



Altech is pleased to announce a new, more extensive printed circuit board terminal block line. This line offers the standard single and double level fixed and pluggable terminal blocks in metric and US pin spacings. However, this product line goes beyond our past standard offering. There is now a wider array of products within each pin spacing as well as new types of blocks such as 35°, reverse horizontal wire entry, and triple level fixed blocks, card edge connectors, panel feed through blocks, barrier strips, and plugs/headers with screw flanges. This product assortment combined with the new pricing structure makes this line extremely competitive.

Altech printed circuit board terminal blocks give you highly dependable connections without the need for wire lugs. Choose either tubular screw clamps or box clamps when economy is paramount or screw-cage clamps for heavy-duty applications. In each case, simply strip and insert the wire and tighten the screw. We recommend the use of ferrules, especially for export applications and whenever fine stranded wires must be terminated.

Our board mounted terminal blocks meet or exceed most international standards and are accepted worldwide. They're available in single, double and triple level configurations with both, millimeter and inch pin spacings. All leave mini footprints to save valuable real estate.

# PRINTED CIRCUIT BOARD TERMINAL BLOCKS

## FIXED

Our printed circuit board terminal blocks designed for fixed mounting offer high density, and maximum flexibility. Modular construction simplifies ordering and reduces inventory. Two- and 3-pole modules can be interlocked to create multipole assemblies. Altech can also supply ready-made assemblies tailored to your specification. Fixed-mount blocks are available with the economical tubular screw, box clamp or the screw-cage clamp and offer several wire entry options to facilitate wiring and increase accessibility.

## PLUGGABLE

The two-piece, plug and header design of our “pluggable” terminal blocks speed and simplify board replacement and reduce costly downtime and misconnections. No special tools are required. Headers are soldered into the board and accept the plugs, which are easily removed for fast, convenient board or device replacement. Choose single- mold designs for maximum strength. Or choose modular designs which are assembled from 2 and 3 pole modules when you need maximum flexibility to meet changing requirements. Both are available in a variety of configurations. Headers are available in vertical, and horizontal, single or double-level, with closed or open ends.

We offer pluggables with either screw-cage clamp termination for heavy duty requirements or with tubular screw termination and open headers for cost sensitive applications. We also offer a card edge connector for a quick, reliable and inexpensive connection.

## CONNECTION

Altech's printed circuit board terminal blocks give you a choice between tubular screw, box clamp and screw-cage clamp designs:

- When your application calls for the highest reliability and frequent wire terminations, the screw-cage clamp should be your choice. As the clamp is tightened, the nickel-plated cage rises, pressing the wire firmly against the busbar, ensuring solid connections every time. Standard color is green.
- In the tubular screw and box clamp design, tightening the screw presses the conductor directly against the bottom of the clamp. These systems are ideal for cost sensitive, lighter duty applications or applications with infrequent wire terminations. Wire protectors are standard. Standard color is black for tubular screw and green for box clamp.

## PIN SPACING

Each clamp style is offered in metric and inch pin spacing. For your convenience, this catalog is organized by pin spacing. Fixed blocks are first, starting with the smallest pin spacing, then pluggable shown in each available spacing.

## MATERIALS

All of our printed circuit board terminal blocks feature precision formed or machined metal parts which are electrolytically plated. Nickel or tin-plated brass cage clamps or tubes, wire protectors, and tin-plated solder pins satisfy the most demanding requirements. Housings are precision-molded from self-extinguishing polyamid 6.8 or glass-filled polyester providing excellent strength and temperature resistance.

## MARKING

Altech offers marking to identify terminal inputs. Order Hot Stamp Imprinting for permanent marking of large quantities or custom marked terminals. Standard marking is consecutive numbers, left to right. This standard marking can be ordered by adding the imprint sequence to the part number as a suffix (i.e. MV-4612/1-12 would be a MV-4612 terminal block imprinted 1 through 12, left to right).

Custom imprints are also available, consult Altech for ordering information.



# Pluggable PCB Blocks

Pin Spacing: 5.00mm\*  
 Orientation: Horizontal Plug  
 Clamp Type: Tubular Screw  
 with Wire Protector  
 Design: Modular



**SHS-5.00**

**ELECTRICAL**

	Current	Voltage	Wire Range
	10A	250V	22-16AWG

**INSTALLATION DATA**

Screw Size	M2.6	PCB Hole Size	–
Torque	0.5Nm (4.5 lbf-in.)	Stripping Lgth.	6.0mm

**MATERIAL**

<b>Body</b>	Glass-Filled Polyester	<b>Screw</b>	Galvanized Steel
<b>Flammability Class</b>	UL94V-0	<b>Terminal</b>	Cu-Be
<b>Temperature Limit</b>	120°C	<b>Wire Protector</b>	Tin-Plated Brass
<b>Color</b>	Black		

No. Poles	Cat. #	Length (B) (mm)	Std. Pk.
2	SHS02-5.00	10.0	100
3	SHS03-5.00	15.0	100
4	SHS04-5.00	20.0	50
5	SHS05-5.00	25.0	50
6	SHS06-5.00	30.0	50
7	SHS07-5.00	35.0	50
8	SHS08-5.00	40.0	50
9	SHS09-5.00	45.0	50
10	SHS10-5.00	50.0	50
11	SHS11-5.00	55.0	50
12	SHS12-5.00	60.0	50
13	SHS13-5.00	65.0	20
14	SHS14-5.00	70.0	20
15	SHS15-5.00	75.0	20
16	SHS16-5.00	80.0	20
17	SHS17-5.00	85.0	20
18	SHS18-5.00	90.0	20
19	SHS19-5.00	95.0	20
20	SHS20-5.00	100.0	20
21	SHS21-5.00	105.0	20
22	SHS22-5.00	110.0	20
23	SHS23-5.00	115.0	20
24	SHS24-5.00	120.0	20



**Dimensions**

A	10.80 mm	I	–
B	10.00 mm	J	Ø2.70 mm
C	13.50 mm	K	Ø3.60 mm
D	4.70 mm	L	–
E	–	M	–
F	–	N	–
G	9.30 mm	O	1.10 mm
H	–	P	5.00 mm

\* Also available in 10.00mm pin spacing

Pin Spacing: 5.00mm\*  
 Orientation: Vertical-Pin Header  
 Clamp Type: –  
 Design: Breakaway



**PVS-5.00**

**ELECTRICAL**

	Current	Voltage	Wire Range
	10A	250V	–

**INSTALLATION DATA**

Screw Size	–	PCB Hole Size	1.5mm
Torque	–	Stripping Lgth.	–

**MATERIAL**

<b>Body</b>	PA6.8	<b>Screw</b>	–
<b>Flammability Class</b>	UL94V-0	<b>Terminal</b>	Tin-Plated Brass
<b>Temperature Limit</b>	125°C	<b>Clamp</b>	–
<b>Color</b>	Black		

No. Poles	Cat. #	Length (B) (mm)*	Std. Pk.
2	PVS02-5.00	10.0	100
3	PVS03-5.00	15.0	100
4	PVS04-5.00	20.0	50
5	PVS05-5.00	25.0	50
6	PVS06-5.00	30.0	50
7	PVS07-5.00	35.0	50
8	PVS08-5.00	40.0	50
9	PVS09-5.00	45.0	50
10	PVS10-5.00	50.0	50
11	PVS11-5.00	55.0	50
12	PVS12-5.00	60.0	50
13	PVS13-5.00	65.0	20
14	PVS14-5.00	70.0	20
15	PVS15-5.00	75.0	20
16	PVS16-5.00	80.0	20
17	PVS17-5.00	85.0	20
18	PVS18-5.00	90.0	20
19	PVS19-5.00	95.0	20
20	PVS20-5.00	100.0	20
21	PVS21-5.00	105.0	20
22	PVS22-5.00	110.0	20
23	PVS23-5.00	115.0	20
24	PVS24-5.00	120.0	20



**Dimensions**

A	12.50 mm	I	2.80 mm
B	* 10.00 mm	J	2.00 mm
C	7.00 mm	K	–
D	–	L	–
E	–	M	Ø1.30 mm
F	–	N	–
G	3.50 mm	O	–
H	–	P	5.00 mm

\* Also available in 10.00mm pin spacing



# Pluggable PCB Blocks



Pin Spacing: 5.00mm  
 Orientation: Horizontal Plug  
 Clamp Type: Screw Cage  
 Design: Single Mold



**SH-5.00**

**ELECTRICAL**

	Current	Voltage	Wire Range
	12A	300V	30-14AWG
	16A	450V	2.5mm <sup>2</sup> Stranded 4.0mm <sup>2</sup> Solid

**INSTALLATION DATA**

<b>Screw Size</b>	M3	<b>PCB Hole Size</b>	–
<b>Torque</b>	0.5Nm (4.5 lbf-in.)	<b>Stripping Lgth.</b>	7.5mm

**MATERIAL**

<b>Body</b>	PA6.8	<b>Screw</b>	Galvanized Steel
<b>Flammability Class</b>	UL94V-0	<b>Terminal</b>	Nickel Brass
<b>Temperature Limit</b>	105°C UL 125°C IEC	<b>Clamp</b>	Nickel Brass
<b>Color</b>	Green		

No. Poles	Cat. #	Length (B) (mm)*	Std. Pk.
2	SH02-5.00	10.0	100
3	SH03-5.00	15.0	100
4	SH04-5.00	20.0	50
5	SH05-5.00	25.0	50
6	SH06-5.00	30.0	50
7	SH07-5.00	35.0	50
8	SH08-5.00	40.0	50
9	SH09-5.00	45.0	50
10	SH10-5.00	50.0	50
11	SH11-5.00	55.0	50
12	SH12-5.00	60.0	50
13	SH13-5.00	65.0	20
14	SH14-5.00	70.0	20
15	SH15-5.00	75.0	20
16	SH16-5.00	80.0	20
17	SH17-5.00	85.0	20
18	SH18-5.00	90.0	20
19	SH19-5.00	95.0	20
20	SH20-5.00	100.0	20
21	SH21-5.00	105.0	20
22	SH22-5.00	110.0	20
23	SH23-5.00	115.0	20
24	SH24-5.00	120.0	20



**Dimensions**

A	15.50 mm	I	2.80 mm
B	*	J	3.10 mm
C	19.15 mm	K	–
D	8.30 mm	L	–
E	–	M	–
F	–	N	–
G	–	O	2.70 mm
H	3.80 mm	P	5.00 mm

Pin Spacing: 5.00mm  
 Orientation: Vertical Header  
 Clamp Type: –  
 Design: Single Mold-Open End



**PV-5.00**

**ELECTRICAL**

	Current	Voltage	Wire Range
	12A	300V	–
	16A	450V	–

**INSTALLATION DATA**

<b>Screw Size</b>	–	<b>PCB Hole Size</b>	1.5mm
<b>Torque</b>	–	<b>Stripping Lgth.</b>	–

**MATERIAL**

<b>Body</b>	PA6.8	<b>Screw</b>	–
<b>Flammability Class</b>	UL94V-0	<b>Terminal</b>	Tin-Plated Brass
<b>Temperature Limit</b>	105°C UL 125°C IEC	<b>Clamp</b>	–
<b>Color</b>	Green		

No. Poles	Cat. #	Length (B) (mm)*	Std. Pk.
2	PV02-5.00	10.0	100
3	PV03-5.00	15.0	100
4	PV04-5.00	20.0	50
5	PV05-5.00	25.0	50
6	PV06-5.00	30.0	50
7	PV07-5.00	35.0	50
8	PV08-5.00	40.0	50
9	PV09-5.00	45.0	50
10	PV10-5.00	50.0	50
11	PV11-5.00	55.0	50
12	PV12-5.00	60.0	50
13	PV13-5.00	65.0	20
14	PV14-5.00	70.0	20
15	PV15-5.00	75.0	20
16	PV16-5.00	80.0	20
17	PV17-5.00	85.0	20
18	PV18-5.00	90.0	20
19	PV19-5.00	95.0	20
20	PV20-5.00	100.0	20
21	PV21-5.00	105.0	20
22	PV22-5.00	110.0	20
23	PV23-5.00	115.0	20
24	PV24-5.00	120.0	20



**Dimensions**

A	12.20 mm	I	–
B	*	J	–
C	8.10 mm	K	–
D	4.00 mm	L	1.00 mm
E	–	M	1.00 mm
F	–	N	15.50 mm
G	4.00 mm	O	–
H	23.15 mm	P	5.00 mm

# Pluggable PCB Blocks

Pin Spacing: 5.00mm  
 Orientation: Vertical Header  
 Clamp Type: –  
 Design: Single Mold - Closed End



**PVP-5.00**

**ELECTRICAL**

	Current	Voltage	Wire Range
	12A	300V	–
	16A	450V	–

**INSTALLATION DATA**

<b>Screw Size</b>	–	<b>PCB Hole Size</b>	1.5mm
<b>Torque</b>	–	<b>Stripping Lgth.</b>	–

**MATERIAL**

<b>Body</b>	PA6.8	<b>Screw</b>	–
<b>Flammability Class</b>	UL94V-0	<b>Terminal</b>	Tin-Plated Brass
<b>Temperature Limit</b>	105°C UL 125°C IEC	<b>Clamp</b>	–
<b>Color</b>	Green		

No. Poles	Cat. #	Length (B) (mm)*	Std. Pk.
2	PVP02-5.00	12.0	100
3	PVP03-5.00	17.0	100
4	PVP04-5.00	22.0	50
5	PVP05-5.00	27.0	50
6	PVP06-5.00	32.0	50
7	PVP07-5.00	37.0	50
8	PVP08-5.00	42.0	50
9	PVP09-5.00	47.0	50
10	PVP10-5.00	52.0	50
11	PVP11-5.00	57.0	50
12	PVP12-5.00	62.0	50
13	PVP13-5.00	67.0	20
14	PVP14-5.00	72.0	20
15	PVP15-5.00	77.0	20
16	PVP16-5.00	82.0	20
17	PVP17-5.00	87.0	20
18	PVP18-5.00	92.0	20
19	PVP19-5.00	97.0	20
20	PVP20-5.00	102.0	20
21	PVP21-5.00	107.0	20
22	PVP22-5.00	112.0	20
23	PVP23-5.00	117.0	20
24	PVP24-5.00	122.0	20



**Dimensions**

A	12.20 mm	I	–
B	*	J	–
C	8.10 mm	K	–
D	4.00 mm	L	1.00 mm
E	–	M	1.00 mm
F	–	N	15.50 mm
G	4.00 mm	O	–
H	23.15 mm	P	5.00 mm

Pin Spacing: 5.00mm  
 Orientation: Horizontal Header  
 Clamp Type: –  
 Design: Single Mold - Open End



**PH-5.00**

**ELECTRICAL**

	Current	Voltage	Wire Range
	12A	300V	–
	16A	450V	–

**INSTALLATION DATA**

<b>Screw Size</b>	–	<b>PCB Hole Size</b>	1.5mm
<b>Torque</b>	–	<b>Stripping Lgth.</b>	–

**MATERIAL**

<b>Body</b>	PA6.8	<b>Screw</b>	–
<b>Flammability Class</b>	UL94V-0	<b>Terminal</b>	Tin-Plated Brass
<b>Temperature Limit</b>	105°C UL 125°C IEC	<b>Clamp</b>	–
<b>Color</b>	Green		

No. Poles	Cat. #	Length (B) (mm)*	Std. Pk.
2	PH02-5.00	10.0	100
3	PH03-5.00	15.0	100
4	PH04-5.00	20.0	50
5	PH05-5.00	25.0	50
6	PH06-5.00	30.0	50
7	PH07-5.00	35.0	50
8	PH08-5.00	40.0	50
9	PH09-5.00	45.0	50
10	PH10-5.00	50.0	50
11	PH11-5.00	55.0	50
12	PH12-5.00	60.0	50
13	PH13-5.00	65.0	20
14	PH14-5.00	70.0	20
15	PH15-5.00	75.0	20
16	PH16-5.00	80.0	20
17	PH17-5.00	85.0	20
18	PH18-5.00	90.0	20
19	PH19-5.00	95.0	20
20	PH20-5.00	100.0	20
21	PH21-5.00	105.0	20
22	PH22-5.00	110.0	20
23	PH23-5.00	115.0	20
24	PH24-5.00	120.0	20



**Dimensions**

A	12.20 mm	I	–
B	*	J	–
C	8.10 mm	K	–
D	1.90 mm	L	1.00 mm
E	–	M	1.00 mm
F	–	N	15.50 mm
G	4.00 mm	O	–
H	23.15 mm	P	5.00 mm

# Pluggable PCB Blocks



Pin Spacing: 5.00mm  
 Orientation: Horizontal Header  
 Clamp Type: –  
 Design: Single Mold - Closed End



**PHP-5.00**

**ELECTRICAL**

	Current	Voltage	Wire Range
	12A	300V	–
	16A	450V	–

**INSTALLATION DATA**

<b>Screw Size</b>	–	<b>PCB Hole Size</b>	1.5mm
<b>Torque</b>	–	<b>Stripping Lgth.</b>	–

**MATERIAL**

<b>Body</b>	PA6.8	<b>Screw</b>	–
<b>Flammability Class</b>	UL94V-0	<b>Terminal</b>	Tin-Plated Brass
<b>Temperature Limit</b>	105°C UL 125°C IEC	<b>Clamp</b>	–
<b>Color</b>	Green		

No. Poles	Cat. #	Length (B) (mm)*	Std. Pk.
2	PHP02-5.00	12.0	100
3	PHP03-5.00	17.0	100
4	PHP04-5.00	22.0	50
5	PHP05-5.00	27.0	50
6	PHP06-5.00	32.0	50
7	PHP07-5.00	37.0	50
8	PHP08-5.00	42.0	50
9	PHP09-5.00	47.0	50
10	PHP10-5.00	52.0	50
11	PHP11-5.00	57.0	50
12	PHP12-5.00	62.0	50
13	PHP13-5.00	67.0	20
14	PHP14-5.00	72.0	20
15	PHP15-5.00	77.0	20
16	PHP16-5.00	82.0	20
17	PHP17-5.00	87.0	20
18	PHP18-5.00	92.0	20
19	PHP19-5.00	97.0	20
20	PHP20-5.00	102.0	20
21	PHP21-5.00	107.0	20
22	PHP22-5.00	112.0	20
23	PHP23-5.00	117.0	20
24	PHP24-5.00	122.0	20

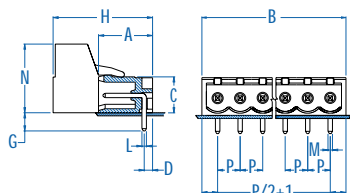

**Dimensions**

A	12.20 mm	I	–
B	*	J	–
C	8.10 mm	K	–
D	1.90 mm	L	1.00 mm
E	–	M	1.00 mm
F	–	N	15.50 mm
G	4.00 mm	O	–
H	23.15 mm	P	5.00 mm

Pin Spacing: 5.08mm  
 Orientation: Horizontal Plug  
 Clamp Type: Screw Cage  
 Design: Single Mold



**SH-5.08**

**ELECTRICAL**

	Current	Voltage	Wire Range
	12A	300V	30-14AWG
	16A	450V	2.5mm <sup>2</sup> Stranded 4.0mm <sup>2</sup> Solid

**INSTALLATION DATA**

<b>Screw Size</b>	M3	<b>PCB Hole Size</b>	–
<b>Torque</b>	0.5Nm (4.5 lbf-in.)	<b>Stripping Lgth.</b>	7.5mm

**MATERIAL**

<b>Body</b>	PA6.8	<b>Screw</b>	Galvanized Steel
<b>Flammability Class</b>	UL94V-0	<b>Terminal</b>	Nickel Brass
<b>Temperature Limit</b>	105°C UL 125°C IEC	<b>Clamp</b>	Nickel Brass
<b>Color</b>	Green		

No. Poles	Cat. #	Length (B) (mm)*	Std. Pk.
2	SH02-5.08	10.2	100
3	SH03-5.08	15.2	100
4	SH04-5.08	20.3	50
5	SH05-5.08	25.4	50
6	SH06-5.08	30.5	50
7	SH07-5.08	35.6	50
8	SH08-5.08	40.6	50
9	SH09-5.08	45.7	50
10	SH10-5.08	50.8	50
11	SH11-5.08	55.9	50
12	SH12-5.08	61.0	50
13	SH13-5.08	66.0	20
14	SH14-5.08	71.1	20
15	SH15-5.08	76.2	20
16	SH16-5.08	81.3	20
17	SH17-5.08	86.4	20
18	SH18-5.08	91.4	20
19	SH19-5.08	96.5	20
20	SH20-5.08	101.6	20
21	SH21-5.08	106.7	20
22	SH22-5.08	111.8	20
23	SH23-5.08	116.6	20
24	SH24-5.08	121.9	20



**Dimensions**

A	15.50 mm	I	2.80 mm
B	*	J	3.10 mm
C	18.80 mm	K	Ø1.80 mm
D	8.30 mm	L	–
E	1.00 mm	M	–
F	5.70 mm	N	–
G	–	O	2.70 mm
H	Ø3.80 mm	P	5.08 mm

# Pluggable PCB Blocks

Pin Spacing: 5.08mm  
 Orientation: Vertical Plug-Wire Entry on Locking Tab Side  
 Clamp Type: Screw Cage  
 Design: Single Mold



**SVF-5.08**

**ELECTRICAL**

	Current	Voltage	Wire Range
	12A	300V	30-14AWG
	16A	450V	2.5mm <sup>2</sup> Stranded 4.0mm <sup>2</sup> Solid

**INSTALLATION DATA**

<b>Screw Size</b>	M3	<b>PCB Hole Size</b>	–
<b>Torque</b>	0.5Nm (4.5 lbf-in.)	<b>Stripping Lgth.</b>	9.1mm

**MATERIAL**

<b>Body</b>	PA6.8	<b>Screw</b>	Galvanized Steel
<b>Flammability Class</b>	UL94V-0	<b>Terminal</b>	Nickeled Brass
<b>Temperature Limit</b>	105°C UL 125°C IEC	<b>Clamp</b>	Nickeled Brass
<b>Color</b>	Green		

No. Poles	Cat. #	Length (B) (mm)*	Std. Pk.
2	SVF02-5.08	10.2	100
3	SVF03-5.08	15.2	100
4	SVF04-5.08	20.3	50
5	SVF05-5.08	25.4	50
6	SVF06-5.08	30.5	50
7	SVF07-5.08	35.6	50
8	SVF08-5.08	40.6	50
9	SVF09-5.08	45.7	50
10	SVF10-5.08	50.8	50
11	SVF11-5.08	55.9	50
12	SVF12-5.08	61.0	50
13	SVF13-5.08	66.0	20
14	SVF14-5.08	71.1	20
15	SVF15-5.08	76.2	20
16	SVF16-5.08	81.3	20
17	SVF17-5.08	86.4	20
18	SVF18-5.08	91.4	20
19	SVF19-5.08	96.5	20
20	SVF20-5.08	101.6	20
21	SVF21-5.08	106.7	20
22	SVF22-5.08	111.8	20
23	SVF23-5.08	116.6	20
24	SVF24-5.08	121.9	20



**Dimensions**

A	27.60 mm	I	2.80 mm
B	*	J	3.10 mm
C	13.50 mm	K	Ø3.80 mm
D	8.30 mm	L	–
E	3.85 mm	M	–
F	5.80 mm	N	–
G	10.80 mm	O	–
H	13.30 mm	P	5.08 mm

Pin Spacing: 5.08mm  
 Orientation: Vertical Plug-Wire Entry on Scalloped Side  
 Clamp Type: Screw Cage  
 Design: Single Mold

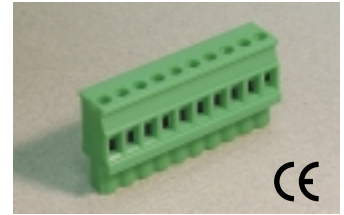

**SVP-5.08**

**ELECTRICAL**

	Current	Voltage	Wire Range
	12A	300V	30-14AWG
	16A	450V	2.5mm <sup>2</sup> Stranded 4.0mm <sup>2</sup> Solid

**INSTALLATION DATA**

<b>Screw Size</b>	M3	<b>PCB Hole Size</b>	–
<b>Torque</b>	0.5Nm (4.5 lbf-in.)	<b>Stripping Lgth.</b>	9.1mm

**MATERIAL**

<b>Body</b>	PA6.8	<b>Screw</b>	Galvanized Steel
<b>Flammability Class</b>	UL94V-0	<b>Terminal</b>	Nickeled Brass
<b>Temperature Limit</b>	105°C UL 125°C IEC	<b>Clamp</b>	Nickeled Brass
<b>Color</b>	Green		

No. Poles	Cat. #	Length (B) (mm)*	Std. Pk.
2	SVP02-5.08	10.2	100
3	SVP03-5.08	15.2	100
4	SVP04-5.08	20.3	50
5	SVP05-5.08	25.4	50
6	SVP06-5.08	30.5	50
7	SVP07-5.08	35.6	50
8	SVP08-5.08	40.6	50
9	SVP09-5.08	45.7	50
10	SVP10-5.08	50.8	50
11	SVP11-5.08	55.9	50
12	SVP12-5.08	61.0	50
13	SVP13-5.08	66.0	20
14	SVP14-5.08	71.1	20
15	SVP15-5.08	76.2	20
16	SVP16-5.08	81.3	20
17	SVP17-5.08	86.4	20
18	SVP18-5.08	91.4	20
19	SVP19-5.08	96.5	20
20	SVP20-5.08	101.6	20
21	SVP21-5.08	106.7	20
22	SVP22-5.08	111.8	20
23	SVP23-5.08	116.6	20
24	SVP24-5.08	121.9	20

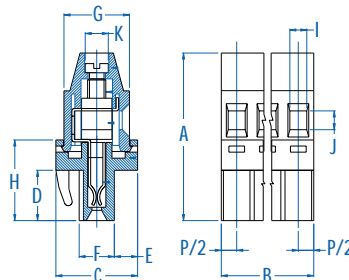

**Dimensions**

A	27.60 mm	I	2.80 mm
B	*	J	3.10 mm
C	13.50 mm	K	Ø3.80 mm
D	8.30 mm	L	–
E	3.85 mm	M	–
F	5.80 mm	N	–
G	10.80 mm	O	–
H	13.30 mm	P	5.08 mm

# Pluggable PCB Blocks



Pin Spacing: 5.08mm  
 Orientation: Vertical Header  
 Clamp Type: –  
 Design: Single Mold-Open End



**PV-5.08**

**ELECTRICAL**

	Current	Voltage	Wire Range
	12A	300V	–
	16A	450V	–

**INSTALLATION DATA**

Screw Size	–	PCB Hole Size	1.5mm
Torque	–	Stripping Lgth.	–

**MATERIAL**

Body	PA6.8	Screw	–
Flammability Class	UL94V-0	Terminal	Tin-Plated Brass
Temperature Limit	105°C UL 125°C IEC	Clamp	–
Color	Green		

No. Poles	Cat. #	Length (B) (mm)*	Std. Pk.
2	PV02-5.08	10.2	100
3	PV03-5.08	15.2	100
4	PV04-5.08	20.3	50
5	PV05-5.08	25.4	50
6	PV06-5.08	30.5	50
7	PV07-5.08	35.6	50
8	PV08-5.08	40.6	50
9	PV09-5.08	45.7	50
10	PV10-5.08	50.8	50
11	PV11-5.08	55.9	50
12	PV12-5.08	61.0	50
13	PV13-5.08	66.0	20
14	PV14-5.08	71.1	20
15	PV15-5.08	76.2	20
16	PV16-5.08	81.3	20
17	PV17-5.08	86.4	20
18	PV18-5.08	91.4	20
19	PV19-5.08	96.5	20
20	PV20-5.08	101.6	20
21	PV21-5.08	106.7	20
22	PV22-5.08	111.8	20
23	PV23-5.08	116.6	20
24	PV24-5.08	121.9	20

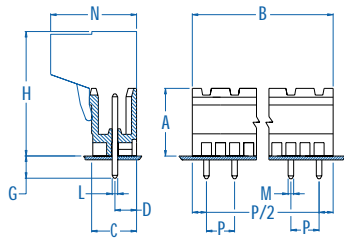

**Dimensions**

A	12.20 mm	I	–
B	*	J	–
C	8.10 mm	K	–
D	4.00 mm	L	1.00 mm
E	–	M	1.00 mm
F	–	N	15.50 mm
G	4.00 mm	O	–
H	22.80 mm	P	5.08 mm

Pin Spacing: 5.08mm  
 Orientation: Vertical Header  
 Clamp Type: –  
 Design: Single Mold - Closed End



**PVP-5.08**

**ELECTRICAL**

	Current	Voltage	Wire Range
	12A	300V	–
	16A	450V	–

**INSTALLATION DATA**

Screw Size	–	PCB Hole Size	1.5mm
Torque	–	Stripping Lgth.	–

**MATERIAL**

Body	PA6.8	Screw	–
Flammability Class	UL94V-0	Terminal	Tin-Plated Brass
Temperature Limit	105°C UL 125°C IEC	Clamp	–
Color	Green		

No. Poles	Cat. #	Length (B) (mm)*	Std. Pk.
2	PVP02-5.08	12.2	100
3	PVP03-5.08	17.2	100
4	PVP04-5.08	22.3	50
5	PVP05-5.08	27.4	50
6	PVP06-5.08	32.5	50
7	PVP07-5.08	37.6	50
8	PVP08-5.08	42.6	50
9	PVP09-5.08	47.7	50
10	PVP10-5.08	52.8	50
11	PVP11-5.08	57.9	50
12	PVP12-5.08	63.0	50
13	PVP13-5.08	68.0	20
14	PVP14-5.08	73.1	20
15	PVP15-5.08	78.2	20
16	PVP16-5.08	83.3	20
17	PVP17-5.08	88.4	20
18	PVP18-5.08	93.4	20
19	PVP19-5.08	98.5	20
20	PVP20-5.08	103.6	20
21	PVP21-5.08	108.7	20
22	PVP22-5.08	113.8	20
23	PVP23-5.08	118.6	20
24	PVP24-5.08	123.9	20



**Dimensions**

A	12.20 mm	I	–
B	*	J	–
C	8.10 mm	K	–
D	4.00 mm	L	1.00 mm
E	–	M	1.00 mm
F	–	N	15.50 mm
G	4.00 mm	O	–
H	22.80 mm	P	5.08 mm



# Pluggable PCB Blocks

Pin Spacing: 5.08mm  
 Orientation: Horizontal Header  
 Clamp Type: -  
 Design: Single Mold - Open End



**PH-5.08**

**ELECTRICAL**

	Current	Voltage	Wire Range
	12A	300V	-
	16A	450V	-

**INSTALLATION DATA**

Screw Size	-	PCB Hole Size	1.5mm
Torque	-	Stripping Lgth.	-

**MATERIAL**

Body	PA6.8	Screw	-
Flammability Class	UL94V-0	Terminal	Tin-Plated Brass
Temperature Limit	105°C UL 125°C IEC	Clamp	-
Color	Green		

No. Poles	Cat. #	Length (B) (mm)*	Std. Pk.
2	PH02-5.08	10.2	100
3	PH03-5.08	15.2	100
4	PH04-5.08	20.3	50
5	PH05-5.08	25.4	50
6	PH06-5.08	30.5	50
7	PH07-5.08	35.6	50
8	PH08-5.08	40.6	50
9	PH09-5.08	45.7	50
10	PH10-5.08	50.8	50
11	PH11-5.08	55.9	50
12	PH12-5.08	61.0	50
13	PH13-5.08	66.0	20
14	PH14-5.08	71.1	20
15	PH15-5.08	76.2	20
16	PH16-5.08	81.3	20
17	PH17-5.08	86.4	20
18	PH18-5.08	91.4	20
19	PH19-5.08	96.5	20
20	PH20-5.08	101.6	20
21	PH21-5.08	106.7	20
22	PH22-5.08	111.8	20
23	PH23-5.08	116.6	20
24	PH24-5.08	121.9	20

Pin Spacing: 5.08mm  
 Orientation: Horizontal Header  
 Clamp Type: -  
 Design: Single Mold - Closed End

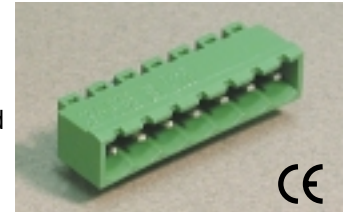

**PHP-5.08**

**ELECTRICAL**

	Current	Voltage	Wire Range
	12A	300V	-
	16A	450V	-

**INSTALLATION DATA**

Screw Size	-	PCB Hole Size	1.5mm
Torque	-	Stripping Lgth.	-

**MATERIAL**

Body	PA6.8	Screw	-
Flammability Class	UL94V-0	Terminal	Tin-Plated Brass
Temperature Limit	105°C UL 125°C IEC	Clamp	-
Color	Green		

No. Poles	Cat. #	Length (B) (mm)*	Std. Pk.
2	PHP02-5.08	12.2	100
3	PHP03-5.08	17.2	100
4	PHP04-5.08	22.3	50
5	PHP05-5.08	27.4	50
6	PHP06-5.08	32.5	50
7	PHP07-5.08	37.6	50
8	PHP08-5.08	42.6	50
9	PHP09-5.08	47.7	50
10	PHP10-5.08	52.8	50
11	PHP11-5.08	57.9	50
12	PHP12-5.08	63.0	50
13	PHP13-5.08	68.0	20
14	PHP14-5.08	73.1	20
15	PHP15-5.08	78.2	20
16	PHP16-5.08	83.3	20
17	PHP17-5.08	88.4	20
18	PHP18-5.08	93.4	20
19	PHP19-5.08	98.5	20
20	PHP20-5.08	103.6	20
21	PHP21-5.08	108.7	20
22	PHP22-5.08	113.8	20
23	PHP23-5.08	118.6	20
24	PHP24-5.08	123.9	20

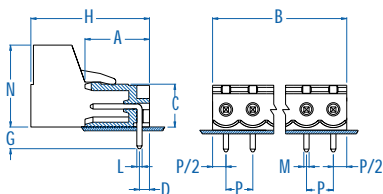

Dimensions

A	12.20 mm	I	-
B	*	J	-
C	8.10 mm	K	-
D	1.90 mm	L	1.00 mm
E	-	M	1.00 mm
F	-	N	15.50 mm
G	4.00 mm	O	-
H	22.80 mm	P	5.08 mm

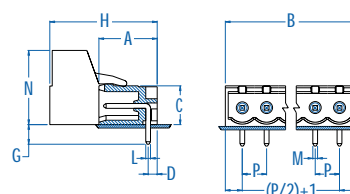

Dimensions

A	12.20 mm	I	-
B	*	J	-
C	8.10 mm	K	-
D	1.90 mm	L	1.00 mm
E	-	M	1.00 mm
F	-	N	15.50 mm
G	4.00 mm	O	-
H	22.80 mm	P	5.08 mm

# Pluggable PCB Blocks

Pin Spacing: 5.08mm  
 Orientation: Vertical -  
 Double Level Header  
 Clamp Type: -  
 Design: Modular - Open End



**PDSV-5.08**

**ELECTRICAL**

	Current	Voltage	Wire Range
	12A	300V	-
	16A	450V	-

**INSTALLATION DATA**

Screw Size	-	PCB Hole Size	1.5mm
Torque	-	Stripping Lgth.	-

**MATERIAL**

Body	PA6.8	Screw	-
Flammability Class	UL94V-0	Terminal	Tin-Plated Brass
Temperature Limit	105°C UL 125°C IEC	Clamp	-
Color	Green		

No. Poles	Cat. #	Length (B) (mm)*	Std. Pk.
4	PDSV02-5.08	10.2	100
6	PDSV03-5.08	15.2	100
8	PDSV04-5.08	20.3	50
10	PDSV05-5.08	25.4	50
12	PDSV06-5.08	30.5	50
14	PDSV07-5.08	35.6	50
16	PDSV08-5.08	40.6	50
18	PDSV09-5.08	45.7	50
20	PDSV10-5.08	50.8	50
22	PDSV11-5.08	55.9	20
24	PDSV12-5.08	61.0	20
26	PDSV13-5.08	66.0	20
28	PDSV14-5.08	71.1	20
30	PDSV15-5.08	76.2	20
32	PDSV16-5.08	81.3	20
34	PDSV17-5.08	86.4	20
36	PDSV18-5.08	91.4	20
38	PDSV19-5.08	96.5	20
40	PDSV20-5.08	101.6	10
42	PDSV21-5.08	106.7	10
44	PDSV22-5.08	111.8	10
46	PDSV23-5.08	116.6	10
48	PDSV24-5.08	121.9	10



**Dimensions**

A	12.20 mm	I	-
B	*	J	-
C	23.74 mm	K	-
D	3.90 mm	L	1.00 mm
E	15.24 mm	M	1.00 mm
F	4.00 mm	N	15.50 mm
G	22.00 mm	O	-
H	22.80 mm	P	5.08 mm

Pin Spacing: 5.08mm  
 Orientation: Horizontal - Double  
 Level Header  
 Clamp Type: -  
 Design: Modular - Open End



**PDSH-5.08**

**ELECTRICAL**

	Current	Voltage	Wire Range
	12A	300V	-
	16A	450V	-

**INSTALLATION DATA**

Screw Size	-	PCB Hole Size	1.5mm
Torque	-	Stripping Lgth.	-

**MATERIAL**

Body	PA6.8	Screw	-
Flammability Class	UL94V-0	Terminal	Tin-Plated Brass
Temperature Limit	105°C UL 125°C IEC	Clamp	-
Color	Green		

No. Poles	Cat. #	Length (B) (mm)*	Std. Pk.
4	PDSH02-5.08	10.2	100
6	PDSH03-5.08	15.2	100
8	PDSH04-5.08	20.3	50
10	PDSH05-5.08	25.4	50
12	PDSH06-5.08	30.5	50
14	PDSH07-5.08	35.6	50
16	PDSH08-5.08	40.6	50
18	PDSH09-5.08	45.7	50
20	PDSH10-5.08	50.8	50
22	PDSH11-5.08	55.9	20
24	PDSH12-5.08	61.0	20
26	PDSH13-5.08	66.0	20
28	PDSH14-5.08	71.1	20
30	PDSH15-5.08	76.2	20
32	PDSH16-5.08	81.3	20
34	PDSH17-5.08	86.4	20
36	PDSH18-5.08	91.4	20
38	PDSH19-5.08	96.5	20
40	PDSH20-5.08	101.6	10
42	PDSH21-5.08	106.7	10
44	PDSH22-5.08	111.8	10
46	PDSH23-5.08	116.6	10
48	PDSH24-5.08	121.9	10



**Dimensions**

A	12.20 mm	I	-
B	*	J	-
C	23.74 mm	K	-
D	1.90 mm	L	1.00 mm
E	10.00 mm	M	1.00 mm
F	4.00 mm	N	15.50 mm
G	22.00 mm	O	-
H	22.80 mm	P	5.08 mm

# Pluggable PCB Blocks

Pin Spacing: 5.08mm  
 Orientation: Horizontal Plug with  
 Screw Flange  
 Clamp Type: Screw Cage  
 Design: Single Mold



**SH-5.08-K**

**ELECTRICAL**

	Current	Voltage	Wire Range
	12A	300V	30-14AWG
	16A	500V	2.5mm <sup>2</sup> Stranded 4.0mm <sup>2</sup> Solid

**INSTALLATION DATA**

<b>Screw Size</b>	M3	<b>PCB Hole Size</b>	–
<b>Torque</b>	0.5Nm (4.5 lbf-in)	<b>Stripping Lgth.</b>	7.5mm

**MATERIAL**

<b>Body</b>	PA6.8	<b>Screw</b>	Galvanized Steel
<b>Flammability Class</b>	UL94V-0	<b>Terminal</b>	Nickeled Brass
<b>Temperature Limit</b>	105°C UL 125°C IEC	<b>Clamp</b>	Nickeled Brass
<b>Color</b>	Green		

No. Poles	Cat. #	Length (B) (mm)*	Std. Pk.
2	SH02-5.08 - K	20.3	100
3	SH03-5.08 - K	25.4	100
4	SH04-5.08 - K	30.5	50
5	SH05-5.08 - K	35.6	50
6	SH06-5.08 - K	40.6	50
7	SH07-5.08 - K	45.7	50
8	SH08-5.08 - K	50.8	50
9	SH09-5.08 - K	55.9	50
10	SH10-5.08 - K	61.0	50
11	SH11-5.08 - K	66.0	50
12	SH12-5.08 - K	71.1	50
13	SH13-5.08 - K	76.2	20
14	SH14-5.08 - K	81.3	20
15	SH15-5.08 - K	86.4	20
16	SH16-5.08 - K	91.4	20
17	SH17-5.08 - K	96.5	20
18	SH18-5.08 - K	101.6	20
19	SH19-5.08 - K	106.7	20
20	SH20-5.08 - K	111.8	20
21	SH21-5.08 - K	116.6	20
22	SH22-5.08 - K	121.9	20

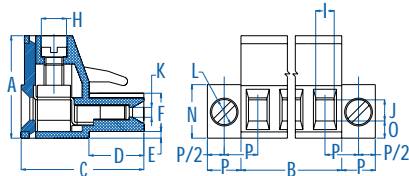

**Dimensions**

A	15.50 mm	I	2.80 mm
B	*	J	3.10 mm
C	18.80 mm	K	Ø1.80 mm
D	8.30 mm	L	Ø3.80 mm
E	1.00 mm	M	–
F	5.70 mm	N	8.10 mm
G	–	O	2.70 mm
H	Ø3.80 mm	P	5.08 mm

Pin Spacing: 5.08mm  
 Orientation: Vertical Header with  
 Screw Flange  
 Clamp Type: –  
 Design: Single Mold

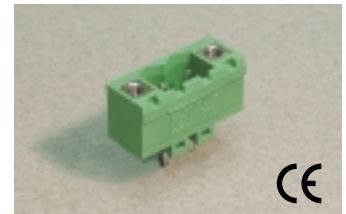

**PV-5.08-K**

**ELECTRICAL**

	Current	Voltage	Wire Range
	12A	300V	–
	16A	450V	–

**INSTALLATION DATA**

<b>Screw Size</b>	–	<b>PCB Hole Size</b>	1.5mm
<b>Torque</b>	–	<b>Stripping Lgth.</b>	–

**MATERIAL**

<b>Body</b>	PA6.8	<b>Screw</b>	–
<b>Flammability Class</b>	UL94V-0	<b>Terminal</b>	Tin-Plated Brass
<b>Temperature Limit</b>	105°C UL 125°C IEC	<b>Clamp</b>	Nickeled Brass
<b>Color</b>	Green		

No. Poles	Cat. #	Length (B) (mm)*	Std. Pk.
2	PV02-5.08 - K	20.3	100
3	PV03-5.08 - K	25.4	100
4	PV04-5.08 - K	30.5	50
5	PV05-5.08 - K	35.6	50
6	PV06-5.08 - K	40.6	50
7	PV07-5.08 - K	45.7	50
8	PV08-5.08 - K	50.8	50
9	PV09-5.08 - K	55.9	50
10	PV10-5.08 - K	61.0	50
11	PV11-5.08 - K	66.0	50
12	PV12-5.08 - K	71.1	50
13	PV13-5.08 - K	76.2	20
14	PV14-5.08 - K	81.3	20
15	PV15-5.08 - K	86.4	20
16	PV16-5.08 - K	91.4	20
17	PV17-5.08 - K	96.5	20
18	PV18-5.08 - K	101.6	20
19	PV19-5.08 - K	106.7	20
20	PV20-5.08 - K	111.8	20
21	PV21-5.08 - K	116.6	20
22	PV22-5.08 - K	121.9	20

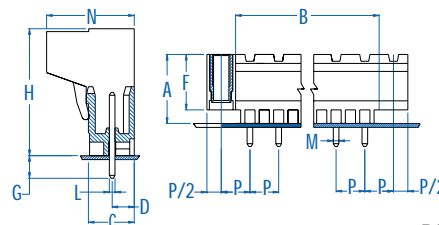

**Dimensions**

A	12.20 mm	I	–
B	*	J	–
C	8.10 mm	K	–
D	4.00 mm	L	1.00 mm
E	–	M	1.00 mm
F	9.80 mm	N	15.50 mm
G	4.00 mm	O	–
H	22.80 mm	P	5.08 mm

# Pluggable PCB Blocks



Pin Spacing: 5.08mm  
 Orientation: Horizontal Header with Screw Flange  
 Clamp Type: -  
 Design: Single Mold



**PH-5.08-K**

**ELECTRICAL**

	Current	Voltage	Wire Range
	12A	300V	-
	16A	450V	-

**INSTALLATION DATA**

<b>Screw Size</b>	-	<b>PCB Hole Size</b>	1.5mm
<b>Torque</b>	-	<b>Stripping Lgth.</b>	-

**MATERIAL**

<b>Body</b>	PA6.8	<b>Screw</b>	-
<b>Flammability Class</b>	UL94V-0	<b>Terminal</b>	Tin-Plated Brass
<b>Temperature Limit</b>	105°C UL 125°C IEC	<b>Clamp</b>	Nickeled Brass
<b>Color</b>	Green		

No. Poles	Cat. #	Length (B) (mm)*	Std. Pk.
2	PH02-5.08 - K	20.3	100
3	PH03-5.08 - K	25.4	100
4	PH04-5.08 - K	30.5	50
5	PH05-5.08 - K	35.6	50
6	PH06-5.08 - K	40.6	50
7	PH07-5.08 - K	45.7	50
8	PH08-5.08 - K	50.8	50
9	PH09-5.08 - K	55.9	50
10	PH10-5.08 - K	61.0	50
11	PH11-5.08 - K	66.0	50
12	PH12-5.08 - K	71.1	50
13	PH13-5.08 - K	76.2	20
14	PH14-5.08 - K	81.3	20
15	PH15-5.08 - K	86.4	20
16	PH16-5.08 - K	91.4	20
17	PH17-5.08 - K	96.5	20
18	PH18-5.08 - K	101.6	20
19	PH19-5.08 - K	106.7	20
20	PH20-5.08 - K	111.8	20
21	PH21-5.08 - K	116.6	20
22	PH22-5.08 - K	121.9	20



**Dimensions**

A	12.20 mm	I	4.10 mm
B	*	J	4.10 mm
C	8.10 mm	K	-
D	1.90 mm	L	1.00 mm
E	-	M	1.00 mm
F	-	N	15.50 mm
G	4.00 mm	O	-
H	22.80 mm	P	5.08 mm

Pin Spacing: 6.35mm  
 Orientation: Vertical Plug  
 Clamp Type: Screw Cage  
 Design: Modular - Card Edge



**MVI**

**ELECTRICAL**

	Current	Voltage	Wire Range
	20A <sup>①</sup>	300V	30-12AWG
	10A	500V	4.0mm <sup>2</sup> Stranded 6.0mm <sup>2</sup> Solid

**INSTALLATION DATA**

<b>Screw Size</b>	M3	<b>PCB Thickness</b>	1.5-1.7mm
<b>Torque</b>	0.5Nm (4.5 lbf-in.)	<b>Stripping Lgth.</b>	9.8mm

**MATERIAL**

<b>Body</b>	PA6.8	<b>Screw</b>	Galvanized Steel
<b>Flammability Class</b>	UL94V-0	<b>Terminal</b>	Nickeled Brass
<b>Temperature Limit</b>	105°C UL 125°C IEC	<b>Clamp</b>	Nickeled Brass
<b>Color</b>	Black		

No. Poles	Cat. #	Length (B) (mm)	Std. Pk.
2	MVI-2	12.7	100
3	MVI-3	19.0	100
4	MVI-4	25.4	50
5	MVI-5	31.8	50
6	MVI-6	38.1	50
7	MVI-7	44.5	50
8	MVI-8	50.8	50
9	MVI-9	57.2	50
10	MVI-10	63.5	50
11	MVI-11	69.9	50
12	MVI-12	76.2	50
13	MVI-13	82.6	20
14	MVI-14	88.9	20
15	MVI-15	95.3	20
16	MVI-16	101.6	20

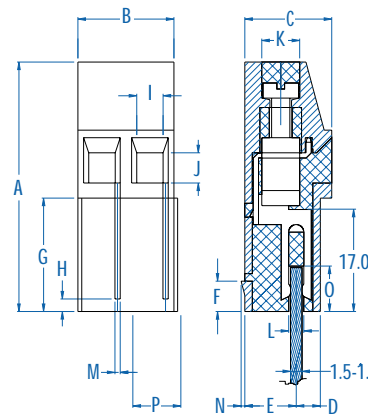

**Dimensions**

A	33.00 mm	I	3.10 mm
B	12.70 mm	J	3.90 mm
C	11.40 mm	K	Ø4.70 mm
D	3.20 mm	L	1.30 mm
E	6.70 mm	M	0.70 mm
F	4.00 mm	N	1.00 mm
G	15.00 mm	O	6.00 mm
H	1.50 mm	P	6.35 mm

<sup>①</sup> 25A Factory Wiring - UL



# Pluggable PCB Blocks

Pin Spacing: 7.50mm  
 Orientation: Horizontal Plug  
 Clamp Type: Screw Cage  
 Design: Single Mold



**SH-7.50**

**ELECTRICAL**

	Current	Voltage	Wire Range
	12A	300V	30-14AWG
	16A	750V	2.5mm <sup>2</sup> Stranded 4.0mm <sup>2</sup> Solid

**INSTALLATION DATA**

<b>Screw Size</b>	M3	<b>PCB Hole Size</b>	–
<b>Torque</b>	0.5Nm (4.5 lbf-in.)	<b>Stripping Lgth.</b>	7.6mm

**MATERIAL**

<b>Body</b>	PA6.8	<b>Screw</b>	Galvanized Steel
<b>Flammability Class</b>	UL94V-0	<b>Terminal</b>	Nickeled Brass
<b>Temperature Limit</b>	105°C UL 125°C IEC	<b>Clamp</b>	Nickeled Brass
<b>Color</b>	Green		

No. Poles	Cat. #	Length (B) (mm)*	Std. Pk.
2	SH02-7.50	15.0	100
3	SH03-7.50	22.5	100
4	SH04-7.50	30.0	50
5	SH05-7.50	37.5	50
6	SH06-7.50	45.0	50
7	SH07-7.50	52.5	50
8	SH08-7.50	60.0	50
9	SH09-7.50	67.5	50
10	SH10-7.50	75.0	50
11	SH11-7.50	82.5	20
12	SH12-7.50	90.0	20
13	SH13-7.50	97.5	20
14	SH14-7.50	105.0	20
15	SH15-7.50	112.5	20
16	SH16-7.50	120.0	20

Pin Spacing: 7.50mm  
 Orientation: Vertical Header  
 Clamp Type: –  
 Design: Single Mold - Open End



**PV-7.50**

**ELECTRICAL**

	Current	Voltage	Wire Range
	12A	300V	–
	16A	750V	–

**INSTALLATION DATA**

<b>Screw Size</b>	–	<b>PCB Hole Size</b>	1.5mm
<b>Torque</b>	–	<b>Stripping Lgth.</b>	–

**MATERIAL**

<b>Body</b>	PA6.8	<b>Screw</b>	–
<b>Flammability Class</b>	UL94V-0	<b>Terminal</b>	Tin-Plated Brass
<b>Temperature Limit</b>	105°C UL 125°C IEC	<b>Clamp</b>	–
<b>Color</b>	Green		

No. Poles	Cat. #	Length (B) (mm)*	Std. Pk.
2	PV02-7.50	15.0	100
3	PV03-7.50	22.5	100
4	PV04-7.50	30.0	50
5	PV05-7.50	37.5	50
6	PV06-7.50	45.0	50
7	PV07-7.50	52.5	50
8	PV08-7.50	60.0	50
9	PV09-7.50	67.5	50
10	PV10-7.50	75.0	50
11	PV11-7.50	82.5	20
12	PV12-7.50	90.0	20
13	PV13-7.50	97.5	20
14	PV14-7.50	105.0	20
15	PV15-7.50	112.5	20
16	PV16-7.50	120.0	20



**Dimensions**

A	15.50 mm	I	2.80 mm
B	*	J	3.10 mm
C	19.85 mm	K	Ø1.80 mm
D	8.30 mm	L	–
E	1.00 mm	M	–
F	5.70 mm	N	–
G	–	O	2.70 mm
H	Ø4.00 mm	P	7.50 mm



**Dimensions**

A	12.20 mm	I	–
B	*	J	–
C	8.10 mm	K	–
D	4.00 mm	L	1.00 mm
E	–	M	1.00 mm
F	–	N	15.50 mm
G	4.00 mm	O	–
H	23.75 mm	P	7.50 mm

Pin Spacing: 7.50mm  
 Orientation: Vertical Header  
 Clamp Type: –  
 Design: Single Mold - Closed End



**PVP-7.50**

**ELECTRICAL**

	Current	Voltage	Wire Range
	12A	300V	–
	16A	750V	–

**INSTALLATION DATA**

Screw Size	–	PCB Hole Size	1.5mm
Torque	–	Stripping Lgth.	–

**MATERIAL**

Body	PA6.8	Screw	–
Flammability Class	UL94V-0	Terminal	Tin-Plated Brass
Temperature Limit	105°C UL 125°C IEC	Clamp	–
Color	Green		

No. Poles	Cat. #	Length (B) (mm)*	Std. Pk.
2	PVP02-7.50	15.0	100
3	PVP03-7.50	22.5	100
4	PVP04-7.50	30.0	50
5	PVP05-7.50	37.5	50
6	PVP06-7.50	45.0	50
7	PVP07-7.50	52.5	50
8	PVP08-7.50	60.0	50
9	PVP09-7.50	67.5	50
10	PVP10-7.50	75.0	50
11	PVP11-7.50	82.5	20
12	PVP12-7.50	90.0	20
13	PVP13-7.50	97.5	20
14	PVP14-7.50	105.0	20
15	PVP15-7.50	112.5	20
16	PVP16-7.50	120.0	20



**Dimensions**

A	12.20 mm	I	–
B	*	J	–
C	8.10 mm	K	–
D	4.00 mm	L	1.00 mm
E	–	M	1.00 mm
F	–	N	15.50 mm
G	4.00 mm	O	–
H	23.75 mm	P	7.50 mm

Pin Spacing: 7.50mm  
 Orientation: Horizontal Header  
 Clamp Type: –  
 Design: Single Mold - Open End



**PH-7.50**

**ELECTRICAL**

	Current	Voltage	Wire Range
	12A	300V	–
	16A	750V	–

**INSTALLATION DATA**

Screw Size	–	PCB Hole Size	1.5mm
Torque	–	Stripping Lgth.	–

**MATERIAL**

Body	PA6.8	Screw	–
Flammability Class	UL94V-0	Terminal	Tin-Plated Brass
Temperature Limit	105°C UL 125°C IEC	Clamp	–
Color	Green		

No. Poles	Cat. #	Length (B) (mm)*	Std. Pk.
2	PH02-7.50	15.0	100
3	PH03-7.50	22.5	100
4	PH04-7.50	30.0	50
5	PH05-7.50	37.5	50
6	PH06-7.50	45.0	50
7	PH07-7.50	52.5	50
8	PH08-7.50	60.0	50
9	PH09-7.50	67.5	50
10	PH10-7.50	75.0	50
11	PH11-7.50	82.5	20
12	PH12-7.50	90.0	20
13	PH13-7.50	97.5	20
14	PH14-7.50	105.0	20
15	PH15-7.50	112.5	20
16	PH16-7.50	120.0	20



**Dimensions**

A	12.20 mm	I	–
B	*	J	–
C	8.10 mm	K	–
D	1.90 mm	L	1.00 mm
E	–	M	1.00 mm
F	–	N	15.50 mm
G	4.00 mm	O	–
H	23.75 mm	P	7.50 mm

# Pluggable PCB Blocks

Pin Spacing: 7.50mm  
 Orientation: Horizontal Header  
 Clamp Type: –  
 Design: Single Mold - Closed End

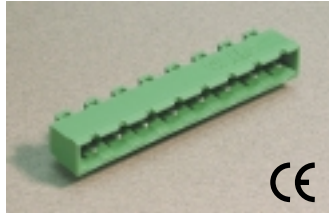

**PHP-7.50**

**ELECTRICAL**

	Current	Voltage	Wire Range
	12A	300V	–
	16A	750V	–

**INSTALLATION DATA**

<b>Screw Size</b>	–	<b>PCB Hole Size</b>	1.5mm
<b>Torque</b>	–	<b>Stripping Lgth.</b>	–

**MATERIAL**

<b>Body</b>	PA6.8	<b>Screw</b>	–
<b>Flammability Class</b>	UL94V-0	<b>Terminal</b>	Tin-Plated Brass
<b>Temperature Limit</b>	105°C UL 125°C IEC	<b>Clamp</b>	–
<b>Color</b>	Green		

No. Poles	Cat. #	Length (B) (mm)*	Std. Pk.
2	PHP02-7.50	15.0	100
3	PHP03-7.50	22.5	100
4	PHP04-7.50	30.0	50
5	PHP05-7.50	37.5	50
6	PHP06-7.50	45.0	50
7	PHP07-7.50	52.5	50
8	PHP08-7.50	60.0	50
9	PHP09-7.50	67.5	50
10	PHP10-7.50	75.0	50
11	PHP11-7.50	82.5	20
12	PHP12-7.50	90.0	20
13	PHP13-7.50	97.5	20
14	PHP14-7.50	105.0	20
15	PHP15-7.50	112.5	20
16	PHP16-7.50	120.0	20



**Dimensions**

A	12.20 mm	I	–
B	*	J	–
C	8.10 mm	K	–
D	1.90 mm	L	1.00 mm
E	–	M	1.00 mm
F	–	N	15.50 mm
G	4.00 mm	O	–
H	23.75 mm	P	7.50 mm

Pin Spacing: 10.00mm  
 Orientation: Horizontal Plug  
 Clamp Type: Screw Cage  
 Design: Single Mold



**SH-10.00**

**ELECTRICAL**

	Current	Voltage	Wire Range
	12A	300V	30-14AWG
	16A	750V	2.5mm² Stranded 4.0mm² Solid

**INSTALLATION DATA**

<b>Screw Size</b>	M3	<b>PCB Hole Size</b>	–
<b>Torque</b>	0.5Nm (4.5 lbf-in.)	<b>Stripping Lgth.</b>	7.5mm

**MATERIAL**

<b>Body</b>	PA6.8	<b>Screw</b>	Galvanized Steel
<b>Flammability Class</b>	UL94V-0	<b>Terminal</b>	Nickeled Brass
<b>Temperature Limit</b>	105°C UL 125°C IEC	<b>Clamp</b>	Nickeled Brass
<b>Color</b>	Green		

No. Poles	Cat. #	Length (B) (mm)*	Std. Pk.
2	SH02-10.00	15.0	100
3	SH03-10.00	25.0	100
4	SH04-10.00	35.0	50
5	SH05-10.00	45.0	50
6	SH06-10.00	55.0	50
7	SH07-10.00	65.0	50
8	SH08-10.00	75.0	50
9	SH09-10.00	85.0	50
10	SH10-10.00	95.0	50
11	SH11-10.00	105.0	20
12	SH12-10.00	115.0	20



**Dimensions**

A	15.50 mm	I	2.80 mm
B	*	J	3.10 mm
C	19.15 mm	K	–
D	8.30 mm	L	–
E	–	M	–
F	–	N	–
G	–	O	2.70 mm
H	Ø3.80 mm	P	10.00 mm

# Pluggable PCB Blocks



Pin Spacing: 10.00mm  
 Orientation: Vertical Header  
 Clamp Type: –  
 Design: Single Mold - Open End



**PV-10.00**

**ELECTRICAL**

	Current	Voltage	Wire Range
	12A	300V	–
	16A	750V	–

**INSTALLATION DATA**

Screw Size	–	PCB Hole Size	1.5mm
Torque	–	Stripping Lgth.	–

**MATERIAL**

Body	PA6.8	Screw	–
Flammability Class	UL94V-0	Terminal	Tin-Plated Brass
Temperature Limit	105°C UL 125°C IEC	Clamp	–
Color	Green		

No. Poles	Cat. #	Length (B) (mm)*	Std. Pk.
2	PV02-10.00	15.0	100
3	PV03-10.00	25.0	100
4	PV04-10.00	35.0	50
5	PV05-10.00	45.0	50
6	PV06-10.00	55.0	50
7	PV07-10.00	65.0	50
8	PV08-10.00	75.0	50
9	PV09-10.00	85.0	50
10	PV10-10.00	95.0	50
11	PV11-10.00	105.0	20
12	PV12-10.00	115.0	20

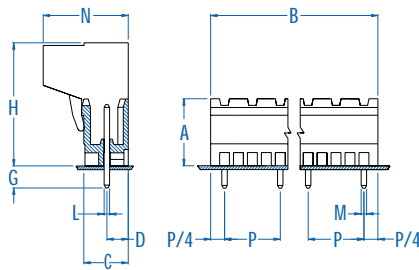

**Dimensions**

A	12.20 mm	I	–
B	*	J	–
C	8.10 mm	K	–
D	4.00 mm	L	1.00 mm
E	–	M	1.00 mm
F	–	N	15.50 mm
G	4.00 mm	O	–
H	23.15 mm	P	10.00 mm

Pin Spacing: 10.00mm  
 Orientation: Vertical Header  
 Clamp Type: –  
 Design: Single Mold - Closed End



**PVP-10.00**

**ELECTRICAL**

	Current	Voltage	Wire Range
	12A	300V	–
	16A	750V	–

**INSTALLATION DATA**

Screw Size	–	PCB Hole Size	1.5mm
Torque	–	Stripping Lgth.	–

**MATERIAL**

Body	PA6.8	Screw	–
Flammability Class	UL94V-0	Terminal	Tin-Plated Brass
Temperature Limit	105°C UL 125°C IEC	Clamp	–
Color	Green		

No. Poles	Cat. #	Length (B) (mm)*	Std. Pk.
2	PVP02-10.00	17.0	100
3	PVP03-10.00	27.0	100
4	PVP04-10.00	37.0	50
7	PVP07-10.00	47.0	50
6	PVP06-10.00	57.0	50
7	PVP07-10.00	67.0	50
8	PVP08-10.00	77.0	50
9	PVP09-10.00	87.0	50
10	PVP10-10.00	97.0	50
11	PVP11-10.00	107.0	20
12	PVP12-10.00	117.0	20



**Dimensions**

A	12.20 mm	I	–
B	*	J	–
C	8.10 mm	K	–
D	4.00 mm	L	1.00 mm
E	–	M	1.00 mm
F	–	N	15.50 mm
G	4.00 mm	O	–
H	23.15 mm	P	10.00 mm



# Pluggable PCB Blocks

Pin Spacing: 10.00mm  
 Orientation: Horizontal Header  
 Clamp Type: –  
 Design: Single Mold - Open End



**PH-10.00**

**ELECTRICAL**

	Current	Voltage	Wire Range
	12A	300V	–
	16A	750V	–

**INSTALLATION DATA**

Screw Size	–	PCB Hole Size	1.5mm
Torque	–	Stripping Lgth.	–

**MATERIAL**

Body	PA6.8	Screw	–
Flammability Class	UL94V-0	Terminal	Tin-Plated Brass
Temperature Limit	105°C UL 125°C IEC	Clamp	–
Color	Green		

No. Poles	Cat. #	Length (B) (mm)*	Std. Pk.
2	PH02-10.00	15.0	100
3	PH03-10.00	25.0	100
4	PH04-10.00	35.0	50
5	PH05-10.00	45.0	50
6	PH06-10.00	55.0	50
5	PH05-10.00	65.0	50
8	PH08-10.00	75.0	50
9	PH09-10.00	85.0	50
10	PH10-10.00	95.0	50
11	PH11-10.00	105.0	20
12	PH12-10.00	115.0	20



**Dimensions**

A	12.20 mm	I	–
B	*	J	–
C	8.10 mm	K	–
D	1.90 mm	L	1.00 mm
E	–	M	1.00 mm
F	–	N	15.50 mm
G	4.00 mm	O	–
H	23.15 mm	P	10.00 mm

Pin Spacing: 10.00mm  
 Orientation: Horizontal Header  
 Clamp Type: –  
 Design: Single Mold - Closed End



**PHP-10.00**

**ELECTRICAL**

	Current	Voltage	Wire Range
	12A	300V	–
	16A	750V	–

**INSTALLATION DATA**

Screw Size	–	PCB Hole Size	1.5mm
Torque	–	Stripping Lgth.	–

**MATERIAL**

Body	PA6.8	Screw	–
Flammability Class	UL94V-0	Terminal	Tin-Plated Brass
Temperature Limit	105°C UL 125°C IEC	Clamp	–
Color	Green		

No. Poles	Cat. #	Length (B) (mm)*	Std. Pk.
2	PHP02-10.00	17.0	100
3	PHP03-10.00	27.0	100
4	PHP04-10.00	37.0	50
7	PHP07-10.00	47.0	50
6	PHP06-10.00	57.0	50
7	PHP07-10.00	67.0	50
8	PHP08-10.00	77.0	50
9	PHP09-10.00	87.0	50
10	PHP10-10.00	97.0	50
11	PHP11-10.00	107.0	20
12	PHP12-10.00	117.0	20

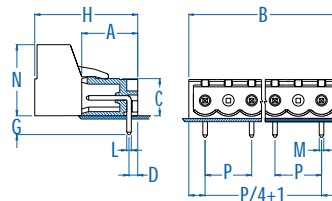

**Dimensions**

A	12.20 mm	I	–
B	*	J	–
C	8.10 mm	K	–
D	1.90 mm	L	1.00 mm
E	–	M	1.00 mm
F	–	N	15.50 mm
G	4.00 mm	O	–
H	23.15 mm	P	10.00 mm

# Pluggable PCB Blocks



Pin Spacing: 10.16mm  
 Orientation: Horizontal Plug  
 Clamp Type: Screw Cage  
 Design: Single Mold



**SH-10.16**

**ELECTRICAL**

	Current	Voltage	Wire Range
	12A	300V	30-14AWG
	16A	750V	2.5mm <sup>2</sup> Stranded 4.0mm <sup>2</sup> Solid

**INSTALLATION DATA**

<b>Screw Size</b>	M3	<b>PCB Hole Size</b>	–
<b>Torque</b>	0.5Nm (4.5 lbf-in.)	<b>Stripping Lgth.</b>	7.5mm

**MATERIAL**

<b>Body</b>	PA6.8	<b>Screw</b>	Galvanized Steel
<b>Flammability Class</b>	UL94V-0	<b>Terminal</b>	Nickeled Brass
<b>Temperature Limit</b>	105°C UL 125°C IEC	<b>Clamp</b>	Nickeled Brass
<b>Color</b>	Green		

No. Poles	Cat. #	Length (B) (mm)*	Std. Pk.
2	SH02-10.16	15.2	100
3	SH03-10.16	25.4	100
4	SH04-10.16	35.6	50
5	SH05-10.16	45.7	50
6	SH06-10.16	55.9	50
7	SH07-10.16	66.0	50
8	SH08-10.16	76.2	50
9	SH09-10.16	86.4	50
10	SH10-10.16	96.5	50
11	SH11-10.16	106.7	20
12	SH12-10.16	116.8	20



**Dimensions**

A	15.50 mm	I	2.80 mm
B	*	J	3.10 mm
C	18.80 mm	K	Ø1.80 mm
D	8.30 mm	L	–
E	1.00 mm	M	–
F	5.70 mm	N	–
G	–	O	2.70 mm
H	Ø3.80 mm	P	10.16 mm

Pin Spacing: 10.16mm  
 Orientation: Vertical Header  
 Clamp Type: –  
 Design: Single Mold - Open End



**PV-10.16**

**ELECTRICAL**

	Current	Voltage	Wire Range
	12A	300V	–
	16A	750V	–

**INSTALLATION DATA**

<b>Screw Size</b>	–	<b>PCB Hole Size</b>	1.5mm
<b>Torque</b>	–	<b>Stripping Lgth.</b>	–

**MATERIAL**

<b>Body</b>	PA6.8	<b>Screw</b>	–
<b>Flammability Class</b>	UL94V-0	<b>Terminal</b>	Tin-Plated Brass
<b>Temperature Limit</b>	105°C UL 125°C IEC	<b>Clamp</b>	–
<b>Color</b>	Green		

No. Poles	Cat. #	Length (B) (mm)*	Std. Pk.
2	PV02-10.16	15.2	100
3	PV03-10.16	25.4	100
4	PV04-10.16	35.6	50
5	PV05-10.16	45.7	50
6	PV06-10.16	55.9	50
7	PV07-10.16	66.0	50
8	PV08-10.16	76.2	50
9	PV09-10.16	86.4	50
10	PV10-10.16	96.5	50
11	PV11-10.16	106.7	20
12	PV12-10.16	116.8	20



**Dimensions**

A	12.20 mm	I	–
B	*	J	–
C	8.10 mm	K	–
D	4.00 mm	L	1.00 mm
E	–	M	1.00 mm
F	–	N	15.50 mm
G	4.00 mm	O	–
H	22.80 mm	P	10.16 mm

# Pluggable PCB Blocks

Pin Spacing: 10.16mm  
 Orientation: Vertical Header  
 Clamp Type: –  
 Design: Single Mold - Closed End



**PVP-10.16**

**ELECTRICAL**

	Current	Voltage	Wire Range
	12A	300V	–
	16A	750V	–

**INSTALLATION DATA**

Screw Size	–	PCB Hole Size	1.5mm
Torque	–	Stripping Lgth.	–

**MATERIAL**

Body	PA6.8	Screw	–
Flammability Class	UL94V-0	Terminal	Tin-Plated Brass
Temperature Limit	105°C UL 125°C IEC	Clamp	–
Color	Green		

No. Poles	Cat. #	Length (B) (mm)*	Std. Pk.
2	PVP02-10.16	17.2	100
3	PVP03-10.16	27.4	100
4	PVP04-10.16	37.6	50
5	PVP05-10.16	47.7	50
6	PVP06-10.16	57.9	50
7	PVP07-10.16	68.0	50
8	PVP08-10.16	78.2	50
9	PVP09-10.16	88.4	50
10	PVP10-10.16	98.5	50
11	PVP11-10.16	108.7	20
12	PVP12-10.16	118.8	20



**Dimensions**

A	12.20 mm	I	–
B	*	J	–
C	8.10 mm	K	–
D	4.00 mm	L	1.00 mm
E	–	M	1.00 mm
F	–	N	15.50 mm
G	4.00 mm	O	–
H	22.80 mm	P	10.16 mm

Pin Spacing: 10.16mm  
 Orientation: Horizontal Header  
 Clamp Type: –  
 Design: Single Mold - Open End



**PH-10.16**

**ELECTRICAL**

	Current	Voltage	Wire Range
	12A	300V	–
	16A	750V	–

**INSTALLATION DATA**

Screw Size	–	PCB Hole Size	1.5mm
Torque	–	Stripping Lgth.	–

**MATERIAL**

Body	PA6.8	Screw	–
Flammability Class	UL94V-0	Terminal	Tin-Plated Brass
Temperature Limit	105°C UL 125°C IEC	Clamp	–
Color	Green		

No. Poles	Cat. #	Length (B) (mm)*	Std Pk
2	PH02-10.16	15.2	100
3	PH03-10.16	25.4	100
4	PH04-10.16	35.6	50
5	PH05-10.16	45.7	50
6	PH06-10.16	55.9	50
7	PH07-10.16	66.0	50
8	PH08-10.16	76.2	50
9	PH09-10.16	86.4	50
10	PH10-10.16	96.5	50
11	PH11-10.16	106.7	20
12	PH12-10.16	116.8	20



**Dimensions**

A	12.20 mm	I	–
B	*	J	–
C	8.10 mm	K	–
D	4.00 mm	L	1.00 mm
E	–	M	1.00 mm
F	–	N	15.50 mm
G	4.00 mm	O	–
H	22.80 mm	P	10.16 mm

Pin Spacing: 10.16mm  
 Orientation: Horizontal Header  
 Clamp Type: –  
 Design: Single Mold - Closed End



**PHP-10.16**

**ELECTRICAL**

	Current	Voltage	Wire Range
	12A	300V	–
	16A	750V	–

**INSTALLATION DATA**

Screw Size	–	PCB Hole Size	1.5mm
Torque	–	Stripping Lgth.	–

**MATERIAL**

Body	PA6.8	Screw	–
Flammability Class	UL94V-0	Terminal	Tin-Plated Brass
Temperature Limit	105°C UL 125°C IEC	Clamp	–
Color	Green		

No. Poles	Cat. #	Length (B) (mm)*	Std. Pk.
2	PHP02-10.16	17.2	100
3	PHP03-10.16	27.4	100
4	PHP04-10.16	37.6	50
5	PHP05-10.16	47.7	50
6	PHP06-10.16	57.9	50
7	PHP07-10.16	68.0	50
8	PHP08-10.16	78.2	50
9	PHP09-10.16	88.4	50
10	PHP10-10.16	98.5	50
11	PHP11-10.16	108.7	20
12	PHP12-10.16	118.8	20



**Dimensions**

A	12.20 mm	I	–
B	*	J	–
C	8.10 mm	K	–
D	4.00 mm	L	1.00 mm
E	–	M	1.00 mm
F	–	N	15.50 mm
G	4.00 mm	O	–
H	22.80 mm	P	10.16 mm

Pin Spacing: 10.16mm  
 Orientation: Vertical-Double  
 Level Header  
 Clamp Type: –  
 Design: Modular - Open End

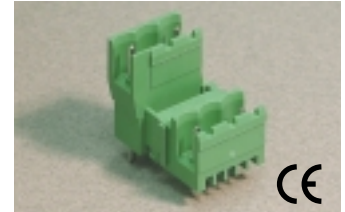

**PDSV-10.16**

**ELECTRICAL**

	Current	Voltage	Wire Range
	12A	300V	–
	16A	750V	–

**INSTALLATION DATA**

Screw Size	–	PCB Hole Size	1.5mm
Torque	–	Stripping Lgth.	–

**MATERIAL**

Body	PA6.8	Screw	–
Flammability Class	UL94V-0	Terminal	Tin-Plated Brass
Temperature Limit	105°C UL 125°C IEC	Clamp	–
Color	Green		

No. Poles	Cat. #	Length (B) (mm)	Std. Pk.
4	PDSV02-10.16	15.2	100
6	PDSV03-10.16	25.4	50
8	PDSV04-10.16	35.6	50
10	PDSV05-10.16	45.7	50
12	PDSV06-10.16	55.9	20
14	PDSV07-10.16	66.0	20
16	PDSV08-10.16	76.2	20
18	PDSV09-10.16	86.4	20
20	PDSV10-10.16	96.5	10
22	PDSV11-10.16	106.7	10
24	PDSV12-10.16	116.8	10



**Dimensions**

A	12.20 mm	I	–
B	15.20 mm	J	–
C	23.74 mm	K	–
D	3.90 mm	L	1.00 mm
E	15.24 mm	M	1.00 mm
F	4.00 mm	N	15.50 mm
G	22.00 mm	O	–
H	22.80 mm	P	10.16 mm



## Pluggable PCB Blocks

Pin Spacing: 10.16mm  
 Orientation: Horizontal-Double  
 Level Header  
 Clamp Type: –  
 Design: Modular - Open End



**PDSH-10.16**

### ELECTRICAL

	Current	Voltage	Wire Range
	12A	300V	–
	16A	750V	–

### INSTALLATION DATA

Screw Size	–	PCB Hole Size	1.5mm
Torque	–	Stripping Lgth.	–

### MATERIAL

Body	PA6.8	Screw	–
Flammability Class	UL94V-0	Terminal	Tin-Plated Brass
Temperature Limit	105°C UL 125°C IEC	Clamp	–
Color	Green		

No. Poles	Cat. #	Length (B) (mm)	Std. Pk.
4	PDSH02-10.16	15.2	100
6	PDSH03-10.16	25.4	50
8	PDSH04-10.16	35.6	50
10	PDSH05-10.16	45.7	50
12	PDSH06-10.16	55.9	20
14	PDSH07-10.16	66.0	20
16	PDSH08-10.16	76.2	20
18	PDSH09-10.16	86.4	20
20	PDSH10-10.16	96.5	10
22	PDSH11-10.16	106.7	10
24	PDSH12-10.16	116.8	10



### Dimensions

A	12.20 mm	I	–
B	15.20 mm	J	–
C	23.74 mm	K	–
D	1.90 mm	L	1.00 mm
E	10.00 mm	M	1.00 mm
F	4.00 mm	N	15.50 mm
G	22.00 mm	O	–
H	22.80 mm	P	10.16 mm

## Barrier Strips

Pin Spacing: 10.00mm  
 Orientation: Vertical  
 Clamp Type: Screw  
 Design: Modular



**MT-210\***

### ELECTRICAL

	Current	Voltage	Wire Range
	20A	300V	26-12AWG
	25A	750V	2x2.5mm <sup>2</sup> Stranded 4.0mm <sup>2</sup> Solid

### INSTALLATION DATA

Screw Size	M3.5	PCB Hole Size	1.4mm
Torque	0.8Nm (7.2 lbf-in.)	Stripping Lgth.	11.0mm

### MATERIAL

Body	PA6.8	Screw	Galvanized Steel
Flammability Class	UL94V-0	Terminal	Tin-Plated Brass
Temperature Limit	105°C UL 125°C IEC	Washer	Iron
Color	Black		

No. Poles	Cat. #	Length (B) (mm)	Std. Pk.
2	MT-2102	20.0	100
3	MT-2103	30.0	100
4	MT-2104	40.0	50
5	MT-2105	50.0	50
6	MT-2106	60.0	50
7	MT-2107	70.0	50
8	MT-2108	80.0	50
9	MT-2109	90.0	50
10	MT-2110	100.0	50
11	MT-2111	110.0	50
12	MT-2112	120.0	50
13	MT-2113	130.0	20
14	MT-2114	140.0	20
15	MT-2115	150.0	20
16	MT-2116	160.0	20
17	MT-2117	170.0	20
18	MT-2118	180.0	20
19	MT-2119	190.0	20
20	MT-2120	200.0	20
21	MT-2121	210.0	20
22	MT-2122	220.0	20
23	MT-2123	230.0	20
24	MT-2124	240.0	20



### Dimensions

A	16.00 mm	I	–
B	20.00 mm	J	–
C	17.50 mm	K	–
D	3.00 mm	L	0.80 mm
E	–	M	1.00 mm
F	–	N	10.00 mm
G	4.20 mm	O	7.75 mm
H	6.20 mm	P	10.00 mm

\* Also available with back wall.

# Panel Feed-through Blocks



Pin Spacing: 7.50mm  
 Orientation: Panel Mount  
 Clamp Type: Screw Cage  
 Design: Modular



## MPT-275/ CMR-75

### ELECTRICAL

	Current	Voltage	Wire Range
	15A <sup>①</sup>	300V	30-14AWG
	24A	450V	2.5mm <sup>2</sup> Stranded 4.0mm <sup>2</sup> Solid

### INSTALLATION DATA

<b>Screw Size</b>	M3	<b>Panel Hole Size</b>	5.2mm
<b>Torque</b>	0.5Nm (4.5 lbf-in.)	<b>Stripping Lgth.</b>	10.1mm

### MATERIAL

<b>Body</b>	PA6.8	<b>Screw</b>	Galvanized Steel
<b>Flammability Class</b>	UL94V-0	<b>Terminal</b>	Tin-Plated Brass
<b>Temperature Limit</b>	125°C IEC	<b>Clamp</b>	Nickeled Brass
<b>Color</b>	Green		

No. Poles	Cat. #	Length (B) (mm)	Std. Pk.
1	MPT-275	7.5	100

### Retaining Key

2	CMR-752	14.8	50
3	CMR-753	22.3	50



Wall Thickness <4.0 mm

### Dimensions

A	18.10 mm	I	2.80 mm
B	7.50 mm	J	2.70 mm
C	19.85 mm	K	Ø4.10 mm
D	5.60 mm	L	11.20 mm
E	14.90 mm	M	0.80 mm
F	-	N	8.00 mm
G	Ø5.00 mm	O	4.90 mm
H	10.10 mm	P	-



### Dimensions

A	25.20 mm	I	-
B	14.80 mm	J	-
C	6.80 mm	K	-
D	0.80 mm	L	3.30 mm
E	-	M	1.40 mm
F	-	N	-
G	-	O	-
H	2.30 mm	P	7.50 mm

① 24A Factory Wiring - UL

Pin Spacing: 10.00mm  
 Orientation: Panel Mount  
 Clamp Type: Screw Cage  
 Design: Modular



## MPT-410/ CMR-10

### ELECTRICAL

	Current	Voltage	Wire Range
	20A <sup>②</sup>	600V	30-12AWG
	32A	450V	4.0mm <sup>2</sup> Stranded 6.0mm <sup>2</sup> Solid

### INSTALLATION DATA

<b>Screw Size</b>	M3	<b>Panel Hole Size</b>	8.2mm
<b>Torque</b>	0.5Nm (4.5 lbf-in.)	<b>Stripping Lgth.</b>	10.1mm

### MATERIAL

<b>Body</b>	PA6.8	<b>Screw</b>	Galvanized Steel
<b>Flammability Class</b>	UL94V-0	<b>Terminal</b>	Tin-Plated Brass
<b>Temperature Limit</b>	125°C IEC	<b>Clamp</b>	Nickeled Brass
<b>Color</b>	Green		

No. Poles	Cat. #	Length (B) (mm)	Std. Pk.
1	MPT-410	10.0	100

### Retaining Key

2	CMR-102	19.8	50
3	CMR-103	29.3	50



Wall Thickness <4.0 mm

### Dimensions

A	20.90 mm	I	3.10 mm
B	10.00 mm	J	3.90 mm
C	19.85 mm	K	Ø5.00 mm
D	5.15 mm	L	11.20 mm
E	16.90 mm	M	0.80 mm
F	-	N	8.00 mm
G	Ø8.00 mm	O	4.75 mm
H	12.20 mm	P	-



### Dimensions

A	25.20 mm	I	-
B	19.80 mm	J	-
C	6.80 mm	K	-
D	0.80 mm	L	3.80 mm
E	-	M	1.65 mm
F	-	N	-
G	-	O	-
H	2.30 mm	P	10.00 mm

② 32A Factory Wiring - UL

# INDEX

PART # . . . . .	PAGE	PART # . . . . .	PAGE
CMR-10 . . . . .	49	MVEB-25 . . . . .	24
CMR-75 . . . . .	49	MVI . . . . .	39
MBE-15 . . . . .	7	MVS-15 . . . . .	8
MBES-15 . . . . .	12	MVSP-25 . . . . .	14
MH-15 . . . . .	10	MVSP-27 . . . . .	22
MH-25 . . . . .	14	MVT-25 . . . . .	17
MH-27 . . . . .	19	MVTB-25 . . . . .	27
MHB-25 . . . . .	25	PDSH-10.16 . . . . .	48
MHE-13 . . . . .	9	PDSH-5.08 . . . . .	37
MHE-16 . . . . .	10	PDSV-5.08 . . . . .	37
MHE-25 . . . . .	11	PDSV-10.16 . . . . .	47
MHE-27 . . . . .	20	PH-10.00 . . . . .	44
MHEB-25 . . . . .	24	PH-10.16 . . . . .	46
MHR-25 . . . . .	11	PH-5.00 . . . . .	32
MHR-27 . . . . .	20	PH-5.08 . . . . .	36
MHSP-25 . . . . .	15	PH-5.08-K . . . . .	39
MHSP-27 . . . . .	22	PH-7.50 . . . . .	41
MI-25 (35) . . . . .	15	PHP-10.00 . . . . .	44
MI-25 (45) . . . . .	16	PHP-10.16 . . . . .	47
MI-25 (5.00) . . . . .	12	PHP-5.00 . . . . .	33
MI-27 . . . . .	21	PHP-5.08 . . . . .	36
MPT-275 . . . . .	49	PHP-7.50 . . . . .	42
MPT-410 . . . . .	49	PV-10.00 . . . . .	43
MT-210 . . . . .	48	PV-10.16 . . . . .	45
MV-15 . . . . .	8	PV-5.00 . . . . .	31
MV-25 . . . . .	13	PV-5.08 . . . . .	35
MV-25-D . . . . .	13	PV-5.08-K . . . . .	38
MV-27 . . . . .	18	PV-7.50 . . . . .	40
MV-46 . . . . .	18	PVP-10.00 . . . . .	43
MV-47 . . . . .	21	PVP-10.16 . . . . .	46
MV-49 . . . . .	23	PVP-5.00 . . . . .	32
MVB-25 . . . . .	25	PVP-5.08 . . . . .	35
MVB-25-D . . . . .	26	PVP-7.50 . . . . .	41
MVD-25 . . . . .	16	PVS-5.00 . . . . .	30
MVDB-25 . . . . .	27	SH-10.00 . . . . .	42
MVDK-25 . . . . .	17	SH-10.16 . . . . .	45
MVDKB-25 . . . . .	26	SH-5.00 . . . . .	31
MVE-15 . . . . .	7	SH-5.08 . . . . .	33
MVE-25 . . . . .	9	SH-5.08-K . . . . .	38
MVE-27 . . . . .	19	SH-7.50 . . . . .	40
MVE-35 . . . . .	6	SHS-5.00 . . . . .	30
MVE-38 . . . . .	6	SVF-5.08 . . . . .	34
MVEB-15 . . . . .	23	SVP-5.08 . . . . .	34

## COMMONLY USED METRIC AND OTHER USEFUL CONVERSIONS

Length inch [in.]           x 25.4        =millimeters millimeters [mm]   x 0.03937   =inches meters [m]           x 3.281       =feet miles [mi]           x 1.609       =kilometers kilometers [km]     x 0.6214     =miles  Torque Newtonmeter [Nm]   x 0.738       =lb-ft lb-ft                   x 1.356       =Nm lb-in                  x 0.113       =Nm oz-in                  x 0.0071      =Nm  Power kilowatt [kW]        x 1.341       =hp hp                     x 0.7457      =kW  Moment of Inertia (WR2) lb-ft2                x 0.042       =kgm2 kilogrammeter2     23.720       =lb-ft2 [kgm2]  Weight Mass and Force Newton [N]           x 0.02248     =pound kilogram [kg]        x 2.205       =pounds pound [lb]            x 4.448       =N pound [lb]            x 0.4536      =kg	Metric Cross-Sectional Areas a		American Wire Gauge		Metric Cross-Sections Areas		American Wire Gauge	
	Cross-Sectional Area mm2	Equivalent Metric Area mm2	AWG or MCM	Cross-Sectional Area mm2	Equivalent Metric Area mm2	AWG or MCM		
0.50	0.519	20 AWG	25.0	21.15	4 AWG			
0.75	0.653	19	35.0	26.67	3			
	0.823	18		33.63	2			
	1.04	17		42.41	1			
	1.31	16	50.0	53.48	1/0			
1.5	1.65	15	70.0	67.43	2/0			
	2.08	14	95.0	85.03	3/0			
2.5	2.62	13		107.20	4/0			
	3.31	12	120.0	126.64	250 MCM			
	4.17	11	150.0	152.00	300			
4.0	5.26	10	185.0	177.35	350			
	6.63	9	240.0	202.71	400			
	8.37	8	300.0	253.35	500			
10.0	10.55	7	400.0	380.00	750			
	13.30	6	500.0	506.71	1000			
16.0	16.77	5	625.0					

<sup>a</sup>As per IEC Publ. 228

DEGREES CELSIUS VERSUS DEGREES FAHRENHEIT															
°C	°F	°C	°F	°C	°F	°C	°F	°C	°F	°C	°F	°C	°F	°C	°F
-80	-112.0	-20	-4.0	5	41.0	30	86.0	55	131.0	80	176.0	105	221.0	130	266.0
-70	-94.0	-19	-2.2	6	42.8	31	87.8	56	132.8	81	177.8	106	222.8	131	267.8
-60	-65.0	-18	-0.4	7	44.6	32	89.6	57	134.6	82	179.6	107	224.6	132	269.6
-50	-58.0	-17	+1.4	8	46.4	33	91.4	58	136.4	83	181.4	108	226.4	133	271.4
-45	-49.1	-16	3.2	9	48.2	34	93.2	59	138.2	84	183.2	109	228.2	134	273.2
-40	-40.0	-15	5.0	10	50.0	35	95.0	60	140.0	85	185.0	110	230.0	135	275.0
-39	-38.2	-14	6.8	11	51.8	36	96.8	61	141.8	86	186.8	111	231.8	136	276.8
-38	-36.4	-13	8.6	12	53.6	37	98.6	62	143.6	87	188.6	112	233.6	137	278.6
-37	-34.6	-12	10.4	13	55.4	38	100.4	63	145.4	88	189.4	113	235.4	138	280.4
-36	-32.8	-11	12.2	14	57.2	39	102.2	64	147.2	89	192.2	114	237.2	139	282.2
-35	-31.0	-10	14.0	15	59.0	40	104.0	65	149.0	90	194.0	115	239.0	140	284.0
-34	-29.2	-9	15.8	16	60.8	41	105.8	66	150.8	91	195.8	116	240.8	141	285.8
-33	-27.4	-8	17.6	17	62.6	42	107.6	67	152.6	92	197.6	117	242.6	142	287.6
-32	-25.6	-7	19.4	18	64.4	43	109.4	68	154.4	93	199.4	118	244.4	143	289.4
-31	-23.8	-6	21.2	19	66.2	44	111.2	69	156.2	94	201.2	119	246.2	144	291.2
-30	-22.0	-5	23.0	20	68.0	45	113.0	70	158.0	95	203.0	120	248.0	145	293.0
-29	-22.0	-4	24.8	21	69.8	46	114.8	71	159.8	96	204.8	121	249.8	146	294.8
-28	-18.4	-3	26.6	22	71.6	47	116.6	72	161.6	97	206.6	122	251.6	147	296.6
-27	-16.6	-2	28.4	23	73.4	48	118.4	73	163.4	98	208.4	123	253.4	148	298.4
-26	-14.8	-1	30.2	24	75.2	49	120.2	74	165.2	99	210.2	124	255.2	149	300.2
-25	-13.0	0	32.0	25	77.0	50	122.0	75	167.0	100	212.0	125	257.0	150	302.0
-24	-11.2	1	33.8	26	78.8	51	123.8	76	168.8	101	213.8	126	258.8	160	320.0
-23	-9.4	2	35.6	27	80.6	52	125.6	77	170.6	102	215.6	127	260.6	170	338.0
-22	-7.6	3	37.4	28	82.4	53	127.4	78	172.4	103	217.4	128	262.4	180	356.0
-21	-5.8	4	39.2	29	84.2	54	129.2	79	174.2	104	219.2	129	264.2	190	374.0
														2000	3632

Conversion Formula °F = 9/5°C + 32°      °C = 5/9(°F-32°)



Компания «Океан Электроники» предлагает заключение долгосрочных отношений при поставках импортных электронных компонентов на взаимовыгодных условиях!

Наши преимущества:

- Поставка оригинальных импортных электронных компонентов напрямую с производств Америки, Европы и Азии, а так же с крупнейших складов мира;
- Широкая линейка поставок активных и пассивных импортных электронных компонентов (более 30 млн. наименований);
- Поставка сложных, дефицитных, либо снятых с производства позиций;
- Оперативные сроки поставки под заказ (от 5 рабочих дней);
- Экспресс доставка в любую точку России;
- Помощь Конструкторского Отдела и консультации квалифицированных инженеров;
- Техническая поддержка проекта, помощь в подборе аналогов, поставка прототипов;
- Поставка электронных компонентов под контролем ВП;
- Система менеджмента качества сертифицирована по Международному стандарту ISO 9001;
- При необходимости вся продукция военного и аэрокосмического назначения проходит испытания и сертификацию в лаборатории (по согласованию с заказчиком);
- Поставка специализированных компонентов военного и аэрокосмического уровня качества (Xilinx, Altera, Analog Devices, Intersil, Interpoint, Microsemi, Actel, Aeroflex, Peregrine, VPT, Syfer, Eurofarad, Texas Instruments, MS Kennedy, Miteq, Cobham, E2V, MA-COM, Hittite, Mini-Circuits, General Dynamics и др.);

Компания «Океан Электроники» является официальным дистрибьютором и эксклюзивным представителем в России одного из крупнейших производителей разъемов военного и аэрокосмического назначения «JONHON», а так же официальным дистрибьютором и эксклюзивным представителем в России производителя высокотехнологичных и надежных решений для передачи СВЧ сигналов «FORSTAR».



## JONHON

«JONHON» (основан в 1970 г.)

Разъемы специального, военного и аэрокосмического назначения:

(Применяются в военной, авиационной, аэрокосмической, морской, железнодорожной, горно- и нефтедобывающей отраслях промышленности)

«FORSTAR» (основан в 1998 г.)

ВЧ соединители, коаксиальные кабели, кабельные сборки и микроволновые компоненты:

(Применяются в телекоммуникациях гражданского и специального назначения, в средствах связи, РЛС, а так же военной, авиационной и аэрокосмической отраслях промышленности).



Телефон: 8 (812) 309-75-97 (многоканальный)

Факс: 8 (812) 320-03-32

Электронная почта: [ocean@oceanchips.ru](mailto:ocean@oceanchips.ru)

Web: <http://oceanchips.ru/>

Адрес: 198099, г. Санкт-Петербург, ул. Калинина, д. 2, корп. 4, лит. А