

Features

- High-performance, Low-power 8/16-bit Atmel® AVR® XMEGA™ Microcontroller
- Non-volatile Program and Data Memories
 - 16 KB - 128 KB of In-System Self-Programmable Flash
 - 4 KB - 8 KB Boot Code Section with Independent Lock Bits
 - 1 KB - 2 KB EEPROM
 - 2 KB - 8 KB Internal SRAM
- Peripheral Features
 - Four-channel DMA Controller with support for external requests
 - Eight-channel Event System
 - Five 16-bit Timer/Counters
 - Three Timer/Counters with 4 Output Compare or Input Capture channels
 - Two Timer/Counters with 2 Output Compare or Input Capture channels
 - High-Resolution Extensions on all Timer/Counters
 - Advanced Waveform Extension on one Timer/Counter
 - Five USARTs
 - IrDA Extension on one USART
 - Two Two-Wire Interfaces with dual address match (I²C and SMBus compatible)
 - Two SPIs (Serial Peripheral Interfaces) peripherals
 - AES and DES Crypto Engine
 - 16-bit Real Time Counter with Separate Oscillator
 - One Twelve-channel, 12-bit, 2 Msps Analog to Digital Converter
 - One Two-channel, 12-bit, 1 Msps Digital to Analog Converter
 - Two Analog Comparators with Window compare function
 - External Interrupts on all General Purpose I/O pins
 - Programmable Watchdog Timer with Separate On-chip Ultra Low Power Oscillator
- Special Microcontroller Features
 - Power-on Reset and Programmable Brown-out Detection
 - Internal and External Clock Options with PLL
 - Programmable Multi-level Interrupt Controller
 - Sleep Modes: Idle, Power-down, Standby, Power-save, Extended Standby
 - Advanced Programming, Test and Debugging Interfaces
 - PDI (Program and Debug Interface) for programming, test and debugging
- I/O and Packages
 - 34 Programmable I/O Lines
 - 44 - lead TQFP
 - 44 - pad VQFN/QFN
 - 49 - ball VFBGA
- Operating Voltage
 - 1.6 – 3.6V
- Speed performance
 - 0 – 12 MHz @ 1.6 – 3.6V
 - 0 – 32 MHz @ 2.7 – 3.6V

Typical Applications

- Industrial control
- Climate control
- Hand-held battery applications
- Factory automation
- ZigBee
- Power tools
- Building control
- Motor control
- HVAC
- Board control
- Networking
- Metering
- White Goods
- Optical
- Medical Applications



8/16-bit AVR® XMEGA A4 Microcontroller

ATxmega128A4
ATxmega64A4
ATxmega32A4
ATxmega16A4

Not recommended for
new designs - Use
XMEGA A4U series

8069R-AVR-06/2013



Not recommended for new designs -
Use XMEGA A4U series

1. Ordering Information

Ordering Code	Flash	E ²	SRAM	Speed (MHz)	Power Supply	Package ⁽¹⁾⁽²⁾⁽³⁾	Temp
ATxmega128A4-AU	128 KB + 8 KB	2 KB	8 KB	32	1.6 - 3.6V	44A	-40°C - 85°C
ATxmega64A4-AU	64 KB + 4 KB	2 KB	4 KB	32	1.6 - 3.6V		
ATxmega32A4-AU	32 KB + 4 KB	1 KB	4 KB	32	1.6 - 3.6V		
ATxmega16A4-AU	16 KB + 4 KB	1 KB	2 KB	32	1.6 - 3.6V		
ATxmega128A4-MH	128 KB + 8 KB	2 KB	8 KB	32	1.6 - 3.6V	44M1	
ATxmega64A4-MH	64 KB + 4 KB	2 KB	4 KB	32	1.6 - 3.6V		
ATxmega32A4-MH	32 KB + 4 KB	1 KB	4 KB	32	1.6 - 3.6V		
ATxmega16A4-MH	16 KB + 4 KB	1 KB	2 KB	32	1.6 - 3.6V		
ATxmega32A4-CU	32 KB + 4K	1 KB	4 KB	32	1.6 - 3.6V	49C2	
ATxmega16A4-CU	16 KB + 4 KB	1 KB	2 KB	32	1.6 - 3.6V		

- Notes:
1. This device can also be supplied in wafer form. Please contact your local Atmel sales office for detailed ordering information.
 2. Pb-free packaging, complies to the European Directive for Restriction of Hazardous Substances (RoHS directive). Also Halide free and fully Green.
 3. For packaging information see "[Packaging information](#)" on page 58.

Package Type	
44A	44-Lead, 10 x 10 mm Body Size, 1.0 mm Body Thickness, 0.8 mm Lead Pitch, Thin Profile Plastic Quad Flat Package (TQFP)
44M1	44-Pad, 7x7x1 mm Body, Lead Pitch 0.50 mm, 5.20 mm Exposed Pad, Thermally Enhanced Plastic Very Thin Quad No Lead Package (VQFN)
49C2	49-Ball (7 x 7 Array), 0.65 mm Pitch, 5.0 x 5.0 x 1.0 mm, Very Thin, Fine-Pitch Ball Grid Array Package (VFPGA)

2. Pinout/Block Diagram

Figure 2-1. Block Diagram and TQFP/QFN pinout

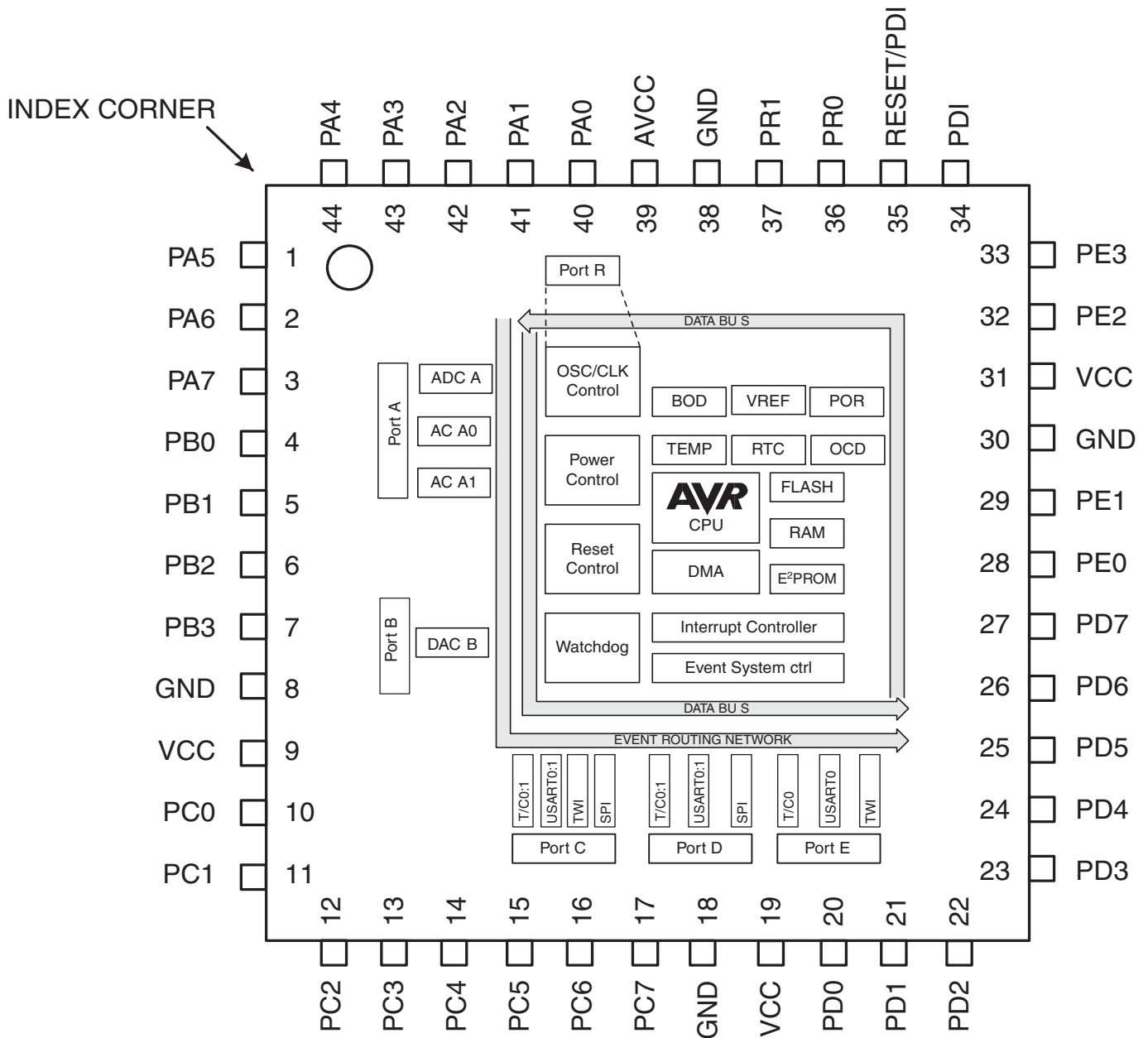

- Notes:
1. For full details on pinout and pin functions refer to "Pinout and Pin Functions" on page 49.
 2. The large center pad underneath the QFN/MLF package should be soldered to ground on the board to ensure good mechanical stability.

Figure 2-2. VFBGA pinout

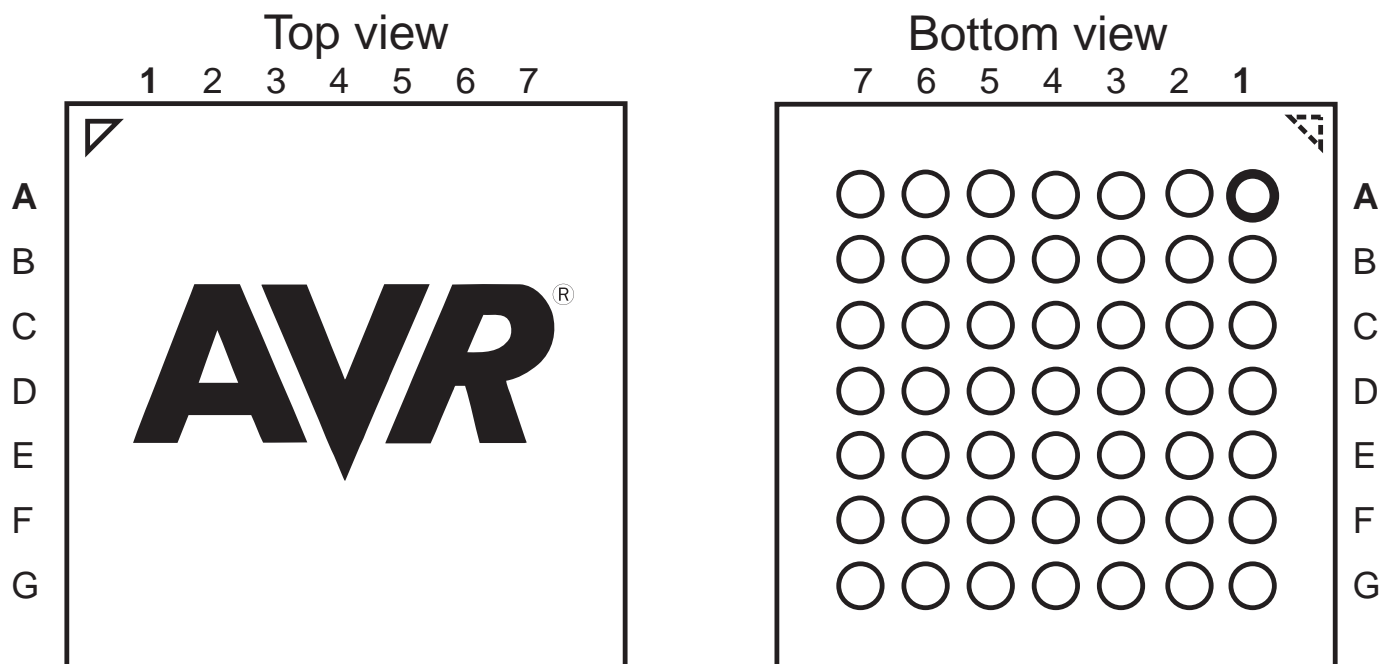

Table 2-1. VFBGA pinout

	1	2	3	4	5	6	
A	PA3	AVCC	GND	PR1	PR0	PDI	PE3
B	PA4	PA1	PA0	GND	RESET/PDI	PE2	VCC
C	PA5	PA2	PA6	PA7	GND	PE1	GND
D	PB1	PB2	PB3	PB0	GND	PD7	PE0
E	GND	GND	PC3	GND	PD4	PD5	PD6
F	VCC	PC0	PC4	PC6	PD0	PD1	PD3
G	PC1	PC2	PC5	PC7	GND	VCC	PD2

3. Overview

The Atmel® AVR® XMEGA™ A4 is a family of low power, high performance and peripheral rich CMOS 8/16-bit microcontrollers based on the AVR enhanced RISC architecture. By executing powerful instructions in a single clock cycle, the XMEGA A4 achieves throughputs approaching 1 Million Instructions Per Second (MIPS) per MHz allowing the system designer to optimize power consumption versus processing speed.

The AVR CPU combines a rich instruction set with 32 general purpose working registers. All the 32 registers are directly connected to the Arithmetic Logic Unit (ALU), allowing two independent registers to be accessed in one single instruction, executed in one clock cycle. The resulting architecture is more code efficient while achieving throughputs many times faster than conventional single-accumulator or CISC based microcontrollers.

The XMEGA A4 devices provide the following features: In-System Programmable Flash with Read-While-Write capabilities, Internal EEPROM and SRAM, four-channel DMA Controller, eight-channel Event System, Programmable Multi-level Interrupt Controller, 34 general purpose I/O lines, 16-bit Real Time Counter (RTC), five flexible 16-bit Timer/Counters with compare modes and PWM, five USARTs, two Two Wire Serial Interfaces (TWIs), two Serial Peripheral Interfaces (SPIs), AES and DES crypto engine, one Twelve-channel, 12-bit ADC with optional differential input with programmable gain, one Two-channel 12-bit DAC, two analog comparators with window mode, programmable Watchdog Timer with separate Internal Oscillator, accurate internal oscillators with PLL and prescaler and programmable Brown-Out Detection.

The Program and Debug Interface (PDI), a fast 2-pin interface for programming and debugging, is available.

The XMEGA A4 devices have five software selectable power saving modes. The Idle mode stops the CPU while allowing the SRAM, DMA Controller, Event System, Interrupt Controller and all peripherals to continue functioning. The Power-down mode saves the SRAM and register contents but stops the oscillators, disabling all other functions until the next TWI or pin-change interrupt, or Reset. In Power-save mode, the asynchronous Real Time Counter continues to run, allowing the application to maintain a timer base while the rest of the device is sleeping. In Standby mode, the Crystal/Resonator Oscillator is kept running while the rest of the device is sleeping. This allows very fast start-up from external crystal combined with low power consumption. In Extended Standby mode, both the main Oscillator and the Asynchronous Timer continue to run. To further reduce power consumption, the peripheral clock to each individual peripheral can optionally be stopped in Active mode and in Idle sleep mode.

The device is manufactured using Atmel's high-density nonvolatile memory technology. The program Flash memory can be reprogrammed in-system through the PDI. A Bootloader running in the device can use any interface to download the application program to the Flash memory. The Bootloader software in the Boot Flash section will continue to run while the Application Flash section is updated, providing true Read-While-Write operation. By combining an 8/16-bit RISC CPU with In-System Self-Programmable Flash, the Atmel XMEGA A4 is a powerful microcontroller family that provides a highly flexible and cost effective solution for many embedded applications.

The XMEGA A4 devices are supported with a full suite of program and system development tools including: C compilers, macro assemblers, program debugger/simulators, programmers, and evaluation kits.

3.1 Block Diagram

Figure 3-1. XMEGA A4 Block Diagram

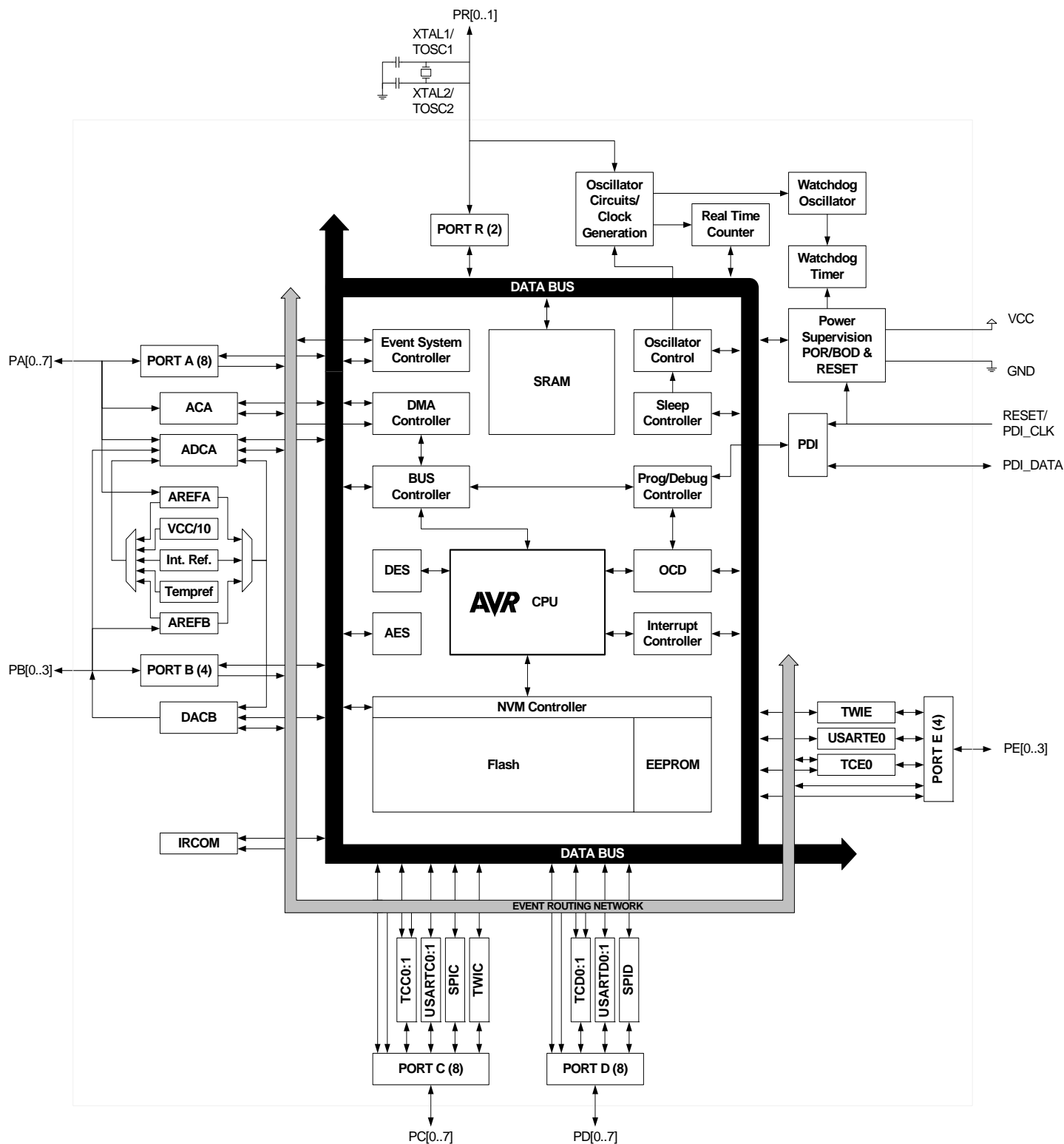

4. Resources

A comprehensive set of development tools, application notes and datasheets are available for download on <http://www.atmel.com/avr>.

4.1 Recommended reading

- Atmel AVR XMEGA A Manual
- XMEGA A Application Notes

This device data sheet only contains part specific information and a short description of each peripheral and module. The XMEGA A Manual describes the modules and peripherals in depth. The XMEGA A application notes contain example code and show applied use of the modules and peripherals.

The XMEGA A Manual and Application Notes are available from <http://www.atmel.com/avr>.

5. Disclaimer

For devices that are not available yet, typical values contained in this datasheet are based on simulations and characterization of other AVR XMEGA microcontrollers manufactured on the same process technology. Min. and Max values will be available after the device is characterized.

6. AVR CPU

6.1 Features

- 8/16-bit high performance AVR RISC Architecture
 - 138 instructions
 - Hardware multiplier
- 32x8-bit registers directly connected to the ALU
- Stack in RAM
- Stack Pointer accessible in I/O memory space
- Direct addressing of up to 16M Bytes of program and data memory
- True 16/24-bit access to 16/24-bit I/O registers
- Support for 8-, 16- and 32-bit Arithmetic
- Configuration Change Protection of system critical features

6.2 Overview

The XMEGA A4 uses the 8/16-bit AVR CPU. The main function of the CPU is program execution. The CPU must therefore be able to access memories, perform calculations and control peripherals. Interrupt handling is described in a separate section. [Figure 6-1 on page 8](#) shows the CPU block diagram.

Figure 6-1. CPU block diagram

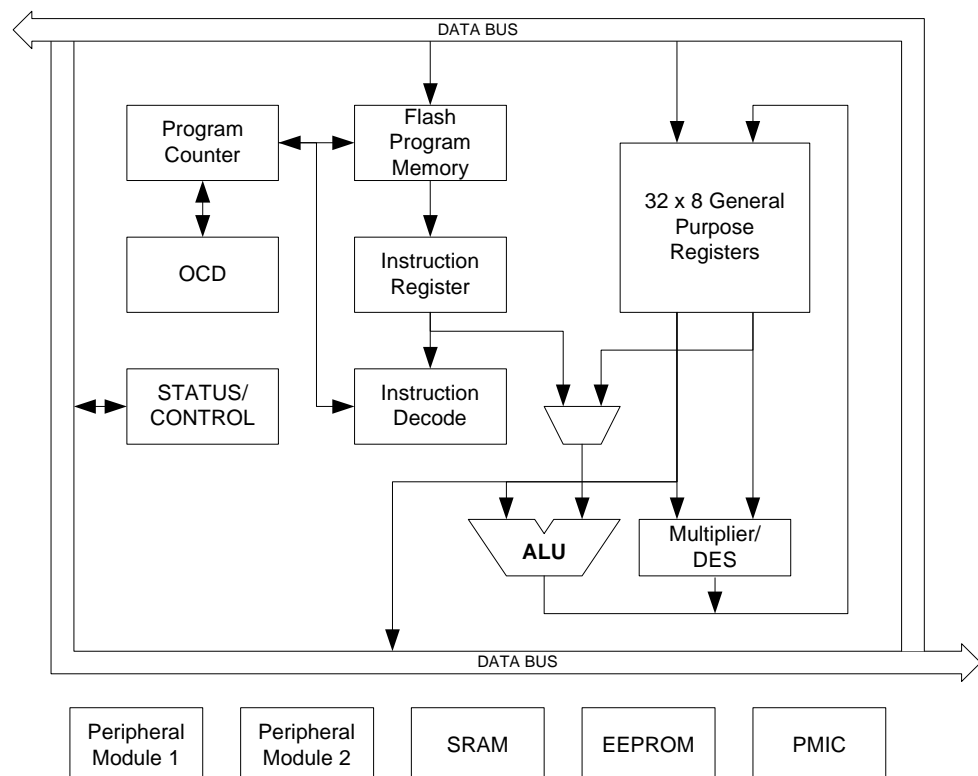

The AVR uses a Harvard architecture - with separate memories and buses for program and data. Instructions in the program memory are executed with a single level pipeline. While one instruction is being executed, the next instruction is pre-fetched from the program memory. This

concept enables instructions to be executed in every clock cycle. The program memory is In-System Re-programmable Flash memory.

6.3 Register File

The fast-access Register File contains 32 x 8-bit general purpose working registers with single clock cycle access time. This allows single-cycle Arithmetic Logic Unit (ALU) operation. In a typical ALU cycle, the operation is performed on two Register File operands, and the result is stored back in the Register File.

Six of the 32 registers can be used as three 16-bit address register pointers for data space addressing - enabling efficient address calculations. One of these address pointers can also be used as an address pointer for look up tables in Flash program memory.

6.4 ALU - Arithmetic Logic Unit

The high performance Arithmetic Logic Unit (ALU) supports arithmetic and logic operations between registers or between a constant and a register. Single register operations can also be executed. Within a single clock cycle, arithmetic operations between general purpose registers or between a register and an immediate are executed. After an arithmetic or logic operation, the Status Register is updated to reflect information about the result of the operation.

The ALU operations are divided into three main categories – arithmetic, logical, and bit-functions. Both 8- and 16-bit arithmetic is supported, and the instruction set allows for efficient implementation of 32-bit arithmetic. The ALU also provides a powerful multiplier supporting both signed and unsigned multiplication and fractional format.

6.5 Program Flow

When the device is powered on, the CPU starts to execute instructions from the lowest address in the Flash Program Memory '0'. The Program Counter (PC) addresses the next instruction to be fetched. After a reset, the PC is set to location '0'.

Program flow is provided by conditional and unconditional jump and call instructions, capable of addressing the whole address space directly. Most AVR instructions use a 16-bit word format, while a limited number uses a 32-bit format.

During interrupts and subroutine calls, the return address PC is stored on the Stack. The Stack is effectively allocated in the general data SRAM, and consequently the Stack size is only limited by the total SRAM size and the usage of the SRAM. After reset the Stack Pointer (SP) points to the highest address in the internal SRAM. The SP is read/write accessible in the I/O memory space, enabling easy implementation of multiple stacks or stack areas. The data SRAM can easily be accessed through the five different addressing modes supported in the AVR CPU.

7. Memories

7.1 Features

- **Flash Program Memory**
 - One linear address space
 - In-System Programmable
 - Self-Programming and Bootloader support
 - Application Section for application code
 - Application Table Section for application code or data storage
 - Boot Section for application code or bootloader code
 - Separate lock bits and protection for all sections
 - Built in fast CRC check of a selectable flash program memory section
- **Data Memory**
 - One linear address space
 - Single cycle access from CPU
 - SRAM
 - EEPROM
 - Byte and page accessible
 - Optional memory mapping for direct load and store
 - I/O Memory
 - Configuration and Status registers for all peripherals and modules
 - 16 bit-accessible General Purpose Register for global variables or flags
 - Bus arbitration
 - Safe and deterministic handling of CPU and DMA Controller priority
 - Separate buses for SRAM, EEPROM, I/O Memory and External Memory access
 - Simultaneous bus access for CPU and DMA Controller
- **Production Signature Row Memory for factory programmed data**
 - Device ID for each microcontroller device type
 - Serial number for each device
 - Oscillator calibration bytes
 - ADC, DAC and temperature sensor calibration data
- **User Signature Row**
 - One flash page in size
 - Can be read and written from software
 - Content is kept after chip erase

7.2 Overview

The AVR architecture has two main memory spaces, the Program Memory and the Data Memory. In addition, the XMEGA A4 features an EEPROM Memory for non-volatile data storage. All three memory spaces are linear and require no paging. The available memory size configurations are shown in ["Ordering Information" on page 2](#). In addition each device has a Flash memory signature row for calibration data, device identification, serial number etc.

Non-volatile memory spaces can be locked for further write or read/write operations. This prevents unrestricted access to the application software.

7.3 In-System Programmable Flash Program Memory

The XMEGA A4 devices contain On-chip In-System Programmable Flash memory for program storage, see [Figure 7-1 on page 11](#). Since all AVR instructions are 16- or 32-bits wide, each Flash address location is 16 bits.

The Program Flash memory space is divided into Application and Boot sections. Both sections have dedicated Lock Bits for setting restrictions on write or read/write operations. The Store Program Memory (SPM) instruction must reside in the Boot Section when used to write to the Flash memory.

A third section inside the Application section is referred to as the Application Table section which has separate Lock bits for storage of write or read/write protection. The Application Table section can be used for storing non-volatile data or application software.

Figure 7-1. Flash Program Memory (Hexadecimal address)

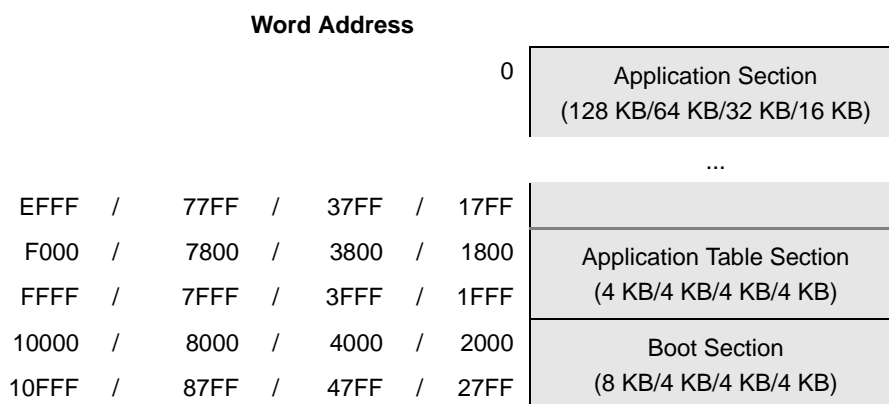

The Application Table Section and Boot Section can also be used for general application software.

7.4 Data Memory

The Data Memory consist of the I/O Memory, EEPROM and SRAM memories, all within one linear address space, see [Figure 7-2 on page 12](#). To simplify development, the memory map for all devices in the family is identical and with empty, reserved memory space for smaller devices.

Figure 7-2. Data Memory Map (Hexadecimal address)

Byte Address	ATxmega64A4	Byte Address	ATxmega32A4	Byte Address	ATxmega16A4
0	I/O Registers (4 KB)	0	I/O Registers (4 KB)	0	I/O Registers (4 KB)
FFF		FFF		FFF	
1000	EEPROM (2 KB)	1000	EEPROM (1 KB)	1000	EEPROM (1 KB)
17FF		13FF		13FF	
	RESERVED		RESERVED		RESERVED
2000	Internal SRAM (4 KB)	2000	Internal SRAM (4 KB)	2000	Internal SRAM (2 KB)
2FFF		2FFF		27FF	

Byte Address	ATxmega128A4
0	I/O Registers (4 KB)
FFF	
1000	EEPROM (2 KB)
17FF	
	RESERVED
2000	Internal SRAM (8 KB)
3FFF	

7.4.1 I/O Memory

All peripherals and modules are addressable through I/O memory locations in the data memory space. All I/O memory locations can be accessed by the Load (LD/LDS/LDD) and Store (ST/STS/STD) instructions, transferring data between the 32 general purpose registers in the CPU and the I/O Memory.

The IN and OUT instructions can address I/O memory locations in the range 0x00 - 0x3F directly.

I/O registers within the address range 0x00 - 0x1F are directly bit-accessible using the SBI and CBI instructions. The value of single bits can be checked by using the SBIS and SBIC instructions on these registers.

The I/O memory address for all peripherals and modules in XMEGA A4 is shown in the "[Peripheral Module Address Map](#)" on page 53.

7.4.2 SRAM Data Memory

The XMEGA A4 devices have internal SRAM memory for data storage.

7.4.3 EEPROM Data Memory

The XMEGA A4 devices have internal EEPROM memory for non-volatile data storage. It is addressable either in a separate data space or it can be memory mapped into the normal data memory space. The EEPROM memory supports both byte and page access.

7.5 Production Signature Row

The Production Signature Row is a separate memory section for factory programmed data. It contains calibration data for functions such as oscillators and analog modules.

The production signature row also contains a device ID that identify each microcontroller device type, and a serial number that is unique for each manufactured device. The device ID for the available XMEGA A4 devices is shown in [Table 7-1 on page 13](#). The serial number consist of the production LOT number, wafer number, and wafer coordinates for the device.

The production signature row can not be written or erased, but it can be read from both application software and external programming.

Table 7-1. Device ID bytes for XMEGA A4 devices.

Device	Device ID bytes		
	Byte 2	Byte 1	Byte 0
ATxmega16A4	41	94	1E
ATxmega32A4	41	95	1E
ATxmega64A4	46	96	1E
ATxmega128A4	46	97	1E

7.6 User Signature Row

The User Signature Row is a separate memory section that is fully accessible (read and write) from application software and external programming. The user signature row is one flash page in size, and is meant for static user parameter storage, such as calibration data, custom serial numbers or identification numbers, random number seeds etc. This section is not erased by Chip Erase commands that erase the Flash, and requires a dedicated erase command. This ensures parameter storage during multiple program/erase session and on-chip debug sessions.

7.7 Flash and EEPROM Page Size

The Flash Program Memory and EEPROM data memory are organized in pages. The pages are word accessible for the Flash and byte accessible for the EEPROM.

Table 7-2 on page 14 shows the Flash Program Memory organization. Flash write and erase operations are performed on one page at a time, while reading the Flash is done one byte at a time. For Flash access the Z-pointer (Z[m:n]) is used for addressing. The most significant bits in the address (FPAGE) give the page number and the least significant address bits (FWORD) give the word in the page.

Table 7-2. Number of words and Pages in the Flash.

Devices	Flash Size	Page Size (words)	FWORD	FPAGE	Application		Boot	
					Size	No of Pages	Size	No of Pages
ATxmega16A4	16 KB + 4 KB	128	Z[6:0]	Z[13:7]	16 KB	64	4 KB	16
ATxmega32A4	32 KB + 4 KB	128	Z[6:0]	Z[14:7]	32 KB	128	4 KB	16
ATxmega64A4	64 KB + 4 KB	128	Z[6:0]	Z[15:7]	64 KB	128	4 KB	16
ATxmega128A4	128 KB + 8 KB	256	Z[7:0]	Z[16:8]	128 KB	256	8 KB	16

Table 7-3 on page 14 shows EEPROM memory organization for the XMEGA A4 devices. EEPROM write and erase operations can be performed one page or one byte at a time, while reading the EEPROM is done one byte at a time. For EEPROM access the NVM Address Register (ADDR[m:n]) is used for addressing. The most significant bits in the address (E2PAGE) give the page number and the least significant address bits (E2BYTE) give the byte in the page.

Table 7-3. Number of Bytes and Pages in the EEPROM.

Devices	EEPROM Size	Page Size (Bytes)	E2BYTE	E2PAGE	No of Pages
ATxmega16A4	1 KB	32	ADDR[4:0]	ADDR[10:5]	32
ATxmega32A4	1 KB	32	ADDR[4:0]	ADDR[10:5]	32
ATxmega64A4	2 KB	32	ADDR[4:0]	ADDR[10:5]	64
ATxmega128A4	2 KB	32	ADDR[4:0]	ADDR[10:5]	64

8. DMAC - Direct Memory Access Controller

8.1 Features

- **Allows High-speed data transfer**
 - From memory to peripheral
 - From memory to memory
 - From peripheral to memory
 - From peripheral to peripheral
- **4 Channels**
- **From 1 byte and up to 16 M bytes transfers in a single transaction**
- **Multiple addressing modes for source and destination address**
 - Increment
 - Decrement
 - Static
- **1, 2, 4, or 8 bytes Burst Transfers**
- **Programmable priority between channels**

8.2 Overview

The XMEGA A4 has a Direct Memory Access (DMA) Controller to move data between memories and peripherals in the data space. The DMA controller uses the same data bus as the CPU to transfer data.

It has 4 channels that can be configured independently. Each DMA channel can perform data transfers in blocks of configurable size from 1 to 64K bytes. A repeat counter can be used to repeat each block transfer for single transactions up to 16M bytes. Each DMA channel can be configured to access the source and destination memory address with incrementing, decrementing or static addressing. The addressing is independent for source and destination address. When the transaction is complete the original source and destination address can automatically be reloaded to be ready for the next transaction.

The DMAC can access all the peripherals through their I/O memory registers, and the DMA may be used for automatic transfer of data to/from communication modules, as well as automatic data retrieval from ADC conversions, data transfer to DAC conversions, or data transfer to or from port pins. A wide range of transfer triggers is available from the peripherals, Event System and software. Each DMA channel has different transfer triggers.

To allow for continuous transfer, two channels can be interlinked so that the second takes over the transfer when the first is finished and vice versa.

The DMA controller can read from memory mapped EEPROM, but it cannot write to the EEPROM or access the Flash.

9. Event System

9.1 Features

- Inter-peripheral communication and signalling with minimum latency
- CPU and DMA independent operation
- 8 Event Channels allow for up to 8 signals to be routed at the same time
- Events can be generated by
 - Timer/Counters (TCxn)
 - Real Time Counter (RTC)
 - Analog to Digital Converters (ADCx)
 - Analog Comparators (ACx)
 - Ports (PORTx)
 - System Clock (Clk_{SYS})
 - Software (CPU)
- Events can be used by
 - Timer/Counters (TCxn)
 - Analog to Digital Converters (ADCx)
 - Digital to Analog Converters (DACx)
 - Ports (PORTx)
 - DMA Controller (DMAC)
 - IR Communication Module (IRCOM)
- The same event can be used by multiple peripherals for synchronized timing
- Advanced Features
 - Manual Event Generation from software (CPU)
 - Quadrature Decoding
 - Digital Filtering
- Functions in Active and Idle mode

9.2 Overview

The Event System is a set of features for inter-peripheral communication. It enables the possibility for a change of state in one peripheral to automatically trigger actions in one or more peripherals. Whose changes in a peripheral that will trigger actions in other peripherals are configurable by software. It is a simple, but powerful system as it allows for autonomous control of peripherals without any use of interrupts, CPU or DMA resources.

The indication of a change in a peripheral is referred to as an event, and is usually the same as the interrupt conditions for that peripheral. Events are passed between peripherals using a dedicated routing network called the Event Routing Network. [Figure 9-1 on page 17](#) shows a basic block diagram of the Event System with the Event Routing Network and the peripherals to which it is connected. This highly flexible system can be used for simple routing of signals, pin functions or for sequencing of events.

The maximum latency is two CPU clock cycles from when an event is generated in one peripheral, until the actions are triggered in one or more other peripherals.

The Event System is functional in both Active and Idle modes.

Figure 9-1. Event System Block Diagram

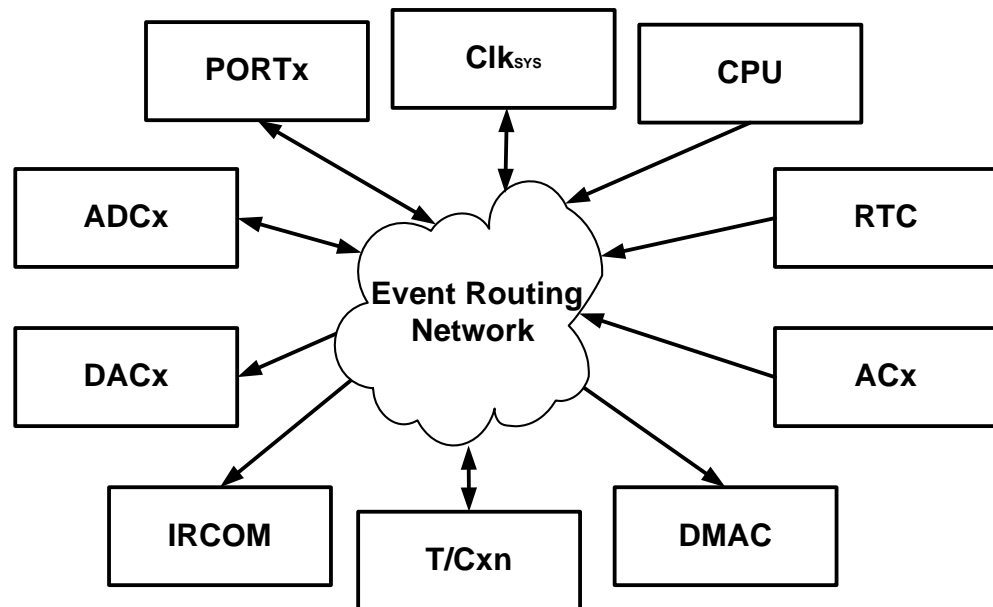

The Event Routing Network can directly connect together ADCs, DACs, Analog Comparators (ACx), I/O ports (PORTx), the Real-time Counter (RTC), Timer/Counters (T/C) and the IR Communication Module (IRCOM). Events can also be generated from software (CPU).

All events from all peripherals are always routed into the Event Routing Network. This consist of eight multiplexers where each can be configured in software to select which event to be routed into that event channel. All eight event channels are connected to the peripherals that can use events, and each of these peripherals can be configured to use events from one or more event channels to automatically trigger a software selectable action.

10. System Clock and Clock options

10.1 Features

- Fast start-up time
- Safe run-time clock switching
- Internal Oscillators:
 - 32 MHz run-time calibrated RC oscillator
 - 2 MHz run-time calibrated RC oscillator
 - 32.768 kHz calibrated RC oscillator
 - 32 kHz Ultra Low Power (ULP) oscillator with 1 kHz output
- External clock options
 - 0.4 - 16 MHz Crystal Oscillator
 - 32 kHz Crystal Oscillator
 - External clock
- PLL with internal and external clock options with 1 to 31x multiplication
- Clock Prescalers with 1 to 2048x division
- Fast peripheral clock running at 2 and 4 times the CPU clock speed
- Automatic Run-Time Calibration of internal oscillators
- Crystal Oscillator failure detection

10.2 Overview

XMEGA A4 has an advanced clock system, supporting a large number of clock sources. It incorporates both integrated oscillators, external crystal oscillators and resonators. A high frequency Phase Locked Loop (PLL) and clock prescalers can be controlled from software to generate a wide range of clock frequencies from the clock source input.

It is possible to switch between clock sources from software during run-time. After reset the device will always start up running from the 2 Mhz internal oscillator.

A calibration feature is available, and can be used for automatic run-time calibration of the internal 2 MHz and 32 MHz oscillators. This reduce frequency drift over voltage and temperature.

A Crystal Oscillator Failure Monitor can be enabled to issue a Non-Maskable Interrupt and switch to internal oscillator if the external oscillator fails. [Figure 10-1 on page 19](#) shows the principal clock system in XMEGA A4.

Figure 10-1. Clock system overview

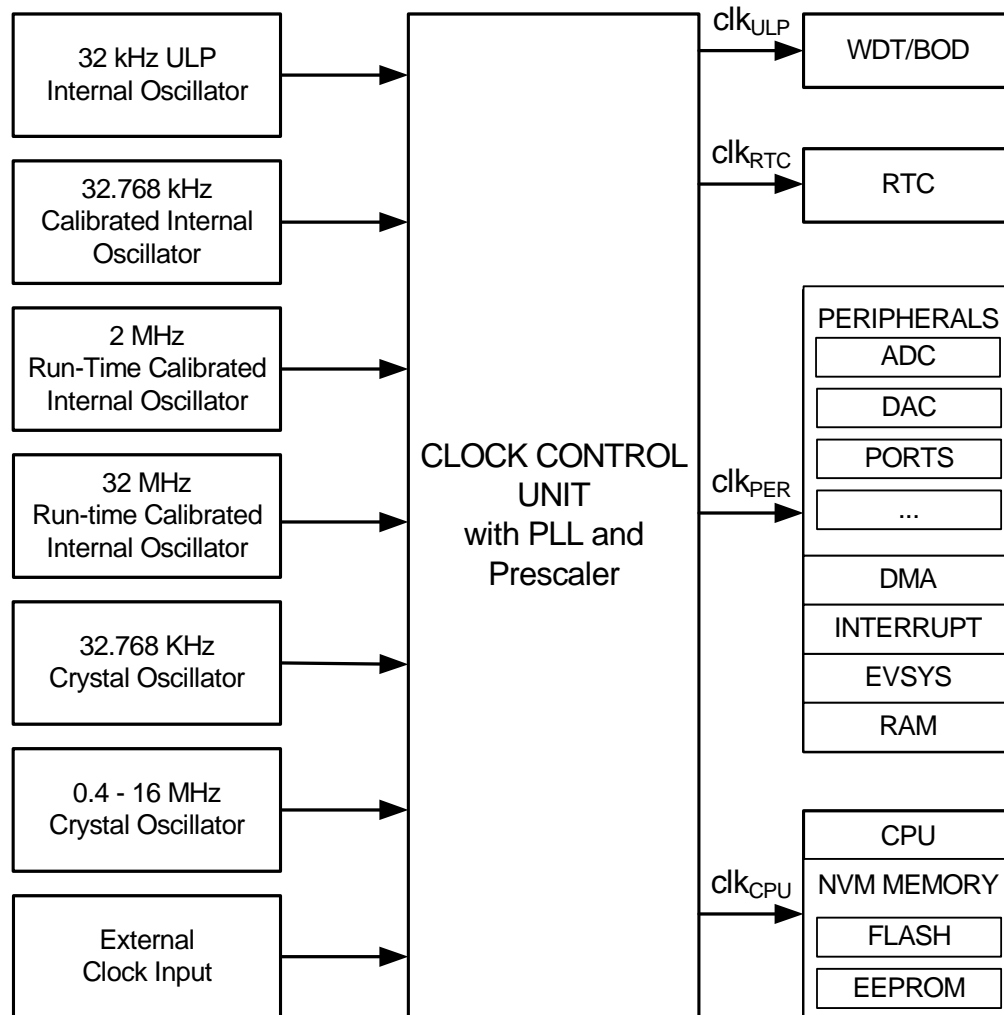

Each clock source is briefly described in the following sub-sections.

10.3 Clock Options

10.3.1 32 kHz Ultra Low Power Internal Oscillator

The 32 kHz Ultra Low Power (ULP) Internal Oscillator is a very low power consumption clock source. It is used for the Watchdog Timer, Brown-Out Detection and as an asynchronous clock source for the Real Time Counter. This oscillator cannot be used as the system clock source, and it cannot be directly controlled from software.

10.3.2 32.768 kHz Calibrated Internal Oscillator

The 32.768 kHz Calibrated Internal Oscillator is a high accuracy clock source that can be used as the system clock source or as an asynchronous clock source for the Real Time Counter. It is calibrated during production to provide a default frequency which is close to its nominal frequency.

10.3.3 32.768 kHz Crystal Oscillator

The 32.768 kHz Crystal Oscillator is a low power driver for an external watch crystal. It can be used as system clock source or as asynchronous clock source for the Real Time Counter.

10.3.4 0.4 - 16 MHz Crystal Oscillator

The 0.4 - 16 MHz Crystal Oscillator is a driver intended for driving both external resonators and crystals ranging from 400 kHz to 16 MHz.

10.3.5 2 MHz Run-time Calibrated Internal Oscillator

The 2 MHz Run-time Calibrated Internal Oscillator is a high frequency oscillator. It is calibrated during production to provide a default frequency which is close to its nominal frequency. The oscillator can use the 32 kHz Calibrated Internal Oscillator or the 32 kHz Crystal Oscillator as a source for calibrating the frequency run-time to compensate for temperature and voltage drift hereby optimizing the accuracy of the oscillator.

10.3.6 32 MHz Run-time Calibrated Internal Oscillator

The 32 MHz Run-time Calibrated Internal Oscillator is a high frequency oscillator. It is calibrated during production to provide a default frequency which is close to its nominal frequency. The oscillator can use the 32 kHz Calibrated Internal Oscillator or the 32 kHz Crystal Oscillator as a source for calibrating the frequency run-time to compensate for temperature and voltage drift hereby optimizing the accuracy of the oscillator.

10.3.7 External Clock input

The external clock input gives the possibility to connect a clock from an external source.

10.3.8 PLL with Multiplication factor 1 - 31x

The PLL provides the possibility of multiplying a frequency by any number from 1 to 31. In combination with the prescalers, this gives a wide range of output frequencies from all clock sources.

11. Power Management and Sleep Modes

11.1 Features

- 5 sleep modes
 - Idle
 - Power-down
 - Power-save
 - Standby
 - Extended standby
- Power Reduction registers to disable clocks to unused peripherals

11.2 Overview

The XMEGA A4 provides various sleep modes tailored to reduce power consumption to a minimum. All sleep modes are available and can be entered from Active mode. In Active mode the CPU is executing application code. The application code decides when and what sleep mode to enter. Interrupts from enabled peripherals and all enabled reset sources can restore the microcontroller from sleep to Active mode.

In addition, Power Reduction registers provide a method to stop the clock to individual peripherals from software. When this is done, the current state of the peripheral is frozen and there is no power consumption from that peripheral. This reduces the power consumption in Active mode and Idle sleep mode.

11.3 Sleep Modes

11.3.1 Idle Mode

In Idle mode the CPU and Non-Volatile Memory are stopped, but all peripherals including the Interrupt Controller, Event System and DMA Controller are kept running. Interrupt requests from all enabled interrupts will wake the device.

11.3.2 Power-down Mode

In Power-down mode all system clock sources, and the asynchronous Real Time Counter (RTC) clock source, are stopped. This allows operation of asynchronous modules only. The only interrupts that can wake up the MCU are the Two Wire Interface address match interrupts, and asynchronous port interrupts, e.g pin change.

11.3.3 Power-save Mode

Power-save mode is identical to Power-down, with one exception: If the RTC is enabled, it will keep running during sleep and the device can also wake up from RTC interrupts.

11.3.4 Standby Mode

Standby mode is identical to Power-down with the exception that all enabled system clock sources are kept running, while the CPU, Peripheral and RTC clocks are stopped. This reduces the wake-up time when external crystals or resonators are used.

11.3.5 Extended Standby Mode

Extended Standby mode is identical to Power-save mode with the exception that all enabled system clock sources are kept running while the CPU and Peripheral clocks are stopped. This reduces the wake-up time when external crystals or resonators are used.

12. System Control and Reset

12.1 Features

- **Multiple reset sources for safe operation and device reset**
 - Power-On Reset
 - External Reset
 - Watchdog Reset
 - The Watchdog Timer runs from separate, dedicated oscillator
 - Brown-Out Reset
 - Accurate, programmable Brown-Out levels
 - PDI reset
 - Software reset
- **Asynchronous reset**
 - No running clock in the device is required for reset
- **Reset status register**

12.2 Resetting the AVR

During reset, all I/O registers are set to their initial values. The SRAM content is not reset. Application execution starts from the Reset Vector. The instruction placed at the Reset Vector should be an Absolute Jump (JMP) instruction to the reset handling routine. By default the Reset Vector address is the lowest Flash program memory address, '0', but it is possible to move the Reset Vector to the first address in the Boot Section.

The I/O ports of the AVR are immediately tri-stated when a reset source goes active.

The reset functionality is asynchronous, so no running clock is required to reset the device.

After the device is reset, the reset source can be determined by the application by reading the Reset Status Register.

12.3 Reset Sources

12.3.1 Power-On Reset

The MCU is reset when the supply voltage VCC is below the Power-on Reset threshold voltage.

12.3.2 External Reset

The MCU is reset when a low level is present on the RESET pin.

12.3.3 Watchdog Reset

The MCU is reset when the Watchdog Timer period expires and the Watchdog Reset is enabled. The Watchdog Timer runs from a dedicated oscillator independent of the System Clock. For more details see ["WDT - Watchdog Timer" on page 24](#).

12.3.4 Brown-Out Reset

The MCU is reset when the supply voltage VCC is below the Brown-Out Reset threshold voltage and the Brown-out Detector is enabled. The Brown-out threshold voltage is programmable.

12.3.5 PDI reset

The MCU can be reset through the Program and Debug Interface (PDI).

12.3.6 Software reset

The MCU can be reset by the CPU writing to a special I/O register through a timed sequence.

13. WDT - Watchdog Timer

13.1 Features

- 11 selectable timeout periods, from 8 ms to 8s.
- Two operation modes
 - Standard mode
 - Window mode
- Runs from the 1 kHz output of the 32 kHz Ultra Low Power oscillator
- Configuration lock to prevent unwanted changes

13.2 Overview

The XMEGA A4 has a Watchdog Timer (WDT). The WDT will run continuously when turned on and if the Watchdog Timer is not reset within a software configurable time-out period, the microcontroller will be reset. The Watchdog Reset (WDR) instruction must be run by software to reset the WDT, and prevent microcontroller reset.

The WDT has a Window mode. In this mode the WDR instruction must be run within a specified period called a window. Application software can set the minimum and maximum limits for this window. If the WDR instruction is not executed inside the window limits, the microcontroller will be reset.

A protection mechanism using a timed write sequence is implemented in order to prevent unwanted enabling, disabling or change of WDT settings.

For maximum safety, the WDT also has an Always-on mode. This mode is enabled by programming a fuse. In Always-on mode, application software can not disable the WDT.

14. PMIC - Programmable Multi-level Interrupt Controller

14.1 Features

- Separate interrupt vector for each interrupt
- Short, predictable interrupt response time
- Programmable Multi-level Interrupt Controller
 - 3 programmable interrupt levels
 - Selectable priority scheme within low level interrupts (round-robin or fixed)
 - Non-Maskable Interrupts (NMI)
- Interrupt vectors can be moved to the start of the Boot Section

14.2 Overview

XMEGA A4 has a Programmable Multi-level Interrupt Controller (PMIC). All peripherals can define three different priority levels for interrupts; high, medium or low. Medium level interrupts may interrupt low level interrupt service routines. High level interrupts may interrupt both low- and medium level interrupt service routines. Low level interrupts have an optional round robin scheme to make sure all interrupts are serviced within a certain amount of time.

The built in oscillator failure detection mechanism can issue a Non-Maskable Interrupt (NMI).

14.3 Interrupt vectors

When an interrupt is serviced, the program counter will jump to the interrupt vector address. The interrupt vector is the sum of the peripheral's base interrupt address and the offset address for specific interrupts in each peripheral. The base addresses for the XMEGA A4 devices are shown in [Table 14-1](#). Offset addresses for each interrupt available in the peripheral are described for each peripheral in the XMEGA A manual. For peripherals or modules that have only one interrupt, the interrupt vector is shown in [Table 14-1](#). The program address is the word address.

Table 14-1. Reset and Interrupt Vectors

Program Address (Base Address)	Source	Interrupt Description
0x000	RESET	
0x002	OSCF_INT_vect	Crystal Oscillator Failure Interrupt vector (NMI)
0x004	PORTC_INT_base	Port C Interrupt base
0x008	PORTR_INT_base	Port R Interrupt base
0x00C	DMA_INT_base	DMA Controller Interrupt base
0x014	RTC_INT_base	Real Time Counter Interrupt base
0x018	TWIC_INT_base	Two-Wire Interface on Port C Interrupt base
0x01C	TCC0_INT_base	Timer/Counter 0 on port C Interrupt base
0x028	TCC1_INT_base	Timer/Counter 1 on port C Interrupt base
0x030	SPIC_INT_vect	SPI on port C Interrupt vector
0x032	USARTC0_INT_base	USART 0 on port C Interrupt base
0x038	USARTC1_INT_base	USART 1 on port C Interrupt base
0x03E	AES_INT_vect	AES Interrupt vector

Table 14-1. Reset and Interrupt Vectors (Continued)

Program Address (Base Address)	Source	Interrupt Description
0x040	NVM_INT_base	Non-Volatile Memory Interrupt base
0x044	PORTB_INT_base	Port B Interrupt base
0x056	PORTE_INT_base	Port E Interrupt base
0x05A	TWIE_INT_base	Two-Wire Interface on Port E Interrupt base
0x05E	TCE0_INT_base	Timer/Counter 0 on port E Interrupt base
0x06A	TCE1_INT_base	Timer/Counter 1 on port E Interrupt base
0x074	USARTE0_INT_base	USART 0 on port E Interrupt base
0x080	PORTD_INT_base	Port D Interrupt base
0x084	PORTA_INT_base	Port A Interrupt base
0x088	ACA_INT_base	Analog Comparator on Port A Interrupt base
0x08E	ADCA_INT_base	Analog to Digital Converter on Port A Interrupt base
0x09A	TCD0_INT_base	Timer/Counter 0 on port D Interrupt base
0x0A6	TCD1_INT_base	Timer/Counter 1 on port D Interrupt base
0x0AE	SPID_INT_vector	SPI on port D Interrupt vector
0x0B0	USARTD0_INT_base	USART 0 on port D Interrupt base
0x0B6	USARTD1_INT_base	USART 1 on port D Interrupt base

15. I/O Ports

15.1 Features

- Selectable input and output configuration for each pin individually
- Flexible pin configuration through dedicated Pin Configuration Register
- Synchronous and/or asynchronous input sensing with port interrupts and events
 - Sense both edges
 - Sense rising edges
 - Sense falling edges
 - Sense low level
- Asynchronous wake-up from all input sensing configurations
- Two port interrupts with flexible pin masking
- Highly configurable output driver and pull settings:
 - Totem-pole
 - Pull-up/-down
 - Wired-AND
 - Wired-OR
 - Bus-keeper
 - Inverted I/O
- Optional Slew rate control
- Configuration of multiple pins in a single operation
- Read-Modify-Write (RMW) support
- Toggle/clear/set registers for Output and Direction registers
- Clock output on port pin
- Event Channel 0 output on port pin 7
- Mapping of port registers (virtual ports) into bit accessible I/O memory space

15.2 Overview

The XMEGA A4 devices have flexible General Purpose I/O Ports. A port consists of up to 8 pins, ranging from pin 0 to pin 7. The ports implement several functions, including synchronous/asynchronous input sensing, pin change interrupts and configurable output settings. All functions are individual per pin, but several pins may be configured in a single operation.

15.3 I/O configuration

All port pins (P_n) have programmable output configuration. In addition, all port pins have an inverted I/O function. For an input, this means inverting the signal between the port pin and the pin register. For an output, this means inverting the output signal between the port register and the port pin. The inverted I/O function can be used also when the pin is used for alternate functions.

15.3.1 Push-pull

Figure 15-1. I/O configuration - Totem-pole

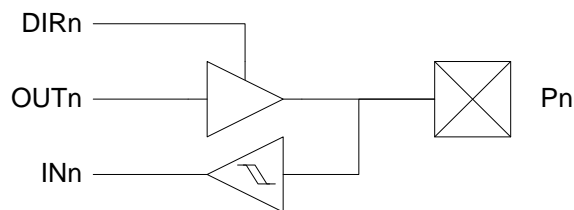

15.3.2 Pull-down

Figure 15-2. I/O configuration - Totem-pole with pull-down (on input)

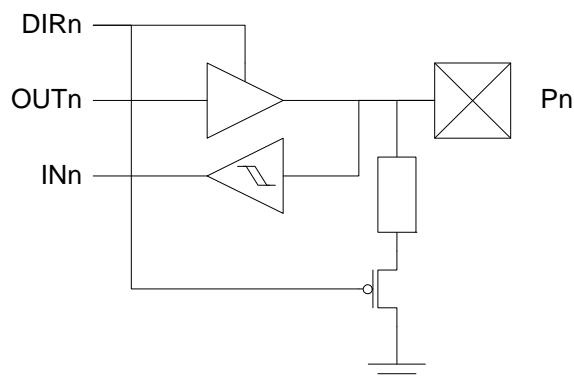

15.3.3 Pull-up

Figure 15-3. I/O configuration - Totem-pole with pull-up (on input)

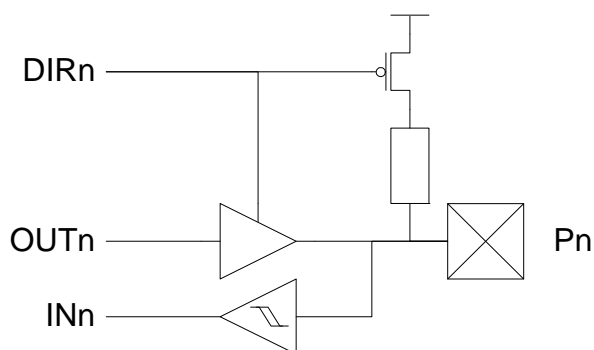

15.3.4 Bus-keeper

The bus-keeper's weak output produces the same logical level as the last output level. It acts as a pull-up if the last level was '1', and pull-down if the last level was '0'.

Figure 15-4. I/O configuration - Totem-pole with bus-keeper

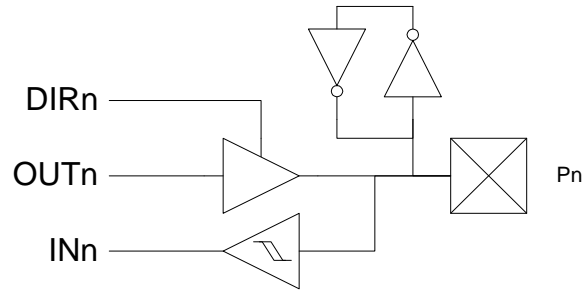

15.3.5 Others

Figure 15-5. Output configuration - Wired-OR with optional pull-down

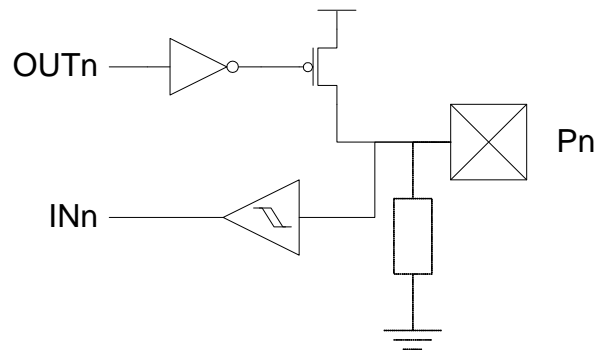
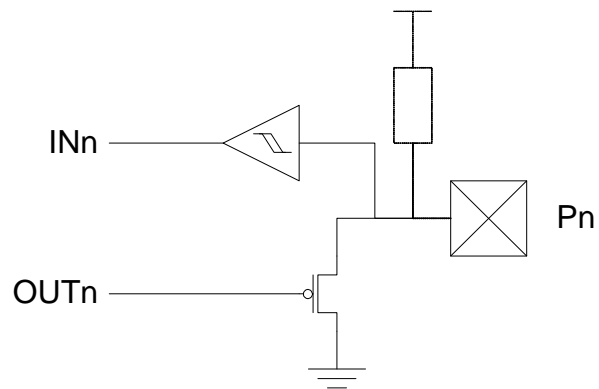

Figure 15-6. I/O configuration - Wired-AND with optional pull-up



15.4 Input sensing

- Sense both edges
- Sense rising edges
- Sense falling edges
- Sense low level

Input sensing is synchronous or asynchronous depending on the enabled clock for the ports, and the configuration is shown in [Figure 15-7 on page 30](#).

Figure 15-7. Input sensing system overview

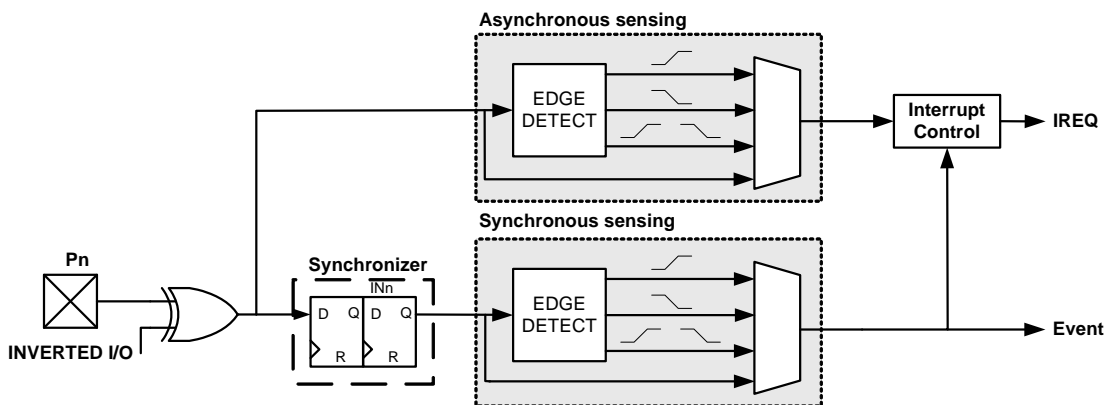

When a pin is configured with inverted I/O, the pin value is inverted before the input sensing.

15.5 Port Interrupt

Each port has two interrupts with separate priority and interrupt vector. All pins on the port can be individually selected as source for each of the interrupts. The interrupts are then triggered according to the input sense configuration for each pin configured as source for the interrupt.

15.6 Alternate Port Functions

In addition to the input/output functions on all port pins, most pins have alternate functions. This means that other modules or peripherals connected to the port can use the port pins for their functions, such as communication or pulse-width modulation. ["Pinout and Pin Functions" on page 49](#) shows which modules on peripherals that enable alternate functions on a pin, and which alternate function is available on a pin.

16. T/C - 16-bit Timer/Counter

16.1 Features

- **Five 16-bit Timer/Counters**
 - Three Timer/Counters of type 0
 - Two Timer/Counters of type 1
- **Three Compare or Capture (CC) Channels in Timer/Counter 0**
- **Two Compare or Capture (CC) Channels in Timer/Counter 1**
- **Double Buffered Timer Period Setting**
- **Double Buffered Compare or Capture Channels**
- **Waveform Generation:**
 - Single Slope Pulse Width Modulation
 - Dual Slope Pulse Width Modulation
 - Frequency Generation
- **Input Capture:**
 - Input Capture with Noise Cancelling
 - Frequency capture
 - Pulse width capture
 - 32-bit input capture
- **Event Counter with Direction Control**
- **Timer Overflow and Timer Error Interrupts and Events**
- **One Compare Match or Capture Interrupt and Event per CC Channel**
- **Supports DMA Operation**
- **Hi-Resolution Extension (Hi-Res)**
- **Advanced Waveform Extension (AWEX)**

16.2 Overview

XMEGA A4 has five Timer/Counters, three Timer/Counter 0 and two Timer/Counter 1. The difference between them is that Timer/Counter 0 has four Compare/Capture channels, while Timer/Counter 1 has two Compare/Capture channels.

The Timer/Counters (T/C) are 16-bit and can count any clock, event or external input in the microcontroller. A programmable prescaler is available to get a useful T/C resolution. Updates of Timer and Compare registers are double buffered to ensure glitch free operation. Single slope PWM, dual slope PWM and frequency generation waveforms can be generated using the Compare Channels.

Through the Event System, any input pin or event in the microcontroller can be used to trigger input capture, hence no dedicated pins are required for this. The input capture has a noise canceller to avoid incorrect capture of the T/C, and can be used to do frequency and pulse width measurements.

A wide range of interrupt or event sources are available, including T/C Overflow, Compare match and Capture for each Compare/Capture channel in the T/C.

PORTC and PORTD each has one Timer/Counter 0 and one Timer/Counter1. PORTE has one Timer/Counter0. Notation of these are TCC0 (Time/Counter C0), TCC1, TCD0, TCD1 and TCE0, respectively.

Figure 16-1. Overview of a Timer/Counter and closely related peripherals

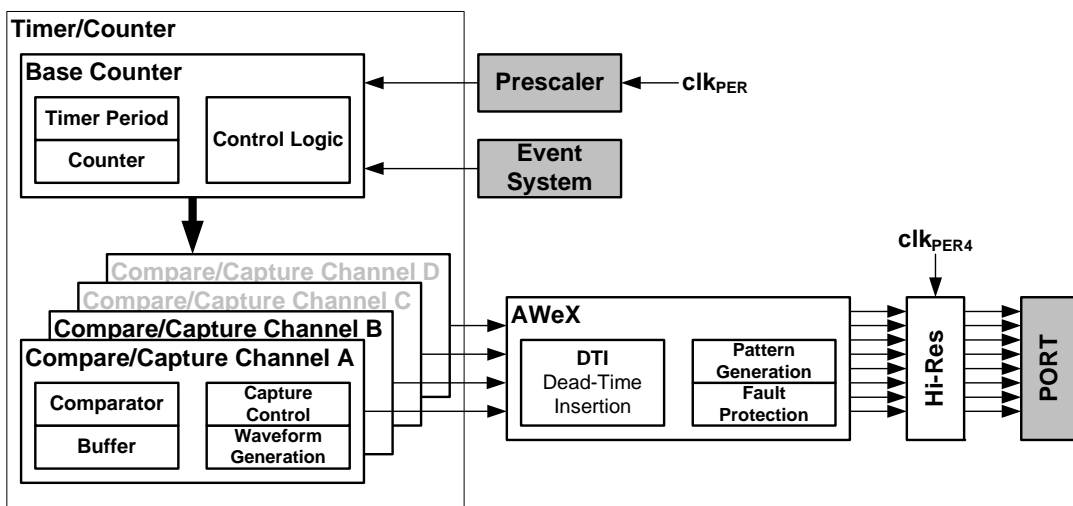

The Hi-Resolution Extension can be enabled to increase the waveform generation resolution by 2 bits (4x). This is available for all Timer/Counters. See ["Hi-Res - High Resolution Extension"](#) on page 34 for more details.

The Advanced Waveform Extension can be enabled to provide extra and more advanced feature for the Timer/Counter. This is only available for Timer/Counter 0. See ["AWEX - Advanced Waveform Extension"](#) on page 33 for more details.

17. AWEX - Advanced Waveform Extension

17.1 Features

- Output with complementary output from each Capture channel
- Four Dead Time Insertion (DTI) Units, one for each Capture channel
- 8-bit DTI Resolution
- Separate High and Low Side Dead-Time Setting
- Double Buffered Dead-Time
- Event Controlled Fault Protection
- Single Channel Multiple Output Operation (for BLDC motor control)
- Double Buffered Pattern Generation

17.2 Overview

The Advanced Waveform Extension (AWEX) provides extra features to the Timer/Counter in Waveform Generation (WG) modes. The AWEX enables easy and safe implementation of for example, advanced motor control (AC, BLDC, SR, and Stepper) and power control applications.

Any WG output from a Timer/Counter 0 is split into a complimentary pair of outputs when any AWEX feature is enabled. These output pairs go through a Dead-Time Insertion (DTI) unit that enables generation of the non-inverted Low Side (LS) and inverted High Side (HS) of the WG output with dead time insertion between LS and HS switching. The DTI output will override the normal port value according to the port override setting. Optionally the final output can be inverted by using the invert I/O setting for the port pin.

The Pattern Generation unit can be used to generate a synchronized bit pattern on the port it is connected to. In addition, the waveform generator output from Compare Channel A can be distributed to, and override all port pins. When the Pattern Generator unit is enabled, the DTI unit is bypassed.

The Fault Protection unit is connected to the Event System. This enables any event to trigger a fault condition that will disable the AWEX output. Several event channels can be used to trigger fault on several different conditions.

The AWEX is available for TCC0. The notation of this is AWEXC.

18. Hi-Res - High Resolution Extension

18.1 Features

- Increases Waveform Generator resolution by 2-bits (4x)
- Supports Frequency, single- and dual-slope PWM operation
- Supports the AWEX when this is enabled and used for the same Timer/Counter

18.2 Overview

The Hi-Resolution (Hi-Res) Extension is able to increase the resolution of the waveform generation output by a factor of 4. When enabled for a Timer/Counter, the Fast Peripheral clock running at four times the CPU clock speed will be as input to the Timer/Counter.

The High Resolution Extension can also be used when an AWEX is enabled and used with a Timer/Counter.

XMEGA A4 devices have three Hi-Res Extensions that each can be enabled for each Timer/Counter pair on PORTC, PORTD and PORTE. The notation of these are HIRESC, HIRESD and HIRESE, respectively.

19. RTC - 16-bit Real-Time Counter

19.1 Features

- 16-bit Timer
- Flexible Tick resolution ranging from 1 Hz to 32.768 kHz
- One Compare register
- One Period register
- Clear timer on Overflow or Compare Match
- Overflow or Compare Match event and interrupt generation

19.2 Overview

The XMEGA A4 includes a 16-bit Real-time Counter (RTC). The RTC can be clocked from an accurate 32.768 kHz Crystal Oscillator, the 32.768 kHz Calibrated Internal Oscillator, or from the 32 kHz Ultra Low Power Internal Oscillator. The RTC includes both a Period and a Compare register. For details, see [Figure 19-1](#).

A wide range of Resolution and Time-out periods can be configured using the RTC. With a maximum resolution of 30.5 μ s, time-out periods range up to 2000 seconds. With a resolution of 1 second, the maximum time-out period is over 18 hours (65536 seconds).

Figure 19-1. Real Time Counter overview

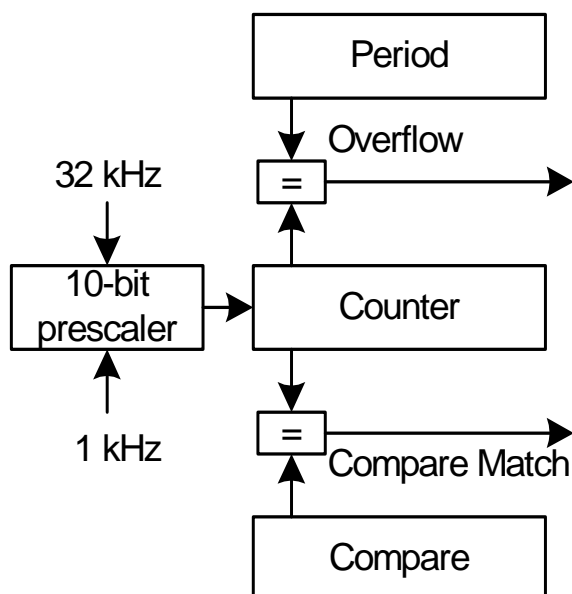

20. TWI - Two-Wire Interface

20.1 Features

- Two Identical TWI peripherals
- Simple yet Powerful and Flexible Communication Interface
- Both Master and Slave Operation Supported
- Device can Operate as Transmitter or Receiver
- 7-bit Address Space Allows up to 128 Different Slave Addresses
- Multi-master Arbitration Support
- Up to 400 kHz Data Transfer Speed
- Slew-rate Limited Output Drivers
- Noise Suppression Circuitry Rejects Spikes on Bus Lines
- Fully Programmable Slave Address with General Call Support
- Address Recognition Causes Wake-up when in Sleep Mode
- I²C and System Management Bus (SMBus) compatible

20.2 Overview

The Two-Wire Interface (TWI) is a bi-directional wired-AND bus with only two lines, the clock (SCL) line and the data (SDA) line. The protocol makes it possible to interconnect up to 128 individually addressable devices. Since it is a multi-master bus, one or more devices capable of taking control of the bus can be connected.

The only external hardware needed to implement the bus is a single pull-up resistor for each of the TWI bus lines. Mechanisms for resolving bus contention are inherent in the TWI protocol.

PORTC and PORTE each has one TWI. Notation of these peripherals are TWIC and TWIE, respectively.

21. SPI - Serial Peripheral Interface

21.1 Features

- Two Identical SPI peripherals
- Full-duplex, Three-wire Synchronous Data Transfer
- Master or Slave Operation
- LSB First or MSB First Data Transfer
- Seven Programmable Bit Rates
- End of Transmission Interrupt Flag
- Write Collision Flag Protection
- Wake-up from Idle Mode
- Double Speed (CK/2) Master SPI Mode

21.2 Overview

The Serial Peripheral Interface (SPI) allows high-speed full-duplex, synchronous data transfer between different devices. Devices can communicate using a master-slave scheme, and data is transferred both to and from the devices simultaneously.

PORTC and PORTD each has one SPI. Notation of these peripherals are SPIC and SPID, respectively.

22. USART

22.1 Features

- Five Identical USART peripherals
- Full Duplex Operation (Independent Serial Receive and Transmit Registers)
- Asynchronous or Synchronous Operation
- Master or Slave Clocked Synchronous Operation
- High-resolution Arithmetic Baud Rate Generator
- Supports Serial Frames with 5, 6, 7, 8, or 9 Data Bits and 1 or 2 Stop Bits
- Odd or Even Parity Generation and Parity Check Supported by Hardware
- Data OverRun Detection
- Framing Error Detection
- Noise Filtering Includes False Start Bit Detection and Digital Low Pass Filter
- Three Separate Interrupts on TX Complete, TX Data Register Empty and RX Complete
- Multi-processor Communication Mode
- Double Speed Asynchronous Communication Mode
- Master SPI mode for SPI communication
- IrDA support through the IRCOM module

22.2 Overview

The Universal Synchronous and Asynchronous serial Receiver and Transmitter (USART) is a highly flexible serial communication module. The USART supports full duplex communication, and both asynchronous and clocked synchronous operation. The USART can also be set in Master SPI mode to be used for SPI communication.

Communication is frame based, and the frame format can be customized to support a wide range of standards. The USART is buffered in both direction, enabling continued data transmission without any delay between frames. There are separate interrupt vectors for receive and transmit complete, enabling fully interrupt driven communication. Frame error and buffer overflow are detected in hardware and indicated with separate status flags. Even or odd parity generation and parity check can also be enabled.

One USART can use the IRCOM module to support IrDA 1.4 physical compliant pulse modulation and demodulation for baud rates up to 115.2 kbps.

PORTC and PORTD each has two USARTs. PORTE has one USART. Notation of these peripherals are USARTC0, USARTC1, USARTE0, USARTE1, USARTD0, USARTD1 and USARTE0, respectively.

23. IRCOM - IR Communication Module

23.1 Features

- Pulse modulation/demodulation for infrared communication
- Compatible to IrDA 1.4 physical for baud rates up to 115.2 kbps
- Selectable pulse modulation scheme
 - 3/16 of baud rate period
 - Fixed pulse period, 8-bit programmable
 - Pulse modulation disabled
- Built in filtering
- Can be connected to and used by one USART at a time

23.2 Overview

XMEGA contains an Infrared Communication Module (IRCOM) for IrDA communication with baud rates up to 115.2 kbps. This supports three modulation schemes: 3/16 of baud rate period, fixed programmable pulse time based on the Peripheral Clock speed, or pulse modulation disabled. There is one IRCOM available which can be connected to any USART to enable infrared pulse coding/decoding for that USART.

24. Crypto Engine

24.1 Features

- Data Encryption Standard (DES) CPU instruction
- Advanced Encryption Standard (AES) Crypto module
- DES Instruction
 - Encryption and Decryption
 - Single-cycle DES instruction
 - Encryption/Decryption in 16 clock cycles per 8-byte block
- AES Crypto Module
 - Encryption and Decryption
 - Support 128-bit keys
 - Support XOR data load mode to the State memory for Cipher Block Chaining
 - Encryption/Decryption in 375 clock cycles per 16-byte block

24.2 Overview

The Advanced Encryption Standard (AES) and Data Encryption Standard (DES) are two commonly used encryption standards. These are supported through an AES peripheral module and a DES CPU instruction. All communication interfaces and the CPU can optionally use AES and DES encrypted communication and data storage.

DES is supported by a DES instruction in the AVR XMEGA CPU. The 8-byte key and 8-byte data blocks must be loaded into the Register file, and then DES must be executed 16 times to encrypt/decrypt the data block.

The AES Crypto Module encrypts and decrypts 128-bit data blocks with the use of a 128-bit key. The key and data must be loaded into the key and state memory in the module before encryption/decryption is started. It takes 375 peripheral clock cycles before the encryption/decryption is done and decrypted/encrypted data can be read out, and an optional interrupt can be generated. The AES Crypto Module also has DMA support with transfer triggers when encryption/decryption is done and optional auto-start of encryption/decryption when the state memory is fully loaded.

25. ADC - 12-bit Analog to Digital Converter

25.1 Features

- One ADC with 12-bit resolution
- 2 Msps sample rate
- Signed and Unsigned conversions
- 4 result registers with individual input channel control
- 12 single ended inputs
- 8x4 differential inputs
- 4 internal inputs:
 - Integrated Temperature Sensor
 - DAC Output
 - VCC voltage divided by 10
 - Bandgap voltage
- Software selectable gain of 2, 4, 8, 16, 32 or 64
- Selectable accuracy of 8- or 12-bit.
- Internal or External Reference selection
- Event triggered conversion for accurate timing
- DMA transfer of conversion results
- Interrupt/Event on compare result

25.2 Overview

XMEGA A4 devices have one Analog to Digital Converter (ADC), see [Figure 25-1 on page 42](#).

The ADC converts analog voltages to digital values. The ADC has 12-bit resolution and is capable of converting up to 2 million samples per second. The input selection is flexible, and both single-ended and differential measurements can be done. For differential measurements an optional gain stage is available to increase the dynamic range. In addition several internal signal inputs are available. The ADC can provide both signed and unsigned results.

This is a pipeline ADC. A pipeline ADC consists of several consecutive stages, where each stage convert one part of the result. The pipeline design enables high sample rate at low clock speeds, and remove limitations on samples speed versus propagation delay. This also means that a new analog voltage can be sampled and a new ADC measurement started while other ADC measurements are ongoing.

ADC measurements can either be started by application software or an incoming event from another peripheral in the device. Four different result registers with individual input selection (MUX selection) are provided to make it easier for the application to keep track of the data. Each result register and MUX selection pair is referred to as an ADC Channel. It is possible to use DMA to move ADC results directly to memory or peripherals when conversions are done.

Both internal and external analog reference voltages can be used. An accurate internal 1.0V reference is available.

An integrated temperature sensor is available and the output from this can be measured with the ADC. The output from the DAC, VCC/10 and the Bandgap voltage can also be measured by the ADC.

Figure 25-1. ADC overview

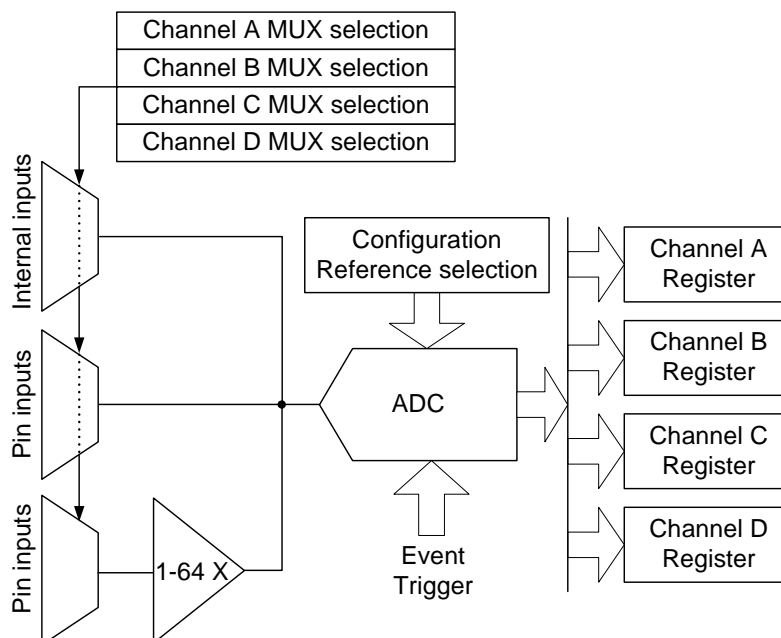

Each ADC has four MUX selection registers with a corresponding result register. This means that four channels can be sampled within 1.5 μ s without any intervention by the application other than starting the conversion. The results will be available in the result registers.

The ADC may be configured for 8- or 12-bit resolution, reducing the minimum conversion time (propagation delay) from 3.5 μ s for 12-bit to 2.5 μ s for 8-bit resolution.

ADC conversion results are provided left- or right adjusted with optional '1' or '0' padding. This eases calculation when the result is represented as a signed integer (signed 16-bit number).

PORTA has one ADC. Notation of this peripheral is ADCA.

26. DAC - 12-bit Digital to Analog Converter

26.1 Features

- One DAC with 12-bit resolution
- Up to 1 Msps conversion rate
- Flexible conversion range
- Multiple trigger sources
- 1 continuous output or 2 Sample and Hold (S/H) outputs
- Built-in offset and gain calibration
- High drive capabilities
- Low Power Mode

26.2 Overview

The XMEGA A4 devices feature one 12-bit, 1 Msps DAC with built-in offset and gain calibration, see [Figure 26-1 on page 43](#).

A DAC converts a digital value into an analog signal. The DAC may use an internal 1.0 voltage as the upper limit for conversion, but it is also possible to use the supply voltage or any applied voltage in-between. The external reference input is shared with the ADC reference input.

Figure 26-1. DAC overview



The DAC has one continuous output with high drive capabilities for both resistive and capacitive loads. It is also possible to split the continuous time channel into two Sample and Hold (S/H) channels, each with separate data conversion registers.

A DAC conversion may be started from the application software by writing the data conversion registers. The DAC can also be configured to do conversions triggered by the Event System to have regular timing, independent of the application software. DMA may be used for transferring data from memory locations to DAC data registers.

The DAC has a built-in calibration system to reduce offset and gain error when loading with a calibration value from software.

PORTB has one DAC. Notation of this peripheral is DACB.

27. AC - Analog Comparator

27.1 Features

- **Two Analog Comparators**
- **Selectable Power vs. Speed**
- **Selectable hysteresis**
 - 0, 20 mV, 50 mV
- **Analog Comparator output available on pin**
- **Flexible Input Selection**
 - All pins on the port
 - Output from the DAC
 - Bandgap reference voltage.
 - Voltage scaler that can perform a 64-level scaling of the internal VCC voltage.
- **Interrupt and event generation on**
 - Rising edge
 - Falling edge
 - Toggle
- **Window function interrupt and event generation on**
 - Signal above window
 - Signal inside window
 - Signal below window

27.2 Overview

XMEGA A4 features two Analog Comparators (AC). An Analog Comparator compares two voltages, and the output indicates which input is largest. The Analog Comparator may be configured to give interrupt requests and/or events upon several different combinations of input change.

Both hysteresis and propagation delays may be adjusted in order to find the optimal operation for each application.

A wide range of input selection is available, both external pins and several internal signals can be used.

The Analog Comparators are always grouped in pairs (AC0 and AC1) on each analog port. They have identical behavior but separate control registers.

Optionally, the state of the comparator is directly available on a pin.

PORTA has one AC pair. Notation of this peripheral is ACA.

Figure 27-1. Analog comparator overview

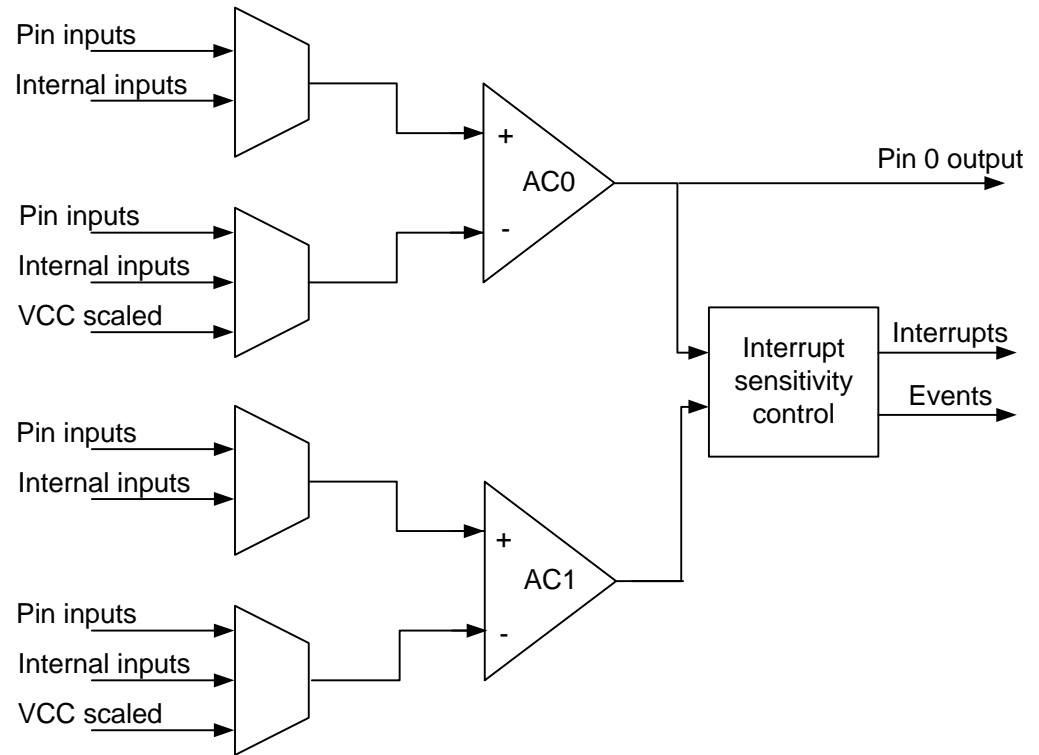

27.3 Input Selection

The Analog comparators have a very flexible input selection and the two comparators grouped in a pair may be used to realize a window function. One pair of analog comparators is shown in [Figure 27-1 on page 45](#).

- **Input selection from pin**
 - Pin 0, 1, 2, 3, 4, 5, 6 selectable to positive input of analog comparator
 - Pin 0, 1, 3, 5, 7 selectable to negative input of analog comparator
- **Internal signals available on positive analog comparator inputs**
 - Output from 12-bit DAC
- **Internal signals available on negative analog comparator inputs**
 - 64-level scaler of the VCC, available on negative analog comparator input
 - Bandgap voltage reference
 - Output from 12-bit DAC

27.4 Window Function

The window function is realized by connecting the external inputs of the two analog comparators in a pair as shown in [Figure 27-2](#).

Figure 27-2. Analog comparator window function

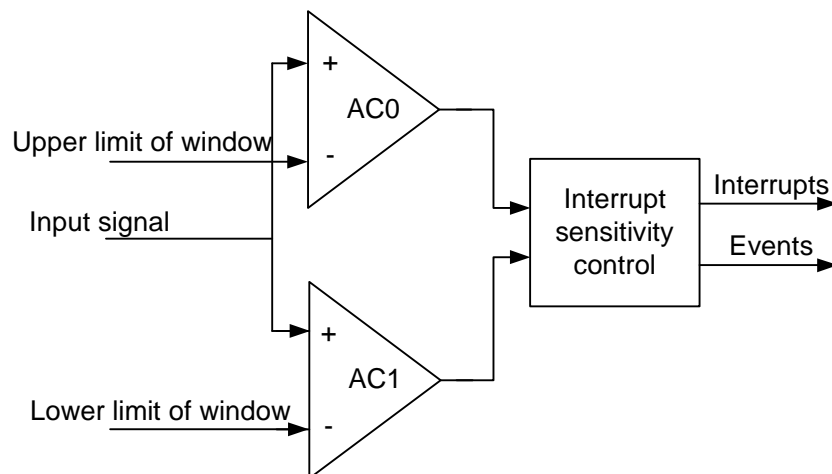

28. OCD - On-chip Debug

28.1 Features

- Complete Program Flow Control
 - Go, Stop, Reset, Step into, Step over, Step out, Run-to-Cursor
- Debugging on C and high-level language source code level
- Debugging on Assembler and disassembler level
- 1 dedicated program address or source level breakpoint for AVR Studio / debugger
- 4 Hardware Breakpoints
- Unlimited Number of User Program Breakpoints
- Unlimited Number of User Data Breakpoints, with break on:
 - Data location read, write or both read and write
 - Data location content equal or not equal to a value
 - Data location content is greater or less than a value
 - Data location content is within or outside a range
 - Bits of a data location are equal or not equal to a value
- Non-Intrusive Operation
 - No hardware or software resources in the device are used
- High Speed Operation
 - No limitation on debug/programming clock frequency versus system clock frequency

28.2 Overview

The XMEGA A4 has a powerful On-Chip Debug (OCD) system that - in combination with Atmel's development tools - provides all the necessary functions to debug an application. It has support for program and data breakpoints, and can debug an application from C and high level language source code level, as well as assembler and disassembler level. It has full Non-Intrusive Operation and no hardware or software resources in the device are used. The ODC system is accessed through an external debugging tool which connects to the PDI physical interface. Refer to "[Program and Debug Interfaces](#)" on page 48.

29. Program and Debug Interfaces

29.1 Features

- **PDI - Program and Debug Interface (Atmel proprietary 2-pin interface)**
- **Access to the OCD system**
- **Programming of Flash, EEPROM, Fuses and Lock Bits**

29.2 Overview

The programming and debug facilities are accessed through PDI physical interface. The PDI physical interface uses one dedicated pin together with the Reset pin, and no general purpose pins are used.

29.3 PDI - Program and Debug Interface

The PDI is an Atmel proprietary protocol for communication between the microcontroller and Atmel's development tools.

30. Pinout and Pin Functions

The pinout of XMEGA A4 is shown in "Pinout/Block Diagram" on page 3. In addition to general I/O functionality, each pin may have several functions. This will depend on which peripheral is enabled and connected to the actual pin. Only one of the alternate pin functions can be used at time.

30.1 Alternate Pin Functions Description

The tables below shows the notation for all pin functions available and describe their functions.

30.1.1 Operation/Power Supply

VCC	Digital supply voltage
AVCC	Analog supply voltage
GND	Ground

30.1.2 Port Interrupt functions

SYNC	Port pin with full synchronous and limited asynchronous interrupt function
ASYNC	Port pin with full synchronous and full asynchronous interrupt function

30.1.3 Analog functions

ACn	Analog Comparator input pin n
AC0OUT	Analog Comparator 0 Output
ADCn	Analog to Digital Converter input pin n
DACn	Digital to Analog Converter output pin n
AREF	Analog Reference input pin

30.1.4 Timer/Counter and AWEX functions

OCnx	Output Compare Channel x for Timer/Counter n
$\overline{\text{OCnx}}$	Inverted Output Compare Channel x for Timer/Counter n
OCnxLS	Output Compare Channel x Low Side for Timer/Counter n
OCnxHS	Output Compare Channel x High Side for Timer/Counter n

30.1.5 Communication functions

SCL	Serial Clock for TWI
SDA	Serial Data for TWI
XCKn	Transfer Clock for USART n
RXDn	Receiver Data for USART n
TXDn	Transmitter Data for USART n
\overline{SS}	Slave Select for SPI
MOSI	Master Out Slave In for SPI
MISO	Master In Slave Out for SPI
SCK	Serial Clock for SPI

30.1.6 Oscillators, Clock and Event

TOSCn	Timer Oscillator pin n
XTALn	Input/Output for inverting Oscillator pin n

30.1.7 Debug/System functions

\overline{RESET}	Reset pin
PDI_CLK	Program and Debug Interface Clock pin
PDI_DATA	Program and Debug Interface Data pin

30.2 Alternate Pin Functions

The tables below shows the main and alternate pin functions for all pins on each port. It also shows which peripheral which make use of or enable the alternate pin function.

Table 30-1. Port A - Alternate functions

PORTA	PIN #	INTERRUPT	ADCA POS	ADCA NEG	ADCA GAINPOS	ADCA GAINNEG	ACA POS	ACA NEG	ACA OUT	REF
GND	38									
AVCC	39									
PA0	40	SYNC	ADC0	ADC0	ADC0		AC0	AC0		AREF
PA1	41	SYNC	ADC1	ADC1	ADC1		AC1	AC1		
PA2	42	SYNC/ASYNC	ADC2	ADC2	ADC2		AC2			
PA3	43	SYNC	ADC3	ADC3	ADC3		AC3	AC3		
PA4	44	SYNC	ADC4		ADC4	ADC4	AC4			
PA5	1	SYNC	ADC5		ADC5	ADC5	AC5	AC5		
PA6	2	SYNC	ADC6		ADC6	ADC6	AC6			
PA7	3	SYNC	ADC7		ADC7	ADC7		AC7	AC0 OUT	

Table 30-2. Port B - Alternate functions

PORTB	PIN #	INTERRUPT	ADCA POS	DACB	REF
PB0	4	SYNC	ADC8		AREF
PB1	5	SYNC	ADC9		
PB2	6	SYNC/ASYNC	ADC10	DAC0	
PB3	7	SYNC	ADC11	DAC1	

Table 30-3. Port C - Alternate functions

PORTC	PIN #	INTERRUPT	TCC0	AWEXC	TCC1	USARTC0	USARTC1	SPI	TWIC	CLOCKOUT	EVENTOUT
GND	8										
VCC	9										
PC0	10	SYNC	OC0A	OC0ALS					SDA		
PC1	11	SYNC	OC0B	OC0AHS		XCK0			SCL		
PC2	12	SYNC/ASYNC	OC0C	OC0BLS		RXD0					
PC3	13	SYNC	OC0D	OC0BHS		TXD0					
PC4	14	SYNC		OC0CLS	OC1A			SS			
PC5	15	SYNC		OC0CHS	OC1B		XCK1	MOSI			
PC6	16	SYNC		OC0DLS			RXD1	MISO			
PC7	17	SYNC		OC0DHS			TXD1	SCK		CLKOUT	EVOUT

Table 30-4. Port D - Alternate functions

PORTD	PIN #	INTERRUPT	TCD0	TCD1	USARTD0	USARTD1	SPID	CLOCKOUT	EVENTOUT
GND	18								
VCC	19								
PD0	20	SYNC	OC0A						
PD1	21	SYNC	OC0B		XCK0				
PD2	22	SYNC/ASYNC	OC0C		RXD0				
PD3	23	SYNC	OC0D		TXD0				
PD4	24	SYNC		OC1A			\overline{SS}		
PD5	25	SYNC		OC1B		XCK1	MOSI		
PD6	26	SYNC				RXD1	MISO		
PD7	27	SYNC				TXD1	SCK	CLKOUT	EVOUT

Table 30-5. Port E - Alternate functions

PORT E	PIN #	INTERRUPT	TCE0	USARTE0	TWIE
PE0	28	SYNC	OC0A		SDA
PE1	29	SYNC	OC0B	XCK0	SCL
GND	30				
VCC	31				
PE2	32	SYNC/ASYNC	OC0C	RXD0	
PE3	33	SYNC	OC0D	TXD0	

Table 30-6. Port R - Alternate functions

PORTR	PIN #	XTAL	PDI	TOSC
PDI	34		PDI_DATA	
\overline{RESET}	35		PDI_CLK	
PR0	36	XTAL2		TOSC2
PR1	37	XTAL1		TOSC1

31. Peripheral Module Address Map

The address maps show the base address for each peripheral and module in XMEGA A4. For complete register description and summary for each peripheral module, refer to the XMEGA A Manual.

Base Address	Name	Description
0x0000	GPIO	General Purpose IO Registers
0x0010	VPOR0	Virtual Port 0
0x0014	VPOR1	Virtual Port 1
0x0018	VPOR2	Virtual Port 2
0x001C	VPOR3	Virtual Port 2
0x0030	CPU	CPU
0x0040	CLK	Clock Control
0x0048	SLEEP	Sleep Controller
0x0050	OSC	Oscillator Control
0x0060	DFLLRC32M	DFLL for the 32 MHz Internal RC Oscillator
0x0068	DFLLRC2M	DFLL for the 2 MHz RC Oscillator
0x0070	PR	Power Reduction
0x0078	RST	Reset Controller
0x0080	WDT	Watch-Dog Timer
0x0090	MCU	MCU Control
0x00A0	PMIC	Programmable MULTilevel Interrupt Controller
0x00B0	PORTCFG	Port Configuration
0x00C0	AES	AES Module
0x0100	DMA	DMA Controller
0x0180	EVSYS	Event System
0x01C0	NVM	Non Volatile Memory (NVM) Controller
0x0200	ADCA	Analog to Digital Converter on port A
0x0320	DACB	Digital to Analog Converter on port B
0x0380	ACA	Analog Comparator pair on port A
0x0400	RTC	Real Time Counter
0x0480	TWIC	Two Wire Interface on port C
0x04A0	TWIE	Two Wire Interface on port E
0x0600	PORTA	Port A
0x0620	PORTB	Port B
0x0640	PORTC	Port C
0x0660	PORTD	Port D
0x0680	PORTE	Port E
0x07E0	PORTR	Port R
0x0800	TCC0	Timer/Counter 0 on port C
0x0840	TCC1	Timer/Counter 1 on port C
0x0880	AWEXC	Advanced Waveform Extension on port C
0x0890	HIRESC	High Resolution Extension on port C
0x08A0	USARTC0	USART 0 on port C
0x08B0	USARTC1	USART 1 on port C
0x08C0	SPIC	Serial Peripheral Interface on port C
0x08F8	IRCOM	Infrared Communication Module
0x0900	TCD0	Timer/Counter 0 on port D
0x0940	TCD1	Timer/Counter 1 on port D
0x0990	HIRESD	High Resolution Extension on port D
0x09A0	USARTD0	USART 0 on port D
0x09B0	USARTD1	USART 1 on port D
0x09C0	SPID	Serial Peripheral Interface on port D
0x0A00	TCE0	Timer/Counter 0 on port E
0x0A90	HIRESE	High Resolution Extension on port E
0x0AA0	USARTE0	USART 0 on port E

32. Instruction Set Summary

Mnemonics	Operands	Description	Operation	Flags	#Clocks
Arithmetic and Logic Instructions					
ADD	Rd, Rr	Add without Carry	$Rd \leftarrow Rd + Rr$	Z,C,N,V,S,H	1
ADC	Rd, Rr	Add with Carry	$Rd \leftarrow Rd + Rr + C$	Z,C,N,V,S,H	1
ADIW	Rd, K	Add Immediate to Word	$Rd \leftarrow Rd + 1:Rd + K$	Z,C,N,V,S	2
SUB	Rd, Rr	Subtract without Carry	$Rd \leftarrow Rd - Rr$	Z,C,N,V,S,H	1
SUBI	Rd, K	Subtract Immediate	$Rd \leftarrow Rd - K$	Z,C,N,V,S,H	1
SBC	Rd, Rr	Subtract with Carry	$Rd \leftarrow Rd - Rr - C$	Z,C,N,V,S,H	1
SBCI	Rd, K	Subtract Immediate with Carry	$Rd \leftarrow Rd - K - C$	Z,C,N,V,S,H	1
SBIW	Rd, K	Subtract Immediate from Word	$Rd + 1:Rd \leftarrow Rd + 1:Rd - K$	Z,C,N,V,S	2
AND	Rd, Rr	Logical AND	$Rd \leftarrow Rd \bullet Rr$	Z,N,V,S	1
ANDI	Rd, K	Logical AND with Immediate	$Rd \leftarrow Rd \bullet K$	Z,N,V,S	1
OR	Rd, Rr	Logical OR	$Rd \leftarrow Rd \vee Rr$	Z,N,V,S	1
ORI	Rd, K	Logical OR with Immediate	$Rd \leftarrow Rd \vee K$	Z,N,V,S	1
EOR	Rd, Rr	Exclusive OR	$Rd \leftarrow Rd \oplus Rr$	Z,N,V,S	1
COM	Rd	One's Complement	$Rd \leftarrow \$FF - Rd$	Z,C,N,V,S	1
NEG	Rd	Two's Complement	$Rd \leftarrow \$00 - Rd$	Z,C,N,V,S,H	1
SBR	Rd,K	Set Bit(s) in Register	$Rd \leftarrow Rd \vee K$	Z,N,V,S	1
CBR	Rd,K	Clear Bit(s) in Register	$Rd \leftarrow Rd \bullet (\$FFh - K)$	Z,N,V,S	1
INC	Rd	Increment	$Rd \leftarrow Rd + 1$	Z,N,V,S	1
DEC	Rd	Decrement	$Rd \leftarrow Rd - 1$	Z,N,V,S	1
TST	Rd	Test for Zero or Minus	$Rd \leftarrow Rd \bullet Rd$	Z,N,V,S	1
CLR	Rd	Clear Register	$Rd \leftarrow Rd \oplus Rd$	Z,N,V,S	1
SER	Rd	Set Register	$Rd \leftarrow \$FF$	None	1
MUL	Rd,Rr	Multiply Unsigned	$R1:R0 \leftarrow Rd \times Rr$ (UU)	Z,C	2
MULS	Rd,Rr	Multiply Signed	$R1:R0 \leftarrow Rd \times Rr$ (SS)	Z,C	2
MULSU	Rd,Rr	Multiply Signed with Unsigned	$R1:R0 \leftarrow Rd \times Rr$ (SU)	Z,C	2
FMUL	Rd,Rr	Fractional Multiply Unsigned	$R1:R0 \leftarrow Rd \times Rr \ll 1$ (UU)	Z,C	2
FMULS	Rd,Rr	Fractional Multiply Signed	$R1:R0 \leftarrow Rd \times Rr \ll 1$ (SS)	Z,C	2
FMULSU	Rd,Rr	Fractional Multiply Signed with Unsigned	$R1:R0 \leftarrow Rd \times Rr \ll 1$ (SU)	Z,C	2
DES	K	Data Encryption	if (H = 0) then R15:R0 \leftarrow Encrypt(R15:R0, K) else if (H = 1) then R15:R0 \leftarrow Decrypt(R15:R0, K)		1/2
Branch Instructions					
RJMP	k	Relative Jump	$PC \leftarrow PC + k + 1$	None	2
IJMP		Indirect Jump to (Z)	$PC(15:0) \leftarrow Z,$ $PC(21:16) \leftarrow 0$	None	2
EIJMP		Extended Indirect Jump to (Z)	$PC(15:0) \leftarrow Z,$ $PC(21:16) \leftarrow EIND$	None	2
JMP	k	Jump	$PC \leftarrow k$	None	3
RCALL	k	Relative Call Subroutine	$PC \leftarrow PC + k + 1$	None	2 / 3 ⁽¹⁾
ICALL		Indirect Call to (Z)	$PC(15:0) \leftarrow Z,$ $PC(21:16) \leftarrow 0$	None	2 / 3 ⁽¹⁾
EICALL		Extended Indirect Call to (Z)	$PC(15:0) \leftarrow Z,$ $PC(21:16) \leftarrow EIND$	None	3 ⁽¹⁾



Mnemonics	Operands	Description	Operation	Flags	#Clocks
CALL	k	call Subroutine	PC ← k	None	3 / 4 ⁽¹⁾
RET		Subroutine Return	PC ← STACK	None	4 / 5 ⁽¹⁾
RETI		Interrupt Return	PC ← STACK	I	4 / 5 ⁽¹⁾
CPSE	Rd,Rr	Compare, Skip if Equal	if (Rd = Rr) PC ← PC + 2 or 3	None	1 / 2 / 3
CP	Rd,Rr	Compare	Rd - Rr	Z,C,N,V,S,H	1
CPC	Rd,Rr	Compare with Carry	Rd - Rr - C	Z,C,N,V,S,H	1
CPI	Rd,K	Compare with Immediate	Rd - K	Z,C,N,V,S,H	1
SBRC	Rr, b	Skip if Bit in Register Cleared	if (Rr(b) = 0) PC ← PC + 2 or 3	None	1 / 2 / 3
SBRS	Rr, b	Skip if Bit in Register Set	if (Rr(b) = 1) PC ← PC + 2 or 3	None	1 / 2 / 3
SBIC	A, b	Skip if Bit in I/O Register Cleared	if (I/O(A,b) = 0) PC ← PC + 2 or 3	None	2 / 3 / 4
SBIS	A, b	Skip if Bit in I/O Register Set	If (I/O(A,b)=1) PC ← PC + 2 or 3	None	2 / 3 / 4
BRBS	s, k	Branch if Status Flag Set	if (SREG(s) = 1) then PC ← PC + k + 1	None	1 / 2
BRBC	s, k	Branch if Status Flag Cleared	if (SREG(s) = 0) then PC ← PC + k + 1	None	1 / 2
BREQ	k	Branch if Equal	if (Z = 1) then PC ← PC + k + 1	None	1 / 2
BRNE	k	Branch if Not Equal	if (Z = 0) then PC ← PC + k + 1	None	1 / 2
BRCS	k	Branch if Carry Set	if (C = 1) then PC ← PC + k + 1	None	1 / 2
BRCC	k	Branch if Carry Cleared	if (C = 0) then PC ← PC + k + 1	None	1 / 2
BRSH	k	Branch if Same or Higher	if (C = 0) then PC ← PC + k + 1	None	1 / 2
BRLO	k	Branch if Lower	if (C = 1) then PC ← PC + k + 1	None	1 / 2
BRMI	k	Branch if Minus	if (N = 1) then PC ← PC + k + 1	None	1 / 2
BRPL	k	Branch if Plus	if (N = 0) then PC ← PC + k + 1	None	1 / 2
BRGE	k	Branch if Greater or Equal, Signed	if (N ⊕ V = 0) then PC ← PC + k + 1	None	1 / 2
BRLT	k	Branch if Less Than, Signed	if (N ⊕ V = 1) then PC ← PC + k + 1	None	1 / 2
BRHS	k	Branch if Half Carry Flag Set	if (H = 1) then PC ← PC + k + 1	None	1 / 2
BRHC	k	Branch if Half Carry Flag Cleared	if (H = 0) then PC ← PC + k + 1	None	1 / 2
BRTS	k	Branch if T Flag Set	if (T = 1) then PC ← PC + k + 1	None	1 / 2
BRTC	k	Branch if T Flag Cleared	if (T = 0) then PC ← PC + k + 1	None	1 / 2
BRVS	k	Branch if Overflow Flag is Set	if (V = 1) then PC ← PC + k + 1	None	1 / 2
BRVC	k	Branch if Overflow Flag is Cleared	if (V = 0) then PC ← PC + k + 1	None	1 / 2
BRIE	k	Branch if Interrupt Enabled	if (I = 1) then PC ← PC + k + 1	None	1 / 2
BRID	k	Branch if Interrupt Disabled	if (I = 0) then PC ← PC + k + 1	None	1 / 2

Data Transfer Instructions

MOV	Rd, Rr	Copy Register	Rd ← Rr	None	1
MOVW	Rd, Rr	Copy Register Pair	Rd+1:Rd ← Rr+1:Rr	None	1
LDI	Rd, K	Load Immediate	Rd ← K	None	1
LDS	Rd, k	Load Direct from data space	Rd ← (k)	None	2 ⁽¹⁾⁽²⁾
LD	Rd, X	Load Indirect	Rd ← (X)	None	1 ⁽¹⁾⁽²⁾
LD	Rd, X+	Load Indirect and Post-Increment	Rd ← (X) X ← X + 1	None	1 ⁽¹⁾⁽²⁾
LD	Rd, -X	Load Indirect and Pre-Decrement	X ← X - 1, Rd ← (X) ← (X)	None	2 ⁽¹⁾⁽²⁾
LD	Rd, Y	Load Indirect	Rd ← (Y) ← (Y)	None	1 ⁽¹⁾⁽²⁾
LD	Rd, Y+	Load Indirect and Post-Increment	Rd ← (Y) Y ← Y + 1	None	1 ⁽¹⁾⁽²⁾

Mnemonics	Operands	Description	Operation	Flags	#Clocks
LD	Rd, -Y	Load Indirect and Pre-Decrement	Y ← Y - 1 Rd ← (Y)	None	2 ⁽¹⁾⁽²⁾
LDD	Rd, Y+q	Load Indirect with Displacement	Rd ← (Y + q)	None	2 ⁽¹⁾⁽²⁾
LD	Rd, Z	Load Indirect	Rd ← (Z)	None	1 ⁽¹⁾⁽²⁾
LD	Rd, Z+	Load Indirect and Post-Increment	Rd ← (Z), Z ← Z+1	None	1 ⁽¹⁾⁽²⁾
LD	Rd, -Z	Load Indirect and Pre-Decrement	Z ← Z - 1, Rd ← (Z)	None	2 ⁽¹⁾⁽²⁾
LDD	Rd, Z+q	Load Indirect with Displacement	Rd ← (Z + q)	None	2 ⁽¹⁾⁽²⁾
STS	k, Rr	Store Direct to Data Space	(k) ← Rr	None	2 ⁽¹⁾
ST	X, Rr	Store Indirect	(X) ← Rr	None	1 ⁽¹⁾
ST	X+, Rr	Store Indirect and Post-Increment	(X) ← Rr, X ← X + 1	None	1 ⁽¹⁾
ST	-X, Rr	Store Indirect and Pre-Decrement	X ← X - 1, (X) ← Rr	None	2 ⁽¹⁾
ST	Y, Rr	Store Indirect	(Y) ← Rr	None	1 ⁽¹⁾
ST	Y+, Rr	Store Indirect and Post-Increment	(Y) ← Rr, Y ← Y + 1	None	1 ⁽¹⁾
ST	-Y, Rr	Store Indirect and Pre-Decrement	Y ← Y - 1, (Y) ← Rr	None	2 ⁽¹⁾
STD	Y+q, Rr	Store Indirect with Displacement	(Y + q) ← Rr	None	2 ⁽¹⁾
ST	Z, Rr	Store Indirect	(Z) ← Rr	None	1 ⁽¹⁾
ST	Z+, Rr	Store Indirect and Post-Increment	(Z) ← Rr, Z ← Z + 1	None	1 ⁽¹⁾
ST	-Z, Rr	Store Indirect and Pre-Decrement	Z ← Z - 1	None	2 ⁽¹⁾
STD	Z+q,Rr	Store Indirect with Displacement	(Z + q) ← Rr	None	2 ⁽¹⁾
LPM		Load Program Memory	R0 ← (Z)	None	3
LPM	Rd, Z	Load Program Memory	Rd ← (Z)	None	3
LPM	Rd, Z+	Load Program Memory and Post-Increment	Rd ← (Z), Z ← Z + 1	None	3
ELPM		Extended Load Program Memory	R0 ← (RAMPZ:Z)	None	3
ELPM	Rd, Z	Extended Load Program Memory	Rd ← (RAMPZ:Z)	None	3
ELPM	Rd, Z+	Extended Load Program Memory and Post-Increment	Rd ← (RAMPZ:Z), Z ← Z + 1	None	3
SPM		Store Program Memory	(RAMPZ:Z) ← R1:R0	None	-
SPM	Z+	Store Program Memory and Post-Increment by 2	(RAMPZ:Z) ← R1:R0, Z ← Z + 2	None	-
IN	Rd, A	In From I/O Location	Rd ← I/O(A)	None	1
OUT	A, Rr	Out To I/O Location	I/O(A) ← Rr	None	1
PUSH	Rr	Push Register on Stack	STACK ← Rr	None	1 ⁽¹⁾
POP	Rd	Pop Register from Stack	Rd ← STACK	None	2 ⁽¹⁾
Bit and Bit-test Instructions					
LSL	Rd	Logical Shift Left	Rd(n+1) ← Rd(n), Rd(0) ← 0, C ← Rd(7)	Z,C,N,V,H	1
LSR	Rd	Logical Shift Right	Rd(n) ← Rd(n+1), Rd(7) ← 0, C ← Rd(0)	Z,C,N,V	1

Mnemonics	Operands	Description	Operation	Flags	#Clocks
ROL	Rd	Rotate Left Through Carry	Rd(0) ← C, Rd(n+1) ← Rd(n), C ← Rd(7)	Z,C,N,V,H	1
ROR	Rd	Rotate Right Through Carry	Rd(7) ← C, Rd(n) ← Rd(n+1), C ← Rd(0)	Z,C,N,V	1
ASR	Rd	Arithmetic Shift Right	Rd(n) ← Rd(n+1), n=0..6	Z,C,N,V	1
SWAP	Rd	Swap Nibbles	Rd(3..0) ↔ Rd(7..4)	None	1
BSET	s	Flag Set	SREG(s) ← 1	SREG(s)	1
BCLR	s	Flag Clear	SREG(s) ← 0	SREG(s)	1
SBI	A, b	Set Bit in I/O Register	I/O(A, b) ← 1	None	1
CBI	A, b	Clear Bit in I/O Register	I/O(A, b) ← 0	None	1
BST	Rr, b	Bit Store from Register to T	T ← Rr(b)	T	1
BLD	Rd, b	Bit load from T to Register	Rd(b) ← T	None	1
SEC		Set Carry	C ← 1	C	1
CLC		Clear Carry	C ← 0	C	1
SEN		Set Negative Flag	N ← 1	N	1
CLN		Clear Negative Flag	N ← 0	N	1
SEZ		Set Zero Flag	Z ← 1	Z	1
CLZ		Clear Zero Flag	Z ← 0	Z	1
SEI		Global Interrupt Enable	I ← 1	I	1
CLI		Global Interrupt Disable	I ← 0	I	1
SES		Set Signed Test Flag	S ← 1	S	1
CLS		Clear Signed Test Flag	S ← 0	S	1
SEV		Set Two's Complement Overflow	V ← 1	V	1
CLV		Clear Two's Complement Overflow	V ← 0	V	1
SET		Set T in SREG	T ← 1	T	1
CLT		Clear T in SREG	T ← 0	T	1
SEH		Set Half Carry Flag in SREG	H ← 1	H	1
CLH		Clear Half Carry Flag in SREG	H ← 0	H	1
MCU Control Instructions					
BREAK		Break	(See specific descr. for BREAK)	None	1
NOP		No Operation		None	1
SLEEP		Sleep	(see specific descr. for Sleep)	None	1
WDR		Watchdog Reset	(see specific descr. for WDR)	None	1

- Notes:
1. Cycle times for Data memory accesses assume internal memory accesses, and are not valid for accesses via the external RAM interface.
 2. One extra cycle must be added when accessing Internal SRAM.

33. Packaging information

33.1 44A

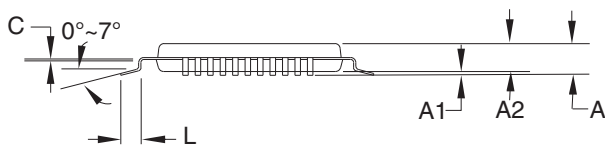
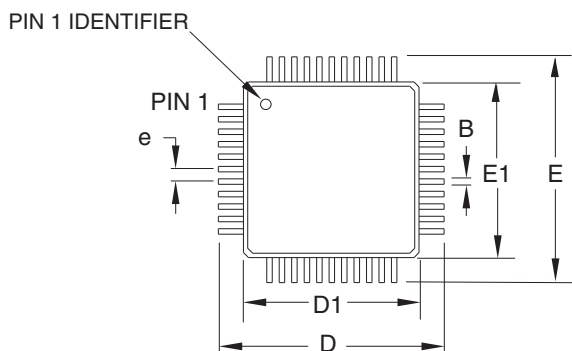

COMMON DIMENSIONS
(Unit of Measure = mm)

SYMBOL	MIN	NOM	MAX	NOTE
A	-	-	1.20	
A1	0.05	-	0.15	
A2	0.95	1.00	1.05	
D	11.75	12.00	12.25	
D1	9.90	10.00	10.10	Note 2
E	11.75	12.00	12.25	
E1	9.90	10.00	10.10	Note 2
B	0.30	-	0.45	
C	0.09	-	0.20	
L	0.45	-	0.75	
e	0.80 TYP			

Notes:

1. This package conforms to JEDEC reference MS-026, Variation ACB.
2. Dimensions D1 and E1 do not include mold protrusion. Allowable protrusion is 0.25mm per side. Dimensions D1 and E1 are maximum plastic body size dimensions including mold mismatch.
3. Lead coplanarity is 0.10mm maximum.

2010-10-20

 2325 Orchard Parkway San Jose, CA 95131	TITLE	DRAWING NO.	REV.
	44A , 44-lead, 10 x 10mm body size, 1.0mm body thickness, 0.8 mm lead pitch, thin profile plastic quad flat package (TQFP)	44A	C

33.2 44M1

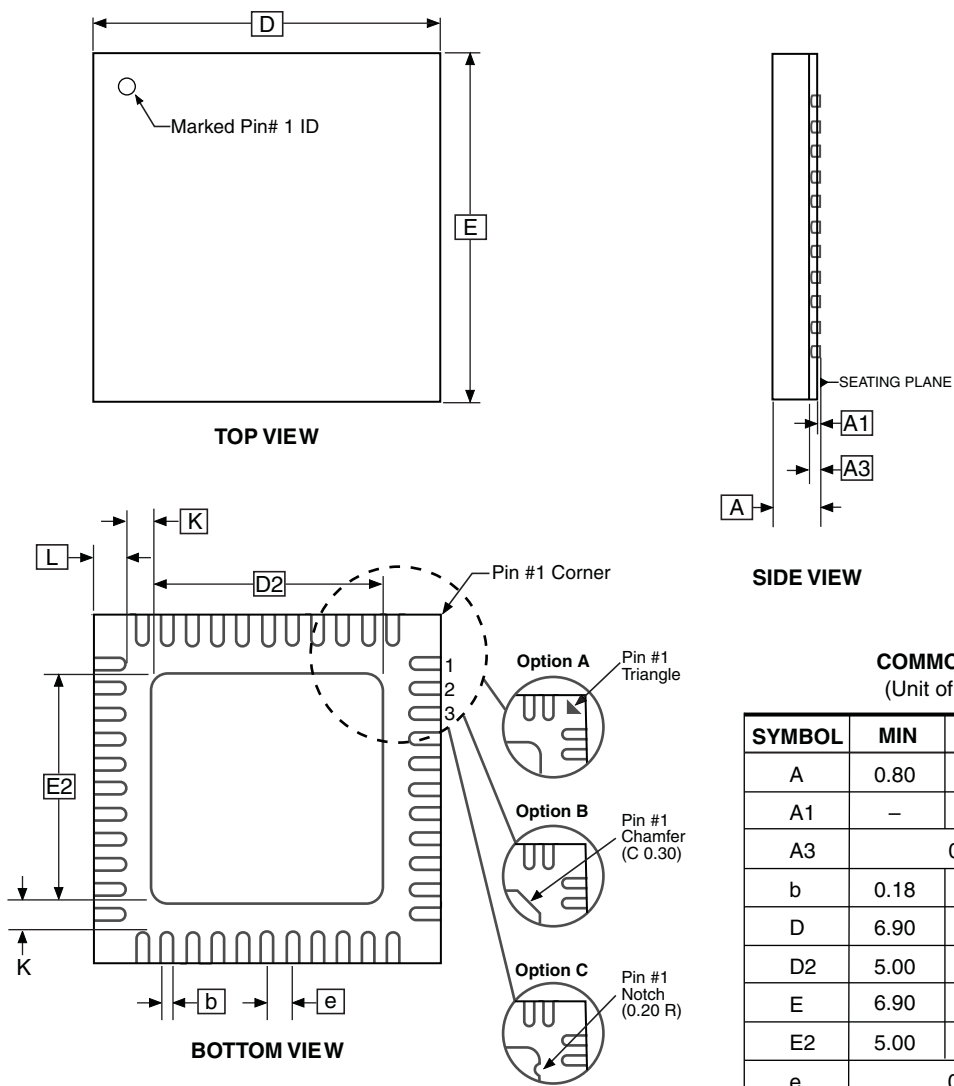

Note: JEDEC Standard MO-220, Fig. 1 (SAW Singulation) VKKD-3.

9/26/08



Package Drawing Contact:
packagedrawings@atmel.com

TITLE
44M1, 44-pad, 7 x 7 x 1.0mm body, lead pitch 0.50mm, 5.20mm exposed pad, thermally enhanced plastic very thin quad flat no lead package (VQFN)

GPC
ZWS

DRAWING NO.
44M1

REV.
H



33.3 49C2

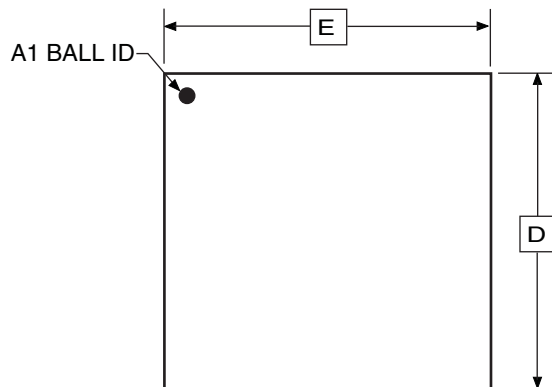

TOP VIEW

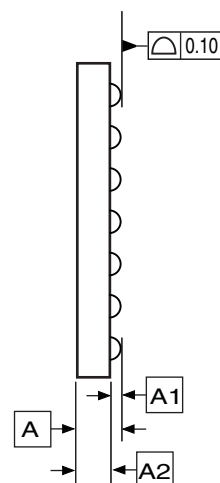

SIDE VIEW

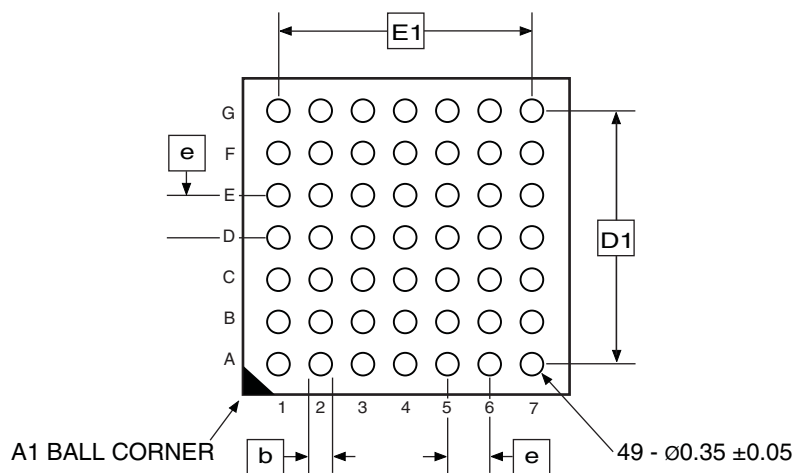

BOTTOM VIEW

COMMON DIMENSIONS
(Unit of Measure = mm)

SYMBOL	MIN	NOM	MAX	NOTE
A	-	-	1.00	
A1	0.20	-	-	
A2	0.65	-	-	
D	4.90	5.00	5.10	
D1	3.90 BSC			
E	4.90	5.00	5.10	
E1	3.90 BSC			
b	0.30	0.35	0.40	
e	0.65 BSC			

3/14/08



Package Drawing Contact:
packagedrawings@atmel.com

TITLE
49C2, 49-ball (7 x 7 array), 0.65mm pitch,
5.0 x 5.0 x 1.0mm, very thin, fine-pitch
ball grid array package (VFBGA)

GPC

CBD

DRAWING NO.

49C2

REV.

A



34. Electrical Characteristics

All typical values are measured at T = 25°C unless other temperature condition is given. All minimum and maximum values are valid across operating temperature and voltage unless other conditions are given.

34.1 Absolute Maximum Ratings*

Operating Temperature.....	-55°C to +125°C
Storage Temperature	-65°C to +150°C
Voltage on any Pin with respect to Ground..	-0.5V to V _{CC} +0.5V
Maximum Operating Voltage	3.6V
DC Current per I/O Pin	20.0 mA
DC Current V _{CC} and GND Pins.....	200.0 mA

*NOTICE: Stresses beyond those listed under “Absolute Maximum Ratings” may cause permanent damage to the device. This is a stress rating only and functional operation of the device at these or other conditions beyond those indicated in the operational sections of this specification is not implied. Exposure to absolute maximum rating conditions for extended periods may affect device reliability.

34.2 DC Characteristics

Table 34-1. Current Consumption

Symbol	Parameter	Condition	Min.	Typ.	Max.	Units		
I _{CC}	Power Supply Current ⁽¹⁾	Active	32 kHz, Ext. Clk	V _{CC} = 1.8V	30		μA	
				V _{CC} = 3.0V	75			
			1 MHz, Ext. Clk	V _{CC} = 1.8V	260			mA
				V _{CC} = 3.0V	570			
			2 MHz, Ext. Clk	V _{CC} = 1.8V	510	690	mA	
				V _{CC} = 3.0V	1.1	1.49		
			32 MHz, Ext. Clk	V _{CC} = 3.0V	11.4	13		
		Idle	32 kHz, Ext. Clk	V _{CC} = 1.8V	2.8		μA	
				V _{CC} = 3.0V	4.8			
			1 MHz, Ext. Clk	V _{CC} = 1.8V	80		μA	
	V _{CC} = 3.0V			150				
	2 MHz, Ext. Clk		V _{CC} = 1.8V	160	225	mA		
		V _{CC} = 3.0V	295	390				
	Power-down mode	All Functions Disabled, T = 25°C	V _{CC} = 3.0V	0.1	3	μA		
All Functions Disabled, T = 85°C		V _{CC} = 3.0V	1.5	5				
ULP, WDT, Sampled BOD, T = 25°C		V _{CC} = 1.8V	1.1	6				
		V _{CC} = 3.0V	1.1	6				
ULP, WDT, Sampled BOD, T = 85°C		V _{CC} = 3.0V	2.6	10				

Table 34-1. Current Consumption (Continued)

Symbol	Parameter	Condition	Min.	Typ.	Max.	Units
I _{CC}	Power-save mode	RTC 1 kHz from Low Power 32 kHz TOSC, T = 25°C	V _{CC} = 1.8V	0.5	4	μA
			V _{CC} = 3.0V	0.7	4	
		RTC from Low Power 32 kHz TOSC	V _{CC} = 3.0V	1.16		
	Reset Current Consumption	without Reset pull-up resistor current	V _{CC} = 3.0V	505		
Module current consumption⁽²⁾						
I _{CC}	RC32M			470		μA
	RC32M w/DFLL	Internal 32.768 kHz oscillator as DFLL source		600		
	RC2M			112		
	RC2M w/DFLL	Internal 32.768 kHz oscillator as DFLL source		145		
	RC32K			30		
	PLL	Multiplication factor = 10x		225		
	Watchdog normal mode			0.9		
	BOD Continuous mode			120		
	BOD Sampled mode			1		
	Internal 1.00 V ref			80		
	Temperature reference			80		
	RTC with int. 32 kHz RC as source	No prescaling		30		
	RTC with ULP as source	No prescaling		0.9		
	ADC	250 kS/s - Int. 1V Ref		2.9		mA
	DAC Normal Mode	Single channel, Int. 1V Ref		2.4		
	DAC Low-Power Mode	Single channel, Int. 1V Ref		1.1		
	AC High-speed			280		μA
	AC Low-power			110		
	USART	Rx and Tx enabled, 9600 BAUD		5.3		
	DMA			95		
	Timer/Counter	Prescaler DIV1		19		
	AES			140		
Flash/EEPROM Programming	V _{CC} = 2V			13		mA
	V _{CC} = 3V			18		

- Note:
- All Power Reduction Registers set.
 - All parameters measured as the difference in current consumption between module enabled and disabled. All data at V_{CC} = 3.0V, Clk_{SYS} = 1 MHz External clock with no prescaling.

34.3 Speed

Table 34-2. Operating voltage and frequency

Symbol	Parameter	Condition	Min	Typ	Max	Units
Clk _{CPU}	CPU clock frequency	V _{CC} = 1.6V	0		12	MHz
		V _{CC} = 1.8V	0		12	
		V _{CC} = 2.7V	0		32	
		V _{CC} = 3.6V	0		32	

The maximum CPU clock frequency of the XMEGA A4 devices is depending on V_{CC}. As shown in [Figure 34-1 on page 63](#) the Frequency vs. V_{CC} curve is linear between 1.8V < V_{CC} < 2.7V.

Figure 34-1. Operating Frequency vs. V_{CC}

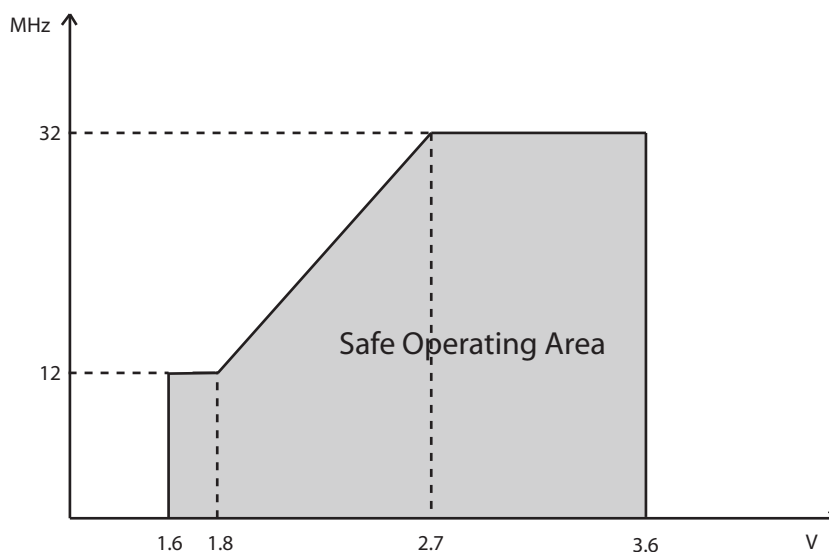

34.4 Flash and EEPROM Memory Characteristics

Table 34-3. Endurance and Data Retention

Symbol	Parameter	Condition	Min	Typ	Max	Units
	Flash	Write/Erase cycles	25°C	10K		Cycle
			85°C	10K		
		Data retention	25°C	100		Year
			55°C	25		
	EEPROM	Write/Erase cycles	25°C	80K		Cycle
			85°C	30K		
		Data retention	25°C	100		Year
			55°C	25		

Table 34-4. Programming time

Symbol	Parameter	Condition	Min	Typ ⁽¹⁾	Max	Units
	Chip Erase	Flash, EEPROM ⁽²⁾ and SRAM Erase		40		ms
	Flash	Page Erase		6		
		Page Write		6		
		Page WriteAutomatic Page Erase and Write		12		
	EEPROM	Page Erase		6		
		Page Write		6		
		Page WriteAutomatic Page Erase and Write		12		

- Notes: 1. Programming is timed from the internal 2 MHz oscillator.
 2. EEPROM is not erased if the EESAVE fuse is programmed.

34.5 ADC Characteristics

Table 34-5. ADC Characteristics

Symbol	Parameter	Condition	Min	Typ	Max	Units
RES	Resolution	Programmable: 8/12	8	12	12	Bits
INL	Integral Non-Linearity	500 ksps	-5	±2	5	LSB
DNL	Differential Non-Linearity	500 ksps		< ±1		
	Gain Error			< ±10		mV
	Offset Error			< ±2		
ADC _{clk}	ADC Clock frequency	Max is 1/4 of Peripheral Clock			2000	kHz
	Conversion rate				2000	ksps
	Conversion time (propagation delay)	(RES+2)/2+GAIN RES = 8 or 12, GAIN = 0 or 1	5	7	8	ADC _{clk} cycles
	Sampling Time	1/2 ADC _{clk} cycle	0.25			µs
	Conversion range		0		VREF	V
AVCC	Analog Supply Voltage		V _{CC} -0.3		V _{CC} +0.3	
VREF	Reference voltage		1.0		V _{CC} -0.6V	
	Input bandwidth					kHz
INT1V	Internal 1.00V reference ⁽¹⁾			1.00		V
INTVCC	Internal V _{CC} /1.6			V _{CC} /1.6		
SCALEDVCC	Scaled internal V _{CC} /10 input			V _{CC} /10		
R _{AREF}	Reference input resistance			> 10		MΩ
	Start-up time			12	24	ADC _{clk} cycles
	Internal input sampling speed	Temp. sensor, V _{CC} /10, Bandgap			100	ksps

Note: 1. Refer to "Bandgap Characteristics" on page 66 for more parameter details.

Table 34-6. ADC Gain Stage Characteristics

Symbol	Parameter	Condition	Min	Typ	Max	Units
	Gain error	1 to 64 gain		< ±1		%
	Offset error			< ±1		mV
Vrms	Noise level at input	64x gain	VREF = Int. 1V	0.12		
			VREF = Ext. 2V	0.06		
	Clock rate	Same as ADC			1000	kHz

34.6 DAC Characteristics

Table 34-7. DAC Characteristics

Symbol	Parameter	Condition		Min	Typ	Max	Units
INL	Integral Non-Linearity	$V_{CC} = 1.6-3.6V$	$V_{REF} = \text{Ext. ref}$		± 5		LSB
DNL	Differential Non-Linearity	$V_{CC} = 1.6-3.6V$	$V_{REF} = \text{Ext. ref}$ $V_{REF} = AV_{CC}$		$< \pm 1$		
F_{clk}	Conversion rate					1000	ksps
AREF	External reference voltage			1.1		$AV_{CC}-0.6$	V
	Reference input impedance				> 10		$M\Omega$
	Max output voltage	$R_{load}=100k\Omega$			$AV_{CC}*0.98$		V
	Min output voltage	$R_{load}=100k\Omega$			< 0.030		
	Offset factory calibration accuracy	Continues mode, $V_{CC}=3.0V$, $V_{REF} = \text{Int } 1.00V$, $T=85^{\circ}C$			± 0.5		LSB
	Gain factory calibration accuracy				± 2.5		

34.7 Analog Comparator Characteristics

Table 34-8. Analog Comparator Characteristics

Symbol	Parameter	Condition		Min	Typ	Max	Units
V_{off}	Input Offset Voltage	$V_{CC} = 1.6 - 3.6V$			$< \pm 10$		mV
I_{lk}	Input Leakage Current	$V_{CC} = 1.6 - 3.6V$			< 1000		pA
V_{hys1}	Hysteresis, No	$V_{CC} = 1.6 - 3.6V$			0		mV
V_{hys2}	Hysteresis, Small	$V_{CC} = 1.6 - 3.6V$	mode = HS		20		mV
V_{hys3}	Hysteresis, Large	$V_{CC} = 1.6 - 3.6V$	mode = HS		40		
t_{delay}	Propagation delay	$V_{CC} = 3.0V$, $T = 85^{\circ}C$	mode = HS		90		ns
		$V_{CC} = 1.6 - 3.6V$	mode = LP		175		

34.8 Bandgap Characteristics

Table 34-9. Bandgap Voltage Characteristics

Symbol	Parameter	Condition		Min	Typ	Max	Units
	Bandgap Startup Time	As reference to ADC or DAC		$1 \text{ CLK_PER} + 2.5\mu s$			μs
		As input to AC or ADC			1.5		
	Bandgap voltage				1.1		V
	ADC/DAC ref	$T = 85^{\circ}C$, After calibration		0.99	1	1.01	
	Variation over voltage and temperature	$V_{CC} = 1.6 - 3.6V$, $T_A = -40^{\circ}C$ to $85^{\circ}C$			± 2		%

34.9 Brownout Detection Characteristics

Table 34-10. Brownout Detection Characteristics⁽¹⁾

Symbol	Parameter	Condition	Min	Typ	Max	Units
	BOD level 0 falling V _{CC}		1.62	1.63	1.7	V
	BOD level 1 falling V _{CC}			1.9		
	BOD level 2 falling V _{CC}			2.17		
	BOD level 3 falling V _{CC}			2.43		
	BOD level 4 falling V _{CC}			2.68		
	BOD level 5 falling V _{CC}			2.96		
	BOD level 6 falling V _{CC}			3.22		
	BOD level 7 falling V _{CC}			3.49		
	Hysteresis	BOD level 0-5		1		%

Note: 1. BOD is calibrated at 85°C within BOD level 0 values, and BOD level 0 is the default level.

34.10 PAD Characteristics

Table 34-11. PAD Characteristics

Symbol	Parameter	Condition	Min	Typ	Max	Units
V _{IH}	Input High Voltage	V _{CC} = 2.4 - 3.6V	0.7*V _{CC}		V _{CC} +0.5	V
		V _{CC} = 1.6 - 2.4V	0.8*V _{CC}		V _{CC} +0.5	
V _{IL}	Input Low Voltage	V _{CC} = 2.4 - 3.6V	-0.5		0.3*V _{CC}	
		V _{CC} = 1.6 - 2.4V	-0.5		0.2*V _{CC}	
V _{OL}	Output Low Voltage GPIO	I _{OH} = 15 mA, V _{CC} = 3.3V		0.4	0.76	
		I _{OH} = 10 mA, V _{CC} = 3.0V		0.3	0.64	
		I _{OH} = 5 mA, V _{CC} = 1.8V		0.2	0.46	
V _{OH}	Output High Voltage GPIO	I _{OH} = -8 mA, V _{CC} = 3.3V	2.6	3.0		
		I _{OH} = -6 mA, V _{CC} = 3.0V	2.1	2.7		
		I _{OH} = -2 mA, V _{CC} = 1.8V	1.4	1.6		
I _{IL}	Input Leakage Current I/O pin			<0.001	1	μA
I _{IH}	Input Leakage Current I/O pin			<0.001	1	
R _P	I/O pin Pull/Buss keeper Resistor	T= -40°C to 85°C		20		kΩ
R _{RST}	Reset pin Pull-up Resistor	T= -40°C to 85°C		20		
	Input hysteresis	V _{CC} = 1.6 V - 3.6 V, T= -40°C to 85°C		0.5		V

34.11 POR Characteristics

Table 34-12. Power-on Reset Characteristics

Symbol	Parameter	Condition	Min	Typ	Max	Units
V _{POT-}	POR threshold voltage falling V _{CC}	V _{CC} falls faster than 1V/ms	0.4	0.8		V
		V _{CC} falls at 1V/ms or slower	0.8	1.3		
V _{POT+}	POR threshold voltage rising V _{CC}			1.3	1.59	

34.12 Reset Characteristics

Table 34-13. Reset Characteristics

Symbol	Parameter	Condition	Min	Typ	Max	Units
	Minimum reset pulse width			90		ns
	Reset threshold voltage	V _{CC} = 2.7 - 3.6V		0.45*V _{CC}		V
		V _{CC} = 1.6 - 2.7V		0.42*V _{CC}		

34.13 Oscillator Characteristics

Table 34-14. Internal 32.768 kHz Oscillator Characteristics

Symbol	Parameter	Condition	Min	Typ	Max	Units
	Accuracy	T = 85°C, V _{CC} = 3V, After production calibration	-0.5		0.5	%

Table 34-15. Internal 2 MHz Oscillator Characteristics

Symbol	Parameter	Condition	Min	Typ	Max	Units
	Accuracy	T = 85°C, V _{CC} = 3V, After production calibration	-1.5		1.5	%
	DFLL Calibration step size	T = 25°C, V _{CC} = 3V		0.15		

Table 34-16. Internal 32 MHz Oscillator Characteristics

Symbol	Parameter	Condition	Min	Typ	Max	Units
	Accuracy	T = 85°C, V _{CC} = 3V, After production calibration	-1.5		1.5	%
	DFLL Calibration stepsize	T = 25°C, V _{CC} = 3V		0.2		

Table 34-17. Internal 32 kHz, ULP Oscillator Characteristics

Symbol	Parameter	Condition	Min	Typ	Max	Units
	Output frequency 32 kHz ULP OSC	T = 85°C, V _{CC} = 3.0V		26		kHz

Table 34-18. External 32.768kHz Crystal Oscillator and TOSC characteristics

Symbol	Parameter	Condition	Min	Typ	Max	Units
SF	Safety factor	Capacitive load matched to crystal specification	3			
ESR/R ₁	Recommended crystal equivalent series resistance (ESR)	Crystal load capacitance 6.5pF			60	kΩ
		Crystal load capacitance 9.0pF			35	
C _{IN_TOSC}	Input capacitance between TOSC pins	Normal mode		4.7		pF
		Low power mode		5.2		

Note: 1. See [Figure 34-2](#) on page 69 for definition

Figure 34-2. TOSC input capacitance

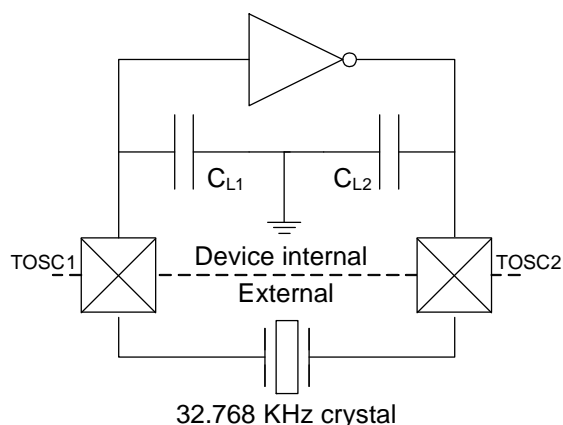

The input capacitance between the TOSC pins is CL1 + CL2 in series as seen from the crystal when oscillating without external capacitors.

Table 34-19. Device wake-up time from sleep

Symbol	Parameter	Condition ⁽¹⁾	Min	Typ ⁽²⁾	Max	Units
	Idle Sleep, Standby and Extended Standby sleep mode	Int. 32.768 kHz RC		130		μS
		Int. 2 MHz RC		2		
		Ext. 2 MHz Clock		2		
		Int. 32 MHz RC		0.17		
	Power-save and Power-down Sleep mode	Int. 32.768 kHz RC		320		
		Int. 2 MHz RC		10.3		
		Ext. 2 MHz Clock		4.5		
		Int. 32 MHz RC		5.8		

Notes: 1. Non-prescaled System Clock source.

2. Time from pin change on external interrupt pin to first available clock cycle. Additional interrupt response time is minimum 5 system clock source cycles.

35. Typical Characteristics

35.1 Active Supply Current

Figure 35-1. Active Supply Current vs. Frequency

$f_{SYS} = 0 - 1.0$ MHz External clock, $T = 25^{\circ}\text{C}$.

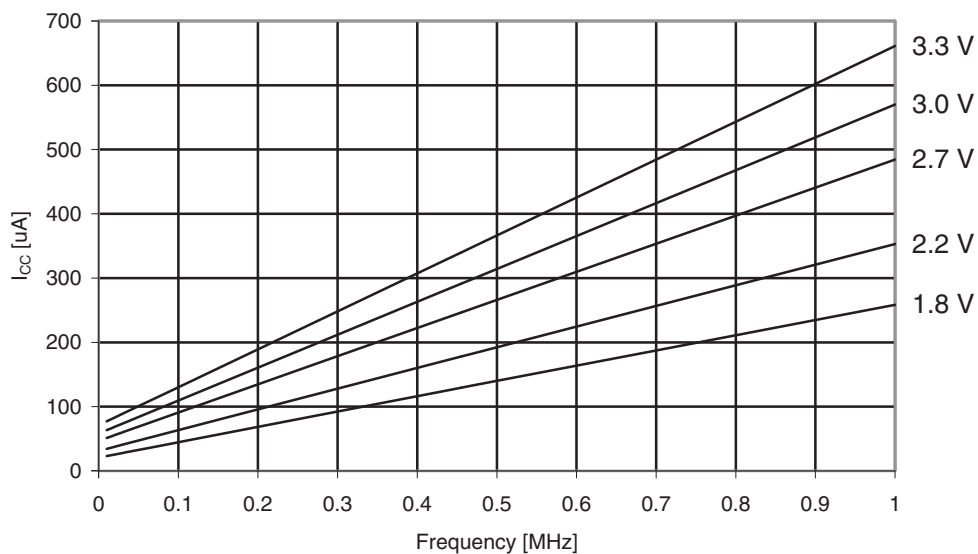

Figure 35-2. Active Supply Current vs. Frequency

$f_{SYS} = 1 - 32$ MHz External clock, $T = 25^{\circ}\text{C}$.

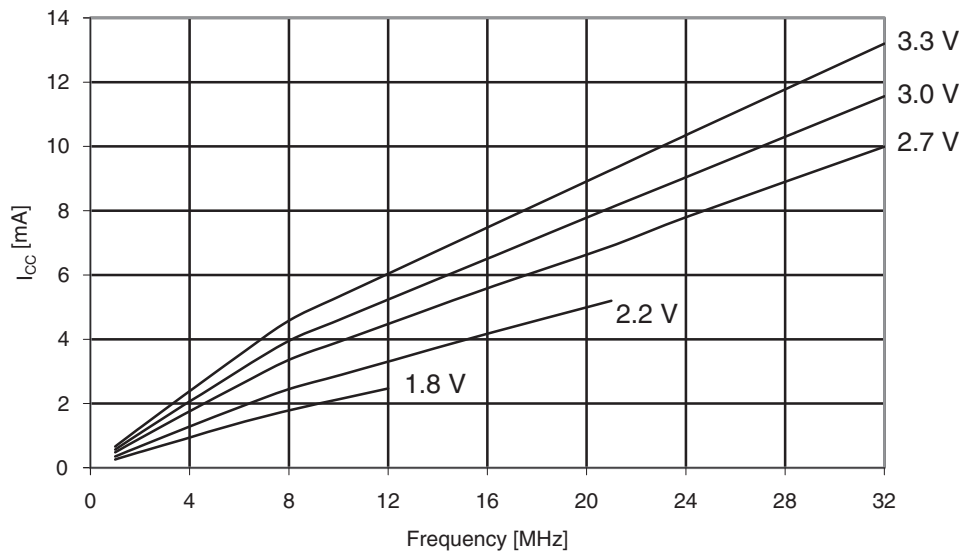

Figure 35-3. Active Supply Current vs. Vcc

$f_{SYS} = 1.0 \text{ MHz External Clock.}$

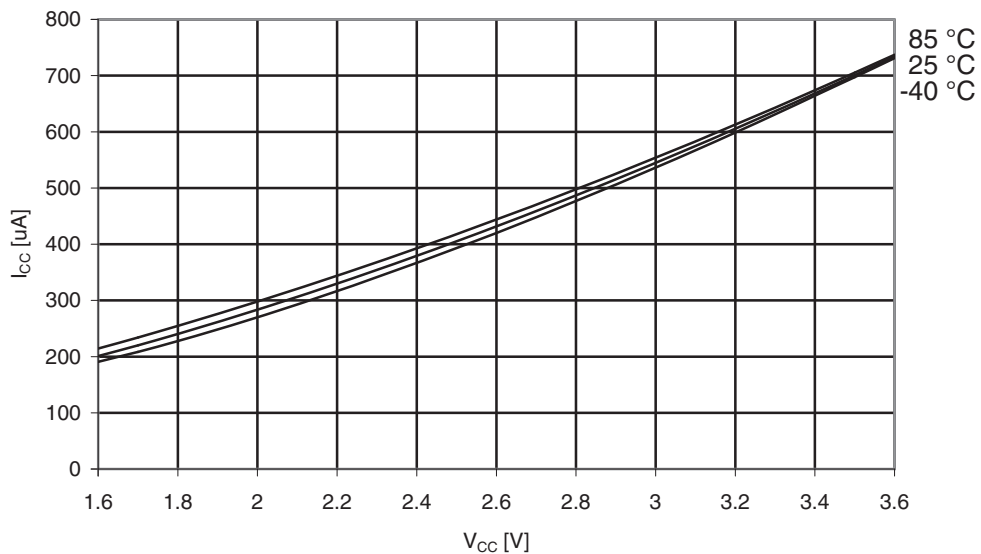

Figure 35-4. Active Supply Current vs. VCC

$f_{SYS} = 32.768 \text{ kHz internal RC.}$

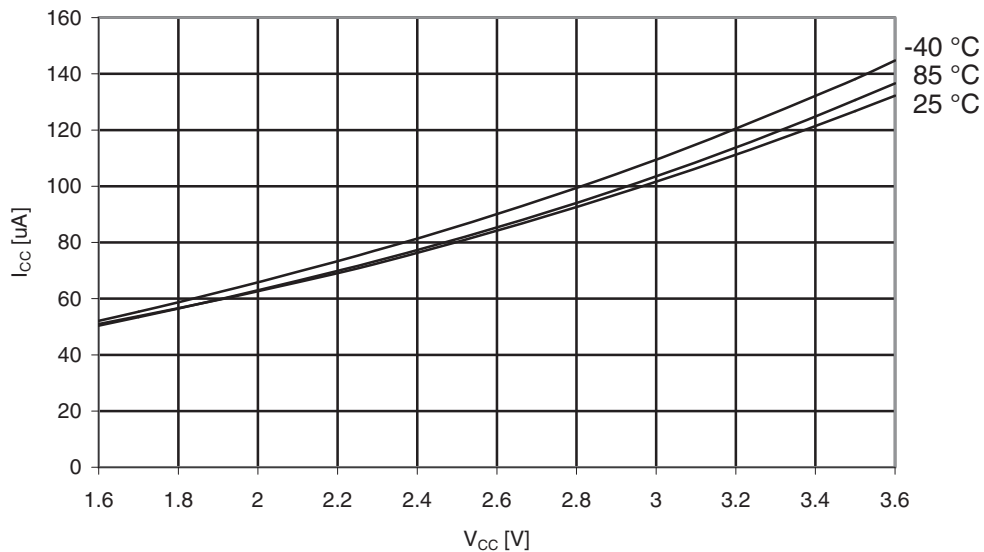

Figure 35-5. Active Supply Current vs. V_{CC}

f_{SYS} = 2.0 MHz internal RC.

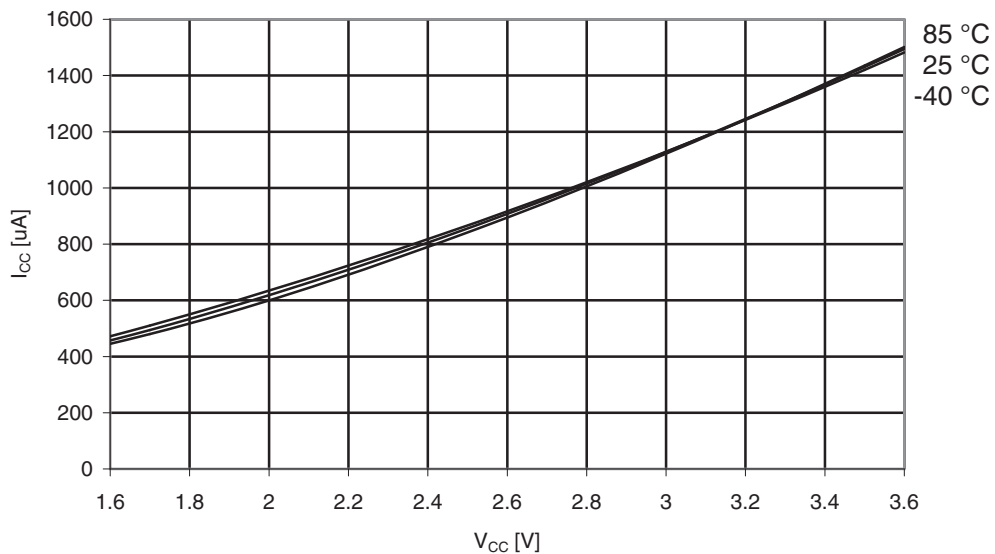

Figure 35-6. Active Supply Current vs. V_{CC}

f_{SYS} = 32 MHz internal RC prescaled to 8 MHz.

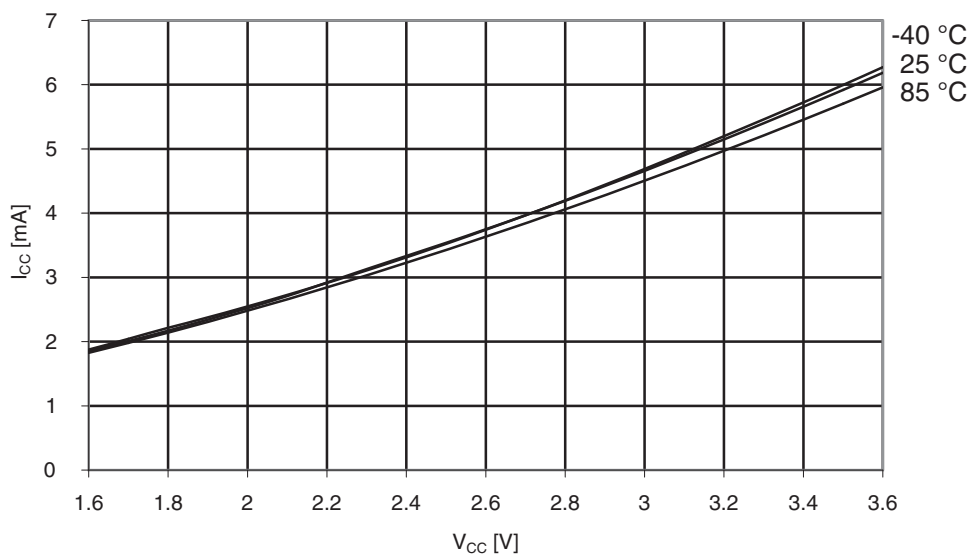
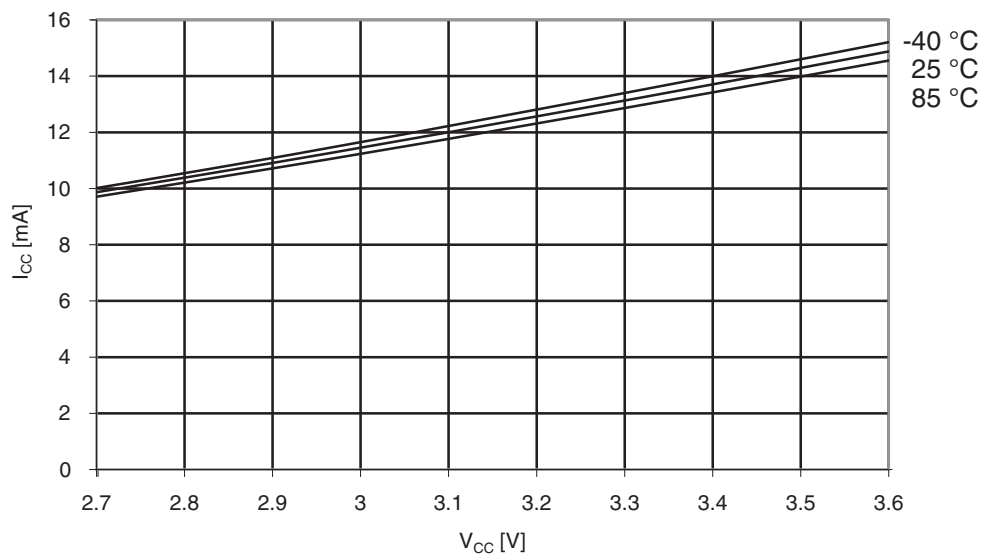

Figure 35-7. Active Supply Current vs. V_{CC}

f_{SYS} = 32 MHz internal RC.



35.2 Idle Supply Current

Figure 35-8. Idle Supply Current vs. Frequency

f_{SYS} = 0 - 1.0 MHz, T = 25°C.

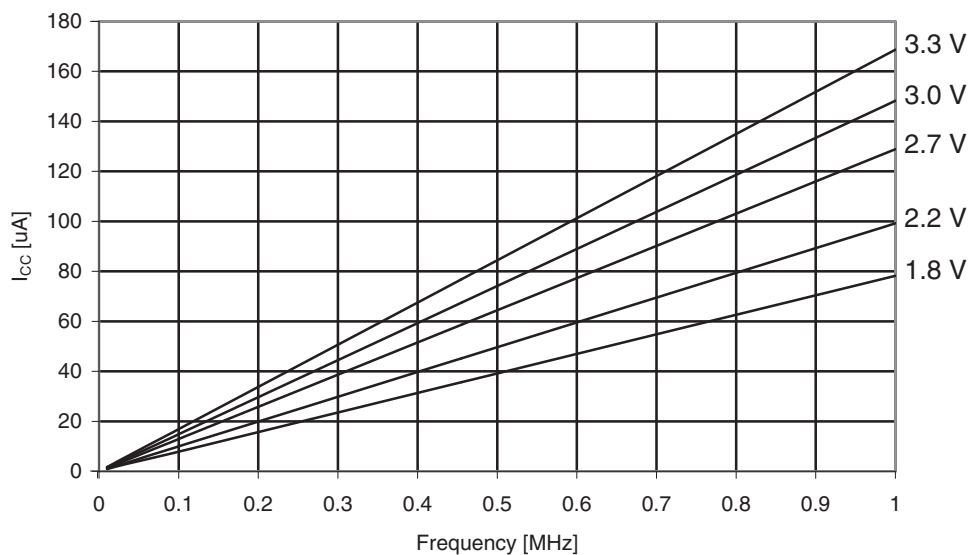

Figure 35-9. Idle Supply Current vs. Frequency

$f_{SYS} = 1 - 32 \text{ MHz}, T = 25^\circ\text{C}.$

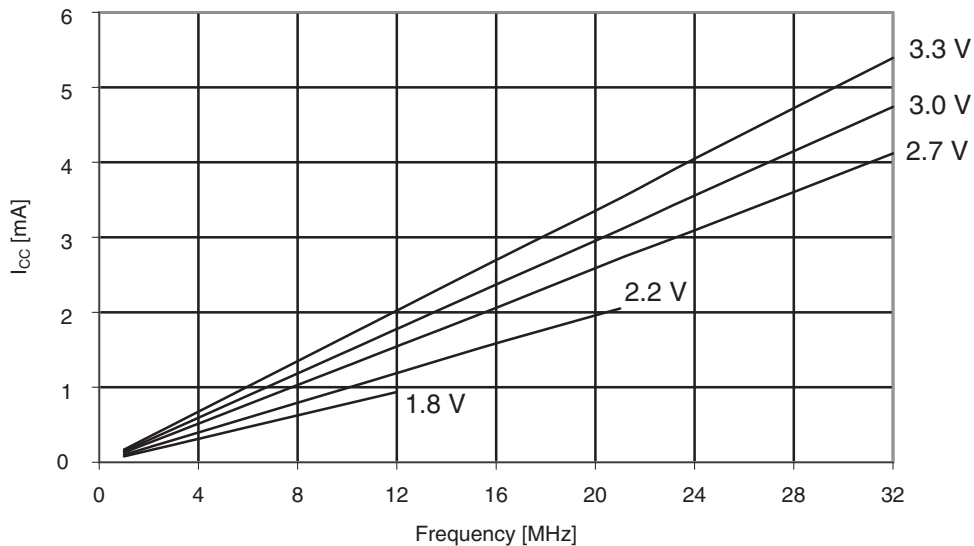

Figure 35-10. Idle Supply Current vs. Vcc

$f_{SYS} = 1.0 \text{ MHz External Clock}.$

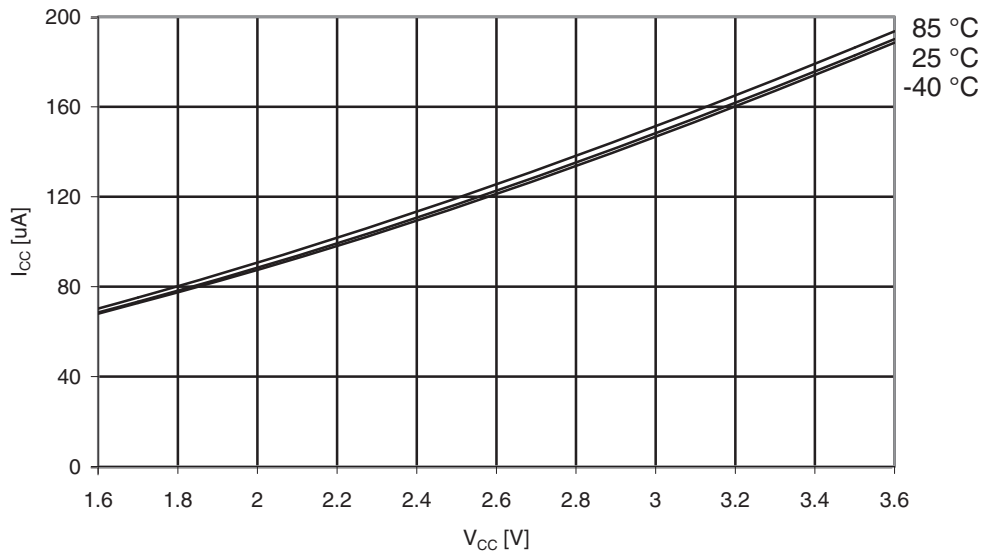

Figure 35-11. Idle Supply Current vs. Vcc

f_{SYS} = 32.768 kHz internal RC.

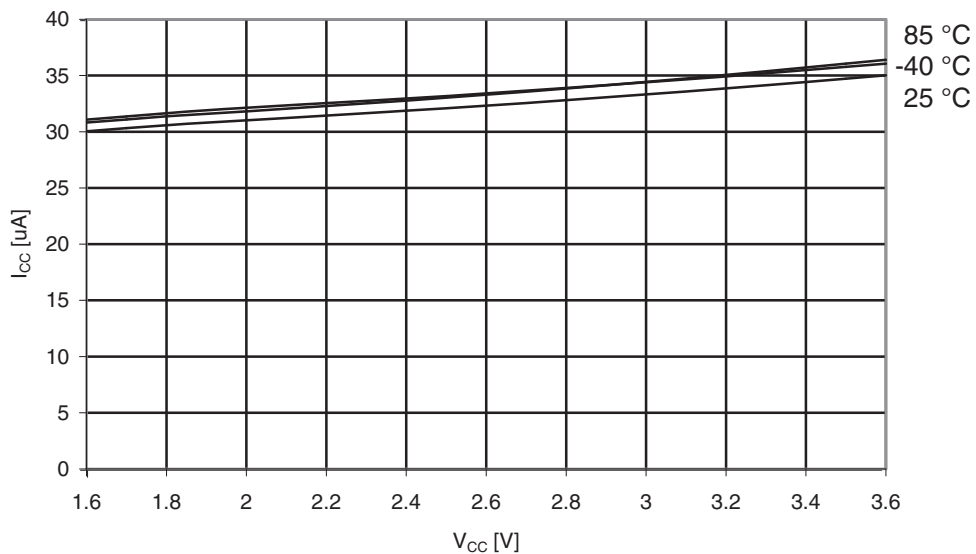

Figure 35-12. Idle Supply Current vs. Vcc

f_{SYS} = 2.0 MHz internal RC.

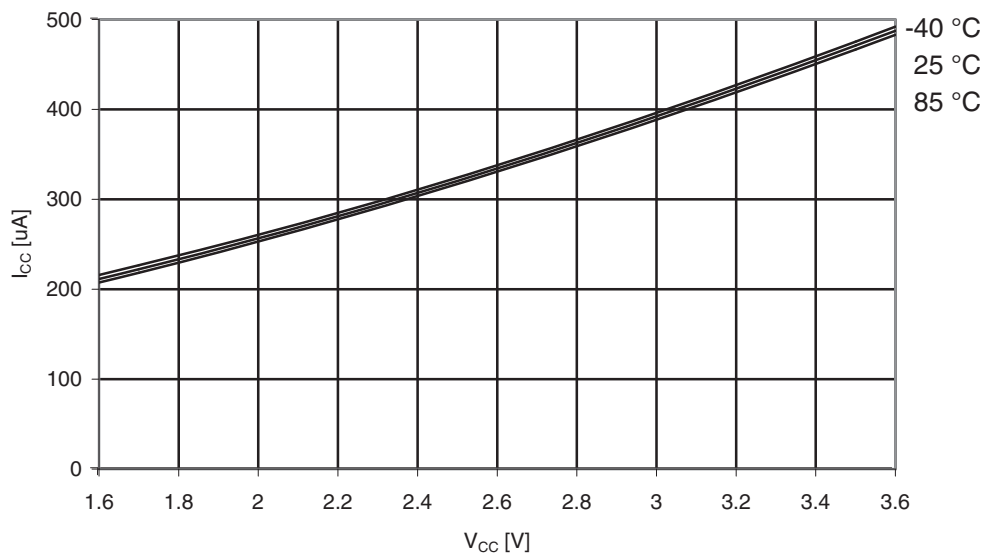

Figure 35-13. Idle Supply Current vs. V_{CC}

f_{SYS} = 32 MHz internal RC prescaled to 8 MHz.

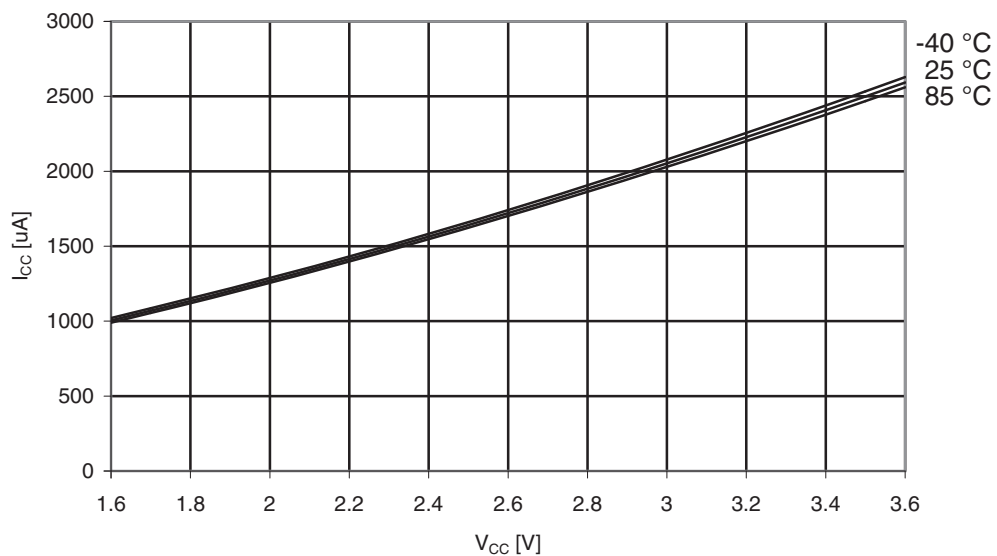
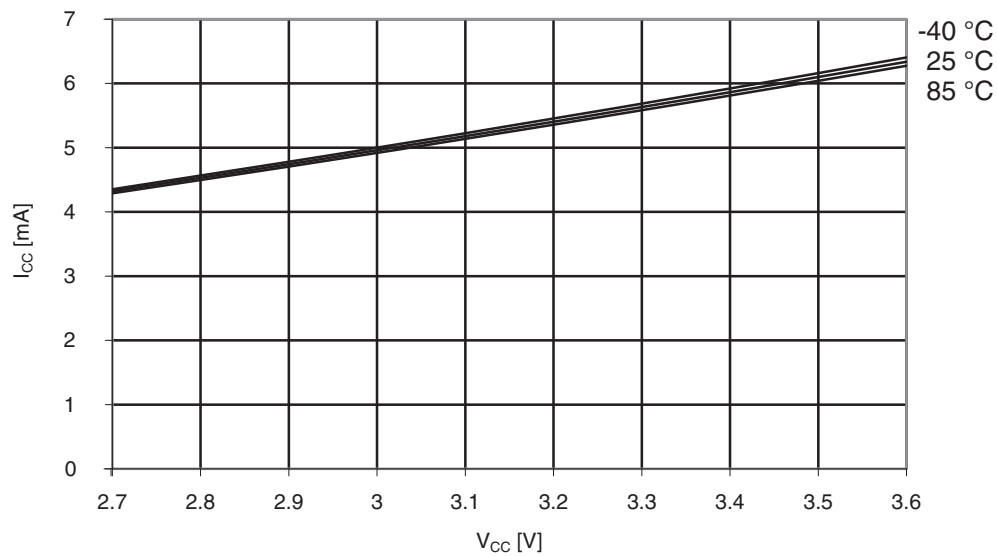

Figure 35-14. Idle Supply Current vs. V_{CC}

f_{SYS} = 32 MHz internal RC.



35.3 Power-down Supply Current

Figure 35-15. Power-down Supply Current vs. Temperature

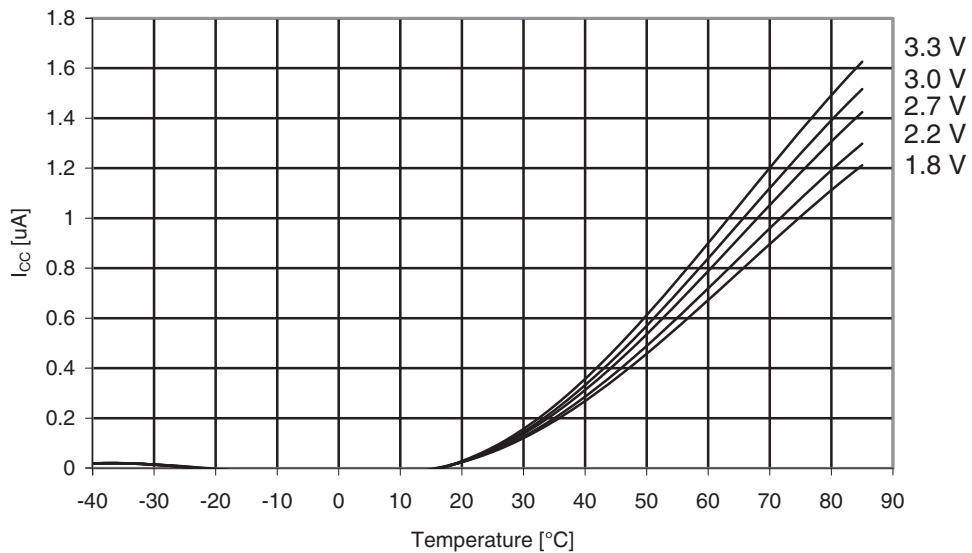
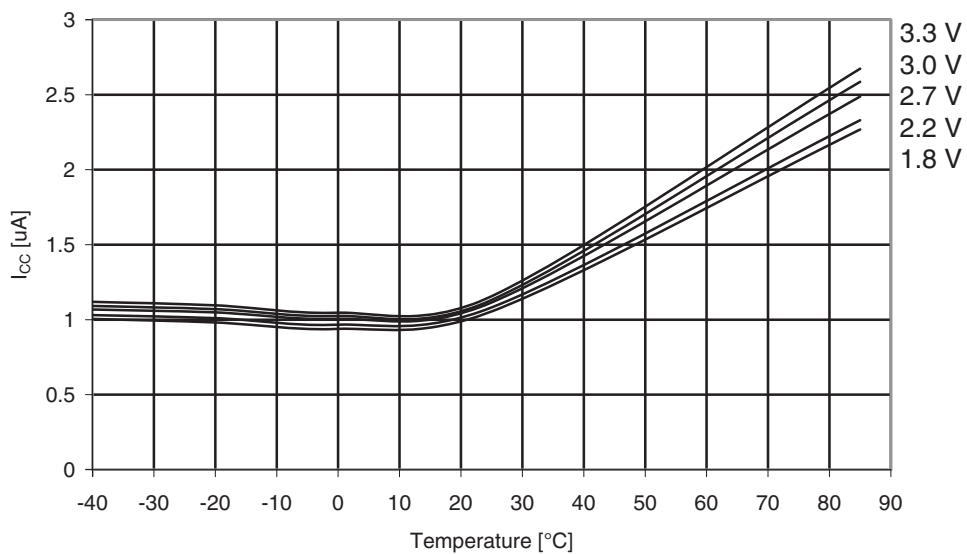
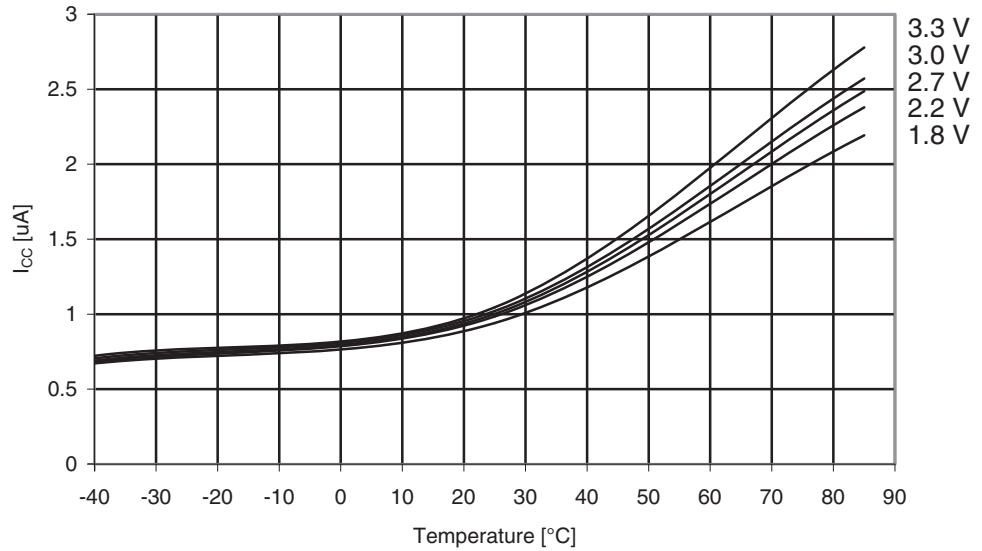

Figure 35-16. Power-down Supply Current vs. Temperature
With WDT and sampled BOD enabled.



35.4 Power-save Supply Current

Figure 35-17. Power-save Supply Current vs. Temperature
 With WDT, sampled BOD and RTC from ULP enabled.



35.5 Pin Pull-up

Figure 35-18. Reset Pull-up Resistor Current vs. Reset Pin Voltage
 $V_{CC} = 1.8V$.

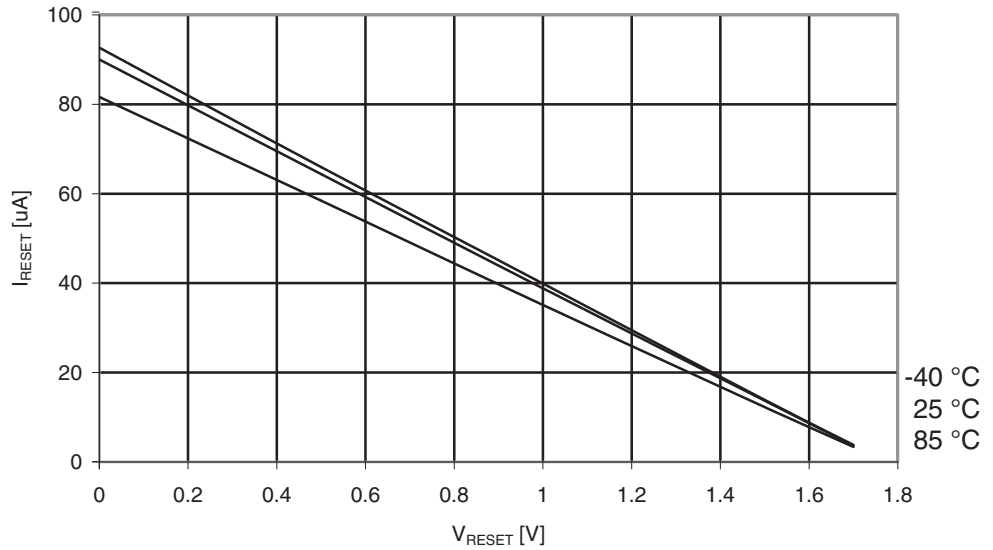

Figure 35-19. Reset Pull-up Resistor Current vs. Reset Pin Voltage

$V_{CC} = 3.0V.$

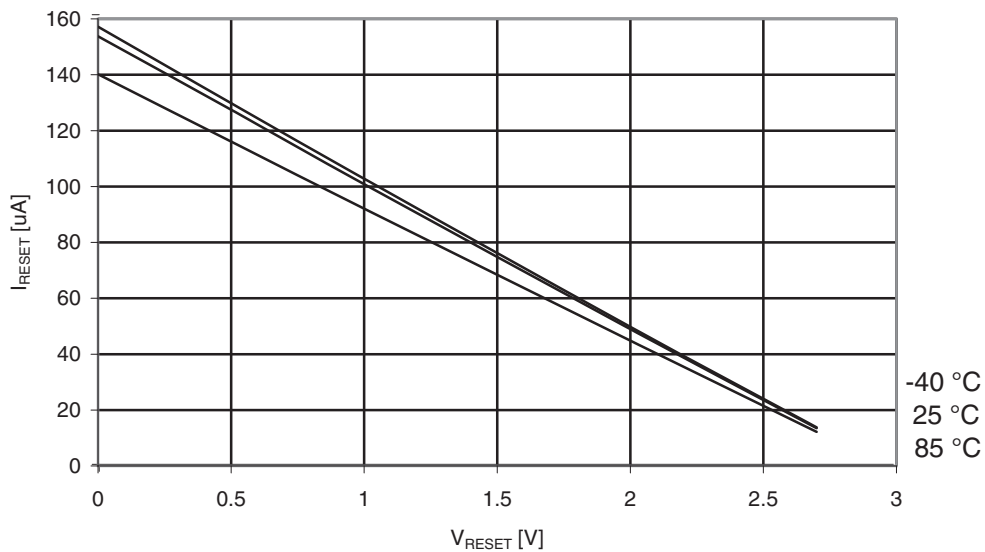
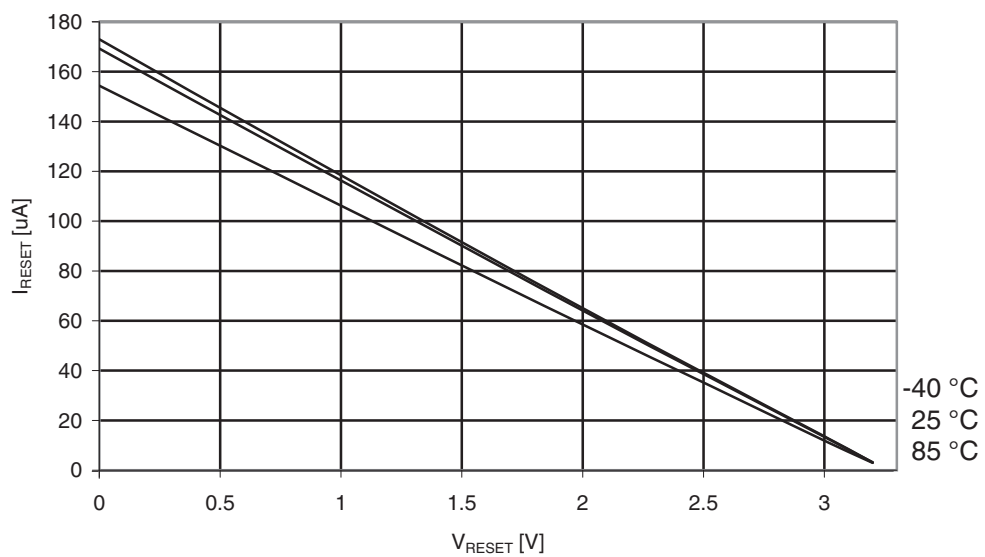

Figure 35-20. Reset Pull-up Resistor Current vs. Reset Pin Voltage

$V_{CC} = 3.3V.$



35.6 Pin Output Voltage vs. Sink/Source Current

Figure 35-21. I/O Pin Output Voltage vs. Source Current

$V_{CC} = 1.8V$.

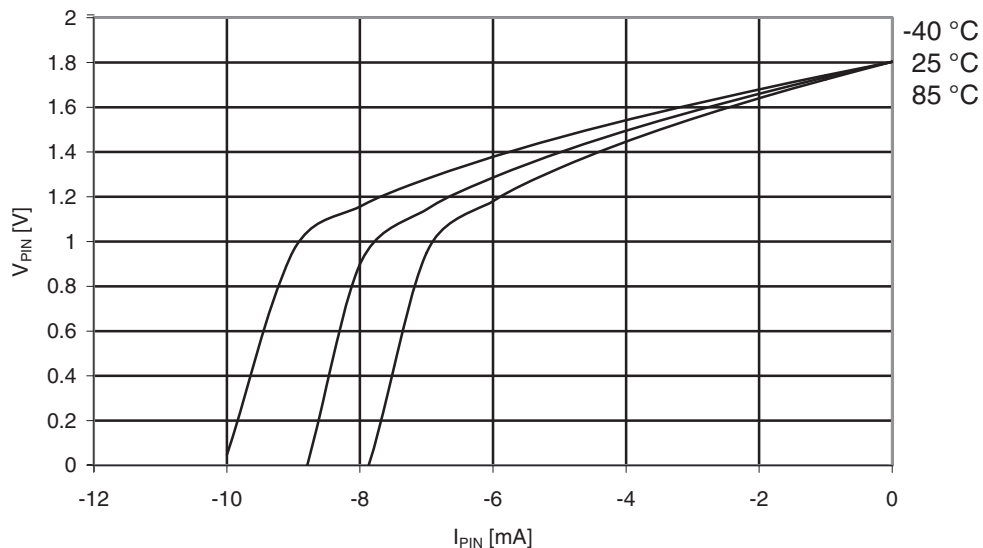

Figure 35-22. I/O Pin Output Voltage vs. Source Current

$V_{CC} = 3.0V$.

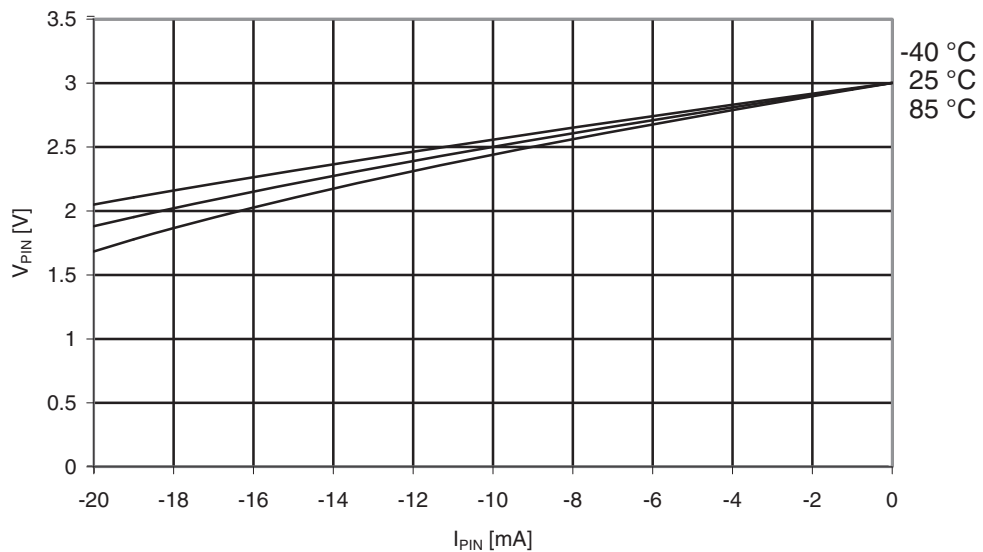

Figure 35-23. I/O Pin Output Voltage vs. Source Current

$V_{CC} = 3.3V$.

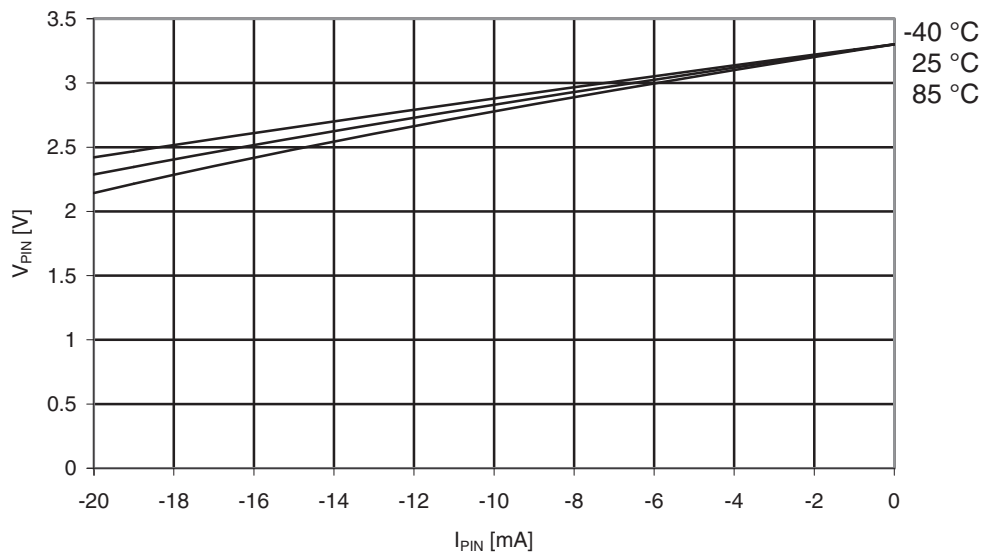

Figure 35-24. I/O Pin Output Voltage vs. Sink Current

$V_{CC} = 1.8V$.

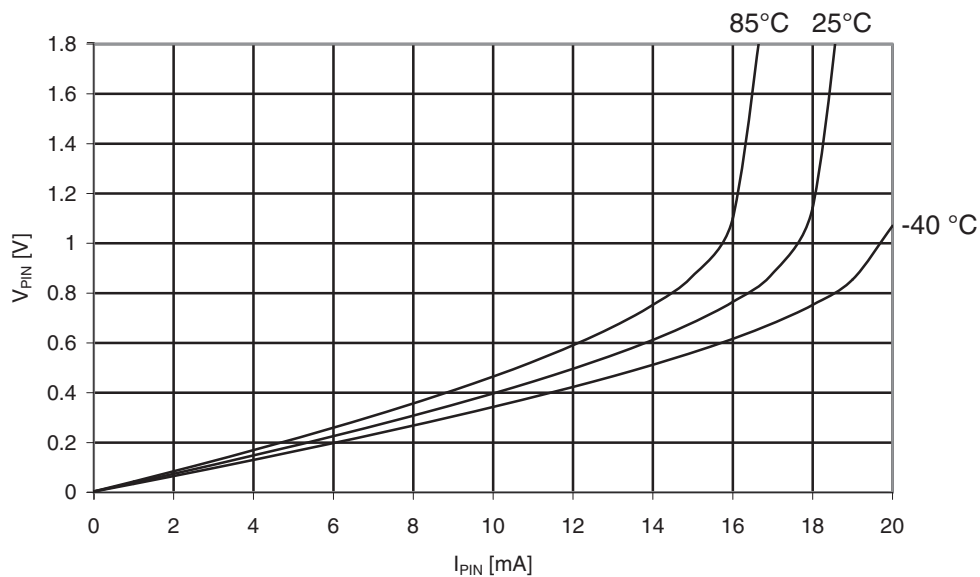

Figure 35-25. I/O Pin Output Voltage vs. Sink Current

$V_{CC} = 3.0V$.

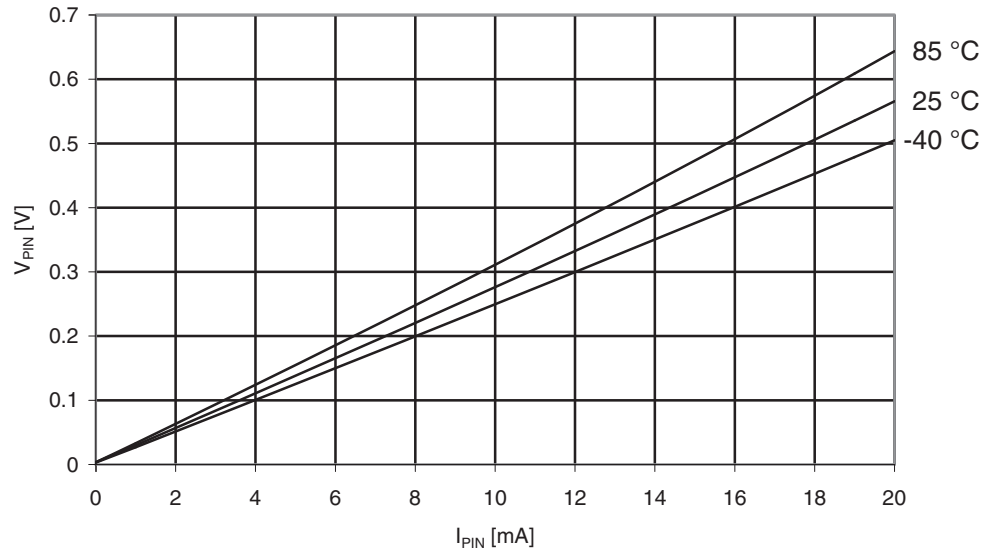
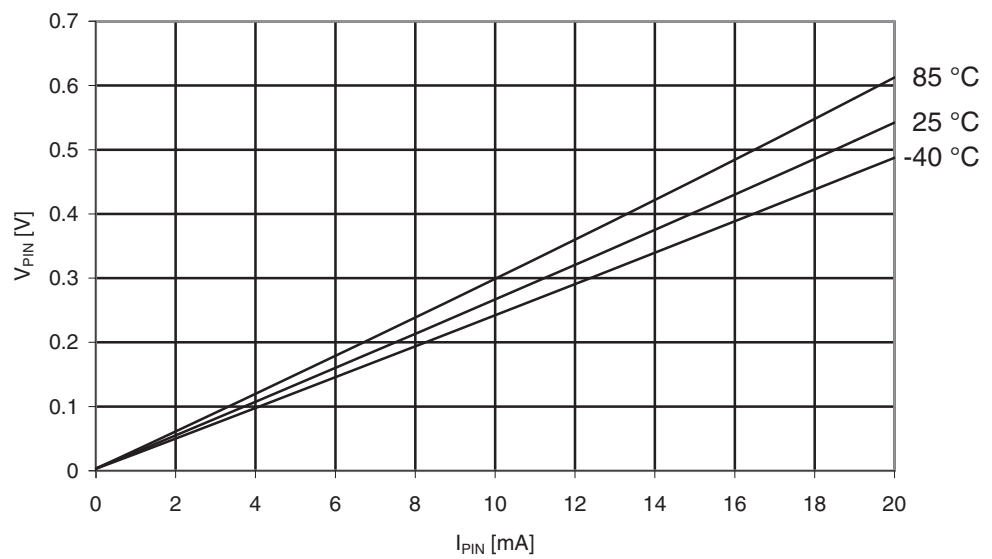

Figure 35-26. I/O Pin Output Voltage vs. Sink Current

$V_{CC} = 3.3V$.



35.7 Pin Thresholds and Hysteresis

Figure 35-27. I/O Pin Input Threshold Voltage vs. V_{CC}

V_{IH} - I/O Pin Read as "1".

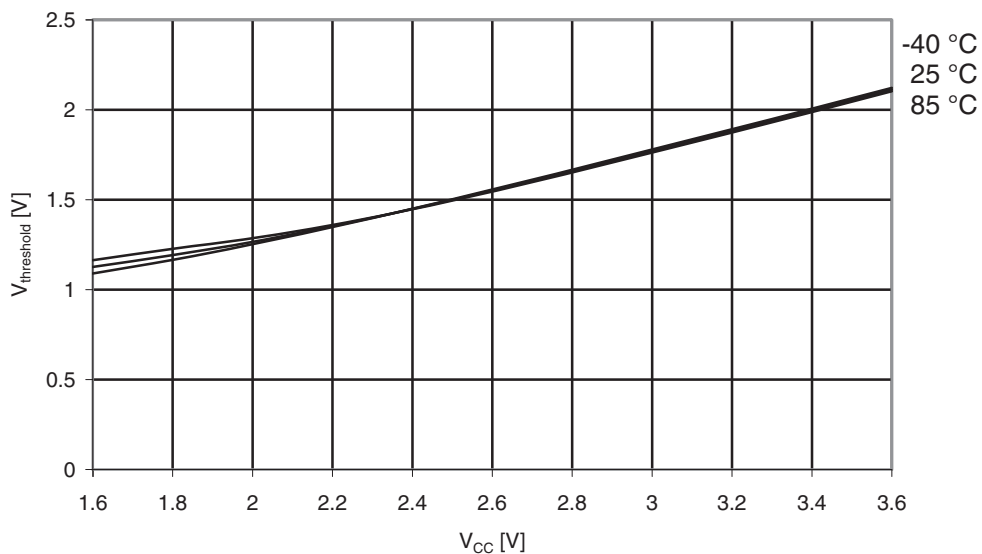

Figure 35-28. I/O Pin Input Threshold Voltage vs. V_{CC}

V_{IL} - I/O Pin Read as "0".

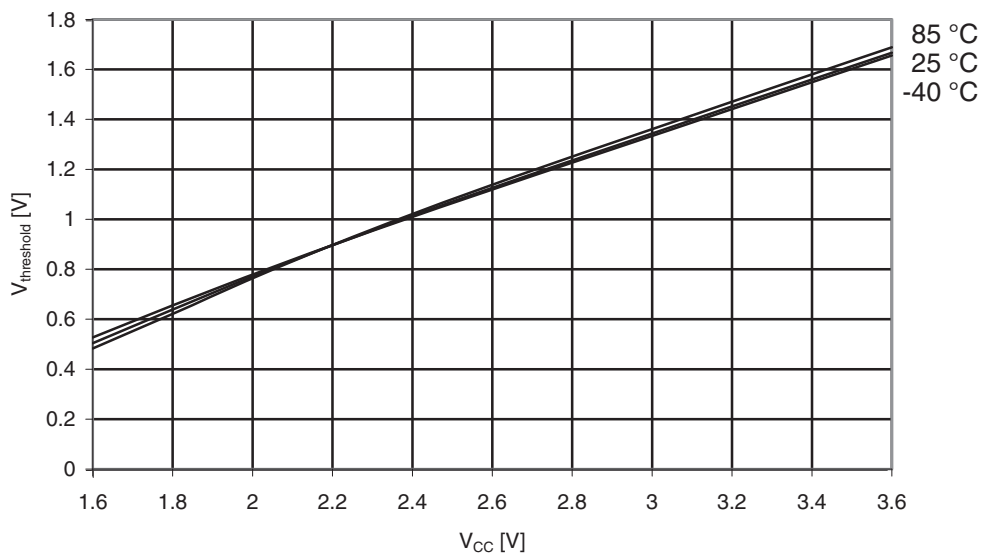

Figure 35-29. I/O Pin Input Hysteresis vs. V_{CC} .

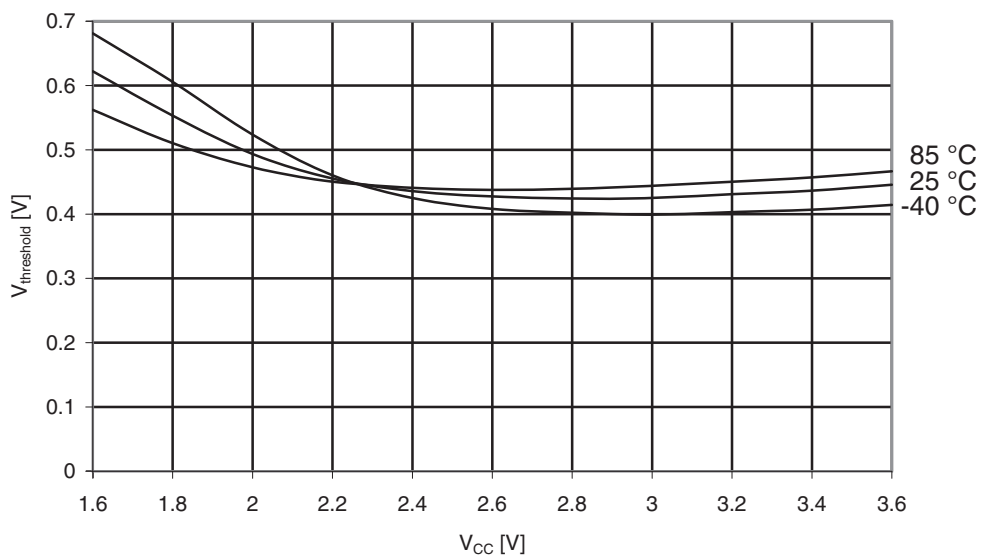

Figure 35-30. Reset Input Threshold Voltage vs. V_{CC}

V_{IH} - I/O Pin Read as "1".

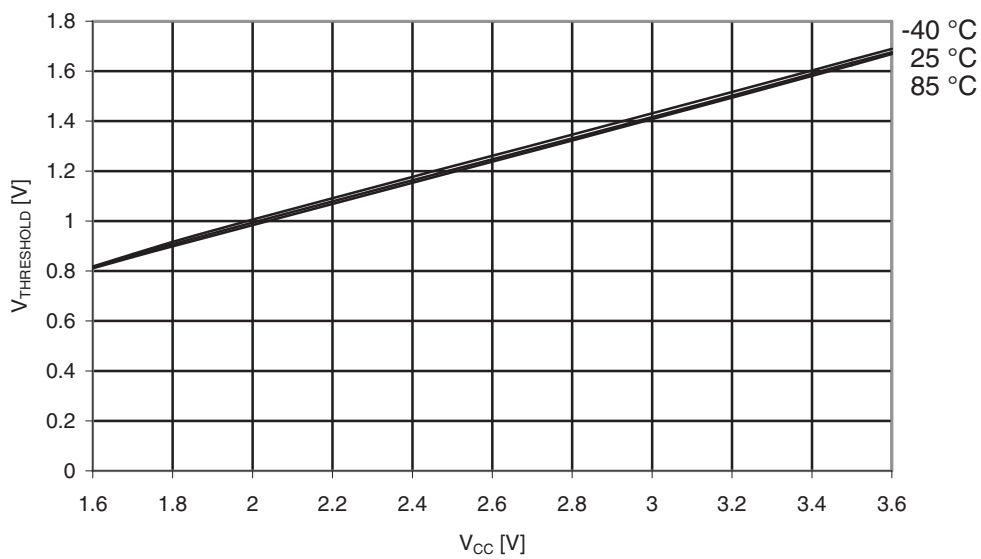
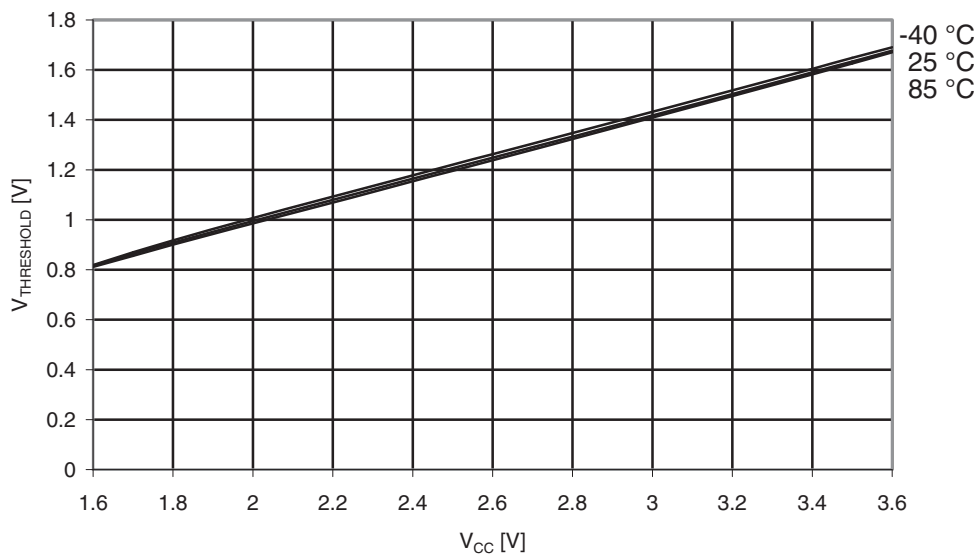

Figure 35-31. Reset Input Threshold Voltage vs. V_{CC}

V_{IL} - I/O Pin Read as "0".



35.8 Bod Thresholds

Figure 35-32. BOD Thresholds vs. Temperature

BOD Level = 1.6V.

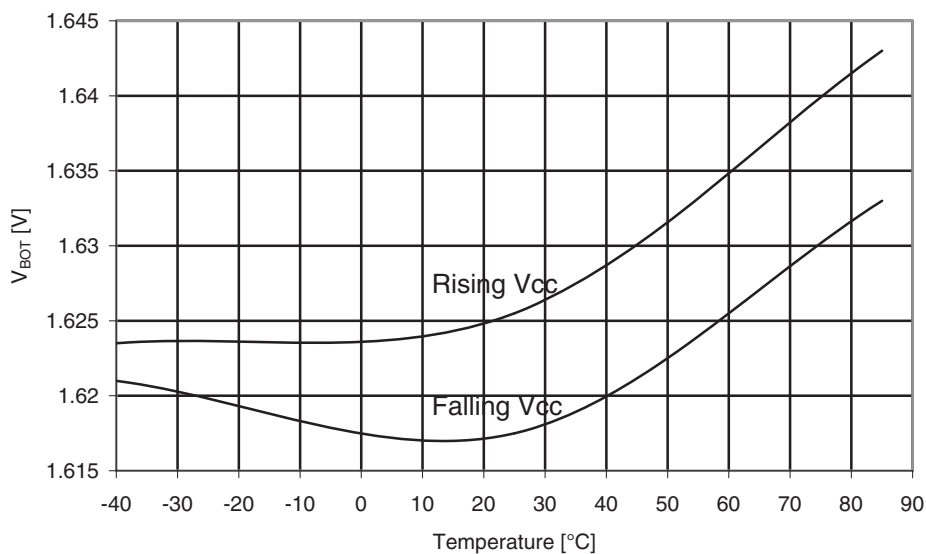
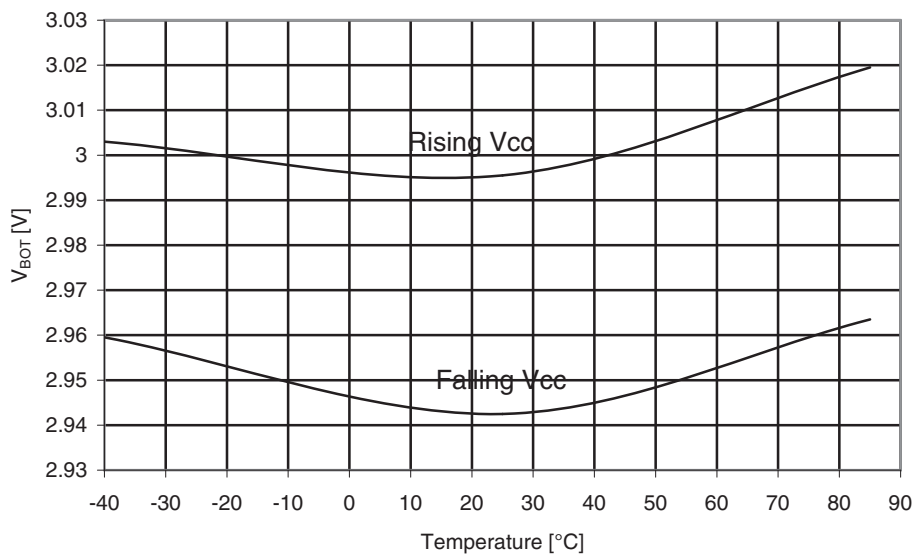

Figure 35-33. BOD Thresholds vs. Temperature

BOD Level = 2.9V.



35.9 Analog Comparator

Figure 35-34. Analog Comparator Hysteresis vs. V_{CC}

High-speed, Small hysteresis.

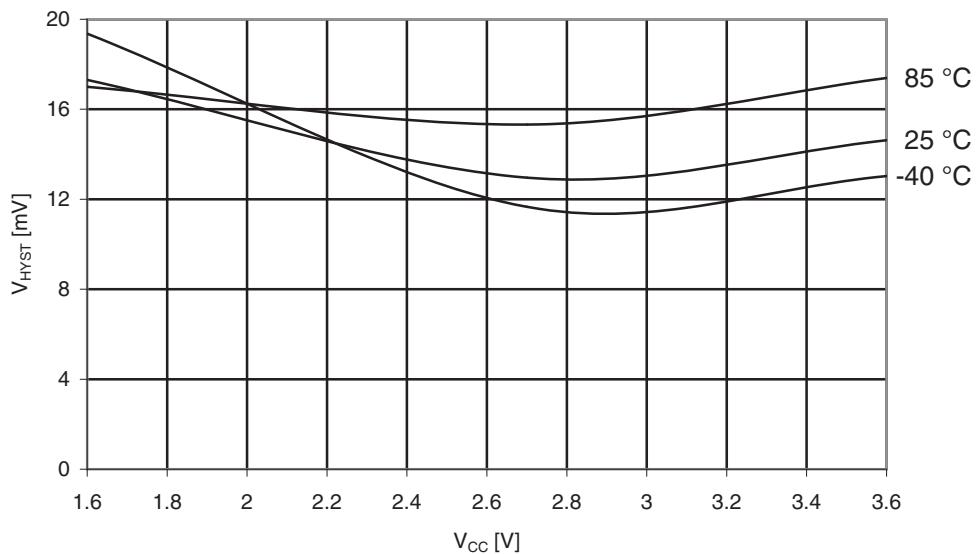

Figure 35-35. Analog Comparator Hysteresis vs. V_{CC}
High-speed, Large hysteresis.

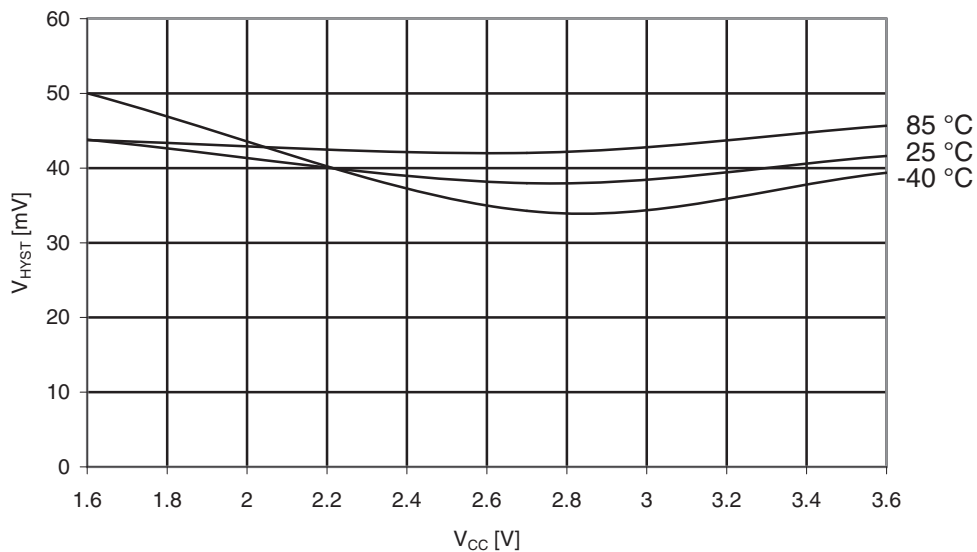
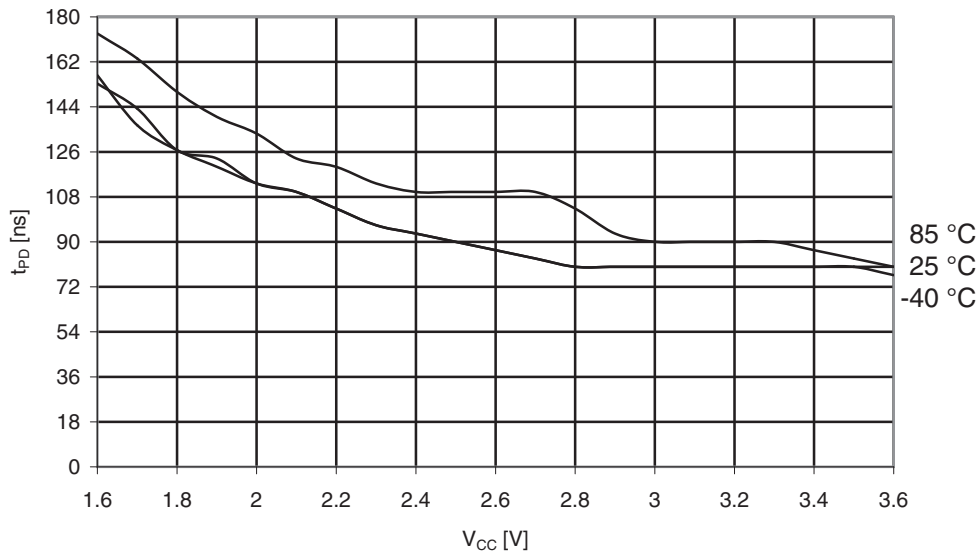

Figure 35-36. Analog Comparator Propagation Delay vs. V_{CC}
High-speed.



35.10 Oscillators and Wake-up Time

35.10.1 Internal 32.768 kHz Oscillator

Figure 35-37. Internal 32.768 kHz Oscillator Calibration Step Size

$T = -40$ to 85°C , $V_{CC} = 3\text{V}$.

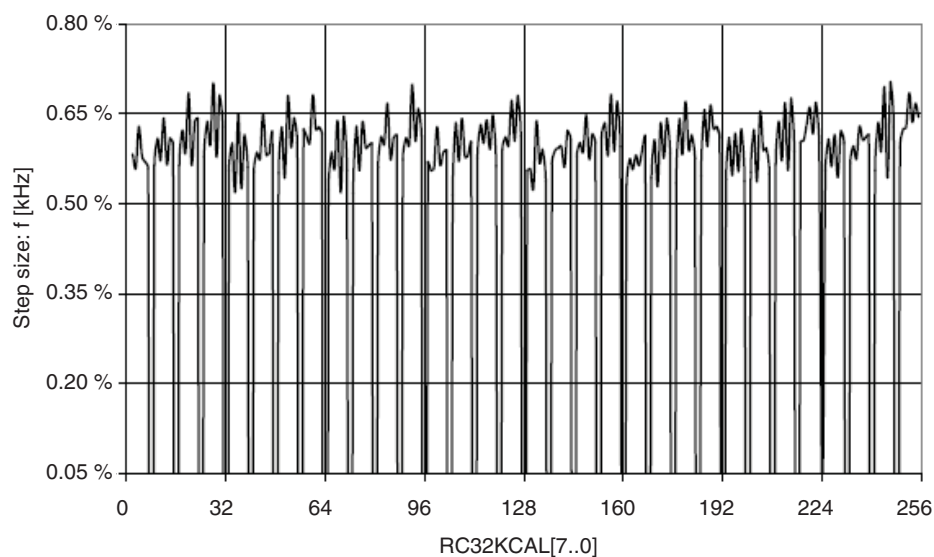

35.10.2 Internal 2 MHz Oscillator

Figure 35-38. Internal 2 MHz Oscillator CALA Calibration Step Size

$T = -40$ to 85°C , $V_{CC} = 3\text{V}$.

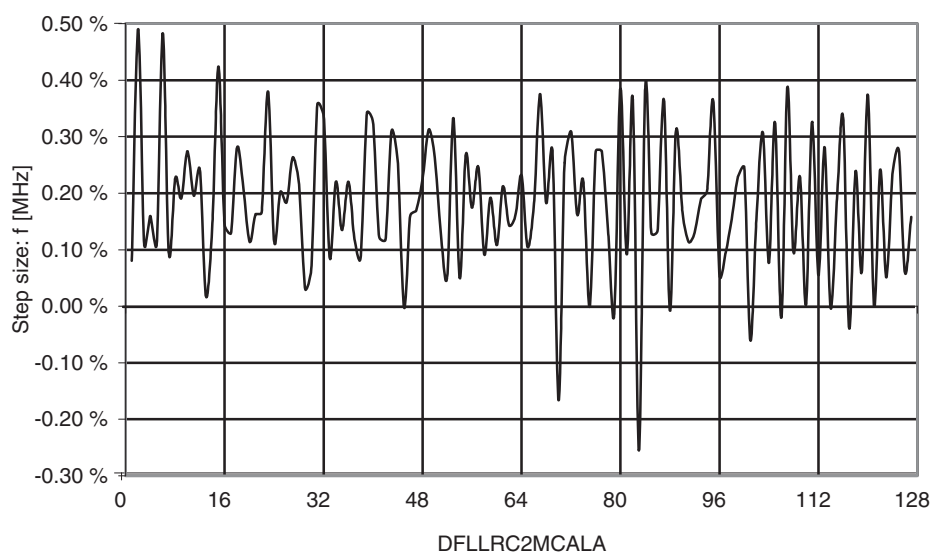
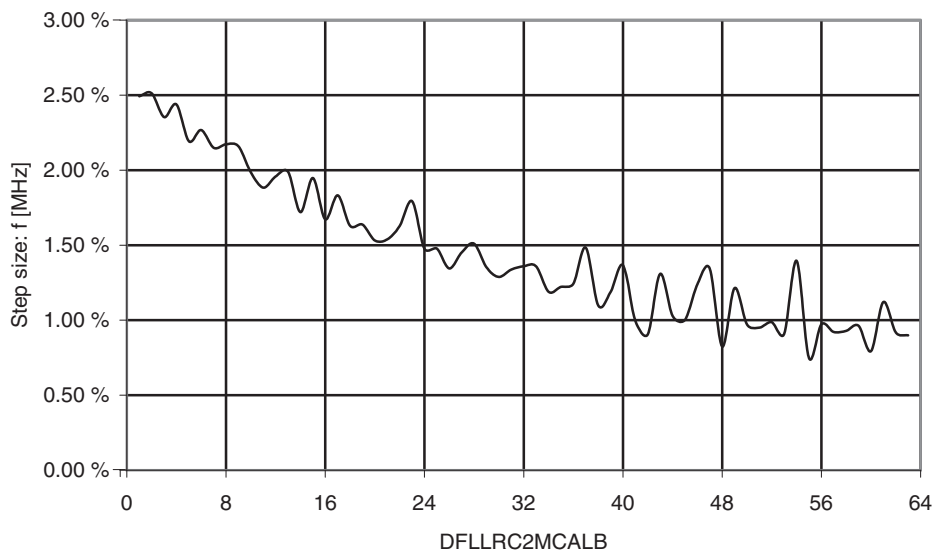

Figure 35-39. Internal 2 MHz Oscillator CALB Calibration Step Size

T = -40 to 85°C, V_{CC} = 3V.



35.10.3 Internal 32 MHz Oscillator

Figure 35-40. Internal 32 MHz Oscillator CALA Calibration Step Size

T = -40 to 85°C, V_{CC} = 3V.

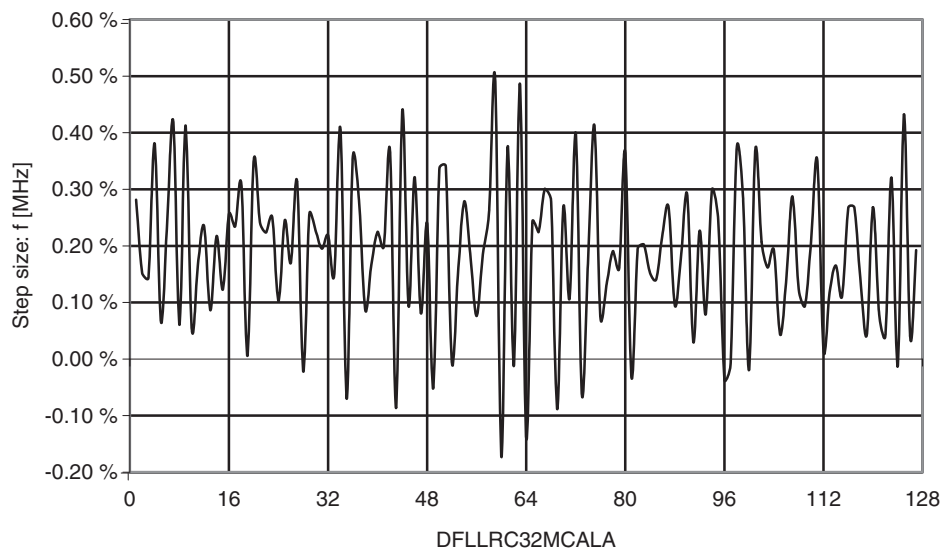
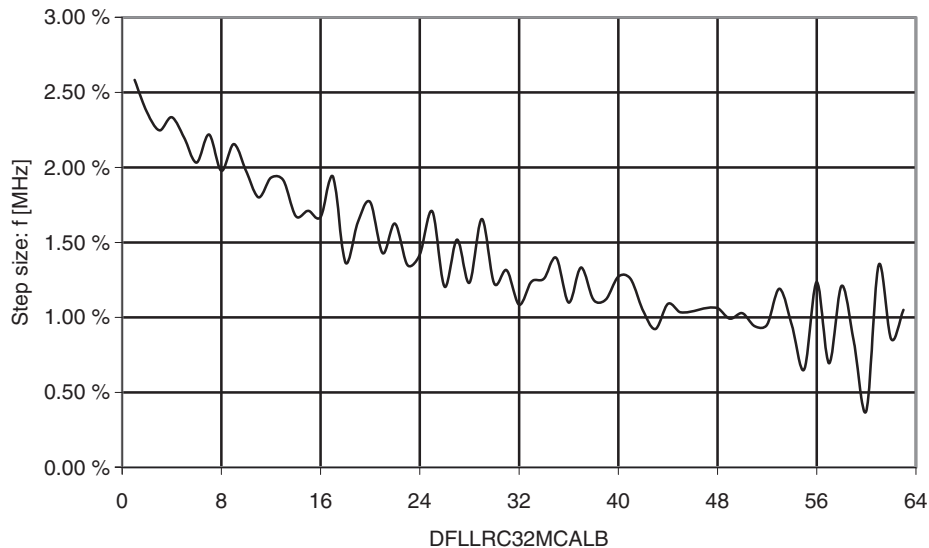

Figure 35-41. Internal 32 MHz Oscillator CALB Calibration Step Size

T = -40 to 85°C, V_{CC} = 3V.



35.11 Module current consumption

Figure 35-42. AC current consumption vs. V_{CC}

Low-power Mode.

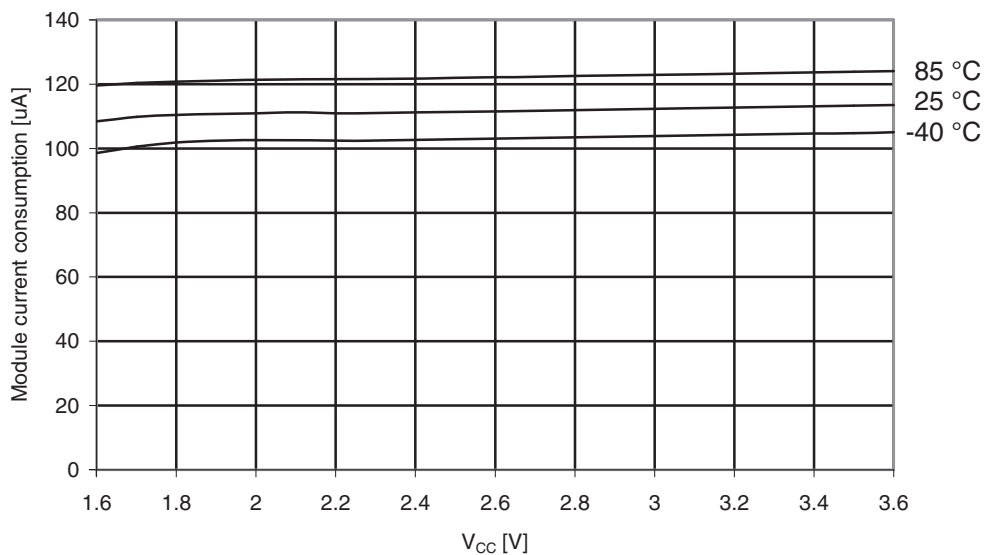
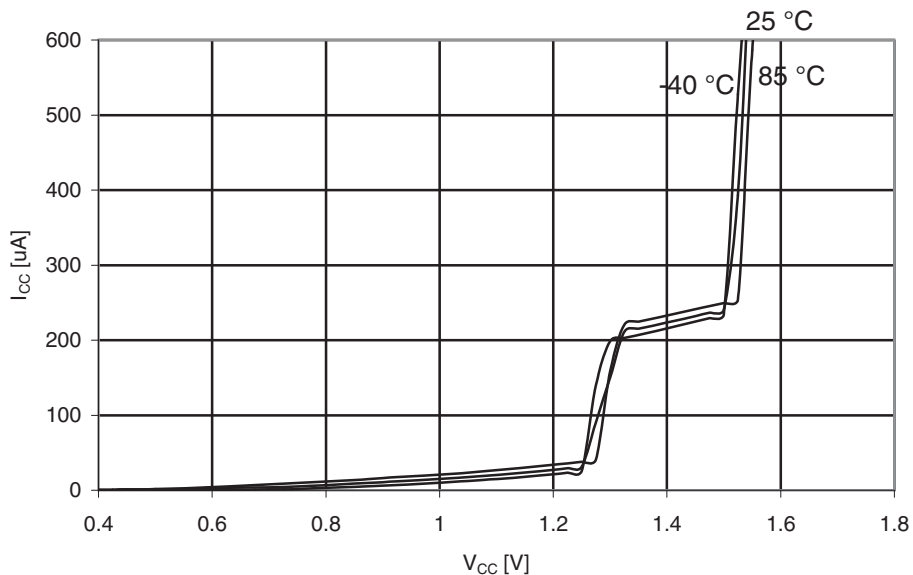
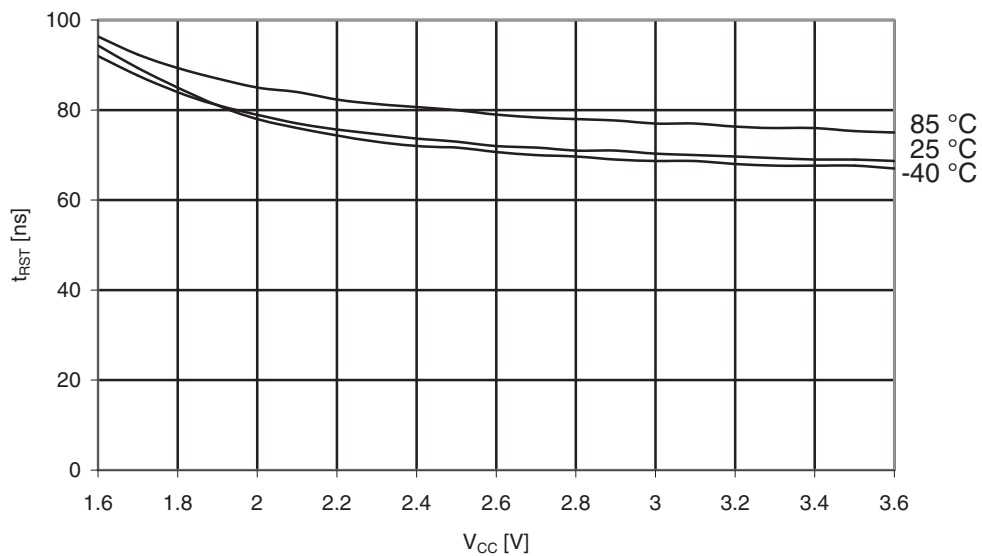

Figure 35-43. Power-up current consumption vs. V_{CC}



35.12 Reset Pulsewidth

Figure 35-44. Minimum Reset Pulse Width vs. V_{CC}



35.13 PDI Speed

Figure 35-45. PDI Speed vs. V_{CC}

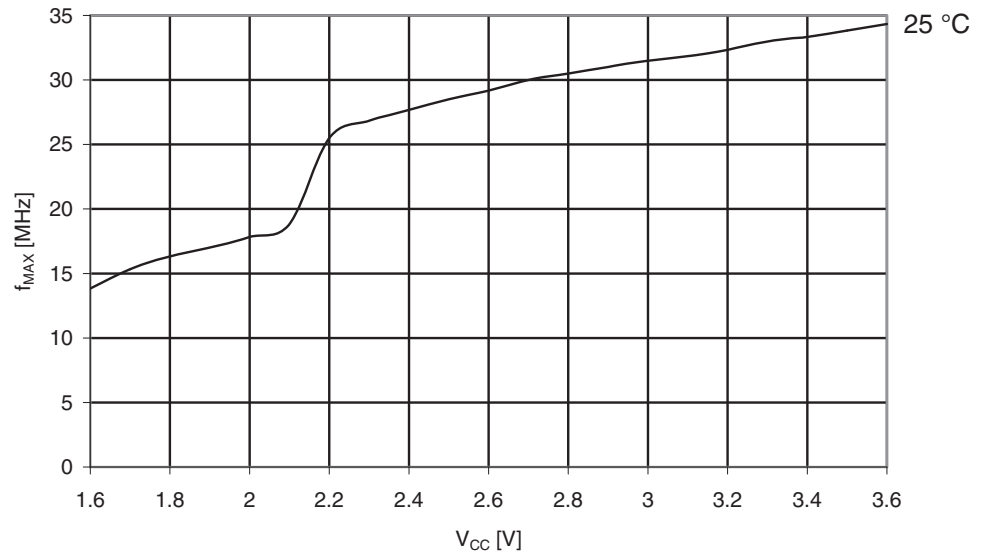

36. Errata

36.1 ATxmega16A4, ATxmega32A4

36.1.1 rev. A/B

- Bandgap voltage input for the ACs can not be changed when used for both ACs simultaneously
- VCC voltage scaler for AC is non-linear
- ADC has increased INL error for some operating conditions
- ADC gain stage output range is limited to 2.4 V
- ADC Event on compare match non-functional
- Bandgap measurement with the ADC is non-functional when VCC is below 2.7V
- Accuracy lost on first three samples after switching input to ADC gain stage
- Configuration of PGM and CWCM not as described in XMEGA A Manual
- PWM is not restarted properly after a fault in cycle-by-cycle mode
- BOD: BOD will be enabled at any reset
- Sampled BOD in Active mode will cause noise when bandgap is used as reference
- DAC is nonlinear and inaccurate when reference is above 2.4V or VCC - 0.6V
- DAC has increased INL or noise for some operating conditions
- EEPROM page buffer always written when NVM DATA0 is written
- Pending full asynchronous pin change interrupts will not wake the device
- Pin configuration does not affect Analog Comparator Output
- NMI Flag for Crystal Oscillator Failure automatically cleared
- Flash Power Reduction Mode can not be enabled when entering sleep
- Crystal start-up time required after power-save even if crystal is source for RTC
- RTC Counter value not correctly read after sleep
- Pending asynchronous RTC-interrupts will not wake up device
- TWI Transmit collision flag not cleared on repeated start
- Clearing TWI Stop Interrupt Flag may lock the bus
- TWI START condition at bus timeout will cause transaction to be dropped
- TWI Data Interrupt Flag (DIF) erroneously read as set
- WDR instruction inside closed window will not issue reset

1. Bandgap voltage input for the ACs cannot be changed when used for both ACs simultaneously

If the Bandgap voltage is selected as input for one Analog Comparator (AC) and then selected/deselected as input for another AC, the first comparator will be affected for up to 1 μ s and could potentially give a wrong comparison result.

Problem fix/Workaround

If the Bandgap is required for both ACs simultaneously, configure the input selection for both ACs before enabling any of them.

2. VCC voltage scaler for AC is non-linear

The 6-bit VCC voltage scaler in the Analog Comparators is non-linear.

Figure 36-1. Analog Comparator Voltage Scaler vs. Scalefac
 $T = 25^{\circ}\text{C}$



Problem fix/Workaround

Use external voltage input for the analog comparator if accurate voltage levels are needed

3. ADC has increased INL error for some operating conditions

Some ADC configurations or operating condition will result in increased INL error.

In signed mode INL is increased to:

- 6LSB for sample rates above 1Msps, and up to 8 LSB for 2Msps sample rate.
- 6LSB for reference voltage below 1.1V when VCC is above 3.0V.
- 20LSB for ambient temperature below 0 degree C and reference voltage below 1.3V.

In unsigned mode, the INL error cannot be guaranteed, and this mode should not be used.

Problem fix/Workaround

None, avoid using the ADC in the above configurations in order to prevent increased INL error. Use the ADC in signed mode also for single ended measurements.

4. ADC gain stage output range is limited to 2.4 V

The amplified output of the ADC gain stage will never go above 2.4 V, hence the differential input will only give correct output when below 2.4 V/gain. For the available gain settings, this gives a differential input range of:

- 1x gain: 2.4 V
- 2x gain: 1.2 V
- 4x gain: 0.6 V
- 8x gain: 300 mV
- 16x gain: 150 mV
- 32x gain: 75 mV
- 64x gain: 38 mV

Problem fix/Workaround

Keep the amplified voltage output from the ADC gain stage below 2.4 V in order to get a correct result, or keep ADC voltage reference below 2.4 V.

5. ADC Event on compare match non-functional

ADC signalling event will be given at every conversion complete even if Interrupt mode (INT-MODE) is set to BELOW or ABOVE.

Problem fix/Workaround

Enable and use interrupt on compare match when using the compare function.

6. Bandgap measurement with the ADC is non-functional when VCC is below 2.7V

The ADC can not be used to do bandgap measurements when VCC is below 2.7V.

Problem fix/Workaround

None.

7. Accuracy lost on first three samples after switching input to ADC gain stage

Due to memory effect in the ADC gain stage, the first three samples after changing input channel must be disregarded to achieve 12-bit accuracy.

Problem fix/Workaround

Run three ADC conversions and discard these results after changing input channels to ADC gain stage.

8. Configuration of PGM and CWCM not as described in XMEGA A Manual

Enabling Common Waveform Channel Mode will enable Pattern generation mode (PGM), but not Common Waveform Channel Mode.

Enabling Pattern Generation Mode (PGM) and not Common Waveform Channel Mode (CWCM) will enable both Pattern Generation Mode and Common Waveform Channel Mode.

Problem fix/Workaround

Table 36-1. Configure PWM and CWCM according to this table:

PGM	CWCM	Description
0	0	PGM and CWCM disabled
0	1	PGM enabled
1	0	PGM and CWCM enabled
1	1	PGM enabled

9. PWM is not restarted properly after a fault in cycle-by-cycle mode

When the AWeX fault restore mode is set to cycle-by-cycle, the waveform output will not return to normal operation at first update after fault condition is no longer present.

Problem fix/Workaround

Do a write to any AWeX I/O register to re-enable the output.

10. BOD will be enabled after any reset

If any reset source goes active, the BOD will be enabled and keep the device in reset if the VCC voltage is below the programmed BOD level. During Power-On Reset, reset will not be released until VCC is above the programmed BOD level even if the BOD is disabled.

Problem fix/Workaround

Do not set the BOD level higher than VCC even if the BOD is not used.

11. Sampled BOD in Active mode will cause noise when bandgap is used as reference

Using the BOD in sampled mode when the device is running in Active or Idle mode will add noise on the bandgap reference for ADC, DAC and Analog Comparator.

Problem fix/Workaround

If the bandgap is used as reference for either the ADC, DAC or the Analog Comparator, the BOD must not be set in sampled mode.

12. DAC is nonlinear and inaccurate when reference is above 2.4V or VCC - 0.6V

Using the DAC with a reference voltage above 2.4V or VCC - 0.6V will give inaccurate output when converting codes that give below 0.75V output:

- ± 10 LSB for continuous mode
- ± 200 LSB for Sample and Hold mode

Problem fix/Workaround

None.

13. DAC has increased INL or noise for some operating conditions

Some DAC configurations or operating condition will result in increased output error.

- Continuous mode: ± 5 LSB
- Sample and hold mode: ± 15 LSB
- Sample and hold mode for reference above 2.0v: up to ± 100 LSB

Problem fix/Workaround

None.

14. EEPROM page buffer always written when NVM DATA0 is written

If the EEPROM is memory mapped, writing to NVM DATA0 will corrupt data in the EEPROM page buffer.

Problem fix/Workaround

Before writing to NVM DATA0, for example when doing software CRC or flash page buffer write, check if EEPROM page buffer active loading flag (EELOAD) is set. Do not write NVM DATA0 when EELOAD is set.

15. Pending full asynchronous pin change interrupts will not wake the device

Any full asynchronous pin-change Interrupt from pin 2, on any port, that is pending when the sleep instruction is executed, will be ignored until the device is woken from another source or the source triggers again. This applies when entering all sleep modes where the System Clock is stopped.

Problem fix/Workaround

None.

16. Pin configuration does not affect Analog Comparator output

The Output/Pull and inverted pin configuration does not affect the Analog Comparator output.

Problem fix/Workaround

None for Output/Pull configuration.

For inverted I/O, configure the Analog Comparator to give an inverted result (i.e. connect positive input to the negative AC input and vice versa), or use an external inverter to change polarity of Analog Comparator output.

17. NMI Flag for Crystal Oscillator Failure automatically cleared

NMI flag for Crystal Oscillator Failure (XOSCFDIF) will be automatically cleared when executing the NMI interrupt handler.

Problem fix/Workaround

This device revision has only one NMI interrupt source, so checking the interrupt source in software is not required.

18. Flash Power Reduction Mode can not be enabled when entering sleep

If Flash Power Reduction Mode is enabled when entering Power-save or Extended Standby sleep mode, the device will only wake up on every fourth wake-up request. If Flash Power Reduction Mode is enabled when entering Idle sleep mode, the wake-up time will vary with up to 16 CPU clock cycles.

Problem fix/Workaround

Disable Flash Power Reduction mode before entering sleep mode.

19. Crystal start-up time required after power-save even if crystal is source for RTC

Even if 32.768 kHz crystal is used for RTC during sleep, the clock from the crystal will not be ready for the system before the specified start-up time. See "XOSCSEL[3:0]: Crystal Oscillator Selection" in XMEGA A Manual. If BOD is used in active mode, the BOD will be on during this period (0.5s).

Problem fix/Workaround

If faster start-up is required, go to sleep with internal oscillator as system clock.

20. RTC Counter value not correctly read after sleep

If the RTC is set to wake up the device on RTC Overflow and bit 0 of RTC CNT is identical to bit 0 of RTC PER as the device is entering sleep, the value in the RTC count register can not be read correctly within the first prescaled RTC clock cycle after wakeup. The value read will be the same as the value in the register when entering sleep.

The same applies if RTC Compare Match is used as wake-up source.

Problem fix/Workaround

Wait at least one prescaled RTC clock cycle before reading the RTC CNT value.

21. Pending asynchronous RTC-interrupts will not wake up device

Asynchronous Interrupts from the Real-Time-Counter that is pending when the sleep instruction is executed, will be ignored until the device is woken from another source or the source triggers again.

Problem fix/Workaround

None.

22. TWI Transmit collision flag not cleared on repeated start

The TWI transmit collision flag should be automatically cleared on start and repeated start, but is only cleared on start.

Problem fix/Workaround

Clear the flag in software after address interrupt.

23. Clearing TWI Stop Interrupt Flag may lock the bus

If software clears the STOP Interrupt Flag (APIF) on the same Peripheral Clock cycle as the hardware sets this flag due to a new address received, CLKHOLD is not cleared and the SCL line is not released. This will lock the bus.

Problem fix/Workaround

Check if the bus state is IDLE. If this is the case, it is safe to clear APIF. If the bus state is not IDLE, wait for the SCL pin to be low before clearing APIF.

Code:

```

/* Only clear the interrupt flag if within a "safe zone". */
while ( /* Bus not IDLE: */
        ((COMMS_TWI.MASTER.STATUS & TWI_MASTER_BUSSTATE_gm) !=
         TWI_MASTER_BUSSTATE_IDLE_gc) &&
        /* SCL not held by slave: */
        !(COMMS_TWI.SLAVE.STATUS & TWI_SLAVE_CLKHOLD_bm)
      )
{
    /* Ensure that the SCL line is low */
    if ( !(COMMS_PORT.IN & PIN1_bm) )
        if ( !(COMMS_PORT.IN & PIN1_bm) )
            break;
}
/* Check for an pending address match interrupt */
if ( !(COMMS_TWI.SLAVE.STATUS & TWI_SLAVE_CLKHOLD_bm) )
{
    /* Safely clear interrupt flag */
    COMMS_TWI.SLAVE.STATUS |= (uint8_t)TWI_SLAVE_APIF_bm;
}

```

24. TWI START condition at bus timeout will cause transaction to be dropped

If Bus Timeout is enabled and a timeout occurs on the same Peripheral Clock cycle as a START is detected, the transaction will be dropped.

Problem fix/Workaround

None.

25. TWI Data Interrupt Flag erroneously read as set

When issuing the TWI slave response command CMD=0b11, it takes 1 Peripheral Clock cycle to clear the data interrupt flag (DIF). A read of DIF directly after issuing the command will show the DIF still set.

Problem fix/Workaround

Add one NOP instruction before checking DIF.

26. WDR instruction inside closed window will not issue reset

When a WDR instruction is execute within one ULP clock cycle after updating the window control register, the counter can be cleared without giving a system reset.

Problem fix/Workaround

Wait at least one ULP clock cycle before executing a WDR instruction.

37. Datasheet Revision History

Please note that the referring page numbers in this section are referred to this document. The referring revisions in this section are referring to the document revision.

37.1 8069R – 06/13

1. Not recommended for new designs - Use XMEGA A4U series.

37.2 8069Q – 12/10

1. Datasheet status changed to complete: Preliminary removed from the front page.
2. Updated all tables in the "Electrical Characteristics" .
3. Updated "Packaging information" on page 58.
4. Replaced Table 34-11 on page 67.
5. Replaced Table 34-18 on page 69 and added the figure "TOSC input capacitance" on page 69.
7. ERRATA A combined with ERRATA B to ERRATA "rev. A/B" .
8. Updated ERRATA for ADC (ADC has increased INL error for some operating conditions).
9. Updated the last page by Atmel new Brand Style Guide.

37.3 8069P – 09/10

1. Updated "Errata" on page 93.

37.4 8069O – 08/10

1. Updated the Footnote 3 of "Ordering Information" on page 2.
2. Updated "Features" on page 27. Event Channel 0 output on port pin 7.
3. Updated "DC Characteristics" on page 61 by adding I_{CC} for Flash/EEPROM Programming.
4. Added AVCC in "ADC Characteristics" on page 65.
5. Updated Start up time in "ADC Characteristics" on page 65.
6. Updated "DAC Characteristics" on page 66. Removed DC output impedance.
7. Updated and fixed typo in "Errata" section.

37.5 8069N – 02/10

1. Added "PDI Speed" on page 92.

37.6 8069M – 02/10

1. Updated the device pin-out [Figure 2-1 on page 3](#). PDI_CLK and PDI_DATA renamed only PDI.
2. Updated "[Alternate Pin Functions Description](#)" on page 49.
3. Updated "[Alternate Pin Functions](#)" on page 51.
4. Updated "[Timer/Counter and AWEX functions](#)" on page 49.
5. Added [Table 34-18 on page 69](#).
6. Added [Table 34-19 on page 69](#).
7. Changed Internal Oscillator Speed to "[Oscillators and Wake-up Time](#)" on page 88.
8. Updated "[Errata](#)" on page 93.

37.7 8069L – 11/09

1. Updated "[Flash and EEPROM Page Size](#)" on page 14.
2. Updated "[Electrical Characteristics](#)" on page 61 with Max/Min numbers.
3. Added "[Flash and EEPROM Memory Characteristics](#)" on page 64.
4. Updated [Table 34-11 on page 67](#), Input hysteresis is in V and not in mV.

37.8 8069K – 06/09

1. Updated "[Ordering Information](#)" on page 2.
2. Updated "[Errata](#)" on page 93

37.9 8069J – 04/09

1. Updated "[Electrical Characteristics](#)" on page 61.
2. Updated "[Typical Characteristics](#)" on page 70.
3. Editorial updates.

37.10 8069I – 03/09

1. Updated ["Electrical Characteristics"](#) on page 61.
2. Updated ["Typical Characteristics"](#) on page 70.

37.11 8069H – 11/08

1. Updated ["Ordering Information"](#) on page 2.
2. Added VFBGA to ["Pinout/Block Diagram"](#) on page 3.
3. Updated ["Block Diagram"](#) on page 6.
4. Updated feature list in ["Memories"](#) on page 10.
5. Added 49-balls VFBGA to ["Packaging information"](#) on page 58.

37.12 8069G – 10/08

1. Updated ["Features"](#) on page 1.
2. Updated ["Ordering Information"](#) on page 2.
3. Replaced the package drawing ["44M1"](#) on page 59 by a rev H update.

37.13 8069F – 09/08

1. Updated ["Features"](#) on page 1.
2. Updated ["Ordering Information"](#) on page 2.
3. Updated ["Features"](#) on page 10 by removing ["External Memory..."](#).
4. Updated [Figure 7-1](#) on page 11 and [Figure 7-2](#) on page 12.
5. Updated [Table 7-2](#) on page 14 and [Table 7-3](#) on page 14.
6. Updated ADC ["Features"](#) on page 41 and ["Overview"](#) on page 41.
7. Removed ["Interrupt Vector Summary"](#) section from datasheet.

37.14 8069E – 08/08

1. Changed [Figure 2-1](#)'s title to ["Block Diagram and TQFP/QFN pinout"](#).
2. Updated [Table 30-6](#) on page 52.

37.15 8069D – 08/08

1. Updated "Features" on page 1 and "Overview" on page 5.
2. Inserted "Interrupt Vector Summary." on page 52.

37.16 8069C – 06/08

1. Updated Figure 2-1 on page 3 and "Pinout and Pin Functions" on page 49.
2. Updated "Overview" on page 5.
3. Updated XMEGA A4 Block Diagram, Figure 3-1 on page 6 by removing JTAG from the block diagram.
4. Removed the sections related to JTAG: JTAG Reset and JTAG Interface.
5. Updated Table 14-1 on page 25.
6. Updated all tables in section "Alternate Pin Functions" on page 51.

37.17 8069B – 06/08

1. Updated "Features" on page 1.
2. Updated "Pinout/Block Diagram" on page 3 and "Pinout and Pin Functions" on page 49.
3. Updated "Ordering Information" on page 2.
4. Updated "Overview" on page 5, included the XMEGA A4 explanation text on page 6.
5. Added XMEGA A4 Block Diagram, Figure 3-1 on page 6.
6. Updated AVR CPU "Features" on page 8 and Updated Figure 6-1 on page 8.
7. Updated Event System block diagram, Figure 9-1 on page 17.
8. Updated "PMIC - Programmable Multi-level Interrupt Controller" on page 25.
9. Updated "AC - Analog Comparator" on page 44.
10. Updated "I/O configuration" on page 27.
11. Inserted a new Figure 16-1 on page 32.
12. Updated "Peripheral Module Address Map" on page 53.
13. Inserted "Instruction Set Summary" on page 54.
14. Added Speed grades in "Speed" on page 63.

37.18 8069A – 02/08

1. Initial revision.

Table of Contents

	Features	1
	Typical Applications	1
1	Ordering Information	2
2	Pinout/Block Diagram	3
3	Overview	5
	3.1 Block Diagram	6
4	Resources	7
	4.1 Recommended reading	7
5	Disclaimer	7
6	AVR CPU	8
	6.1 Features	8
	6.2 Overview	8
	6.3 Register File	9
	6.4 ALU - Arithmetic Logic Unit	9
	6.5 Program Flow	9
7	Memories	10
	7.1 Features	10
	7.2 Overview	10
	7.3 In-System Programmable Flash Program Memory	11
	7.4 Data Memory	12
	7.5 Production Signature Row	13
	7.6 User Signature Row	13
	7.7 Flash and EEPROM Page Size	14
8	DMAC - Direct Memory Access Controller	15
	8.1 Features	15
	8.2 Overview	15
9	Event System	16
	9.1 Features	16
	9.2 Overview	16
10	System Clock and Clock options	18
	10.1 Features	18

10.2	Overview	18
10.3	Clock Options	19
11	<i>Power Management and Sleep Modes</i>	21
11.1	Features	21
11.2	Overview	21
11.3	Sleep Modes	21
12	<i>System Control and Reset</i>	23
12.1	Features	23
12.2	Resetting the AVR	23
12.3	Reset Sources	23
13	<i>WDT - Watchdog Timer</i>	24
13.1	Features	24
13.2	Overview	24
14	<i>PMIC - Programmable Multi-level Interrupt Controller</i>	25
14.1	Features	25
14.2	Overview	25
14.3	Interrupt vectors	25
15	<i>I/O Ports</i>	27
15.1	Features	27
15.2	Overview	27
15.3	I/O configuration	27
15.4	Input sensing	30
15.5	Port Interrupt	30
15.6	Alternate Port Functions	30
16	<i>T/C - 16-bit Timer/Counter</i>	31
16.1	Features	31
16.2	Overview	31
17	<i>AWEX - Advanced Waveform Extension</i>	33
17.1	Features	33
17.2	Overview	33
18	<i>Hi-Res - High Resolution Extension</i>	34
18.1	Features	34
18.2	Overview	34

19	<i>RTC - 16-bit Real-Time Counter</i>	35
	19.1Features	35
	19.2Overview	35
20	<i>TWI - Two-Wire Interface</i>	36
	20.1Features	36
	20.2Overview	36
21	<i>SPI - Serial Peripheral Interface</i>	37
	21.1Features	37
	21.2Overview	37
22	<i>USART</i>	38
	22.1Features	38
	22.2Overview	38
23	<i>IRCOM - IR Communication Module</i>	39
	23.1Features	39
	23.2Overview	39
24	<i>Crypto Engine</i>	40
	24.1Features	40
	24.2Overview	40
25	<i>ADC - 12-bit Analog to Digital Converter</i>	41
	25.1Features	41
	25.2Overview	41
26	<i>DAC - 12-bit Digital to Analog Converter</i>	43
	26.1Features	43
	26.2Overview	43
27	<i>AC - Analog Comparator</i>	44
	27.1Features	44
	27.2Overview	44
	27.3Input Selection	46
	27.4Window Function	46
28	<i>OCD - On-chip Debug</i>	47
	28.1Features	47
	28.2Overview	47
29	<i>Program and Debug Interfaces</i>	48

29.1	Features	48
29.2	Overview	48
29.3	PDI - Program and Debug Interface	48
30	<i>Pinout and Pin Functions</i>	49
30.1	Alternate Pin Functions Description	49
30.2	Alternate Pin Functions	51
31	<i>Peripheral Module Address Map</i>	53
32	<i>Instruction Set Summary</i>	54
33	<i>Packaging information</i>	58
33.1	144A	58
33.2	244M1	59
33.3	349C2	60
34	<i>Electrical Characteristics</i>	61
34.1	Absolute Maximum Ratings*	61
34.2	DC Characteristics	61
34.3	Speed	63
34.4	Flash and EEPROM Memory Characteristics	64
34.5	ADC Characteristics	65
34.6	DAC Characteristics	66
34.7	Analog Comparator Characteristics	66
34.8	Bandgap Characteristics	66
34.9	Brownout Detection Characteristics	67
34.10	PAD Characteristics	67
34.11	POR Characteristics	68
34.12	Reset Characteristics	68
34.13	Oscillator Characteristics	68
35	<i>Typical Characteristics</i>	70
35.1	Active Supply Current	70
35.2	Idle Supply Current	73
35.3	Power-down Supply Current	77
35.4	Power-save Supply Current	78
35.5	Pin Pull-up	78
35.6	Pin Output Voltage vs. Sink/Source Current	80
35.7	Pin Thresholds and Hysteresis	83

35.8	Bod Thresholds	85
35.9	Analog Comparator	86
35.10	Oscillators and Wake-up Time	88
35.11	Module current consumption	90
35.12	Reset Pulsewidth	91
35.13	PDI Speed	92
36	<i>Errata</i>	93
36.1	ATxmega16A4, ATxmega32A4	93
37	<i>Datasheet Revision History</i>	99
37.180	69R – 06/13	99
37.280	69Q – 12/10	99
37.380	69P – 09/10	99
37.480	69O – 08/10	99
37.580	69N – 02/10	100
37.680	69M – 02/10	100
37.780	69L – 11/09	100
37.880	69K – 06/09	100
37.980	69J – 04/09	100
37.1080	69I – 03/09	101
37.1180	69H – 11/08	101
37.1280	69G – 10/08	101
37.1380	69F – 09/08	101
37.1480	69E – 08/08	101
37.1580	69D – 08/08	102
37.1680	69C – 06/08	102
37.1780	69B – 06/08	102
37.1880	69A – 02/08	102
	<i>Table of Contents</i>	<i>i</i>



Headquarters

Atmel Corporation
2325 Orchard Parkway
San Jose, CA 95131
USA
Tel: 1(408) 441-0311
Fax: 1(408) 487-2600

International

Atmel Asia
Unit 1-5 & 16, 19/F
BEA Tower, Millennium City 5
418 Kwun Tong Road
Kwun Tong, Kowloon
Hong Kong
Tel: (852) 2245-6100
Fax: (852) 2722-1369

Atmel Europe
Le Krebs
8, Rue Jean-Pierre Timbaud
BP 309
78054 Saint-Quentin-en-
Yvelines Cedex
France
Tel: (33) 1-30-60-70-00
Fax: (33) 1-30-60-71-11

Atmel Japan
9F, Tonetsu Shinkawa Bldg.
1-24-8 Shinkawa
Chuo-ku, Tokyo 104-0033
Japan
Tel: (81) 3-3523-3551
Fax: (81) 3-3523-7581

Product Contact

Web Site
www.atmel.com

Technical Support
avr@atmel.com

Sales Contact
www.atmel.com/contacts

Literature Requests
www.atmel.com/literature

Disclaimer: The information in this document is provided in connection with Atmel products. No license, express or implied, by estoppel or otherwise, to any intellectual property right is granted by this document or in connection with the sale of Atmel products. **EXCEPT AS SET FORTH IN ATMEL'S TERMS AND CONDITIONS OF SALE LOCATED ON ATMEL'S WEB SITE, ATMEL ASSUMES NO LIABILITY WHATSOEVER AND DISCLAIMS ANY EXPRESS, IMPLIED OR STATUTORY WARRANTY RELATING TO ITS PRODUCTS INCLUDING, BUT NOT LIMITED TO, THE IMPLIED WARRANTY OF MERCHANTABILITY, FITNESS FOR A PARTICULAR PURPOSE, OR NON-INFRINGEMENT. IN NO EVENT SHALL ATMEL BE LIABLE FOR ANY DIRECT, INDIRECT, CONSEQUENTIAL, PUNITIVE, SPECIAL OR INCIDENTAL DAMAGES (INCLUDING, WITHOUT LIMITATION, DAMAGES FOR LOSS OF PROFITS, BUSINESS INTERRUPTION, OR LOSS OF INFORMATION) ARISING OUT OF THE USE OR INABILITY TO USE THIS DOCUMENT, EVEN IF ATMEL HAS BEEN ADVISED OF THE POSSIBILITY OF SUCH DAMAGES.** Atmel makes no representations or warranties with respect to the accuracy or completeness of the contents of this document and reserves the right to make changes to specifications and product descriptions at any time without notice. Atmel does not make any commitment to update the information contained herein. Unless specifically provided otherwise, Atmel products are not suitable for, and shall not be used in, automotive applications. Atmel's products are not intended, authorized, or warranted for use as components in applications intended to support or sustain life.

© 2010 Atmel Corporation. All rights reserved. Atmel®, Atmel logo and combinations thereof, AVR®, AVR® logo and others are registered trademarks, XMEGA™ and others are trademarks of Atmel Corporation or its subsidiaries. Other terms and product names may be trademarks of others.

Mouser Electronics

Authorized Distributor

Click to View Pricing, Inventory, Delivery & Lifecycle Information:

Microchip:

[ATXMEGA32A4-CCU](#) [ATXMEGA16A4-AU](#) [ATXMEGA32A4-AU](#) [ATXMEGA32A4-MU](#) [ATXMEGA64A4-AU](#)
[ATXMEGA64A4-MU](#) [ATXMEGA16A4-CUR](#) [ATXMEGA32A4-CUR](#) [ATXMEGA32A4-CU](#) [ATXMEGA16A4-CU](#)
[ATXMEGA16A4-MH](#) [ATXMEGA32A4-MH](#) [ATXMEGA16A4-MHR](#) [ATXMEGA16A4-AUR](#) [ATXMEGA32A4-AUR](#)
[ATXMEGA32A4-CCUR](#) [ATXMEGA32A4-MHR](#) [ATXMEGA32A4-ANR](#) [ATXMEGA32A4-AN](#)

Компания «Океан Электроники» предлагает заключение долгосрочных отношений при поставках импортных электронных компонентов на взаимовыгодных условиях!

Наши преимущества:

- Поставка оригинальных импортных электронных компонентов напрямую с производств Америки, Европы и Азии, а так же с крупнейших складов мира;
- Широкая линейка поставок активных и пассивных импортных электронных компонентов (более 30 млн. наименований);
- Поставка сложных, дефицитных, либо снятых с производства позиций;
- Оперативные сроки поставки под заказ (от 5 рабочих дней);
- Экспресс доставка в любую точку России;
- Помощь Конструкторского Отдела и консультации квалифицированных инженеров;
- Техническая поддержка проекта, помощь в подборе аналогов, поставка прототипов;
- Поставка электронных компонентов под контролем ВП;
- Система менеджмента качества сертифицирована по Международному стандарту ISO 9001;
- При необходимости вся продукция военного и аэрокосмического назначения проходит испытания и сертификацию в лаборатории (по согласованию с заказчиком);
- Поставка специализированных компонентов военного и аэрокосмического уровня качества (Xilinx, Altera, Analog Devices, Intersil, Interpoint, Microsemi, Actel, Aeroflex, Peregrine, VPT, Syfer, Eurofarad, Texas Instruments, MS Kennedy, Miteq, Cobham, E2V, MA-COM, Hittite, Mini-Circuits, General Dynamics и др.);

Компания «Океан Электроники» является официальным дистрибьютором и эксклюзивным представителем в России одного из крупнейших производителей разъемов военного и аэрокосмического назначения «JONHON», а так же официальным дистрибьютором и эксклюзивным представителем в России производителя высокотехнологичных и надежных решений для передачи СВЧ сигналов «FORSTAR».



JONHON

«JONHON» (основан в 1970 г.)

Разъемы специального, военного и аэрокосмического назначения:

(Применяются в военной, авиационной, аэрокосмической, морской, железнодорожной, горно- и нефтедобывающей отраслях промышленности)

«FORSTAR» (основан в 1998 г.)

ВЧ соединители, коаксиальные кабели, кабельные сборки и микроволновые компоненты:

(Применяются в телекоммуникациях гражданского и специального назначения, в средствах связи, РЛС, а так же военной, авиационной и аэрокосмической отраслях промышленности).



Телефон: 8 (812) 309-75-97 (многоканальный)

Факс: 8 (812) 320-03-32

Электронная почта: ocean@oceanchips.ru

Web: <http://oceanchips.ru/>

Адрес: 198099, г. Санкт-Петербург, ул. Калинина, д. 2, корп. 4, лит. А