

## L-Series Sealed Rocker Switches



Making the right connections has never been easier — with the L-Series Rocker Switch from Carling Technologies. Not only does this innovative switch offer total design flexibility, it has set new standards for both performance and reliability. It's IP67 certified, and able to withstand temperatures from -40°C to +85°C. Features include countless switch and lamp circuit combinations, LED illuminated lenses or laser etched rockers, as well as hundreds of legend choices and several accessories.

### Eliminates need for retooling

Neatly proportioned, our L-Series fits into industry standard mounting holes of 1.734" x .867" and 44.0mm x 22.0mm.

### Integrates easily into your system

You can choose from a variety of termination options, including .250 TAB QC & .187 TAB QC.

### Withstands extreme temperatures

Roller pin mechanism eliminates need for lubricants, so it can withstand from -40°C to +85°C.

### Ensures greater shock protection

Welded lamp connection and one-piece internal, jumperless terminal withstand extreme shock and vibration.

### Maximizes your design flexibility

Twelve terminals offer you an extensive range of switch and lamp circuit options, including LED or incandescent illumination.

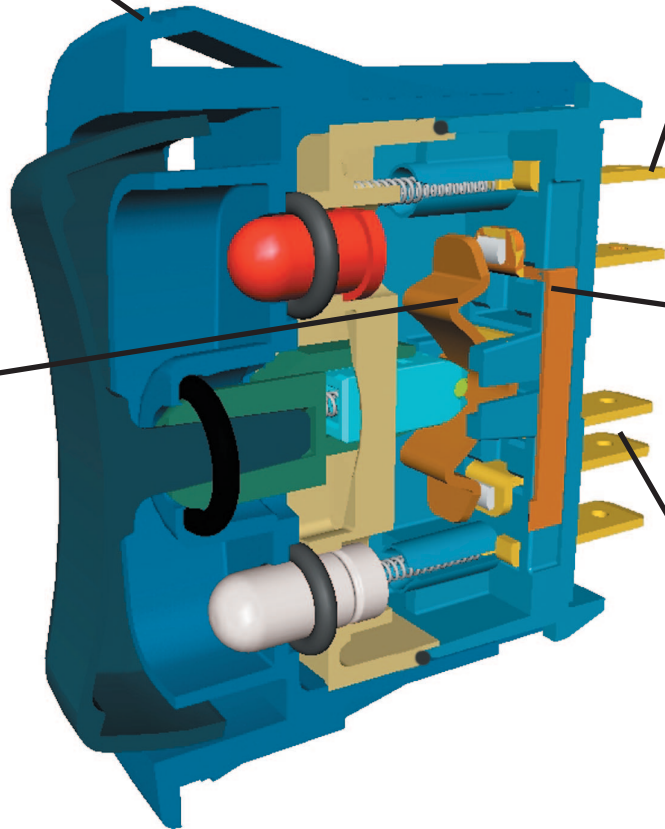

**Electrical**

Contact Rating . . . . .	.4VA @ 24VDC (MAX) resistive 15 amps, 125 VAC 10 amps, 250 VAC 20 amps, 4-14 VDC 15 amps, 15-28 VDC
Dielectric Strength . . . . .	1250 Volts RMS between pole to pole 3750 Volts RMS between live parts and accessible surfaces
Insulation Resistance . . .	50 Megohms
Initial Contact Resistance.	10 milliohms max. @ 4 VDC
Life . . . . .	100,000 cycles maintained, 50,000 cycles momentary at rated voltage and current
Contacts . . . . .	90/10 silver-nickel, silver tin-oxide, gold
Terminals . . . . .	Brass or copper/silver plate 3/16" (4.76mm) & 1/4" (6.3mm) Quick Connect terminations standard.

**Mechanical**

Endurance . . . . . 250,000 cycles minimum

**Physical**

Lighted . . . . .	Incandescent - rated 10,000 hours LED - rated 100,000 hours 1/2 life (LED is internally ballasted for volt-ages to 24 VDC)
Seals . . . . .	Rocker, base & bracket are sealed.
Base . . . . .	Polyester blend rated to 85°C with a flammability rating of 94VO.
Actuator . . . . .	Nylon 66 Reinforced, rated to 105°C (modular lens). Locking rocker, standard rocker & paddle. Laser etching with a polycarbonate actuator.
Lens . . . . .	Polycarbonate rated at 100°C. Front snap-in.
Connector . . . . .	Nylon 66 rated at 85°C. Polarized.

**Actuator Travel (Angular Displacement)**

2 position . . . . .	26°
3 positions . . . . .	13° from center

**Environmental**

Environmental . . . . .	IP67, representing an index of protection as applied to electrical equipment in accordance with IEC 529, BS 5490, DIN 400 50 & NFC 20 010.
Corrosion Resistance . . .	MFG Class III per ASTM B-827 & B-845, Method H, with 3 years exposure.
Operating Temperature . . .	-40° C to + 85° C
Vibration 1 . . . . .	Per Mil-Std 202F, Method 204D Test Condition A 0.06 DA or 10G's 10-500 Hz. Tested with VCH connector. Test criteria - No loss of circuit during test and pre and post test contact resistance.
Vibration 2 . . . . .	Resonance search 24-50 Hz 0.40 DA 50-2000 ±10 G's peak Results Horizontal Axis 3-5 G's max. Random 24 Hz 0.06 PSD-Gsq/Hz 60 Hz 0.50 100 Hz 0.50 200 Hz 0.025 2000 Hz 0.025 No loss of circuit during test; <10µ chatter.
Shock . . . . .	Per Mil-Std 202F, Method 213B, Test Condition K @ 30G's. Tested with VCH connector. Test criteria - No loss of circuit during test, pre, and post test contact resistance.
Salt Spray . . . . .	Per Mil-Std 202F, Method 101D, Test Condition A, 48 Hrs.
Thermal Shock . . . . .	Per Mil-Std 202F, Method 107F, Test Condition A, -55°C to 85°C. Test criteria - pre and post test contact resistance.
Moisture Resistance . . . .	Per Mil-Std 202F, Method 106F, Test Criteria - pre and post test contact resistance.

**Mounting Specifications**

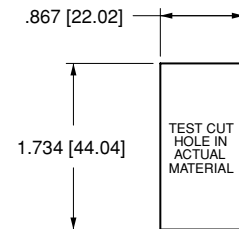

MOUNTING HOLE

**Panel Thickness Range**  
Acceptable Panel Thickness  
.030 to .156 (.76mm to 3.96mm)  
Recommended:  
.030, .062, .093, .125 and .156

**L 11 E 3 C H N 1 - 3 A A 45 - 1 48**

1 Series    2 Circuit    3 Rating    4 Termination    5 Illumination    6 Lamp    7 Lamp    8 Bracket    9 Actuator    10 Lens Style & Color    11 Lens Style & Color    12 Legend    13 Legend Orientation    14 Actuator Lens Legend

**1 SERIES**  
L

**2 CIRCUIT<sup>2</sup>**  
Terminal Orientation

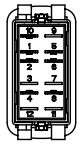

( ) - momentary

SP - single pole - uses terminals 1, 2 & 4.  
DP - double pole uses terminals 5, 6 & 8.  
Terminals 9, 10, 11 & 12 for lamp circuit only.

Position:	1	2	3
SP DP	2 & 4, 6 & 8	Connected Terminals	1 & 2, 5 & 6
11 21	ON	NONE	OFF
12 22	(ON)	NONE	OFF
13 23	ON	NONE	(OFF)
14 24	ON	NONE	ON
15 25	ON	NONE	(ON)
16 26	ON	OFF	ON
17 27	ON	OFF	(ON)
18 28	(ON)	OFF	(ON)

**CIRCUITS WITH JUMPER TERMINALS**

30	(2,4&5),(1,6&8)	OFF, OFF	(1,2&8),(4,5&6)
31	1,2&5	2,3&7	2,4&8

**PROGRESSIVE CIRCUITS**

51	3&4	2&3	1&2
52	3&4	2&3	OFF
53	(3&4)	2&3	1&2
54	(3&4)	2&3	OFF
55	(3&4)	2&3	(1&2)
56	(3&4)	2&3	(OFF)
57	3&4	2&3	(OFF)
58	2&4	2&3	1&2
61	3&4,7&8	2&3,6&7	1&2,5&6
62	3&4,7&8	2&3,6&7	OFF, OFF
63	(3&4),(7&8)	2&3,6&7	1&2,5&6
64	(3&4),(7&8)	2&3,6&7	OFF, OFF
65	(3&4),(7&8)	2&3,6&7	(1&2),(5&6)
66	(3&4),(7&8)	2&3,6&7	(OFF),(OFF)
67	3&4,7&8	2&3,6&7	(OFF),(OFF)
68	2&4,7&8	2&4, OFF	OFF, OFF
69	2&4,1,7&8	2&4, OFF	OFF, OFF
70	(2&4),(7&8)	2&4,5&7	(1&2),(5&7)
71	(2&4),(7&8)	2&4,5&7	1&2,5&7
72	2&4,7&8	2&4,5&7	1&2,5&7
73	(2&4),(7&8)	2&4, OFF	OFF, OFF
80	2&4,6&8	2&4, OFF	OFF,5&6

**HAZARD WARNING CIRCUITS**

A2	6,7&8, 3&4	NONE	OFF,1&2
A3	6,7&8, 2&4	NONE	OFF,1&2

**3 RATING<sup>2</sup>**

1	.4VA @ 28VDC Resistive	D	20A 12V
4	10A 250VAC 1/2 HP, 15A 125VAC 1/2 HP, No Listings	E	15A 12V
B	15A 24V	G	20A 6V
C	20A 18V	H	20A 3V

**4 TERMINATION<sup>3,4</sup>**

1	.250 (6.4mm) TAB (QC)	3	.187 (4.7mm) TAB (QC)
---	-----------------------	---	-----------------------

NOTES:  
Consult factory to verify horsepower rating for your particular circuit choice.

- Custom colors are available. Consult factory.
- Circuits 30, 31, 58, 69 when used in combination with termination codes 1 and 3 are not available with rating codes 4, C, D, G or H.
- Termination 3 only available with rating codes 1, B, and E.
- Termination 1 not available with rating code 4.
- Not available with circuits 11-18, 51-57 and 69.

**5 ILLUMINATION**

Lamp #1: above terminals 9 & 10 end of switch.; Lamp #2: above terminals 11 & 12 end of switch. Positive (+) and negative (-) symbols apply to LED lamps only.

Lamps	Illumination Type	Lamp wired to Terminals		
S	None			
A	# 1 Independent	10+	9-	
B	# 2 Independent	12+	11-	
C	# 1 Independent	10+	9-	
	&# 2 Independent	12+	9-	
D	# 1 Dependent	4+	9-	
E	# 1 Independent	10+	9-	
	&# 2 Dependent	4+	9-	
F <sup>5</sup>	# 1 Independent	10+	9-	
	&# 2 Dependent	8+	9-	
G	# 1 Dependent	4+	9-	
	&# 2 Independent	10+	9-	
H	# 1 Both Independent	10+	9-	
	&# 2 (in series)			
1	# 2 Hazard	6+	10+	12-
2	# 1 Hazard	6+	10+	12-

**6,7 LAMP (same coding for both selections)**

Selection 6: above terminals 10 & 9; Selection 7: above terminals 12 & 11

No lamp 0

Incandescent	4 3V	5 6V	6 12V	7 18V	8 24V
LED*	Red	Amber	Green		
2VDC	A	L	F		
6VDC	B	M	G		
12VDC	C	N	H		
24VDC	D	P	J		

\* Consult factory for "daylight bright", blue/green and white LED options.  
Typical current draw for LED is 20ma.

**8 BRACKET COLOR<sup>1</sup>**

	Black	White	Gray	Red
Standard Bracket	1 A	2 B	3 C	4 D
Rockerguard at Lamp 1	E	F	G	H
Rockerguard at Lamp 2				

**9 ACTUATOR STYLE AND COLOR<sup>1</sup>**

	Black	White	Gray	Red	Laser Etched
Rocker	A	B	C	D	3
Paddle	J	N	K	M	4

**10 & 11 LENS STYLE AND COLOR**

Lens color for LEDs must be clear, white, or match color of LED. Green or blue lenses are not recommended with Neon lamps.

0 - No Actuator Z - No Lens

Clear	White	Amber	Green	Red	Blue	
1	-	B	G	M	T	Large Transparent
-	7	C	H	N	U	Large Translucent
3	-	D	J	P	V	Bar Transparent
-	9	E	K	R	W	Bar Transparent
5	A	-	-	-	-	Laser Etch background color

**12 LASER ETCH, LENS OR BODY LEGEND**

00 No legend this location / no actuator  
For legend options & codes, see page 69 of this catalog.

**13 LEGEND ORIENTATION**

0 No legend (used with codes 11-18 in selection 12)

1 Orientation 1 - vertical, lamp 1 on top

2 Orientation 2 - horizontal, lamp 1 on right

3 Orientation 3 - vertical, lamp 1 on bottom

4 Orientation 4 - vertical, lamp 1 on left

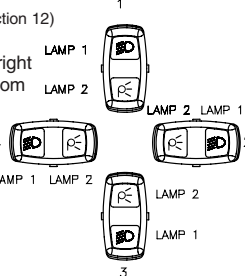
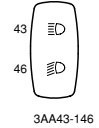
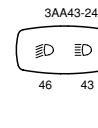
**14 ACTUATOR LENS LEGEND**

00 No legend this location / no actuator  
For legend options & codes, see page 69 of this catalog.

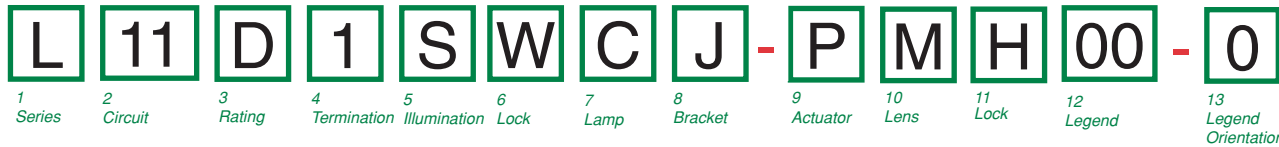

## 1 SERIES

**L**

## 2 CIRCUIT<sup>6</sup>

Terminal Orientation

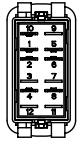

( ) - momentary  
 SP - single pole - uses terminals 1, 2 & 4.  
 DP - double pole uses terminals 5, 6 & 8.  
 Terminals 9, 10, 11 & 12 for lamp circuit only.

Position:	1	2	3 (lock location)
SP	DP	2 & 4, 6 & 8	Connected Terminals
11	21	ON	NONE
14	24	ON	NONE
16	26	ON	OFF
17	27	ON	ON
18	28	(ON)	(ON)

CIRCUITS WITH JUMPER TERMINALS

30 <sup>2</sup>	(2,4&5),(1,6&8)	OFF, OFF	(1,2&8),(4,5&6)
31 <sup>2</sup>	1,2&5	2,3&7	2,4&8

PROGRESSIVE CIRCUITS

51	3&4	2&3	1&2
52	3&4	2&3	OFF
53	(3&4)	2&3	1&2
54	(3&4)	2&3	OFF
55	(3&4)	2&3	(1&2)
56	(3&4)	2&3	(OFF)
57	3&4	2&3	(OFF)
58	2&4	2&3	1&2
61	3&4,7&8	2&3,6&7	1&2,5&6
62	3&4,7&8	2&3,6&7	OFF, OFF
63	(3&4),(7&8)	2&3,6&7	1&2,5&6
64	(3&4),(7&8)	2&3,6&7	OFF,OFF
65	(3&4),(7&8)	2&3,6&7	(1&2),(5&6)
66	(3&4),(7&8)	2&3,6&7	(OFF),(OFF)
67	3&4,7&8	2&3,6&7	(OFF),(OFF)
68	2&4,7&8	2&4,OFF	OFF,OFF
69	2&4,1,7&8	2&4,OFF	OFF,OFF
70	(2&4),(7&8)	2&4,5&7	(1&2),(5&7)
71	(2&4),(7&8)	2&4,5&7	1&2,5&7
72	2&4,7&8	2&4,5&7	1&2,5&7
73	(2&4),(7&8)	2&4,OFF	OFF,OFF
80	2&4,6&8	2&4,OFF	OFF,5&6

## 3 RATING<sup>6</sup>

1	.4VA @ 28VDC Resistive	D	20A 12V
4	10A 250VAC 1/2 HP,	E	15A 12V
	15A 125VAC 1/2 HP, No Listings	G	20A 6V
B	15A 24V	H	20A 3V
C	20A 18V		

## 4 TERMINATION<sup>4,5</sup>

1	.250 (6.4mm) TAB (QC)	3	.187 (4.7mm) TAB (QC)
---	-----------------------	---	-----------------------

## 5 ILLUMINATION<sup>6</sup>

Lamp located above terminals 11 & 12, position 1 end of switch.  
 Positive (+) and negative (-) symbols apply to LED lamps only.

S	Lamps	Illumination Type	Lamp wired to Terminals
S	None		
B	# 2	Independent	12+ 11-

## 6 LOCK

**W** Lock above terminals 10 & 9.

## 7 LAMP

Above terminals 12 & 11  
 No lamp **0**  
 Incandescent **4** 3V **5** 6V **6** 12V **7** 18V **8** 24V  
 LED\* **Red** **Amber** **Green**

2VDC	<b>A</b>	<b>L</b>	<b>F</b>
6VDC	<b>B</b>	<b>M</b>	<b>G</b>
12VDC	<b>C</b>	<b>N</b>	<b>H</b>
24VDC	<b>D</b>	<b>P</b>	<b>J</b>

\* Consult factory for "daylight bright", blue/green and white LED options.  
 Typical current draw for LED is 20ma.

## 8 BRACKET COLOR<sup>1</sup>

Black **J**

## 9 ACTUATOR STYLE AND COLOR<sup>1</sup>

Locking Rocker	Black <b>P</b>	Red <b>R</b>
----------------	----------------	--------------

## 10 LENS STYLE AND COLOR

Lens color for LEDs must be clear, white, or match color of LED.  
 Green or blue lenses are not recommended with Neon lamps.

**0** - No Actuator **Z** - No Lens

Clear	White	Amber	Green	Red	Blue	
<b>1</b>	-	<b>B</b>	<b>G</b>	<b>M</b>	<b>T</b>	Large Transparent
-	<b>7</b>	<b>C</b>	<b>H</b>	<b>N</b>	<b>U</b>	Large Translucent
<b>3</b>	-	<b>D</b>	<b>J</b>	<b>P</b>	<b>V</b>	Bar Transparent
-	<b>9</b>	<b>E</b>	<b>K</b>	<b>R</b>	<b>W</b>	Bar Transparent

## 11 LOCK FUNCTION AND COLOR<sup>7</sup>

Locking Position	Up	Down	Up & Down	Center <sup>3</sup>	Lock Color
<b>A</b>	<b>H</b>	<b>R</b>	<b>1</b>	<b>1</b>	Match Actuator
<b>B</b>	<b>J</b>	<b>S</b>	<b>2</b>	<b>2</b>	black
<b>C</b>	<b>K</b>	<b>T</b>	<b>3</b>	<b>3</b>	white
<b>D</b>	<b>L</b>	<b>V</b>	<b>4</b>	<b>4</b>	red
<b>E</b>	<b>M</b>	<b>W</b>	<b>5</b>	<b>5</b>	safety orange

## 12 LASER ETCH, LENS OR BODY LEGEND

**00** No legend this location / no actuator  
 For legend options & codes, see page 69 of this catalog.

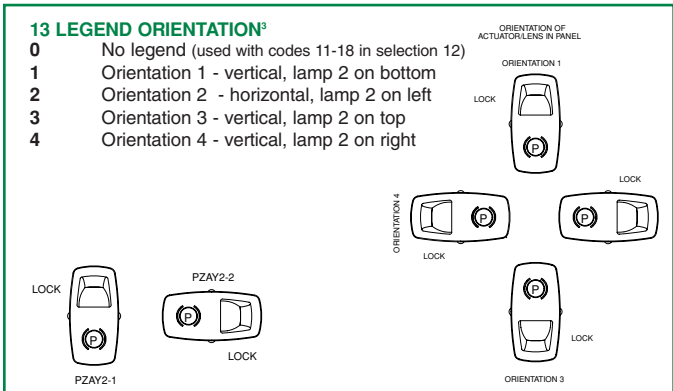

**NOTES:**

- Consult factory to verify horsepower rating for your particular circuit choice.
- 1 Custom colors are available. Consult factory.
- 2 Additional lamp circuits available. Consult factory.
- 3 Available only with 3 position circuits.
- 4 Termination 1 not available with rating 4.
- 5 Termination 3 only available with ratings 1, B and E.
- 6 Circuits 30, 31, 58 and 69, when used in combination with termination codes 1 is not available with rating codes 4, C, D, G or H.
- 7 Up, Up & Down, and Center lock options will be available 1Q2004.

**Dimensional Specifications**

**L SERIES**  
SHOWN WITH LASER ETCHED ACTUATOR

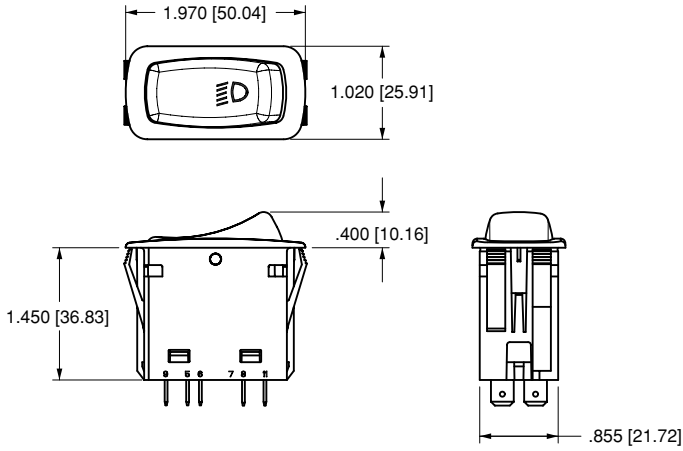

**L SERIES**  
SHOWN WITH ROCKER GUARD

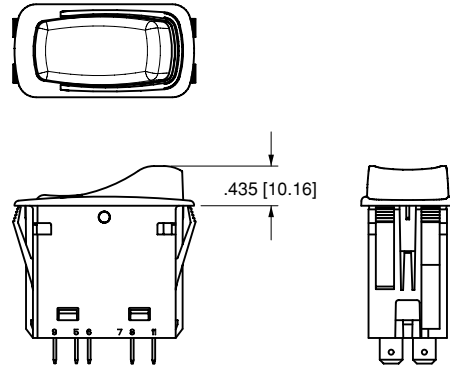

**L SERIES**  
SHOWN WITH LARGE LENS AND PADDLE ACTUATOR

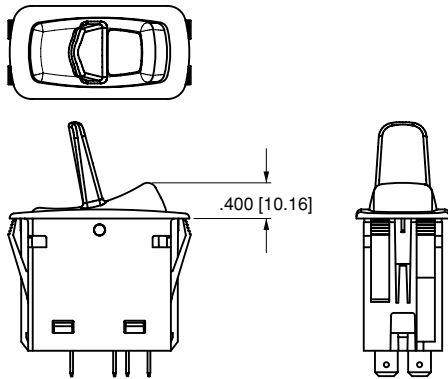

**L SERIES**  
SHOWN WITH BAR LENS, LOCK AND CONNECTOR

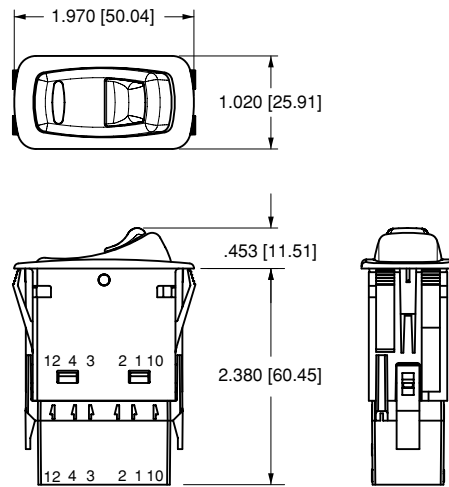

**Connector**

**L SERIES**  
CONNECTOR

**LC1-01** BLACK .250 TAB CONNECTOR  
**LC1-02** BLACK .187 TAB CONNECTOR

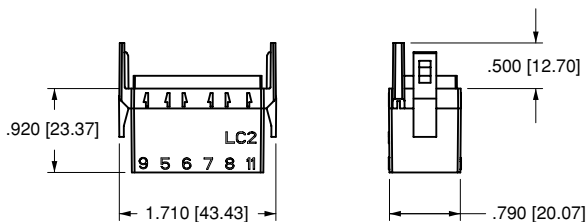

**Hole Plug**

**L SERIES**  
HOLE PLUG

**LH1** REMOVABLE HOLE PLUG WITH NON-SERRATED WINGS  
**LH2** HOLE PLUG WITH SERRATED WINGS

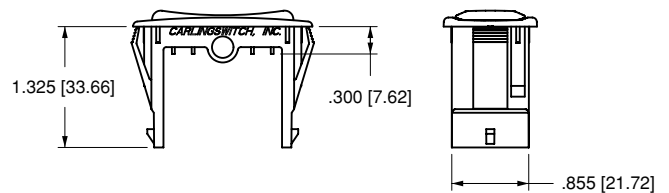
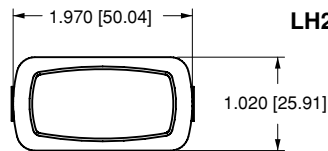

**Mounting Panel**

**Dimensional Specifications: in. [mm]**

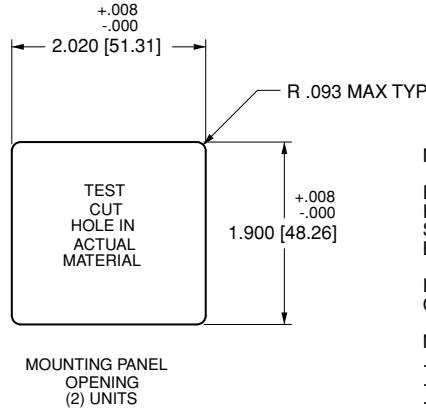
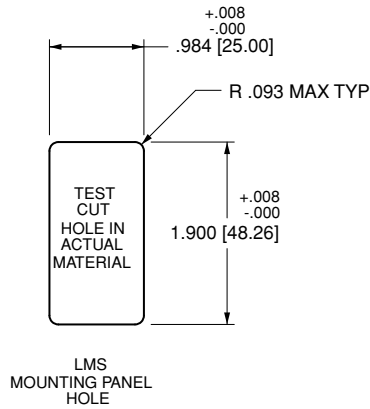

**MOUNTING PANEL**

FOR ADDITIONAL UNITS, ADD 1.03 [26.2] PER UNIT. FOR MORE THAN 2 L-SERIES SWITCHES, ADD MIDDLE SECTION. AVAILABLE IN PANEL THICKNESSES LISTED BELOW. CONSULT FACTORY

DIMENSIONS: LME 2.02 [51.3mm] PLUS NUMBER OF CENTER BEZELS (LMM) X 1.034 [26.26mm]

**MOUNTING PANEL THICKNESS**

- .062 [1.57]
- .093 [2.36]
- .125 [3.17]
- .156 [3.96]

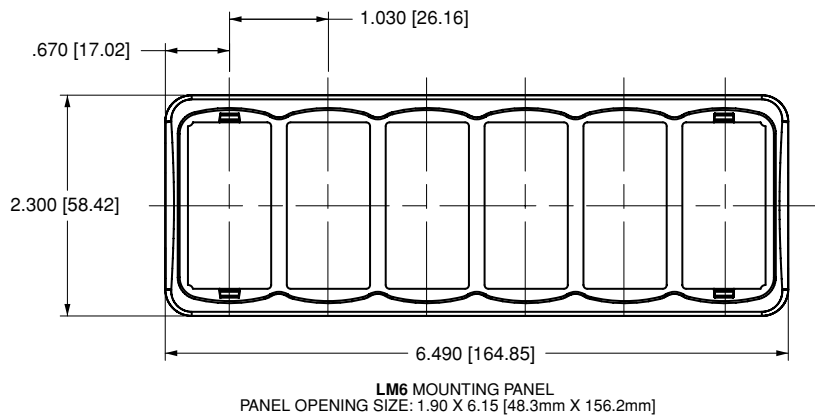
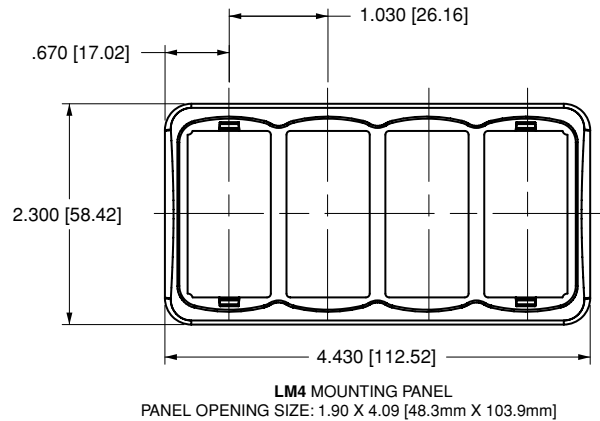
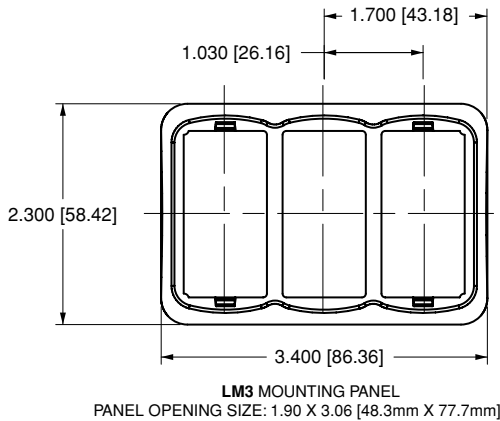
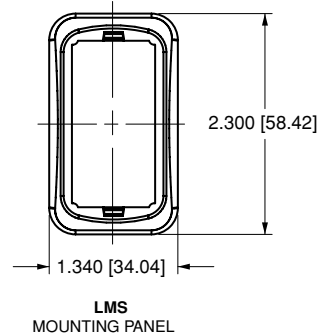
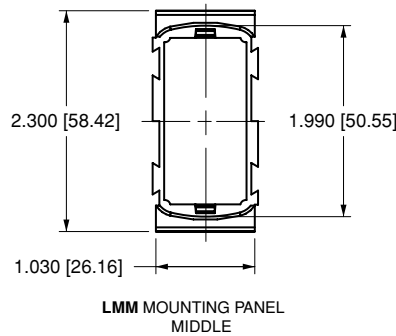
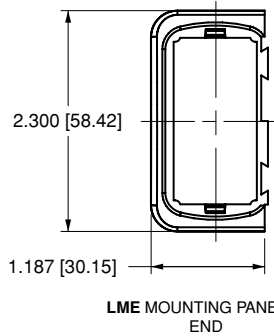

CIRCUIT CODE	SCHEMATIC	CIRCUIT CODE	SCHEMATIC	CIRCUIT CODE	SCHEMATIC
11		22		51	
12		23		52	
13		24		53	
14		25		54	
15		26		55	
16		27		56	
17		28		57	
18		30		58	
21		31		61	

















CIRCUIT CODE	SCHEMATIC	CIRCUIT CODE	SCHEMATIC
<b>62</b>		<b>71</b>	
<b>63</b>		<b>72</b>	
<b>64</b>		<b>73</b>	
<b>65</b>		<b>80</b>	
<b>66</b>		<b>A2</b>	
<b>67</b>		<b>A3</b>	
<b>68</b>			
<b>69</b>			
<b>70</b>			



















ILLUM. CODE	SCHEMATIC
A	
B	
C	
D	
E	
F	
G	
H	
1	
2	

**LEGEND**

SYMBOL	DEFINITION
	TERMINAL LOCATION
	LAMP LOCATION
	LAMP LOCATION
	MAINTAINED CIRCUIT
	MOMENTARY CIRCUIT
	2 POSITION CONNECTION
	2 POSITION
	3 POSITION

LEGEND		LEGEND CODE		
SYMBOL	NAME <small>(SYMBOL MEANING)</small>	BODY	LENS	
			NEGATIVE <sup>1</sup>	POSITIVE
	RUNNING LIGHTS (UNDER POWER)	AA	NA	MA
	LIGHT	AB	NB	MB
	MASTER LIGHT SWITCH	AC	NC	MC
	HORN	AD	ND	MD
	PROPULSION SYSTEM TRIM TRIMMING OPERATION	AE	NE	ME
	VENTILATION FAN OR BLOWER	AF	NF	MF
	WINDSHIELD WASHER	AG	NG	MG
	WINDSHIELD WIPER	AH	NH	MH
	BILGE PUMP	AJ	NJ	MJ
	BILGE BLOWER	AK	NK	MK
	POTABLE WATER PRESSURE	AL	NL	ML
	ENGINE START	AM	ED	MM
	ENGINE STOP	AN	EE	MN
	DRIVE TILT TILT OPERATION	30		31
	EMERGENCY START	32		33
	UP/DOWN LIFT	34		
	TRIM TAB TRIMMING OPERATION	35		36

LEGEND		LEGEND CODE		
SYMBOL	NAME <small>(SYMBOL MEANING)</small>	BODY	LENS	
			NEGATIVE <sup>1</sup>	POSITIVE
	ANCHOR LIGHT	37		38
	ANCHOR	39		40
	WATER FLUSHING TAP FOR OUTBOARDS	41		42
	HIGH BEAM	43	44	45
	LOW / DIPPED BEAM	46	47	48
	SIDE MARKER LIGHT	DG	49	DF
	INTERIOR LIGHT	50	51	52
	WORK LIGHT	53	54	55
	WORK LAMP	56	57	58
	LOADING FLOOR LAMP	CW	59	CY
	ON -WIPER-INT DELAY	60		
	ROTARY BEACON	61	62	63
	LAMP TEST	DK	64	DL
	WINDSHIELD WIPER/WASHER	65	66	67
	HAZARD WARNING	68	69	70
	WARM AIR BLOWER	71	72	73
	HORN REAR	AX	74	Y4

**NOTE**

<sup>1</sup> Negative lens not available on L or LD-Series.  
Additional Standard Markings available. Consult factory.

Компания «Океан Электроники» предлагает заключение долгосрочных отношений при поставках импортных электронных компонентов на взаимовыгодных условиях!

Наши преимущества:

- Поставка оригинальных импортных электронных компонентов напрямую с производств Америки, Европы и Азии, а так же с крупнейших складов мира;
- Широкая линейка поставок активных и пассивных импортных электронных компонентов (более 30 млн. наименований);
- Поставка сложных, дефицитных, либо снятых с производства позиций;
- Оперативные сроки поставки под заказ (от 5 рабочих дней);
- Экспресс доставка в любую точку России;
- Помощь Конструкторского Отдела и консультации квалифицированных инженеров;
- Техническая поддержка проекта, помощь в подборе аналогов, поставка прототипов;
- Поставка электронных компонентов под контролем ВП;
- Система менеджмента качества сертифицирована по Международному стандарту ISO 9001;
- При необходимости вся продукция военного и аэрокосмического назначения проходит испытания и сертификацию в лаборатории (по согласованию с заказчиком);
- Поставка специализированных компонентов военного и аэрокосмического уровня качества (Xilinx, Altera, Analog Devices, Intersil, Interpoint, Microsemi, Actel, Aeroflex, Peregrine, VPT, Syfer, Eurofarad, Texas Instruments, MS Kennedy, Miteq, Cobham, E2V, MA-COM, Hittite, Mini-Circuits, General Dynamics и др.);

Компания «Океан Электроники» является официальным дистрибьютором и эксклюзивным представителем в России одного из крупнейших производителей разъемов военного и аэрокосмического назначения «JONHON», а так же официальным дистрибьютором и эксклюзивным представителем в России производителя высокотехнологичных и надежных решений для передачи СВЧ сигналов «FORSTAR».



## JONHON

«JONHON» (основан в 1970 г.)

Разъемы специального, военного и аэрокосмического назначения:

(Применяются в военной, авиационной, аэрокосмической, морской, железнодорожной, горно- и нефтедобывающей отраслях промышленности)

«FORSTAR» (основан в 1998 г.)

ВЧ соединители, коаксиальные кабели, кабельные сборки и микроволновые компоненты:

(Применяются в телекоммуникациях гражданского и специального назначения, в средствах связи, РЛС, а так же военной, авиационной и аэрокосмической отраслях промышленности).



Телефон: 8 (812) 309-75-97 (многоканальный)

Факс: 8 (812) 320-03-32

Электронная почта: [ocean@oceanchips.ru](mailto:ocean@oceanchips.ru)

Web: <http://oceanchips.ru/>

Адрес: 198099, г. Санкт-Петербург, ул. Калинина, д. 2, корп. 4, лит. А