

# Features

# Switching Regulator

- Efficiency up to 96%, no need for heatsinks
- 2A continuous output current
- Vin up to 32V
- Vout: 1.2V - 15V
- Wide operating temperature -40°C to +70°C at full load
- Continuous short circuit protection
- Pin compatible with TO220 linear regulators
- Positive to negative converter

# RECOM

## DC/DC Converter

## R-78B-2.0

**2.0 Amp**  
**SIP3**  
**Single Output**



### Description

The R-78Bxx-2.0 series high efficiency switching regulators are ideally suited to replace 78xx linear regulators and are pin compatible. The efficiency of up to 96% means that very little energy is wasted as heat. Full power is available over a temperature range of -40°C up to 70°C without the need for heatsinks with their additional space and mounting costs. A high input voltage of up to 32VDC and output voltages from 1.2V up to 15V, low ripple and noise figures and a short circuit input current of typically only 50mA round off the specifications of this versatile converter series.

### Selection Guide

| Part Number  | Input Voltage Range [VDC] | Output Voltage [VDC] | Output Current [mA] | Efficiency @ full load |                | Max. Capacitive Load <sup>(1)</sup> [µF] |
|--------------|---------------------------|----------------------|---------------------|------------------------|----------------|--|
|              |                           |                      |                     | @ min Vin [%]          | @ max. Vin [%] |  |
| R-78B1.2-2.0 | 4.75 - 32                 | 1.2                  | 2000                | 87                     | 72             | 3300                                     |
| R-78B1.5-2.0 | 4.75 - 32                 | 1.5                  | 2000                | 90                     | 79             | 3300                                     |
| R-78B1.8-2.0 | 4.75 - 32                 | 1.8                  | 2000                | 91                     | 80             | 3300                                     |
| R-78B2.5-2.0 | 4.75 - 32                 | 2.5                  | 2000                | 92                     | 84             | 2300                                     |
| R-78B3.3-2.0 | 4.75 - 32                 | 3.3                  | 2000                | 92                     | 86             | 1800                                     |
| R-78B5.0-2.0 | 6.5 - 32                  | 5                    | 2000                | 94                     | 90             | 820                                      |
| R-78B9.0-2.0 | 11 - 32                   | 9                    | 2000                | 95                     | 93             | 620                                      |
| R-78B12-2.0  | 15 - 32                   | 12                   | 2000                | 96                     | 94             | 470                                      |
| R-78B15-2.0  | 18 - 32                   | 15                   | 2000                | 96                     | 95             | 470                                      |

#### Notes:

Note1: Max. cap load is tested by nominal input and full resistive load

### Model Numbering

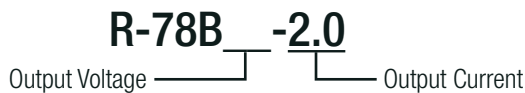

IEC62368-1 certified  
EN62368-1 certified  
EN55032 compliant  
CB report

**Specifications** (measured @ Ta= 25°C, nom. Vin, full load and after warm up unless otherwise specified)

### BASIC CHARACTERISTICS

| Parameter                              | Condition       |                            | Min.    | Typ.               | Max.  |
|--|-----------------|----------------------------|---------|--------------------|-------|
| Input Voltage Range                    | nom. Vin= 24VDC | 1.2Vout - 3.3Vout          | 4.75VDC | 24VDC              | 32VDC |
|  |                 | 5Vout                      | 6.5VDC  |                    |       |
|  |                 | 9Vout                      | 11VDC   |                    |       |
|  |                 | 12Vout                     | 15VDC   |                    |       |
|  |                 | 15Vout                     | 18VDC   |                    |       |
| Maximum Reverse Voltage                |                 |                            |         |                    | 0V    |
| Inrush Current                         |                 |                            |         | 2A                 |       |
| Quiescent Current                      | nom. Vin= 24VDC |                            |         | 2mA                |       |
| Internal Power Dissipation             | Vout= 1.5VDC    |                            |         | 0.35W              | 0.8W  |
| Start-up time                          |                 |                            |         | 10ms               |       |
| Rise Time                              |                 |                            |         | 50µs               |       |
| Internal Operating Frequency           | nom. Vin= 24VDC |                            |         | 460kHz             |       |
| Minimum Load                           |                 |                            | 0%      |                    |       |
| Output Ripple and Noise <sup>(2)</sup> | 20MHz BW        | Vout ≤3.3VDC<br>Vout ≥5VDC |         | 50mVp-p<br>75mVp-p |       |

**Notes:**

Note2: Measurements are made with a 100nF MLCC across output (low ESR)

**Efficiency vs. Load**

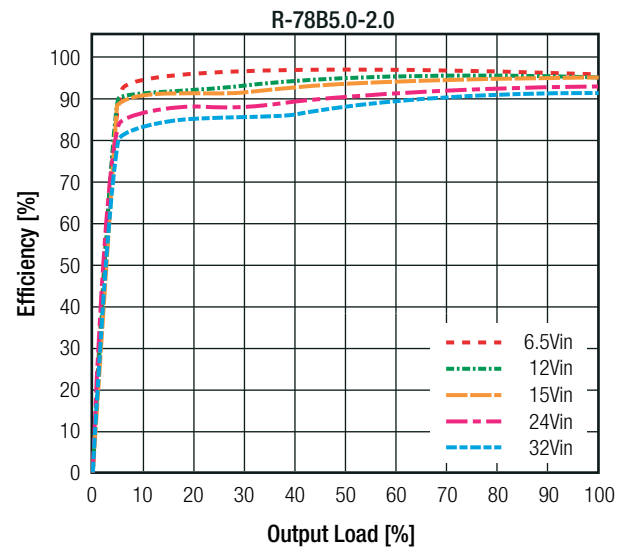
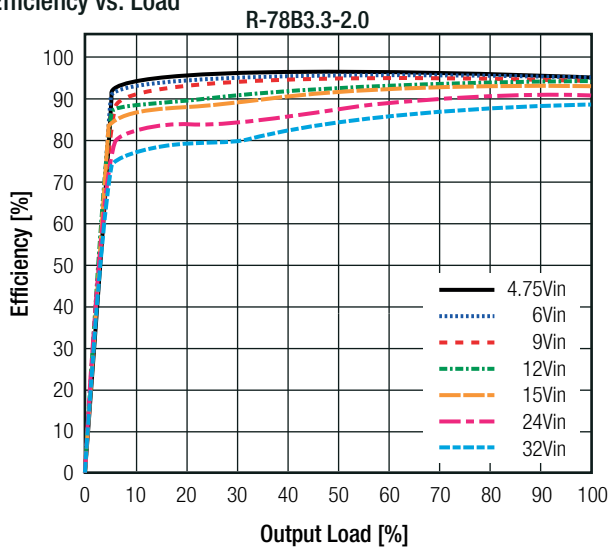

**Efficiency vs. Input Voltage**

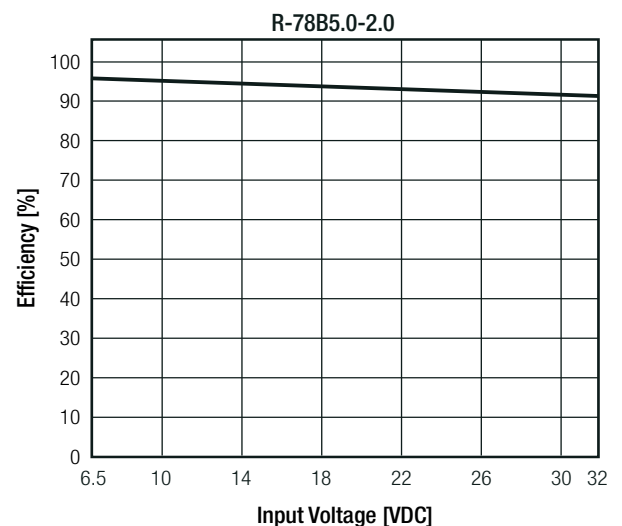
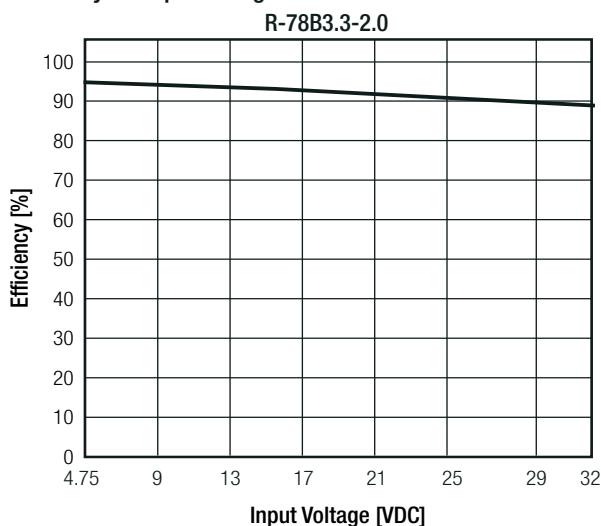

**Specifications** (measured @ Ta= 25°C, nom. Vin, full load and after warm up unless otherwise specified)

**REGULATIONS**

| Parameter       | Condition                        | Value      |
|-----------------|----------------------------------|------------|
| Output Accuracy | 100% load                        | ±2.0% typ. |
| Line Regulation | low line to high line, full load | ±0.5% typ. |
| Load Regulation | 0% to 100% load                  | ±1.0% typ. |

**PROTECTIONS**

| Parameter                      | Condition       | Value                                      |
|--------------------------------|-----------------|--|
| Short Circuit Protection (SCP) | below 100mΩ     | continuous, automatic recovery             |
| Short Circuit Input Current    | nom. Vin= 24VDC | <5Vout<br>≥5Vout<br>50mA typ.<br>75mA typ. |

**ENVIRONMENTAL**

| Parameter                   | Condition                        | Value                                    |
|-----------------------------|----------------------------------|--|
| Operating Temperature Range | without derating (see graph)     | -40°C to +70°C                           |
| Maximum Case Temperature    |                                  | +105°C                                   |
| Temperature Coefficient     |                                  | 0.02%/°C typ.                            |
| Operating Altitude          |                                  | 5000m                                    |
| Operating Humidity          | non-condensing                   | 95% RH max.                              |
| Pollution Degree            |                                  | PD2                                      |
| Vibration                   |                                  | 10-55Hz, 2G, 30min along X, Y and Z axis |
| MTBF                        | according to MIL-HDBK-217F, G.B. | +25°C<br>6349 x 10 <sup>3</sup> hours    |

**Derating Graph**

(@ Chamber and natural convection 0.1 m/s)

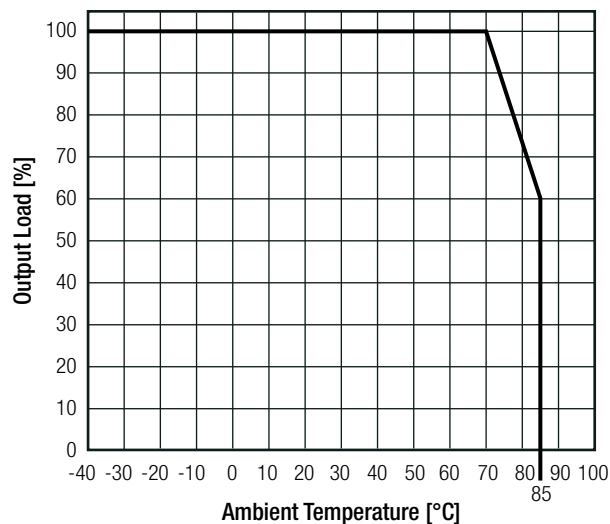

**Specifications** (measured @ Ta= 25°C, nom. Vin, full load and after warm up unless otherwise specified)

**SAFETY AND CERTIFICATIONS**

| Certificate Type (Safety)   | Report / File Number | Standard   |
|---|----------------------|--|
| Audio/video, information and communication technology equipment Safety requirements (CB Scheme) | L0339m38-B1-L        | IEC62368-1: 2014, 2nd Edition<br>EN62368-1: 2014 |
| EAC   | RU-AT.49.09571       | TP TC 004/2011                                   |
| RoHS2+  |                      | RoHS 2011/65/EU + AM2015/863                     |

| EMC Compliance  | Condition   | Standard / Criterion                 |
|---|---|--------------------------------------|
| Electromagnetic compatibility of multimedia equipment - Emission requirements                   | with external components<br>(see filter suggestion below) | EN55032, Class A<br>EN55032, Class B |
| Information technology equipment - Immunity characteristics - Limits and methods of measurement |   | EN55024:2010                         |
| Electromagnetic compatibility of multimedia equipment - Emission requirements                   |   | EN55032: 2013, Class B               |
| ESD Electrostatic discharge immunity test   | Air ±8kV; Contact ± 4kV                                   | IEC61000-4-2, Criteria A             |
| Radiated, radio-frequency, electromagnetic field immunity test                                  | 3 V/m   | IEC61000-4-3, Criteria A             |
| Fast Transient and Burst Immunity   | ±0.5kV  | IEC61000-4-4, Criteria A             |
| Surge Immunity  | ±0.5kV  | IEC61000-4-5, Criteria A             |
| Immunity to conducted disturbances, induced by radio-frequency fields                           | 3V  | IEC61000-4-6, Criteria A             |
| Power Magnetic Field Immunity   | 50Hz/ 1A/m  | IEC61000-4-8, Criteria A             |

**EMC Filtering Suggestion according to EN55032**

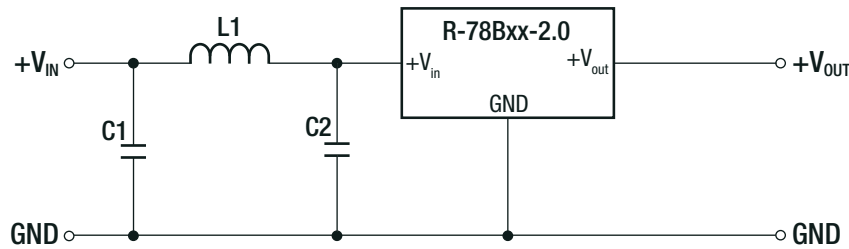

| EN55022 | C1                  | C2                  | L1          |
|---------|---------------------|---------------------|-------------|
| Class A | 4.7µF 50V MLCC 1206 | N/A                 | 3.3µH Choke |
| Class B | 10µF 50V MLCC 1210  | 4.7µF 50V MLCC 1206 | 10µH Choke  |

**DIMENSION and PHYSICAL CHARACTERISTICS**

| Parameter         | Type    | Value                |
|-------------------|---------|----------------------|
| Material          | case    | plastic, (UL94 V-0)  |
|                   | potting | silicone, (UL94 V-0) |
|                   | PCB     | FR4, (UL94 V-0)      |
| Dimension (LxWxH) |         | 11.5 x 8.5 x 17.5mm  |
| Weight            |         | 4.0g typ.            |

continued on next page

Specifications (measured @ Ta= 25°C, nom. Vin, full load and after warm up unless otherwise specified)

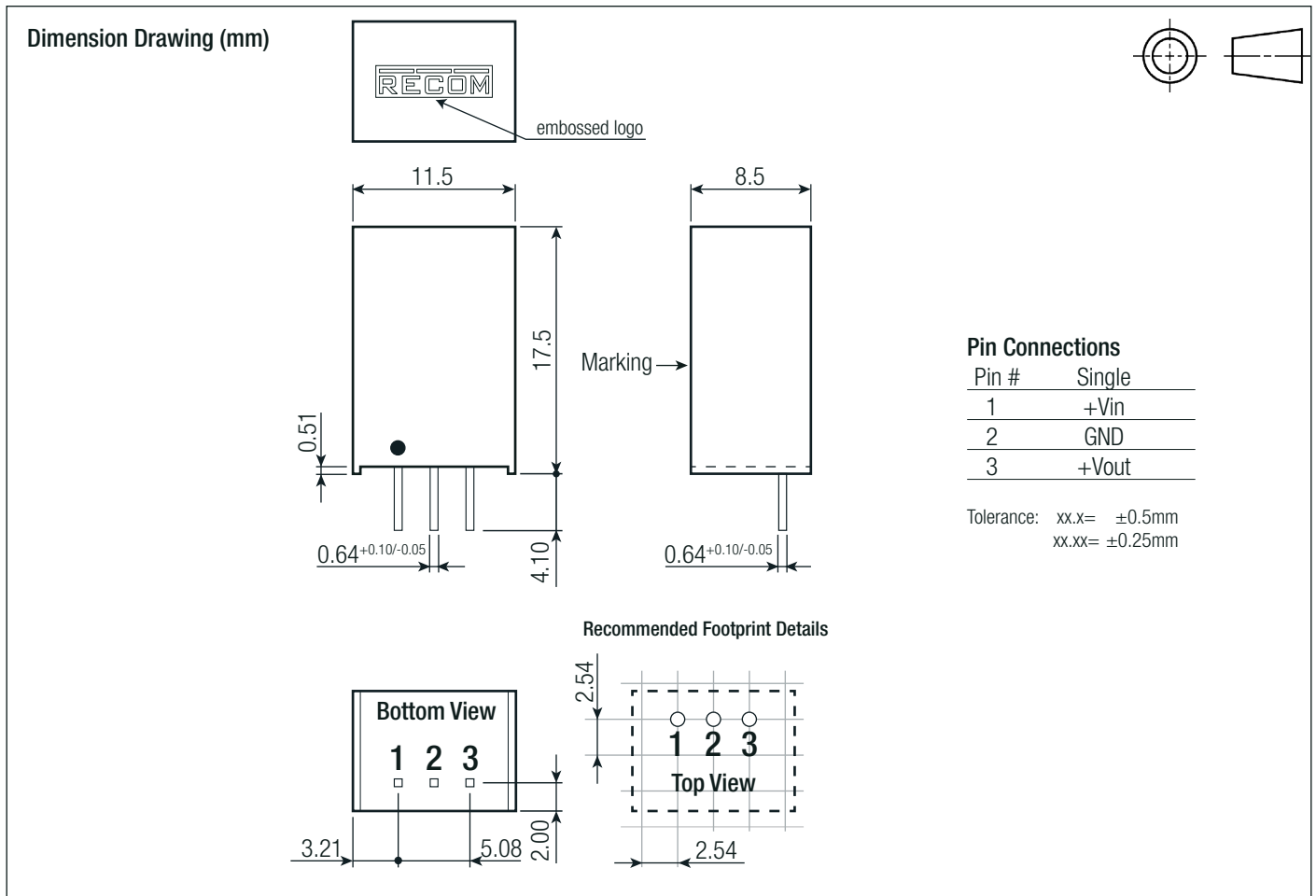

## INSTALLATION and APPLICATION

### Positive to Negative

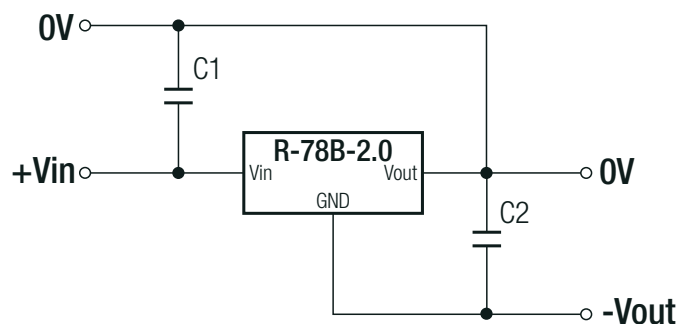

| Part Number  | Input Voltage Range [VDC] | Output Voltage [VDC] | Output Current [mA] | Efficiency @ full load @ min Vin [%] | Efficiency @ full load @ max. Vin [%] | External Capacitor [C1 / C2] |
|--------------|---------------------------|----------------------|---------------------|--------------------------------------|---------------------------------------|------------------------------|
| R-78B1.2-2.0 | 4.75 - 32                 | -1.2                 | -1000               | 86                                   | 86                                    | 10µF / 10µF                  |
| R-78B1.5-2.0 | 4.75 - 32                 | -1.5                 | -1000               | 74                                   | 87                                    | 10µF / 10µF                  |
| R-78B1.8-2.0 | 4.75 - 32                 | -1.8                 | -1000               | 76                                   | 88                                    | 10µF / 10µF                  |
| R-78B2.5-2.0 | 4.75 - 32                 | -2.5                 | -1000               | 79                                   | 89                                    | 10µF / 10µF                  |
| R-78B3.3-2.0 | 4.75 - 32                 | -3.3                 | -1000               | 83                                   | 89                                    | 10µF / 10µF                  |
| R-78B5.0-2.0 | 6.5 - 32                  | -5                   | -1000               | 86                                   | 90                                    | 10µF / 10µF                  |
| R-78B9.0-2.0 | 11 - 32                   | -9                   | -1000               | 90                                   | 91                                    | 10µF / 10µF                  |
| R-78B12-2.0  | 15 - 32                   | -12                  | -1000               | 91                                   | 92                                    | 10µF / 10µF                  |
| R-78B15-2.0  | 18 - 32                   | -15                  | -1000               | 92                                   | 93                                    | 10µF / 10µF                  |

**Specifications** (measured @ Ta= 25°C, nom. Vin, full load and after warm up unless otherwise specified)

| PACKAGING INFORMATION       |                |                       |
|-----------------------------|----------------|-----------------------|
| Parameter                   | Type           | Value                 |
| Packaging Dimension (LxWxH) | tube           | 520.0 x 25.1 x 10.6mm |
| Packaging Quantity          |                | 42pcs                 |
| Storage Temperature Range   |                | -55°C to +125°C       |
| Storage Humidity            | non-condensing | 95% RH max.           |

The product information and specifications may be subject to changes even without prior written notice. The product has been designed for various applications; its suitability lies in the responsibility of each customer. The products are not authorized for use in safety-critical applications without RECOM's explicit written consent. A safety-critical application is an application where a failure may reasonably be expected to endanger or cause loss of life, inflict bodily harm or damage property. The applicant shall indemnify and hold harmless RECOM, its affiliated companies and its representatives against any damage claims in connection with the unauthorized use of RECOM products in such safety-critical applications.

Компания «Океан Электроники» предлагает заключение долгосрочных отношений при поставках импортных электронных компонентов на взаимовыгодных условиях!

Наши преимущества:

- Поставка оригинальных импортных электронных компонентов напрямую с производств Америки, Европы и Азии, а так же с крупнейших складов мира;
- Широкая линейка поставок активных и пассивных импортных электронных компонентов (более 30 млн. наименований);
- Поставка сложных, дефицитных, либо снятых с производства позиций;
- Оперативные сроки поставки под заказ (от 5 рабочих дней);
- Экспресс доставка в любую точку России;
- Помощь Конструкторского Отдела и консультации квалифицированных инженеров;
- Техническая поддержка проекта, помощь в подборе аналогов, поставка прототипов;
- Поставка электронных компонентов под контролем ВП;
- Система менеджмента качества сертифицирована по Международному стандарту ISO 9001;
- При необходимости вся продукция военного и аэрокосмического назначения проходит испытания и сертификацию в лаборатории (по согласованию с заказчиком);
- Поставка специализированных компонентов военного и аэрокосмического уровня качества (Xilinx, Altera, Analog Devices, Intersil, Interpoint, Microsemi, Actel, Aeroflex, Peregrine, VPT, Syfer, Eurofarad, Texas Instruments, MS Kennedy, Miteq, Cobham, E2V, MA-COM, Hittite, Mini-Circuits, General Dynamics и др.);

Компания «Океан Электроники» является официальным дистрибьютором и эксклюзивным представителем в России одного из крупнейших производителей разъемов военного и аэрокосмического назначения «JONHON», а так же официальным дистрибьютором и эксклюзивным представителем в России производителя высокотехнологичных и надежных решений для передачи СВЧ сигналов «FORSTAR».



## JONHON

«JONHON» (основан в 1970 г.)

Разъемы специального, военного и аэрокосмического назначения:

(Применяются в военной, авиационной, аэрокосмической, морской, железнодорожной, горно- и нефтедобывающей отраслях промышленности)

«FORSTAR» (основан в 1998 г.)

ВЧ соединители, коаксиальные кабели,  
кабельные сборки и микроволновые компоненты:

(Применяются в телекоммуникациях гражданского и специального назначения, в средствах связи, РЛС, а так же военной, авиационной и аэрокосмической отраслях промышленности).



Телефон: 8 (812) 309-75-97 (многоканальный)

Факс: 8 (812) 320-03-32

Электронная почта: [ocean@oceanchips.ru](mailto:ocean@oceanchips.ru)

Web: <http://oceanchips.ru/>

Адрес: 198099, г. Санкт-Петербург, ул. Калинина, д. 2, корп. 4, лит. А