

FEATURING 2017 High Performance Portfolio

optical

Optical & IC Selector Guide

- TIAs
- Laser & Modulator Drivers
- Single-Lane ClearEdge™ CDRs
- Dual-Lane ClearEdge™ CDRs
- Quad-Lane ClearEdge™ CDRs
- Multi-Lane Signal Conditioners
- ROSAs
- Limiting Amplifiers
- Transceiver ICs
- Optical Reference Design Kits

contents

Overview	3
Semtech Solutions	4
New Products	5
Optical Applications	6
Laser Drivers (LD) and Limiting Amplifiers (LA)	7
TIAs	8
Transceiver IC (LD& LA)	10
ClearEdge™ CDRs	11
ROSAs	12
Copper Applications	14
Backplane & Linecard Signal Conditioners	15
Optical Module Reference Design Kits	16

High-Performance Optical & Copper Products

Semtech designs the industry's most innovative optical, analog and mixed-signal semiconductor solutions to serve the rising global demand for high-speed data transmission products.

Semtech is an active contributor to networking standards development and has shipped over half a billion optical ICs. This combination of real-world experience and industry leadership enables us to deliver best-in-class solutions for our customers' designs.

Semtech also offers one of the industry's most comprehensive portfolios of optical transceiver IC products ranging from 100Mbps to over 100Gbps, supporting key industry standards such as Fibre Channel, InfiniBand®, Ethernet, CPRI, PON, SONET, and PCI Express®. Semtech is also investing in leading-edge technologies to enable communication systems at 400Gbps and beyond.

For our optical component and module customers, this highly differentiated set of products provides a unique roadmap that improves performance and reliability, while simplifying design, lowering costs and speeding time-to-market.

For systems designers and manufacturers working on the next generation of high-speed networks, Semtech's multi-lane and multi-rate 10Gbps-100Gbps backplane solutions provide cost-effective, low power, high-performance products to enable next-generation networks.



Enabling High Performance, High-Speed

- Class leading IC solutions for 25G and 100G applications, including SFP28, QSFP28, CFPx, and AOCs
- Full portfolio of integrated solutions for all PON applications and complete reference designs
- Semtech's ClearEdge™ CDR with low power, reference-free technology
- Transimpedance amplifiers (TIAs) that exceed the IEEE Stressed Receiver Sensitivity (SRS) specifications
- High performance, low power laser drivers
- Receive Optical Sub-Assembly (ROSA) based on Semtech's Rchip technology
- Industry's first single-chip 10G PON transceivers for symmetric and asymmetric applications
- Industry's first quad CDRs enabling long reach Infiniband® QDR, 40GbE and 100GbE applications
- Full portfolio of integrated solutions to address all SFP+ and XFP modules
- Dual-lane CDRs (Tx/Rx) with integrated DML or EML driver
- Protocol-independent repeaters/redrivers
- Limiting amplifiers (LA) that provide wideband, low noise post-amplification
- SFP+ reference design kits for optical modules to decrease design time

Building the Future Together

As networking requirements continue to evolve, so will Semtech, by working with customers to provide solutions for tomorrow's networking challenges. One thing that won't change, however, is Semtech's commitment to being a reliable supplier and providing innovative approaches that deliver unrivaled performance for the most sophisticated applications.

Technology Leadership for the Future of Optical Communications

TECHNOLOGIES

ClearEdge™ CDRs

- Market leader in CDRs
- Reference-free operation
- Integrated solutions enable best performance and lowest power

TIAs

Industry leading performance and proven reliability with over 400 million sold

Laser Drivers & Limiting Amplifiers

High-performance integrated solutions for single- and multi-channel applications

ROSAs

Best-in-class sensitivity, based on our patented Rchip technology

MARKETS

100G Ethernet

Solutions for QSFP28 and CFPx modules as well as 100G AOCs

25G Ethernet

Market leading IC and ROSA solutions for SFP28 modules and AOCs

10G Ethernet & CPRI

- Complete portfolio of module IC and backplane solutions
- Solutions for XFP, SFP+, QSFP+ modules

PON/FTTH

- Industry's first fully integrated 10G PON solutions
- Highly integrated chipset solutions for EPON & GPON ONU/OLT

16G Fibre Channel

Industry's first complete integrated IC solution for 16G Fibre Channel



New Products

GN2105: Low-Power Quad 25Gbps CDR with DML Driver

- Fully integrated Quad DML driver and industry-leading ClearEdge™ CDR
- Enables <3.5W 100G QSFP28 PSM4 to LR4 designs, when coupled with GN2104S or GN2110
- DC Coupled DML driver allows for Chip-on-board and Passive DML TOSA applications
- Proprietary DML compensation technology maximizes performance with multiple DML laser vendors

GN2147 / GN2148 / GN2149: Low-Power Dual 24-28Gbps ClearEdge™ CDRs with Integrated VCSEL Driver and TIA

- GN2147 offers industry's higher integrated with Dual CDR + VCSEL Driver + TIA integrated in a compact single die size of 1.7x3.0mm
- GN2148 and GN2149 offers customer flexibility with CDR + VCSEL integration and CDR + TIA integration, respectively in a small die size of 1.2x 2.9mm
- Enables low cost, high-performance 25Gbps AOCs and SFP28 SR modules

GN1159: 1.0 to 12.5Gbps LR Transceiver Chip with Digital Diagnostics

- Based on industry proven GN1157/B
- Full suite of flexible Digital Diagnostics modes
- Advanced eye-shaping features
- Up to 92mA modulation and 120mA bias current

GN2104S: Low-Power Quad ClearEdge™ CDR 25-28Gbps

- Low power dissipation (340mW typical)
- Compact footprint ideal for QSFP28 and CFP4 modules

GN2106PS: Low-Power Quad ClearEdge™ CDR with integrated EML drivers 25-28Gbps and Integrated Bias T Components

- Fully monolithically integrated quad EML Driver and ClearEdge™ CDR with integrated Bias T components to allow easier layout
- Provides reference-free signal conditioning for CFP4 and QSFP28 modules

GN2504: Low-Power Quad ClearEdge™ CDR 25-28Gbps Reference-Free Repeater

- Provides reference-free signal conditioning on backplanes and linecards
- Low power dissipation (600mW typical)

GN2108B: Quad 24-28Gbps Transmitter Array for SR4

- Integrated ClearEdge™ CDR and VCSEL array driver
- Enable extended reach up to 300m on OM4, and 150m on OM3

GN2110B: Quad 24-28Gbps Receiver Array for SR4

- Integrated TIA array and ClearEdge™ CDR offers industry leading performance for both 850nm and 1310nm applications
- 250um channel pitch

GN3358: High Gain 11.3Gbps Limiting APD ROSA

- High output swing with pre-emphasis ideal for non-retimed applications
- Low power dissipation, best-in-class sensitivity
- Available with threshold adjust

GN3270: 28Gbps Limiting PIN ROSA

- Low power dissipation (105mW)
- For 25GbE SFP28 applications

GN25L98: ONU Transceiver IC

- PON Combo IC with integrated APD bias controller
- Single BOM can accommodate many different BOSA suppliers
- Programmable APD fault detection, shutdown and recovery

GN7151: 10G PON OLT EML/CDR Driver

- 140mA bias current
- Low power
- 2.5V modulation voltage

GN28L95: 10G PON Combo IC

- 2.5G dual loop Tx, 10G Rx
- BoB and module reference designs
- Low BOM cost

Optical Applications

Semtech products offer a comprehensive selection of optical transceiver ICs and components for all 1-10GbE, CPRI, OC-192, and 100G module form factors.

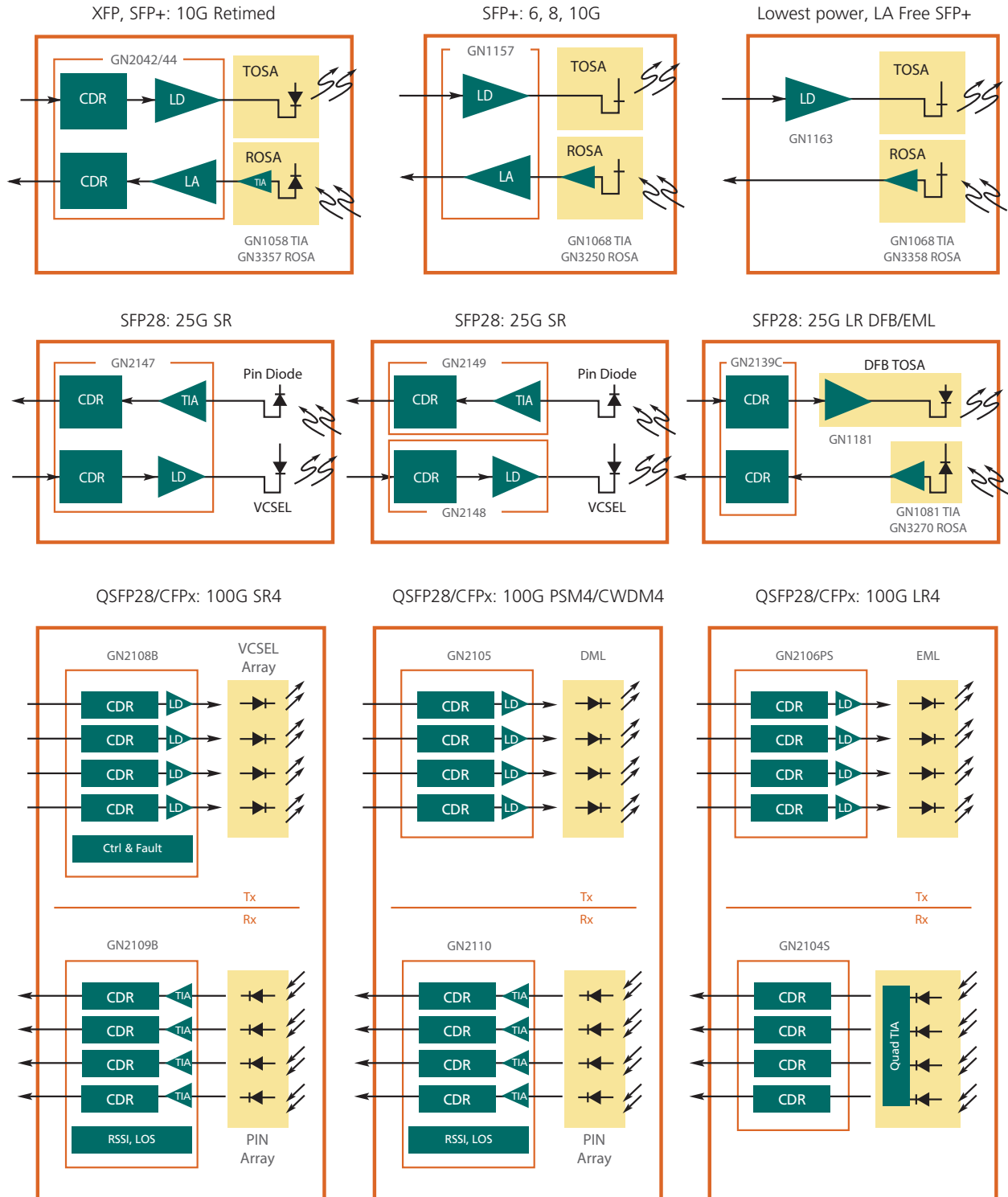

Laser Drivers and Limiting Amplifiers

High-performance laser drivers and limiting amplifiers for optical communications.

APPLICATIONS:

- 10G EPON, XG-PON1 and XG-PON2
- 8G Fibre Channel
- 9.95Gbps OC-192 and 10.70Gbps OC-192 with FEC
- 10.3Gbps Ethernet
- 10.52Gbps Fibre Channel
- 11.1Gbps Ethernet over SONET/SDH
- 11.3Gbps Fibre Channel with Forward Error Correction
- 40G QSFP+ modules
- 6Gbps and 10Gbps CPRI modules for wireless front haul
- 100Gbps Ethernet

LIMITING AMPLIFIERS:

NT20045

Low cost 3.0V to 5.5V, 200Mbps limiting amplifier for SONET, SDH, ESCON and Fast Ethernet applications over optical fiber.

NT24L73

1.25Gbps CMOS limiting amplifier with CML data outputs and signal status in an MSOP package.

LASER DRIVERS:

GN1185

High-performance Quad 25–28Gbps DML driver for active TOSAs targeting 100G applications.

GN1181

High-performance 28G single channel DML driver for active TOSAs.

NT20042

Low cost 3.3V/5.0V 300 Mbps LED driver for SONET/SDH, ESCON and Fast Ethernet applications over optical fiber.

NT22L33

3.3V/5.0V CMOS laser driver for data rates of 125Mbps to 1.25Gbps.

GN1160, GN1161, GN1163

Very low power laser drivers for DFB/VCSEL applications, RSSI feature for compatibility with our high gain ROSA's, enabling SFP+ modules without limiting amplifiers.

GN1190

Quad VCSEL driver for parallel and multi-channel datacom & telecom modules. Low power consumption, 210mW typical for 4 channels. Use with GN1090 quad TIA.

LIMITING AMPLIFIERS

Part Number	Overview	Data Rate (Gbps)	Gain (dB)	BW	Supply (V)	Noise Figure (uV)	Applications
NT20045	200Mbps Limiting Amp	0.2	60	0.125	3.3/5.0	80	OC-3, Fast Ethernet
NT24L73	1.25Gbps Limiting Amp	1.25	46	0.938	3.3	300	OC-3, OC-12, GbE

LASER DRIVERS

Part Number	Overview	Data Rate (Gbps)	Max Mod / Bias Current (mA)	Supply (V)	Pkg	Applications
NT20042	300Mbps LED Driver	0.3	100	3.3/5.0	QSOP-16	OC-3, Fast Ethernet
NT22L33	1.25Gbps FP/DFB Laser Driver	1.25	70/80	3.3/5.0	QFN-24 (4mm)	OC-3, OC-12, GbE
GN1160	DFB Driver	to 11.3	90/120	3.3 (Opt. 2.8)	QFN-28	10GE SFP+ 10GBASE-LR
GN1163*	DFB Driver	to 11.9	90/120	3.3 (Opt. 2.8)	QFN-24	QSFP+ 10GBASE-LR
GN1161*	VCSEL Driver	to 11.3	20/15	3.3 (Opt. 2.8)	QFN-28	10GbE SFP+ 10GBASE-SR
GN1190	Quad VCSEL Driver	to 14.3	12/12	3.3	Bare Die	40Gbps Ethernet, Infiniband, QSFP+
GN1181*	DFB Driver	25-28	55m/70	2.3/3.3	Bare Die	25GbE and 100GbE Ethernet active TOSA
GN1185*	Quad DFB driver	25-28	55m/70	2.3/3.3	Bare Die	100GbE Ethernet active TOSA

* Please contact your sales representative for more details.

TIA's

Wideband, low noise transimpedance amplifiers (TIAs) for your optical communication applications.

Semtech offers a portfolio of fully integrated BiCMOS and pure CMOS transimpedance amplifiers providing wideband, low noise pre-amplification of a current signal from a PIN photodiode or APD.

Semtech's TIAs offer best-in-class performance in limiting, linear or automatic gain control versions for use in high-performance optical receivers operating from 155Mbps to 28Gbps.

FEATURES

- Wideband, low noise
- Limiting, linear and AGC versions
- Fully integrated on-chip de-coupling for low cost and best performance

APPLICATIONS

- ITU/IEEE-based transmission systems
- 10G and 100G Ethernet
- SONET/SDH based transmission systems, test equipment and optical modules from OC-3 to OC-192
- 8G and 16G Fibre Channel
- Serial data systems up to 28Gbps
- PON/FTTH systems – BPON, EPON, GPON, 10GEPON and XG-PON
- 6G and 1–12G CPRI modules for wireless front haul
- 100Gbps client side modules

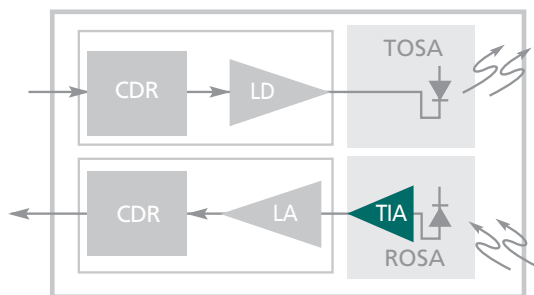

GN1081, GN1084, GN1085

1x28Gbps and 4x28Gbps limiting TIA optimized for 100GBASE-LR4 applications.

GN7068

10Gbps limiting TIA designed for APD applications such as ROSAs for 10G PON OLT and 10GBASE-ZR transceivers modules.

GN7050, GN7051, GN7052, GN7053

Limiting TIA designed specifically for 1G EPON, 1G GPON, 2.5G XG-PON and 10G EPON OLT applications.

GN1068

14Gbps multi-rate limiting TIA providing high gain and wideband performance for use in Ethernet and 16G Fibre Channel applications.

GN1056

10Gbps linear TIA for high-performance APD applications such as ultra-long haul telecom and submarine applications.

GN1058

10Gbps high gain TIA optimized for applications requiring AGC, such as 10GBASE-LRM and DWDM receivers for low OSNR environments.

GN1090

Quad 14.5Gbps array receiver for parallel and multi-channel datacom and telecom modules. Advanced receiver design for excellent optical performance and very low power consumption (240mW total for 4 channels). Use with GN1190 Quad VCSEL Driver.

NT25L55

2.5Gbps Super TIA for GPON ONU with high sensitivity better than -30dBm over all conditions.



NT25L51

2.5Gbps CMOS TIA for FTTH and Telecom Fiber transceiver applications with automatic gain control enabling over 27dB of dynamic operating range.

NT24L55

Super high sensitivity, high-performance CMOS 1.25Gbps TIA with 35dB of dynamic operating range designed for FTTH applications such as GEAPON transceivers and long haul telecom/datacom applications.

NT24L50

1.25Gbps high sensitivity TIA with automatic gain control for FTTH and Datacom Fiber transceiver applications.

NT23L50

622Mbps high sensitivity TIA for FTTH and Telecom Fiber transceiver applications.

NT20R67

Low cost 3.3V to 5.0V CMOS PIN TIA with automatic gain control and more than 43dB dynamic range for Optical Fiber applications up to 200Mbps.

TIA's

Part Number	Overview	Data Rate (Gbps)	Gain (k Ω)	BW (GHz)	Supply (V)	Noise	Applications
NT20R67	155Mbps AGC TIA	0.155	63	0.165	3.3/5.0	11nA	OC-3, Fast Ethernet
NT20067	155Mbps AGC TIA	0.155	23	0.165	3.3/5.0	11nA	OC-3, Fast Ethernet
NT23L50	622Mbps AGC TIA	0.622	50	0.32	3.3	60nA	OC-12, BPON
NT24L50	1.25Gbps AGC TIA	1.25	25	0.75	3.3	92nA	GbE, EPON
NT24L55	1.25Gbps High Sensitivity AGC TIA	1.25	46	0.75	3.3	74nA	EPON
NT25L51	2.5Gbps AGC TIA	2.5	8	1.7	3.3	230nA	OC-48, GPON (APD)
GN25L53*	3.1Gbps AGC TIA	3.1	5.5	1.9	3.3	335nA	CPRI, GPON, OC-48 (APD)
NT25L55*	2.5Gbps High Sensitivity AGC TIA	2.5	21	1.4	3.3	87nA	GPON (PD)
NT28L52*	10G Limiting	to 10.3	2.35	7	3.3	1.2 μ A	PON, 10GBASE-SR
GN1056	10G Linear	to 11.3	500/1	12	3.3	1 μ A	OC-192
GN1058	10G Linear AGC	to 11.3	4	12	3.3	1 μ A	10GBASE-LRM & DWDM
GN7068	10G Limiting	to 11.3	3	12	3.3	1 μ A	APD ROSAs for 10G PON ONU & 10GBASE-ZR
GN1068	14G Limiting	to 14.3	6.75	12	3.3	1.2 μ A	CPRI, 10GBASE-SR/LR/ER & 16G FC
GN1090	Quad 10G limiting	to 14.3	*	*	3.3	0.9 μ A	40Gbps Ethernet; Infiniband, QSFP+
GN7050*	1.25G Burst Mode Limiting	1.25	13	1.0	3.3	*	1G EPON OLT
GN7052*	Tri-rate PON TIA	1.25/ 2.5/ 10.3	13/ 1.2/ 2.3	1.1/ 2.5/ 8.7	3.3	*	1.25G EPON/ 2.5G XG-PON/ 10G EPON OLT
GN7053*	1G GPON Burst Mode Limiting	1.25	1.25	1.5	3.3	*	1G GPON OLT
GN1081*	28G Limiting	28	6	22	3.3	1.78 μ A	25Gbps and 100Gbps Ethernet/ OTN, Infiniband EDR
GN1084*	25G Limiting	25	6	22	3.3	2.3 μ A	25Gbps and 100Gbps Ethernet
GN1085*	Quad 28G Limiting	28	6	22	3.3	1.78 μ A	100Gbps Ethernet/OTN, Infiniband EDR

* Please contact your sales representative for more details.

Transceiver ICs (LD & LA)

High-performance laser drivers and limiting amplifiers for optical communications.

GN1157/57B/59/58

Semtech's latest, lowest power transceiver IC for SFP+ LR/SR applications with integrated APC and advanced eye shaping features.

GN28L95

Combined 10Gbps limiting post amplifier and 2.5Gbps burst mode laser driver for cost critical 10GEAPON and XG-PON asymmetric applications. GN28L95 features robust automatic ER control and integrated APD controller.

GN25L96, GN25L96

2.5Gbps CMOS programmable burst mode laser driver and post amplifier optimized for wide laser compatibility and TIA sensitivity.

GN25L98

2.5Gbps CMOS burst mode laser driver and limiting post amplifier with automatic ERC control and integrated APD controller.

GN7354, GN7355

10G EPON transceiver for next-generation PON systems. The GN7355 combines a 10G burst mode laser driver with a receive CDR and is targeted at 10G EPON symmetric applications. The GN7354 is a pin-for-pin compatible, de-rated version of the GN7355 intended to address the 1.25Gbps and 2.5Gbps transmit data rate, and cost pressures of the 10Gbps asymmetric EPON and XG-PON applications.

GN1411A/12B/44/44S

The GN1411A/GN1412A are highly-integrated, low-power, small footprint transceivers that are ideal for SFP+ LR/ER optical modules.

Transceiver IC (LD&LA)						
Part Number	Overview	Data Rate (Gbps)	Max Mod/Bias Current (mA)	Supply (V)	Package	Applications
GN25L95*	Burst Mode DFB + Receive LA	to 2.5	90/100	3.3	QFN-28	EPON, GPON, BOSA-on-Board
GN25L96*	Programmable Burst Mode DFB + Receive LA	to 2.5	90/100	3.3	QFN-28	EPON, GPON, BOSA-on-Board, SFP
GN25L98*	Burst Mode DFB + Receive LA + APD Controller	to 2.5	90/100	3.3	QFN-28	EPON, GPON, BOSA-on-Board
GN25L95C*	SFP Burst Mode DFB + Receive LA	3.1G to 125M	90/100	3.3	QFN-28	Single and multi rate SFP
NT28L90	2.5Gbps Burst Mode DFB + 10 Gbps Receive LA	Rx 10.3 Tx 2.5	90/100	3.3	QFN-28	10GbE EPON, XG-PON1 (Asymmetric)
GN28L95	2.5Gbps Burst Mode DFB + 10Gbps Receive LA	Rx 10.3, Tx 2.4G	100/85	3.3	QFN-32	10GbE EPON, XG-PON (Asymmetric)
GN7354*	Burst Mode DFB + Receive LA & CDR	Rx 10.3 Tx to 2.5	90/90	3.3 (3.3 or 5 output stage)	QFN-32	10GbE EPON, XG-PON (Asymmetric)
GN7355	Burst Mode DFB + Receive LA & CDR	10.3	90/90	3.3 + 5 output stage (optional 3.3V)	QFN-32	10GbE EPON, XG-PON (Symmetric)
GN1412B*	EML Laser Driver + Receive LA	to 11.3	2.5Vpp/120mA	3.3	QFN-32	10GbE, OC-192
GN1444S*	EML Laser Driver + Receive LA	to 11.3	2.5Vpp/120mA	1.8 & 3.3	QFN-32	10GbE, OC-192
GN1157	DML Laser Driver + Receive LA	to 11.3	90/120	3.3 (Optional 2.8)	QFN-28	10GbE LR SFP+, CPRI
GN1157B*	DML Laser Driver + Receive LA	to 12.5	90/120	2.4 & 3.3	QFN-28	10GbE LR SFP+, CPRI
GN1158	VCSEL Laser Driver + Receive LA	to 11.3	20/15	3.3 (Optional 2.8)	QFN-28	10GbE SR SFP+

* Please contact your sales representative for more details.

ClearEdge™ CDRs

Semtech's multi-lane signal conditioners based on our reference-free ClearEdge™ CDR platform with integrated drivers and TIAs offer the lowest power, smallest footprint solutions for XFP, retimed SFP+, 25G and 100G modules, and AOCs.

ENABLING NEXT-GENERATION 100G MARKETS

Semtech 100G ClearEdge™ CDR portfolio integrates our proven Quad 24G-28G CDRs with VCSEL, DML or EML drivers for transmit with TIAs for receive, targeting both short reach and long reach modules. Our proven integration and the industry's lowest power and superior performance simplifies 100G designs and lowers cost.

ENABLING SFP28 AND 25GBS AOCs

The GN2147 dual CDR with integrated VCSEL driver and TIA enables high-performance and low cost SFP28 SR modules and AOCs. The single chip design and advanced transmit compensation enables low cost solutions using a single lens design as well as low bandwidth VCSELs for exceptional BOM savings.

FEATURE SET FOR DWDM AND TUNABLE APPLICATIONS

The GN2040 family has a rich feature set to enable optimal performance in DWDM and Tunable applications. The features include slice level adjust, programmable peaking on the receive path input and sampling clock phase adjust.

LOW COST, SMALL FOOTPRINT SOLUTION

Semtech's fully integrated CDR solutions including the GN2040 family and GN2017A enable high density module designs including DWDM, Fibre Channel and Tunable applications. Package solutions at 5x5mm 32-QFN and even as small as 4x4mm 32-QFN are available with full feature sets.

ClearEdge™ CDRs								
Part Number	Data Rate (Gbps)	Lanes	Laser Driver	TIA	Slice Level Adjust	Pin Compatibility	Package	Applications
GN2042*	9.95–11.3	2 (1Rx + 1Tx)	DML	–	Yes	GN2044	QFN-32	XFP & SFP+, 10GbE & OC-192 Enables 1W Retimed SFP+10km
GN2044*	9.95–11.3	2 (1Rx + 1Tx)	EML	–	Yes	GN1444, GN2042	QFN-32	XFP and SFP+ 10GbE, OC-192 & DWDM Enables 1.5W Retimed SFP+ 40/80km
GN2044S*	9.95–11.3	2 (1Rx + 1Tx)	EML	–	Yes	GN1444S	QFN-32	Tunable SFP+, OC-192 & DWDM Enables 1.5W Retimed TSFP+
GN2040*	9.95–11.3	2 (1Rx + 1Tx)	DML	–	Yes	GN204x	QFN-32	XFP and SFP+, 10GbE, OC-192 and DWDM
GN2017A*	9.95–11.7 14.025	2 (1Rx + 1Tx)	VCSEL	–	No	GN2010X	QFN-32	16G FC, 10G FCoE
GN2104S*	25–28	4	–	–	Yes	–	FC-CSP	100Gbps Ethernet, Infiniband EDR
GN2106PS*	25–28	4	EML	–	Yes	–	BGA	100Gbps Ethernet/OTN, Infiniband EDR
GN2108	25	4	VCSEL	–	Yes	–	Die	100Gbps Ethernet SR4
GN2109*	25	4	–	Yes	Yes	GN2110	Die	100Gbps Ethernet SR4, PSM4
GN2110*	25–28	4	–	Yes	Yes	GN2109	Die	100Gbps Ethernet/OTN PSM4, CWDM4, CLR4
GN2105*	25–28	4	DML	–	Yes	–	FC-BGA	100Gbps Ethernet, PSM4, CWDM4, CLR4
GN2147	24–28.1	2 (Rx + Tx)	VCSEL	Yes	–	–	Die	25Gbps AOC
GN2148	24–28.1	1 Tx	VCSEL	–	–	–	Die	SFP28 SR
GN2149	24–28.1	1 Rx	–	Yes	–	–	Die	SFP28 SR
GN2139C*	24–26.5	2 (Rx + Tx)	–	–	–	–	CSP	SFP28 LR & ER

* Please contact your sales representative for more details.

ROSAs

Best-in-class receive optical sub-assemblies (ROSAs) based on patented Rchip technology.

Semtech's complete line of PIN and APD ROSA products spans 1310nm nanometer (nm) to 1550nm including limiting, linear and automatic gain control (AGC) functionality. Our PIN ROSAs operate at $+3.3V \pm 10\%$ and from $-40^{\circ}C$ to $+85^{\circ}C$, with highly accurate RSSI functionality and industry best dynamic range. The ROSA products feature patented Rchip packaged in a fully compliant SC or LC type optical subassembly and are available with optional flex circuits.

Super high gain Rchip ROSAs deliver $35k\Omega$ of gain that eliminates the cost and power of the limiting amplifier for SFP+ applications.

FEATURES:

- Best-in-class stressed receiver sensitivity
- High gain to ensure exceptional crosstalk performance within the module
- Patented Rchip technology to ensure maximum module manufacturing yield
- Super high gain delivers most integrated, lowest power SFP+ solution

APPLICATIONS:

- 10GBASE-SR
- 10GBASE-LR
- 10GBASE-ER
- 10GBASE-LRM
- OC-192 SR-1
- OC-192 IR-2
- 10G EPON
- 80km
- DWDM
- 8GFC & 10GFC
- 25G Ethernet



GN3050

10km limiting ROSA provides excellent performance achieving $-21dBm$ unstressed sensitivity. Ideal for 10GBASELR and SR1.

GN3250

10/40 km XMD compatible limiting ROSA provides excellent $-21dBm$ unstressed sensitivity and high ORL for 10GBASE-ER and IR-2 applications.

GN3052

AGC ROSA for 10GbE LRM and linear applications. Interoperability with all leading EDC solutions for LRM.

GN3357

11.3Gbps APD ROSA with high gain linear AGC TIA for both 80km limiting and DWDM applications requiring excellent OSNR performance.

GN3257

10/40km linear AGC ROSA offering excellent performance in low-OSNR environments, coupled with low power consumption.

GN3268

10/40km XMD compatible low power (94mW) limiting ROSA.

GN3270

A limiting 25Gbps PIN ROSA in a TO-46 style co-axial package, with excellent sensitivity performance coupled with low power consumption.



GN3250
ROSA

ROSAs & Super High Gain ROSAs

Part Number	Overview	Data Rate (Gbps)	Gain (kΩ)	Supply	RSSI	Unstressed Sensitivity	Comments	ORL
GN3050	10km Rchip Limiting	to 11.3	10	+3.3V ±10%	Yes	-21dBm	-16.8dBm OMA (Stressed sens.)	-14dB
GN3250	40km Rchip Limiting	to 11.3	10	+3.3V ±10%	Yes	-21dBm	-16.0dBm OMA (Stressed sens.)	-27dB
GN3052	LRM Rchip AGC	to 11.3	9	+3.3V ±10%	Yes	-17dBm OMA	-12dBm OMA (Stressed sens.)	-14dB
GN3155*	SR Super High Gain Rchip	to 11.3	35	+3.3V ±10%	Yes	-15dBm OMA	Eliminates LA in SFP+	-14dB
GN3055*	10km Super High Gain Rchip	to 11.3	35	+3.3V ±10%	Yes	-21dBm	Eliminates LA in SFP+	-14dB
GN3255*	40km Super High Gain Rchip	to 11.3	35	+3.3V ±10%	Yes	-21dBm	Eliminates LA in SFP+	-27dB
GN3068*	10km Low Power Limiting	to 11.3	7	+3.3V ±10%	Yes	-21dBm	94mW power dissipation	-14dB
GN3268*	40km Low Power Limiting	to 11.3	7	+3.3V ±10%	Yes	-21dBm	94mW power dissipation	-27dB
GN3257*	PIN with AGC	to 11.3	8.5	+3.3V ±10%	Yes	-19dBm	–	-27dB
GN3352	APD with AGC	to 11.3	4	+3.3V ±10%	VAPD	-27dBm	–	-27dB
GN3357*	High Gain APD with AGC	to 11.3	8.5	+3.3V ±10%	VAPD	-27dBm	–	-27dB
GN3358*	High Gain APD Rchip	to 11.3	13	+3.3V ± 10%	VAPD	-27dBm	Ideal for non-retimed SFP+	-27dB
GN3368*	Limiting APD RChip	to 11.3	4	+3.3V ±10%	VAPD	-27dBm	–	-27dB
GN3270*	25G Limiting PIN ROSA	28	6	+3.3V ±10%	Yes	-14dBm	SFP28 LR applications	-27dB

* Please contact your sales representative for more details.

Copper Applications

Semtech offers a comprehensive selection of IC solutions for high speed serial line card and backplane communication applications.

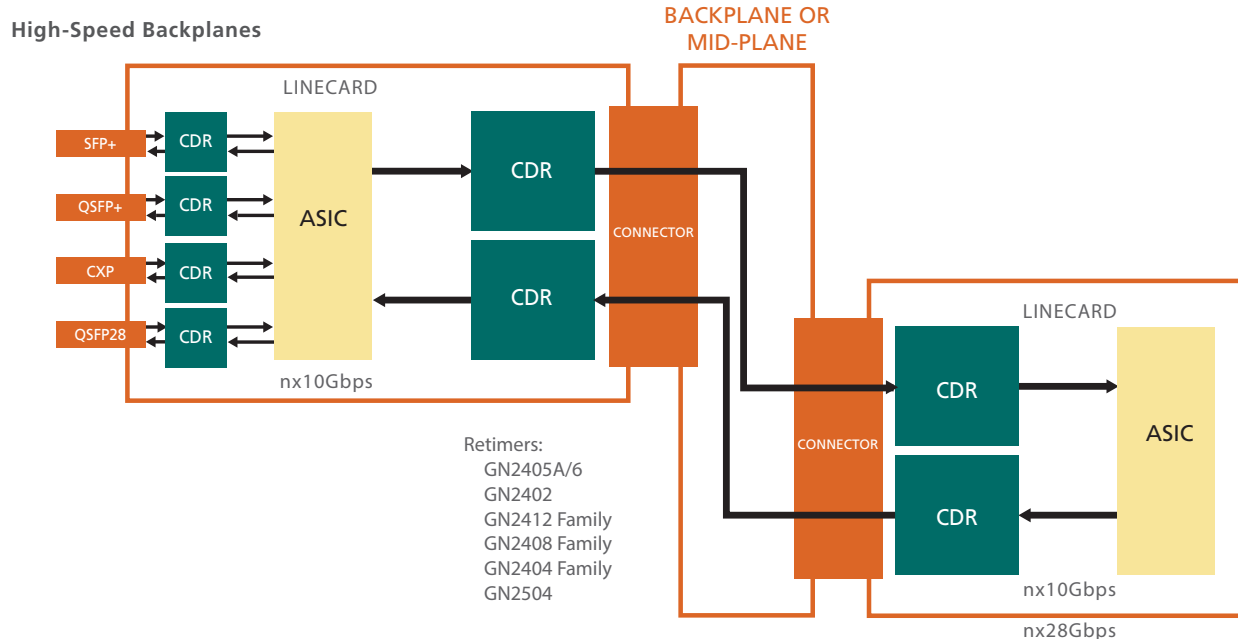

Backplane & Linecard Signal Conditioners

Semtech's multi-channel signal conditioners enhance the reach and robustness of high-speed serial links by compensating for transmission losses and re-setting the crosstalk and jitter budgets.

HIGH LEVEL OF INTEGRATION AND SMALL FOOTPRINT

Semtech's backplane and linecard signal conditioners are ideal for small form factor modules or dense backplane/linecard applications.

FULL PORTFOLIO

Semtech products offer solutions for Ethernet, Infiniband, Fibre Channel and PCI Express. Solutions are available with and without CDR functionality.

DRIVE LONG BACKPLANES OR CABLES

A combination of Equalizer, DFE and ClearEdge™ CDR technology allows for an optimal solution to drive long, dense backplanes or cables at high speeds.

LOW POWER

Semtech's ClearEdge™ CDR products require the lowest power in the industry, a key factor as densities increase.

RESET THE JITTER AND CROSSTALK BUDGETS

Using CDRs will reset the jitter budget, substantially increasing the robustness of the system and allowing for design flexibility. Using CDRs in multi-channel systems will also reset the crosstalk budget, an increasing concern at higher data rates.

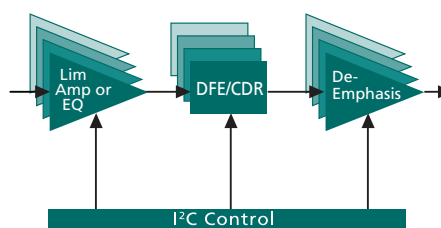

Multi-Lane Signal Conditioners

Part Number	Data Rate (Gbps)	Lanes	CDR	Ref Clock	Input Stage	De-emphasis	Supply (V)	Pkg	Applications
GN2504*	25.6–28.1	4	Yes	Not Req.	Adaptive Equalizer	Yes	1.8	QFN-54	25G/50G/100G Linecards, nx28G Backplanes, 25G/50G/100G Active Copper Cables
GT1706 Family*	1.25–14.5	6	Yes	Req.	Adaptive Equalizer	Yes	0.9 1.8	BGA-144	HD/3G/4K/8K Video Broadcast testing Fibre Channel/Infiniband/Ethernet Link Testing BERT Developments
GN2412 Family*	1.25–12.8	12	Yes	Req.	Adaptive Equalizer DFE	Yes	0.9 1.8	BGA-144	>nx10G Backplanes, 10G/40G/100G Linecards, 10G-KR, 40G-KR4, 40G-CR4, Crosspoint Switching, CPRI
GN2408 Family*	1.25–12.8	8	Yes	Req.	Adaptive Equalizer DFE	Yes	0.9 1.8	BGA-144	>nx10G Backplanes, 10G/40G Linecards, 10G-KR, Crosspoint Switching, CPRI
GN2404 Family*	1.25–12.8	4	Yes	Req.	Adaptive Equalizer DFE	Yes	0.9 1.8	BGA-144	>nx10G Backplanes, 10G/40G Linecards, 10G-KR, 40G-KR4, 40G-CR4, Crosspoint Switching, CPRI
GN2402*	10.3125	4	Yes	Not Req.	Equalizer	Yes	3.3	QFN-44	nx10G Backplanes, 10G/40G Linecards, 10G/40G Active cables
GX4002	9.9–11.3, 14.025	2	Yes	Not Req.	Equalizer	Yes	3.3	QFN-32	nx10G Backplanes, 10G/40G Linecards, Infiniband FDR, 16G Fibre Channel, Crosspoint Switching
GN2405A/5S*	9.95–11.3	4	Yes	Not Req.	Equalizer	Yes	3.3	QFN-48	nx10G Backplanes 10G/40G Linecards 10G/40G Active cables
GN2406/6S*	9.95–10.95	4	Yes	Not Req.	Limiting Amp	Yes	3.3	QFN-48	10G/40G Linecards
GN1407	1–8	4	No	Not Req.	Equalizer	No	1.2 1.8	QFN-56	PCIe Gen 1/2/3, SNAP-12, POP-4/LX-4/CX-4/KX-4, XAUI/RXAUI and Rapid I/O
GN1406	2.5, 3.125, 5.0, 6.25	4	Yes	Req.	Equalizer	Yes	1.2 1.8	QFN-56	PCIe Gen 1/2, SNAP-12, POP-4/LX-4/CX-4/KX-4, XAUI/RXAUI and Rapid I/O

* Please contact your sales representative for more details.

Optical Module Reference Design Kit

Improve the performance and time to market of your SFP+ design with Semtech Optical Module Reference Design Kits.

FAST TIME-TO-MARKET

Semtech's reference design kits offer training through schematics, layout files and a design guide as well as prompt support from our experienced applications engineers, reducing both design costs and time to market. This type of system is currently executed in the FTTx market, as the ability to reuse the 10G symmetric SFP+ design to address the 10G asymmetric market is incorporated.

BROAD RANGE OF REFERENCE DESIGNS AVAILABLE

Reference design kits are offered to cover a wide variety of SFP+ applications, including symmetrical and asymmetrical PON, and 10GbE SR and LR applications.

For Ethernet SFP+, designs are available for both the traditional architecture (including a LA in the receive chain), as well as a new LA-free architecture enabled by Semtech's High Gain ROSA portfolio.

GN1157B RDK (RDK-GN1157B-SFP+00)

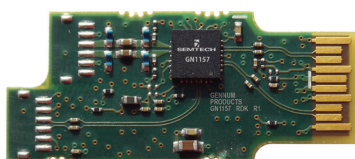

GN1160/GN3055 RDK (RDK-SFP+-Optical04)

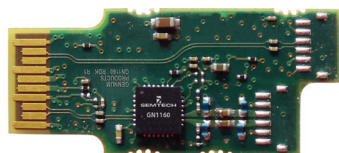

GN7354/7355 RDK, RDK-SFP+-PON-S00, RDK-SFP+-PON-A00

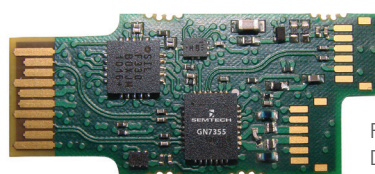

Rx CDR+ Tx Burst Mode
DML driver
GN7355 - Symmetric PON
GN7354 - Asymmetric PON

RDK-SFP++LR

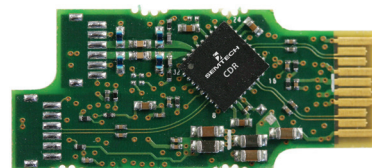

OPTICAL MODULE REFERENCE DESIGN KITS					
Part Number	Parts Demonstrated	Data Rate (Gbps)	Connector Type	Wavelength (nm)	Applications
RDK-SFP++LR	GN3068/GN3268, GN2010D/GN2042	9.95–11.3	SFP+	1310	10GbE LR, OC-192
RDK-SFP++ER	GN3268, GN2010EA/GN2044	9.95–11.3	SFP+	1550	10GbE ER, OC-192
RDK-SFP+-PON-S00	GN7355	10.3	SFP+	1577/1270	10G EPON
RDK-SFP+-PON-A00	GN7354	10/1.25 10/2.5	SFP+	1577/1310 1577/1270	10G EPON Asym. XG-PON1
RDK-SFP+-Optical02	GN1157	1–11.3	SFP+	1310	10GbE LR & CPRI
RDK-GN1157B-SFP+00	GN1157B	1–12.5	SFP+	1310	10GbE LR & CPRI
RDK-SFP+-Optical03	GN1158	1–11.3	SFP+	850	10GbE SR
RDK-SFP+-Optical04	GN1160, GN3055	1–11.3	SFP+	1310	10GbE LR

Design files and results available upon request.



Semtech Corporation 200 Flynn Road, Camarillo, California 93012

phone: (805) 498-2111 • fax: (805) 498-3804 • email: canada@semtech.com • www.semtech.com

Mouser Electronics

Authorized Distributor

Click to View Pricing, Inventory, Delivery & Lifecycle Information:

[Semtech:](#)

[NT25L51-WP](#) [NT24L50-WP](#)

Компания «Океан Электроники» предлагает заключение долгосрочных отношений при поставках импортных электронных компонентов на взаимовыгодных условиях!

Наши преимущества:

- Поставка оригинальных импортных электронных компонентов напрямую с производств Америки, Европы и Азии, а так же с крупнейших складов мира;
- Широкая линейка поставок активных и пассивных импортных электронных компонентов (более 30 млн. наименований);
- Поставка сложных, дефицитных, либо снятых с производства позиций;
- Оперативные сроки поставки под заказ (от 5 рабочих дней);
- Экспресс доставка в любую точку России;
- Помощь Конструкторского Отдела и консультации квалифицированных инженеров;
- Техническая поддержка проекта, помощь в подборе аналогов, поставка прототипов;
- Поставка электронных компонентов под контролем ВП;
- Система менеджмента качества сертифицирована по Международному стандарту ISO 9001;
- При необходимости вся продукция военного и аэрокосмического назначения проходит испытания и сертификацию в лаборатории (по согласованию с заказчиком);
- Поставка специализированных компонентов военного и аэрокосмического уровня качества (Xilinx, Altera, Analog Devices, Intersil, Interpoint, Microsemi, Actel, Aeroflex, Peregrine, VPT, Syfer, Eurofarad, Texas Instruments, MS Kennedy, Miteq, Cobham, E2V, MA-COM, Hittite, Mini-Circuits, General Dynamics и др.);

Компания «Океан Электроники» является официальным дистрибьютором и эксклюзивным представителем в России одного из крупнейших производителей разъемов военного и аэрокосмического назначения «JONHON», а так же официальным дистрибьютором и эксклюзивным представителем в России производителя высокотехнологичных и надежных решений для передачи СВЧ сигналов «FORSTAR».



JONHON

«JONHON» (основан в 1970 г.)

Разъемы специального, военного и аэрокосмического назначения:

(Применяются в военной, авиационной, аэрокосмической, морской, железнодорожной, горно- и нефтедобывающей отраслях промышленности)

«FORSTAR» (основан в 1998 г.)

ВЧ соединители, коаксиальные кабели, кабельные сборки и микроволновые компоненты:

(Применяются в телекоммуникациях гражданского и специального назначения, в средствах связи, РЛС, а так же военной, авиационной и аэрокосмической отраслях промышленности).



Телефон: 8 (812) 309-75-97 (многоканальный)

Факс: 8 (812) 320-03-32

Электронная почта: ocean@oceanchips.ru

Web: <http://oceanchips.ru/>

Адрес: 198099, г. Санкт-Петербург, ул. Калинина, д. 2, корп. 4, лит. А