

# BAT54CLT1G, SBAT54CLT1G

## Dual Common Cathode Schottky Barrier Diodes

These Schottky barrier diodes are designed for high speed switching applications, circuit protection, and voltage clamping. Extremely low forward voltage reduces conduction loss. Miniature surface mount package is excellent for hand-held and portable applications where space is limited.

### Features

- Extremely Fast Switching Speed
- Low Forward Voltage – 0.35 V (Typ) @  $I_F = 10$  mA
- AEC Qualified and PPAP Capable
- S Prefix for Automotive and Other Applications Requiring Unique Site and Control Change Requirements
- These Devices are Pb-Free, Halogen Free/BFR Free and are RoHS Compliant\*

### MAXIMUM RATINGS ( $T_J = 125^\circ\text{C}$ unless otherwise noted)

Rating	Symbol	Value	Unit
Reverse Voltage	$V_R$	30	V
Forward Power Dissipation @ $T_A = 25^\circ\text{C}$ Derate above $25^\circ\text{C}$	$P_F$	225 1.8	mW mW/ $^\circ\text{C}$
Thermal Resistance (Note 1) Junction-to-Ambient (Note 2)	$R_{\theta JA}$	508 311	$^\circ\text{C}/\text{W}$
Forward Current (DC)	$I_F$	200 Max	mA
Non-Repetitive Peak Forward Current $t_p < 10$ msec	$I_{FSM}$	600	mA
Repetitive Peak Forward Current Pulse Wave = 1 sec, Duty Cycle = 66%	$I_{FRM}$	300	mA
Junction Temperature	$T_J$	-55 to +125	$^\circ\text{C}$
Storage Temperature Range	$T_{stg}$	-55 to +150	$^\circ\text{C}$

Stresses exceeding Maximum Ratings may damage the device. Maximum Ratings are stress ratings only. Functional operation above the Recommended Operating Conditions is not implied. Extended exposure to stresses above the Recommended Operating Conditions may affect device reliability.

1. FR-4 @ Minimum Pad.
2. FR-4 @ 1.0 x 1.0 inch Pad.

\*For additional information on our Pb-Free strategy and soldering details, please download the ON Semiconductor Soldering and Mounting Techniques Reference Manual, SOLDERRM/D.



ON Semiconductor®

<http://onsemi.com>

## 30 VOLT DUAL COMMON CATHODE SCHOTTKY BARRIER DIODES

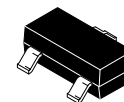

SOT-23  
CASE 318  
STYLE 9

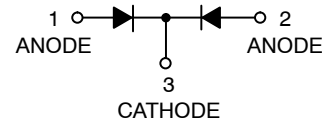

### MARKING DIAGRAM

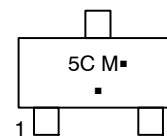

5C = Device Code  
M = Date Code  
▪ = Pb-Free Package

(\*Note: Microdot may be in either location)

\*Date Code orientation and/or position may vary depending upon manufacturing location.

### ORDERING INFORMATION

Device	Package	Shipping†
BAT54CLT1G	SOT-23 (Pb-Free)	3,000 / Tape & Reel
SBAT54CLT1G	SOT-23 (Pb-Free)	3,000 / Tape & Reel
BAT54CLT3G	SOT-23 (Pb-Free)	10,000 / Tape & Reel

†For information on tape and reel specifications, including part orientation and tape sizes, please refer to our Tape and Reel Packaging Specifications Brochure, BRD8011/D.

# BAT54CLT1G, SBAT54CLT1G

## ELECTRICAL CHARACTERISTICS ( $T_A = 25^\circ\text{C}$ unless otherwise noted) (EACH DIODE)

Characteristic	Symbol	Min	Typ	Max	Unit
Reverse Breakdown Voltage ( $I_R = 10 \mu\text{A}$ )	$V_{(BR)R}$	30	-	-	V
Total Capacitance ( $V_R = 1.0 \text{ V}$ , $f = 1.0 \text{ MHz}$ )	$C_T$	-	7.6	10	pF
Reverse Leakage ( $V_R = 25 \text{ V}$ )	$I_R$	-	0.5	2.0	$\mu\text{A}$
Forward Voltage ( $I_F = 0.1 \text{ mAdc}$ )	$V_F$	-	0.22	0.24	V
Forward Voltage ( $I_F = 30 \text{ mAdc}$ )	$V_F$	-	0.41	0.5	V
Forward Voltage ( $I_F = 100 \text{ mAdc}$ )	$V_F$	-	0.52	0.8	V
Reverse Recovery Time ( $I_F = I_R = 10 \text{ mAdc}$ , $I_{R(\text{REC})} = 1.0 \text{ mAdc}$ , Figure 1)	$t_{rr}$	-	-	5.0	ns
Forward Voltage ( $I_F = 1.0 \text{ mAdc}$ )	$V_F$	-	0.29	0.32	V
Forward Voltage ( $I_F = 10 \text{ mAdc}$ )	$V_F$	-	0.35	0.40	V

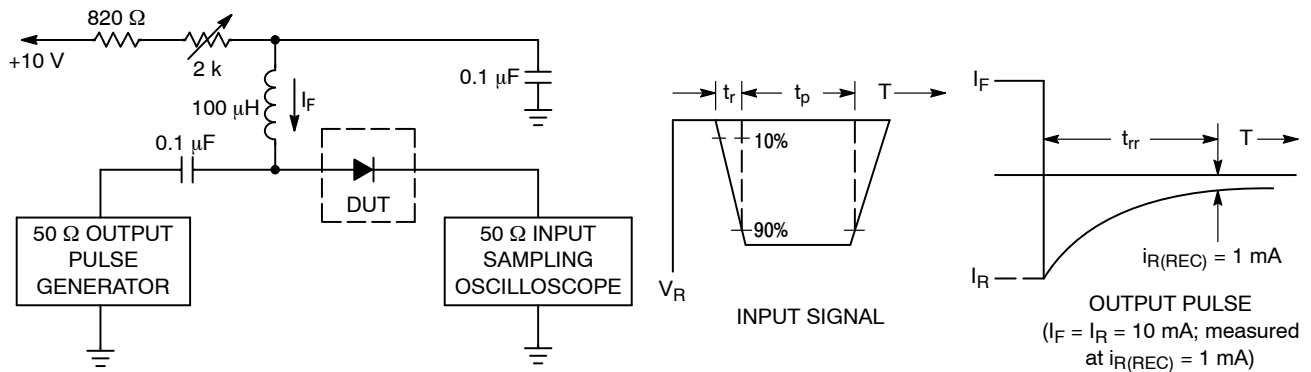

- Notes: 1. A 2.0 kΩ variable resistor adjusted for a Forward Current ( $I_F$ ) of 10 mA.  
 2. Input pulse is adjusted so  $I_{R(\text{peak})}$  is equal to 10 mA.  
 3.  $t_p \gg t_{rr}$

Figure 1. Recovery Time Equivalent Test Circuit

# BAT54CLT1G, SBAT54CLT1G

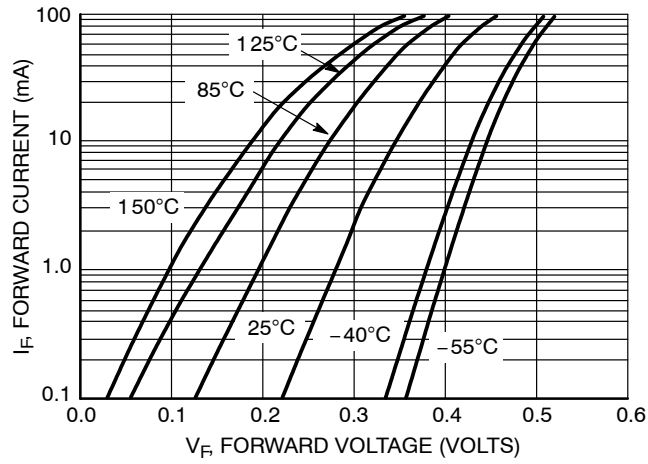

**Figure 2. Forward Voltage**

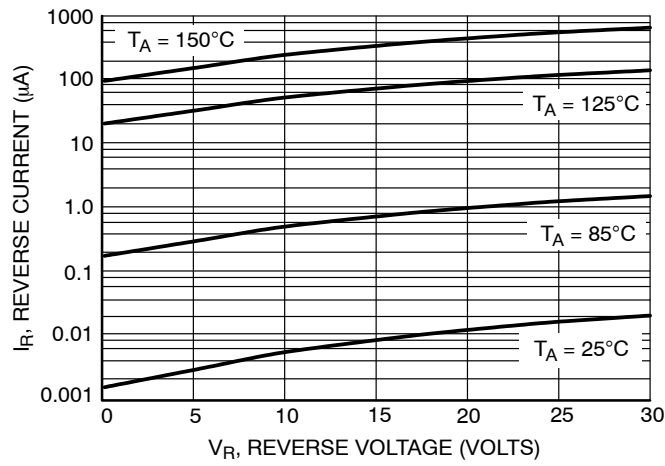

**Figure 3. Leakage Current**

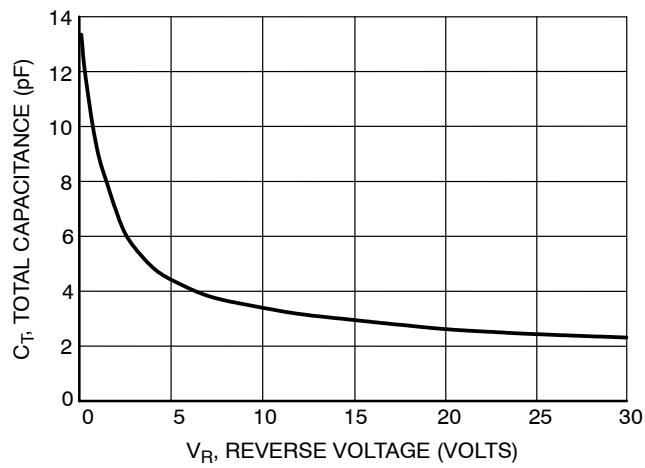
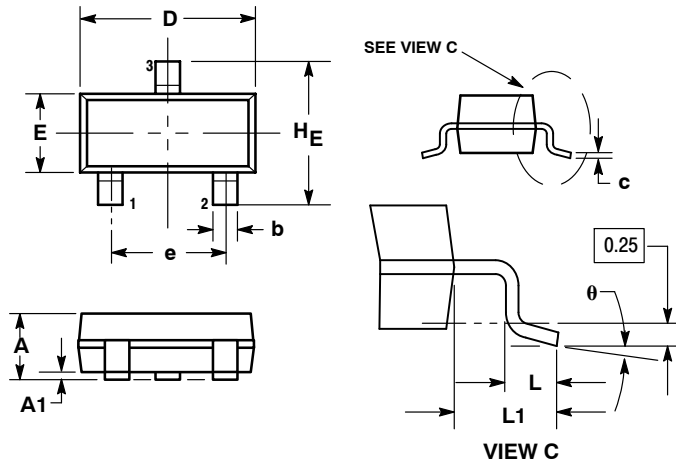

**Figure 4. Total Capacitance**

# BAT54CLT1G, SBAT54CLT1G

## PACKAGE DIMENSIONS

SOT-23 (TO-236)  
CASE 318-08  
ISSUE AP



NOTES:

1. DIMENSIONING AND TOLERANCING PER ANSI Y14.5M, 1982.
2. CONTROLLING DIMENSION: INCH.
3. MAXIMUM LEAD THICKNESS INCLUDES LEAD FINISH THICKNESS. MINIMUM LEAD THICKNESS IS THE MINIMUM THICKNESS OF BASE MATERIAL.
4. DIMENSIONS D AND E DO NOT INCLUDE MOLD FLASH, PROTRUSIONS, OR GATE BURRS.

DIM	MILLIMETERS			INCHES		
	MIN	NOM	MAX	MIN	NOM	MAX
A	0.89	1.00	1.11	0.035	0.040	0.044
A1	0.01	0.06	0.10	0.001	0.002	0.004
b	0.37	0.44	0.50	0.015	0.018	0.020
c	0.09	0.13	0.18	0.003	0.005	0.007
D	2.80	2.90	3.04	0.110	0.114	0.120
E	1.20	1.30	1.40	0.047	0.051	0.055
e	1.78	1.90	2.04	0.070	0.075	0.081
L	0.10	0.20	0.30	0.004	0.008	0.012
L1	0.35	0.54	0.69	0.014	0.021	0.029
HE	2.10	2.40	2.64	0.083	0.094	0.104
θ	0°	---	10°	0°	---	10°

STYLE 9:

- PIN 1. ANODE
- ANODE
- CATHODE

### SOLDERING FOOTPRINT\*

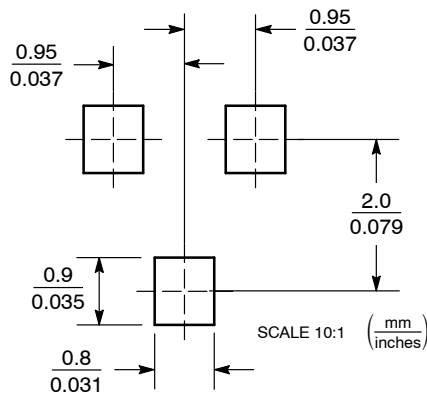

\*For additional information on our Pb-Free strategy and soldering details, please download the ON Semiconductor Soldering and Mounting Techniques Reference Manual, SOLDERRM/D.

ON Semiconductor and are registered trademarks of Semiconductor Components Industries, LLC (SCILLC). SCILLC reserves the right to make changes without further notice to any products herein. SCILLC makes no warranty, representation or guarantee regarding the suitability of its products for any particular purpose, nor does SCILLC assume any liability arising out of the application or use of any product or circuit, and specifically disclaims any and all liability, including without limitation special, consequential or incidental damages. "Typical" parameters which may be provided in SCILLC data sheets and/or specifications can and do vary in different applications and actual performance may vary over time. All operating parameters, including "Typicals" must be validated for each customer application by customer's technical experts. SCILLC does not convey any license under its patent rights nor the rights of others. SCILLC products are not designed, intended, or authorized for use as components in systems intended for surgical implant into the body, or other applications intended to support or sustain life, or for any other application in which the failure of the SCILLC product could create a situation where personal injury or death may occur. Should Buyer purchase or use SCILLC products for any such unintended or unauthorized application, Buyer shall indemnify and hold SCILLC and its officers, employees, subsidiaries, affiliates, and distributors harmless against all claims, costs, damages, and expenses, and reasonable attorney fees arising out of, directly or indirectly, any claim of personal injury or death associated with such unintended or unauthorized use, even if such claim alleges that SCILLC was negligent regarding the design or manufacture of the part. SCILLC is an Equal Opportunity/Affirmative Action Employer. This literature is subject to all applicable copyright laws and is not for resale in any manner.

### PUBLICATION ORDERING INFORMATION

**LITERATURE FULFILLMENT:**  
Literature Distribution Center for ON Semiconductor  
P.O. Box 5163, Denver, Colorado 80217 USA  
**Phone:** 303-675-2175 or 800-344-3860 Toll Free USA/Canada  
**Fax:** 303-675-2176 or 800-344-3867 Toll Free USA/Canada  
**Email:** orderlit@onsemi.com

**N. American Technical Support:** 800-282-9855 Toll Free USA/Canada  
**Europe, Middle East and Africa Technical Support:**  
Phone: 421 33 790 2910  
**Japan Customer Focus Center**  
Phone: 81-3-5817-1050

**ON Semiconductor Website:** [www.onsemi.com](http://www.onsemi.com)  
**Order Literature:** <http://www.onsemi.com/orderlit>  
For additional information, please contact your local Sales Representative

Компания «Океан Электроники» предлагает заключение долгосрочных отношений при поставках импортных электронных компонентов на взаимовыгодных условиях!

Наши преимущества:

- Поставка оригинальных импортных электронных компонентов напрямую с производств Америки, Европы и Азии, а так же с крупнейших складов мира;
- Широкая линейка поставок активных и пассивных импортных электронных компонентов (более 30 млн. наименований);
- Поставка сложных, дефицитных, либо снятых с производства позиций;
- Оперативные сроки поставки под заказ (от 5 рабочих дней);
- Экспресс доставка в любую точку России;
- Помощь Конструкторского Отдела и консультации квалифицированных инженеров;
- Техническая поддержка проекта, помощь в подборе аналогов, поставка прототипов;
- Поставка электронных компонентов под контролем ВП;
- Система менеджмента качества сертифицирована по Международному стандарту ISO 9001;
- При необходимости вся продукция военного и аэрокосмического назначения проходит испытания и сертификацию в лаборатории (по согласованию с заказчиком);
- Поставка специализированных компонентов военного и аэрокосмического уровня качества (Xilinx, Altera, Analog Devices, Intersil, Interpoint, Microsemi, Actel, Aeroflex, Peregrine, VPT, Syfer, Eurofarad, Texas Instruments, MS Kennedy, Miteq, Cobham, E2V, MA-COM, Hittite, Mini-Circuits, General Dynamics и др.);

Компания «Океан Электроники» является официальным дистрибьютором и эксклюзивным представителем в России одного из крупнейших производителей разъемов военного и аэрокосмического назначения «**JONHON**», а так же официальным дистрибьютором и эксклюзивным представителем в России производителя высокотехнологичных и надежных решений для передачи СВЧ сигналов «**FORSTAR**».



## JONHON

«**JONHON**» (основан в 1970 г.)

Разъемы специального, военного и аэрокосмического назначения:

(Применяются в военной, авиационной, аэрокосмической, морской, железнодорожной, горно- и нефтедобывающей отраслях промышленности)

«**FORSTAR**» (основан в 1998 г.)

ВЧ соединители, коаксиальные кабели,  
кабельные сборки и микроволновые компоненты:

(Применяются в телекоммуникациях гражданского и специального назначения, в средствах связи, РЛС, а так же военной, авиационной и аэрокосмической отраслях промышленности).



Телефон: 8 (812) 309-75-97 (многоканальный)

Факс: 8 (812) 320-03-32

Электронная почта: [ocean@oceanchips.ru](mailto:ocean@oceanchips.ru)

Web: <http://oceanchips.ru/>

Адрес: 198099, г. Санкт-Петербург, ул. Калинина, д. 2, корп. 4, лит. А