

EAO – Your Expert Partner for
Human Machine Interfaces



EAO Product Information

Series 51



Description	3
Product Assembly	4
Devices raised mounting	7
Devices flush mounting	13
Accessories.....	21
Technical Data.....	33
Typical Applications	36
Application guidelines.....	37
Marking	38
Drawings.....	40
Index.....	58

Product Information

General notes

The illuminated pushbuttons of series 51 with hoseproof front (IP 65) can be supplied with snap-action or low-level switching elements. The equipment (switches) for raised mounting are protected against accidental operation by the extended sides of the bezel. Flush mounting equipment excels with best available ergonomics and low down height. To supplement the range of illuminated pushbuttons, we can offer a hoseproof safety keylock switch with various lock numbers.

Mounting

All switch actuators are mounted from the front by pushing them through the mounting hole in the front panel. They are then fixed from the back with a fixing nut and the mounting tool Typ-Nr. 01-907. Max. tightening torque 50 Ncm.

For switching elements we offer plug-in bases, which when soldered to a PCB enable a plug-in connection to the button. The rectangular actuators for raised are provided with an anti-twisting device.

Lenses

The flat or concave lenses are available in various colours, as well as translucent or transparent. Round lenses for flush mounting equipment are available in aluminium also.

Because of production related reasons, the colours of anodized aluminium parts can vary slightly.

Marking

For further information about engraving, hot stamping and film inserts see part Marking.

Illumination

The T1 ³/₄ Midget Groove incandescent (filament) lamp (6 ... 48 V) ensures perfect illumination of the lenses, which are supplied in various colours.

T1 ³/₄ Midget Groove Single-LED (6, 12, 24, 28, 48 V) are also available in blue, green, red, white or yellow.

Luminosity and wave length scattering caused by technology used in the LED manufacturing processes may lead to visual differences in our products.

For supply voltages above 48 V, it is necessary to use a voltage reduction element (external series resistor or transformer).

Position indication

The status of a maintained action switch can be determined by the position of the lens.

Keylock switch

Standard lock (Index D). Standard lock number is 311. If the lock number is not specified, we will supply standard number 311.

An additional 134 special locks (Index X) are available on request. Master keys for lock numbers 311 ... 445 may be ordered by quoting Typ-Nr. 31-989.300. Two keys are supplied with each keylock switch. Spare keys (Index D) for standard locks may be ordered by quoting Typ-Nr. 31-989.xxx (please state the lock number).

Specimen order

Indicator :

- Indicator actuator, 18 x 24 mm, soldering terminal 31-040.005

Essential accessories :

- Lens plastic blue, transparent, flush, 18 x 24 mm 31-903.6
- Single-LED, T1 ³/₄ MG, 24 VAC/DC, blau 10-2J12.1066

*We reserve the right to modify technical data
All dimensions in mm*

Indicator round, raised mounting



- 1 Lens
- 2 LED
- 3 Indicator housing
- 4 Sealing
- 5 Front plate
- 6 Fixing nut

Illuminated pushbutton, raised mounting

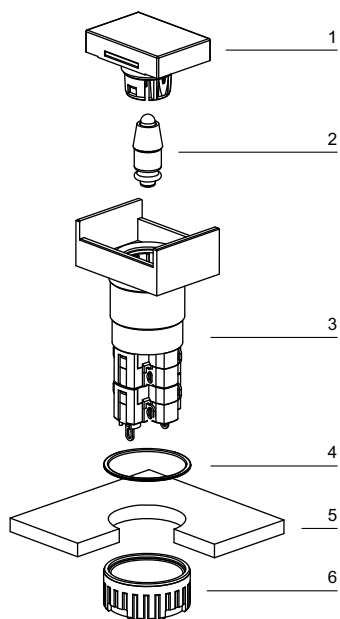

- 1 Lens
- 2 LED
- 3 Switch housing
- 4 Sealing
- 5 Front plate
- 6 Fixing nut

Keylock switch round, flush mounting

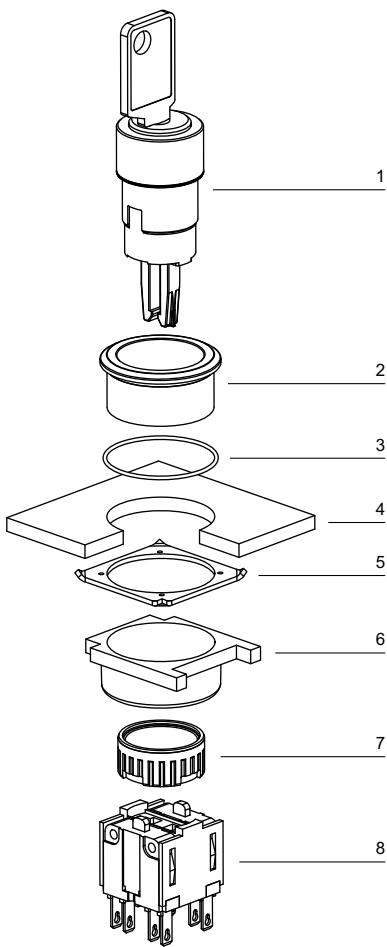

- 1 Actuator housing
- 2 Front bezel
- 3 Sealing
- 4 Front plate
- 5 Anti-twist ring
- 6 Thrust piece
- 7 Fixing nut
- 8 Switching element

Selector switch square, flush mounting

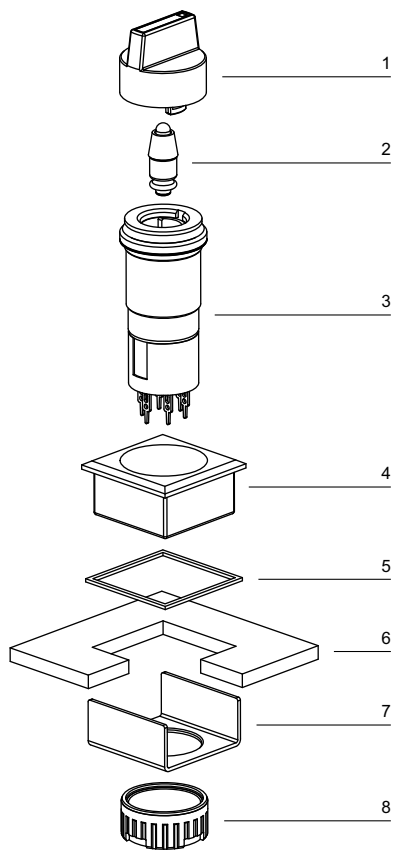

- 1 Actuator housing
- 2 LED
- 3 Actuator housing
- 4 Front bezel
- 5 Sealing
- 6 Front plate
- 7 Fixing bracket
- 8 Fixing nut

Indicator actuator



Essential Accessories:

-  Lens plastic, raised mounting page 21
-  Single-LED page 30

	Front protection	Diode (1N 4007)	Terminals	⌀ 18 x 18 mm Typ-Nr.	⌀ 18 x 24 mm Typ-Nr.	Ø 18 mm Typ-Nr.	Component layout	Mounting dimensions	Technical drawing	Circuit drawing	
Indicator actuator	IP 65	1 D	UT	51-703.006	51-701.006	51-741.006	4	1	12	78	0.006
		2 D	UT	51-704.006	51-702.006	51-742.006	4	1	12	79	0.006
	-	S		51-050.005	51-040.005	51-030.005		1	12	1	0.004
		S1		51-050.002	51-040.002	51-030.002		1	12	1	0.004
		UT		51-051.006	51-041.006	51-031.006	4	1	12	1	0.005

Indicators fit also in mounting hole no. 2

Diode (1N 4007): D = Diode, - = without

Terminals: UT = Universal terminal, S = Soldering terminal, S1 = Soldering terminal (also pluggable 2.8 x 0.5 mm)

Component layout from page 40, Mounting dimensions from page 41, Technical drawing from page 42, Circuit drawing from page 47

Illuminated pushbutton actuator



Essential Accessories:

- Lens plastic, raised mounting page 21
- Single-LED page 30

	Front protection	Switching system	Contacts	Diode (1N 4007)	Switching action		Ø 18 x 18 mm Typ-Nr.	Ø 18 x 24 mm Typ-Nr.	Ø 18 mm Typ-Nr.	Component layout	Mounting dimensions	Technical drawing	Circuit drawing		
						Terminals									
Illuminated pushbutton actuator	IP 65	LL	1 NC	-	MA	UT	51-486.036	51-466.036	51-476.036	4	1	13	11	0.007	
					M	UT	51-456.036	51-426.036	51-436.036	4	1	13	57	0.007	
			1 NC + 1 NO	-	MA	UT	51-483.036	51-463.036	51-473.036	4	1	13	14	0.007	
					M	UT	51-453.036	51-423.036	51-433.036	4	1	13	60	0.007	
			1 NO	-	MA	UT	51-485.036	51-465.036	51-475.036	4	1	13	13	0.007	
					M	UT	51-455.036	51-425.036	51-435.036	4	1	13	59	0.007	
			2 NC	-	MA	UT	51-482.036	51-462.036	51-472.036	4	1	13	12	0.007	
					M	UT	51-452.036	51-422.036	51-432.036	4	1	13	58	0.007	
			2 NO	-	MA	UT	51-481.036	51-461.036	51-471.036	4	1	13	15	0.007	
					M	UT	51-451.036	51-421.036	51-431.036	4	1	13	61	0.007	
			SA	1 NC + 1 NO	1 D	MA	H	51-717.0292	51-713.0292	51-747.0292		1	13	8	0.008
						M	H	51-709.0292	51-705.0292	51-743.0292		1	13	54	0.008
					2 D	MA	H	51-718.0292	51-714.0292	51-748.0292		1	13	9	0.008
						M	H	51-710.0292	51-706.0292	51-744.0292		1	13	55	0.008
		-			MA	S	51-281.0252	51-261.0252	51-271.0252		1	13	10	0.006	
						S1	51-281.022	51-261.022	51-271.022		1	13	7	0.006	
					M	S	51-151.0252	51-121.0252	51-131.0252		1	13	56	0.006	
						S1	51-151.022	51-121.022	51-131.022		1	13	53	0.006	
		2 NC + 2 NO			1 D	MA	H	51-719.0292	51-715.0292	51-749.0292		1	13	4	0.010
						M	H	51-711.0292	51-707.0292	51-745.0292		1	13	50	0.010
					2 D	MA	H	51-720.0292	51-716.0292	51-750.0292		1	13	5	0.010
						M	H	51-712.0292	51-708.0292	51-746.0292		1	13	51	0.010
					-	MA	S	51-282.0252	51-262.0252	51-272.0252		1	13	6	0.008
						M	S	51-152.0252	51-122.0252	51-132.0252		1	13	52	0.008
		3 NC + 3 NO	-	MA	S	51-283.0252	51-263.0252	51-273.0252		1	13	3	0.010		
				M	S	51-153.0252	51-123.0252	51-133.0252		1	13	49	0.010		
		4 NC + 4 NO	-	MA	S	51-284.0252	51-264.0252	51-274.0252		1	13	2	0.012		
				M	S	51-154.0252	51-124.0252	51-134.0252		1	13	48	0.012		

Illuminated pushbutton fit also in mounting hole no. 2

Switching system: LL = Low level switching element, SA = Snap-action switching element

Contacts: NC = Normally closed, NO = Normally open

Diode (1N 4007): - = without, D = Diode

Switching action: MA = Maintained action, M = Momentary action

Terminals: UT = Universal terminal, H = Combined terminal: Solder-/ Universal (at contact/ at diode), S = Soldering terminal, S1 = Soldering terminal (also pluggable 2.8 x 0.5 mm)

Component layout from page 40, Mounting dimensions from page 41, Technical drawing from page 42, Circuit drawing from page 47

Keylock switch 2 positions



	Front protection	Switching system	Contacts	Switching action	Terminals	Key remove	Key remove			Component layout	Mounting dimensions	Technical drawing	Circuit drawing	IP	
							Ø 18 x 18 mm Typ-Nr.	Ø 18 x 24 mm Typ-Nr.	Ø 18 mm Typ-Nr.						
Keylock switch 2 positions Position A : Basic position Position C : Maintained action Standard lock 311 Front : Plastic black	IP 65	LL	1 NC + 1 NO	MA	UT	A	51-445.036D	51-405.036D	51-415.036D	4	2	14	76	0.017	
							C	51-448.036D	51-408.036D						51-418.036D
							C + A	51-442.036D	51-402.036D						51-412.036D
							C + A	51-441.036D	51-401.036D						51-411.036D
			2 NO	MA	UT	A	51-444.036D	51-404.036D	51-414.036D	4	2	14	77	0.017	
							C	51-447.036D	51-407.036D						51-417.036D
							C + A	51-441.036D	51-401.036D						51-411.036D
							C + A	51-441.036D	51-401.036D						51-411.036D
		SA	1 NC + 1 NO	MA	S	A	51-255.025D2	51-295.025D2	51-235.025D2	2	14	72	0.016		
							C	51-355.025D2	51-395.025D2					51-335.025D2	
							C + A	51-155.025D2	51-195.025D2					51-135.025D2	
							C + A	51-155.025D2	51-195.025D2					51-135.025D2	
				S1	A	51-255.022D	51-295.022D	51-235.022D	2	14	72	0.016			
						C	51-355.022D	51-395.022D					51-335.022D		
						C + A	51-155.022D	51-195.022D					51-135.022D		
						C + A	51-155.022D	51-195.022D					51-135.022D		
2 NC + 2 NO	MA	S	A	51-256.025D2	51-296.025D2	51-236.025D2	2	14	73	0.016					
				C	51-356.025D2	51-396.025D2					51-336.025D2				
				C + A	51-156.025D2	51-196.025D2					51-136.025D2				
3 NC + 3 NO	MA	S	A	51-257.025D2	51-297.025D2	51-237.025D2	2	14	74	0.016					
				C	51-357.025D2	51-397.025D2					51-337.025D2				
				C + A	51-157.025D2	51-197.025D2					51-137.025D2				
4 NC + 4 NO	MA	S	A	51-258.025D2	51-298.025D2	51-238.025D2	2	14	75	0.016					
				C	51-358.025D2	51-398.025D2					51-338.025D2				
				C + A	51-158.025D2	51-198.025D2					51-138.025D2				
				C + A	51-158.025D2	51-198.025D2					51-138.025D2				
Position A : Basic position Position C : Momentary action Standard lock 311 Front : Plastic black	IP 65	LL	1 NC + 1 NO	M	UT	A	51-458.036D	51-428.036D	51-438.036D	4	2	14	70	0.017	
							2 NO	51-457.036D	51-427.036D						51-437.036D
		SA	1 NC + 1 NO	M	S	A	51-145.025D2	51-495.025D2	51-141.025D2	2	14	66	0.016		
							S1	51-145.022D	51-495.022D					51-141.022D	
			2 NC + 2 NO	M	S	A	51-146.025D2	51-496.025D2	51-142.025D2	2	14	67	0.016		
							3 NC + 3 NO	51-147.025D2	51-497.025D2					51-143.025D2	
			4 NC + 4 NO	M	S	A	51-148.025D2	51-498.025D2	51-144.025D2	2	14	69	0.016		

Other lock numbers on request

Switching system: LL = Low level switching element, SA = Snap-action switching element

Contacts: NC = Normally closed, NO = Normally open

Switching action: MA = Maintained action, M = Momentary action

Terminals: UT = Universal terminal, S = Soldering terminal, S1 = Soldering terminal (also pluggable 2.8 x 0.5 mm)

Component layout from page 40, Mounting dimensions from page 41, Technical drawing from page 42, Circuit drawing from page 47

Keylock switch 3 positions



	Front protection	Switching system	Contacts	Switching action	Terminals	Key remove	Ø 18 x 18 mm Typ-Nr.	Ø 18 x 24 mm Typ-Nr.	Ø 18 mm Typ-Nr.	Mounting dimensions	Technical drawing	Circuit drawing	
Keylock switch 3 positions Position C : Maintained action Position A : Basic position Position B : Maintained action Standard lock 311	IP 65	SA	2 NC + 2 NO	MA-0-MA	S1	A	51-381.022D	51-361.022D	51-371.022D	2	1	65	0.025
						C + B	51-383.022D	51-363.022D	51-373.022D	2	1	65	0.025
						C+A+B	51-382.022D	51-362.022D	51-372.022D	2	1	65	0.025
Position C : Maintained action Position A : Basic position Position B : Momentary action Standard lock 311	IP 65	SA	2 NC + 2 NO	MA-0-M	S1	A	51-385.022D	51-365.022D	51-375.022D	2	1	64	0.025
						C + A	51-386.022D	51-366.022D	51-376.022D	2	1	64	0.025
Position C : Momentary action Position A : Basic position Position B : Momentary action Standard lock 311	IP 65	SA	2 NC + 2 NO	M-0-M	S1	A	51-384.022D	51-364.022D	51-374.022D	2	1	63	0.025
Position C : Momentary action Position A : Basic position Position B : Maintained action standard lock 311	IP 65	SA	2 NC + 2 NO	M-0-MA	S1	A	51-387.022D	51-367.022D	51-377.022D	2	1	62	0.025
						A + B	51-388.022D	51-368.022D	51-378.022D	2	1	62	0.025

Other lock numbers on request

Switching system: SA = Snap-action switching element

Contacts: NC = Normally closed, NO = Normally open

Switching action: MA = Maintained action, M = Momentary action

Terminals: S1 = Soldering terminal (also pluggable 2.8 x 0.5 mm)

Mounting dimensions from page 41, Technical drawing from page 42, Circuit drawing from page 47

Selector switch 2 positions

illuminative



Essential Accessories:

Lever, raised mounting page 24

Single-LED page 30

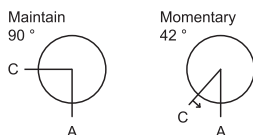

	Front protection	Switching system	Contacts	Diode (1N 4007)	Switching action	Terminals	Ø 18 mm Typ-Nr.	Component layout	Mounting dimensions	Technical drawing	Circuit drawing		
Selector switch 2 positions Position A : Basic position Position C : Maintained action	IP 65	LL	1 NC	-	MA	UT	52-476.036	4	2	19	43	0.007	
			1 NC + 1 NO	-	MA	UT	52-473.036	4	2	19	46	0.007	
			1 NO	-	MA	UT	52-475.036	4	2	19	45	0.007	
			2 NC	-	MA	UT	52-472.036	4	2	19	44	0.007	
			2 NO	-	MA	UT	52-471.036	4	2	19	47	0.007	
			1 NC + 1 NO	1 D	MA	H	52-747.0292		2	19	40	0.008	
		SA	1 NC + 1 NO	2 D	MA	H	52-748.0292		2	19	41	0.008	
				-	MA	S	52-271.0252		2	19	42	0.006	
				S1	52-271.022		2	19	39	0.006			
				2 NC + 2 NO	1 D	MA	H	52-749.0292		2	19	36	0.010
			2 NC + 2 NO	2 D	MA	H	52-750.0292		2	19	37	0.010	
				-	MA	S	52-272.0252		2	19	38	0.006	
				3 NC + 3 NO	-	MA	S	52-273.0252		2	19	35	0.006
				4 NC + 4 NO	-	MA	S	52-274.0252		2	19	34	0.006
Position A : Basic position Position C : Momentary action	IP 65	LL	1 NC	-	M	UT	52-436.036	4	2	19	29	0.007	
			1 NC + 1 NO	-	M	UT	52-433.036	4	2	19	32	0.007	
			1 NO	-	M	UT	52-435.036	4	2	19	31	0.007	
			2 NC	-	M	UT	52-432.036	4	2	19	30	0.007	
			2 NO	-	M	UT	52-431.036	4	2	19	33	0.007	
			SA	1 NC + 1 NO	1 D	M	H	52-743.0292		2	19	26	0.008
		2 D			M	H	52-744.0292		2	19	27	0.008	
		-			M	S	52-131.0252		2	19	28	0.006	
		S1			52-131.022		2	19	25	0.006			
		2 NC + 2 NO		1 D	M	H	52-745.0292		2	19	22	0.010	
				2 D	M	H	52-746.0292		2	19	23	0.010	
				-	M	S	52-132.0252		2	19	24	0.006	
				3 NC + 3 NO	-	M	S	52-133.0252		2	19	21	0.006
		4 NC + 4 NO	-	M	S	52-134.0252		2	19	20	0.006		

Switching system: LL = Low level switching element, SA = Snap-action switching element

Contacts: NC = Normally closed, NO = Normally open

Diode (1N 4007): - = without, D = Diode

Switching action: MA = Maintained action, M = Momentary action

Terminals: UT = Universal terminal, H = Combined terminal: Solder-/ Universal (at contact/ at diode), S = Soldering terminal, S1 = Soldering terminal (also pluggable 2.8 x 0.5 mm)

Component layout from page 40, Mounting dimensions from page 41, Technical drawing from page 42, Circuit drawing from page 47

Selector switch 3 positions

illuminative



Essential Accessories:

-  Lever, raised mounting page 24
-  Single-LED page 30

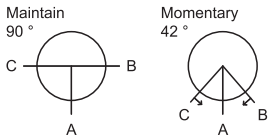

	Front protection	Switching system	Contacts	Switching action	Terminals	Ø 18 mm Typ-Nr.	Mounting dimensions	Technical drawing	Circuit drawing	
Selector switch 3 positions Position C : Maintained action Position A : Basic position Position B : Maintained action	IP 40	SA	2 NC + 2 NO	MA-0-MA	S1	52-571.022A	2	6	19	0.015
				M-0-MA	S1	52-574.022A	2	6	17	0.015
Position C : Momentary action Position A : Basic position Position B : Momentary action	IP 40	SA	2 NC + 2 NO	MA-0-M	S1	52-573.022A	2	6	18	0.015
				M-0-M	S1	52-572.022A	2	6	16	0.015

Switching system: SA = Snap-action switching element

Contacts: NC = Normally closed, NO = Normally open

Switching action: MA = Maintained action, M = Momentary action

Terminals: S1 = Soldering terminal (also pluggable 2.8 x 0.5 mm)

Mounting dimensions from page 41, Technical drawing from page 42, Circuit drawing from page 47

Indicator actuator, flush mounting

Actuators usable for front dimensions: \square 24 x 24 mm | \square 24 x 30 mm | 25 mm dia.



Essential Accessories:

-  Front bezel set for Indicators and Illuminated pushbutton, flush mounting page 25
-  Lens plastic, flush mounting page 21
-  Single-LED page 30

	Front protection	Terminals	Typ-Nr.	Component layout	Mounting dimensions	Technical drawing	Circuit drawing	
Indicator actuator, flush mounting	IP 65	S	51-050.005F	3	15	1	0.004	
		S1	51-050.002F	3	15	1	0.004	
		UT	51-051.006F	4	3	15	1	0.005

Terminals: S = Soldering terminal, S1 = Soldering terminal (also pluggable 2.8 x 0.5 mm), UT = Universal terminal

Component layout from page 40, Mounting dimensions from page 41, Technical drawing from page 42, Circuit drawing from page 47

Illuminated pushbutton actuator, flush mounting

Actuators usable for front dimensions: \square 24 x 24 mm | \square 24 x 30 mm | 25 mm dia.



Essential Accessories:

- Front bezel set for Indicators and Illuminated pushbutton, flush mounting page 25
- Lens plastic, flush mounting page 21
- Single-LED page 30

	Front protection	Switching system	Contacts	Switching action	Terminals	Typ-Nr.	Component layout	Mounting dimensions	Technical drawing	Circuit drawing		
Illuminated pushbutton actuator, flush mounting	IP 65	LL	1 NC	MA	UT	51-486.036F	4	3	16	11	0.006	
				M	UT	51-456.036F	4	3	16	57	0.006	
			1 NC + 1 NO	MA	UT	51-483.036F	4	3	16	14	0.006	
				M	UT	51-453.036F	4	3	16	60	0.006	
			1 NO	MA	UT	51-485.036F	4	3	16	13	0.006	
				M	UT	51-455.036F	4	3	16	59	0.006	
			2 NC	MA	UT	51-482.036F	4	3	16	12	0.006	
				M	UT	51-452.036F	4	3	16	58	0.006	
			2 NO	MA	UT	51-481.036F	4	3	16	15	0.006	
				M	UT	51-451.036F	4	3	16	61	0.006	
			SA	1 NC + 1 NO	MA	S	51-281.0252F		3	16	10	0.005
						S1	51-281.022F		3	16	7	0.007
		M			S	51-151.0252F		3	16	56	0.005	
					S1	51-151.022F		3	16	53	0.007	
		2 NC + 2 NO		MA	S	51-282.0252F		3	16	6	0.008	
					S	51-152.0252F		3	16	52	0.008	
		3 NC + 3 NO		MA	S	51-283.0252F		3	16	3	0.010	
					S	51-153.0252F		3	16	49	0.010	
		4 NC + 4 NO	MA	S	51-284.0252F		3	16	2	0.012		
				S	51-154.0252F		3	16	48	0.012		

Switching system: LL = Low level switching element, SA = Snap-action switching element

Contacts: NC = Normally closed, NO = Normally open

Switching action: MA = Maintained action, M = Momentary action

Terminals: UT = Universal terminal, S = Soldering terminal, S1 = Soldering terminal (also pluggable 2.8 x 0.5 mm)

Component layout from page 40, Mounting dimensions from page 41, Technical drawing from page 42, Circuit drawing from page 47

Keylock switch actuator 2 positions, flush mounting



Essential Accessories:

 Front bezel set for Keylock switch, flush mounting page 26

	Front protection	Switching system	Contacts	Switching action	Terminals	Key remove	□ 24 x 24 mm Typ-Nr.	□ 24 x 30 mm Typ-Nr.	Ø 25 mm Typ-Nr.	Component layout				kg					
										Mounting dimensions	Technical drawing	Circuit drawing							
Keylock switch actuator 2 positions, flush mounting Position A : Basic position Position C : Maintained action Standard lock 311 Front : Plastic black	IP 65	LL	1 NC + 1 NO	MA	UT	A	51-445.036DF			4	3	17	76	0.027					
							C	51-448.036DF			4	3	17	76	0.027				
							C + A	51-442.036DF			4	3	17	76	0.027				
					2 NO	MA	UT	A	51-444.036DF			4	3	17	77	0.027			
									C	51-447.036DF			4	3	17	77	0.027		
									C + A	51-441.036DF			4	3	17	77	0.027		
					SA	1 NC + 1 NO	MA	S	A	51-255.025D2F				3	17	72	0.027		
										C	51-355.025D2F				3	17	72	0.027	
										C + A	51-155.025D2F				3	17	72	0.027	
									S1	A	51-255.022DF				3	17	72	0.027	
											C	51-355.022DF				3	17	72	0.027
											C + A	51-155.022DF				3	17	72	0.027
					2 NC + 2 NO	MA	S	A	51-256.025D2F				3	17	73	0.027			
									C	51-356.025D2F				3	17	73	0.027		
									C + A	51-156.025D2F				3	17	73	0.027		
					3 NC + 3 NO	MA	S	A	51-257.025D2F				3	17	74	0.027			
									C	51-357.025D2F				3	17	74	0.027		
									C + A	51-157.025D2F				3	17	74	0.027		
					4 NC + 4 NO	MA	S	A	51-258.025D2F				3	17	75	0.027			
									C	51-358.025D2F				3	17	75	0.027		
		C + A	51-158.025D2F									3	17	75	0.027				
Position A : Basic position Position C : Momentary action Standard lock 311 Front : Plastic black	IP 65	LL	1 NC + 1 NO	M	UT	A	51-458.036DF			4	3	17	70	0.027					
							2 NO	51-457.036DF			4	3	17	71	0.027				
			SA	1 NC + 1 NO	M	S	A	51-145.025D2F				3	17	66	0.027				
								S1	51-145.022DF				3	17	66	0.027			
				2 NC + 2 NO	M	S	A	51-146.025D2F				3	17	67	0.027				
								3 NC + 3 NO	M	S	A	51-147.025D2F				3	17	68	0.027
				4 NC + 4 NO	M	S	A	51-148.025D2F				3	17	69	0.027				

Continuation see next page

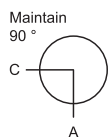

	Front protection	Switching system	Contacts	Switching action	Terminals	Key remove	Ø 24 x 24 mm Typ-Nr.	Ø 24 x 30 mm Typ-Nr.	Ø 25 mm Typ-Nr.	Component layout		Mounting dimensions		Technical drawing		Circuit drawing	
Position A : Basic position Position C : Maintained action Standard lock 311 Front : Plastic black	IP 65	LL	1 NC + 1 NO	MA	UT	A		51-405.036DF		4	3	17	76	0.029			
						C		51-408.036DF		4	3	17	76	0.029			
						C + A		51-402.036DF		4	3	17	76	0.029			
			2 NO	MA	UT	A		51-404.036DF		4	3	17	77	0.029			
						C		51-407.036DF		4	3	17	77	0.029			
						C + A		51-401.036DF		4	3	17	77	0.029			
			SA	1 NC + 1 NO	MA	S	A		51-295.025D2F		3	17	72	0.029			
							C		51-395.025D2F		3	17	72	0.029			
							C + A		51-195.025D2F		3	17	72	0.029			
						S1	A		51-295.022DF		3	17	72	0.029			
							C		51-395.022DF		3	17	72	0.029			
							C + A		51-195.022DF		3	17	72	0.029			
		2 NC + 2 NO		MA	S	A		51-296.025D2F		3	17	73	0.029				
						C		51-396.025D2F		3	17	73	0.029				
						C + A		51-196.025D2F		3	17	73	0.029				
		3 NC + 3 NO		MA	S	A		51-297.025D2F		3	17	74	0.029				
						C		51-397.025D2F		3	17	74	0.029				
						C + A		51-197.025D2F		3	17	74	0.029				
		4 NC + 4 NO	MA	S	A		51-298.025D2F		3	17	75	0.029					
					C		51-398.025D2F		3	17	75	0.029					
					C + A		51-198.025D2F		3	17	75	0.029					
		Position A : Basic position Position C : Momentary action Standard lock 311 Front : Plastic black	IP 65	LL	1 NC + 1 NO	M	UT	A		51-428.036DF		4	3	17	70	0.029	
								A		51-427.036DF		4	3	17	71	0.029	
					2 NO	M	UT	A		51-427.036DF		4	3	17	71	0.029	
A								51-427.036DF		4	3	17	71	0.029			
SA	1 NC + 1 NO			M	S	A		51-495.025D2F		3	17	66	0.029				
						A		51-495.022DF		3	17	66	0.029				
	2 NC + 2 NO			M	S	A		51-496.025D2F		3	17	67	0.029				
						A		51-496.025D2F		3	17	67	0.029				
3 NC + 3 NO	M			S	A		51-497.025D2F		3	17	68	0.029					
					A		51-497.025D2F		3	17	68	0.029					
4 NC + 4 NO	M			S	A		51-498.025D2F		3	17	69	0.029					
					A		51-498.025D2F		3	17	69	0.029					
Position A : Basic position Position C : Maintained action Standard lock 311 Front : Plastic black	IP 65	LL	1 NC + 1 NO	MA	UT	A		51-415.036DF		4	3	17	76	0.026			
						C		51-418.036DF		4	3	17	76	0.026			
						C + A		51-412.036DF		4	3	17	76	0.026			
			2 NO	MA	UT	A		51-414.036DF		4	3	17	77	0.026			
						C		51-417.036DF		4	3	17	77	0.026			
						C + A		51-411.036DF		4	3	17	77	0.026			
			SA	1 NC + 1 NO	MA	S	A		51-235.025D2F		3	17	72	0.026			
							C		51-335.025D2F		3	17	72	0.026			
							C + A		51-135.025D2F		3	17	72	0.026			
				S1	A		51-235.022DF		3	17	72	0.026					
					C		51-335.022DF		3	17	72	0.026					
					C + A		51-135.022DF		3	17	72	0.026					
		2 NC + 2 NO	MA	S	A		51-236.025D2F		3	17	73	0.026					
					C		51-336.025D2F		3	17	73	0.026					
					C + A		51-136.025D2F		3	17	73	0.026					
		3 NC + 3 NO	MA	S	A		51-237.025D2F		3	17	74	0.026					
					C		51-337.025D2F		3	17	74	0.026					
					C + A		51-137.025D2F		3	17	74	0.026					
		4 NC + 4 NO	MA	S	A		51-238.025D2F		3	17	75	0.026					
					C		51-338.025D2F		3	17	75	0.026					
					C + A		51-138.025D2F		3	17	75	0.026					

Continuation see next page

Continued from previous page



	Front protection	Switching system	Contacts	Switching action	Terminals	Key remove	□ 24 x 24 mm Typ-Nr.	□ 24 x 30 mm Typ-Nr.	Ø 25 mm Typ-Nr.	Component layout				Circuit drawing
										Mounting dimensions	Technical drawing			
Position A : Basic position Position C : Momentary action Standard lock 311 Front : Plastic black	IP 65	LL	1 NC + 1 NO	M	UT	A			51-438.036DF	4	3	17	70	0.026
			2 NO	M	UT	A			51-437.036DF	4	3	17	71	0.026
		SA	1 NC + 1 NO	M	S	A			51-141.025D2F	3	17	66	66	0.026
					S1	A			51-141.022DF	3	17	66	66	0.026
			2 NC + 2 NO	M	S	A			51-142.025D2F	3	17	67	67	0.026
			3 NC + 3 NO	M	S	A			51-143.025D2F	3	17	68	68	0.026
			4 NC + 4 NO	M	S	A			51-144.025D2F	3	17	69	69	0.026

Other lock numbers on request

Switching system: LL = Low level switching element, SA = Snap-action switching element

Contacts: NC = Normally closed, NO = Normally open

Switching action: MA = Maintained action, M = Momentary action

Terminals: UT = Universal terminal, S = Soldering terminal, S1 = Soldering terminal (also pluggable 2.8 x 0.5 mm)

Component layout from page 40, Mounting dimensions from page 41, Technical drawing from page 42, Circuit drawing from page 47

Keylock switch actuator 3 positions, flush mounting



Essential Accessories:

 Front bezel set for Keylock switch, flush mounting page 26

Maintain 90° 	Momentary 42° 	Front protection	Switching system	Contacts	Switching action	Terminals	Key remove	\varnothing 24 x 24 mm Typ-Nr.	\square 24 x 30 mm Typ-Nr.	\varnothing 25 mm Typ-Nr.	Mounting dimensions				
											Technical drawing	Circuit drawing			
Keylock switch actuator 3 positions, flush mounting Position C : Maintained action Position A : Basic position Position B : Maintained action Standard lock 311															
Position C : Maintained action Position A : Basic position Position B : Maintained action Standard lock 311	IP 65	SA	2 NC + 2 NO	MA-0-MA	S1	A	A	51-381.022DF	51-361.022DF	51-371.022DF	3	4	65	0.027	
								C + B	51-383.022DF	51-363.022DF	51-373.022DF	3	4	65	0.027
								C+A+B	51-382.022DF	51-362.022DF	51-372.022DF	3	4	65	0.027
Position C : Maintained action Position A : Basic position Position B : Momentary action Standard lock 311															
Position C : Maintained action Position A : Basic position Position B : Momentary action Standard lock 311	IP 65	SA	2 NC + 2 NO	MA-0-M	S1	A	A	51-385.022DF	51-365.022DF	51-375.022DF	3	4	64	0.027	
								C + A	51-386.022DF	51-366.022DF	51-376.022DF	3	4	64	0.027
Position C : Momentary action Position A : Basic position Position B : Maintained action Standard lock 311															
Position C : Momentary action Position A : Basic position Position B : Maintained action Standard lock 311	IP 65	SA	2 NC + 2 NO	M-0-MA	S1	A	A	51-387.022DF	51-367.022DF	51-377.022DF	3	4	62	0.027	
								A + B	51-388.022DF	51-368.022DF	51-378.022DF	3	4	62	0.027
Position C : Momentary action Position A : Basic position Position B : Momentary action Standard lock 311															
Position C : Momentary action Position A : Basic position Position B : Momentary action Standard lock 311	IP 65	SA	2 NC + 2 NO	M-0-M	S1	A	A	51-384.022DF	51-364.022DF	51-374.022DF	3	4	63	0.027	

Other lock numbers on request

Switching system: SA = Snap-action switching element

Contacts: NC = Normally closed, NO = Normally open

Switching action: MA = Maintained action, M = Momentary action

Terminals: S1 = Soldering terminal (also pluggable 2.8 x 0.5 mm)

Mounting dimensions from page 41, Technical drawing from page 42, Circuit drawing from page 47

Selector switch actuator 2 positions, flush mounting

illuminative

Actuators usable for front dimensions: \square 24 x 24 mm | 25 mm dia.



Essential Accessories:

-  Front bezel set for Selector switch, flush mounting page 26
-  Lever, flush mounting page 24
-  Single-LED page 30



	Front protection	Switching system	Contacts	Switching action	Terminals	Typ-Nr.	Component layout	Mounting dimensions	Technical drawing	Circuit drawing	
Selector switch actuator 2 positions, flush mounting Position A : Basic position Position C : Maintained action	IP 65	LL	1 NC	MA	UT	52-476.036	4	3	18	43	0.007
			1 NC + 1 NO	MA	UT	52-473.036	4	3	18	46	0.007
			1 NO	MA	UT	52-475.036	4	3	18	45	0.007
			2 NC	MA	UT	52-472.036	4	3	18	44	0.007
			2 NO	MA	UT	52-471.036	4	3	18	47	0.007
		SA	1 NC + 1 NO	MA	S	52-271.0252		3	18	42	0.006
				S1	52-271.022		3	18	39	0.006	
			2 NC + 2 NO	MA	S	52-272.0252		3	18	38	0.006
			3 NC + 3 NO	MA	S	52-273.0252		3	18	35	0.006
			4 NC + 4 NO	MA	S	52-274.0252		3	18	34	0.006
Position A : Basic position Position C : Momentary action	IP 65	LL	1 NC	M	UT	52-436.036	4	3	18	29	0.007
			1 NC + 1 NO	M	UT	52-433.036	4	3	18	32	0.007
			1 NO	M	UT	52-435.036	4	3	18	31	0.007
			2 NC	M	UT	52-432.036	4	3	18	30	0.007
			2 NO	M	UT	52-431.036	4	3	18	33	0.007
		SA	1 NC + 1 NO	M	S	52-131.0252		3	18	28	0.006
				S1	52-131.022		3	18	25	0.006	
			2 NC + 2 NO	M	S	52-132.0252		3	18	24	0.006
			3 NC + 3 NO	M	S	52-133.0252		3	18	21	0.006
			4 NC + 4 NO	M	S	52-134.0252		3	18	20	0.006

Switching system: LL = Low level switching element, SA = Snap-action switching element

Contacts: NC = Normally closed, NO = Normally open

Switching action: MA = Maintained action, M = Momentary action

Terminals: UT = Universal terminal, S = Soldering terminal, S1 = Soldering terminal (also pluggable 2.8 x 0.5 mm)

Component layout from page 40, Mounting dimensions from page 41, Technical drawing from page 42, Circuit drawing from page 47

Selector switch actuator 3 positions, flush mounting

illuminative

Actuators usable for front dimensions: \square 24 x 24 mm | 25 mm dia.



Essential Accessories:

Front bezel set for Selector switch, flush mounting page 26

Lever, raised mounting page 24

Single-LED page 30

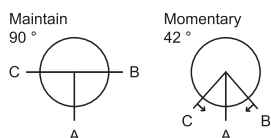

	Front protection	Switching system	Contacts	Switching action	Terminals	Typ-Nr.	Mounting dimensions	Technical drawing	Circuit drawing	
Selector switch actuator 3 positions, flush mounting Position C : Maintained action Position A : Basic position Position B : Maintained action	IP 40	SA	2 NC + 2 NO	MA-0-MA	S1	52-571.022A	3	5	19	0.015
				M-0-MA	S1	52-574.022A	3	5	17	0.015
Position C : Momentary action Position A : Basic position Position B : Momentary action	IP 40	SA	2 NC + 2 NO	MA-0-M	S1	52-573.022A	3	5	18	0.015
				M-0-M	S1	52-572.022A	3	5	16	0.015

Switching system: SA = Snap-action switching element

Contacts: NC = Normally closed, NO = Normally open

Switching action: MA = Maintained action, M = Momentary action

Terminals: S1 = Soldering terminal (also pluggable 2.8 x 0.5 mm)

Mounting dimensions from page 41, Technical drawing from page 42, Circuit drawing from page 47

Front

Lens plastic, raised mounting

	Lens	∅ 18 x 18 mm Typ-Nr.	∅ 18 x 24 mm Typ-Nr.	∅ 18 mm Typ-Nr.	
Lens plastic, raised mounting concave, illuminative	blue transparent	51-954.6	51-904.6		0.001
	colourless transparent	51-954.7	51-904.7		0.001
	green transparent	51-954.5	51-904.5		0.001
	orange transparent	51-954.3	51-904.3		0.001
	red transparent	51-954.2	51-904.2		0.001
	yellow transparent	51-954.4	51-904.4		0.001
flush, illuminative	blue transparent	51-953.6	51-903.6	51-933.6	0.001
	colourless transparent	51-953.7	51-903.7	51-933.7	0.001
	green transparent	51-953.5	51-903.5	51-933.5	0.001
	orange transparent	51-953.3	51-903.3	51-933.3	0.001
	red transparent	51-953.2	51-903.2	51-933.2	0.001
	smoked transparent	51-953.1	51-903.1	51-933.1	0.001
	yellow transparent	51-953.4	51-903.4	51-933.4	0.001
flush, illuminative (not recommended for film insert)	blue translucent	51-951.6	51-901.6	51-931.6	0.001
	colourless transparent	51-955.7	51-905.7	51-935.7	0.001
	green translucent	51-951.5	51-901.5	51-931.5	0.001
	green transparent	51-955.5	51-905.5	51-935.5	0.001
	orange translucent	51-951.3	51-901.3	51-931.3	0.001
	red translucent	51-951.2	51-901.2	51-931.2	0.001
	red transparent	51-955.2	51-905.2	51-935.2	0.001
	white translucent	51-951.9	51-901.9	51-931.9	0.001
	yellow translucent	51-951.4	51-901.4	51-931.4	0.001
	yellow transparent	51-955.4	51-905.4	51-935.4	0.001
flush, non-illuminative	black opaque	51-951.0	51-901.0	51-931.0	0.001
	grey opaque	51-951.8	51-901.8	51-931.8	0.001
concave, illuminative (not recommended for film insert)	colourless transparent		51-906.7		0.001
	green transparent		51-906.5		0.001
	red transparent		51-906.2		0.001
	yellow transparent		51-906.4		0.001



Lens plastic, flush mounting

mat

	Lens	∅ 24 x 24 mm Typ-Nr.	∅ 24 x 30 mm Typ-Nr.	∅ 25 mm Typ-Nr.	
Lens plastic, flush mounting illuminative	blue transparent flush	61-9671.6	61-9681.6	61-9642.6	0.002
	colourless transparent flush	61-9671.7	61-9681.7	61-9642.7	0.002
	green transparent flush	61-9671.5	61-9681.5	61-9642.5	0.002
	orange transparent flush	61-9671.3	61-9681.3	61-9642.3	0.002
	red transparent flush	61-9671.2	61-9681.2	61-9642.2	0.002
	smoked transparent flush	61-9671.1	61-9681.1	61-9642.1	0.002
	yellow transparent flush	61-9671.4	61-9681.4	61-9642.4	0.002
non-illuminative	black opaque flush	61-9771.0	61-9781.0		0.002
	grey opaque flush	61-9771.8	61-9781.8		0.002
	white translucent flush	61-9771.9	61-9781.9		0.002



Lens plastic with symbol, flush mounting

	Symbol	Lens	Ø 25 mm Typ-Nr.	
Lens plastic with symbol, flush mounting flush - level, illuminative	ON/OFF	blue transparent	61-9643.602	0.002
		colourless transparent	61-9643.702	0.002
		green transparent	61-9643.502	0.002
		red transparent	61-9643.202	0.002
	Ring	blue transparent	61-9643.601	0.002
		colourless transparent	61-9643.701	0.002
		green transparent	61-9643.501	0.002
		orange transparent	61-9643.301	0.002
		red transparent	61-9643.201	0.002
		yellow transparent	61-9643.401	0.002
	Stand by	blue transparent	61-9643.603	0.002
		colourless transparent	61-9643.703	0.002
		green transparent	61-9643.503	0.002
red transparent		61-9643.203	0.002	



The silvery coat is being applied on the lens (screen print) with an additional protective lacquer.

Marking plate for lens round plastic, flush mounting

can be hot stamped

	Marking plate	Typ-Nr.	
Marking plate for lens round plastic, flush mounting only applicable with Lens round Typ-Nr. 61-9642.X	Plastic colourless transparent	61-9707.7	0.001



Lens metal with spot, flush mounting

mat

	Lens	Ø 25 mm Typ-Nr.	
Lens metal with spot, flush mounting	Aluminium black flush	61-9841.0A	0.002
	Aluminium blue flush	61-9841.6A	0.002
	Aluminium gold flush	61-9841.4A	0.002
	Aluminium natural flush	61-9841.8A	0.002
	Aluminium olive-green flush	61-9841.5A	0.002
	Aluminium red flush	61-9841.2A	0.002



Lens metal, flush mounting

mat

	Lens	Ø 25 mm Typ-Nr.	
Lens metal, flush mounting convex	Aluminium black	61-9842.0	0.003
	Aluminium blue	61-9842.6	0.003
	Aluminium gold	61-9842.4	0.003
	Aluminium natural	61-9842.8	0.003
	Aluminium olive-green	61-9842.5	0.003
	Aluminium red	61-9842.2	0.003
flush	Aluminium black	61-9841.0	0.002
	Aluminium blue	61-9841.6	0.002
	Aluminium gold	61-9841.4	0.002
	Aluminium natural	61-9841.8	0.002
	Aluminium olive-green	61-9841.5	0.002
	Aluminium red	61-9841.2	0.002



Mushroom-head cap, flush mounting

	Mushroom had cap	Ø 32 mm Typ-Nr.	
Mushroom-head cap, flush mounting	Plastic black opaque	61-9593.0	0.004
	Plastic green opaque	61-9593.5	0.004
	Plastic red opaque	61-9593.2	0.004
	Plastic yellow opaque	61-9593.4	0.004



Front bezel square for selector switch, raised mounting

	Front bezel	Typ-Nr.	
Front bezel square for selector switch, raised mounting 24 x 24 mm	Plastic black	52-950.0	0.001
26 x 26 mm	Plastic black	52-952.0	0.001



Lever, raised mounting

with bar and marking dot

	Lever	Bar colour	Typ-Nr.	 kg
Lever, raised mounting illuminative	Plastic black	blue	52-928.60	0.001
		green	52-928.50	0.001
		orange	52-928.30	0.001
		red	52-928.20	0.001
		yellow	52-928.40	0.001
	Plastic grey	blue	52-929.60	0.001
		green	52-929.50	0.001
		orange	52-929.30	0.001
		red	52-929.20	0.001
		yellow	52-929.40	0.001
non-illuminative	Plastic black	black	52-928.0	0.001
	Plastic grey	grey	52-929.8	0.001
		white	52-929.9	0.001



Lever, flush mounting

with bar and marking dot

	Lever	Bar colour	Typ-Nr.	 kg
Lever, flush mounting illuminative	Plastic black	blue	61-9028.60	0.001
		green	61-9028.50	0.001
		orange	61-9028.30	0.001
		red	61-9028.20	0.001
		yellow	61-9028.40	0.001
	Plastic grey	blue	61-9029.60	0.001
		green	61-9029.50	0.001
		orange	61-9029.30	0.001
		red	61-9029.20	0.001
		yellow	61-9029.40	0.001
non-illuminative	Plastic black	black	61-9028.0	0.001
		white	61-9028.9	0.001
	Plastic grey	grey	61-9029.8	0.001
		white	61-9029.9	0.001



Legend frame

for devices 25 mm dia., flush mounting

	Typ-Nr.	Technical drawing	 kg
Legend frame 30 x 50 mm, adhesive, Aluminium black	61-9980.0	10	0.001



Technical drawing from page 42

Legend plate insert

for Legend frame 61-9980.0

	Typ-Nr.	
Legend plate insert 14.5 x 23.5 mm, adhesive, Aluminium black	704.968.1	0.001
14.5 x 23.5 mm, adhesive, Aluminium natural	704.968.0	0.001



Front bezel set for Indicators and Illuminated pushbutton, flush mounting

	Front bezel	∅ 24 x 24 mm Typ-Nr.	∅ 24 x 30 mm Typ-Nr.	∅ 25 mm Typ-Nr.	Mounting dimensions	
Front bezel set for Indicators and Illuminated pushbutton, flush mounting	Plastic black	61-9930.0	61-9931.0	61-9933.10	3	0.008
	Plastic silver	61-9930.4	61-9931.4		3	0.008
	Aluminium black			61-9933.1	3	0.006
	Aluminium blue			61-9933.6	3	0.006
	Aluminium gold			61-9933.4	3	0.006
	Aluminium natural			61-9933.0	3	0.006
	Aluminium olive-green			61-9933.5	3	0.006
	Aluminium red			61-9933.2	3	0.006



Mounting dimensions from page 41

Front bezel set for Mushroom-head pushbutton, flush mounting

	Front bezel	∅ 40 mm Typ-Nr.	∅ 25 mm Typ-Nr.	Mounting dimensions	
Front bezel set for Mushroom-head pushbutton, flush mounting	Aluminium natural	61-9934.8		4	0.013
	Aluminium black		61-9933.1	4	0.006
	Aluminium blue		61-9933.6	4	0.006
	Aluminium gold		61-9933.4	4	0.006
	Aluminium natural		61-9933.0	4	0.006
	Aluminium olive-green		61-9933.5	4	0.006
	Aluminium red		61-9933.2	4	0.006
	Plastic black		61-9933.10	4	0.008



Mounting dimensions from page 41

Front bezel set for Keylock switch, flush mounting

	Front bezel	∅ 24 x 24 mm Typ-Nr.	∅ 24 x 30 mm Typ-Nr.	∅ 25 mm Typ-Nr.	Mounting dimensions	
Front bezel set for Keylock switch, flush mounting	Plastic black	61-9930.0	61-9931.0	61-9932.10	3	0.008
	Plastic silver	61-9930.4	61-9931.4		3	0.008
	Aluminium black			61-9932.1	3	0.006
	Aluminium blue			61-9932.6	3	0.006
	Aluminium gold			61-9932.4	3	0.006
	Aluminium natural			61-9932.0	3	0.006
	Aluminium olive-green			61-9932.5	3	0.006
	Aluminium red			61-9932.2	3	0.006



With the round front bezel sets ∅25 mm the anti-twist ring is part of the sales-package.
Mounting dimensions from page 41

Front bezel set for Selector switch, flush mounting

	Front bezel	∅ 24 x 24 mm Typ-Nr.	∅ 25 mm Typ-Nr.	Mounting dimensions	
Front bezel set for Selector switch, flush mounting	Plastic black	61-9936.0		3	0.007
	Aluminium black		61-9932.1	3	0.006
	Aluminium blue		61-9932.6	3	0.006
	Aluminium gold		61-9932.4	3	0.006
	Aluminium natural		61-9932.0	3	0.006
	Aluminium olive-green		61-9932.5	3	0.006
	Aluminium red		61-9932.2	3	0.006
	Plastic black		61-9932.10	3	0.008



With the round front bezel sets ∅25 mm the anti-twist ring is part of the sales-package.
Mounting dimensions from page 41

Front protective cap

for flush - level lenses only for protection IP 68

	Front protective cap	Typ-Nr.	
Front protective cap for front bezel set 24 x 30 mm, flush mounting	Silicone natural transparent	61-9927.2	0.001
for front bezel set 25 mm dia., flush mounting	Silicone natural transparent	84-9103.7	0.001



ATTENTION

when using the front protection cover for push buttons the external sealing in the front bezel set and the silicone bellows in the actuator are to be removed !

Protective cover, raised mounting

	Ø 18 x 18 mm Typ-Nr.	Ø 18 x 24 mm Typ-Nr.	Technical drawing	
Protective cover, raised mounting hinged, transparent, with means for sealing	51-920		2	0.002
		51-925	3	0.002



Technical drawing from page 42

Protective cover, flush mounting

	Ø 24 x 24 mm Typ-Nr.	Ø 24 x 30 mm Typ-Nr.	Ø 25 mm Typ-Nr.	Mounting dimensions	Technical drawing	
Protective cover, flush mounting hinged, transparent, with means for sealing	61-9921.0			3	7	0.006
		61-9922.0		3	8	0.006
slide by side, with means not for sealing			61-9924.0	3	9	0.006



Mounting dimensions from page 41, Technical drawing from page 42

Blind plug, raised mounting

	Blind plug	Ø 18 x 18 mm Typ-Nr.	Ø 18 x 24 mm Typ-Nr.	Ø 18 mm Typ-Nr.	Mounting dimensions	
Blind plug, raised mounting	Plastic black	51-948.0	51-947.0	51-949.0	1	0.003



Blind plugs fit also in mounting holes no. 2
Mounting dimensions from page 41

Blind plug, flush mounting

	Blind plug	Ø 24 x 24 mm Typ-Nr.	Ø 24 x 30 mm Typ-Nr.	Ø 25 mm Typ-Nr.	Mounting dimensions	Technical drawing	
Blind plug, flush mounting	Plastic black	61-9451.0	61-9452.0		3		0.006
				61-9453.0	3	11	0.006



Mounting dimensions from page 41, Technical drawing from page 42

Master key

	Typ-Nr.	
Master key Lock numbers 311 ... 445 (DOM)	31-989.300	0.006



Spare key

	Typ-Nr.	
Spare key Key lock switch, standard lock 311 (DOM)	31-989.311	0.006



Other lock numbers on request

EMC Key protection cap

	Typ-Nr.	
EMC Key protection cap Plastic black, for lock type DOM	31-985.0	0.005



Backside

PCB plug-in base

	Terminals	Typ-Nr.	Component layout	
PCB plug-in base 16.4 mm dia. x 9.8 mm for Low level switching element, Pins axial	P	31-940	2	0.002
17.8 x 12.9 mm x 9.8 mm for Snap-action switching element 2.8 mm, Pins axial	P	31-942	3	0.002
17.9 x 17.9 x 8.4 mm for Low level switching element, Pins bent at right-angle	P	31-941	1	0.004



PCB plug-in base Pins right-angle : With the extendable mounting the distance between plug-in base and PCB can be varied up to 3 mm.

Terminals: P = PCB terminal

Component layout from page 40

Multi-plug housing

	Typ-Nr.	
Multi-plug housing for Switching block	51-943.0	0.005



Flat receptacle

	Typ-Nr.	
Flat receptacle 2.0 x 0.5 mm for Universal terminal	31-945	0.001
2.8 x 0.5 mm for Multi-plug housing	51-943.1	0.001
2.8 x 0.5 mm for Plug-in terminal	31-946	0.001



Insulation sleeve

	Typ-Nr.	
Insulation sleeve Cover Plug-in terminals for snap-action switching element 2.8 mm	01-928	0.001
for Flat receptacle 31-945	31-928	0.001
for Flat receptacle 31-946	31-929	0.001



Terminal cover

	Typ-Nr.	
Terminal cover	01-929	0.010



Illumination

Filament lamp

	Socket	Operating voltage/-current	Typ-Nr.	
Filament lamp	T1 3/4 MG	12 VAC/DC, 75 mA	10-1309.1309	0.001
		14 VAC/DC, 80 mA	10-1310.1319	0.001
		18 VAC/DC, 40 mA	10-1311.1249	0.001
		24 VAC/DC, 35 mA	10-1312.1229	0.001
		28 VAC/DC, 30 mA	10-1313.1209	0.001
		28 VAC/DC, 40 mA	10-1313.1249	0.001
		36 VAC/DC, 20 mA	10-1316.1179	0.001
		36 VAC/DC, 30 mA	10-1316.1209	0.001
		48 VAC/DC, 20 mA	10-1319.1179	0.001
		48 VAC/DC, 25 mA	10-1319.1199	0.001
		6 VAC/DC, 120 mA	10-1306.1349	0.001
		6.3 VAC/DC, 200 mA	10-1307.1369	0.001



Single-LED

Single-LED	Socket	Light colour	Operating voltage/-current	Typ-Nr.		
Single-LED	T1 3/4 MG	blue	12 VAC/DC, 7/14 mA	10-2J09.1066	0.002	
			24 VAC/DC, 7/14 mA	10-2J12.1066	0.002	
			28 VAC/DC, 7/14 mA	10-2J13.1066	0.002	
			48 VAC/DC, 4/8 mA	10-2J19.1046	0.002	
			6 VDC, 15 mA	10-2J06.3146	0.002	
			12 VAC/DC, 4/7 mA	10-2J09.1065	0.002	
		green	24 VAC/DC, 4/7 mA	10-2J12.1065	0.002	
			28 VAC/DC, 4/7 mA	10-2J13.1065	0.002	
			48 VAC/DC, 2/4 mA	10-2J19.1045	0.002	
			6 VDC, 7 mA	10-2J06.3145	0.002	
			red	12 VAC/DC, 7/14 mA	10-2J09.1062	0.002
				24 VAC/DC, 7/14 mA	10-2J12.1062	0.002
		28 VAC/DC, 7/14 mA		10-2J13.1062	0.002	
		48 VAC/DC, 4/8 mA		10-2J19.1042	0.002	
		6 VDC, 15 mA		10-2J06.3142	0.002	
		12 VAC/DC, 7/14 mA		10-2J09.1069	0.002	
		white diffuse	24 VAC/DC, 7/14 mA	10-2J12.1069	0.002	
			28 VAC/DC, 7/14 mA	10-2J13.1069	0.002	
			48 VAC/DC, 4/8 mA	10-2J19.1049	0.002	
			6 VDC, 15 mA	10-2J06.3149	0.002	
			yellow	12 VAC/DC, 7/14 mA	10-2J09.1064	0.002
				24 VAC/DC, 7/14 mA	10-2J12.1064	0.002
		28 VAC/DC, 7/14 mA		10-2J13.1064	0.002	
		48 VAC/DC, 4/8 mA		10-2J19.1044	0.002	
		6 VDC, 15 mA		10-2J06.3144	0.002	



Note:
AC operation through halve-wave rectifier possible, slight flickering can occur.

Series resistor

for lamp voltage reduction

Series resistor	Operating voltage	Typ-Nr.	
10 kΩ, for filament lamp 48 VAC, 25 mA	230/240 V	02-904.7	0.003
2.7 kΩ, for filament lamp 48 VAC, 25 mA	110 V	02-904.0	0.003
3.3 kΩ, for filament lamp 48 VAC, 25 mA	125 V	02-904.1	0.003
4.7 kΩ, for filament lamp 48 VAC, 25 mA	145 V	02-904.3	0.003



Please keep to the country specific security rules.

Terminal plate empty

for fitting with series resistors

Terminal plate empty	Typ-Nr.	
10 spaces 125 x 60 x 15 mm	02-912.2	0.045
15 spaces 187.5 x 60 x 15 mm	02-912.3	0.090
20 spaces 250 x 60 x 15 mm	02-912.4	0.095
5 spaces 62.5 x 60 x 15 mm	02-912.1	0.025



Assembling

Fixing nut

	Typ-Nr.	
Fixing nut Metal, specifically for keylock switches	31-991	0.005



Anti-twist ring

for Key lock- and Selector switch

	Typ-Nr.	
Anti-twist ring	51-910	0.001



Lens remover

	Typ-Nr.	
Lens remover for flush mounting	61-9730.0	0.011
for raised mounting	02-905	0.011



Lamp remover

	Typ-Nr.	
Lamp remover	61-9740.0	0.003



CAUTION

A switching process might be released when replacing the lamp/LED !

Mounting tool

	Typ-Nr.	
Mounting tool	01-907	0.020



Dismantling tool

	Typ-Nr.	
Dismantling tool for dismantling of Lens, Lens holder and Switching element block	51-938	0.027



Flat receptacle remover

	Typ-Nr.	 kg
Flat receptacle remover for removing the Flat receptacle of the Multi-plug in housing	51-943.9	0.001



Actuator with snap-action switching element

Switching system

Self-cleaning, double-break, snap action switching system (with contact gap 2 x 0.5 mm).
 1 normally closed or 1 normally open contact per element.
 Snap-action switching elements with soldering terminals at the sides: up to 4 switching element can be on a pushbutton (max. 4 normally closed and 4 normally open contacts).
 Snap-action switching element with axial plug-in terminals 2.8 mm stachable, only 1 switching element can be on a pushbutton.

Material

Material of contact
 Gold plated silver

Switch housing
 Axial soldering-/plug-in terminal 2.8 mm:
 Diallylphthalate DAP, Polyamide 66, Polysulfone, heat-resistant and self-extinguishing.
 Soldering terminal: PA 6.6 Ultramid

Actuator housing
 Polyetherimide, self-extinguishing

Mechanical characteristics

Terminals
 Snap-action switching element with tinned soldering terminals at the sides:
 Max. wire diameter 2 wires à 1.2 mm
 Max. wire cross-section of stranded cable 1 x 1 mm²

Snap-action switching element with axial soldering terminals, which can also be used as plug-in terminals 2.8 x 0.5 mm:
 Max. wire diameter 2 wires of 1 mm
 Max. wire cross-section of stranded cable 2 of 0.75 mm² or 1 x 1.0 mm²

Actuating torque
 2.5 Ncm ... 5.5 Ncm, depending on the number of switching elements. Measured at the key or lever of the keylock- or selector switch.

Actuating force
 4 N ... 6 N, depending on the number of switching elements

Actuating travel
 Illuminated pushbutton 3 mm

Keylock-/selector switch actuator 2 positions:
 1x ca. 42° deflection momentary action
 1x ca. 90° deflection maintained action

Rebound time
 ≤5ms

Mechanical lifetime

Momentary action	2 million cycles of operation
Maintained action	1 million cycles of operation
Keylock switch	50 000 cycles of operation

Electrical characteristics

Standards
 IEC 61058, EN 61058

Rated voltage
 250 VAC/VDC

Rated current
 5 A

Contact resistance
 Starting value (initial) ≤50 mΩ

Electrostatic discharge (ESD)
 ≤15 KV (Keylock switch)

Conventional free air thermal current
 5 A
 The maximum current in continuous operation and at ambient temperature not exceeding the quoted maximum values.

Switch rating
 250 VAC, 5 A (cosφ 1)
 250 VAC, 3 A (cosφ 0,3)

Switch rating AC (cosφ 0,7)

Voltage	125 VAC	250 VAC
Current	3 A	2 A

Switch rating DC (inductive) L:R = 30 ms

Voltage	24 VDC	60 VDC	110 VDC	220 VDC
Current	2 A	0.7 A	0.2 A	0.1 A

Electric strength
 2500 VAC, 50 Hz, 1 min. between all terminals and earth, as per IEC 60512-2-11

Protection class
 II

Environmental conditions

Storage temperature
 -40 °C ... +85 °C

Service temperature
 -25 °C ... +55 °C
 For indicators and illuminated pushbuttons mounted as a block, make sure the heat can escape freely.

Protection degree
 IP 65 front side, as per IEC 60529

Shock resistance
 (Single impacts, semi-sinusoidal)
 15 g for 11 ms, as per IEC 60512-4-3, IEC 60068-2-27

Vibration resistance
 (Sinusoidal)
 10 g at 10 Hz ... 1500 Hz, amplitude 1.5 mm, as per IEC 60512-4-4, IEC 60068-2-6

Climate resistance
 Standard condition, as per IEC 60068-2-3 and 2-30
 Changing condition, as per IEC 60068-2-14 and 2-33

Approvals

Approbations
 CB (IEC 61058)
 CSA
 ENEC (EN 61058)
 Germanischer Lloyd
 UL

Declaration of conformity
CE

Actuator with snap-action switching element block (Keylock- and Selector switch 3 positions)

Switching system

Self-cleaning, double-break, snap action switching system
1 normally closed or 1 normally open contact per element.

Material

Material of contact
Gold plated hardsilver

Switch housing
Diallylphthalate (DAP), heat-resistant and self-extinguishing

Actuator housing
Polyetherimide, self-extinguishing

Mechanical characteristics

Terminals
Soldering terminal which can also be used as plug-in terminal
2.8 x 0.5 mm:
Max. wire diameter 2 wires of 1 mm
Max. wire cross-section of stranded cable 2 x 0.75 mm²

Actuating torque
2.5 Ncm ... 5.5 Ncm, depending on the number of switching elements. Measured at the key or lever of the keylock- or selector switch.

Actuating travel
Keylock-/selector switch actuator with 3 positions
2x ca. 42° deflection momentary action
2x ca. 90° deflection maintained action

Rebound time
≤5ms

Mechanical lifetime
Keylock switch 50 000 cycles of operation
Selector switch 100 000 cycles of operation

Electrical characteristics

Electrostatic discharge (ESD)
≤15 KV (Keylock switch)

Conventional free air thermal current
5 A
The maximum current in continuous operation and at ambient temperature not exceeding the quoted maximum values.

Switch rating
250 VAC, 5 A (cosφ 0,75)

Electric strength
2500 VAC, 50 Hz, 1 min. between all terminals and earth, as per IEC 60512-2-11

Protection class
II

Environmental conditions

Storage temperature
-40 °C ... +85 °C

Service temperature
-25 °C ... +55 °C
for selector switches mounted as a block, make sure the heat can escape freely

Protection degree
Front side, as per IEC 60529
IP 65 keylock switch
IP 40 selector switch

Approvals

Approbations
CB (IEC 61058)
CSA
ENEC (EN 61058)
Germanischer Lloyd
UL

Declaration of conformity
CE

Actuator with low level switching element

Switching system

This low level switching element was designed for switching low powers in electronic circuits. The mechanism assures reliable switching of loads ranging from a few μA / μV up to 100 mA / 42 VAC/ DC.

Single-break momentary contact, as normally open or normally closed with 4 independent points of contact. 2 momentary contacts per switching element; combination of normally open and normally closed is possible.
Special features are the long life, extremely short rebound time and stable contact resistance.

Material

Material of contact
Gold plated

Switch housing
Polysulfone, heat-resistant and self-extinguishing

Actuator housing
Polyetherimide, self-extinguishing

Mechanical characteristics

Terminals
The universal terminals permit these units to be mounted on printed circuit boards (PCB). These terminals can also be used as soldering or plug-in terminals.
For these terminals we can also supply a plug-in base which, when soldered on to the board, enables the switch to be plugged in.
Soldering terminal:
Max. wire diameter 2 wires à 0.8 mm
Max. wire cross-section of stranded cable 1x 0.75 mm²

Plug-in terminal 2.0 x 0.5 mm

Actuating torque
2.5 Ncm ... 5.5 Ncm, measured at the key or lever of the keylock- or selector switch

Actuating force

3 N ... 3,5 N

Actuating travel

Illuminated pushbutton 3 mm

Keylock-/selector switch actuator 2 positions:

1x ca. 42° deflection momentary action

1x ca. 90° deflection maintained action

Rebound time

Typ. <100 µs

Mechanical lifetime

Momentary action 5 million cycles of operation

Maintained action 1 million cycles of operation

Keylock switch 50 000 cycles of operation

Electrical characteristics**Contact resistance**

Starting value (initial) ≤50 mΩ

Electrostatic breakdown value

≤15 KV (Keylock switch)

Switch rating

10 µA, 100 µV to 100 mA at 42 VAC/VDC

Electric strength

2500 VAC, 50 Hz, 1 min. between all terminals and earth, as per IEC 60512-2-11

Environmental conditions**Storage temperature**

-40 °C ... +85 °C

Service temperature

-25 °C ... +55 °C

For indicators and illuminated pushbuttons mounted as a block, make sure the heat can escape freely.

Protection degree

IP 65 front side, as per IEC 60529

Shock resistance

(Single impacts, semi-sinusoidal)

15 g for 11 ms, as per IEC 60512-4-3, IEC 60068-2-27

Diode element

When indicators and illuminated pushbuttons equipped with diodes, the user is able to perform a lamp check or wire an alarm circuit simply with a considerable saving of space.

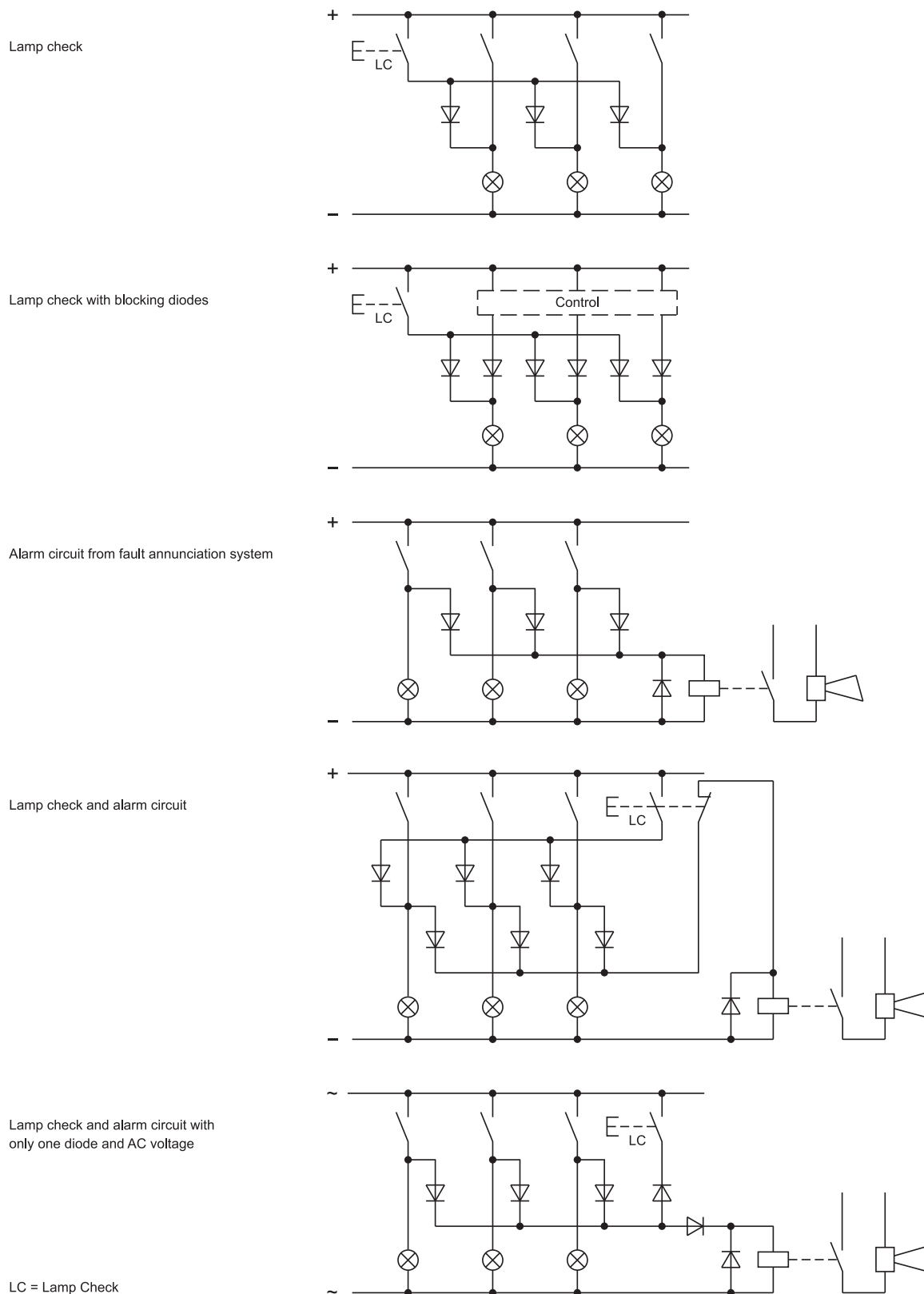

LC = Lamp Check

Suppressor circuits

When switching inductive loads such as relays, DC motors, and DC solenoids, it is always important to absorb surges (e.g. with a diode) to protect the contacts. When these inductive loads are switched off, a counter emf can severely damage switch contacts and greatly shorten lifetime.

Fig. 1 shows an inductive load with a free-wheeling diode connected in parallel. This free-wheeling diode provides a path for the inductor current to flow when the current is interrupted by the switch. Without this free-wheeling diode, the voltage across the coil will be limited only by dielectric breakdown voltages of the circuit or parasitic elements of the coil. This voltage can be kilovolts in amplitude even when nominal circuit voltages are low (e.g. 12 VDC) see Fig. 2.

The free-wheeling diode should be chosen so that the reverse breakdown voltage is greater than the voltage driving the inductive load. The DC blocking voltage (V_R) of the free-wheeling diode can be found in the datasheet of a diode. The forward current should be equal or greater than the maximum current flowing through the load.

To get an efficient protection, the free-wheeling diode must be connected as close as possible to the inductive load!

Switching with inductive load
Fig. 1



Counter emf
over load without free-wheeling diode
Fig. 2



General notes

1. Engraving

In addition to the most commonly used world languages, in DIN 1451-3 close spacing, other typefaces are available as Scandinavian, Slavic, Greek, Russian and Polish.

Red, blue and black lenses are filled with white colour. Other colour lenses are filled in black. Standard height of letters is 2 mm. If the height is not specified, we will supply 2 mm engraved letters.

2. Hot stamping

For larger series it is worth considering markings by means of hot stamping. We will be pleased to advise you.

For letters and figures, typefaces with 2.5 mm, 3 mm and 4 mm are available.

3. Film inserts

Instead of using engraving the lenses can be fitted with transparent film inserts, as an alternative. For this purpose, though, it is advisable to use transparent lenses.

In the case of use of a smoke-black lens the fitted film becomes readable only if the lamp is on.

The film thickness is 0.2 mm.

Important : Consider pushbutton mounting orientation before specifying engraving characters !

Lenses for indicators and illuminated pushbuttons, raised mounting

All dimensions in mm

Front size (Lens)	Film insert max. size	Height of letters h	Number of lines	Number of (target value) capital letters per line	Number of (target value) small letters per line	Image
18 dia. (15.8 dia.)	12.8 dia.	2	3	6	6	B4
		3	2	5	6	B4
		4	2	3	4	B4
		5	1	2	3	B4
		6	1	2	3	B4
		8	1	2	2	B4
18 x 18 (15.3 x 15.3)	12.7 x 12.7	2	4	7 - 8	8	B3
		3	3	6 - 7	7	B3
		4	2	4 - 5	5	B3
		5	2	3 - 4	4	B3
		6	1	3	3 - 4	B3
		8	1	2 - 3	2 - 3	B3
18 x 24 (15.3 x 21.5)	12.7 x 18.7	2	4	11	12	B1
			5	7 - 8	8	B2
		3	3	9 - 10	10 - 11	B1
			4	6 - 7	7	B2
		4	2	7	7 - 8	B1
			3	4 - 5	5	B2
		5	2	5 - 6	6	B1
				3 - 4	4	B2
		6	1	4 - 5	5	B1
			2	3	3 - 4	B2
		8	1	3 - 4	3 - 4	B1
				2 - 3	2 - 3	B2



B1



B2



B3



B4



Lenses for indicators and illuminated pushbuttons, flush mounting

All dimensions in mm

Front size (Lens)	Film insert max. size	Height of letters h	Number of lines	Number of (target value) capital letters per line	Number of (target value) small letters per line	Image
24 x 24 (18 x 18)	15.1 x 15.1	2	4	8 - 9	9	B3
		3	3	7 - 8	8	B3
		4	2	4 - 5	5	B3
		5	2	4	4 - 5	B3
		6	1	4	4	B3
		8	1	2 - 3	2 - 3	B3
24 x 30 (18 x 24)	15.1 x 21	2	4	12	13	B1
			5	8 - 9	9	B2
		3	3	10 - 11	11 - 12	B1
			4	7 - 8	8	B2
		4	2	7	8	B1
			3	4 - 5	5	B2
		5	2	5 - 6	6	B1
				4	4 - 5	B2
		6	1	4 - 5	5	B1
			2	3	3 - 4	B2
		8	1	3 - 4	3 - 4	B1
				2 - 3	2 - 3	B2
25 dia. (19.7 dia.)	Marking plate	2	3	6	6	B4
		3	2	5	6	B4
		4	2	3	4	B4
		5	1	2	3	B4
		6	1	2	3	B4
		8	1	2	2	B4



Component layout

1 PCB plug-in base page 28



2 PCB plug-in base page 28



3 PCB plug-in base page 28

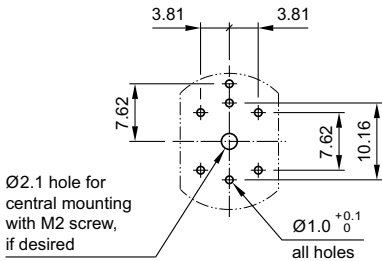

4 Indicator actuator page 7 | Illuminated pushbutton actuator page 8 | Keylock switch 2 positions page 9 | Selector switch 2 positions page 11 | Indicator actuator, flush mounting page 13 | Illuminated pushbutton actuator, flush mounting page 14 | Keylock switch actuator 2 positions, flush mounting page 15 | Selector switch actuator 2 positions, flush mounting page 19

Terminal (rearside)

PCB layout (conductor side)



Mounting dimensions

1 Indicator actuator page 7 | Illuminated pushbutton actuator page 8 | Blind plug, raised mounting page 27

18 x 18 mm

18 x 24 mm

Ø18 mm



2 Keylock switch 2 positions page 9 | Keylock switch 3 positions page 10 | Selector switch 2 positions page 11 | Selector switch 3 positions page 12

18 x 18 mm

18 x 24 mm

Ø18 mm

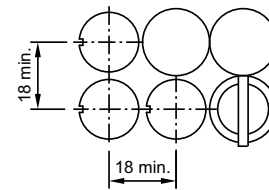

3 Indicator actuator, flush mounting page 13 | Illuminated pushbutton actuator, flush mounting page 14 | Keylock switch actuator 2 positions, flush mounting page 15 | Keylock switch actuator 3 positions, flush mounting page 18 | Selector switch actuator 2 positions, flush mounting page 19 | Selector switch actuator 3 positions, flush mounting page 20 | Front bezel set for Indicators and Illuminated pushbutton, flush mounting page 25 | Front bezel set for Keylock switch, flush mounting page 26 | Front bezel set for Selector switch, flush mounting page 26 | Protective cover, flush mounting page 27 | Blind plug, flush mounting page 27

Ø25 mm

24 x 30 mm

24 x 24 mm



- Hole spacing min. 26 mm / min. 26 mm by using of the round front protective cap 84-9103.7
- Hole spacing min. 31 mm / min. 25 mm by using of the rectangular front protectice cap 61-9927.2

4 Front bezel set for Mushroom-head pushbutton, flush mounting page 25



Technical drawing

1 Keylock switch 3 positions page 10



2 Protective cover, raised mounting page 27

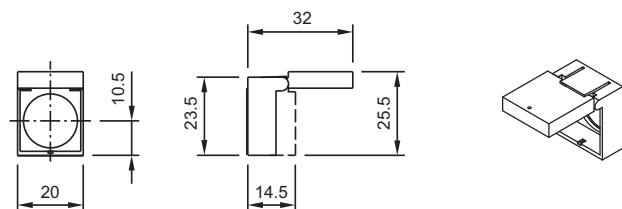

3 Protective cover, raised mounting page 27

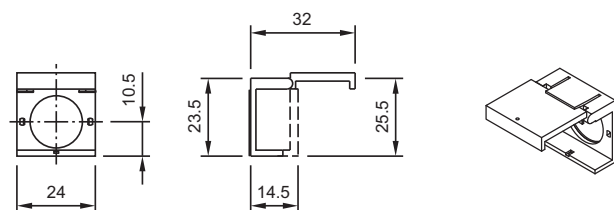

4 Keylock switch actuator 3 positions, flush mounting page 18



5 Selector switch actuator 3 positions, flush mounting page 20



6 Selector switch 3 positions page 12



7 Protective cover, flush mounting page 27



8 Protective cover, flush mounting page 27



9 Protective cover, flush mounting page 27



10 Legend frame page 24

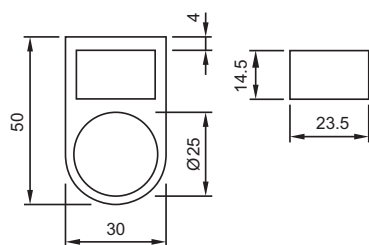

11 Blind plug, flush mounting page 27



12 Indicator actuator page 7

Soldering terminal	Soldering terminal (also pluggable)	Universal terminal	Universal terminal + diodes
L	L1	U	U+D
23	26	35	-
1D, 2D			35

13 Illuminated pushbutton actuator page 8

	Soldering terminal	Soldering terminal (also pluggable)	Universal terminal	Combined terminal + diodes
	L	L1	U	H+D
1NC+1NO	28	36	-	-
2NC+2NO	35.5	-	-	-
3NC+3NO	43	-	-	-
4NC+4NO	50.5	-	-	-
1NC+1NO+D	-	-	-	43.5
2NO+2NC+D	-	-	-	51
1NC, 1NO, 1NC+1NO, 2NC, 2NO	35			-

14 Keylock switch 2 positions page 9

	Soldering terminal	Soldering terminal (also pluggable)	Universal terminal
	L	L1	U
1NC+1NO	26.5	36	-
2NC+2NO	34	-	-
3NC+3NO	41.5	-	-
4NC+4NO	49	-	-
1NC, 1NO, 1NC+1NO, 2NC, 2NO	35.5		

15 Indicator actuator, flush mounting page 13

Soldering terminal		Soldering terminal (also pluggable)		Universal terminal	
L	L1	U			
31	34	44			

16 Illuminated pushbutton actuator, flush mounting page 14

	Soldering terminal		
	L	L1	U
1NC+1NO	36.5	44	-
2NC+2NO	44	-	-
3NC+3NO	51.5	-	-
4NC+4NO	59	-	-
1NC, 1NO, 1NC+1NO, 2NC, 2NO	44		

17 Keylock switch actuator 2 positions, flush mounting page 15

	Soldering terminal		
	L	L1	U
1NC+1NO	35	44.5	-
2NC+2NO	42.5	-	-
3NC+3NO	50	-	-
4NC+4NO	57.5	-	-
1NC, 1NO, 1NC+1NO, 2NC, 2NO	44.5		

18 Selector switch actuator 2 positions, flush mounting page 19

	Soldering terminal	Soldering terminal (also pluggable)	Universal terminal
	L	L1	U
1NC+1NO	41	48	-
2NC+2NO	48.5	-	-
3NC+3NO	56	-	-
4NC+4NO	63.5	-	-
1NC, 1NO, 1NC+1NO, 2NC, 2NO	48		

19 Selector switch 2 positions page 11

	Soldering terminal	Soldering terminal (also pluggable)	Universal terminal	Combined terminal + diodes
	L	L1	U	H+D
1NC+1NO	32	36	-	-
2NC+2NO	39.5	-	-	-
3NC+3NO	47	-	-	-
4NC+4NO	54.5	-	-	-
1NC+1NO+D	-	-	-	43.5
2NC+2NO+D	-	-	-	51
1NC, 1NO, 1NC+1NO, 2NC, 2NO	39			

Circuit drawing

1 Indicator actuator page 7 | Indicator actuator, flush mounting page 13



2 Illuminated pushbutton actuator page 8 | Illuminated pushbutton actuator, flush mounting page 14



3 Illuminated pushbutton actuator page 8 | Illuminated pushbutton actuator, flush mounting page 14



4 Illuminated pushbutton actuator page 8

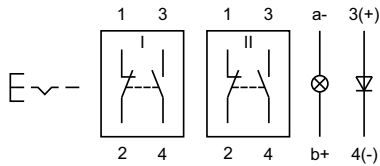

5 Illuminated pushbutton actuator page 8

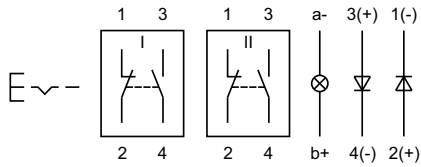

6 Illuminated pushbutton actuator page 8 | **Illuminated pushbutton actuator, flush mounting** page 14

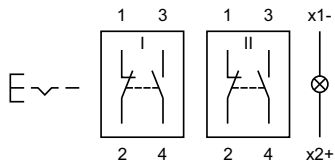

7 Illuminated pushbutton actuator page 8 | **Illuminated pushbutton actuator, flush mounting** page 14

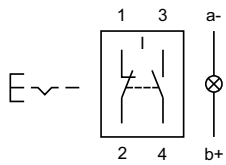

8 Illuminated pushbutton actuator page 8

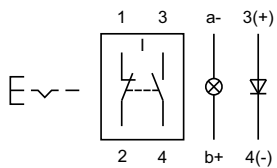

9 Illuminated pushbutton actuator page 8

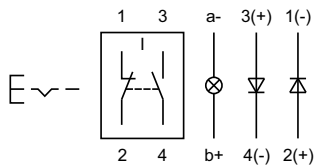

10 Illuminated pushbutton actuator page 8 | **Illuminated pushbutton actuator, flush mounting** page 14

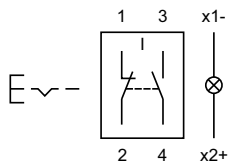

11 Illuminated pushbutton actuator page 8 | **Illuminated pushbutton actuator, flush mounting** page 14

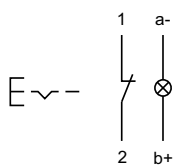

12 Illuminated pushbutton actuator page 8 | **Illuminated pushbutton actuator, flush mounting** page 14



13 Illuminated pushbutton actuator page 8 | **Illuminated pushbutton actuator, flush mounting** page 14



14 Illuminated pushbutton actuator page 8 | **Illuminated pushbutton actuator, flush mounting** page 14



15 Illuminated pushbutton actuator page 8 | **Illuminated pushbutton actuator, flush mounting** page 14



16 Selector switch 3 positions page 12 | **Selector switch actuator 3 positions, flush mounting** page 20

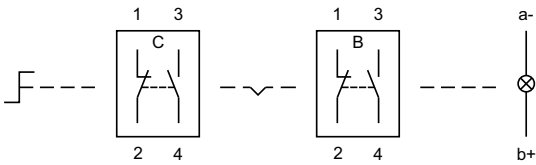

17 Selector switch 3 positions page 12 | **Selector switch actuator 3 positions, flush mounting** page 20



18 Selector switch 3 positions page 12 | **Selector switch actuator 3 positions, flush mounting** page 20

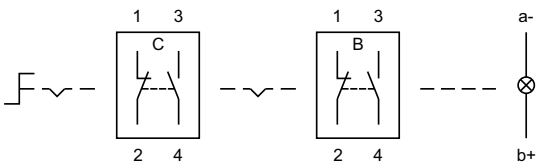

19 Selector switch 3 positions page 12 | **Selector switch actuator 3 positions, flush mounting** page 20



20 Selector switch 2 positions page 11 | Selector switch actuator 2 positions, flush mounting page 19



21 Selector switch 2 positions page 11 | Selector switch actuator 2 positions, flush mounting page 19



22 Selector switch 2 positions page 11



23 Selector switch 2 positions page 11



24 Selector switch 2 positions page 11 | Selector switch actuator 2 positions, flush mounting page 19

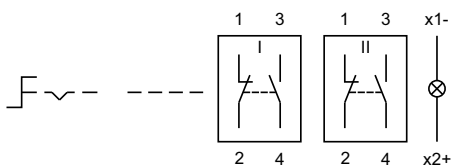

25 Selector switch 2 positions page 11 | Selector switch actuator 2 positions, flush mounting page 19



26 Selector switch 2 positions page 11



27 Selector switch 2 positions page 11

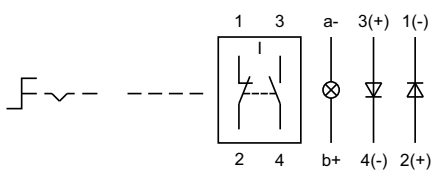

28 Selector switch 2 positions page 11 | Selector switch actuator 2 positions, flush mounting page 19



29 Selector switch 2 positions page 11 | Selector switch actuator 2 positions, flush mounting page 19



30 Selector switch 2 positions page 11 | Selector switch actuator 2 positions, flush mounting page 19



31 Selector switch 2 positions page 11 | Selector switch actuator 2 positions, flush mounting page 19



32 Selector switch 2 positions page 11 | Selector switch actuator 2 positions, flush mounting page 19

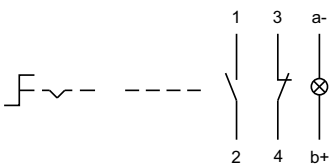

33 Selector switch 2 positions page 11 | Selector switch actuator 2 positions, flush mounting page 19

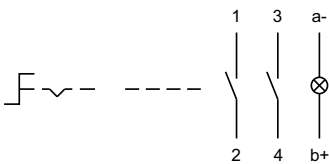

34 Selector switch 2 positions page 11 | Selector switch actuator 2 positions, flush mounting page 19

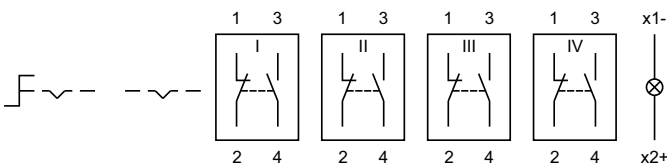

35 Selector switch 2 positions page 11 | Selector switch actuator 2 positions, flush mounting page 19

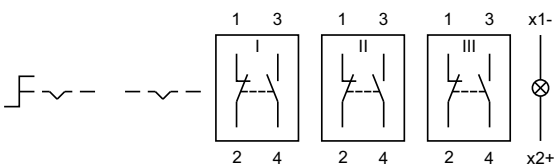

36 Selector switch 2 positions page 11



37 Selector switch 2 positions page 11



38 Selector switch 2 positions page 11 | Selector switch actuator 2 positions, flush mounting page 19



39 Selector switch 2 positions page 11 | Selector switch actuator 2 positions, flush mounting page 19



40 Selector switch 2 positions page 11

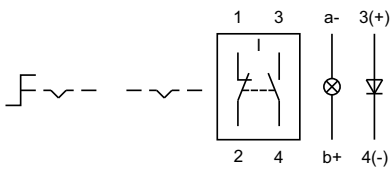

41 Selector switch 2 positions page 11

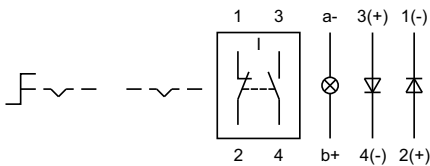

42 Selector switch 2 positions page 11 | Selector switch actuator 2 positions, flush mounting page 19

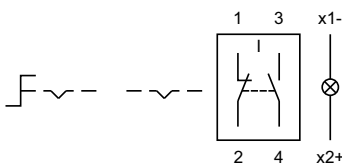

43 Selector switch 2 positions page 11 | Selector switch actuator 2 positions, flush mounting page 19



44 Selector switch 2 positions page 11 | Selector switch actuator 2 positions, flush mounting page 19



45 Selector switch 2 positions page 11 | Selector switch actuator 2 positions, flush mounting page 19



46 Selector switch 2 positions page 11 | Selector switch actuator 2 positions, flush mounting page 19



47 Selector switch 2 positions page 11 | Selector switch actuator 2 positions, flush mounting page 19

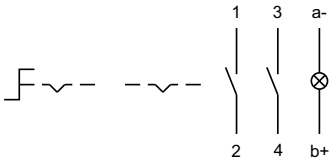

48 Illuminated pushbutton actuator page 8 | Illuminated pushbutton actuator, flush mounting page 14



49 Illuminated pushbutton actuator page 8 | Illuminated pushbutton actuator, flush mounting page 14



50 Illuminated pushbutton actuator page 8



51 Illuminated pushbutton actuator page 8



52 Illuminated pushbutton actuator page 8 | Illuminated pushbutton actuator, flush mounting page 14

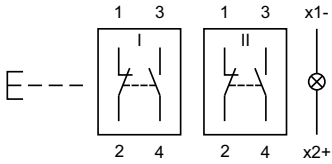

53 Illuminated pushbutton actuator page 8 | Illuminated pushbutton actuator, flush mounting page 14

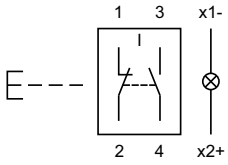

54 Illuminated pushbutton actuator page 8

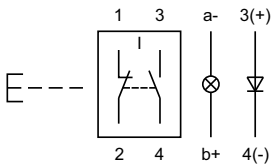

55 Illuminated pushbutton actuator page 8

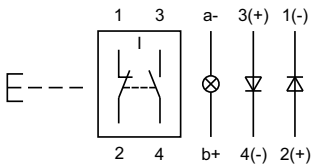

56 Illuminated pushbutton actuator page 8 | Illuminated pushbutton actuator, flush mounting page 14

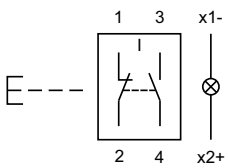

57 Illuminated pushbutton actuator page 8 | Illuminated pushbutton actuator, flush mounting page 14

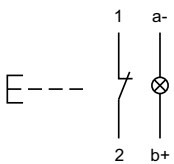

58 Illuminated pushbutton actuator page 8 | Illuminated pushbutton actuator, flush mounting page 14

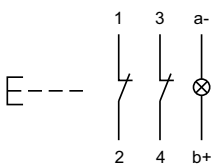

59 Illuminated pushbutton actuator page 8 | Illuminated pushbutton actuator, flush mounting page 14

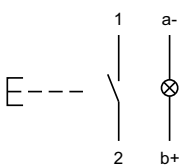

60 Illuminated pushbutton actuator page 8 | Illuminated pushbutton actuator, flush mounting page 14

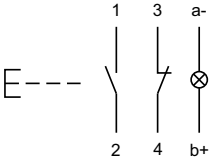

61 Illuminated pushbutton actuator page 8 | Illuminated pushbutton actuator, flush mounting page 14

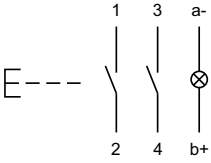

62 Keylock switch 3 positions page 10 | Keylock switch actuator 3 positions, flush mounting page 18

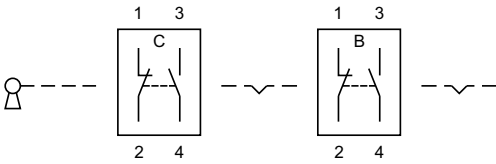

63 Keylock switch 3 positions page 10 | Keylock switch actuator 3 positions, flush mounting page 18



64 Keylock switch 3 positions page 10 | Keylock switch actuator 3 positions, flush mounting page 18



65 Keylock switch 3 positions page 10 | Keylock switch actuator 3 positions, flush mounting page 18



66 Keylock switch 2 positions page 9 | Keylock switch actuator 2 positions, flush mounting page 15

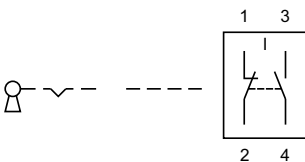

67 Keylock switch 2 positions page 9 | Keylock switch actuator 2 positions, flush mounting page 15



68 Keylock switch 2 positions page 9 | Keylock switch actuator 2 positions, flush mounting page 15



69 Keylock switch 2 positions page 9 | Keylock switch actuator 2 positions, flush mounting page 15

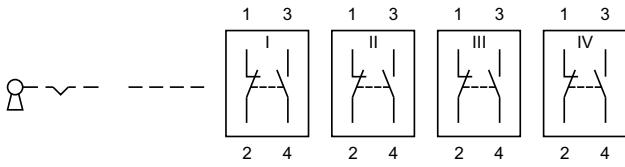

70 Keylock switch 2 positions page 9 | Keylock switch actuator 2 positions, flush mounting page 15

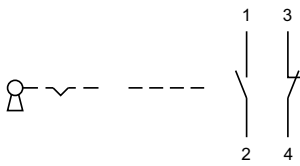

71 Keylock switch 2 positions page 9 | Keylock switch actuator 2 positions, flush mounting page 15

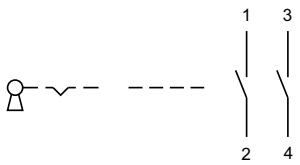

72 Keylock switch 2 positions page 9 | Keylock switch actuator 2 positions, flush mounting page 15

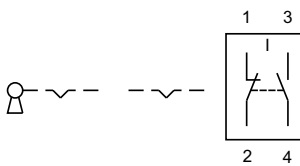

73 Keylock switch 2 positions page 9 | Keylock switch actuator 2 positions, flush mounting page 15

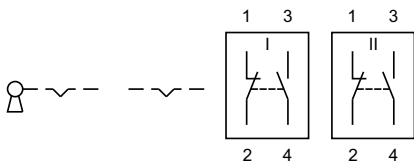

74 Keylock switch 2 positions page 9 | Keylock switch actuator 2 positions, flush mounting page 15



75 Keylock switch 2 positions page 9 | Keylock switch actuator 2 positions, flush mounting page 15



76 Keylock switch 2 positions page 9 | Keylock switch actuator 2 positions, flush mounting page 15



77 Keylock switch 2 positions page 9 | Keylock switch actuator 2 positions, flush mounting page 15



78 Indicator actuator page 7



79 Indicator actuator page 7



Index from Typ-Nr.

Typ-Nr.	Page	Typ-Nr.	Page	Typ-Nr.	Page
01-907	31	51-040.002	7	51-156.025D2	9
01-928	29	51-040.005	7	51-156.025D2F	15
01-929	29	51-041.006	7	51-157.025D2	9
02-904.0	30	51-050.002	7	51-157.025D2F	15
02-904.1	30	51-050.002F	13	51-158.025D2	9
02-904.3	30	51-050.005	7	51-158.025D2F	15
02-904.7	30	51-050.005F	13	51-195.022D	9
02-905	31	51-051.006	7	51-195.022DF	16
02-912.1	30	51-051.006F	13	51-195.025D2	9
02-912.2	30	51-121.022	8	51-195.025D2F	16
02-912.3	30	51-121.0252	8	51-196.025D2	9
02-912.4	30	51-122.0252	8	51-196.025D2F	16
10-1306.1349	29	51-123.0252	8	51-197.025D2	9
10-1307.1369	29	51-124.0252	8	51-197.025D2F	16
10-1309.1309	29	51-131.022	8	51-198.025D2	9
10-1310.1319	29	51-131.0252	8	51-198.025D2F	16
10-1311.1249	29	51-132.0252	8	51-235.022D	9
10-1312.1229	29	51-133.0252	8	51-235.022DF	16
10-1313.1209	29	51-134.0252	8	51-235.025D2	9
10-1313.1249	29	51-135.022D	9	51-235.025D2F	16
10-1316.1179	29	51-135.022DF	16	51-236.025D2	9
10-1316.1209	29	51-135.025D2	9	51-236.025D2F	16
10-1319.1179	29	51-135.025D2F	16	51-237.025D2	9
10-1319.1199	29	51-136.025D2	9	51-237.025D2F	16
10-2J06.3142	30	51-136.025D2F	16	51-238.025D2	9
10-2J06.3144	30	51-137.025D2	9	51-238.025D2F	16
10-2J06.3145	30	51-137.025D2F	16	51-255.022D	9
10-2J06.3146	30	51-138.025D2	9	51-255.022DF	15
10-2J06.3149	30	51-138.025D2F	16	51-255.025D2	9
10-2J09.1062	30	51-141.022D	9	51-255.025D2F	15
10-2J09.1064	30	51-141.022DF	17	51-256.025D2	9
10-2J09.1065	30	51-141.025D2	9	51-256.025D2F	15
10-2J09.1066	30	51-141.025D2F	17	51-257.025D2	9
10-2J09.1069	30	51-142.025D2	9	51-257.025D2F	15
10-2J12.1062	30	51-142.025D2F	17	51-258.025D2	9
10-2J12.1064	30	51-143.025D2	9	51-258.025D2F	15
10-2J12.1065	30	51-143.025D2F	17	51-261.022	8
10-2J12.1066	30	51-144.025D2	9	51-261.0252	8
10-2J12.1069	30	51-144.025D2F	17	51-262.0252	8
10-2J13.1062	30	51-145.022D	9	51-263.0252	8
10-2J13.1064	30	51-145.022DF	15	51-264.0252	8
10-2J13.1065	30	51-145.025D2	9	51-271.022	8
10-2J13.1066	30	51-145.025D2F	15	51-271.0252	8
10-2J13.1069	30	51-146.025D2	9	51-272.0252	8
10-2J19.1042	30	51-146.025D2F	15	51-273.0252	8
10-2J19.1044	30	51-147.025D2	9	51-274.0252	8
10-2J19.1045	30	51-147.025D2F	15	51-281.022	8
10-2J19.1046	30	51-148.025D2	9	51-281.022F	14
10-2J19.1049	30	51-148.025D2F	15	51-281.0252	8
31-928	29	51-151.022	8	51-281.0252F	14
31-929	29	51-151.022F	14	51-282.0252	8
31-940	28	51-151.0252	8	51-282.0252F	14
31-941	28	51-151.0252F	14	51-283.0252	8
31-942	28	51-152.0252	8	51-283.0252F	14
31-945	29	51-152.0252F	14	51-284.0252	8
31-946	29	51-153.0252	8	51-284.0252F	14
31-985.0	28	51-153.0252F	14	51-295.022D	9
31-989.300	28	51-154.0252	8	51-295.022DF	16
31-989.311	28	51-154.0252F	14	51-295.025D2	9
31-991	31	51-155.022D	9	51-295.025D2F	16
51-030.002	7	51-155.022DF	15	51-296.025D2	9
51-030.005	7	51-155.025D2	9	51-296.025D2F	16
51-031.006	7	51-155.025D2F	15	51-297.025D2	9

Index from Typ-Nr.

Typ-Nr.	Page	Typ-Nr.	Page	Typ-Nr.	Page
51-297.025D2F	16	51-385.022D	10	51-442.036DF	15
51-298.025D2	9	51-385.022DF	18	51-444.036D	9
51-298.025D2F	16	51-386.022D	10	51-444.036DF	15
51-335.022D	9	51-386.022DF	18	51-445.036D	9
51-335.022DF	16	51-387.022D	10	51-445.036DF	15
51-335.025D2	9	51-387.022DF	18	51-447.036D	9
51-335.025D2F	16	51-388.022D	10	51-447.036DF	15
51-336.025D2	9	51-388.022DF	18	51-448.036D	9
51-336.025D2F	16	51-395.022D	9	51-448.036DF	15
51-337.025D2	9	51-395.022DF	16	51-451.036	8
51-337.025D2F	16	51-395.025D2	9	51-451.036F	14
51-338.025D2	9	51-395.025D2F	16	51-452.036	8
51-338.025D2F	16	51-396.025D2	9	51-452.036F	14
51-355.022D	9	51-396.025D2F	16	51-453.036	8
51-355.022DF	15	51-397.025D2	9	51-453.036F	14
51-355.025D2	9	51-397.025D2F	16	51-455.036	8
51-355.025D2F	15	51-398.025D2	9	51-455.036F	14
51-356.025D2	9	51-398.025D2F	16	51-456.036	8
51-356.025D2F	15	51-401.036D	9	51-456.036F	14
51-357.025D2	9	51-401.036DF	16	51-457.036D	9
51-357.025D2F	15	51-402.036D	9	51-457.036DF	15
51-358.025D2	9	51-402.036DF	16	51-458.036D	9
51-358.025D2F	15	51-404.036D	9	51-458.036DF	15
51-361.022D	10	51-404.036DF	16	51-461.036	8
51-361.022DF	18	51-405.036D	9	51-462.036	8
51-362.022D	10	51-405.036DF	16	51-463.036	8
51-362.022DF	18	51-407.036D	9	51-465.036	8
51-363.022D	10	51-407.036DF	16	51-466.036	8
51-363.022DF	18	51-408.036D	9	51-471.036	8
51-364.022D	10	51-408.036DF	16	51-472.036	8
51-364.022DF	18	51-411.036D	9	51-473.036	8
51-365.022D	10	51-411.036DF	16	51-475.036	8
51-365.022DF	18	51-412.036D	9	51-476.036	8
51-366.022D	10	51-412.036DF	16	51-481.036	8
51-366.022DF	18	51-414.036D	9	51-481.036F	14
51-367.022D	10	51-414.036DF	16	51-482.036	8
51-367.022DF	18	51-415.036D	9	51-482.036F	14
51-368.022D	10	51-415.036DF	16	51-483.036	8
51-368.022DF	18	51-417.036D	9	51-483.036F	14
51-371.022D	10	51-417.036DF	16	51-485.036	8
51-371.022DF	18	51-418.036D	9	51-485.036F	14
51-372.022D	10	51-418.036DF	16	51-486.036	8
51-372.022DF	18	51-421.036	8	51-486.036F	14
51-373.022D	10	51-422.036	8	51-495.022D	9
51-373.022DF	18	51-423.036	8	51-495.022DF	16
51-374.022D	10	51-425.036	8	51-495.025D2	9
51-374.022DF	18	51-426.036	8	51-495.025D2F	16
51-375.022D	10	51-427.036D	9	51-496.025D2	9
51-375.022DF	18	51-427.036DF	16	51-496.025D2F	16
51-376.022D	10	51-428.036D	9	51-497.025D2	9
51-376.022DF	18	51-428.036DF	16	51-497.025D2F	16
51-377.022D	10	51-431.036	8	51-498.025D2	9
51-377.022DF	18	51-432.036	8	51-498.025D2F	16
51-378.022D	10	51-433.036	8	51-701.006	7
51-378.022DF	18	51-435.036	8	51-702.006	7
51-381.022D	10	51-436.036	8	51-703.006	7
51-381.022DF	18	51-437.036D	9	51-704.006	7
51-382.022D	10	51-437.036DF	17	51-705.0292	8
51-382.022DF	18	51-438.036D	9	51-706.0292	8
51-383.022D	10	51-438.036DF	17	51-707.0292	8
51-383.022DF	18	51-441.036D	9	51-708.0292	8
51-384.022D	10	51-441.036DF	15	51-709.0292	8
51-384.022DF	18	51-442.036D	9	51-710.0292	8

Index from Typ-Nr.

Typ-Nr.	Page	Typ-Nr.	Page	Typ-Nr.	Page
51-711.0292	8	51-933.4	21	52-432.036	19
51-712.0292	8	51-933.5	21	52-433.036	11
51-713.0292	8	51-933.6	21	52-433.036	19
51-714.0292	8	51-933.7	21	52-435.036	11
51-715.0292	8	51-935.2	21	52-435.036	19
51-716.0292	8	51-935.4	21	52-436.036	11
51-717.0292	8	51-935.5	21	52-436.036	19
51-718.0292	8	51-935.7	21	52-471.036	11
51-719.0292	8	51-938	31	52-471.036	19
51-720.0292	8	51-943.0	28	52-472.036	11
51-741.006	7	51-943.1	29	52-472.036	19
51-742.006	7	51-943.9	32	52-473.036	11
51-743.0292	8	51-947.0	27	52-473.036	19
51-744.0292	8	51-948.0	27	52-475.036	11
51-745.0292	8	51-949.0	27	52-475.036	19
51-746.0292	8	51-951.0	21	52-476.036	11
51-747.0292	8	51-951.2	21	52-476.036	19
51-748.0292	8	51-951.3	21	52-571.022A	12
51-749.0292	8	51-951.4	21	52-571.022A	20
51-750.0292	8	51-951.5	21	52-572.022A	12
51-901.0	21	51-951.6	21	52-572.022A	20
51-901.2	21	51-951.8	21	52-573.022A	12
51-901.3	21	51-951.9	21	52-573.022A	20
51-901.4	21	51-953.1	21	52-574.022A	12
51-901.5	21	51-953.2	21	52-574.022A	20
51-901.6	21	51-953.3	21	52-743.0292	11
51-901.8	21	51-953.4	21	52-744.0292	11
51-901.9	21	51-953.5	21	52-745.0292	11
51-903.1	21	51-953.6	21	52-746.0292	11
51-903.2	21	51-953.7	21	52-747.0292	11
51-903.3	21	51-954.2	21	52-748.0292	11
51-903.4	21	51-954.3	21	52-749.0292	11
51-903.5	21	51-954.4	21	52-750.0292	11
51-903.6	21	51-954.5	21	52-928.0	24
51-903.7	21	51-954.6	21	52-928.20	24
51-904.2	21	51-954.7	21	52-928.30	24
51-904.3	21	51-955.2	21	52-928.40	24
51-904.4	21	51-955.4	21	52-928.50	24
51-904.5	21	51-955.5	21	52-928.60	24
51-904.6	21	51-955.7	21	52-929.20	24
51-904.7	21	52-131.022	11	52-929.30	24
51-905.2	21	52-131.022	19	52-929.40	24
51-905.4	21	52-131.0252	11	52-929.50	24
51-905.5	21	52-131.0252	19	52-929.60	24
51-905.7	21	52-132.0252	11	52-929.8	24
51-906.2	21	52-132.0252	19	52-929.9	24
51-906.4	21	52-133.0252	11	52-950.0	23
51-906.5	21	52-133.0252	19	52-952.0	23
51-906.7	21	52-134.0252	11	61-9028.0	24
51-910	31	52-134.0252	19	61-9028.20	24
51-920	27	52-271.022	11	61-9028.30	24
51-925	27	52-271.022	19	61-9028.40	24
51-931.0	21	52-271.0252	11	61-9028.50	24
51-931.2	21	52-271.0252	19	61-9028.60	24
51-931.3	21	52-272.0252	11	61-9028.9	24
51-931.4	21	52-272.0252	19	61-9029.20	24
51-931.5	21	52-273.0252	11	61-9029.30	24
51-931.6	21	52-273.0252	19	61-9029.40	24
51-931.8	21	52-274.0252	11	61-9029.50	24
51-931.9	21	52-274.0252	19	61-9029.60	24
51-933.1	21	52-431.036	11	61-9029.8	24
51-933.2	21	52-431.036	19	61-9029.9	24
51-933.3	21	52-432.036	11	61-9451.0	27

Index from Typ-Nr.

Typ-Nr.	Page	Typ-Nr.	Page	Typ-Nr.	Page
61-9452.0	27	61-9842.2	23		
61-9453.0	27	61-9842.4	23		
61-9593.0	23	61-9842.5	23		
61-9593.2	23	61-9842.6	23		
61-9593.4	23	61-9842.8	23		
61-9593.5	23	61-9921.0	27		
61-9642.1	21	61-9922.0	27		
61-9642.2	21	61-9924.0	27		
61-9642.3	21	61-9927.2	26		
61-9642.4	21	61-9930.0	25		
61-9642.5	21	61-9930.0	26		
61-9642.6	21	61-9930.4	25		
61-9642.7	21	61-9930.4	26		
61-9643.201	22	61-9931.0	25		
61-9643.202	22	61-9931.0	26		
61-9643.203	22	61-9931.4	25		
61-9643.301	22	61-9931.4	26		
61-9643.401	22	61-9932.0	26		
61-9643.501	22	61-9932.0	26		
61-9643.502	22	61-9932.1	26		
61-9643.503	22	61-9932.1	26		
61-9643.601	22	61-9932.10	26		
61-9643.602	22	61-9932.10	26		
61-9643.603	22	61-9932.2	26		
61-9643.701	22	61-9932.2	26		
61-9643.702	22	61-9932.4	26		
61-9643.703	22	61-9932.4	26		
61-9671.1	21	61-9932.5	26		
61-9671.2	21	61-9932.5	26		
61-9671.3	21	61-9932.6	26		
61-9671.4	21	61-9932.6	26		
61-9671.5	21	61-9933.0	25		
61-9671.6	21	61-9933.0	25		
61-9671.7	21	61-9933.1	25		
61-9681.1	21	61-9933.1	25		
61-9681.2	21	61-9933.10	25		
61-9681.3	21	61-9933.10	25		
61-9681.4	21	61-9933.2	25		
61-9681.5	21	61-9933.2	25		
61-9681.6	21	61-9933.4	25		
61-9681.7	21	61-9933.4	25		
61-9707.7	22	61-9933.5	25		
61-9730.0	31	61-9933.5	25		
61-9740.0	31	61-9933.6	25		
61-9771.0	21	61-9933.6	25		
61-9771.8	21	61-9934.8	25		
61-9771.9	21	61-9936.0	26		
61-9781.0	21	61-9980.0	24		
61-9781.8	21	704.968.0	25		
61-9781.9	21	704.968.1	25		
61-9841.0	23	84-9103.7	26		
61-9841.0A	22				
61-9841.2	23				
61-9841.2A	22				
61-9841.4	23				
61-9841.4A	22				
61-9841.5	23				
61-9841.5A	22				
61-9841.6	23				
61-9841.6A	22				
61-9841.8	23				
61-9841.8A	22				
61-9842.0	23				

	EAO AG
	Tannwaldstrasse 88 4601 Olten, Switzerland
E-mail	info@eao.com
Website	www.eao.com
	Austria
Phone	+49 201 85 87 0
Fax	+49 201 85 87 210
E-mail	sales.ede@eao.com
	Belgium
Phone	+32 3 777 82 36
Fax	+32 3 777 84 19
E-mail	sales.ebl@eao.com
	China
Phone	+852 27 86 91 41
Fax	+852 27 86 95 61
E-mail	sales.ehk@eao.com
	France
Phone	+33 1 64 43 37 37
Fax	+33 1 64 43 37 49
E-mail	sales.esa@eao.com
	Germany
Phone	+49 201 85 87 0
Fax	+49 201 85 87 210
E-mail	sales.ede@eao.com
	Italy
Phone	+39 035 481 0189
Fax	+39 035 481 3786
E-mail	sales.eit@eao.com
	Japan
Phone	+81 3 5444 5411
Fax	+81 3 5444 0345
E-mail	sales.esj@eao.com
	Netherlands
Phone	+31 78 653 17 00
Fax	+31 78 653 17 99
E-mail	sales.enl@eao.com
	Sweden
Phone	+46 8 683 86 60
Fax	+46 8 724 29 12
E-mail	sales.esw@eao.com
	Switzerland
Phone	+41 62 388 95 00
Fax	+41 62 388 95 55
E-mail	sales.ech@eao.com
	United Kingdom
Phone	+44 1444 236 000
Fax	+44 1444 236 641
E-mail	sales.euk@eao.com
	USA
Phone	+1 203 877 4577
Fax	+1 203 877 3694
E-mail	sales.eus@eao.com
	Other Countries
Phone	+41 62 286 92 10
Fax	+41 62 296 21 62
E-mail	info@eao.com

Компания «Океан Электроники» предлагает заключение долгосрочных отношений при поставках импортных электронных компонентов на взаимовыгодных условиях!

Наши преимущества:

- Поставка оригинальных импортных электронных компонентов напрямую с производств Америки, Европы и Азии, а так же с крупнейших складов мира;
- Широкая линейка поставок активных и пассивных импортных электронных компонентов (более 30 млн. наименований);
- Поставка сложных, дефицитных, либо снятых с производства позиций;
- Оперативные сроки поставки под заказ (от 5 рабочих дней);
- Экспресс доставка в любую точку России;
- Помощь Конструкторского Отдела и консультации квалифицированных инженеров;
- Техническая поддержка проекта, помощь в подборе аналогов, поставка прототипов;
- Поставка электронных компонентов под контролем ВП;
- Система менеджмента качества сертифицирована по Международному стандарту ISO 9001;
- При необходимости вся продукция военного и аэрокосмического назначения проходит испытания и сертификацию в лаборатории (по согласованию с заказчиком);
- Поставка специализированных компонентов военного и аэрокосмического уровня качества (Xilinx, Altera, Analog Devices, Intersil, Interpoint, Microsemi, Actel, Aeroflex, Peregrine, VPT, Syfer, Eurofarad, Texas Instruments, MS Kennedy, Miteq, Cobham, E2V, MA-COM, Hittite, Mini-Circuits, General Dynamics и др.);

Компания «Океан Электроники» является официальным дистрибьютором и эксклюзивным представителем в России одного из крупнейших производителей разъемов военного и аэрокосмического назначения «JONHON», а так же официальным дистрибьютором и эксклюзивным представителем в России производителя высокотехнологичных и надежных решений для передачи СВЧ сигналов «FORSTAR».



JONHON

«JONHON» (основан в 1970 г.)

Разъемы специального, военного и аэрокосмического назначения:

(Применяются в военной, авиационной, аэрокосмической, морской, железнодорожной, горно- и нефтедобывающей отраслях промышленности)

«FORSTAR» (основан в 1998 г.)

ВЧ соединители, коаксиальные кабели, кабельные сборки и микроволновые компоненты:

(Применяются в телекоммуникациях гражданского и специального назначения, в средствах связи, РЛС, а так же военной, авиационной и аэрокосмической отраслях промышленности).



Телефон: 8 (812) 309-75-97 (многоканальный)

Факс: 8 (812) 320-03-32

Электронная почта: ocean@oceanchips.ru

Web: <http://oceanchips.ru/>

Адрес: 198099, г. Санкт-Петербург, ул. Калинина, д. 2, корп. 4, лит. А