

Amphenol® Fiber Optic Interconnect Products for Military, Aerospace and Harsh Environments

12-352-4

- High Speed
- Reliable
- Secure
- Robust



Amphenol



**MIL-PRF-29504
Size 16 Fiber
Optic Termini**



**High Density
Insert with
Size 20 Fiber
Optic Termini**



**D38999 with
MT Ferrule
Fiber Optic
Termini**



**ARINC 801
Fiber Optic
Connector and Termini**



**Hybrid with
Fiber Optic
Termini and
High Speed Coax
Contacts**

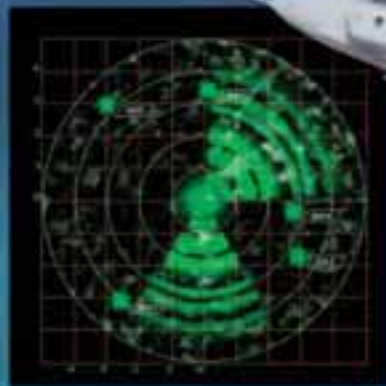

*Amphenol fiber optic
termini and connectors
provide reliable transfer of
data signals for communi-
cation systems in many
applications:*

- *military aircraft and ground vehicles*
- *commercial aircraft*
- *radar, missiles and battlefield equipment*
- *medical and test equipment*



Fiber Optics for Multi-Channel Cylindrical Connectors. Fiber Optics for High Density Rectangular Connectors.



MIL-PRF-29504 Fiber Optic Termini can be accommodated in any size 16 or 20 contact cavity of MIL-DTL-38999 Series III connector.



Amphenol® D38999 Connectors with MT Optical Ferrules

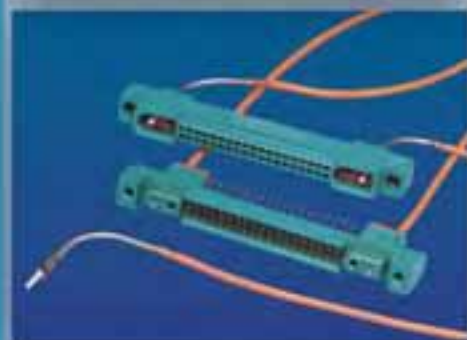

Hybrid Low Mating Force Brush Contact Rectangular Connectors with Fiber Optics



Hybrid LRM Interconnects with Brush Contacts and MIL-PRF-29504 Fiber Optic Termini



LRM (Line Replaceable Modules) with MT Fiber Optic Ferrules

The emergence of highly reliable fiber optic transmission systems that provide high speed and secure communication has led to the development of precision fiber optic multi-channel termination and interconnect systems for harsh environments.

Amphenol Corporation, well known for high quality, reliable interconnection products for the military-aerospace market, has a wide offering of fiber optic products to meet today's needs.

Amphenol Aerospace fiber optic products offer low insertion loss characteristics, with high reliability and repeatability. Included in the Amphenol Aerospace offering of fiber optic products are:

- High performance, well-established MIL-DTL-38999 Series III cylindrical connector with fiber optic termini.
- ARINC 801 fiber optic interconnect series, meeting commercial aerospace and military market needs.
- Fiber optic bulkhead feed-through cylindrical connectors.
- Low Mating Force Brush PCB rectangular connectors - combining brush and fiber optics.
- LRM surface mount rectangular connectors used in advanced avionics - combining brush and fiber optics.
- Fiber optics in VME64 and VITA-46 rectangular interconnect products.
- Fiber optics in rack and panel interconnects: ARINC 600 & 404, R27 and R58 Series.
- Fiber optic cable assemblies - a variety of cable configurations. Amphenol will help design a complete system, including polishing, assembly and testing.

Amphenol Aerospace operates Quality Systems that are certified to ISO9001:2000 by third party Registrars.

Amphenol Interconnect Capabilities and Design Flexibility

For over 50 years, Amphenol Aerospace has been in the forefront of interconnect design and manufacturing for aerospace and harsh environment applications. From the Spirit of St. Louis to the International Space Station, Amphenol connectors continue to lead the industry in reliability, quality, and innovation.



The manufacturing center for fiber optic components and cable systems is located at the main plant of Amphenol Aerospace located in Sidney, New York. This location includes a diverse manufacturing capability including state of the art CNC machining, die-casting, molding, impact and extruding, screw machining, and plating.

Also within the Sidney facility are a complete design engineering facility and a complete environmental test laboratory capable of performing a wide variety of tests including vibration, mechanical shock, temperature, humidity, salt spray and altitude simulation

Of course, fiber optic interconnects is only part of the Amphenol story. With the largest interconnect offering in the market and a systems integration capability to match, Amphenol is the leading manufacturer of integrated systems solutions for the military and aerospace markets. We lead the industry by offering the elements necessary for success in the military and aerospace OEM supply chain: design and modeling, applications engineering, fabrication, value-added assembly, and testing



ARINC 801 Cylindrical Connector Series



ARINC 600 Rack and Panel Connector with ARINC 801 Termini.



Comprehensive line of cable assemblies for fiber optic interconnects. Amphenol can design an "end-to-end" solution



Amphenol® Back-plane Systems with Fiber Optics. Shown: MT ferrules in the rack and MIL-PRF-29504 in the cylindrical connecto



VME P0/J0 Interconnects and Proposed VITA-46 Interconnects with MT Fiber Optics



Fiber Optic Bulkhead Feed-Through Connectors with size 16 pin termini on both ends.

Amphenol® Military Aerospace Fiber Optic Interconnects



Space Application Connectors with Fiber Optics

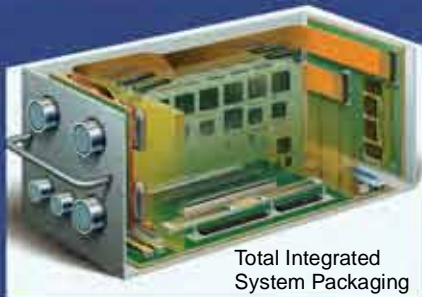

Total Integrated System Packaging



High technology production centers within Amphenol Aerospace create volume runs that are cost effective and meet on-time delivery demands.

Amphenol has earned the reputation as a leader in manufacturing fiber optic cylindrical connectors meeting stringent military requirements, as well as developing new and innovative fiber optic interconnect designs for rectangular and surface mount applications. Our vertically integrated design, manufacturing and test capabilities allow for fast response to developing applications and markets. Our fiber optic interconnect products have been employed in many well-known military platforms including:

- F16
- F22
- F35 (JSF)
- International Space Station
- Boeing 777
- Commercial and private aircraft

For more information on Amphenol Aerospace capabilities in fiber optics for harsh environments, or to speak with an applications engineer about a particular project using fiber optics, please contact us:

Amphenol Aerospace Operations
 40-60 Delaware Avenue
 Sidney, NY 13838-1395
 Ph: 800-678-0141 or 607-563-5011
www.amphenol-aerospace.com

Table of Contents

Amphenol® Military Aerospace Fiber Optic Products Introduction . . . 1, 2

FIBER OPTIC TERMINI

MIL-PRF-29504/4 & /5 Multi-mode termini, size 16	3
Multi-mode termini, HD20	4
MIL-PRF-29504/4 & /5 Single mode termini, size 16	5
90° Multi-mode termini, size 16	6
ARINC 801 termini, genderless, keyed termini	7
MT ferrule termini, male and female for high density	8

FIBER OPTIC MULTI-CHANNEL CYLINDRICAL CONNECTORS

MIL-DTL-38999 SERIES III, Tri-Start - the high performance connector choice for fiber optic technology; new tight tolerance styles	9
Fiber Optic 38999 Tri-Start shell styles	10-12
Fiber Optic 38999 Tri-Start insert availability chart	13
Fiber Optic 38999 Tri-start insert arrangements	14-16
Fiber Optic 38999 Tri-Start how to order	17
Fiber Optic 38999 Tri-Start with ARINC 801 inserts	18
Fiber Optic 38999 Tri-Start with MT ferrule inserts	19
Fiber Optic 38999 Tri-Start Bulk-head Feed-through connectors	20
Accessories for fiber optic cylindrical connectors	21
Application tools for fiber optic cylindrical connectors	22

FIBER OPTIC RECTANGULAR CONNECTORS

Rectangular PCB Connectors with size 16 fiber optic termini	23
LRM Connectors with size 16 fiber optic termini; LRM connector overview	24
LRM Connectors with MT ferrule termini	25
VMEP0/J0 Interconnects, Ruggedized VITA-46 Interconnects with MT and Backplane Systems with Fiber Optics	26
Rack and Panel Connectors - ARINC 600, R27 and R58 Series with ARINC 801 termini	27

FIBER OPTIC CABLE SYSTEMS

Custom cable design and fabrication for use with multi-channel fiber optic connectors	28, 29
---	--------

Additional Fiber Optic Products from Amphenol 30-32

Amphenol Sales Office Listing

Amphenol® Military Aerospace Fiber Optic Interconnects product introduction



Fiber Optics in MIL-DTL-38999 Series III Connectors

Amphenol Aerospace offers a wide range of fiber optic interconnect solutions for use in the harsh environments experienced in military and aerospace applications. Amphenol Aerospace has established the rugged and reliable MIL-DTL-38999 as a common connector shell platform that houses a wide variety of fiber optic termini including MIL-PRF-29504*, HD20, ARINC 801 and MT ferrules.

MIL-DTL-38999 Series III Tri-Start connectors are available in various insert arrangements, materials and finishes to meet any type of environmental requirement. Our MIL-PRF-29504 and HD20 termini can be combined with most of our copper contacts to create a large assortment of hybrid fiber/copper connector combinations.

Amphenol's newest offering of fiber optic products is the ARINC 801 series of connectors and termini. Adopted by the commercial air market, the ARINC 801 insert is incorporated into the D38999 Series III shell and is designed specifically for fiber optics.

Fiber Optics in Rectangular Interconnects

Amphenol Aerospace is uniquely qualified to design and manufacture a wide range of rectangular interconnect products containing MIL-PRF-29504, HD20 and MT fiber optic termini. Our rectangular interconnect products include a variety of applications including LRM surface mount and rack & panel styles - all available in hybrid fiber/copper configurations.

Amphenol's Fiber Optic Termini Product Offering

- **MIL-PRF-29504** - Pin and socket termini that feature high precision, pre-radiused ceramic ferrules to help improve insertion loss performance and reduce polishing time. Products are available in both single mode and multi-mode versions. The socket has a plastic protective shroud over the ceramic alignment sleeve that incorporates a built-in anti-rotation feature.
- **HD20 termini** - Pin and socket termini that have the same benefits of the MIL-PRF-29504 termini, but in a smaller, size 20 contact that allows for increased density in D38999 connector shells.
- **90° termini** - Pin and socket 90° multi-mode termini in size 16 are available. Consult Amphenol Aerospace for availability of 90° size 20 termini.
- **ARINC 801 termini** - Genderless fiber optic termini that use a precision 1.25 mm ceramic ferrule. Precision inserts with guide pins and keyed termini maximize multi-mode and single mode performance. ARINC 801 termini facilitate an angled polish which is advantageous for lower return loss.
- **MT ferrules** - Industry-standard, very high density plastic ferrules available in either 12-fiber or 24-fiber versions, in multi-mode PC, single mode PC, and single mode APC configurations.

* MIL-PRF-29504 supersedes MIL-T-29504. (MIL-T-29504 is still available; consult Amphenol Aerospace for more information.)

MIL-PRF-29504/4 & /5 Multi-mode termini size 16, pin and socket

Amphenol® Multi-mode, Size 16 Termini Features:

- Precision ceramic ferrules which precisely position the fiber within the termini.
- Precision ceramic alignment sleeves insure accurate fiber to fiber alignment.
- Socket has threaded protective shroud with anti-rotation key, manufactured from rugged PEEK™ material, provides protection for the ceramic alignment sleeve.
- Stainless steel termini bodies and springs.
- Laser welded components for stronger construction.
- Allows for multiple fiber accommodations



Multi-mode Size 16 Fiber Optic Termini
 Designed for use in the size 16 contact cavities of Multi-channel MIL-DTL-38999 Series III Connectors and Amphenol CF-52 & CF-50 Fiber Optic Connectors

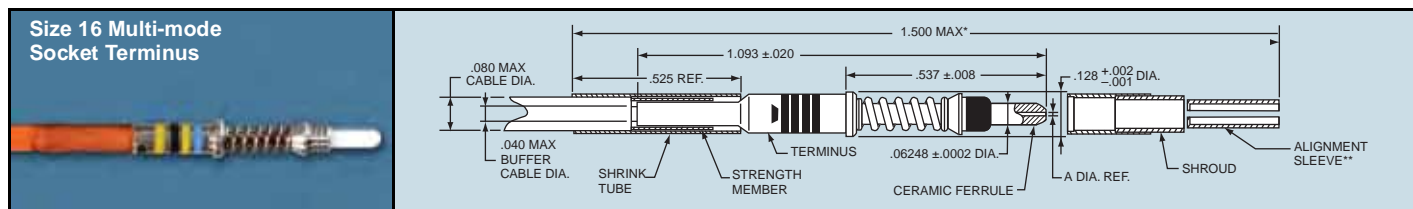
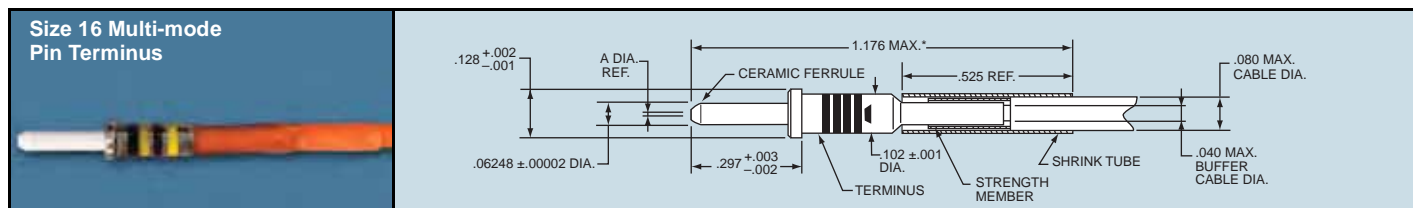

Amphenol® Multi-Channel fiber optic connectors are supplied less termini. Order multi-mode termini by Amphenol part number designation or MIL-PRF-29504 designation as shown in the charts below. Consult Amphenol, Sidney, NY for further availability.

* Indicated dimension when fully assembled.
 ** Alignment sleeve shipped unassembled.
 All dimensions for reference only.

Fiber Optic Pins Ordering Information

Amphenol Part Number	Fiber Size† Core/Cladding	A Dia. Ref. (Microns)	Ferrule Hole Tolerance	Reference Only M29504/4-XXXX
CF-198142-009	50/125 & 62.5/125	126	+2,-0	M29504/4-4210*
CF-198036-010	50/125 & 62.5/125	127	+2,-0	superseded by MIL-PRF
CF-198142-010	50/125 & 62.5/125	127	+2,-0	M29504/4-4040*
CF-198036-017	100/140	145	+3,-0	superseded by MIL-PRF
CF-198142-017	100/140	145	+3,-0	M29504/4-4044*
CF-198036-29A	100/140/172 (Polyimide)	173	+1,-0	superseded by MIL-PRF
CF-198142-29A	100/140/172 (Polyimide)	173	+1,-0	M29504/4-4293*
CF-198036-053	200/230	236	+4,-0	superseded by MIL-PRF
CF-198142-053	200/230	236	+4,-0	M29504/4-4214*

Fiber Optic Sockets Ordering Information

Amphenol Part Number	Fiber Size† Core/Cladding	A Dia. Ref. (Microns)	Ferrule Hole Tolerance	Reference Only M29504/5-XXXX
CF-198143-009	50/125 & 62.5/125	126	+2,-0	M29504/5-4239*
CF-198035-010	50/125 & 62.5/125	127	+2,-0	superseded by MIL-PRF
CF-198143-010	50/125 & 62.5/125	127	+2,-0	M29504/5-4046*
CF-198035-017	100/140	145	+3,-0	superseded by MIL-PRF
CF-198143-017	100/140	145	+3,-0	M29504/5-4050*
CF-198035-29A	100/140/172 (Polyimide)	173	+1,-0	superseded by MIL-PRF
CF-198143-29A	100/140/172 (Polyimide)	173	+1,-0	M29504/5-4296*
CF-198035-053	200/230	236	+4,-0	superseded by MIL-PRF
CF-198143-053	200/230	236	+4,-0	M29504/5-4243*

* Consult Amphenol Aerospace, Sidney NY for qualification status.
 † Additional fiber optic termini sizes available upon request; consult Amphenol Aerospace for availability.

Multi-mode termini, HD20 size 20 pin and socket

Amphenol® Multi-mode, Size 20 Termini Features:

- Designed for use in size 20 cavities of MIL-DTL-38999 Series III connectors
- 1mm precision ceramic ferrules
- Offers increased termini density in Amphenol MIL-DTL-38999 connectors
- Designed with similar high performance components as the proven size 16 termini
- Maintains fiber optic/electrical hybrid capabilities
- Allows for multiple fiber accommodations
- Termination accomplished using the industry proven epoxy/polish method. Can be polished Air Gap (AG) or Physical contact (PC).



Multi-mode Size 20 Fiber Optic Termini
Designed for use in the size 20 contact cavities of Multi-channel MIL-DTL-38999 Series III Connectors and Amphenol CF-52 & CF-50 Fiber Optic Connectors

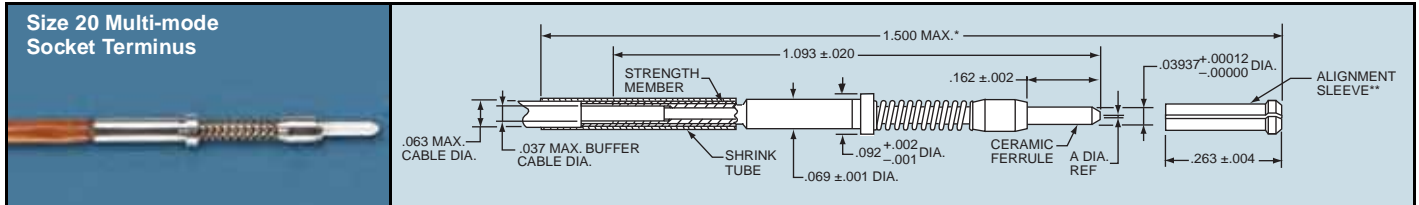
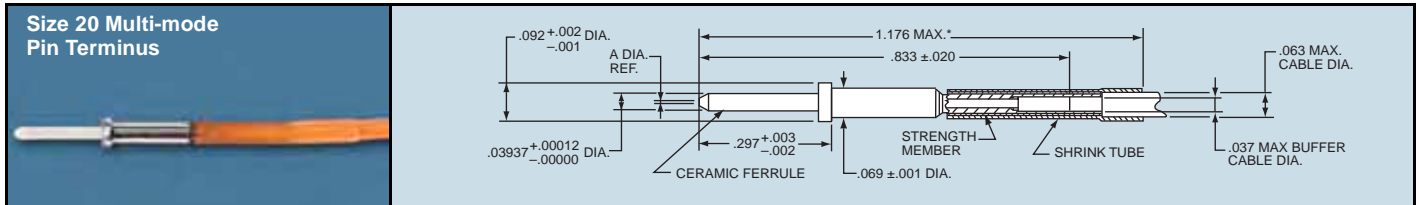

Amphenol® Multi-Channel fiber optic connectors are supplied less termini. Order multi-mode termini by Amphenol part number designation as shown in the chart below. Consult Amphenol, Sidney, NY for further availability.

* Indicated dimension when fully assembled.
** Alignment sleeve shipped unassembled.
All dimensions for reference only.

Ordering Information Multi-mode Termini (Size 20) for MIL-DTL-38999 Connectors

Fiber Size† Core/Cladding Dia (Microns)	Amphenol Part Numbers		A Dia. Ref. (Microns)	Ferrule Hole Tolerance
	Size 20 Socket	Size 20 Pin		
50/125	CF-198080-010	CF-198081-010	127	+3,-0
62.5/125				
100/140	CF-198080-017	CF-198081-017	145	+3,-0

† Additional sizes available upon request: consult Sidney, NY for availability.

MIL-PRF-29504 Type Single mode termini size 16, pin and socket

Amphenol® Single mode, Size 16 Termini Features:

- Designed for use in size 16 cavities of Amphenol MIL-DTL-38999 Series III connectors
- Designed with similar high performance components as the size 16 multi-mode termini
- Maintains fiber optic/electrical hybrid capabilities
- Allows for multiple fiber accommodations
- Termination accomplished using the industry proven epoxy/polish method providing Physical Contact (PC) for low return loss



Amphenol® Multi-Channel fiber optic connectors are supplied less termini. Order single mode size 16 termini by Amphenol part number designation as shown in the charts below. Consult Amphenol, Sidney, NY for further availability.

Single Mode Size 16 Fiber Optic Termini
 Designed for use in the size 16 contact cavities of Multi-channel MIL-DTL-38999 Series III Connectors and Amphenol CF-52 & CF-50 Fiber Optic Connectors

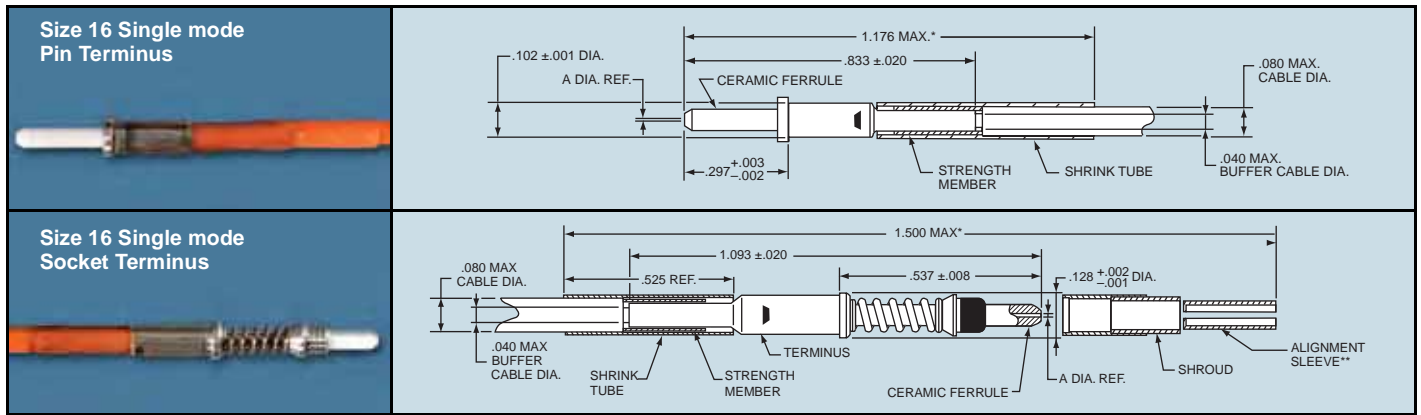

* Indicated dimension when fully assembled.
 ** Alignment sleeve shipped unassembled.
 All dimensions for reference only.

Fiber Optic Pins Ordering Information

Amphenol Part Number	Fiber Size† Core/Cladding	A Dia. Ref. (Microns)	Ferrule Hole Tolerance	Reference Only M29504/4-XXXX
CF-198096-008	9/125 (Single mode)	125	+1,-0	superseded by MIL-PRF
CF-198142-25A	9/125 (Single mode)	125.5	+1,-0	M29504/4-4208*
CF-198096-009	9/125 (Single mode)	126	+1,-0	superseded by MIL-PRF
CF-198142-126	9/125 (Single mode)	126	+1,-0	M29504/4-4209*

Fiber Optic Sockets Ordering Information

Amphenol Part Number	Fiber Size† Core/Cladding	A Dia. Ref. (Microns)	Ferrule Hole Tolerance	Reference Only M29504/5-XXXX
CF-198095-008	9/125 (Single mode)	125	+1,-0	superseded by MIL-PRF
CF-198143-25A	9/125 (Single mode)	125.5	+1,-0	M29504/4-4237*
CF-198095-009	9/125 (Single mode)	126	+1,-0	superseded by MIL-PRF
CF-198143-126	9/125 (Single mode)	126	+1,-0	M29504/5-4238*

* Consult Amphenol Aerospace, Sidney NY for qualification status.
 † Additional fiber optic termini sizes available upon request; consult Amphenol Aerospace for availability.

90° multi-mode termini size 16, pin and socket

Amphenol provides 90°, size 16 fiber optic termini that can be used with multi-channel cylindrical connectors. Consult Amphenol for the 90°, size 16 termini for use in LRM rectangular connectors. (See pages 24, 25 for more information on LRM connectors. Also consult Amphenol for availability of 90° size 20 termini.

90° Socket Termini (Size 16)

Ordering Information for 90° Multi-mode Socket Termini

Fiber Size† Core/Cladding Dia (Microns)	Socket, Size 16 Amphenol Part Number For use in Cylindrical Connectors	A Dia Ref	
		Inches	Microns
50/125	CF-198111-010	.0050	127
62.5/125			
100/140	CF-198111-017	.0057	145
100/140/172	CF-198111-29	OR	.0069
	CF-198111-29A		.0068

† Additional sizes available upon request: consult Amphenol, Sidney, NY for availability.
* Consult Amphenol, Sidney, NY for ordering information.
** Indicated dimension when fully assembled.
*** Shrink tubing and alignment sleeve are shipped unassembled.
For 90°, size 16 fiber optic termini for use in LRM rectangular connectors consult Amphenol, Sidney NY.
All dimensions for reference only.

90° Pin Termini (Size 16)

Ordering Information for 90° Multi-mode Pin Termini

Fiber Size† Core/Cladding Dia (Microns)	Pin, Size 16 Amphenol Part Number For use in Cylindrical Connectors	A Dia Ref		B Max (Inches)	C Ref (Inches)
		Inches	Microns		
50/125	CF-198110-010	.0050	127	1.121	1.100
62.5/125					
100/140	CF-198110-017	.0057	145	1.121	1.100
100/140/172	CF-198110-029	OR	.0069	1.121	1.100
	CF-198110-29A		.0068		
50/125	CF-198112-010	.0050	127	1.003	.900
62.5/125					
100/140	CF-198112-017	.0057	145	1.003	.900
100/140/172	CF-198112-029	OR	.0069	1.003	.900
	CF-198112-29A		.0068		

† Additional sizes available upon request: consult Amphenol, Sidney, NY for availability.
* Consult Amphenol, Sidney, NY for ordering information.
For 90°, size 16 fiber optic termini for use in LRM rectangular connectors consult Amphenol, Sidney NY.
All dimensions for reference only.

ARINC 801 termini genderless, keyed termini

Amphenol® ARINC 801 Termini Features:

- Designed for use in Amphenol® ARINC 801 fiber optic connectors - manufactured to comply with ARINC 801.
- Genderless terminus allows for use on both sides of a connector
- Alignment sleeves are contained in a separate carrier which is removable for easier end-face cleaning
- Precision ceramic ferrules and sleeves insure accurate fiber to fiber alignment
- Keyed to provide anti-rotation
- Available with both PC and APC end-face finishes
- Terminus body is crimped to the cable providing a "Pull-Proof" advantage



ARINC 801 Termini

Designed for use in ARINC 801 Fiber Optic Connectors

Amphenol® ARINC fiber optic connectors are supplied less contacts. Order ARINC 801 termini by Amphenol part number designation as shown in the chart at right. Consult Amphenol, Sidney, NY for further availability.

See page 18 for information on ARINC 801 termini in cylindrical 38999 connectors. See page 27 for information on ARINC 801 termini in rack and panel ARINC 600, R27 and R58 series connectors.

Ordering Information ARINC 801 Termini for ARINC 801 Connectors

Amphenol ARINC 801 Termini Part Number	A Dia. Ref	Ferrule Hole Tolerance
CF-198148-125	125	+1, -0
CF-198148-129	125.5	+1, -0
CF-198148-126	126	+1, -0
CF-198148-128	128	+2, -0
CF-198148-144	144	+4, -0
CF-198148-157	157	+7, -0
CF-198148-175	175	+7, -0
CF-198148-236	236	+7, -0
CF-198148-336	336	+7, -0
CF-198148-448	448	+7, -0

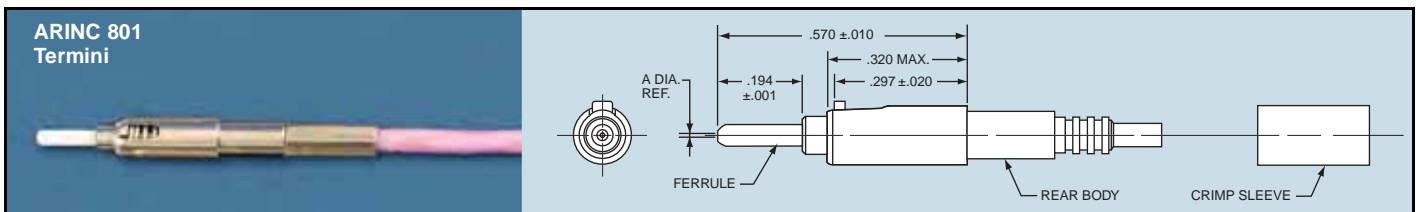

All dimensions for reference only.

MT ferrule termini

male and female ferrules, for higher density

Amphenol® MT (Multi-terminal) Features:

- Designed for use in Amphenol® MIL-DTL-38999 cylindrical connectors and also for rectangular products: printed circuit board interconnects, LRM, VME64 and VITA46 interconnects.
- Male and female ferrules available in either multi-mode or single mode designs.
- Fiber spacing is 0.25mm
- Very high density can be achieved in cylindrical connectors:
 - up to 24 fiber channels in a size 11 composite shell
 - up to 96 fiber channels in a size 21 composite shell
- Amphenol supplies MT termini assemblies in kits, minus the MT ferrule. MT ferrules that meet the IEC1754-5 specification are recommended for use.
- Assembly tool 11-100000-000 is available to aid in MT termini assembly into connectors; MT contact removal tool CF-008025-000 is also available.

See page 19 for information on MT fiber optic ferrules in D38999 cylindrical connectors.



MT Ferrule Fiber Optic Termini
Designed for use in
Multi-channel MIL-DTL-38999 Series III Connectors

Ordering Information for MT Assembly Kits and Tools

MT Male Assembly Kit**	CF-198136-000
MT Female Assembly**	CF-198137-000
MT Kit Assembly Tool	11-100000-000
MT Contact Removal Tool	CF-008025-000

** MT ferrules are not included in the assembly kits

MT Assembly Tool (11-100000-000)

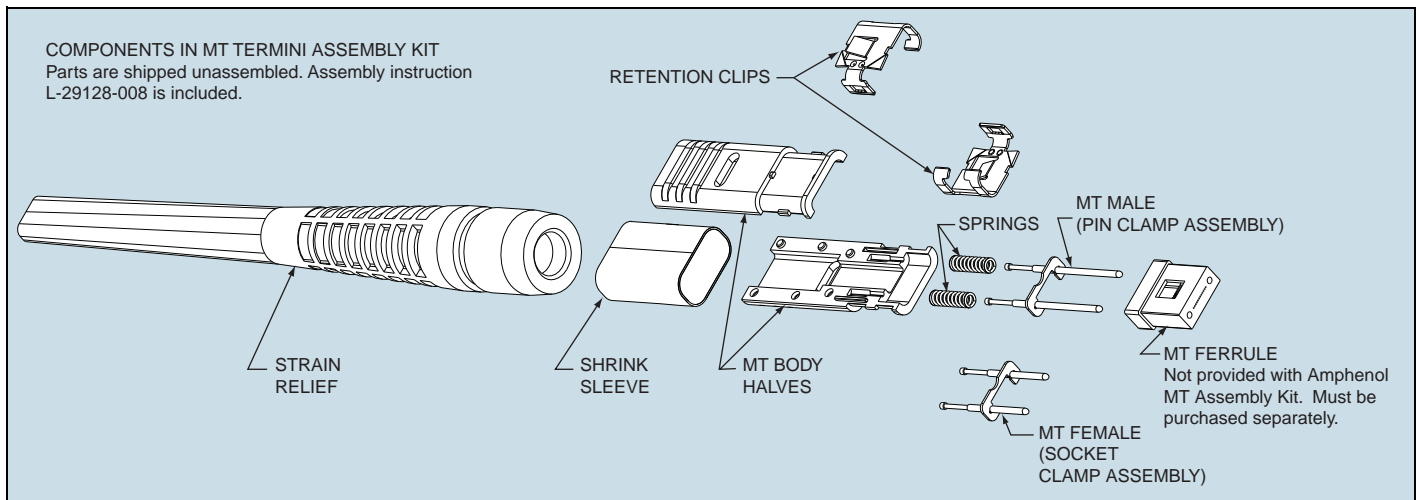
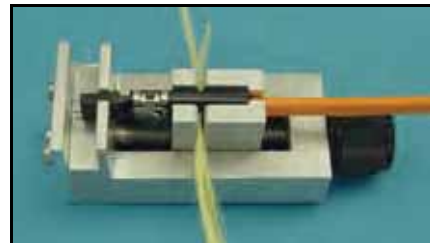

For information on MT fiber optics in Amphenol rectangular interconnects see pages 25 and 26.

Multi-Channel Cylindrical Connectors with Fiber Optics

MIL-DTL-38999 Series III, Tight Tolerance styles

Amphenol introduced the MIL-C-38999 Series III connector in the mid-1970's.

Amphenol has continued since the 70's to improve performance and reliability that makes this design of the 38999 Series III the connector of choice by system designers worldwide.

During the mid-1980's the 38999 Series III connector was selected as the platform to use for the new MIL-T-29504 size 16 fiber optic termini.

Amphenol® Tri-Start, Series III - the Highest Performance MIL-DTL-38999 Connector The Ideal Choice for Fiber Optic Technology

- Meets or exceeds MIL-DTL-38999 Series III requirements
- EMI Shielding - solid metal to metal coupling, grounding fingers, electroless nickel plating, and thicker wall sections provide superior EMI shielding capability of 65dB min. at 10 GHz
- Termini Protection - recessed pins in this 100% scoop-proof connector minimize potential termini damage
- Corrosion Resistance - shells of stainless steel or cadmium over nickel plating withstand 500 hr. salt spray exposure
- Vibration/Shock - operates under severe high temperature vibration, through 200°C
- Threaded coupling quickly and completely mates in one 360° turn of the coupling nut

Amphenol® Composite Tri-Start, Qualified to MIL-DTL-38999, Rev. J

Same high performance features as metal Tri-Start connectors, but also includes the following features:

- Lightweight - 17% – 70% weight savings
- Increased Corrosion Resistance - olive drab cadmium (175°C) and electroless nickel plating (200°C both withstand 2000 hours of salt spray exposure.
- Durability - 1500 couplings minimum (in reference to connector couplings, not termini)

Design improvement for fiber optics to metal clip retention system.

The introduction of MIL-T-29504 termini into a connector not designed for spring-loaded termini yielded the first improvement of the basic 38999 for use with fiber optics. In 1987, Amphenol introduced the CF-52 series connector with a beryllium-copper retention clip for improved termini stability inside the connector insert.

Design improvements for fiber optics to tighter tolerances and integrated wave washers.

Through the 1990's Amphenol has continued to modify the design of the 38999 to improve the performance of the connector when using fiber optic termini. The CF-50 series connector employs a modified master key and precision tooling to precisely align the insert cavities during connector mating. The CF-50 also integrates a wave washer in the coupling mechanism to reduce the possibility of connectors de-mating during periods of high vibration.

The illustration shows the key features of the MIL-DTL-38999 CF-50 - The highest optical performance connector.

1. Beryllium-copper retention clip for improved termini stability.
2. Precision-aligned inserts
3. Modified master key
4. Integrated wave washer for improved performance in high vibration environments.

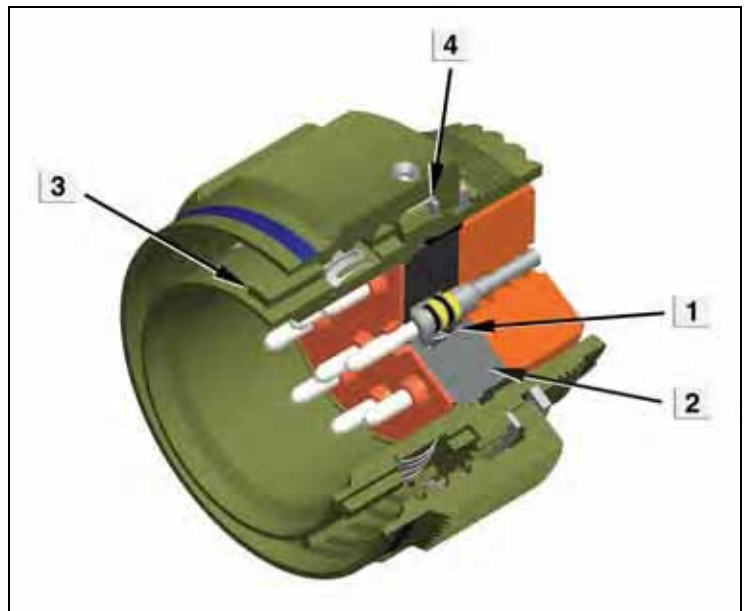

Multi-Channel Fiber Optic Cylindrical Connectors Tri-Start (MIL-DTL-38999, III) type shell styles

TRI-START™ METAL AND COMPOSITE CONNECTORS

Wall Mount Receptacle with Fiber Optics shell style 0

For complete part number, see how to order, page 17.

† Red Band indicates fully mated
 †† Blue band indicates rear release contact retention system

Designates true position dimensioning

All dimensions for reference only

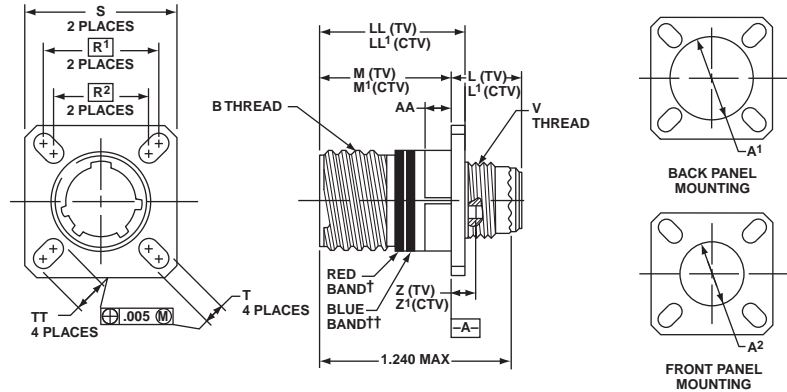

Shell Size	MS Shell Size Code	B Thread Class 2A 0.1P-0.3L-TS (Plated)	L Max. (TV)	L ¹ Max. (CTV)	M +.000 - .005 (TV)	M ¹ +.000 - .005 (CTV)	<input type="checkbox"/> R ¹	<input type="checkbox"/> R ²	S Max.	T +.008	V Thread Metric	Z Max. (TV)	Z ¹ Max. (CTV)	A ¹ Dia. Back Panel Mount	A ² Dia. Front Panel Mount	AA Max. Panel Thickness	LL +.006 - .000 (TV)	LL ¹ ±.005 (CTV)	TT ±.008
9	A	.6250	.469	.514	.820	.773	.719	.594	.948	.128	M12X1-6g	.153	.198	.650	.510	.234	.905	.908	.216
11	B	.7500	.469	.514	.820	.773	.812	.719	1.043	.128	M15X1-6g	.153	.198	.800	.620	.234	.905	.908	.194
13	C	.8750	.469	.514	.820	.773	.906	.812	1.137	.128	M18X1-6g	.153	.198	.910	.740	.234	.905	.908	.194
15	D	1.0000	.469	.514	.820	.773	.969	.906	1.232	.128	M22X1-6g	.153	.198	1.040	.900	.234	.905	.908	.173
17	E	1.1875	.469	.514	.820	.773	1.062	.969	1.323	.128	M25X1-6g	.153	.198	1.210	1.010	.234	.905	.908	.194
19	F	1.2500	.469	.514	.820	.773	1.156	1.062	1.449	.128	M28X1-6g	.153	.198	1.280	1.130	.234	.905	.908	.194
21	G	1.3750	.500	.545	.790	.741	1.250	1.156	1.575	.128	M31X1-6g	.183	.228	1.410	1.250	.204	.905	.904	.194
23	H	1.5000	.500	.545	.790	.741	1.375	1.250	1.701	.154	M34X1-6g	.183	.228	1.530	1.360	.204	.905	.904	.242
25	J	1.6250	.500	.545	.790	.741	1.500	1.375	1.823	.154	M37X1-6g	.183	.228	1.660	1.470	.204	.905	.904	.242

Box Mount Receptacle with Fiber Optics shell style 2

For complete part number, see how to order, page 17.
 Consult Amphenol Aerospace for availability of composite box mount receptacles.

† Red Band indicates fully mated
 †† Blue band indicates rear release contact retention system

Designates true position dimensioning

All dimensions for reference only

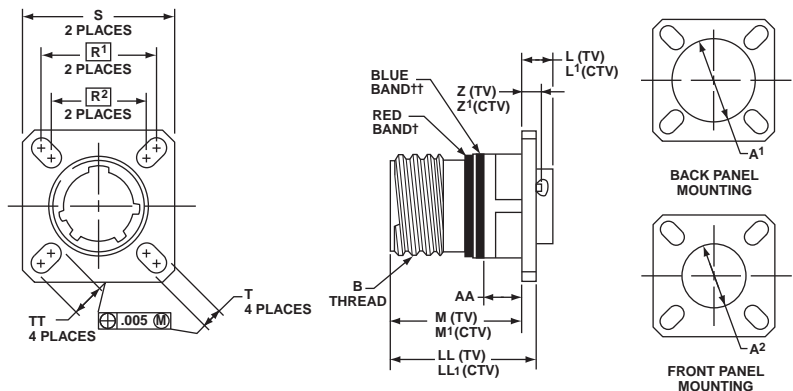

Shell Size	MS Shell Size Code	B Thread Class 2A 0.1P-0.3L-TS (Plated)	L Max. (TV)	L ¹ Max. (CTV)	M +.000 - .005 (TV)	M ¹ +.000 - .005 (CTV)	<input type="checkbox"/> R ¹	<input type="checkbox"/> R ²	S Max.	T +.008	Z Max. (TV)	Z ¹ Max. (CTV)	A ¹ Dia. Back Panel Mount	A ² Dia. Front Panel Mount	AA Max. Panel Thickness	LL +.006 - .000 (TV)	LL ¹ ±.005 (CTV)	TT ±.008
9	A	.6250	.205	.250	.820	.773	.719	.594	.948	.128	.153	.198	.650	.510	.234	.905	.908	.216
11	B	.7500	.205	.250	.820	.773	.812	.719	1.043	.128	.153	.198	.800	.620	.234	.905	.908	.194
13	C	.8750	.205	.250	.820	.773	.906	.812	1.137	.128	.153	.198	.910	.740	.234	.905	.908	.194
15	D	1.0000	.205	.250	.820	.773	.969	.906	1.232	.128	.153	.198	1.040	.900	.234	.905	.908	.173
17	E	1.1875	.205	.250	.820	.773	1.062	.969	1.323	.128	.153	.198	1.210	1.010	.234	.905	.908	.194
19	F	1.2500	.205	.250	.820	.773	1.156	1.062	1.449	.128	.153	.198	1.280	1.130	.234	.905	.908	.194
21	G	1.3750	.235	.280	.790	.741	1.250	1.156	1.575	.128	.183	.228	1.410	1.250	.204	.905	.904	.194
23	H	1.5000	.235	.280	.790	.741	1.375	1.250	1.701	.154	.183	.228	1.530	1.360	.204	.905	.904	.242
25	J	1.6250	.235	.280	.790	.741	1.500	1.375	1.823	.154	.183	.228	1.660	1.470	.204	.905	.904	.242

Multi-Channel Fiber Optic Cylindrical Connectors Tri-Start (MIL-DTL-38999, III) type shell styles, cont.

TRI-START™ METAL AND COMPOSITE CONNECTORS

Jam Nut Receptacle with Fiber Optics shell style 7

For complete part number, see how to order, page 17.

† Red Band indicates fully mated
 †† Blue band indicates rear release contact retention system

★ .059 dia. min. 3 lockwire holes
 Formed lockwire hole design (6 holes) is optional
 All dimensions for reference only

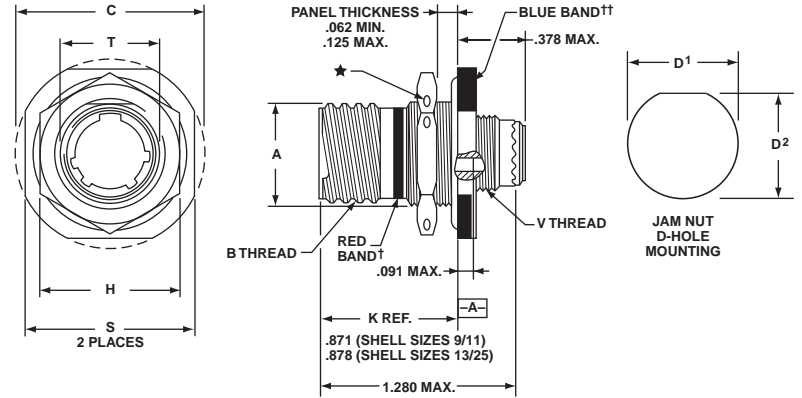

Shell Size	MS Shell Size Code	A* +.000 -.010	B Thread Class 2A 0.1P-0.3L-TS (Plated)	C Max.	D ¹ +.010 -.000	D ² +.000 -.010	HHex +.017 -.016	S ±.010	T +.010 -.000	V Thread Metric
9	A	.669	.6250	1.199	.700	.670	.875	1.062	.697	M12X1-6g
11	B	.769	.7500	1.386	.825	.770	1.000	1.250	.822	M15X1-6g
13	C	.955	.8750	1.511	1.010	.955	1.188	1.375	1.007	M18X1-6g
15	D	1.084	1.0000	1.636	1.135	1.085	1.312	1.500	1.134	M22X1-6g
17	E	1.208	1.1875	1.761	1.260	1.210	1.438	1.625	1.259	M25X1-6g
19	F	1.333	1.2500	1.949	1.385	1.335	1.562	1.812	1.384	M28X1-6g
21	G	1.459	1.3750	2.073	1.510	1.460	1.688	1.938	1.507	M31X1-6g
23	H	1.575	1.5000	2.199	1.635	1.585	1.812	2.062	1.634	M34X1-6g
25	J	1.709	1.6250	2.323	1.760	1.710	2.000	2.188	1.759	M37X1-6g

Line Receptacle with Fiber Optics shell style 1

For complete part number, see how to order, page 17.

† Red Band indicates fully mated
 †† Blue band indicates rear release contact retention system
 All dimensions for reference only

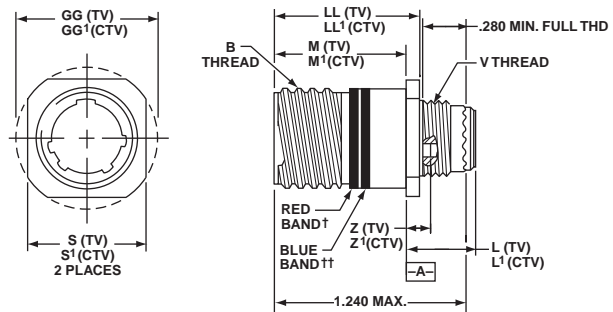

Shell Size	MS Shell Size Code	B Thread 0.1P-0.3L-TS-2A (Plated)	L Max. (TV)	L ¹ Max. (CTV)	M +.000 -.005 (TV)	M ¹ +.000 -.005 (CTV)	S ±.010 (TV)	S ¹ ±.010 (CTV)	V Thread Metric	Z Max. (TV)	Z ¹ Max. (CTV)	GG Dia. ±.010 (TV)	GG ¹ Dia. ±.010 (CTV)	LL +.006 -.000 (TV)	LL ¹ ±.005 (CTV)
9	A	.6250	.469	.514	.820	.773	.675	.635	M12X1-6g	.153	.198	.812	.699	.905	.908
11	B	.7500	.469	.514	.820	.773	.800	.765	M15X1-6g	.153	.198	.905	.875	.905	.908
13	C	.8750	.469	.514	.820	.773	.925	.885	M18X1-6g	.153	.198	1.093	1.007	.905	.908
15	D	1.0000	.469	.514	.820	.773	1.050	1.100	M22X1-6g	.153	.198	1.219	1.140	.905	.908
17	E	1.1875	.469	.514	.820	.773	1.238	1.197	M25X1-6g	.153	.198	1.375	1.229	.905	.908
19	F	1.2500	.469	.514	.820	.773	1.300	1.260	M28X1-6g	.153	.198	1.469	1.380	.905	.908
21	G	1.3750	.500	.545	.790	.741	1.425	1.385	M31X1-6g	.183	.228	1.625	1.493	.905	.904
23	H	1.5000	.500	.545	.790	.741	1.550	1.510	M34X1-6g	.183	.228	1.750	1.626	.905	.904
25	J	1.6250	.500	.545	.790	.741	1.675	1.635	M37X1-6g	.183	.228	1.875	1.777	.905	.904

Multi-Channel Fiber Optic Cylindrical Connectors Tri-Start (MIL-DTL-38999, III) type shell styles, cont.

TRI-START™ METAL AND COMPOSITE CONNECTORS

Straight Plug with Fiber Optics shell style 6

For complete part number, see how to order, page 17.

METAL

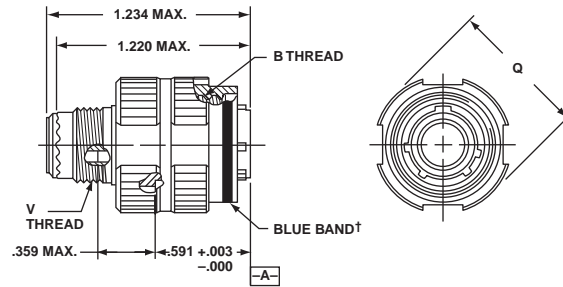

COMPOSITE

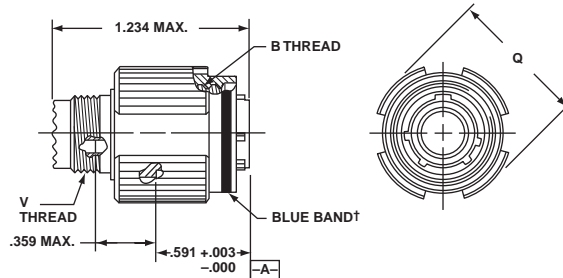

† Blue band indicates rear release contact retention system

Straight Plug

Shell Size	MS Shell Size Code	B Thread 0.1P-0.3L-TS-2B (Plated)	Q Dia. Max.	V Thread Metric
9	A	.6250	.858	M12X1-6g
11	B	.7500	.984	M15X1-6g
13	C	.8750	1.157	M18X1-6g
15	D	1.0000	1.280	M22X1-6g
17	E	1.1875	1.406	M25X1-6g
19	F	1.2500	1.516	M28X1-6g
21	G	1.3750	1.642	M31X1-6g
23	H	1.5000	1.768	M34X1-6g
25	J	1.6250	1.890	M37X1-6g

Multi-Channel Fiber Optic Cylindrical Connectors Tri-Start (MIL-DTL-38999, III) type insert availability

Fiber optic termini can be accommodated in any size 16 or size 20 contact cavity of MIL-DTL-38999 Series III type connector insert patterns, as listed in the following chart. For availability of fiber type, either multi-mode or single mode, see note at bottom of chart.

Shell Size/ Arrangement	Total Contacts	Contact Size							
		22D	Optic Termini Availability*		12	12 (Coax)	10 (Power)	8 (Coax)	8 (Twinax) ◆
			20	16					
9-94	2		2						
9-98	3		3						
11-2	2			2					
11-5	5		5						
11-98	6		6						
11-99	7		7						
13-4	4			4					
13-8	8		8						
13-13	4			2**	2				
13-98	10		10						
15-5	5		5						
15-15	15		14	1					
15-18	18		18						
15-19	19		19						
15-97	12		8	4					
17-8	8			8					
17-26	26		26						
17-99	23		21	2					
19-11	11			11					
19-28	28		26	2					
19-32	32		32						
21-16	16			16					
21-29	27		19	4	4				
21-39	39		37	2					
21-41	41		41						
23-21	21			21					
23-53	53		53						
23-54	53	40		9	4				
23-55	55		55						
25-4	56		48	8					
25-11***	11		2			9			
25-20***	30		10	13		4		3	
25-24	24			12	12				
25-26	25		16		5		4		
25-29	29			29					
25-37	37			37					
25-41	41	22	3	11		2		3	
25-43	43		23	20					
25-46	46		40	4			2†		
25-61	61		61						
25-90	46		40	4				2	
25-F4	66	49		13	4				

* Size 16 multi-mode and single mode fiber optic termini are readily available. For size 20 multi-mode termini consult Amphenol Aerospace for availability.

** Two size 16 contacts dedicated to fiber optics.

*** For use in MIL-STD-1760 applications. See Tri-Start Catalog, 12-092

† For RG180/U and RG195/U cables only. Contact Amphenol for other cable applications.

◆ Size 8 coax and Twinax are interchangeable.

For service ratings and performance of electrical contacts see Tri-Start Catalog, 12-092.

Multi-Channel Fiber Optic Cylindrical Connectors Tri-Start (MIL-DTL-38999, III) insert arrangements

front face of pin inserts illustrated

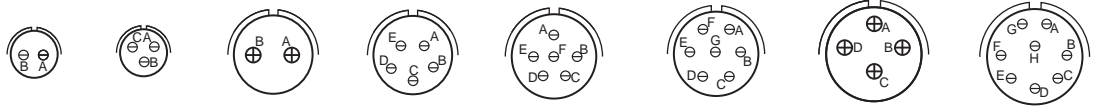

Insert Arrangement	9-94	9-98	11-2	11-5	11-98	11-99	13-4	13-8
Number of Contacts	2	3	2	5	6	7	4	8
Contact Size	20	20	16	20	20	20	16	20

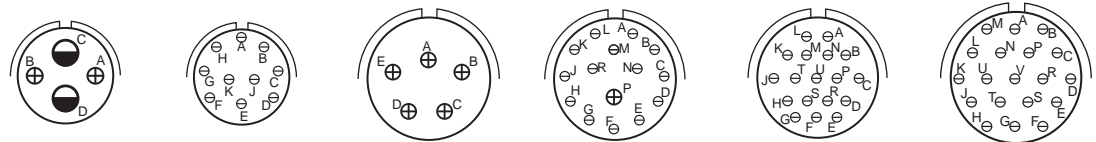

Insert Arrangement	13-13	13-98	15-5	15-15	15-18	15-19
Number of Contacts	2 2	10	5	14 1	18	19
Contact Size	16 12	20	16	20 16	20	20

Dedicated to Fiber Optics

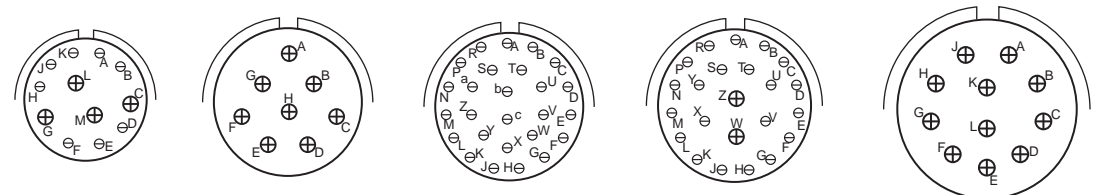

Insert Arrangement	15-97	17-8	17-26	17-99	19-11
Number of Contacts	8 4	8	26	21 2	11
Contact Size	20 16	16	20	20 16	16

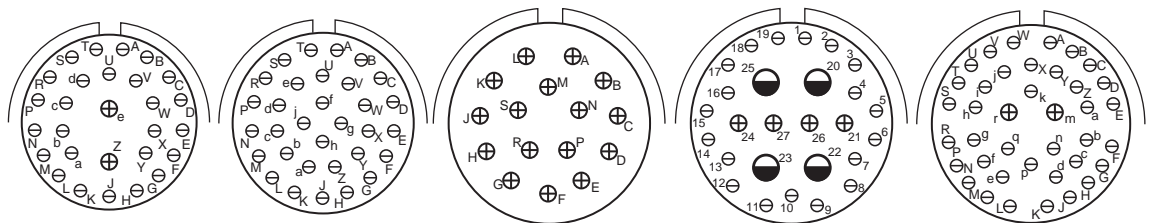

Insert Arrangement	19-28	19-32	21-16	21-29	21-39
Number of Contacts	26 2	32	16	19 4 4	37 2
Contact Size	20 16	20	16	20 16 12	20 16

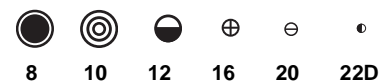

Multi-Channel Fiber Optic Cylindrical Connectors Tri-Start (MIL-DTL-38999, III) insert arrangements

front face of pin inserts illustrated

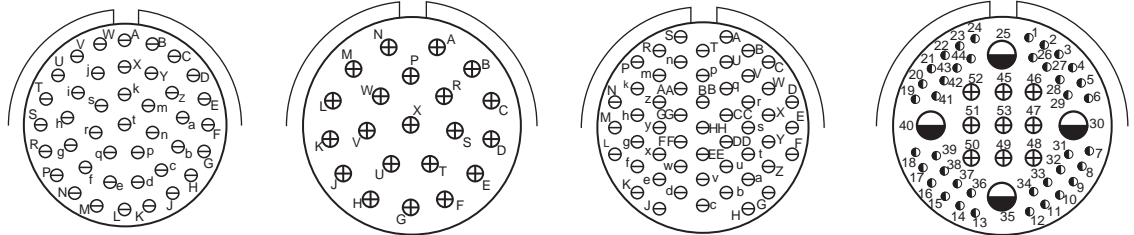

Insert Arrangement	21-41	23-21	23-53	23-54		
Number of Contacts	41	21	53	40	9	4
Contact Size	20	16	20	22D	16	12

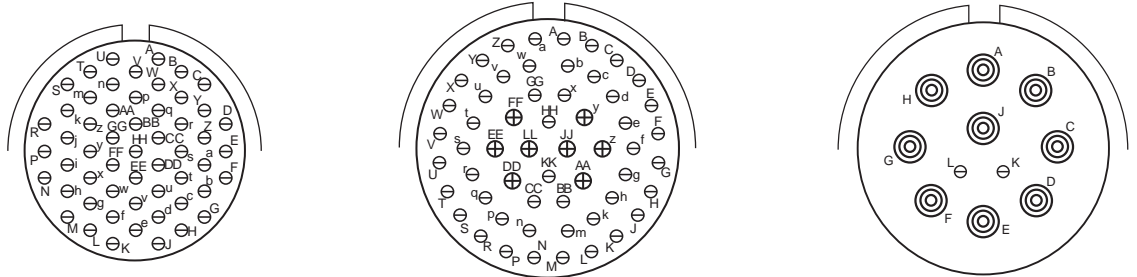

Insert Arrangement	23-55	25-4		25-11***	
Number of Contacts	55	48	8	2	9
Contact Size	20	20	16	20	10 Power

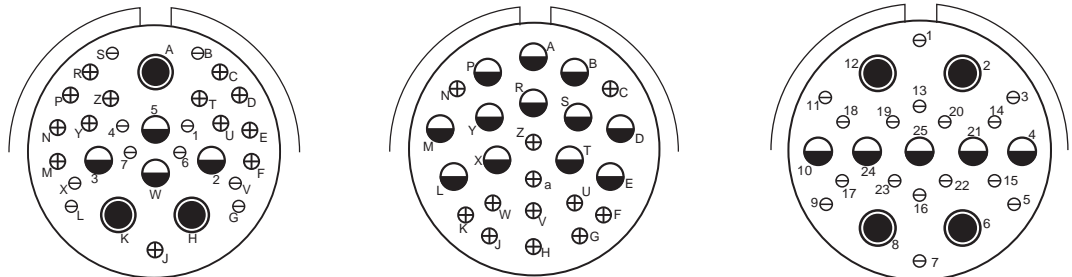

Insert Arrangement	25-20***				25-24		25-26		
Number of Contacts	10	13	3	4	12	12	16	5	4
Contact Size	20	16	8 Twinax	12 Coax†	16	12	20	12	8 Coax

*** For use in MIL-STD-1760 applications. See Tri-Start Catalog, 12-092.
 † 12 Coax Contacts can be Matched Impedance or Power



Multi-Channel Fiber Optic Cylindrical Connectors Tri-Start (MIL-DTL-38999, III) insert arrangements

front face of pin inserts illustrated

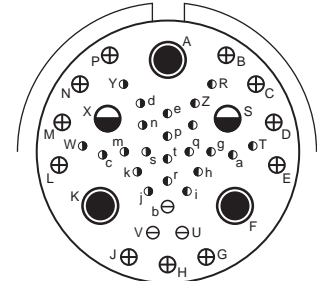
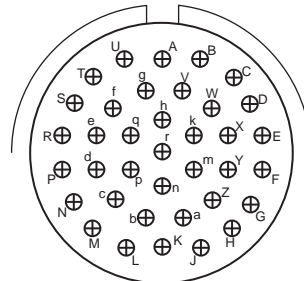
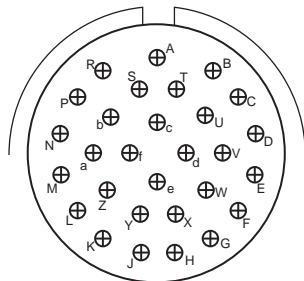

Insert Arrangement	25-29	25-37	25-41				
Number of Contacts	29	37	22	3	11	2	3
Contact Size	16	16	22D	20	16	12 Coax	8 Twinax

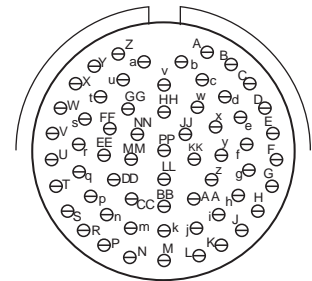
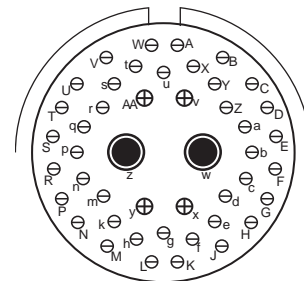
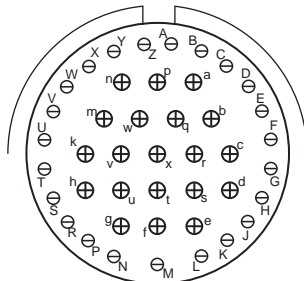

Insert Arrangement	25-43		25-46			25-61
Number of Contacts	23	20	40	4	2	61
Contact Size	20	16	20	16	8 Coax†	20

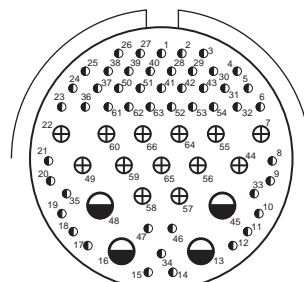
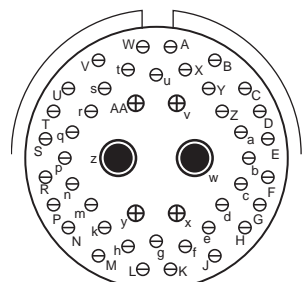

Insert Arrangement	25-90			25-F4		
Number of Contacts	40	4	2	49	13	4
Contact Size	20	16	8 Twinax	22D	16	12

† Coax contacts for RG180 or RG195 cable.



Multi-Channel Fiber Optic Cylindrical Connectors Tri-Start (MIL-DTL-38999, III) type

how to order

Amphenol® Multi-Channel fiber optic connectors for use with multi-mode and single mode termini can be ordered by coded part number. Ordering procedure is illustrated by part number CF-509017-8P as shown below:

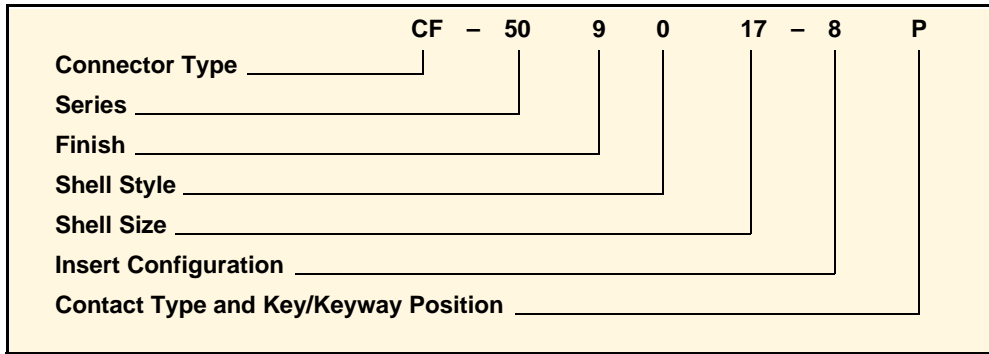

Connector Type

CF designates Multi-Channel Fiber Optic Connector
 DF designates Multi-Channel Fiber Optic Connector supplied per D38999 with sealing plugs and insertion/removal tools

Series

50 designates aluminum shell, tight tolerance
 52 designates aluminum shell
 60 designates composite shell, tight tolerance
 62 designates composite shell
 80 designates stainless steel shell, tight tolerance
 82 designates stainless steel shell

Finish

4 designates electroless nickel plated aluminum, 48 hour salt spray resistance, 200°C
 5 designates unplated composite
 6 designates corrosion resistant stainless steel, 500 hour salt spray resistance, 200°C
 9 designates corrosion resistant olive drab cadmium plate aluminum, 500 hour salt spray resistance, 175°C
 D designates Durmalon™ (Nickel-PTFE)
 Durmalon is a trademark of Amphenol. For more information on Durmalon, go to www.amphenol-aerospace.com/durmalon.asp
 S designates nickel plated stainless steel, 500 hour salt spray resistance, 200°C

Shell Style

0 designates wall mount receptacle
 1 designates line receptacle
 2 designates box mount receptacle
 6 designates straight plug
 7 designates jam nut receptacle

Shell Size

See Insert Availability (preceding pages)

Insert Configuration

See Insert Availability (preceding pages)

Contact Type and Key/Keyway Position

P designates pin contacts
 S designates socket contacts
 For key/keyway positioning, choose the alternate rotation suffix letter from the chart below.

ALTERNATE POSITION SUFFIX

Alternate Position	Suffix Letter	
	Pins	Sockets
Normal	P	S
A	G	H
B	I	J
C	K	L
D	M	N
E	R	T

For more information on key/keyway rotation, see Amphenol Tri-Start Cylindrical catalog, 12-092.

Multi-Channel Fiber Optic Cylindrical Connectors Tri-Start (MIL-DTL-38999, III) with ARINC 801 inserts

Amphenol now offers a multi-channel cylindrical connector that complies with the ARINC specification. This connector, available in straight plug and wall mount receptacle, uses the ARINC 801 ceramic termini described on page 7.

The features of the ARINC 801 connector include:

- Uses precision ARINC 801 fiber optic termini (typical multi-mode insertion loss is less than 0.15 dB).
- Removable alignment sleeve insert for easy cleaning of fiber optic termini.
- Three stages of alignment: shell-to-shell keys, guide pins and ceramic alignment sleeves.
- Includes all of the features of standard D38999 straight plug and wall mount receptacle shells (refer to page 10 for shell dimensions).
 - Scoop-proof design
 - Option for alternate keys and keyways
 - Rear accessory threads
 - Standard insertion/extraction tools (M81969/14-03)



ARINC 801 Inserts within Tri-Start Connectors

front face of pin inserts illustrated



11-02

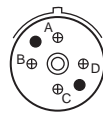

13-04

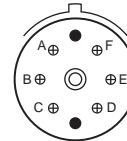

15-06

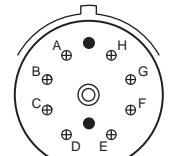

17-08

ARINC Insert Arrangement

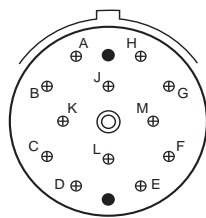

19-12

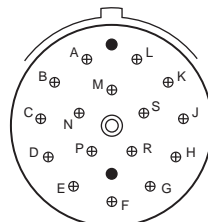

21-16

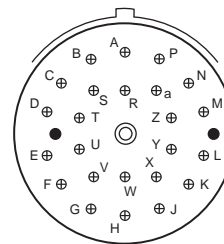

23-24

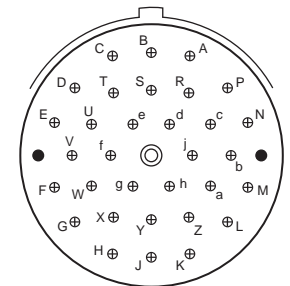

25-32

ARINC Insert Arrangement

Ordering Information ARINC 801 Connectors

ARINC 801 Shell Style	Amphenol Part Number		
	Finish		
	Black Anodize	Composite	OD Cadmium
Straight Plug	CF-97017X-YY	CF-97020X-YY	CF-97023X-YY
Wall Mount Receptacle	CF-97016X-YYP	CF-97021X-YYP	CF-97022X-YYP

Shell Size	Insert Arrangements							
	11	13	15	17	19	21	23	25
'X' in part number	2	3	4	5	6	7	8	9
'YY' in part number	02	04	06	08	12	16	24	32

Multi-Channel Fiber Optic Cylindrical Connectors Tri-Start (MIL-DTL-38999, III) with MT Ferrule inserts

Amphenol offers a multi-channel cylindrical connector with high density MT fiber optics. This connector uses MT ferrules described on page 8.

The features of the MT cylindrical connector include:

- High fiber density in a relatively small cylindrical connector package with all the advantages of the MIL-DTL-38999 series III proven connector
- Three levels of alignment provide for precision fiber to fiber interface:
 - Shell to shell with keying to allow for alternate positions
 - Insert plug to insert receptacle
 - MT contact guide pins
- Ferrules are available in either 12-fiber or 24-fiber versions, in multi-mode PC, single mode PC, and single mode APC configurations
- 2 arrangements are available as shown at right, shell size 11 with one ferrule, and shell size 21 with four ferrules



Tri-Start (MIL-DTL-38999, Series III) Connectors with MT Ferrule Inserts

Amphenol® Multi-Channel fiber optic connectors for use with MT ferrule termini can be ordered by coded part number. Ordering procedure is illustrated by part number CF-699011-1PN as shown below:

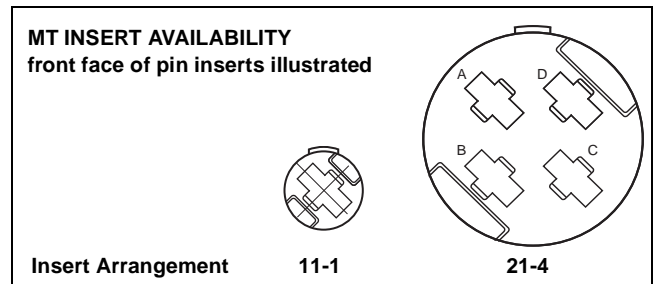

	CF	-	6	9	9	0	11	-	1	P
Connector Type _____										
Connector Class _____										
Terminus Style _____										
Shell Finish _____										
Shell Style _____										
Shell Size _____										
Insert Arrangement _____										
Insert Type and Key/Keyway Position _____										

Connector Type

CF designates Multi-Channel Fiber Optic Connector

Connector Class

- 5 designates aluminum shell, tight tolerance
- 6 designates composite shell, tight tolerance
- 8 designates stainless steel shell, tight tolerance

Terminus Style

9 designates MT terminus

Shell Finish

- 4 designates electroless nickel plated aluminum, 48 hour salt spray resistance, 200°C
- 5 designates unplated composite
- 6 designates corrosion resistant stainless steel, 500 hour salt spray resistance, 200°C
- 9 designates corrosion resistant olive drab cadmium plate aluminum, 500 hour salt spray resistance, 175°C
- D designates Durmalon™ (Nickel-PTFE)

Shell Style

- 0 designates wall mount receptacle
- 1 designates line receptacle
- 2 designates box mount receptacle
- 6 designates straight plug
- 7 designates jam nut receptacle

Shell Size

- 11 designates shell size 11
- 21 designates shell size 21

Insert Arrangement

- 1 designates single cavity
- 4 designates four cavity

Insert Type and Keyway Position

P designates plug insert
S designates socket insert
For keyway positioning, choose the alternate rotation suffix from the chart below.

ALTERNATE POSITION SUFFIX

Alternate Position	Suffix Letter	
	Pins	Sockets
Normal	P	S
A	G	H
B	I	J
C	K	L
D	M	N
E	R	T

Information on MT termini is provided on page 8.

Durmalon is a trademark of Amphenol Aerospace. For more information on Durmalon, go to www.amphenol-aerospace.com/durmalon.asp

Fiber Optic Bulkhead Feed-Through Connectors with size 16 pin termini on both ends

Amphenol extends its line of harsh environment fiber optic components with a multi-channel fiber optic feed-through. This feed-through is designed to perform in demanding aerospace environments and any other applications where a high degree of environmental sealing is required between bulkheads.

Features include:

- Fully compatible with D38999 and Amphenol® CF-series fiber optic connectors (Consult Amphenol Aerospace for mating connector information).
- Jam nut style for easy installation
- Available with M29504 fiber optic termini
- Meets or exceeds hermeticity of 10^{-7} cc/min. He leak testing
- Available finishes include electroless nickel and olive drab cadmium
- Typical fiber sizes include 50/125 and 62.5/125 multi-mode fiber (Consult Amphenol Aerospace for other fiber types and sizes).

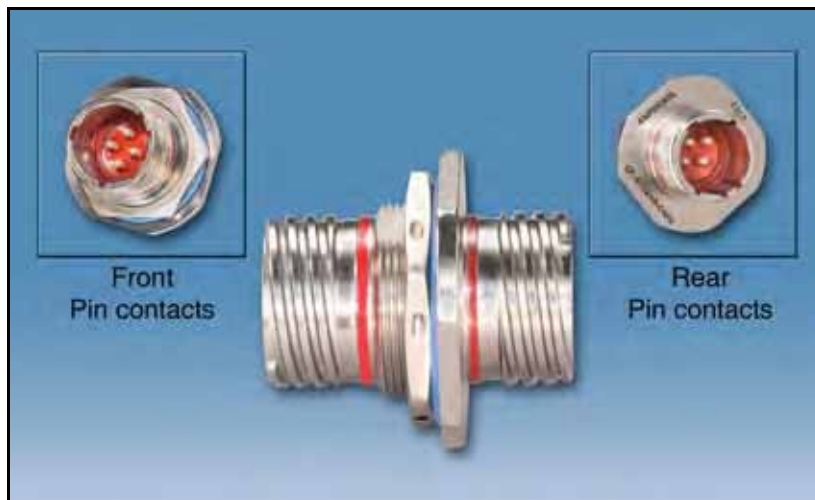

Fiber Optic Bulkhead Feed-Through Connector (Special size 16 Pin-Pin Termini Configuration)

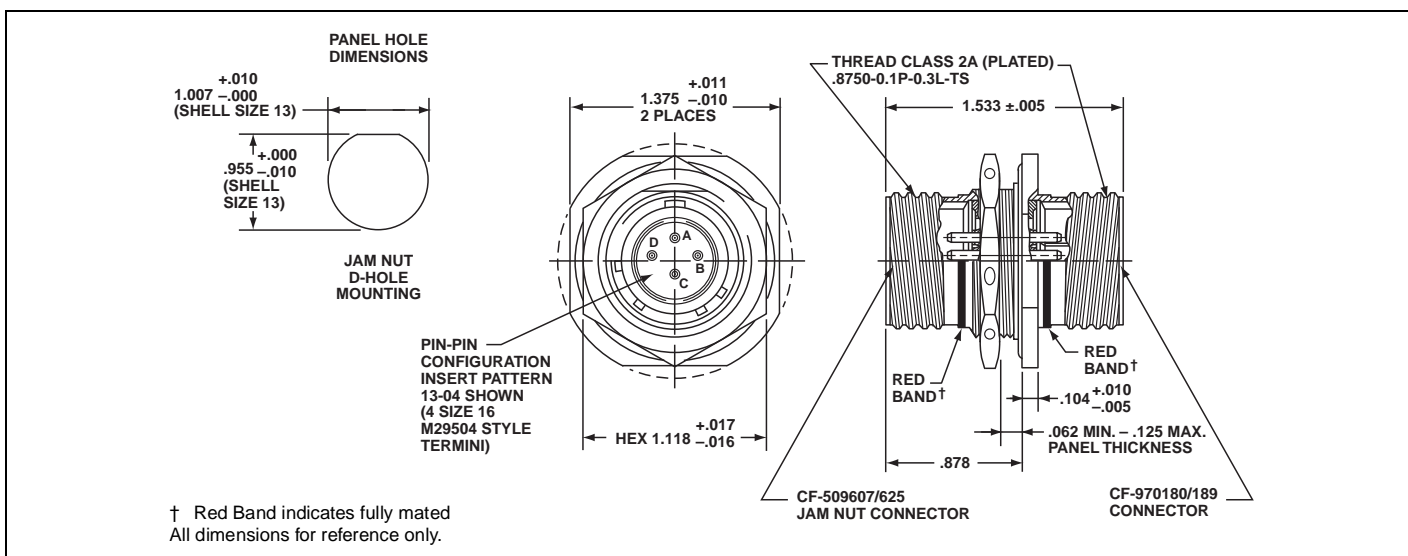

Ordering Information Fiber Optic Bulkhead Feed-through Connectors

Bulkhead Feed-through Shell Style	Amphenol Part Number	
	Finish	
	Electroless Nickel	OD Cadmium
Jam Nut Receptacle	CF-97024X-YYPA	CF-97019X-YYPA

Shell Size	Insert Arrangements							
	11	13	15	17	19	21	23	25
'X' in part number	2	3	4	5	6	7	8	9
'YY' in part number	02	04	05	08	11	16	21	29

PA suffix - indicates pin with Normal rotation on jam nut end and 'A' rotation (mirror image) on opposite end.

Accessories for Cylindrical Connectors

protection caps, sealing plugs, strain reliefs

Protection Caps

Shell Size	Plastic Protection Caps		MS Metal Protection Caps		
	For Plugs	For Receptacles	MS Shell Size Code	For MS Plugs	For MS Receptacles
9	10-70506-14	10-70500-10	A	D38999/32W9X*	D38999/33W9X*
11	10-70506-16	10-70500-12	B	D38999/32W11X*	D38999/33W11X*
13	10-70500-18	10-70500-14	C	D38999/32W13X*	D38999/33W13X*
15	10-70500-20	10-70500-16	D	D38999/32W15X*	D38999/33W15X*
17	10-70500-22	10-70500-19	E	D38999/32W17X*	D38999/33W17X*
19	10-70500-24	10-70500-20	F	D3899/32W19X*	D38999/33W19X*
21	10-70524-1	10-70500-22	G	D3999/32W21X*	D38999/33W21X*
23	10-70506-28	10-70500-24	H	D38999/32W23X*	D38999/33W23X*
25	10-70500-28	10-70524-1	J	D3899932W25X*	D38999/33W25X*

* To complete order number, replace X with applicable letter as follows:
 R - designates eyelet type
 N - designates washer type

MS metal protection caps are supplied with service class W which designates corrosion resistant olive drab cadmium plate aluminum.

Environmental Strain Relief for Jacketed Cable with Strength Member

(Can be used with size 16 or 20, multi-mode or single mode termini).

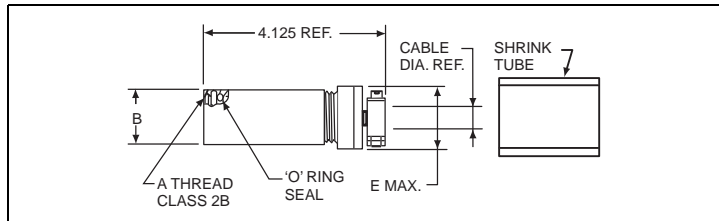

Non-Environmental Strain Relief for Individual Single Fiber Cables

(Can be used with size 16 or 20, multi-mode or single mode termini).

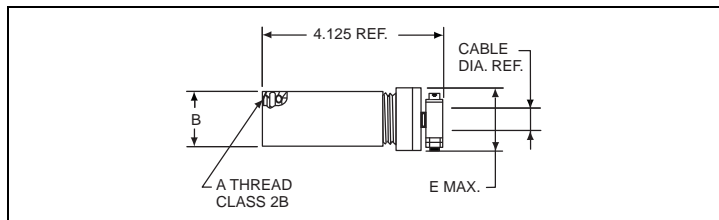

Environmental Strain Relief for Jacketed Cable with Strength Member			Non-Environmental Strain Relief for Individual Single Fiber Cables					Shell Size	A Thread Class 2B (Metric)	B Max. Dia.	E Max. Dia.
Assembly Part Number**	Cable Dia.		Assembly Part Number**	Cable Dia.		Max. No. of Cables					
	Max.	Min.		Max.	Min.						
CF-195022-11()	.300	.182	CF-195025-11()	.125	.060	2	11	M15X1-6H	.781	1.031	
CF-195022-13()	.412	.282	CF-195025-13()	.125	.060	4	13	M18X1-6H	.897	1.062	
CF-195022-15()	.412	.282	CF-195025-15()	.125	.060	5	15	M22X1-6H	1.054	1.062	
CF-195022-17()	.500	.282	CF-195025-17()	.125	.060	8	17	M25X1-6H	1.172	1.312	
CF-195022-19()	.500	.282	CF-195025-19()	.Consult Amphenol Aerospace.			19	M25X1-6H	1.290	1.312	
CF-195022-21()	.500	.282	CF-195025-21()				21	M25X1-6H	1.406	1.312	
CF-195022-23()	.500	.282	CF-195025-23()				23	M25X1-6H	1.531	1.312	
CF-195022-25()	.500	.282	CF-195025-25()				25	M25X1-6H	1.645	1.312	

Sealing Plugs

Sealing Plugs for Unused Contact Cavities		
Contact Size	Proprietary No.	Military No.
8 (Coax)	10-482099-8	N/A
8 (Twinax)	T3-4008-59P	N/A
8 (Power)	10-405996-81	MS27488-8-1
10 (Power)	10-576225	N/A
12	10-405996-121	MS27488-12-1
16	10-405996-161	MS27488-16-1
20	10-405996-201	MS27488-20-1
22D	10-405996-41	MS27488-4-1



Protection Caps



Sealing Plugs



Connectors Assembled with Strain Reliefs and Metal Caps

** To order strain reliefs see charts below. Complete the part number by adding a finish suffix as follows:
 -XX9 designates olive drab cadmium plate nickel plate
 -XXG designates electroless nickel
 Consult Amphenol Aerospace for availability of other strain reliefs.

Application tools for multi-mode termini for use in multi-channel cylindrical connectors

The following data includes information pertaining to the application tools which have been established for polishing, inserting and removing multi-mode fiber optic termini within multi-channel connectors. Insertion and removal tools are common to MIL-DTL-38999 size 16 and size 20 tools. Installation instructions L-1262 for multi-mode size 16 and L-2103 for multi-mode size 20 provide proper installation and polishing procedures for these termini. These are available on-line at www.amphenol-aerospace.com, under service instructions.



Plastic Insertion/Removal Tool for Size 16 Multi-mode Termini

Termination kits, as shown at right, are available for each Amphenol connector family. The kit includes the carrying case, heat gun, crimping and stripping tools and microscope with adapters.



Termination Kit

Application Tools for Multi-Channel, Multi-mode Fiber Optic Termini

Contact Size/ Type	Termini Part Number	Hand Polishing Tools*	Machine Polishing Tools		Termination Kit (Includes necessary field termination equipment)
			Amphenol/Buehler Fibernet*** Polishing Tool Part Number	Amphenol/Buehler Fiberscope*** Adaptor Body Part Number	
16 Multi-mode	CF-198035-()** Socket CF-198036-()** Pin	11-12123 or 11-12195 (grooved for wet polishing)	11-12103	11-12104	CF-8500-1†
20 Multi-mode	CF-198080-()** Socket CF-198081-()** Pin	11-12153	N/A	N/A	CF-8500-3††

Contact Size/ Type	Insertion Tools					
	Plastic Tools (Double ended insertion/removal tool)		Metal Tools			
	MS Part Number	Color	Angle Type		Straight Type Proprietary Part Number	Color
			MS Part Number	Proprietary Part Number		
16 Multi-mode	M81969/14-03	Blue/White	M81969/8-07	11-8674-16 11-012197-16†††	11-8794-16 11-012198-16†††	Blue
20 Multi-mode	M81969/14-10	Red/Orange	M81969/8-05	11-8674-20	11-8794-16	Red

Contact Size/ Type	Removal Tools						
	Plastic Tools (Double ended insertion/removal tool)		Metal Tools				
	MS Part Number	Color	For Unwired Contacts Proprietary Part Number	Angle Type		Straight Type Proprietary Part Number	Color
				MS Part Number	Proprietary Part Number		
16 Multi-mode	M81969/14-03	Blue/White	11-10050-10	M81969/8-08	11-8675-16	11-8795-16	White
20 Multi-mode	M81969/14-10	Red/Orange	11-10050-9	M81969/8-06	11-8675-20	11-8795-20	White

◆ FOR APPLICATION TOOLS FOR SINGLE MODE TERMINI, CONSULT AMPHENOL AEROSPACE.

The M81969/8, 11-8675 and 11-8794 metal contact insertion and removal tools will accommodate wires having the maximum outside diameter of .105 for size 16 and .084 for size 20. When wire diameters exceed this, the plastic tools must be used.

* Single Termini Capability

** To complete order number add fiber size; see ordering information on page 3 for size 16 multi-mode, and page 4 for size 20 multi-mode.

*** Fibernet and Fiberscope are registered trademarks of Buehler Ltd.

† This includes hand polishing tool 11-12123.

†† This includes hand polishing tool 11-12153.

††† Recommended tool for socket termination insertion.

Rectangular PCB Connectors with Multi-mode Size 16 Termini hybrid arrangements - Brush contacts and fiber optics

Fiber Optic Termini for PCB Connectors

Amphenol's superiority and breadth of product offering is demonstrated in its capacity for packaging fiber termini and the Brush contact in a printed circuit board connector.

Fiber termini size 16 and HD20 can be used as well as the 90° termini style with optical performance the same as when used in cylindrical connectors.

Consult Amphenol Aerospace for assistance in solving design problems and for part numbers that will provide the proper combination of these hybrid configurations to meet your specific requirements.

For more information on PCB connectors see catalog 12-035 on-line at www.amphenol-aerospace.com.

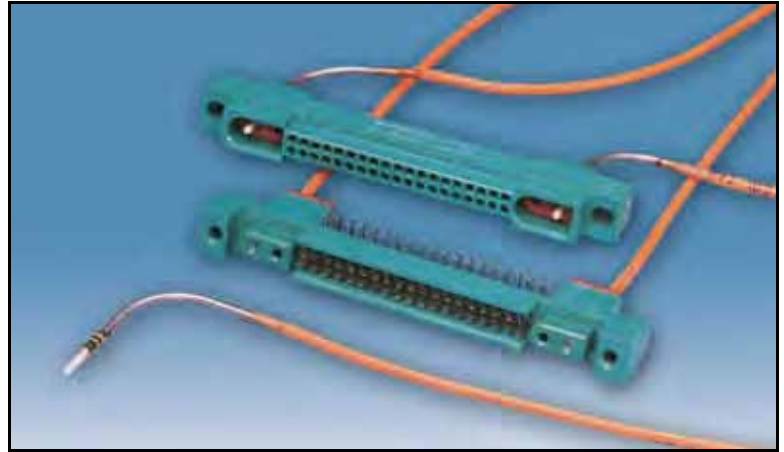

Printed Circuit Board Rectangular Connector with Hybrid Configuration (Fiber Optics and Brush Contacts)

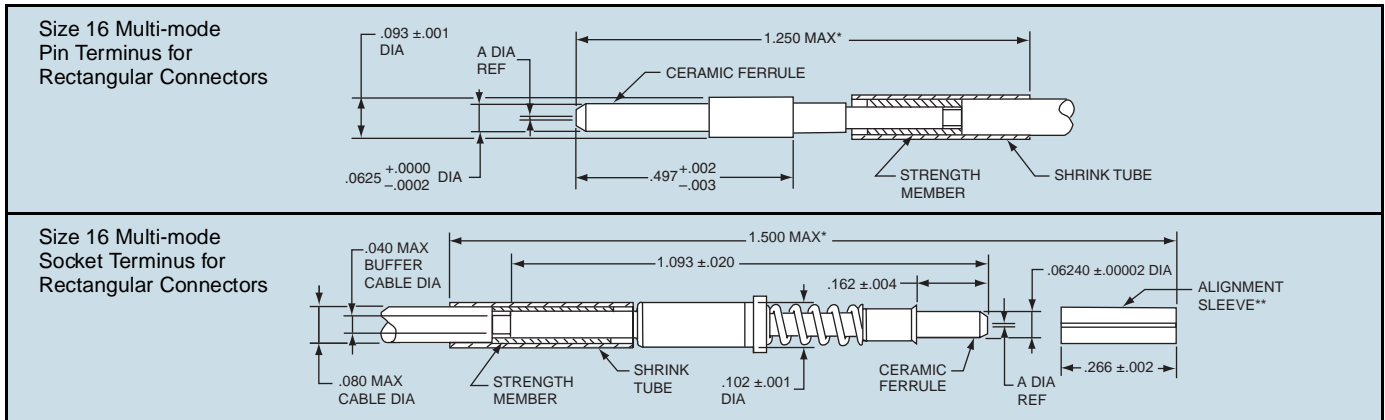

Typical fiber optic straight termini for rectangular PCB connectors are depicted. However, these illustrations do not represent all configurations. Consult Amphenol Aerospace for further information.

* Indicated dimension when fully assembled.

** Alignment sleeve shipped unassembled.

† Additional sizes available upon request: consult Amphenol, Sidney, NY for availability.

Power contacts can be purchased separately, contact Amphenol, Sidney, NY.

Amphenol® B³ Brush Contacts

B³ stands for Bristle Brush Bunch contact - multiple strands of high tensile wire that intermesh to create an electrical connection. The Bristle Brush contact has been proven in military avionics packages and meets the requirements of MIL-DTL-55302. It provides high density in tighter spacing which is a main concern for integrated electronics in aircraft systems. Advantages of the brush contact include:

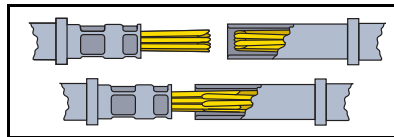

- Redundant current paths: 14-70 gas tight points of contact per mated bunch
- Very smooth low friction interface
- Low mating forces: 1.5 oz. typical per contact, 70-90% lower than conventional contacts
- Long contact life: 100,000 cycles of mating and unmating without performance degradation
- Documented intermittency free performance: No 10 nano-second discontinuities during 50,000,000 cycles of 0.010" displacement
- Impervious to fretting

Fiber Size† Core/Cladding Dia (Microns)	A Dia Ref	
	Inches	Microns
50/125	.0050	127
62.5/125	.0050	127
200/230	.0093	236
200/240	.0097	245

PCB Connector Arrangement with Brush contacts and Fiber Optics

10 to 100 Brush contacts plus 4 fiber optic termini. Consult Amphenol for part number.



RECTANGULAR FIBER OPTIC CONNECTORS

LRM Connectors with Multi-mode Size 16 Termini hybrid arrangements - Brush contacts and fiber optics

Fiber Optic Termini for Line Replaceable Module (LRM) Connectors

Fiber optic high speed transmission is available within LRM connectors for use in advanced avionics systems. Optical performance of fiber optic termini within the LRM connectors are the same as termini used in cylindrical connectors.

Modified MIL-PRF-29504/4, /5, size 16, straight termini (shown in drawings below) or 90° styles can be configured into LRM interconnects. Termini for rectangular LRM connectors are determined by insert and shell style of the connector. For ordering information for LRM connectors consult Amphenol Aerospace.

LRM interconnects can have hybrid arrangements of fiber optics with Brush contacts, as well as other contact types. Brush contacts are arranged in staggered grid patterns or Gen-X patterns. The contact patterns shown at right represent some fiber optic and brush contact arrangements typical for LRM connectors.



LRM Connectors with Fiber Optic Multi-mode Termini in Combination with Brush Contacts

Amphenol® LRM Connector Series

LRM connectors are high performance, high density interconnects, specifically designed to connect printed circuit boards. The Amphenol Brush contact technology is the foundation of the LRM connector series.

Features, benefits and options of LRM connectors include:

- GEN-X contact pattern - has .075 inch spacing along the row with .060 inch between rows, offset .0375 inch between rows on the mating face.
- Staggered grid contact pattern - has .100 inch spacing along the row with .050 inch between rows, offset .050 inch between rows on the mating face
- Staggered grid Airflow-thru contact pattern - for wider or oversized board packages between 0.235 and 0.425 inches. Wider spacing in center also provides for more airflow cooling of the connector inserts.
- Backplane design versatility:
 - Available with through-hole solder posts or with compliant pins for solderless applications
 - Compliant/solderless backplane contacts are front replaceable
- ESD Protection - Staggered grid and GEN-X LRM connectors are typically provided with ESD (Electrostatic Discharge) protection. They utilize the Faraday Cage principal to shunt electrostatic discharge events to the conductive enclosure on which the connector is mounted, thus never allowing the high voltage, high current discharge event to reside on any contacts.
- Wide range of PCB/heat sink accommodations with standard surface mount tails or optional flex-circuit termination
- Polarization keys - up to 4096 possible keying positions
- Vibration: Superior intermittency-free performance under vibration
- Dielectric withstanding voltage: Staggered grid and GEN-X styles: 100 volts at sea level (due to the incorporation of ESD shield)
- Temperature range:
 - Suitable for vapor phase soldering
 - Normal operating temperature is -65°C to +125°C
- Current rating: 3.0A derated to 1.5A typical (dependant on loading)

For more information on Amphenol LRM interconnects see catalog 12-037 on-line at www.amphenol-aerospace.com.

Staggered Grid LRM Patterns with Fiber Optics

108 brush contacts plus 8 fiber optic termini
BP Termini: CF-198070-() or CF-198071-()
MOD Termini: MIL-T-29504/5

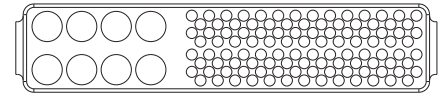

108 brush contacts plus 6 fiber optic termini
BP Termini: MIL-T-29504/6
MOD Termini: MIL-T-29504/5

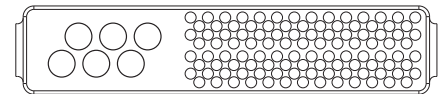

152 brush contacts plus 4 fiber optic termini
BP Termini: CF-198070-() or CF-198071-()
MOD Termini: CF-198059-()

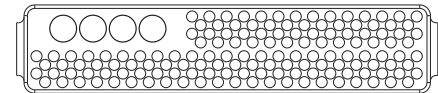

Consult Amphenol Aerospace for part number ordering information. Custom configurations are also available.

LRM Connectors with MT Ferrule Termini hybrid arrangements - Brush contacts and fiber optics

Fiber Optic MT Ferrules for Line Replaceable Module (LRM) Connectors

MT ferrules are widely used in LRM interconnects for high speed data transmission. The small rectangular MT components provide very high density. MT ferrules can have 12 fiber lines per ferrule or 24 fiber lines per ferrule.

Termini for rectangular LRM connectors are determined by insert and shell style of the connector. The contact patterns shown at right represent some fiber optic MT ferrules and brush contact arrangements typical for LRM connectors.

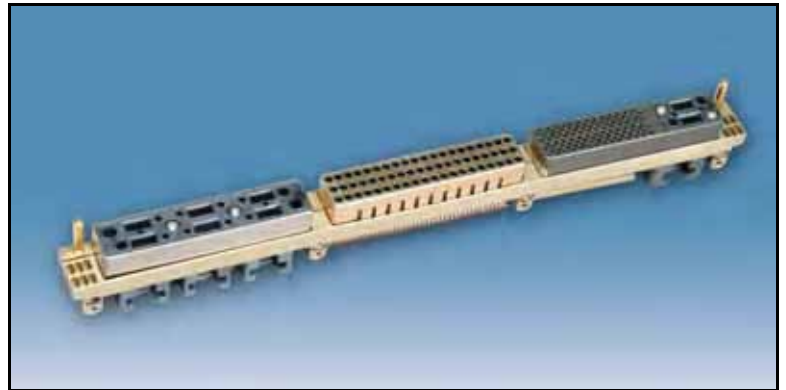

LRM Connectors with MT Ferrule Fiber Optics in Combination with Brush Contacts

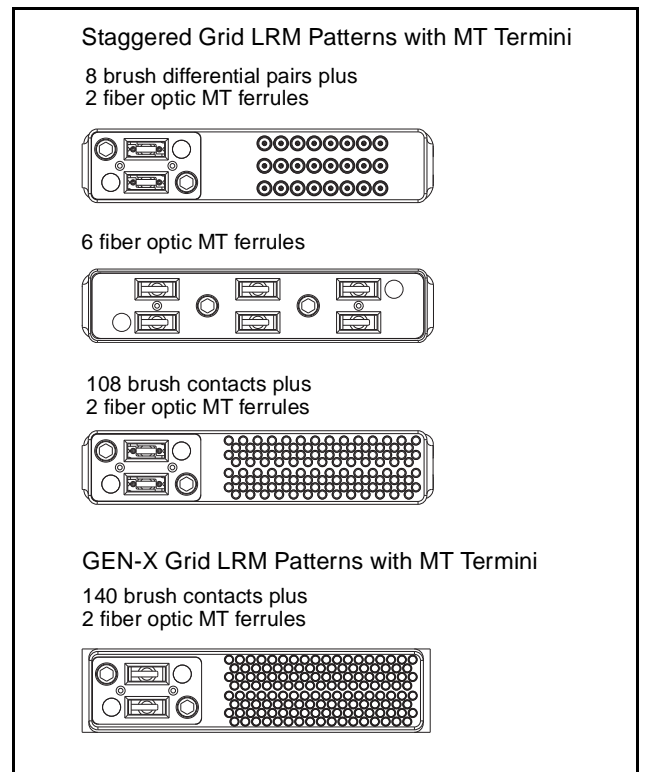
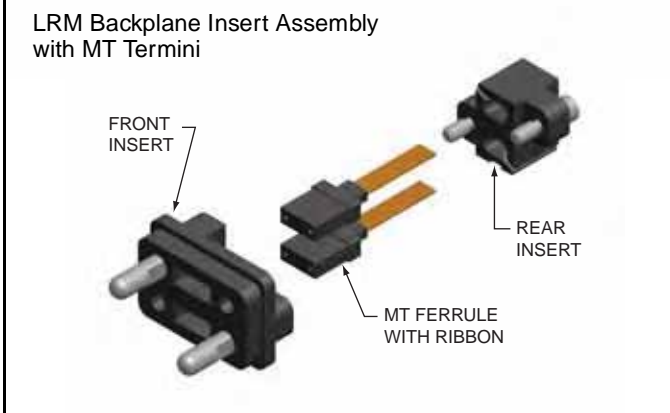
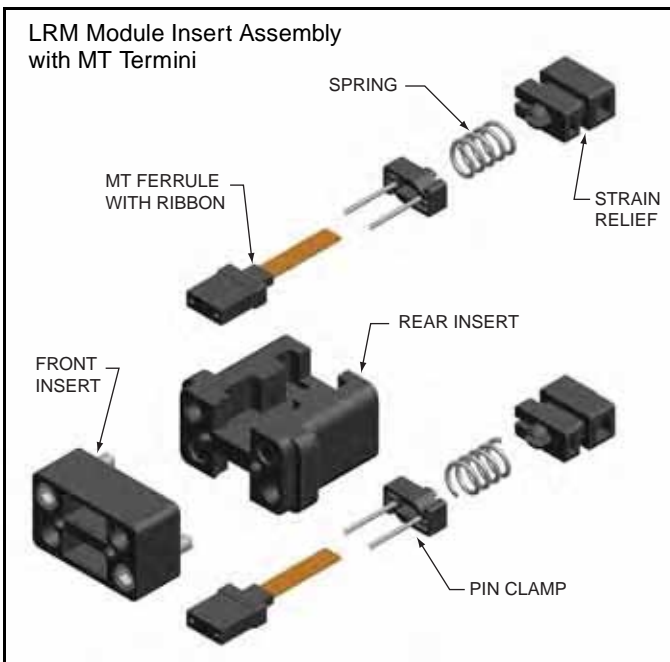

Consult Amphenol Aerospace for part number ordering information.

VME64X, VITA-46 Type Interconnects and Backplane Systems with Fiber Optics

Fiber Optic MT Ferrules for VME64x

Amphenol provides a fiber optic interconnect for attachment to standard VME-64x cards and backplanes for the P0 and J0 locations of the boards. It uses MT ferrules and it is used in place of P0/J0 electrical applicable connectors.

Performance features include:

- Tested to IEEE 1156.1-1993 paragraphs
- Operating temperature from -55°C to $+125^{\circ}\text{C}$
- Shock: 100g, 6ms, 1/2 sine, 18 pulses
Shock: 30g, 6ms, 1/2 sine, 18 pulses
- Sine vibration: 10g, 40 min./axis, 3 axis
- Random vibration: 0.15g² Hz, 40 min./axis, 2 axis
- ESD: 15KV/150 pF

Amphenol's VME P0/J0 fiber optic connectors are used in military and commercial aviation, military vehicles and GPS systems. They are designed to customer specifications. Consult Amphenol Aerospace for further information.

Fiber Optic MT Ferrules for VITA-46

Amphenol's proposed VITA-46 MT connector provides a reliable high speed connection for the most extreme commercial and military environments.

This ruggedized interconnect is among the highest density of connector products on the market.

- Up to 24 fiber optic channels per MT ferrule
- Up to 48 channels per connector

Fiber Optics for Backplane Systems

Amphenol is a leader in the design and manufacture of backplane assemblies and enclosures for military and aerospace applications. Amphenol Backplane systems provide custom backplane assemblies using high density, ruggedized, board-to-board backplane interconnects.

The high technology backplane product offerings include:

- Electrical backplanes - Large panel sizes with high layer counts, and features such as high aspect ratio plating, small diameter plated-through holes, and controlled impedances
- Optical backplanes - Fiber termination with MT optical ferrules. Ribbon cable sorting allows programming flexibility; thus rendering the entire system easily upgradeable.
- Hybrid Optical backplanes - Integrated electrical and optical systems in one discrete package for advanced avionics systems requiring high speed optical/digital signal processing.

For more information on Amphenol Backplanes consult ABS, Amphenol Backplane Systems Division or Amphenol Aerospace.



VME P0/J0 Connectors with MT Ferrule Fiber Optics



Ruggedized Proposed VITA-46 Connectors with MT Ferrule Fiber Optics

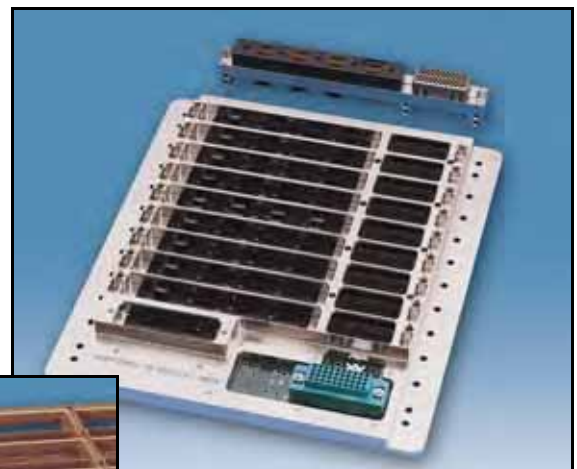

Fiber Optic Backplane with MT Ferrules in LRM Connectors



Fiber Optic Backplane with MT Ferrules in LRM Connectors plus a Cylindrical Connector with MIL-PRF-29504 Termini

ARINC Rack and Panel Connectors with ARINC 801 Termini

Amphenol Canada offers ARINC 801 fiber optic termini and MIL-PRF-29504 termini in all their rectangular connectors. Standard rectangular connector formats include:

- ARINC 600
- ARINC 404
- M24308
- R27 (MIL-DTL-83527)
- R58 (MIL-DTL-83733)
- R39 (Rectangular 38999)

The rectangular connectors from Amphenol Canada are well suited for harsh environmental military avionics applications (R58, R27 & R39) as well as commercial aircraft applications (ARINC 600 & ARINC 404). The ARINC 801 fiber optic termini originally designed for commercial aircraft applications has been incorporated into all of these rectangular connector products and applications.



ARINC 600 Rack and Panel Connector with Fiber Optics



R27 Series Rack and Panel Connector with Fiber Optics

The products features of the ARINC 801 termini include:

- ferrule diameter 1.25mm
- genderless termini
- available in multi-mode or single mode
- end face finishes in PC and APC
- keyed to ensure anti-rotation
- alignment sleeves are contained in a separate carrier
- alignment sleeve carrier is removable to provide easier end face cleaning
- pull-proof strain relief design
- crimp contact
- precision ceramic ferrules and sleeves ensure accurate fiber to fiber alignment
- standard extraction tool M81969/14-03

Also see page 7 for information on ARINC 801 termini features.

Contact Amphenol Canada for additional information on the products on this page, and also for additional insert patterns available.

Phone: 416-291-4401

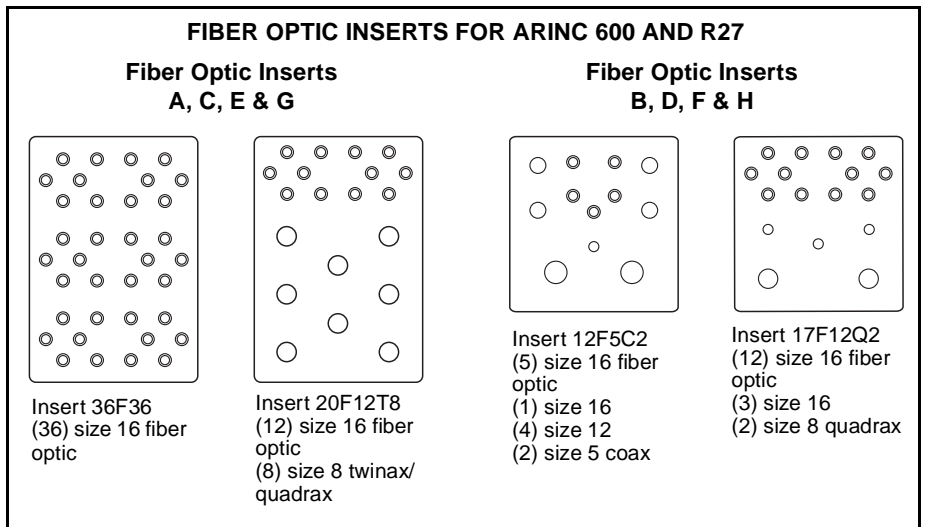

R58 Series Rack and Panel Connector with Fiber Optics

Fiber Optic Cable Systems for use in multi-channel cylindrical connectors

Fiber Optic Custom Cable Assembly Design and Fabrication

Amphenol's cable assembly expertise dates back to the first industry standard fiber optic connector, over 25 years ago. Our depth of understanding of connector and termini design, and the complete control of connector materials, make Amphenol Fiber Optic cable assemblies one of the best in the industry. Amphenol offers a comprehensive line of single mode and multi-mode cable assemblies in a variety of cable configurations. From simple jumpers to multi-fiber custom assemblies, Amphenol can design and supply all of your cable needs.

High quality polishing processes have been developed to meet and exceed industry standard specifications for insertion loss, return loss and end-face geometry. All assemblies are designed to intermateability standards for optical and physical performance criteria.

Amphenol can assemble, polish and test many harsh environment and commercial grade connectors including:

- MIL-PRF-29504
- HD20
- MTC/MP0
- ARINC 801
- ST
- LC
- FC
- SC



**ARINC 801 Connectors
and Cables**

Connector and cable materials are extensively inspected prior to assembly. Every completed cable assembly receives 100% inspection for both insertion loss and visual defects. Interferometers are used for accurate end-face geometry testing.

You specify the optical and mechanical requirements of the cable assembly and Amphenol's fiber optic application's engineers will develop an "end-to-end" interconnect solution. Design creativity, experience and an understanding of harsh environments will ensure a functional and manufacturable design. See the next page for a guide to selecting and specifying a fiber optic cable assembly.



D38999 Fiber Optic Connectors and Cables



**Explosion Proof Amphe-EX™ Connectors
and Cables**



**D38999 Fiber Optic Connectors with Strain
Reliefs, Cables and Cable Clamps**

Fiber Optic Cable Systems

cable designer's guide

The following criteria should be considered when specifying a fiber optic cable assembly. You may copy this page and fax it Amphenol Aerospace*. Our design engineers are ready to help meet your custom cable application requirements.

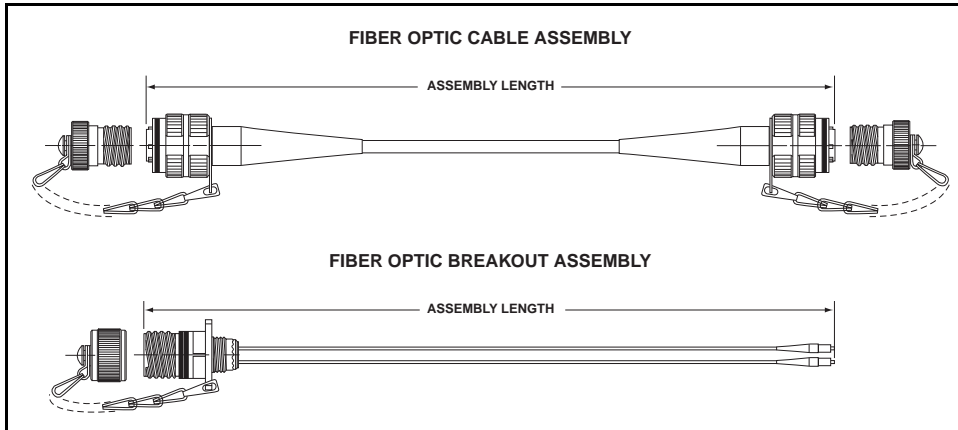

Typical Breakout Cable Assembly shown:

- Connector ends: MIL-DTL-38999 Fiber Optic Jam Nut Receptacle; and Commercial grade ST
- Termini in the 38999 connector are size 16 single mode
- Optical wavelength: 1300
- Cable: Avionics grade; 1 ft. length

This check list is provided to help ensure a thorough design of a custom fiber optic cable assembly.

ENVIRONMENTAL CRITERIA

- High Temperature _____
- Low Temperature _____
- Salt Spray _____
- Mechanical Shock _____
- Mechanical Vibration _____
- Durability _____

COMPONENTS

Termini

- MIL-PRF-29504
 - Pin _____
 - Socket _____
- ARINC 801 _____
- MTC _____
- HD20 _____
- Other _____

Connectors - Cylindrical

- MIL-DTL-38999 _____
- ARINC 801 _____
- MTC _____

Connectors - Rectangular

- Low mating force, PCB _____
- LRM _____
- Rack and Panel _____
- VME64X _____
- VITA-46 _____

Accessories

- Backshells/Strain Reliefs _____
- Sealing plugs _____
- Protection caps _____

OPERATIONAL CRITERIA

- Assembly Length and Tolerance _____

Optical Wavelength

- 850 _____
- 1300 _____
- 1550 _____
- Other _____

Fiber Core Size

- 5/125 single mode _____
- 9/125 single mode _____
- 50/125 multi-mode _____
- 62.5/125 multi-mode _____
- 100/140 multi-mode _____
- 200/230 multi-mode _____
- Other _____

Performance

- Insertion Loss _____
- Return Loss _____

Cable Type

- Field Tactical _____
- LSZH _____
- Breakout _____
- Distribution _____
- Avionics _____

* Fax to 607-563-5157, attention Fiber Optic Design Engineering, Amphenol Aerospace. Or call 607-563-5011 for further assistance.

Additional Fiber Optic Products

TFOCA-II[®], M28876, ST and MIL-PRF-NGCON connectors

TFOCA-II[®] Fiber Optic Connectors

The TFOCA-II[®] 4 and 12-channel fiber optic connectors are ideal for military tactical applications as well as other environmentally harsh conditions. This unique connector series is designed and patented by Amphenol Fiber Systems International and is the base line design for the DFT MIL-PRF-83526/16 and /17. The TFOCA-II[®] design takes advantage of the latest in fiber optic connectivity technology and is recognized as the industry standard for tactical deployable interconnect. The TFOCA-II[®] is the required ground tactical connector for the US Army WIN-T (Warfighter Information Network Tactical) program.

The TFOCA-II[®] connector is designed to need little or no maintenance in the field. However, if field-level repair and cleaning is required, all TFOCA-II[®] connectors can be fully field repaired reusing all components with the exception of the termini. It has a removable end-cap to allow direct access to the alignment sleeve and termini.

M28876 Fiber Optic Connectors

Amphenol Fiber Systems International produces M28876 multi-channel fiber optic connectors and backshells for the US Navy shipboard requirements. These connectors are designed to provide superior optical performance in severe environmental and mechanical operating conditions. AFSI backshells feature the robust, yet simple to use Quickloc cable captivation system. Angled physical contact (APC), custom material, and custom plated connectors are also available.

Military ST Fiber Optic Connectors

Amphenol Fiber Systems offers rugged military fiber optic ST Connectors for deployable and fixed communication systems requirements. Various versions of connectors and adapters are available to meet a broad range of specific needs and system requirements. The MIL-C-83522 connector is qualified for military applications. This stainless steel connector features a higher spring force, allowing it to meet the shock requirements as specified in MIL-C-83522.

COTS ST Fiber Optic Connectors

AFSI's COTS ST connectors provide the same robustness with a spring force more consistent with commercial ST connectors, enabling them to better connect to all other ST connectors and ancillary electronics.

MIL-PRF-NGCON, MIL-PRF-64266 Fiber Optic Connectors

AFSI offers MIL-PRF-NGCON compliant fiber optic connectors with proven technology and features from existing connector standard of 38999 and 28876 for the next generation connector (NGCON). These innovative connectors include genderless contacts and high-density packaging.

For more information on the products from Amphenol Fiber Systems International call 214-547-2400.



TFOCA-II[®] Fiber Optic Connectors



M28876 Fiber Optic Connectors



MIL and COTS ST Fiber Optic Connectors



MIL-PRF-NGCON Fiber Optic Connectors

Additional Fiber Optic Products

Hermaphroditic fiber optic connectors, MFM, CTOS, CTOL and AXOS connectors

Hermaphroditic Fiber Optic Connectors

Amphenol Socapex (ASF) provides three fiber optic transmission interconnects for semi to harsh environments. All three styles eliminate the need for polarizing the assemblies or using adapters.

- **HQM** - fully hermaphroditic with an active receptacle option
- **HDM** - lightweight, smaller design, fully hermaphroditic
- **HLM** - fully hermaphroditic, for extreme harsh environments where cost and space are factors and lensing is preferred.

All three types are produced with butt joint fiber optic technology which provides for lower insertion losses. All three are bayonet coupling and are available in 2 channels with multi-mode and single mode termini.

MFM Fiber Optic Connectors

ASF offers the MFM connector family of connectors which use butt joint ceramic ferrule technology with a ceramic alignment sleeve:

- **Hermaphroditic MFM Connectors** (shown top)- designed to facilitate the interconnection of fiber optic cable



MFM Family of Connector

assemblies. One piece construction; shell machined from non-corrosive nickel aluminum bronze.

- **Duplex MFM Connectors** (shown center) - lightweight MFM connectors developed specifically for external applications. Simple termination of sub-assembly due to one-piece construction. Both shells and ferrules are keyed for optimum repeatability. Environmental silicon O-ring sealing.
- **Simplex MFM Connectors** (shown bottom) - small and lightweight MFM connectors capable of withstanding the most stringent environments. Interface with a wide range of rugged fiber optic cables. Both shells and ferrules are keyed for optimum repeatability. Anti-vibration coupling mechanism.

CTOS, CTOL, AXOS Field Deployable Lens Connectors

ASF offers fiber optic high speed transmission Tactical Multiway interconnects for harsh environments like battlefield conditions and quick deployable large capacity links. These are hermaphroditic connectors with expanded beam fiber optic technology; qualified to Stanag 4290. Stainless steel bodies resist corrosion, and ergonomic ribbed synthetic rubber shells improve handling and ensure mechanical protection. These connectors provide EMI protection.

- **CTOS** - 38 mm dia.; 2 and 4 channel, single mode and multi-mode termini
- **CTOL** - 52 mm dia.; 2, 4 and 8 channel; multi-mode termini
- **AXOS** - 27 mm dia.; 2 and 4 channel; multi-mode termini

For more information on the products on this page call Amphenol Socapex (ASF) in France 33-4-5089-2800 in North America, call Amphenol Fiber Systems International 214-547-2400



HQM Hermaphroditic Connector



HLM Hermaphroditic Connector



CTOS Connector



CTOL Connector



AXOS Connector

Additional Fiber Optic Products

MTRJ Field connectors, Tactical optical splice

MTRJ Field Connectors

Amphenol Socapex provides a cylindrical fiber optic interconnect with a MTRJ interface. It is available with 1, 2 or 4 channels. This interconnect allows for the use of any preassembled standard MTRJ patchcord (Mini round, Flat Duplex or Duplex Zipcord) to be upgraded to a harsh environment connection system; no additional termination or tooling required. It is designed for use in all levels of harsh environments from industrial to mil-aero applications.

The MTRJ uses a MIL-D38999 Series III threaded coupling shell, providing the advantage of an anti-decoupling device for high vibrations. It is rated IP67 for protection from dust, fluids, vibration, shock and traction. Durability: 500 mating cycles. Adapts to various cordset types and types of fiber 50/125, 62/125, 9/125.

For further information go to Amphenol website: www.rjfield.com or call Amphenol Socapex in France 33-4-5089-2800.

Tactical Optical Splice

Amphenol Socapex offers a fiber optic splice used for easy repair of tactical cables in the field with no epoxy handling. This splice restores all the functions of the cable such as tensile strength and flexibility crush resistance.

For more information call Amphenol Socapex in France 33-4-5089-2800 in North America, call Amphenol Fiber Systems International 214-547-2400



MTRJ Field Connector



Tactical Optical Splice

Компания «Океан Электроники» предлагает заключение долгосрочных отношений при поставках импортных электронных компонентов на взаимовыгодных условиях!

Наши преимущества:

- Поставка оригинальных импортных электронных компонентов напрямую с производств Америки, Европы и Азии, а так же с крупнейших складов мира;
- Широкая линейка поставок активных и пассивных импортных электронных компонентов (более 30 млн. наименований);
- Поставка сложных, дефицитных, либо снятых с производства позиций;
- Оперативные сроки поставки под заказ (от 5 рабочих дней);
- Экспресс доставка в любую точку России;
- Помощь Конструкторского Отдела и консультации квалифицированных инженеров;
- Техническая поддержка проекта, помощь в подборе аналогов, поставка прототипов;
- Поставка электронных компонентов под контролем ВП;
- Система менеджмента качества сертифицирована по Международному стандарту ISO 9001;
- При необходимости вся продукция военного и аэрокосмического назначения проходит испытания и сертификацию в лаборатории (по согласованию с заказчиком);
- Поставка специализированных компонентов военного и аэрокосмического уровня качества (Xilinx, Altera, Analog Devices, Intersil, Interpoint, Microsemi, Actel, Aeroflex, Peregrine, VPT, Syfer, Eurofarad, Texas Instruments, MS Kennedy, Miteq, Cobham, E2V, MA-COM, Hittite, Mini-Circuits, General Dynamics и др.);

Компания «Океан Электроники» является официальным дистрибьютором и эксклюзивным представителем в России одного из крупнейших производителей разъемов военного и аэрокосмического назначения «**JONHON**», а так же официальным дистрибьютором и эксклюзивным представителем в России производителя высокотехнологичных и надежных решений для передачи СВЧ сигналов «**FORSTAR**».



JONHON

«**JONHON**» (основан в 1970 г.)

Разъемы специального, военного и аэрокосмического назначения:

(Применяются в военной, авиационной, аэрокосмической, морской, железнодорожной, горно- и нефтедобывающей отраслях промышленности)

«**FORSTAR**» (основан в 1998 г.)

ВЧ соединители, коаксиальные кабели,
кабельные сборки и микроволновые компоненты:

(Применяются в телекоммуникациях гражданского и специального назначения, в средствах связи, РЛС, а так же военной, авиационной и аэрокосмической отраслях промышленности).



Телефон: 8 (812) 309-75-97 (многоканальный)

Факс: 8 (812) 320-03-32

Электронная почта: ocean@oceanchips.ru

Web: <http://oceanchips.ru/>

Адрес: 198099, г. Санкт-Петербург, ул. Калинина, д. 2, корп. 4, лит. А