





Amphenol®/Pyle® Industrial Connectors Star-Line®, Star-Line EX®, Rig-Power®

12-054-4

Heavy Duty, Environmentally Sealed,
Power and Control Connectors

UL Ex IEC IECEx PGT INMETRO ETL



Amphenol

Interconnects for Control & Signal Applications

Rugged, Heavy Duty, Environmentally Sealed



Amphenol®
Star-Lok Series



Star-Line with
Basketweave Cable Grip



Amphenol®/Pyle®
Star-Line® Series

Amphenol®/Pyle®
Star-Line EX® Series



Star-Line®
with Backshell



Star-Line®
with Cable Gland



Amphenol® PT Series
Miniature 26482 Type



Amphenol® RPT Series



Amphenol®
Amphe-EX® Series



Amphenol® Cable Glands



Amphenol® Cord Grips

Amphenol®

www.amphenol-industrial.com



Contents

Star-Line® Series Overview	2
Star-Line EX® Series Overview	3
Environmental Highlights, Double Lead Acme Thread Features, Wire Limitation Guide	4
Contact Insert Features-Mod I, Mod II	5
Connector Component Ordering Details	6 - 9
Plug Hardware Assemblies	10 - 13
Receptacle Hardware Assemblies	14 - 22
Starline EX® Product Instructions.....	23 - 24
Starline EX® Ordering Details, EEx d Cable Types.....	25 - 27
Starline EX® Hardware	28 - 30
Starline EX® Description of Equipment & Part Number Code Logic	31
Starline EX® Assembly and Termination Instructions	32 - 40
Single Pole Power Connectors	41 - 45
Insert Configuration Listing, Electrical Ratings.....	46 - 47
Spare Replacement Contacts for MOD II Inserts.....	48
Termination Data	49
Thermocouple Contacts	50
Insert Configuration Index	51 - 53
Insert Configurations	54 - 81
V.F.D. Insert Configurations.....	82 - 83
Connector Components, Spare Parts, Cable Adapters and Accessories	84 - 89
Protection Covers and Caps Accessories	90 - 91
Conduit System Accessories.....	92 - 93
Crimping, Insertion and Removal Tools	94 - 95
Connector Assembly and Termination Instructions	96
Connectors with RADSOK® High Amperage Contacts and Other Amphenol®/Pyle® Connectors.....	97 - 99
Sales Offices and Distributors Listing	100

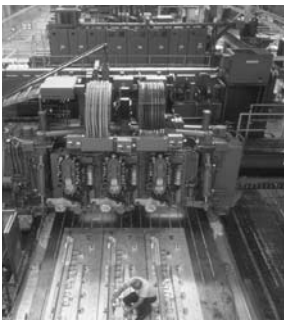

Catalog information for reference only. For more assistance, contact your local Amphenol field sales office or:

Amphenol Industrial Operations
40-60 Delaware Avenue,
Sidney, NY 13838-1395
Phone: 1-888-364-9011
Fax: 1-520-397-7169
Technical email: tech@amphenol-aio.com

This catalog and most all Amphenol catalogs are available for viewing, printing and downloading on websites:

www.amphenol-industrial.com
www.amphenol-aerospace.com

STAR-LINE® Series

Star-Line Series “ZP/ZR” connectors are heavy duty environmentally sealed plugs and receptacles and have been successfully used in all types of Industrial and Aerospace applications. These compact environmental connectors have provided outstanding performance in complex ground support cable networks, automatic and process control systems and instrumentation systems.

This family of connectors has made a major contribution to the successful interconnection of peak power generating systems as well as offshore petroleum production for power distribution and data acquisition.

Ample margins of safety and reliability have been designed into the Star-Line connectors to maintain capability levels which make them ideally suited for the broad spectrum of demands placed on them by industry.

The specific materials and design features incorporated in Star-Line connectors were originally selected to satisfy the stringent requirements of the Aerospace industry for heavy-duty connectors. These connectors combine electrical and mechanical capabilities that equal or exceed the performance parameters established by the Military Specification MIL-5015.

- **UL & CSA** listed to UL1977/CSA C22.2 requirements
- **ENVIRONMENTAL RESISTANCE** – Design and materials withstand the most challenging operating conditions. Series has an IP 68-8 rating.
- **SOLDER, CRIMP AND PRESSURE TERMINALS AVAILABLE**
- **EASILY ACCESSIBLE WIRE TERMINALS** – Conductors are readily terminated to contacts. Cable housings are slipped over conductors or leads after terminating. Cumbersome handling and seating of inserts with conductors attached is eliminated.
- **LARGE WIRING SPACE** – Ample wiring space is provided in cable housings and conduit fitting bodies. Hub of body mounts in any of four positions (except FS & FD box assemblies).
- **REVERSIBLE INSERTS** – A full range of contact inserts and application adapters are available. All are interchangeable and reversible to suit special needs.



* Star-line Series Connectors are certified to UL 1977 specifications.

- **DOUBLE-LEAD THREAD COUPLING** – Modified Acme Thread does not clog under adverse conditions of ice, snow, sand or mud and provides the quick coupling feature.
- **HARD ANODIC COATING** – All machine, aluminum parts finished with a hard, scratch-resistant coating per MIL-A-8625, Type III. Dielectric strength 1800 volts. Heat resistance of 750° F.
- **HIGH TENSILE STRENGTH *ALUMINUM** – Bar Stock Components precision machined. Points of impact designed for extra strength.
- **RADSOK® HIGH AMPERAGE CONTACTS** – Special arrangements are available with RADSOK high amperage contacts. Standard Star-line inserts are not interchangeable with new RADSOK contact insert arrangements.
- **RoHS COMPLIANT PRODUCT AVAILABLE** – Consult Amphenol Industrial Operations.



STAR-LINE® EX Series



The Star-Line EX Series is a hybrid form of the parent Starline product line. The series is certified for use in a Zone 1-IIc hazardous environment. Classified facilities such as petrochemical refineries, land and offshore drilling systems are but a few of the applications for this broad product series.

- **ATEX CERTIFIED** – for Zone 1-IIc hazardous environment. For certificate contact factory
- **IECEX CERTIFIED** – For certificate contact factory
- **CENELEC IP68-8 RATED** – Listed under EEx d IIc T6. Plugs and receptacles listed under EEx de IIc T6.
- **HARD ANODIC COATING** – All machined aluminum parts finished with a hard, scratch-resistant coating per MIL-A-8625, Type III. Dielectric strength 1800 volts. Heat resistance of 750° F.
- **SOLDER, CRIMP AND PRESSURE TERMINALS AVAILABLE**
- **REVERSIBLE INSERTS** – A full range of contact inserts for power, signal and mixed applications are available. All are interchangeable and reversible to suit specific needs.
- **EASILY ACCESSIBLE WIRE TERMINALS** – Conductors are readily terminated to contacts. Cable housings are slipped over conductors or leads after terminating. Cumbersome handling and seating of inserts with conductors attached is eliminated.
- **LARGE WIRING SPACE** – Ample wiring space is provided in cable housings and hardware.
- **HIGH TENSILE STRENGTH ALUMINUM** – Bar Stock Components precision machined. Points of impact designed for extra strength.
- **CABLE OPTIONS** – Starline EX Series can be terminated onto unarmored or armored and sheathed cables built to IEEE-45 / UL1309, IEC, BS, DIN and JIC standards. Flexible cables like SOOW-A, W, G-GC and DLO constructions can also be used with this Series.
- **EX CABLE GLANDS** – Wide variety of glands are available for Star-Line EX connectors. For more information ask for new Amphenol Cable Glands and Cord Grips catalog 12-055.
- **INSERT VARIETY** – A broad range of inserts are offered ranging from single-contact to 143 contacts. High amperage up to 1135 amps at 1000V / AC or DC. Contacts are high quality copper with silver plating. (Gold plating available as an option) Composite inserts for power, control and instrumentation service available. *For Amphenol Star-Line product insert de-rating information per the National Electric Code, please consult the Amphenol Industrial website, www.amphenol-industrial.com. Chart is located under LITERATURE tab.*
- **RADSOK® HIGH AMPERAGE CONTACTS** – Special arrangements are available with RADSOK high amperage contacts. Standard Star-line EX inserts are not interchangeable with new RADSOK contact insert arrangements.
- **RoHS COMPLIANT PRODUCT AVAILABLE** – Consult Amphenol Industrial Operations



Star-Line EX Series connectors are certified for use in Zone 1-IIc hazardous environment



Star-Line EX Connector with EX gland (EX-13-3 style shown)



Environmental Highlights

PROPERTY	MIL-5015 REQUIREMENTS CLASSES A, B, E J & R	STAR-LINE, STAR-LOK CONNECTORS
TEMPERATURE	-67° F to 225° F (-55° C to 107° C)	Temperature Classes A, B, E, J and R can withstand 257° F continuously. For short duration high-temperature life, consult factory.
PRESSURE	No requirement	300 PSI external (coupled connectors) 200 PSI internal (with pin and socket inserts)
AIR LEAKAGE	1 cubic inch/hour maximum	Exceeds Classes E and R specifications
HUMIDITY AND MOISTURE RESISTANCE	1 1/2 times A.C. voltage rating after 14 days. Exposure to 95% relative humidity at 160° F.	Exceeds Classes E and R. MIL-5015 Meets MIL-STD-202B, Method 106A
CORROSION RESISTANCE	48 Hours – Method 1001 MIL-STD-1344 No exposure of base metal.	Salt spray: 300 days – No exposure of base metal.
CHEMICAL RESISTANCE	No requirement	Oil, most acids and alkalis.
DUST RESISTANCE	No requirement	Meets MIL-STD-202B, Method 110, Condition B
SHOCK RESISTANCE	50 G minimum	Exceeds 60 G's Certain inserts available to 200 G.
VIBRATION	Method 2005 Method II MIL-STD-1344	Exceeds Method II & MIL-STD-167-1 (Ships).
TEST PROBE ABUSE	Contact size No. 16 and No. 18	Exceeds MIL-5015 on all contacts No. 18 through 4/0.

Why the Double-Lead Acme Thread?

The double-lead Acme thread is a moderate torque quick-coupling thread which permits complete coupling in approximately one turn of the coupling nut. In addition, there are actually two parallel threads having starting points 180 degrees apart. All of this ensures that plugs and receptacles are being mated or unmated axially. The thread contour makes it self-cleaning.

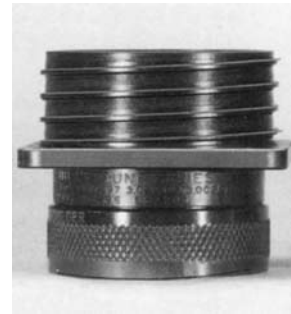

One parallel thread removed to show actual thread angle.

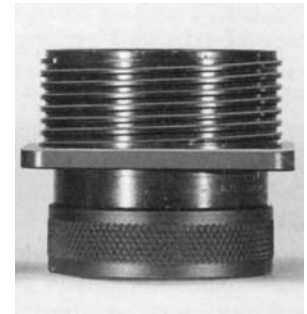

Standard double-lead Acme. Two parallel threads.

Wire Limitation Guide

There are restrictions to the maximum diameter of wire as they relate to the rear or wire side of the connector insert as follows.

Mod I. When wires are passed through the rigid back insulation for ease of soldering:

Wire size	Maximum diameter
#4/0	.747"
#1/0	.555"
#4	.400"
#8	.262"
#10	.201"
#12	.150"
#16	.107"
#18	.086"
Mod II & III	
#10	.248"
#12	.193"
#16	.130"
#18	.110"

MOD I Captive Contact Inserts

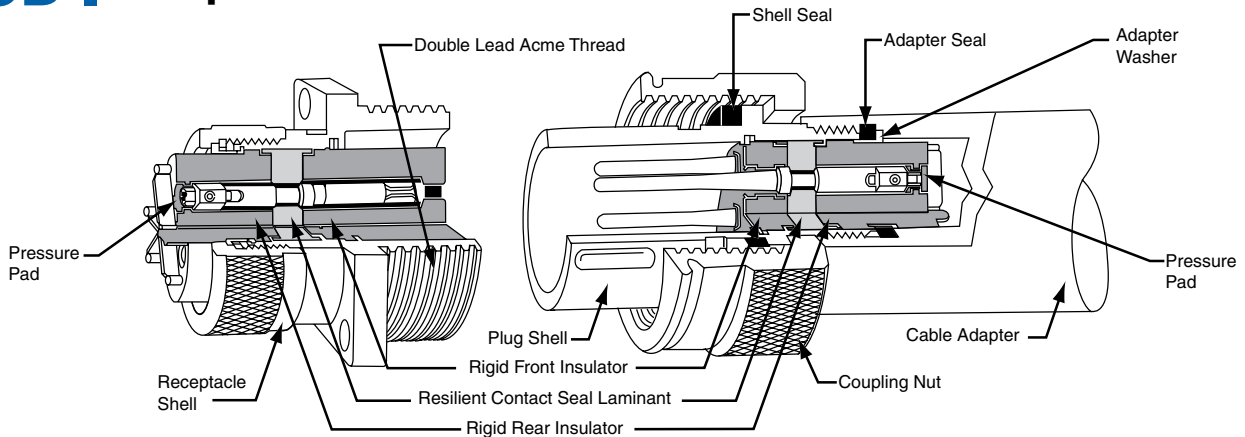

Self-sealing Construction: all MOD I captive contact inserts are capable of being terminated after assembly in the basic barrel and are completely self-sealing when pressurized by any selected adapter. Water, gas, vapor, moisture or dust positively cannot pass in either direction through or around the insulation. The “sandwich” construction of MOD I inserts consists of a resilient silicone laminate between two rigid plastic insulators. The resilient laminate seals absorbs shock and vibration and allows the contacts to align themselves freely. The rigid faced plastic insulators impart just the right amount of restraint to retain the contacts in place.

The combined “sandwich” provides all the advantages of resilient mounting plus all the advantages of rigid mounting, with none of the shortcomings of either. Under pressure, between a shoulder and a thrust washer, the silicone reacts as a fluid and being non-compressible, flows against all surfaces to affect a reliable seal around the periphery of the insert and around all contacts where they penetrate the insulation. Contact cavities are clearly numbered on the front and rear insert face to facilitate identification during assembly, inspection and maintenance. Socket insulator contact cavities are of a bellmouth guided entry design. These chamfered lead-ins insure easy and positive mating of male contacts.

MOD II Insertable/Removable Crimp Contact Inserts

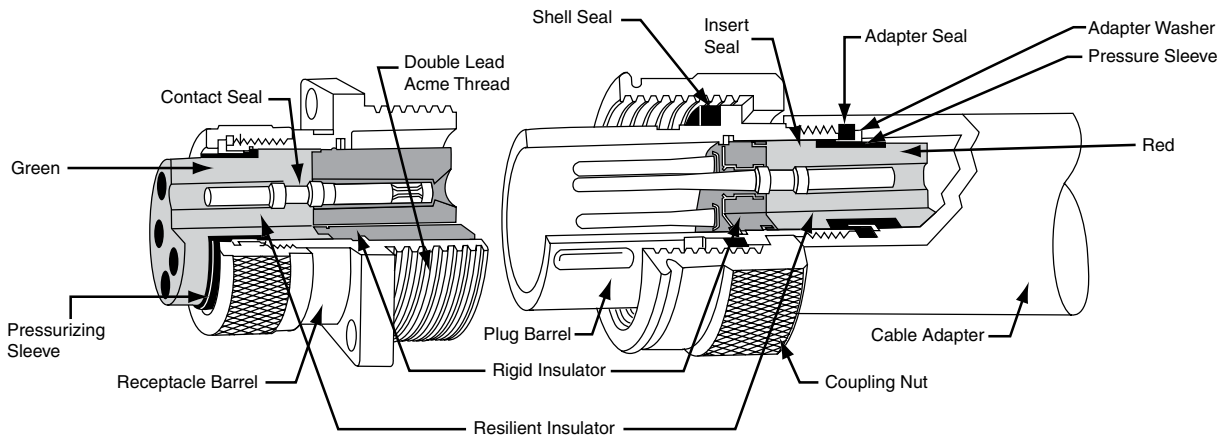

MOD II insulations have one less rigid disc than their MOD I counterparts.

Individual unmounted contacts are crimped to their respective wires outside of the connector where ample working space is available. The crimping operation can be by hand or power operated tool.

Contacts with crimped joint intact are inserted one by one, with a hand tool, into the insulation premounted within the connector barrel shell.

The resilient portion of the insert functions to seal around the contacts and prevent leakage through contact cavities, seal

against leakage between the insert and shell, absorb shock and vibration, provide electrical insulation between contacts and retain the contacts in the connector.

Contacts may be inserted and removed without degradation of the retention or environmental capability. The front rigid portion of the insert functions to stabilize and ensure positive alignment of the contacts.

Contact cavities are clearly numbered on the front and rear insert face to facilitate identification during assembling, inspection and maintenance. Socket insulator contact cavities are of a bellmouth guided entry design. These chamfered lead-ins ensure easy and positive mating of male contacts.

Custom Build Your Own Connectors

Power Connectors – 20-30-60-100-200-325-700 Amperes, 1 thru 10 Contacts

Control & Instrumentation Connectors – 3 thru 143 Contacts

The following pages present connector sub-assemblies which are available and can be used in conjunction with the inserts listed.

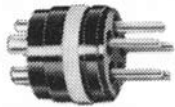

PIN INSERT
CONFIGURATION



PLUG
CONFIGURATION



RECEPTACLE
CONFIGURATION

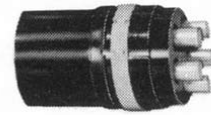

SOCKET INSERT
CONFIGURATION

Ordering Information

All plug and receptacle assemblies require two part numbers:

- A. The catalog number of the desired insert.
- B. The catalog number of the selected plug or receptacle hardware.

To Order Complete Assemblies

1. Determine supply voltage, amperage and number of contacts desired.
2. Select insert configuration from pages 37-63. Write down Dash Number, Shell Size and MOD number of insert. Voltage and amperage information can be found on page 30. Example: 3#12 contacts – 27P (MALE) and 27S (FEMALE); MOD I; Shell Size 12 (page 37).
3. Select desired plug and receptacle hardware from pages 9-28. Make certain that the shell size of the hardware corresponds with the shell size of the desired insert. Determine outside diameter of cable. Example: Male Plug with Basket Weave. Cable is 3 conductor #12 (.635 outside diameter). ZPLK-1212-27P (page 15).

Female Receptacle mounted to Junction Box with 45° Angle Adapter and 1" Conduit Hub. ZRLBB-312-27S (page 23).

4. Order tools from pages 76-77.

To Order Assemblies Without The Insert

(For large users stocking connector components in bulk)

1. If a MOD I insert will be used, order the hardware by the catalog number and eliminate the asterisk. Example: ZPLD-1212 (page 12).
2. If a MOD II insert will be used, order by the catalog number but substitute a 200 for the asterisk. Example: ZPLD-1212-200
3. MOD III inserts must be ordered assembled in their basic barrel (consult Amphenol Industrial Operations).

Please Read Carefully:

- Hardware with a longer cable housing should be used if the insert has:
 - Any pressure contact – line or ground.
 - More than 10 contacts-any size.
 - More than 4 #10 or larger contacts.
- A jack coupling nut should be used if the insert has:
 - A configuration with shorter relay contacts.
 - A configuration of 37 or more contacts.

A JACK COUPLING NUT SHOULD NOT BE USED ON ANY POWER INSERT CONNECTOR THAT IS TO BE DISCONNECTED UNDER LOAD

- To insure proper coupling the following torque values should be used on the coupling nut:

Shell Size	Torque Setting (lb. ft.)
12	11.0
16	13.5
20	15.5
C20	15.5
24	23.0
C24	23.0
28	31.0
C28	31.0

NOTE: The N.E.C. circuit breaking and non-circuit breaking ratings are based on test results of contacts and connectors. Consult the N.E.C. when selecting wire/cable for specific applications. Under certain conditions, a wire size may be rated higher or lower than our table indicates for a given contact size.

Connector Assemblies

Typical MOD I Plug Components

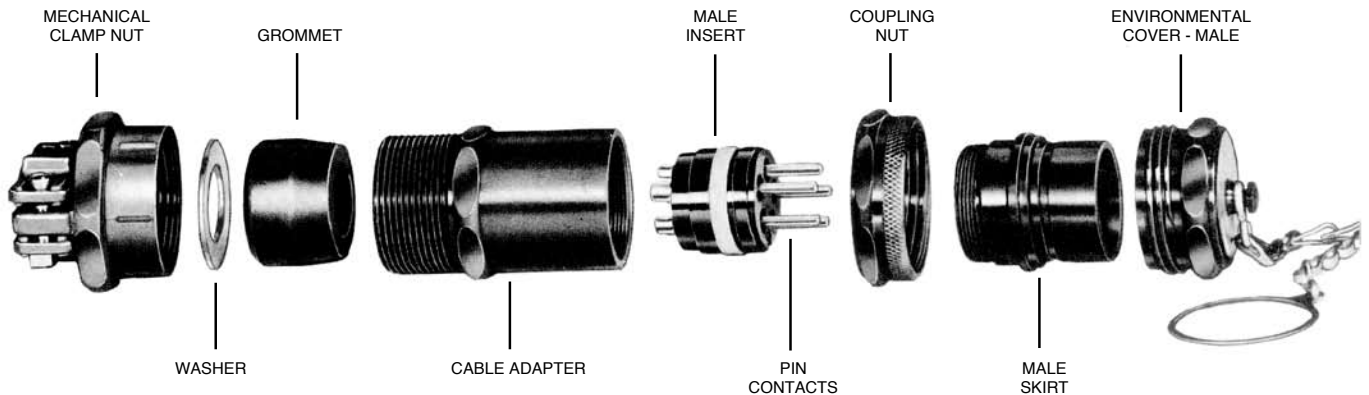

Typical MOD I Receptacle Components

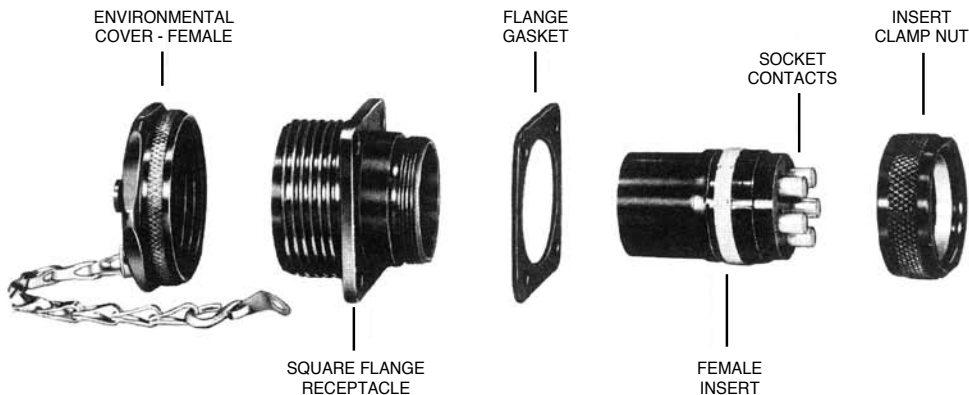

Connector Basic Components

STAR-LINE Assembly

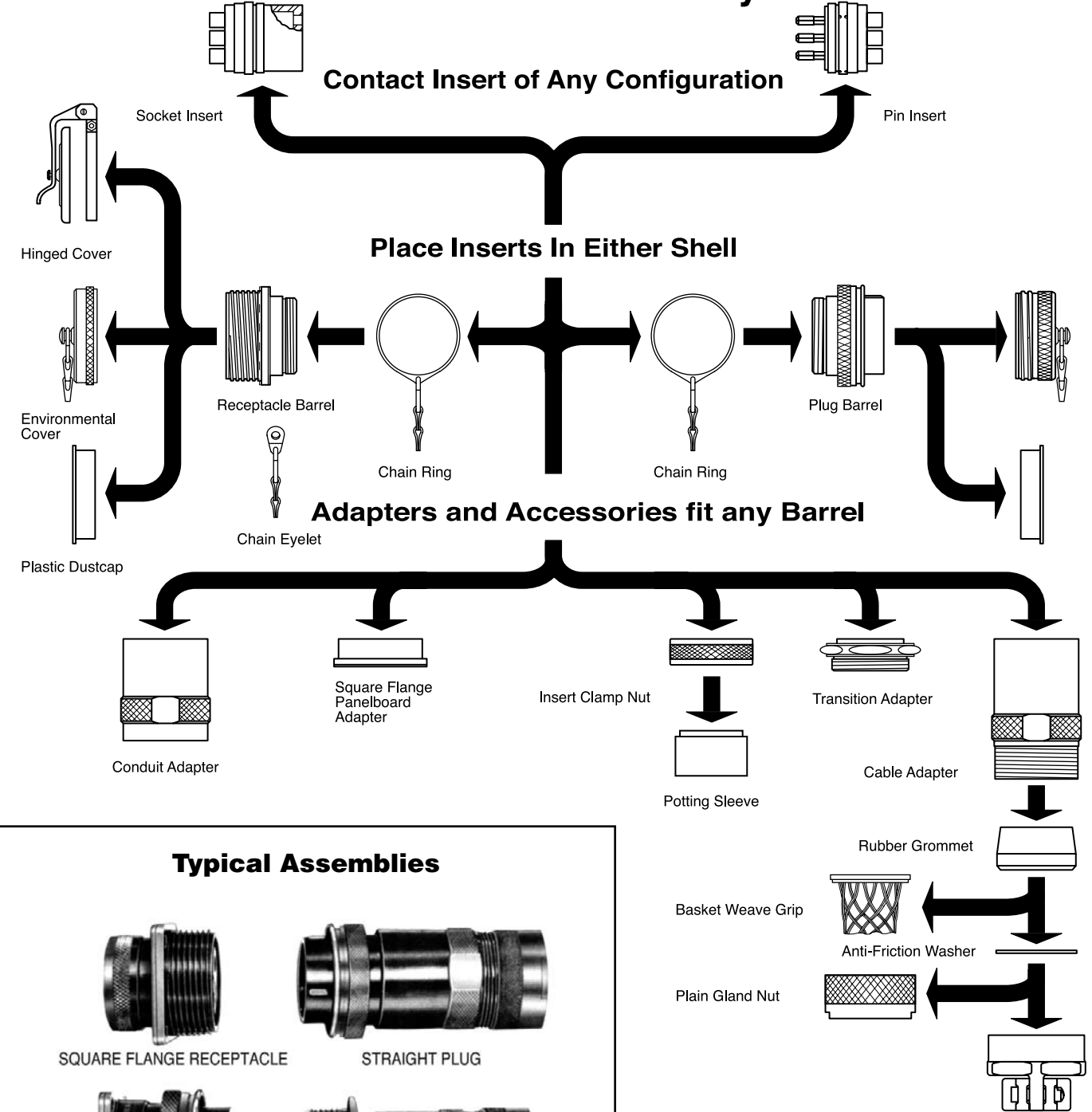

Code Logic Star-Line Series

Cable Mounted Connectors

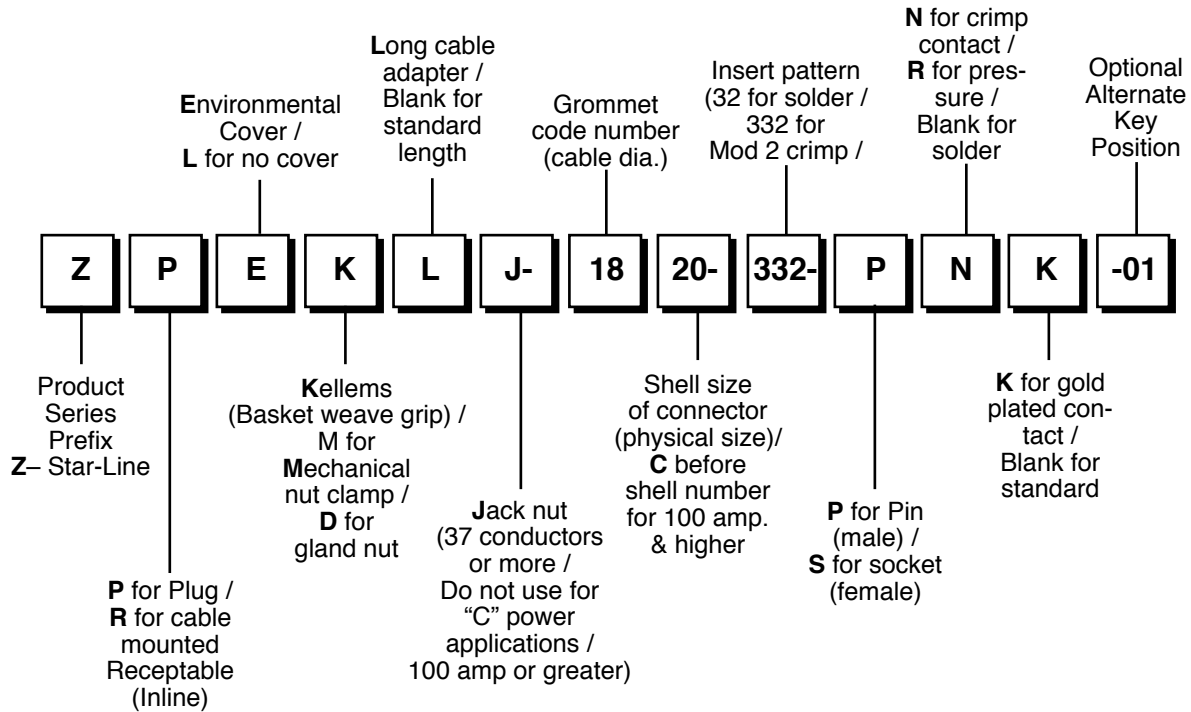

Fixed Connectors

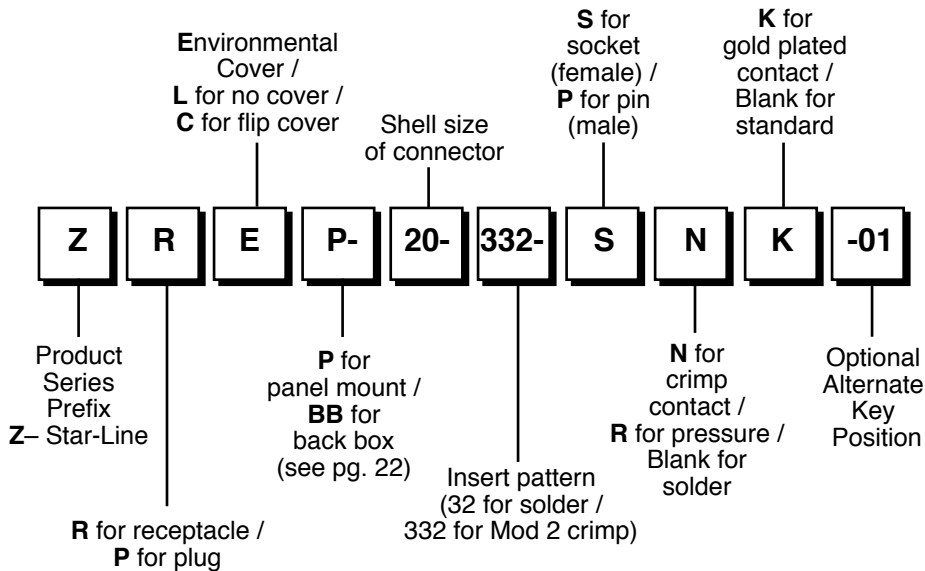

RoHS COMPLIANT PRODUCT AVAILABLE – Consult Amphenol Industrial Operations.



Straight Plug With Standard Compression Nut

To specify a complete plug, substitute the Dash No. of the contact insert selected, for the Asterisk (*) in the Catalog No. below.



**Types
ZPLD ZPED**

Size Cable	Shell Size	Cat. No. With Standard Coupling Nut	DIMENSIONS WITH STANDARD CABLE ADAPTER			Catalog No. With Jack Coupling Nut	
			A	B	C		
Select from Table Below and Substitute Symbol No. for Delta▲	12	ZPLD-▲-12-*	5-3/8	1-13/16	5-31/32	ZPLDJ-▲-12-*	
	16	ZPLD-▲-16-*	5-5/8	2-5/16	5-7/32	ZPLDJ-▲-16-*	
	20	ZPLD-▲-20-*	6-1/8	2-13/16	6-23/32	ZPLDJ-▲-20-*	
	C20	ZPLD-▲-C20-*	6-5/8	2-13/16	7-7/32	ZPLDJ-▲-C20-*	
	24	ZPLD-▲-24-*	6-5/8	3-5/16	7-7/32	ZPLDJ-▲-24-*	
	C24	ZPLD-▲-C24-*	7-1/8	3-5/16	7-23/32	ZPLDJ-▲-C24-*	
	28	ZPLD-▲-28-*	7-1/8	3-13/16	7-23/32	ZPLDJ-▲-28-*	
	C28	ZPLD-▲-C28-*	7-5/8	3-13/16	8-7/32	ZPLDJ-▲-C28-*	
	WITH LONG CABLE ADAPTER						
	12	ZPLDL-▲-12-*	7-5/8	1-13/16	8-7/32	ZPLDLJ-▲-12-*	
16	ZPLDL-▲-16-*	7-7/8	2-5/16	8-15/32	ZPLDLJ-▲-16-*		
20	ZPLDL-▲-20-*	8-3/8	2-13/16	8-31/32	ZPLDLJ-▲-20-*		
C20	ZPLDL-▲-C20-*	8-7/8	2-13/16	9-15/32	ZPLDLJ-▲-C20-*		
24	ZPLDL-▲-24-*	8-7/8	3-5/16	9-15/32	ZPLDLJ-▲-24-*		
C24	ZPLDL-▲-C24-*	9-3/8	3-5/16	9-31/32	ZPLDLJ-▲-C24-*		
28	ZPLDL-▲-28-*	9-1/8	3-13/16	9-23/32	ZPLDLJ-▲-28-*		
C28	ZPLDL-▲-C28-*	9-5/8	3-13/16	10-7/32	ZPLDLJ-▲-C28-*		

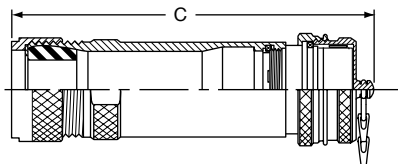
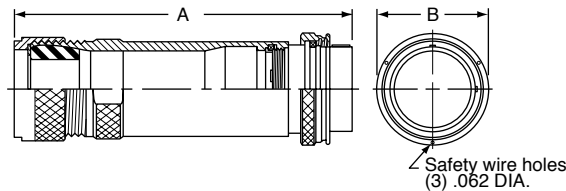

To specify plug with environmental cover, change third letter in Part No. "L" to "E". Example: ZPLD changes to ZPED.



OIL-RESISTANT RUBBER GROMMETS—SYMBOL NUMBERS OF SIZES AVAILABLE Substitute the symbol number for the Delta ▲ in the catalog number of plug. Example: ZPLD-▲-12-* for .500 to .625 Dia. Cable changes to ZPLD-10 12-*

Cable Dia.	Shell 12	Shell 16	Shells 20 & C20	Shells 24 & C24	Shells 28 & C28	Cable Dia.	Shell 12	Shell 16	Shell 20 & C20	Shells 24 & C24	Shells 28 & C28
.062 to .125	02	-	-	-	-	1.500 to 1.625	-	-	26	26	26
.125 to .250	04	-	-	-	-	1.625 to 1.750	-	-	28	28	28
.250 to .375	06	06	-	-	-	1.750 to 1.875	-	-	30	30	30
.375 to .500	08	08	-	-	-	1.875 to 1.937	-	-	31	-	-
.500 to .625	10	10	10	-	-	1.937 to 2.000	-	-	-	32	32
.625 to .750	12	12	12	-	-	2.000 to 2.125	-	-	-	34	34
.750 to .875	14	14	14	-	-	2.125 to 2.250	-	-	-	36	36
.875 to .937	15	-	-	-	-	2.250 to 2.375	-	-	-	38	38
.937 to 1.000	-	16	16	16	-	2.375 to 2.437	-	-	-	39	-
1.000 to 1.125	-	18	18	18	-	2.437 to 2.500	-	-	-	-	40
1.125 to 1.250	-	20	20	20	-	2.500 to 2.625	-	-	-	-	42
1.250 to 1.375	-	22	22	22	-	2.625 to 2.750	-	-	-	-	44
1.375 to 1.437	-	23	-	-	-	2.750 to 2.875	-	-	-	-	46
1.437 to 1.500	-	-	24	24	24						

Straight Plug With Mechanical Clamp Nut



To specify a complete plug, substitute the Dash No. of the contact insert selected, for the Asterisk (*) in the Catalog No. below.

Types ZPLM ZPEM

Size Cable	Shell Size	Cat. No. With Standard Coupling Nut	DIMENSIONS WITH STANDARD CABLE ADAPTER					Catalog No. With Jack Coupling Nut	
			A	B	C	D	E		
Select from Table Below and Substitute Symbol No. for Delta▲	12	ZPLM-▲-12-*	6-1/8	1-13/16	6-23/32	2-3/8	1-3/4	ZPLMJ-▲-12-*	
	16	ZPLM-▲-16-*	6-7/16	2-5/16	7-1/32	3	2-1/4	ZPLMJ-▲-16-*	
	20	ZPLM-▲-20-*	7	2-13/16	7-19/32	3-3/4	2-3/4	ZPLMJ-▲-20-*	
	C20	ZPLM-▲-C20-*	7-1/2	2-13/16	8-3/32	3-3/4	2-3/4	ZPLMJ-▲-C20-*	
	24	ZPLM-▲-24-*	7-9/16	3-5/16	8-5/32	4-1/2	3-1/4	ZPLMJ-▲-24-*	
	C24	ZPLM-▲-C24-*	8-1/16	3-5/16	8-21/32	4-1/2	3-1/4	ZPLMJ-▲-C24-*	
	28	ZPLM-▲-28-*	8-1/8	3-13/16	8-23/32	5-1/8	3-3/4	ZPLMJ-▲-28-*	
	C28	ZPLM-▲-C28-*	8-5/8	3-13/16	9-7/32	5-1/8	3-3/4	ZPLMJ-▲-C28-*	
	WITH LONG CABLE ADAPTER								
	12	ZPLML-▲-12-*	8-3/8	1-13/16	8-31/32	2-3/8	1-3/4	ZPLMLJ-▲-12-*	
16	ZPLML-▲-16-*	8-11/16	2-5/16	9-9/32	3	2-1/4	ZPLMLJ-▲-16-*		
20	ZPLML-▲-20-*	9-1/4	2-13/16	9-27/32	3-3/4	2-3/4	ZPLMLJ-▲-20-*		
C20	ZPLML-▲-C20-*	9-3/4	2-13/16	10-11/32	3-3/4	2-3/4	ZPLMLJ-▲-C20-*		
24	ZPLML-▲-24-*	9-13/16	3-5/16	10-13/32	4-1/2	3-1/4	ZPLMLJ-▲-24-*		
C24	ZPLML-▲-C24-*	10-5/16	3-5/16	10-29/32	4-1/2	3-1/4	ZPLMLJ-▲-C24-*		
28	ZPLML-▲-28-*	10-1/8	3-13/16	10-23/32	5-1/8	3-3/4	ZPLMLJ-▲-28-*		
C28	ZPLML-▲-C28-*	10-5/8	3-13/16	11-7/32	5-1/8	3-3/4	ZPLMLJ-▲-C28-*		

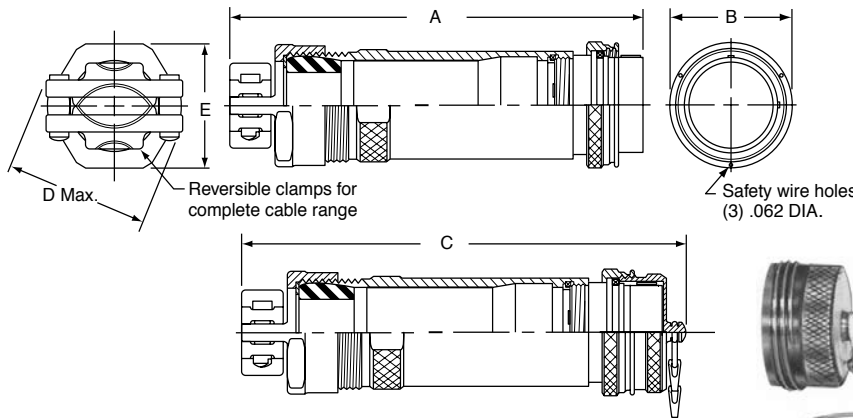

To specify plug with environmental cover, change third letter in Part No. "L" to "E". Example: ZPLM changes to ZPEM.

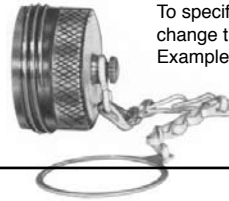

OIL-RESISTANT RUBBER GROMMETS—SYMBOL NUMBERS OF SIZES AVAILABLE Substitute the symbol number for the Delta ▲ in the catalog number of plug. Example: ZPLM-▲-12-* for .500 to .625 Dia. Cable changes to ZPLM-10 12-*

Cable Dia.	Shell					Cable Dia.	Shell				
	12	16	20 & C20	24 & C24	28 & C28		12	16	20 & C20	24 & C24	28 & C28
.062 to .125	02	-	-	-	-	1.500 to 1.625	-	-	26	26	26
.125 to .250	04	-	-	-	-	1.625 to 1.750	-	-	28	28	28
.250 to .375	06	06	-	-	-	1.750 to 1.875	-	-	30	30	30
.375 to .500	08	08	-	-	-	1.875 to 1.937	-	-	31	-	-
.500 to .625	10	10	10	-	-	1.875 to 2.000	-	-	-	32	32
.625 to .750	12	12	12	-	-	2.000 to 2.125	-	-	-	34	34
.750 to .875	14	14	14	-	-	2.125 to 2.250	-	-	-	36	36
.875 to .937	15	-	-	-	-	2.250 to 2.375	-	-	-	38	38
.875 to 1.000	-	16	16	16	-	2.375 to 2.437	-	-	-	39	-
1.000 to 1.125	-	18	18	18	-	2.375 to 2.500	-	-	-	-	40
1.125 to 1.250	-	20	20	20	-	2.500 to 2.625	-	-	-	-	42
1.250 to 1.375	-	22	22	22	-	2.625 to 2.750	-	-	-	-	44
1.375 to 1.437	-	23	-	-	-	2.750 to 2.875	-	-	-	-	46
1.375 to 1.500	-	-	24	24	24						

Straight Plug

With Conduit Adapter (for flexible conduit fittings)

To specify a complete plug, substitute the dash no. of the contact insert selected for the asterisk (*) in the catalog no. below.

A PLUG WITH JACK COUPLING NUT SHOULD BE USED WITH INSERTS HAVING 37 OR MORE CONTACTS.



Types
ZPLT ZPET

Shell Size	Size Conduit	Catalog No. With Standard Coupling Nut	DIMENSIONS				Catalog No. With Jack Coupling Nut
			A	B	C	D	
12	3/4	ZPLT-2 12-*	4-1/4	1-13/16	4-27-32	3/4	ZPLTJ-2 12-*
16	1-1/4	ZPLT-4 16-*	4-3/8	2-5/16	4-31/32	1-1/4	ZPLTJ-4 16-*
20	1-1/2	ZPLT-5 20-*	4-1/2	2-13/16	5-3/32	1-1/2	ZPLTJ-5 20-*
C20	1-1/2	ZPLT-5 C20-*	5	2-13/16	5-19/32	1-1/2	ZPLTJ-5 C20-*
24	2	ZPLT-6 24-*	4-5/8	3-5/16	5-7/32	2	ZPLTJ-6 24-*
C24	2	ZPLT-6 C24-*	5-1/8	3-5/16	5-23/32	2	ZPLTJ-6 C24-*
28	2-1/2	ZPLT-7 28-*	5-3/32	3-13/16	5-11/16	2-1/2	ZPLTJ-7 28-*
C28	2-1/2	ZPLT-7 C28-*	5-19/32	3-13/16	6-3/16	2-1/2	ZPLTJ-7 C28-*

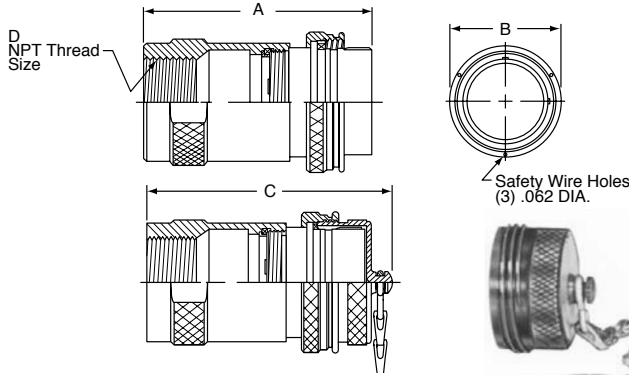

To specify plug with environmental cover, change third letter in Part No. "L" to "E".
Example: ZPLT changes to ZPET.



Straight Male Plug

Panel Mount

To specify a complete plug, substitute the dash no. of the contact insert selected for the asterisk (*) in the catalog no. below.

A PLUG WITH JACK COUPLING NUT SHOULD BE USED WITH INSERTS HAVING 37 OR MORE CONTACTS.



Types
ZPLP ZPEP

Shell Size	Open Back	Catalog No. With Standard Coupling Nut	DIMENSIONS						Catalog No. With Jack Coupling Nut
			A	B	C	G	H	J	
12	Use with or without Potting Sleeve	ZPLP-12-*	2-3/8	1-13/16	2-31/32	1-17/64	1-5/8	3/16	ZPLPJ- 12-*
16		ZPLP-16-*	2-13/32	2-5/16	3	1-11/16	2-1/8	7/32	ZPLPJ- 16-*
20		ZPLP-20-*	2-7/16	2-13/16	3-1/32	2-3/32	2-5/8	9/32	ZPLPJ- 20-*
C20		ZPLP-C20-*	2-15/16	2-13/16	3-17/32	2-3/32	2-5/8	9/32	ZPLPJ- C20-*
24		ZPLP-24-*	2-15/32	3-5/16	3-1/16	2-17/32	3-1/8	11/32	ZPLPJ- 24-*
C24		ZPLP-C24-*	2-31/32	3-5/16	3-9/16	2-17/32	3-1/8	11/32	ZPLPJ- C24-*
28		ZPLP-28-*	2-15/32	3-13/16	3-1/16	3-1/32	3-3/4	11/32	ZPLPJ- 28-*
C28		ZPLP-C28-*	2-31/32	3-13/16	3-9/16	3-1/32	3-3/4	11/32	ZPLPJ- C28-*

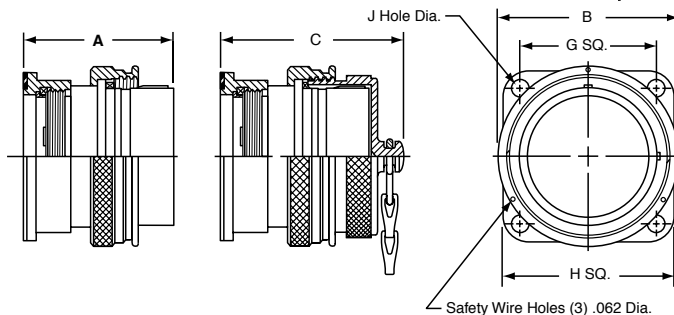

To specify plug with environmental cover, change third letter in Part No. "L" to "E".
Example: ZPLP changes to ZPEP.



Straight Plug With Basketweave Cable Grip

To specify a complete plug, substitute the Dash No. of the contact insert selected for the asterisk (*) in the catalog no.
A PLUG WITH JACK COUPLING NUT SHOULD BE USED WITH INSERTS HAVING 37 OR MORE CONTACTS



Types
ZPLK ZPEK

Size Cable	Shell Size	Catalog No. With Standard Coupling Nut	DIMENSIONS			Catalog No. With Jack Coupling Nut	
			WITH STANDARD CABLE ADAPTER				
			A	B	C		
Select from Table Below and Substitute Symbol No. for Delta ▲	12	ZPLK-▲-12-*	5-3/8	1-13/16	5-31/32	ZPLKJ-▲-12-*	
	16	ZPLK-▲-16-*	5-5/8	2-5/16	6-7/32	ZPLKJ-▲-16-*	
	20	ZPLK-▲-20-*	6-1/8	2-13/16	6-23/32	ZPLKJ-▲-20-*	
	C20	ZPLK-▲-C20-*	6-5/8	2-13/16	7-7/32	ZPLKJ-▲-C20-*	
	24	ZPLK-▲-24-*	6-5/8	3-5/16	7-7/32	ZPLKJ-▲-24-*	
	C24	ZPLK-▲-C24-*	7-1/8	3-5/16	7-23/32	ZPLKJ-▲-C24-*	
	28	ZPLK-▲-28-*	7-1/8	3-13/16	7-23/32	ZPLKJ-▲-28-*	
	C28	ZPLK-▲-C28-*	7-5/8	3-13/16	8-7/32	ZPLKJ-▲-C28-*	
	WITH LONG CABLE ADAPTER						
	12	ZPLKL-▲-12-*	7-5/8	1-13/16	8-7/32	ZPLKJ-▲-12-*	
	16	ZPLKL-▲-16-*	7-7/8	2-5/16	8-15/32	ZPLKJ-▲-16-*	
	20	ZPLKL-▲-20-*	8-3/8	2-13/16	8-31/32	ZPLKJ-▲-20-*	
	C20	ZPLKL-▲-C20-*	8-7/8	2-13/16	9-15/32	ZPLKJ-▲-C20-*	
	24	ZPLKL-▲-24-*	8-7/8	3-5/16	9-15/32	ZPLKJ-▲-24-*	
C24	ZPLKL-▲-C24-*	9-3/8	3-5/16	9-31/32	ZPLKJ-▲-C24-*		
28	ZPLKL-▲-28-*	9-1/8	3-13/16	9-23/32	ZPLKJ-▲-28-*		
C28	ZPLKL-▲-C28-*	9-5/8	3-13/16	10-7/32	ZPLKJ-▲-C28-*		

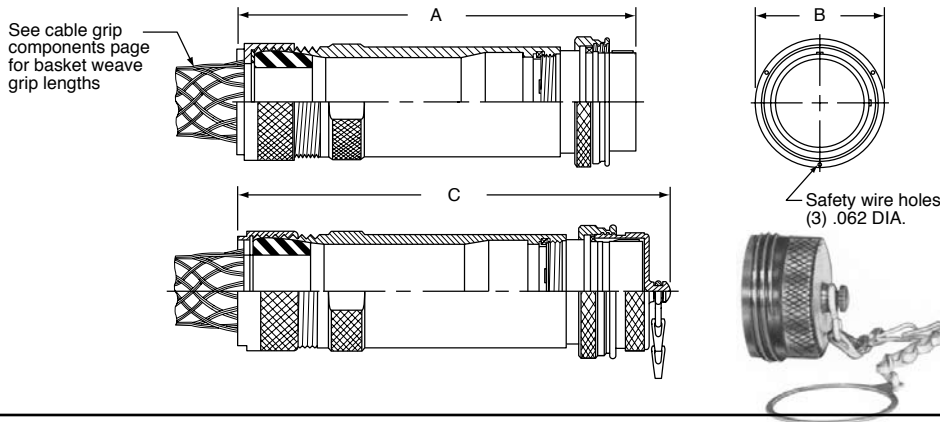

To specify plug with environmental cover, change third letter in Part No. "L" to "E". Example: ZPLK changes to ZPEK.



OIL-RESISTANT RUBBER GROMMETS—SYMBOL NUMBERS OF SIZES AVAILABLE Substitute the symbol number for the Delta ▲ in the catalog number of plug. Example: ZPLK-▲-12-* for .500 to .625 Dia. Cable changes to ZPLK-10 12-*

Cable Dia.	Shell 12	Shell 16	Shells 20 & C20	Shells 24 & C24	Shells 28 & C28	Cable Dia.	Shell 12	Shell 16	Shell 20 & C20	Shells 24 & C24	Shells 28 & C28
.062 to .125	02	—	—	—	—	1.500 to 1.625	—	—	26	26	26
.125 to .250	04	—	—	—	—	1.625 to 1.750	—	—	28	28	28
.250 to .375	06	06	—	—	—	1.750 to 1.875	—	—	30	30	30
.375 to .500	08	08	—	—	—	1.875 to 1.937	—	—	31	—	—
.500 to .625	10	10	10	—	—	1.875 to 2.000	—	—	—	32	32
.625 to .750	12	12	12	—	—	2.000 to 2.125	—	—	—	34	34
.750 to .875	14	14	14	—	—	2.125 to 2.250	—	—	—	36	36
.875 to .937	15	—	—	—	—	2.250 to 2.375	—	—	—	38	38
.875 to 1.000	—	16	16	16	—	2.375 to 2.437	—	—	—	39	—
1.000 to 1.125	—	18	18	18	—	2.437 to 2.500	—	—	—	—	40
1.125 to 1.250	—	20	20	20	—	2.500 to 2.625	—	—	—	—	42
1.250 to 1.375	—	22	22	22	—	2.625 to 2.750	—	—	—	—	44
1.375 to 1.437	—	23	—	—	—	2.750 to 2.875	—	—	—	—	46
1.375 to 1.500	—	—	24	24	24						

In-Line Receptacle With Mechanical Clamp Nut

To specify a complete receptacle, substitute the dash no. of the contact insert selected for the asterisk (*) in the catalog no. below.



Types
ZRLM ZREM

Size Cable	Shell Size	Cat. No.	DIMENSIONS					
			A	C	D	E	F	G
Select from Table Below and Substitute Symbol No. for Delta ▲	12	ZRLM-▲-12-*	6-1/8	6-3/4	1-3/4	1-61/64	1-3/4	2-3/8
	16	ZRLM-▲-16-*	6-7/16	7-1/16	2-1/4	2-31/64	2-1/4	3
	20	ZRLM-▲-20-*	7	7-5/8	2-3/4	3-1/32	2-3/4	3-3/4
	C20	ZRLM-▲-C20-*	7-1/2	8-1/8	2-3/4	3-1/32	2-3/4	3-3/4
	24	ZRLM-▲-24-*	7-9/16	8-3/16	3-1/4	3-9/16	3-1/4	4-1/2
	C24	ZRLM-▲-C24-*	8-1/16	8-11/16	3-1/4	3-9/16	3-1/4	4-1/2
	28	ZRLM-▲-28-*	8-1/8	8-3/4	3-3/4	4-1/16	3-3/4	5-1/8
	C28	ZRLM-▲-C28-*	8-5/8	9-1/4	3-3/4	4-1/16	3-3/4	5-1/8
	WITH LONG CABLE ADAPTER							
12	ZRLML-▲-12-*	8-3/8	9	1-3/4	1-61/64	1-3/4	2-3/8	
16	ZRLML-▲-16-*	8-11/16	9-5/16	2-1/4	2-31/64	2-1/4	3	
20	ZRLML-▲-20-*	9-1/4	9-7/8	2-3/4	3-1/32	2-3/4	3-3/4	
C20	ZRLML-▲-C20-*	9-3/4	10-3/8	2-3/4	3-1/32	2-3/4	3-3/4	
24	ZRLML-▲-24-*	9-13/16	10-7/16	3-1/4	3-9/16	3-1/4	4-1/2	
C24	ZRLML-▲-C24-*	10-5/16	10-15/16	3-1/4	3-9/16	3-1/4	4-1/2	
28	ZRLML-▲-28-*	10-1/8	10-3/4	3-3/4	4-1/16	3-3/4	5-1/8	
C28	ZRLML-▲-C28-*	10-5/8	11-1/4	3-3/4	4-1/16	3-3/4	5-1/8	

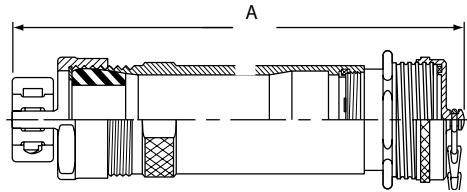
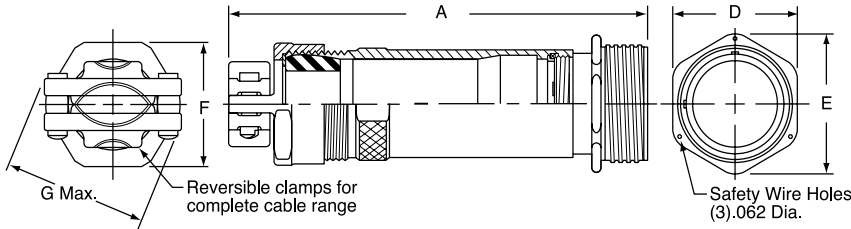

To specify receptacle with threaded environmental cover, change third letter in Part No. "L" to "E".
Example: ZRLM changes to ZREM.



OIL-RESISTANT RUBBER GROMMETS—SYMBOL NUMBERS OF SIZES AVAILABLE

Substitute the symbol number for the Delta ▲ in the catalog number of plug.
Example: ZRLM-▲-12-* for .500 to .625 Dia. cable changes to ZRLM-10-12-*

Cable Dia.	Shell 12	Shell 16	Shells 20 & C20	Shells 24 & C24	Shells 28 & C28	Cable Dia.	Shell 12	Shell 16	Shell 20 & C20	Shells 24 & C24	Shells 28 & C28
.062 to .125	02	-	-	-	-	1.500 to 1.625	-	-	26	26	26
.125 to .250	04	-	-	-	-	1.625 to 1.750	-	-	28	28	28
.250 to .375	06	06	-	-	-	1.750 to 1.875	-	-	30	30	30
.375 to .500	08	08	-	-	-	1.875 to 1.937	-	-	31	-	-
.500 to .625	10	10	10	-	-	1.875 to 2.000	-	-	-	32	32
.625 to .750	12	12	12	-	-	2.000 to 2.125	-	-	-	34	34
.750 to .875	14	14	14	-	-	2.125 to 2.250	-	-	-	36	36
.875 to .937	15	-	-	-	-	2.250 to 2.375	-	-	-	38	38
.875 to 1.000	-	16	16	16	-	2.375 to 2.437	-	-	-	39	-
1.000 to 1.125	-	18	18	18	-	2.437 to 2.500	-	-	-	-	40
1.125 to 1.250	-	20	20	20	-	2.500 to 2.625	-	-	-	-	42
1.250 to 1.375	-	22	22	22	-	2.625 to 2.750	-	-	-	-	44
1.375 to 1.437	-	23	-	-	-	2.750 to 2.875	-	-	-	-	46
1.375 to 1.500	-	-	24	24	24						

In-Line Receptacle

With Standard Compression Nut

To specify a complete receptacle, substitute the dash no. of the contact insert selected for the asterisk (*) in the catalog no. below.

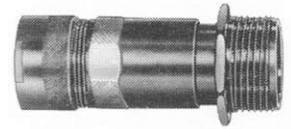

Types
ZRLD ZRED

Size Cable	Shell Size	Cat. No.	Dimensions				
			A	C	D	E	
Select from Table Below and Substitute Symbol No. for Delta ▲	12	ZRLD-▲-12-*	5-3/8	6	1-3/4	1-61/64	
	16	ZRLD-▲-16-*	5-5/8	6-1/4	2-1/4	2-31/64	
	20	ZRLD-▲-20-*	6-1/8	6-3/4	2-3/4	3-1/32	
	C20	ZRLD-▲-C20-*	6-5/8	7-1/4	2-3/4	3-1/32	
	24	ZRLD-▲-24-*	6-5/8	7-1/4	3-1/4	3-9/16	
	C24	ZRLD-▲-C24-*	7-1/8	7-3/4	3-1/4	3-9/16	
	28	ZRLD-▲-28-*	7-1/8	7-3/4	3-3/4	4-1/16	
	C28	ZRLD-▲-C28-*	7-5/8	8-1/4	3-3/4	4-1/16	
	With Long Cable Adapter						
	12	ZRLDL-▲-12-*	7-5/8	8-1/4	1-3/4	1-61/64	
16	ZRLDL-▲-16-*	7-7/8	8-1/2	2-1/4	2-31/64		
20	ZRLDL-▲-20-*	8-3/8	9	2-3/4	3-1/32		
C20	ZRLDL-▲-C20-*	8-7/8	9-1/2	2-3/4	3-1/32		
24	ZRLDL-▲-24-*	8-7/8	9-1/2	3-1/4	3-9/16		
C24	ZRLDL-▲-C24-*	9-3/8	10	3-1/4	3-9/16		
28	ZRLDL-▲-28-*	9-1/8	9-3/4	3-3/4	4-1/16		
C28	ZRLDL-▲-C28-*	9-5/8	10-1/4	3-3/4	4-1/16		

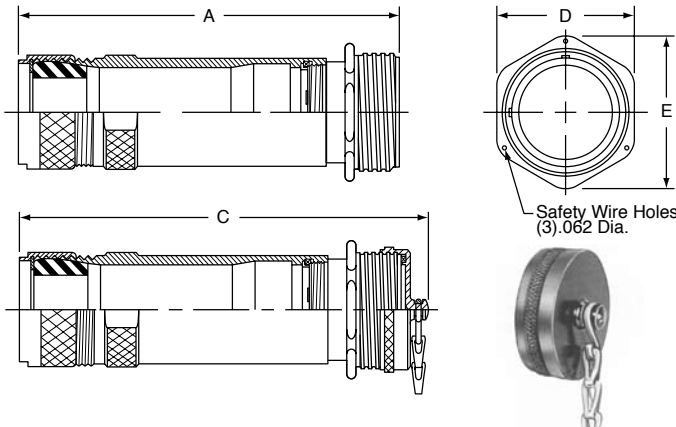

To specify receptacle with threaded environmental cover, change third letter in Part No. "L" to "E".
Example: ZRLD changes to ZRED.



OIL-RESISTANT RUBBER GROMMETS—SYMBOL NUMBERS OF SIZES AVAILABLE

Substitute the symbol number for the Delta ▲ in the catalog number of plug.
Example: ZRLD-▲-12-* for .500 to .625 Dia. cable changes to ZRLD-10 12-*

Cable Dia.	Shell 12	Shell 16	Shells 20 & C20	Shells 24 & C24	Shells 28 & C28	Cable Dia.	Shell 12	Shell 16	Shell 20 & C20	Shells 24 & C24	Shells 28 & C28
.062 to .125	02	—	—	—	—	1.500 to 1.625	—	—	26	26	26
.125 to .250	04	—	—	—	—	1.625 to 1.750	—	—	28	28	28
.250 to .375	06	06	—	—	—	1.750 to 1.875	—	—	30	30	30
.375 to .500	08	08	—	—	—	1.875 to 1.937	—	—	31	—	—
.500 to .625	10	10	10	—	—	1.875 to 2.000	—	—	—	32	32
.625 to .750	12	12	12	—	—	2.000 to 2.125	—	—	—	34	34
.750 to .875	14	14	14	—	—	2.125 to 2.250	—	—	—	36	36
.875 to .937	15	—	—	—	—	2.250 to 2.375	—	—	—	38	38
.875 to 1.000	—	16	16	16	—	2.375 to 2.437	—	—	—	39	—
1.000 to 1.125	—	18	18	18	—	2.437 to 2.500	—	—	—	—	40
1.125 to 1.250	—	20	20	20	—	2.500 to 2.625	—	—	—	—	42
1.250 to 1.375	—	22	22	22	—	2.625 to 2.750	—	—	—	—	44
1.375 to 1.437	—	23	—	—	—	2.750 to 2.875	—	—	—	—	46
1.375 to 1.500	—	—	24	24	24						

In-Line Receptacle

With Basketweave Cable Grip

To specify a complete receptacle, substitute the dash no. of the contact insert selected for the asterisk (*) in the catalog no. below.



Types
ZRLK ZREK

Size Cable	Shell Size	Cat. No.	Dimensions				
			A	C	D	E	
Select from Table Below and Substitute Symbol No. for Delta ▲	12	ZRLK-▲-12-*	5-3/8	6	1-3/4	1-61/64	
	16	ZRLK-▲-16-*	5-5/8	6-1/4	2-1/4	2-31/64	
	20	ZRLK-▲-20-*	6-1/8	6-3/4	2-3/4	3-1/32	
	C20	ZRLK-▲-C20-*	6-5/8	7-1/4	2-3/4	3-1/32	
	24	ZRLK-▲-24-*	6-5/8	7-1/4	3-1/4	3-9/16	
	C24	ZRLK-▲-C24-*	7-1/8	7-3/4	3-1/4	3-9/16	
	28	ZRLK-▲-28-*	7-1/8	7-3/4	3-3/4	4-1/16	
	C28	ZRLK-▲-C28-*	7-5/8	8-1/4	3-3/4	4-1/16	
	With Long Cable Adapter						
	12	ZRLKL-▲-12-*	7-5/8	8-1/4	1-3/4	1-61/64	
	16	ZRLKL-▲-16-*	7-7/8	8-1/2	2-1/4	2-31/64	
	20	ZRLKL-▲-20-*	8-3/8	9	2-3/4	3-1/32	
	C20	ZRLKL-▲-C20-*	8-7/8	9-1/2	2-3/4	3-1/32	
	24	ZRLKL-▲-24-*	8-7/8	9-1/2	3-1/4	3-9/16	
C24	ZRLKL-▲-C24-*	9-3/8	10	3-1/4	3-9/16		
28	ZRLKL-▲-28-*	9-1/8	9-3/4	3-3/4	4-1/16		
C28	ZRLKL-▲-C28-*	9-5/8	10-1/4	3-3/4	4-1/16		

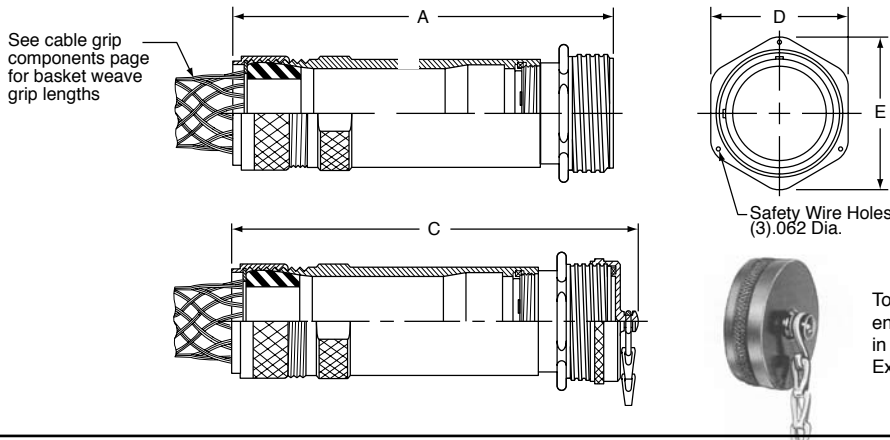

To specify receptacle with threaded environmental cover, change third letter in Part No. "L" to "E".
Example: ZRLK changes to ZREK.



OIL-RESISTANT RUBBER GROMMETS—SYMBOL NUMBERS OF SIZES AVAILABLE

Substitute the symbol number for the Delta ▲ in the catalog number of plug.
Example: ZRLK-▲-12-* for .500 to .625 Dia. cable changes to ZRLK-10 12-*

Cable Dia.	Shell 12	Shell 16	Shells 20 & C20	Shells 24 & C24	Shells 28 & C28	Cable Dia.	Shell 12	Shell 16	Shell 20 & C20	Shells 24 & C24	Shells 28 & C28
.062 to .125	02	-	-	-	-	1.500 to 1.625	-	-	26	26	26
.125 to .250	04	-	-	-	-	1.625 to 1.750	-	-	28	28	28
.250 to .375	06	06	-	-	-	1.750 to 1.875	-	-	30	30	30
.375 to .500	08	08	-	-	-	1.875 to 1.937	-	-	31	-	-
.500 to .625	10	10	10	-	-	1.875 to 2.000	-	-	-	32	32
.625 to .750	12	12	12	-	-	2.000 to 2.125	-	-	-	34	34
.750 to .875	14	14	14	-	-	2.125 to 2.250	-	-	-	36	36
.875 to .937	15	-	-	-	-	2.250 to 2.375	-	-	-	38	38
.875 to 1.000	-	16	16	16	-	2.375 to 2.437	-	-	-	39	-
1.000 to 1.125	-	18	18	18	-	2.437 to 2.500	-	-	-	-	40
1.125 to 1.250	-	20	20	20	-	2.500 to 2.625	-	-	-	-	42
1.250 to 1.375	-	22	22	22	-	2.625 to 2.750	-	-	-	-	44
1.375 to 1.437	-	23	-	-	-	2.750 to 2.875	-	-	-	-	46
1.375 to 1.500	-	-	24	24	24						

In-Line Receptacle

With Conduit Adapter

(for flexible conduit fittings)



Types
ZRLT ZRET

To specify a complete receptacle, substitute the dash no. of the contact insert selected, for the asterisk (*) in the catalog no. below.

To specify receptacle with threaded environmental cover, change third letter in part no. "L" to "E".

Shell Size	Size Conduit	Cat. No.	Dimensions				
			A	B	C	D	E
12	3/4	ZRLT-2 12-*	4-1/4	3/4	4-7/8	1-3/8	1-61/64
16	1-1/4	ZRLT-4 16-*	4-3/8	1-1/4	5	2-1/4	2-15/32
20	1-1/2	ZRLT-5 20-*	4-1/2	1-1/2	5-1/8	2-3/4	3-1/32
C20	1-1/2	ZRLT-5 C20-*	5	1-1/2	5-5/8	2-3/4	3-1/32
24	2	ZRLT-6 24-*	4-5/8	2	5-1/4	3-1/4	3-9/16
C24	2	ZRLT-6 C24	5-1/8	2	5-3/4	3-1/4	3-9/16
28	2-1/2	ZRLT-7 28-*	5-3/32	2-1/2	5-23-32	3-3/4	4-1/16
C28	2-1/2	ZRLT-7 C28-*	5-19/32	2-1/2	6-7/32	3-3/4	4-1/16

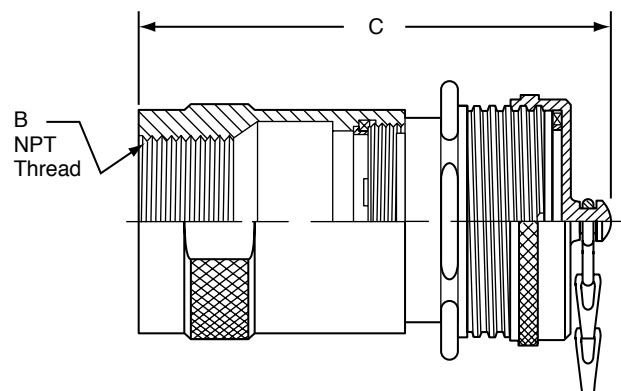
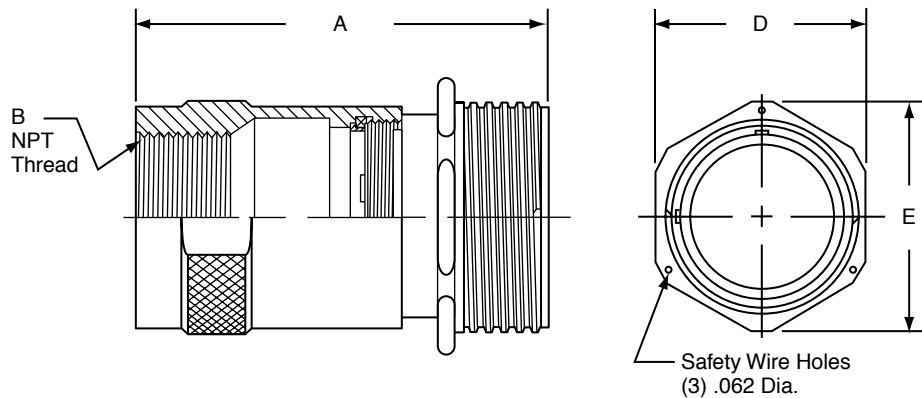

To specify receptacle with threaded environmental cover, change third letter in Part No. "L" to "E".
Example: ZRLT changes to ZRET.

Square Flange Receptacle

To specify a complete receptacle, substitute the dash no. of the contact insert selected, for the asterisk (*) in the catalog no. below.



Types
ZRLP ZRCP ZREP

Shell Size	Open Back	Catalog No.	DIMENSIONS WITH STANDARD CABLE ADAPTER									
			A	B	C*	E	F	G	J	K	L	N
12	Use with or without Potting Sleeves	ZRLP- 12-*	1-3/4	1-3/8	1-1/12	11/64	2-15/16	2-1/8	1	1-11/32	2-21/64	1/4
16		ZRLP- 16-*	2-1/4	1-11/16	2	13/64	2-15/16	2-1/8	1	1-27/32	2-21/64	1/4
20		ZRLP- 20-*	2-3/4	2-3/32	2-1/2	7/32	2-15/16	2-3/16	1	2-11/32	2-21/64	1/4
C20		ZRLP- C20-*	2-3/4	2-3/32	2-1/2	7/32	3-7/16	2-11/16	1-1/2	2-11/32	2-53/64	3/4
24		ZRLP- 24-*	3-1/4	2-17/32	3	9/32	2-15/16	2-3/16	1	2-27/32	2-21/64	1/4
C24		ZRLP- C24-*	3-1/4	2-17/32	3	9/32	3-7/16	2-11/16	1-1/2	2-27/32	2-53/64	3/4
28		ZRLP- 28-*	3-3/4	3-1/32	3-1/2	11/32	2-15/16	2-3/16	1	3-11/32	2-21/64	1/4
C28		ZRLP- C28*	3-3/4	3-1/32	3-1/2	11/32	3-7/16	2-11/16	1-1/2	3-11/32	2-53/64	3/4

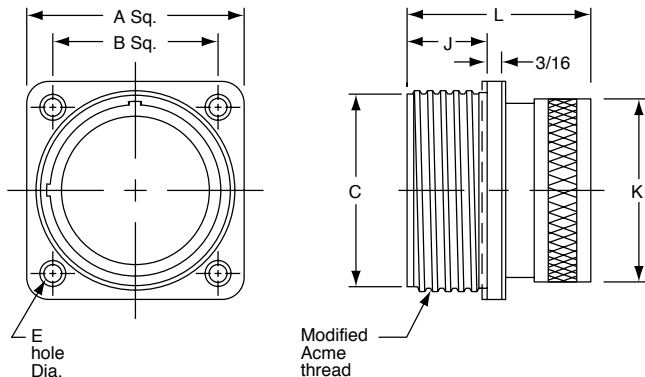

WITH THREADED ENVIRONMENTAL COVER AND SASH CHAIN

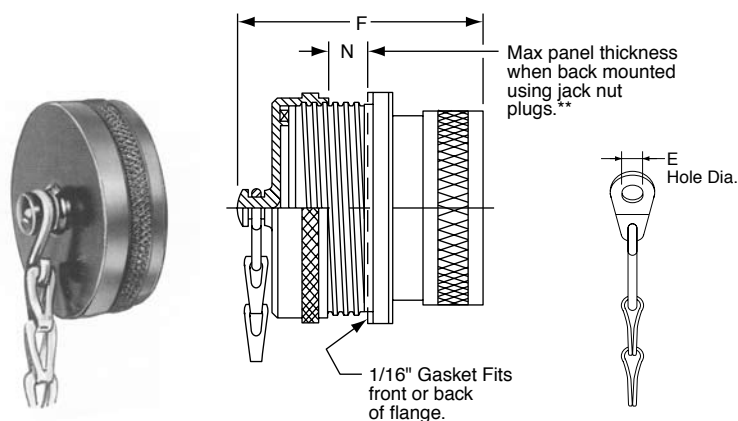

To specify receptacle with threaded environmental cover, change third letter in part number from "L" to "E".
Example: ZRLP changes to ZREP.

WITH HINGED SPRING COVER

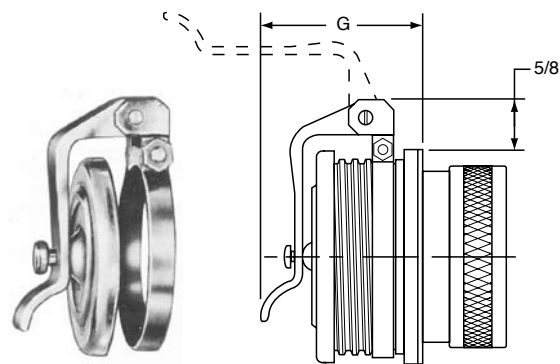

To specify receptacle with spring door cover, change third letter in part number from "L" to "C".
Example: ZRLP changes to ZRCP.

Drill hole in panel 1/64" larger than Dimension "K" for front mounting or dimension "C" for back mounting
**Maximum panel thickness may be increased 1/8" when using Standard Coupling Nut Plugs.

Square Flange Receptacle with Mechanical Clamp Nut



Type
ZRLPM ZRCPM ZREPM

To specify a complete receptacle, substitute the dash no. of the contact insert selected, for the asterisk (*) in the catalog no. below.

Size Cable	Shell Size	Catalog Number	Dimensions									
			A	B	C	D	E	F	G	H	N	
Select from Table Below and Substitute Symbol No. for Delta ▲	12	ZRLPM-▲-12-*	6-1/8	1-3/4	6-3/4	1-3/8	11/64	1-3/4	2-3/8	1-1/2	1/4	
	16	ZRLPM-▲-16-*	6-7/16	2-1/4	7-1/16	1-11/16	13/64	2-1/4	3	2	1/4	
	20	ZRLPM-▲-20-*	7	2-3/4	7-5/8	2-3/32	7/32	2-3/4	3-3/4	2-1/2	1/4	
	C20	ZRLPM-▲-C20-*	7-1/2	2-3/4	8-1/8	2-3/32	7/32	2-3/4	3-3/4	2-1/2	3/4	
	24	ZRLPM-▲-24-*	7-9/16	3-1/4	8-3/16	2-17/32	9/32	3-1/4	4-1/2	3	1/4	
	C24	ZRLPM-▲-C24-*	8-1/16	3-1/4	8-11/16	2-17/32	9/32	3-1/4	4-1/2	3	3/4	
	28	ZRLPM-▲-28-*	8-1/8	3-3/4	8-3/4	3-1/32	11/32	3-3/4	5-1/8	3-1/2	1/4	
	C28	ZRLPM-▲-C28-*	8-5/8	3-3/4	9-1/4	3-1/32	11/32	3-3/4	5-1/8	3-1/2	3/4	
	With Long Cable Adapter											
	12	ZRLPML-▲-12-*	8-3/8	1-3/4	9	1-3/8	11/64	1-3/4	2-3/8	1-1/2	1/4	
16	ZRLPML-▲-16-*	8-11/16	2-1/4	9-5/16	1-11/16	13/64	2-1/4	3	2	1/4		
20	ZRLPML-▲-20-*	9-1/4	2-3/4	9-7/8	2-3/32	7/32	2-3/4	3-3/4	2-1/2	1/4		
C20	ZRLPML-▲-C20-*	9-3/4	2-3/4	10-3/8	2-3/32	7/32	2-3/4	3-3/4	2-1/2	3/4		
24	ZRLPML-▲-24-*	9-13/16	3-1/4	10-7/16	2-17/32	9/32	3-1/4	4-1/2	3	1/4		
C24	ZRLPML-▲-C24-*	10-5/16	3-1/4	10-15/16	2-17/32	9/32	3-1/4	4-1/2	3	3/4		
28	ZRLPML-▲-28-*	10-1/8	3-3/4	10-3/4	3-1/32	11/32	3-3/4	5-1/8	3-1/2	1/4		
C28	ZRLPML-▲-C28-*	10-5/8	3-3/4	11-1/4	3-1/32	11/32	3-3/4	5-1/8	3-1/2	3/4		

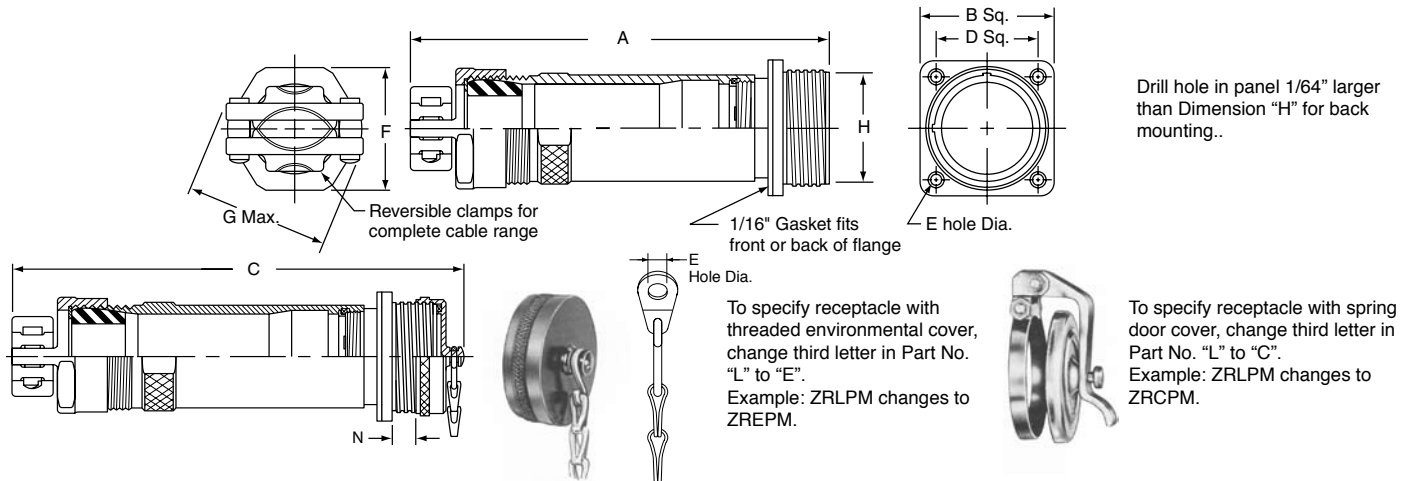

OIL-RESISTANT RUBBER GROMMETS—SYMBOL NUMBERS OF SIZES AVAILABLE

Substitute the symbol number for the Delta ▲ in the catalog number of plug.

Example: ZRLK-▲-12-* for .500 to .625 Dia. cable changes to ZREK-10 12-*

Cable Dia.	Shell 12	Shell 16	Shells 20 & C20	Shells 24 & C24	Shells 28 & C28	Cable Dia.	Shell 12	Shell 16	Shell 20 & C20	Shells 24 & C24	Shells 28 & C28
.062 to .125	02	-	-	-	-	1.500 to 1.625	-	-	26	26	26
.125 to .250	04	-	-	-	-	1.625 to 1.750	-	-	28	28	28
.250 to .375	06	06	-	-	-	1.750 to 1.875	-	-	30	30	30
.375 to .500	08	08	-	-	-	1.875 to 1.937	-	-	31	-	-
.500 to .625	10	10	10	-	-	1.875 to 2.000	-	-	-	32	32
.625 to .750	12	12	12	-	-	2.000 to 2.125	-	-	-	34	34
.750 to .875	14	14	14	-	-	2.125 to 2.250	-	-	-	36	36
.875 to .937	15	-	-	-	-	2.250 to 2.375	-	-	-	38	38
.875 to 1.000	-	16	16	16	-	2.375 to 2.437	-	-	-	39	-
1.000 to 1.125	-	18	18	18	-	2.437 to 2.500	-	-	-	-	40
1.125 to 1.250	-	20	20	20	-	2.500 to 2.625	-	-	-	-	42
1.250 to 1.375	-	22	22	22	-	2.625 to 2.750	-	-	-	-	44
1.375 to 1.437	-	23	-	-	-	2.750 to 2.875	-	-	-	-	46
1.375 to 1.500	-	-	24	24	24						

Square Flange Receptacle With Basketweave Cable Grip

To specify a complete receptacle, substitute the dash no. of the contact insert selected for the asterisk (*) in the catalog no. below.



Size Cable	Shell Size	Catalog Number	Dimensions							ZRLPK, ZRCPK, ZREPK	
			A	B	C	D	E	F	G		
Select from Table Below and Substitute Symbol No. for Delta ▲	12	ZRLPK-▲-12-*	5-3/8	1-3/4	6	1-3/8	11/64	1-1/2	1/4		
	16	ZRLPK-▲-16-*	5-5/8	2-1/4	6-1/4	1-11/16	13/64	2	1/4		
	20	ZRLPK-▲-20-*	6-1/8	2-3/4	6-3/4	2-3/32	7/32	2-1/2	1/4		
	C20	ZRLPK-▲-C20-*	6-5/8	2-3/4	7-1/4	2-3/32	7/32	2-1/2	3/4		
	24	ZRLPK-▲-24-*	6-5/8	3-1/4	7-1/4	2-17/32	9/32	3	1/4		
	C24	ZRLPK-▲-C24-*	7-1/8	3-1/4	7-3/4	2-17/32	9/32	3	3/4		
	28	ZRLPK-▲-28-*	7-1/8	3-3/4	7-3/4	3-1/32	11/32	3-1/2	1/4		
	C28	ZRLPK-▲-C28-*	7-5/8	3-3/4	8-1/4	3-1/32	11/32	3-1/2	3/4		
With Long Cable Adapter											
12	ZRLPKL-▲-12-*	7-5/8	1-3/4	8-1/4	1-3/8	11/64	1-1/2	1/4			
16	ZRLPKL-▲-16-*	7-7/8	2-1/4	8-1/2	1-11/16	13/64	2	1/4			
20	ZRLPKL-▲-20-*	8-3/8	2-3/4	9	2-3/32	7/32	2-1/2	1/4			
C20	ZRLPKL-▲-C20-*	8-7/8	2-3/4	9-1/2	2-3/32	7/32	2-1/2	3/4			
24	ZRLPKL-▲-24-*	8-7/8	3-1/4	9-1/2	2-17/32	9/32	3	1/4			
C24	ZRLPKL-▲-C24-*	9-3/8	3-1/4	10	2-17/32	9/32	3	3/4			
28	ZRLPKL-▲-28-*	9-1/8	3-3/4	9-3/4	3-1/32	11/32	3-1/2	1/4			
C28	ZRLPKL-▲-C28-*	9-5/8	3-3/4	10-1/4	3-1/32	11/32	3-1/2	1/4			

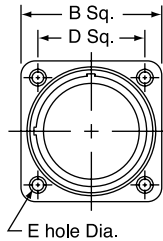
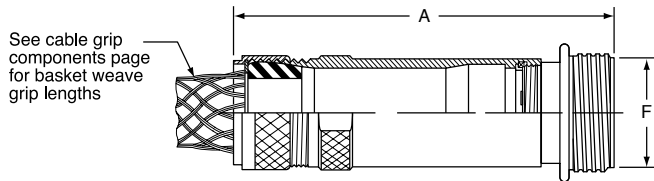

Drill hole in panel 1/64" larger than Dimension "H" for back mounting..

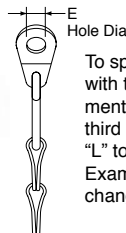
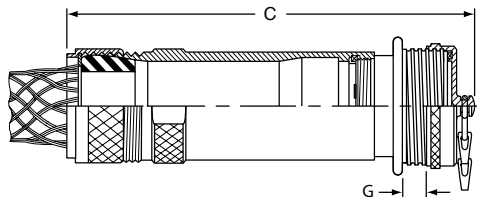

To specify receptacle with threaded environmental cover, change third letter in Part No. "L" to "E". Example: ZRLPK changes to ZREPR.



To specify receptacle with spring door cover, change third letter in Part No. "L" to "C". Example: ZRLPK changes to ZRCPR.



OIL-RESISTANT RUBBER GROMMETS—SYMBOL NUMBERS OF SIZES AVAILABLE

Substitute the symbol number for the Delta ▲ in the catalog number of plug.

Example: ZRLK-▲-12-* for .500 to .625 Dia. cable changes to ZREK-10 12-*

Cable Dia.	Shell 12	Shell 16	Shells 20 & C20	Shells 24 & C24	Shells 28 & C28	Cable Dia.	Shell 12	Shell 16	Shell 20 & C20	Shells 24 & C24	Shells 28 & C28
.062 to .125	02	-	-	-	-	1.500 to 1.625	-	-	26	26	26
.125 to .250	04	-	-	-	-	1.625 to 1.750	-	-	28	28	28
.250 to .375	06	06	-	-	-	1.750 to 1.875	-	-	30	30	30
.375 to .500	08	08	-	-	-	1.875 to 1.937	-	-	31	-	-
.500 to .625	10	10	10	-	-	1.875 to 2.000	-	-	-	32	32
.625 to .750	12	12	12	-	-	2.000 to 2.125	-	-	-	34	34
.750 to .875	14	14	14	-	-	2.125 to 2.250	-	-	-	36	36
.875 to .937	15	-	-	-	-	2.250 to 2.375	-	-	-	38	38
.875 to 1.000	-	16	16	16	-	2.375 to 2.437	-	-	-	39	-
1.000 to 1.125	-	18	18	18	-	2.437 to 2.500	-	-	-	-	40
1.125 to 1.250	-	20	20	20	-	2.500 to 2.625	-	-	-	-	42
1.250 to 1.375	-	22	22	22	-	2.625 to 2.750	-	-	-	-	44
1.375 to 1.437	-	23	-	-	-	2.750 to 2.875	-	-	-	-	46
1.375 to 1.500	-	-	24	24	24						

Receptacle Mounted to Junction Box With Angle Adapter



Types
ZRLBB ZRCBB ZREBB

To specify a complete receptacle, substitute the dash no. of the contact insert selected, for the asterisk (*) in the catalog no. below.

Shell Size	Hub Size†	Cat. No.	Dimensions							
			A	B	C	D	E	F	G	H
12	3/4	ZRLBB- 2 12-*	5-1/4	4-5/8	4-3/16	3-9/16	2-3/8	2-13/16	2-7/16	9/32
	1	ZRLBB-3 12-*	5-1/4	4-5/8	4-3/16	3-9/16	2-3/8	2-13/16	2-7/16	9/32
16	1	ZRLBB-3 16-*	5-1/4	4-5/8	4-3/16	3-9/16	2-3/8	2-15/16	2-17/32	9/32
	1-1/4	ZRLBB-4 16-*	5-1/4	4-5/8	4-3/16	3-9/16	2-5/8	2-15/16	2-17/32	9/32
	1-1/2	ZRLBB-5 16-*	5-1/4	4-5/8	4-3/16	3-9/16	2-5/8	2-15/16	2-17/32	9/32
20	1-1/4	ZRLBB-4 20-*	6	5-1/4	4-1/2	3-7/8	3-3/4	3-39/64	3	9/32
	1-1/2	ZRLBB-5 20-*	6	5-1/4	4-1/2	3-7/8	3-3/4	3-39/64	3	9/32
	2	ZRLBB-6 20-*	6	5-1/4	4-1/2	3-7/8	3-3/4	3-39/64	3	9/32
C20	1-1/4	ZRLBB-4 C20-*	6	5-1/4	4-1/2	3-7/8	3-3/4	3-39/64	3-3/8	9/32
	1-1/2	ZRLBB-5 C20-*	6	5-1/4	4-1/2	3-7/8	3-3/4	3-39/64	3-3/8	9/32
	2	ZRLBB-6 C20-*	6	5-1/4	4-1/2	3-7/8	3-3/4	3-39/64	3-3/8	9/32
24	2-1/2	ZRLBB-7 24-*	See Drawing Below		8	7	3-3/4	3-33/64	2-19/64	7/16
	3	ZRLBB-8 24-*			8	7	4-1/2	3-33/64	2-19/64	7/16
C24	2-1/2	ZRLBB-7 C24-*			8	7	3-3/4	3-33/64	2-21-32	7/16
	3	ZRLBB-8 C24-*			8	7	4-1/2	3-33-64	2-21-32	7/16
28	2-1/2	ZRLBB-7 28-*			8	7	3-3/4	3-1/2	2-7/64	7/16
	3	ZRLBB-8 28-*			8	7	4-1/2	3-1/2	2-7/64	7/16
C28	2-1/2	ZRLBB-7 C28-*			8	7	3-3/4	3-1/2	2-15/32	7/16
	3	ZRLBB-8 C28-*			8	7	4-1/2	3-1/2	2-15/32	7/16

† Other hub sizes are available. Consult Amphenol Industrial Operations.

SHELL SIZES 12 - 16 - 20 - C20

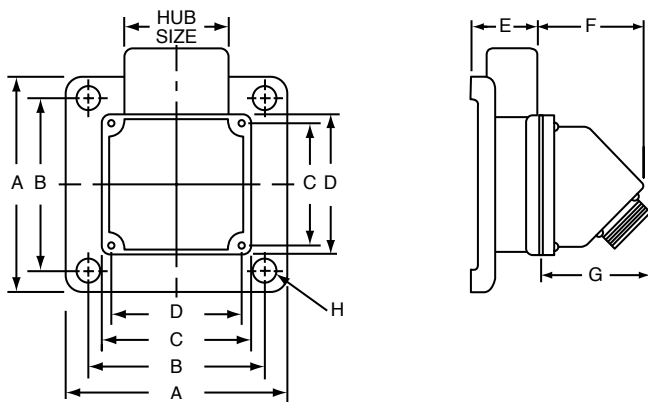

SHELL SIZES 24 - C24 - 28 - C28

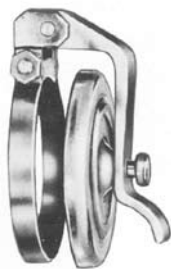
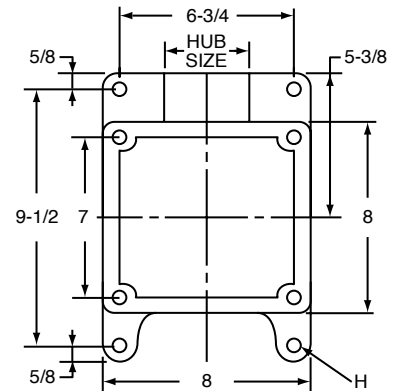

WITH HINGED SPRING COVER

To specify receptacle with spring door cover, change third letter in part number from "L" to "C".
Example: ZRLBB changes to ZRCBB



WITH THREADED ENVIRONMENTAL COVER AND SASH CHAIN

To specify receptacle with threaded environmental cover, change third letter in part number from "L" to "E".
Example: ZRLBB changes to ZREBB

Receptacle Mounted to Junction Box

With Straight Adapter

To specify a complete receptacle, substitute the dash no. of the contact insert selected, for the asterisk (*) in the catalog no. below.



Types
ZRLA ZRCA ZREA

Shell Size	Hub Size†	Cat. No.	Dimensions							
			A	B	C	D	E	F	G	H
12	3/4	ZRLA- 2 12-*	5-1/4	4-5/8	4-3/16	3-9/16	2-3/8	1-27/32	1	9/32
	1	ZRLA-3 12-*	5-1/4	4-5/8	4-3/16	3-9/16	2-3/8	1-27/32	1	9/32
16	1	ZRLA-3 16-*	5-1/4	4-5/8	4-3/16	3-9/16	2-3/8	1-27/32	1	9/32
	1-1/4	ZRLA-4 16-*	5-1/4	4-5/8	4-3/16	3-9/16	2-5/8	1-27/32	1	9/32
	1-1/2	ZRLA-5 16-*	5-1/4	4-5/8	4-3/16	3-9/16	2-5/8	1-27/32	1	9/32
20	1-1/4	ZRLA-4 20-*	6	5-1/4	4-1/2	3-7/8	3-3/4	3-1/16	1-7/32	9/32
	1-1/2	ZRLA-5 20-*	6	5-1/4	4-1/2	3-7/8	3-3/4	3-1/16	1-7/32	9/32
	2	ZRLA-6 20-*	6	5-1/4	4-1/2	3-7/8	3-3/4	3-1/16	1-7/32	9/32
C20	1-1/4	ZRLA-4 C20-*	6	5-1/4	4-1/2	3-7/8	3-3/4	2-9/16	1-7/32	9/32
	1-1/2	ZRLA-5 C20-*	6	5-1/4	4-1/2	3-7/8	3-3/4	2-9/16	1-7/32	9/32
	2	ZRLA-6 C20-*	6	5-1/4	4-1/2	3-7/8	3-3/4	2-9/16	1-7/32	9/32
24	2-1/2	ZRLA-7 24-*	See Drawing Below		8	7	3-3/4	2-11/32	1-1/2	7/16
	3	ZRLA-8 24-*			8	7	4-1/2	2-11/32	1-1/2	7/16
C24	2-1/2	ZRLA-7 C24-*			8	7	3-3/4	2-27/32	1-1/2	7/16
	3	ZRLA-8 C24-*			8	7	4-1/2	3-33-64	1-1/2	7/16
28	2-1/2	ZRLA-7 28-*			8	7	3-3/4	2-27/32	1-1/2	7/16
	3	ZRLA-8 28-*			8	7	4-1/2	2-9/32	1-1/2	7/16
C28	2-1/2	ZRLA-7 C28-*			8	7	3-3/4	2-25/32	1-1/2	7/16
	3	ZRLA-8 C28-*			8	7	4-1/2	2-25/32	1-1/2	7/16

† Other hub sizes are available. Consult Amphenol Industrial Operations.

SHELL SIZES 12 - 16 - 20 - C20

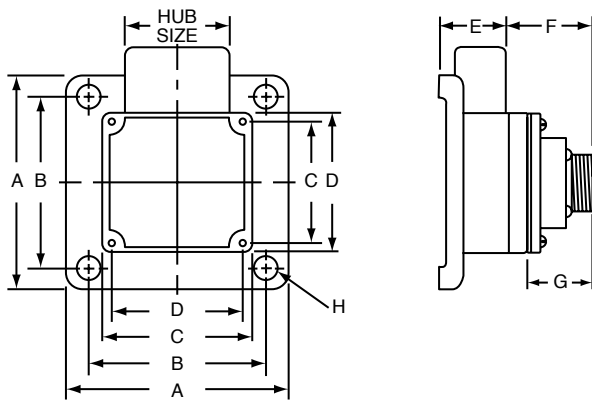

SHELL SIZES 24 - C24 - 28 - C28

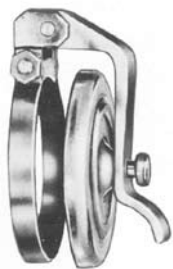
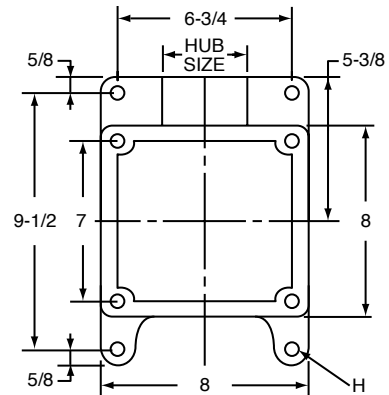

WITH HINGED SPRING COVER

To specify receptacle with spring door cover, change third letter in part number from "L" to "C".
Example: ZRLA changes to ZRCA.



WITH THREADED ENVIRONMENTAL COVER AND SASH CHAIN

To specify receptacle with threaded environmental cover, change third letter in part number from "L" to "E".
Example: ZRLA changes to ZREA.

Amphenol[®] Star-Line EX[®] Product Instructions



Sections Contents:

- **Hazardous Location Page**
- **Part Number Guide**
- **EX Gland Code Guide**
- **EX-13 Plug**
- **EX-15 Inline Receptacle**
- **EX-17 Panel Mount Receptacle**
- **Familiarization & Assembly Information**
- **Assembly & Termination**
- **Mixing Instructions**
- **Potting Instructions**



Star-Line EX[®] Hazardous Certification Information



Ingress Protection (IP) Ratings

First Number Protection against solid bodies	Second Number Protection against Liquids
0 No Protection	0 No Protection
1 Objects greater than 50mm	1 Vertically dripping water
2 Objects greater than 12mm	2 75 to 90 dripping water
3 Objects greater than 2.5mm	3 Sprayed water
4 Objects greater than 1mm	4 Splashed water
5 Dust-protected	5 Water jets
* 6 Dust-tight	6 Heavy Seas
	7 Temporary immersion
	* 8 Indefinite immersion

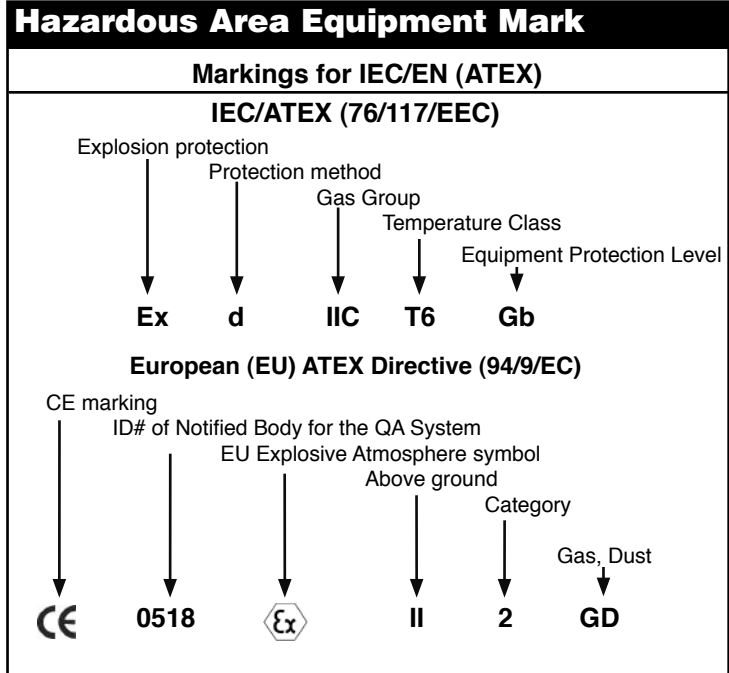

Temperature Ratings

Surface Temperature	UEC, EU (Europe) USA (NEC 505) Canada
450 C (842 F)	T1
300 C (572 F)	T2
200 C (392 F)	T3
135 C (275 F)	T4
* 100 C (212 F)	T5
* 85 C (185 F)	T6

Note: Star-Line Ex[®] products certification denoted with a *.

HazLoc Hand Chart

Protection Method	IEC/EN (ATEX)						ATEX Category
	Ex Code	Gas		Ex Code	Dust		
Intrinsic Safety	ia ib ic	60079-11 60079-11 60079-11	Zone 0 Zone 1 Zone 2	iaD ibD	61241-11 61241-11	Zone 20 Zone 21	1 2 3
* Flameproof	d	60079-1					2
* Enclosure				tD	61241-1	Zone 20, 21, 22	
Purge & Pressurization	px py pz	60079-2 60079-2 60079-2	Zone 1 Zone 1 Zone 2				2 2 3
Pressurized				pD	612441-4	Zone 21, 22	
* Increased Safety	e	60079-7	Zone 1				2
Encapsulation	ma mb	60079-18 60079-18	Zone 0 Zone 1	maD mbD	61241-18 61241-18	Zone 20 Zone 21	1 2
Oil Immersion	o	60079-6	Zone 1				2
Powder Filled	q	60079-5	Zone 1				2
Non Incendive	nA, nC, nL, nR	60079-15	Zone 2				3
Rooms (draft)	p	60079-13	Zone 1				2
Optical Radiation	op..	60079-28	Zone 0				1
* General Requirements		60079-0			61241-0		
* Class. of Hazardous Areas		60079-1					
* Electrical Installations		60079-14					
Inspection & Maintenance		60079-17					

Code Logic Star-Line EX

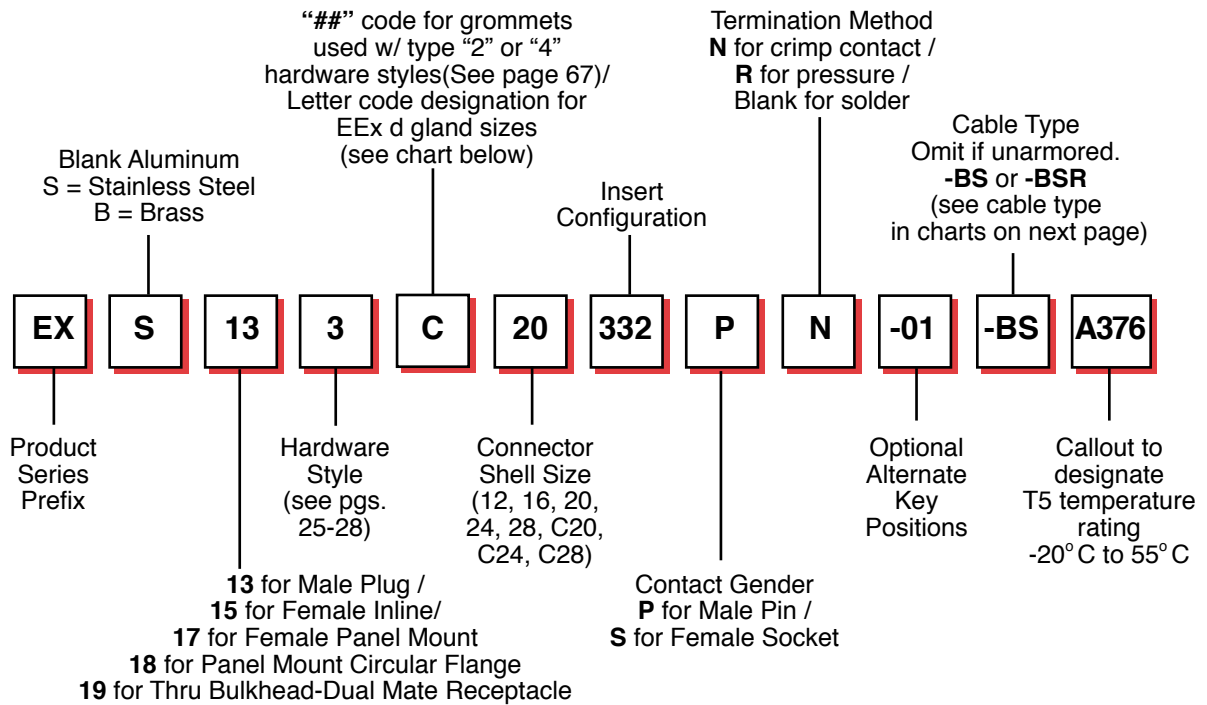

Example:

EX-13-3-C-20-332PN

Male Plug with EEX gland for a cable with 0.95” 24.1mm O.D., 20ea #12awg/4mm² male contacts.

EX-15-4-1620-332SN

Female Inline with basket weave grip for a cable with 0.95” 24.1mm O.D., 20ea #12awg/4mm² female contacts.

EX-17-1-20-332SN

Female Panel Mount, 20ea #12awg/4mm² female contacts.

EX-13-3-C-16-22PR-BS

Male Plug with EEX gland for an armored cable with 1.25”/31.75mm O.D., 4ea #4awg/25mm² male contacts.

EX-17-3-C-16-22SR-BS

Female Panel Mount with cable adapter with and EEX gland for an armored and sheathed cable.

For Amphenol Star-Line product insert de-rating information per the National Electric Code, please consult the Amphenol Industrial website, www.amphenol-industrial.com. Chart is located under LITERATURE tab.



PRODUCT CERTIFICATIONS



Certificate Number: SIRA 03ATEX1101X



Cert. No.: IECEX SIR 10.0064X



North American Hazloc Listing
Consult Factory for Listing No



GOST-R Cert. No. POCC MX.AM96.B00012



(TUV) Brasil Cert. No. TUV 11.0147X



File Number: E184393



CSA Listed



Member: International
Association of Drilling Contractors



The Starline product family carries all of the industry standard approvals ranging from ATEX and IECEX to UL and CSA.



Starline EX offers a full range of hardware styles including the use of EX rated cable glands, mechanical clamps and gland nuts.



EEx d Cable Types

EEx d Cable Gland Size Code	Unarmored Cable No deviation if Unarmored		Armored & Sheathed Cable -BS				Armored & Sheathed with reduced bore -BSR	
	Min	Max	UA		Standard		OD-Reduced	
			Min	Max	Min	Max	Min	Max
A1	.1575 (4.0)	.3307 (8.4)	.1339 (3.4)	.3307 (8.4)	.3543 (9.0)	.5315 (13.5)	.2638 (6.7)	.4055 (10.3)
A2	.2835 (7.2)	.4606 (11.7)	.2835 (7.2)	.4606 (11.7)	.4528 (11.5)	.6299 (16.0)	.3701 (9.4)	.4921 (12.5)
A	.3780 (9.6)	.5512 (14.0)	.3701 (9.4)	.5512 (14.0)	.6102 (15.5)	.8307 (21.1)	.4724 (12.0)	.6929 (17.6)
B	.5315 (13.5)	.7874 (20.0)	.5315 (13.5)	.7874 (20.0)	.7992 (20.3)	1.079 (27.4)	.6614 (16.8)	.9409 (23.9)
C	.7677 (19.5)	1.035 (26.3)	.7677 (19.5)	1.035 (26.3)	1.051 (26.7)	1.339 (34.0)	.9134 (23.2)	1.201 (30.5)
C2	.9055 (23.0)	1.268 (32.2)	.9055 (23.0)	1.268 (32.2)	1.299 (33.0)	1.598 (40.6)	1.126 (28.6)	1.425 (36.2)
D	1.110 (28.2)	1.504 (38.2)	1.106 (28.1)	1.504 (38.2)	1.551 (39.4)	1.839 (46.7)	1.370 (34.8)	1.669 (42.4)
D2	1.307 (33.2)	1.736 (44.1)	1.303 (33.1)	1.736 (44.1)	1.799 (45.7)	2.094 (53.2)	1.618 (41.1)	1.909 (48.5)
E	1.547 (39.3)	1.972 (50.1)	1.543 (39.2)	1.969 (50.0)	2.051 (52.1)	2.343 (59.5)	1.870 (47.5)	2.157 (54.8)
E2	1.839 (46.7)	2.205 (56.0)	1.839 (46.7)	2.205 (56.0)	2.299 (58.4)	2.591 (65.8)	2.118 (53.8)	2.409 (61.2)
F	2.059 (52.3)	2.441 (62.0)	2.051 (52.1)	2.441 (62.0)	2.551 (64.8)	2.843 (72.2)	2.370 (60.2)	2.677 (68.0)
F2	2.287 (58.1)	2.677 (68.0)	2.283 (58.0)	2.677 (68.0)	2.799 (71.1)	3.071 (78.0)	2.618 (66.5)	2.890 (73.4)
G	2.453 (62.3)	2.835 (72.0)	2.449 (62.2)	2.835 (72.0)	3.031 (77.0)	3.307 (84.0)	-	



Amphenol offers an extensive line of explosion proof and general duty cable glands. Consult Amphenol Industrial Operations and ask for new catalog 12-055, Amphenol Cable Glands and Cord Grips.



Star-Line EX Plug with EX Gland



Cables can be designed with a custom overmold to any Amphenol cylindrical connector for any industrial application. Consult Amphenol Industrial Operations for further information.



Hardware

*Notes: For "C" length inserts, add 1/2" to both dimensions "A" & "B".

Plug with Mechanical Clamp (POTTING REQUIRED) EX-13-2 Style

Dimension Shell	A*	B*	C	D	E	F
12	7-7/16 (189)	3-9/16 (91)	2-1/8 (54)	2 (51)	15/16 (24)	2-3/8 (60)
16	9-1/2 (241)	3-9/16 (91)	2-5/8 (67)	2-1/16 (52)	1-7/16 (37)	3 (76)
20	9-9/16 (243)	3-9/16 (91)	3-1/8 (79)	2-1/8 (54)	1-15/16 (49)	3-3/4 (95)
24	9-5/8 (245)	3-9/16 (91)	3-5/8 (92)	2-3/16 (56)	2-7/16 (62)	4-1/2 (114)
28	9-11/16 (246)	3-9/16 (91)	4-1/8 (105)	2 1/4 (57)	2-7/8 (73)	5-1/8 (130)

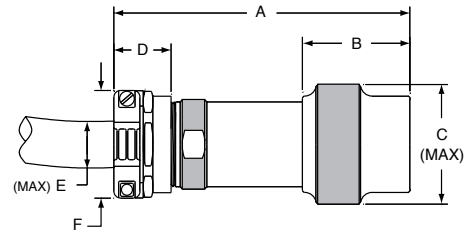

Plug with EEx d Gland (POTTING IS NOT REQUIRED) EX-13-3 Style

Note: 'D' Dimension varies according to cable gland. Detailed cable dimensions and type required.

Gland is included with the connector.

Dimension Shell	A*	B*	C	Gland Thread
12	6-1/16 (154)	3-9/16 (91)	2-1/8 (54)	M25
16	8-1/16 (205)	3-9/16 (91)	2-5/8 (67)	M40
20	8-1/16 (205)	3-9/16 (91)	3-1/8 (79)	M50
24	8-1/16 (205)	3-9/16 (91)	3-5/8 (92)	M63
28	8-1/16 (205)	3-9/16 (91)	4-1/8 (105)	M75

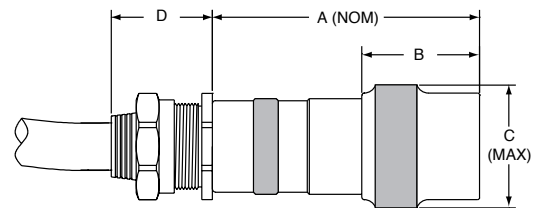
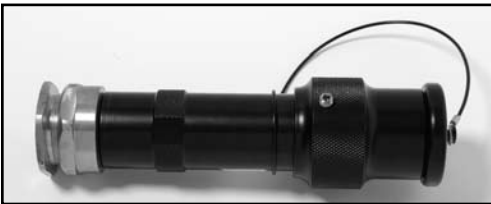

Plug with Basketweave Cable Grip (POTTING REQUIRED) EX-13-4 Style

Dimension Shell	A*	B*	C	D	E	F	G
12	6-1/16 (154)	3-9/16 (91)	2-1/8 (54)	1-1/4 (32)	15/16 (24)	1-9/32 (33)	8 (203)
16	8-1/16 (205)	3-9/16 (91)	2-5/8 (67)	1-1/4 (32)	1-7/16 (37)	1-25/32 (45)	10-1/2 (267)
20	8-1/16 (205)	3-9/16 (91)	3-1/8 (79)	1-1/4 (32)	1-15/16 (49)	2-9/32 (58)	14-1/2 (368)
24	8-1/16 (205)	3-9/16 (91)	3-5/8 (92)	1-1/4 (32)	2-7/16 (62)	2-25/32 (71)	17-1/2 (445)
28	8-1/16 (205)	3-9/16 (91)	4-1/8 (105)	1-1/4 (32)	2-7/8 (73)	3-9/32 (83)	19 (483)

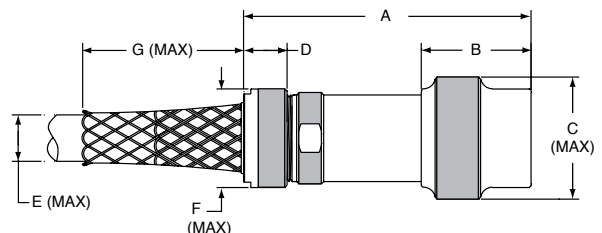

*Notes: For "C" length inserts, add 1/2" to both dimensions "A" & "B".

In-line Receptacle with Mechanical Clamp (POTTING REQUIRED)

EX-15-2 Style

Dimension Shell	A*	B*	C	D	E	F
12	7 (178)	1-7/16 (37)	1-1/2 (38)	2 (51)	15/16 (24)	2-3/8 (60)
16	9-1/16 (230)	1-7/16 (37)	2 (51)	2-1/16 (52)	1-7/16 (37)	3 (76)
20	9-1/8 (232)	1-7/16 (37)	2-1/2 (64)	2-1/8 (54)	1-15/16 (49)	3-3/4 (95)
24	9-3/16 (233)	1-7/16 (37)	3 (76)	2-3/16 (56)	2-7/16 (62)	4-1/2 (114)
28	9-1/4 (235)	1-7/16 (37)	3-1/2 (89)	2-1/4 (57)	2-7/8 (73)	5-1/8 (130)

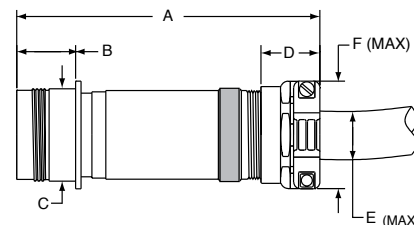

In-line Receptacle with EEx d Gland (POTTING IS NOT REQUIRED)

EX-15-3 Style

Note: 'D' Dimension varies according to cable gland. Detailed cable dimensions and type required.

Gland is included with the connector.

Dimension Shell	A*	B*	C	Gland Thread
12	5-5/8 (143)	1-7/16 (37)	1-1/2 (38)	M25
16	7-5/8 (194)	1-7/16 (37)	2 (51)	M40
20	7-5/8 (194)	1-7/16 (37)	2-1/2 (64)	M50
24	7-5/8 (194)	1-7/16 (37)	3 (76)	M63
28	7-5/8 (194)	1-7/16 (37)	3-1/2 (89)	M75

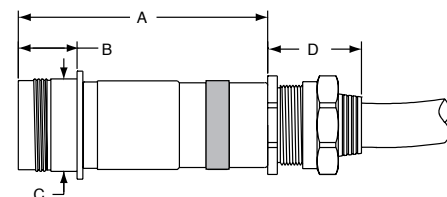

In-line Receptacle with Basketweave Cable Grip (POTTING REQUIRED)

EX-15-4 Style

Dimension Shell	A*	B*	C	D	E	F	G
12	6-1/4 (159)	1-7/16 (37)	1-1/2 (38)	1-1/4 (32)	15/16 (24)	1-9/32 (33)	8 (203)
16	8-1/4 (210)	1-7/16 (37)	2 (51)	1-1/4 (32)	1-7/16 (37)	1-25/32 (45)	10-1/2 (267)
20	8-1/4 (210)	1-7/16 (37)	2-1/2 (64)	1-1/4 (32)	1-15/16 (49)	2-9/32 (58)	14-1/2 (368)
24	8-1/4 (210)	1-7/16 (37)	3 (76)	1-1/4 (32)	2-7/16 (62)	2-25/32 (71)	17-1/2 (445)
28	8-1/4 (210)	1-7/16 (37)	3-1/2 (89)	1-1/4 (32)	2-7/8 (73)	3-9/32 (83)	19 (483)

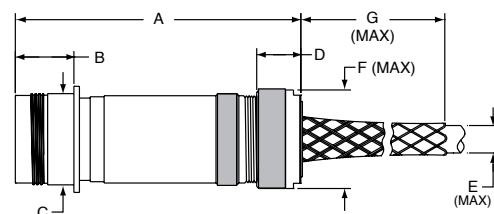



STAR-LINE EX[®]

*Notes: For "C" length inserts, add 1/2" to both dimensions "A" & "B".

Panel Mount Receptacle (POTTING REQUIRED) EX-17-1 Style



Dimension Shell	A*	B*	C	D	E	F
12	4 7/16	1.765	1-1/2 (38)	1.654 (42)	2-1/4 (57)	M40
16	4 7/16	1.765	2 (51)	2.047 (52)	2-5/8 (67)	M50
20	4 7/16	1.765	2-1/2 (64)	2.441 (62)	3 (76)	M63
24	4 7/16	1.765	3 (76)	2.835 (72)	3-1/2 (89)	M75
28	4 7/16	1.765	3-1/2 (89)	3.228 (82)	4 (102)	M90

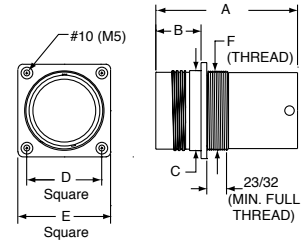

Fixed In-Line Receptacle with Mechanical Clamp (POTTING REQUIRED) EX-17-2 Style

Dimension Shell	A*	B*	C	D	E	F
12	7 (178)	1-7/16 (27)	1-1/2 (38)	2 (51)	5/16 (24)	2-3/8 (60)
16	9-1/16 (230)	1-7/16 (27)	2 (51)	2-1/16 (52)	1-7/16 (37)	3 (76)
20	9-1/8 (229)	1-7/16 (27)	2-1/2 (64)	2-1/8 (54)	1-15/16 (49)	3-3/4 (95)
24	9-3/16 (233)	1-7/16 (27)	3 (76)	2-3/16 (56)	2-7/16 (62)	4-1/2 (114)
28	9-1/4 (235)	1-7/16 (27)	3-1/2 (89)	2-1/4 (57)	2-7/8 (73)	5-1/8 (130)

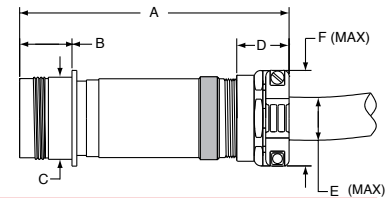

Fixed In-Line Receptacle with EEx d Gland (POTTING IS NOT REQUIRED) EX-17-3 Style

Note: 'D' Dimension varies according to cable gland. Detailed cable dimensions and type required. Gland is included with the connector.

Dimension Shell	A*	B*	C	Gland Thread
12	5-5/8 (143)	1-7/16 (37)	1-1/2 (38)	M25
16	7-7/8 (194)	1-7/16 (37)	2 (51)	M40
20	7-7/8 (194)	1-7/16 (37)	1-1/2 (64)	M50
24	7-7/8 (194)	1-7/16 (37)	3 (76)	M63
28	7-7/8 (194)	1-7/16 (37)	3-1/2 (89)	M75

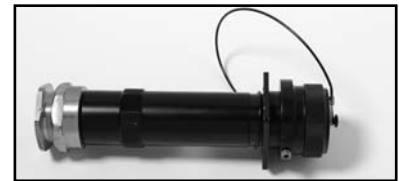
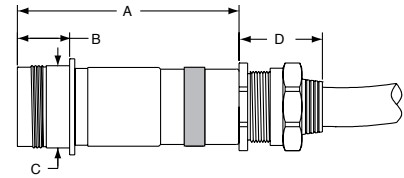

Fixed In-Line Receptacle with Basketweave Cable Grip (POTTING REQUIRED) EX-17-4 Style

Dimension Shell	A*	B*	C	D	E	F	G
12	6-1/4 (159)	1-7/16 (27)	1-1/2 (38)	1-1/4 (32)	15/16 (24)	1-9/32 (33)	8 (203)
16	8-1/4 (210)	1-7/16 (27)	2 (51)	1-1/4 (32)	1-7/16 (37)	1-25/32 (45)	10-1/2 (267)
20	8-1/4 (210)	1-7/16 (27)	2-1/2 (64)	1-1/4 (32)	1-15/16 (49)	2-9/32 (58)	14-1/2 (368)
24	8-1/4 (210)	1-7/16 (27)	3 (76)	1-1/4 (32)	2-7/16 (62)	2-25/32 (71)	17-1/2 (445)
28	8-1/4 (210)	1-7/16 (27)	3-1/2 (89)	1-1/4 (32)	2-7/8 (73)	3-9/32 (83)	19 (483)

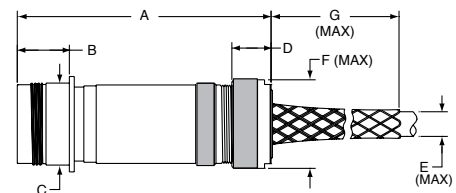

Description of equipment

The Star-line EX series of connectors is comprised of metallic bodied plug and receptacle shells, to form in-line cable connections. Externally the main bodies are fitted with suitably certified cable glands. Internally the main bodies each contain an insulator insert fitted with solder or pressure type contacts of either a pin or socket variety. The plug and receptacle shells together form an in-line connector. When connected together they form a spigotted flamepath and are mechanically interlocked by means of a threaded nut retained by a grub screw.

Additionally, the receptacle connector is available in a bulkhead mounted version that contains an externally threaded flamepath for mounting to certified EX enclosures with suitable internal mating thread. This variety of bulkhead mount connector, must be internally potted, as described within this document.

The range is comprised of seven body (forms) sizes, each with a number of pin/socket size combinations between 1 and 143 contacts. The connector shell size, pin configuration and rating are reflected in the individual type designations.

Design Option are described below and include, alternative keying options, and pin or sleeve contacts in either the plug or receptacle bodies.

Part Number Code Logic: EX(a) - (b) - (c) - (d)- (e) - (f)(g)(h)(j) - (k)

Connector series type designation	EX
Shell material (a)	Aluminium (default, omit code) B-Brass S-Stainless steel
Shell configuration (b)	13- Inline Receptacle, w/ accompanying blanking cap 15- Inline Plug, w/ accompanying blanking cap. 17 - Flange Mount Receptacle, w/ accompanying blanking cap. 18 - Circular Bulkhead Mount Receptacle, w/ cap.
Cable Adapter style (c)	1- Bulkhead Mount (w/ potting adapter; requires potting) 2- Mechanical Clamp (requires potting) 3- Threaded for use with EX certified Gland 4- Basketweave Grip (requires potting)
Grommet ID (d)	See catalog for available sizes and codes
Shell Size (e)	12, 16, 20, C20, 24, C24, 28, C28
Contact Insulation (f)	See catalog for configurations
Contact Gender (g)	P - Pin, S - Socket
Termination Style (h)	N - Crimp, R - Pressure
Insert Rotation (j)	Normal (default, omit code) For alternates, refer to catalog
Planned Additions (k)	Certified Variations



Star-Line EX[®]

Familiarization & Assembly Information

1. Read manufacturer's assembly instructions before actually starting to assemble connectors. Besides the matter of instruction on correct procedures, there are two important reasons for this preliminary step: To identify the various component parts, and to check for any missing parts.
2. Cut cable jackets and sheathing squarely and to correct length, using only wire strippers that have been approved for the operation. In preparing the individual wires in cables and harnesses for assembly, make allowances in length for reaching the outermost circle of contact cavities in the conductors. The insulation should be cut progressively longer as they extend out from the center of the cable or harness to assure sufficient length.
3. Follow chart on page 34 covering maximum cable stripping lengths for effective cable gland or grommet sealing. All conductors should be fit into contact wire wells correctly. A practice layout should be done so that the assembler can oversee what the finished will look like when finished.
4. Some cables that will be used will have a 'basket weave' type of armor under the outer jacket (sheath) and over the inner jacket. Since many regulatory entities require that the armor be grounded at least at the source end, it is beneficial to ground the armor via a spare contact within the connector. Following the removal of sufficient amount of outer jacket (see chart on page 34) ample amount of the armor can be clipped away, but not all. An adequate amount should remain in order that a small cross-section conductor, short in length, be woven into the remaining armor weave and either soldered or covered with mastic impregnated heat shrink, creating an intimate bond to the armor. At the opposite end of the short piece of wire a contact should be crimped and inserted into the insert.
5. Use only correctly sized and ingress protected certified glands or sealing grommets to assure resistance to moisture and other contaminants.
6. Use only the proper crimping tools that have been set or calibrated with precision gages.
7. Make certain that all contacts are the correct size before attempting to assemble in insert cavities. This point is particularly important when both power and control types of contacts are used in the same connector.
8. Be sure that ground contacts (when applicable) are correctly located.
9. Seat all contacts properly so that they will not be damaged or become disengaged during connector mating operations
10. Use only the proper insertion tools and be sure that they are aligned axially when pushing contact into their fully seated position.
11. When inserts have more cavities than conductors, plug unused cavities with furnished contacts.
12. After all terminated contacts are inserted in their respective cavities and inspected (detailed on page 34), the cable adapter or insert clamp nut should be tightened with a wrench. (detailed on page 37).
13. When handling cables, use adequate support to prevent damage to the internal wires. Exd glands are intended for sealing purposes and should not be used as a cable grip.
14. If for any reason terminated conductors have to be removed from an insert because of an assembly error or change in circuitry, be sure to remove the cable gland or cable adapter first before extracting the contact and reinserting it.
15. If one of the connector poles is a ground wire, make sure that it is grounded properly before the connector actually is engaged.
16. When connectors having the same configuration are to be mounted close together, different or alternate keying arrangements should be used to prevent mismatching and possible damage to the electrical system.
17. Always inspect all aspects of connector assembly operations before putting connectors into actual operation.
18. Crimping and terminating of conductors to contacts must be done carefully. Make certain that wire strands are fully bottomed in contact-wells by checking through inspection hole provided (Detailed on page 34).
19. Never try to straighten bent contacts. Straightening cannot be done properly and the plating on contacts very likely will be marred. This will result in a high resistance connection and will expose the base material to possible corrosion.
20. Each assembly operator should be his own inspector. Worn, damaged, or defective tools should be reported immediately to foreman and supervisors. Assembly operators should be indoctrinated with this attitude and made to understand the importance of always guarding quality. Assembly workmanship is a significant factor in terminating the quality of multiple contact connectors. Quality cannot be "inspected" into connectors; it must be "built-in" during each and every assembly operation.

Star-Line EX® Cable Types

It is the responsibility of the specifier/user to select the appropriate cable to be used with the EX Star-Line connector system. The specifier/user should favor the use of cables constructed with flexible conductors (IEC class 5 or higher/ICEA type H or higher) as well as a flexible armor type (basket weave) if required. Armor systems such as those identified in IEC 92-3 or IEEE455 or UL1309 are recommended. An impervious jacket should always be furnished over the armor. IEC/BS cables such as armored with SWA (X), tape(Z), and NEC style cables such as 'interlocked' or MC are not recommended with the EX connector system.

The armor system should be grounded at the source point. Periodically the specifier/user should investigate the need for armor grounding (earthing) within the plug or in-line connector itself. In addition to the weaving of the armor grounding conductor, soldering and/or heat shrink and/or strong adhesive electrical takes, and/or 'tension banding' should be applied on the armor and conductor to insure a permanent bond. The armor grounding wire should be terminated (solder or crimp) to an appropriate sized contact, and inserted into the connector insert.

The armor system should not be confused or associated with shielding which is employed with instrumentation/telecommunication cables. Shielding for pairs/triads have their own individual drain wires which should be terminated onto dedicated contacts. These drain wires should be insulated with heat shrink within the connector body to prevent contact with other drain wires or pair/triad shield faces.

The above procedure does not apply to single conductor cables, i.e., 444-1111mcm (150mm-500mm), or multiconductor power or control cables.

Single conductor Cables Periodically single conductor cables will be required in an armored and sheathed construction.

Since there is no armor grounding contact path provided within the connector assembly, a suitable external method must be employed. It is recommended that a small strip of outer jacket be cut away a reasonable distance from the entrance to the cable gland of the connector. A durable insulated conductor with a cross section not smaller than #14awg/4mm should be bonded to the exposed armor. Protective tapes or heat or cold shrink (3M PST) should be applied to protect this bonding point. The opposite end of this grounding conductor should be terminated at the corresponding receptacles' panel via one of the receptacles' fastening screws or a dedicated grounding lug or bar. In an 'in-line' configuration, a mirror image of the above should be used with a simple mating point in close proximity to the connector set.

In summary the specifier/user should be versed in acceptable applications that are allowed by the regulatory/certifying bodies having jurisdiction. Periodic inspection of this grounding arrangement should be implemented.

All connectors are furnished with a protective cover. In actuality this cover is viewed as a critical part of the connector. The cover is compared to a cover on a flameproof (Exd) enclosure. Absence of the cover voids the Ex certification. The covers should not be viewed as an incidental protection to the external elements, but a required component of a hazardous certified device. When the connectors are plugged together the covers can be screwed into each other to protect the threads from damage. When the connectors are not mated, it is required that the covers be installed and the set screws on the covers be fully driven into the body of the connector. Replacement covers and 'NYLOK' set screws are available on request.

SIRA Product Labeling Information

Information below must be attached to connectors via non-removable label.

Amphenol
Sidney NY 13838 USA

Star-Line, Size Ref

Work Order Number; Date Code; Facility
Code

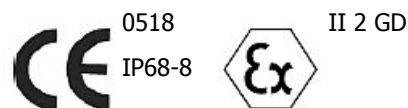

Sira 03ATEX1101X & IECEx SIR 10.0064X

"Max volts, Max amp, Current rating per pin"

DO NOT SEPARATE WHEN ENERGIZED

Marking for all connectors used in standard (+40°C max.) ambient:

Ex d IIC T6 Gb (Inline Plugs and Receptacles)
Ex tb IIIC T80°C Db IP68 (Inline Plugs and Receptacles)
Ex de IIC T6 Gb (Panel mount receptacle filled w/ cement)
Ex tb IIIC T80°C Db IP68 (Panel mount receptacle filled w/ cement)
 $-20^{\circ}\text{C} \leq T_{\text{amb}} \leq +40^{\circ}\text{C}$

Marking for inline connectors, used in +55°C max. ambient: (INCREASED TEMP RANGE ONLY ALLOWABLE FOR CONNECTORS (EX-13-3, EX-15-3, EX-17-3) EMPLOYING SUITABLE EX CERTIFIED GLANDS. THIS MARKING IS NOT APPLICABLE FOR CE-MENTED CONFIGURATIONS)

Ex d IIC T5 Gb (Inline Plugs and Receptacles)
Ex tb IIIC T95°C Db IP68 (Inline Plugs and Receptacles)
 $-20^{\circ}\text{C} \leq T_{\text{amb}} \leq +55^{\circ}\text{C}$



The following instructions apply to equipment covered by certificate numbers:

Sira 03ATEX1101X & IECEx SIR 10.0064X

The equipment may be used with flammable gases and vapours with apparatus group(s) IIA, IIB, & IIC and with temperature classes T6, T5, T4, T3, T2 & T1.

The equipment is only certified for use in ambient temperatures in the range -20°C to +40°C and should not be used outside this range.

The product complies with the following standards:

Installation shall be carried out by suitably-trained personnel in accordance with the applicable code of practice **e.g.**

EN 60079-0:2006 (IEC 60079-0:2007 5th Ed)	General requirements for electrical apparatus for explosive gas atmospheres
EN 60079-1:2007 (IEC 60079-1:2007 6th Ed)	Electrical apparatus for explosive gas atmospheres - Part 1: Flameproof enclosures "d"
EN 60079-7:2007 (IEC 60079-7:2006 4th Ed)	Electrical apparatus for explosive gas atmospheres – Part 7: Increased safety "e"
EN 61241-0:2006 (IEC 61241-1:2004 1st Ed + Corr Nov 05)	General requirements for electrical apparatus for use in the presence of combustible dust
EN 61241-1:2004 (IEC 61241-1:2004 1st Ed)	Electrical apparatus for use in the presence of combustible dust. Protection by enclosures "tD"

EN/IEC 60079-14 or EN/IEC 61241-14. It is the end user's responsibility to ensure that the product, as specified and confirmed by the product label, is suitable for its intended application.

Inspection and maintenance of this equipment shall be carried out by suitably trained personnel in accordance with the applicable code of practice e.g. **EN/IEC 60079-17 or EN/IEC 61241-17.**

Repair of this equipment shall be carried out by suitably trained personnel in accordance with the applicable code of practice e.g. **EN/IEC 60079-19.**

Components to be incorporated into or used as replacement parts of the equipment shall be fitted by suitably trained personnel, using only components purchased from Amphenol or an Amphenol approved distributor. Any use of non-approved components/suppliers will invalidate the certification for that product.

The certification of this equipment relies upon the following materials used in its construction:

1. Connector Materials:

- (Standard Base Material) ASTM B211 or B221 Alloy 6061-T6, Aluminum (<7%Mg, <7%Ti),
- (Optional Base Material) ASTM 5640, Alloy 303, Stainless Steel,
- (Optional Base Material) ASTM B455, Alloy C38500, Brass.

2. Seal Materials:

- Buna Rubber w/ Durometer of 70 SHORE A.

If the equipment is likely to come into contact with aggressive substances, then it is the responsibility of the user to take suitable precautions that prevent it from being adversely affected, thus ensuring that the type of protection provided by the equipment is not compromised.

Aggressive substances: e.g. acidic liquids or gases that may attack metals, or solvents that may affect polymeric materials.

Suitable precautions: e.g. regular checks as part of routine inspections or establishing from the material's data sheets that it is resistant to specific chemicals.

SPECIAL CONDITIONS FOR SAFE USE/CONDITIONS OF CERTIFICATION

The following must be adhered to in full for safety and as to not invalidate product certification.

1. The panel mounted variants may be installed in suitably certified and dimensioned flameproof equipment providing that the certification of this flameproof equipment will allow such installation.
2. The panel mounted variants may be fitted in an increased safety enclosure when the free internal space is filled with epoxy resin and providing the certification of the enclosure will allow such installation. An electric strength test in accordance with EN 60079-7:2007 and IEC 60079-7:2007 Clause 7.1 will be performed on each unit after installation of the epoxy resin.
3. The Ex-18 range of panel-mounted variants may be installed in a suitably certified and dimensioned flameproof equipment providing that the certification of this flameproof equipment will allow such installation. They have the following dimensioned spigot joints and are suitable for Group IIA, IIB or IIC, dependent upon the associated apparatus entry dimensions.

Shell Size	Spigot diameter (mm)	Spigot length (mm)
12	39.90/39.85	46 (+/-1)
16	49.90/49.85	46 (+/-1)
20	62.90/62.85	46 (+/-1)
24	74.90/74.85	46 (+/-1)
28	89.90/89.85	46 (+/-1)

1. The Ex-18 range of receptacles shall only be used where the temperature at the point of entry in service on the associated enclosure is between -20°C to +70.2°C.
2. The Ex-18 range connector does not incorporate an external earth facility. It is the responsibility of the user or installer to ensure adequate earth continuity by means of guidance given within the manufacturer's installation instructions.

Star-Line EX® Connector Mating, Securement and Certification Compliance

The Starline EX series utilizes a traditional threaded (ACME) coupling scheme, with an additional enhancement. The coupling sleeve is part of an actual assembly. The assembly is comprised of a coupling sleeve, and two (2) grub screws (set screws). These set screws and their proper implementation, are a requirement of the Certificate of Conformity.

Once the connectors are mated, and the coupling nut has been tightened, it is a requirement that the Grub Screws both be tightened using a proper tool (allen key; supplied with connector). This prevents the coupling nut from backing off, and minimizes "unauthorized decoupling" of the mated connector pair. The Grub Screws would have to be intentionally loosened, in order for the coupling nut to be retracted, and the connectors unmated.

WARNING: Compliance with the Certificate of Conformity is satisfied when:

- 1) the male and female connectors are completely mated, and
- 2) the coupling sleeve is fully engaged, and
- 3) the grub screws are fully engaged, and
- 4) all the above are established before the circuit is energized.

WARNING: When circuits are de-energized, and the connectors, all plugs and receptacles, are un-mated, the respective flameproof blanking caps must be installed, and all grub screws secured. Flame-proof blanking caps are a part of the certification, and their use is required, to maintain flameproof worthiness of the connector halves independently, should the circuit be re-energized.



Star-Line EX®

Assembly & Terminating Instructions

Cable Jacket & Wire Stripping

Shell Size	Contact Size AWG(mm)	Mod 1 (Solder Contact) Strip Lengths (mm)		Mod 1 (Pressure Contact) Strip Lengths (mm)		Mod 2 & 3 (Crimp Contact) Strip Lengths (mm)	
		Conductor	Jacket	Conductor	Jacket	Conductor	Jacket
12	18 (0.75mm)	7.2mm	99.2mm	-	90.5mm	11.5mm	90.5mm
	16 (1.5mm)	7.2mm	99.2mm	-	90.5mm	14.6mm	90.5mm
	12 (4.0mm)	8.7mm	99.2mm	17.5mm	90.5mm	15.5mm	90.5mm
	10 (6.0mm)	11.9mm	99.2mm	14.3mm	84.1mm	17.1mm	92.1mm
16	18 (0.75mm)	7.2mm	105.5mm	-	96.8mm	11.5mm	96.8mm
	16 (1.5mm)	7.2mm	105.5mm	-	96.8mm	14.6mm	96.8mm
	12 (4.0mm)	8.7mm	105.5mm	-	96.8mm	15.5mm	96.8mm
	10 (6.0mm)	11.9mm	105.5mm	-	90.5mm	17.1mm	98.4mm
	8 (10.0mm)	15.1mm	105.5mm	-	88.9mm	21.0mm	98.4mm
	4 (25.0mm)	16.7mm	105.5mm	17.5mm	87.3mm	23.0mm	101.6mm
20	18 (0.75mm)	7.2mm	118.2mm	-	109.5mm	11.5mm	109.6mm
	16 (1.5mm)	7.2mm	118.2mm	-	109.5mm	14.6mm	109.6mm
	12 (4.0mm)	8.7mm	118.2mm	-	109.5mm	15.5mm	109.6mm
	10 (6.0mm)	11.9mm	118.2mm	-	103.2mm	17.1mm	111.12mm
	8 (10.0mm)	15.1mm	118.2mm	-	101.6mm	21.0mm	111.12mm
	4 (25.0mm)	16.7mm	118.2mm	17.5mm	101.6mm	23.0mm	113.9mm
	1/0 (50.0mm)	18.3mm	118.2mm	19.1mm	98.4mm	31.0mm	115.2mm
	535MCM (240mm)	50.0mm	118.2mm	-	90.0mm	-	-
	777 MCM (400mm)	50.0mm	130.9mm	-	90.0mm	-	-
24/C24	18 (0.75mm)	7.2mm	130.9mm	-	122.2mm	11.5mm	-
	16 (1.5mm)	7.2mm	130.9mm	-	122.2mm	14.6mm	-
	12 (4.0mm)	8.7mm	130.9mm	-	122.2mm	15.5mm	-
	10 (6.0mm)	11.9mm	130.9mm	-	115.9mm	17.1mm	-
	8 (10.0mm)	15.1mm	130.9mm	-	114.3mm	21.0mm	-
	4 (25.0mm)	16.7mm	130.9mm	17.5mm	100.0mm	23.0mm	-
	1/0 (50mm)	18.3mm	130.9mm	19.1mm	117.5mm	31.0mm	-
	4/0 (120mm)	18.3mm	130.9mm	19.1mm	127.0mm	31.6mm	-
	535 MCM (240mm)	50.0mm	130.9mm	-	90.0mm	-	-
	777 MCM (400mm)	50.0mm	130.9mm	-	90.0mm	-	-
28/C28	18 (0.75mm)	7.2mm	137.3mm	-	125.6mm	11.5mm	-
	16 (1.5mm)	7.2mm	137.3mm	-	125.6mm	14.6mm	-
	12 (4.0mm)	8.7mm	137.3mm	-	125.6mm	15.5mm	-
	10 (6.0mm)	11.9mm	137.3mm	-	122.2mm	17.1mm	-
	8 (10.0mm)	15.1mm	137.3mm	-	120.7mm	21.0mm	-
	4 (25.0mm)	16.7mm	137.3mm	17.5mm	106.4mm	23.0mm	-
	1/0 (50mm)	18.3mm	137.3mm	19.1mm	123.8mm	31.0mm	-
	4/0 (120mm)	18.3mm	137.3mm	19.1mm	133.4mm	31.6mm	-
	350 MCM (185mm)	21.4mm	137.3mm	-	130.1mm	33.5mm	-

Star-Line EX[®]

Assembly & Terminating Instructions

Electrical Connectors with MOD I Inserts

The following table gives the wire sizes and cord/cable types to be used with the Star-line plugs, receptacles and cable connectors. The plugs and cable connectors are intended for connection to 3, 4 or 5 conductor cords/cables depending on the contact insert configuration.

The cord sealing grips range for plugs and cord connectors is 1/8". For instance, if inside dia. of grommet is 3/4" it will seal and grip a cord dia. in the range of .750 dia. max. to .625 dia min. Inside diameter of grommets are in sixteenth of an inch increments.

Amperes Rating of Device	Conductor Size AWG	Type Cord/Cable
20	#14	S, SO
30	#12, #10	S, SO
60	#6, #4	W
100	#0, #1, #2	W
200	#3/0, #4/0	W

There are two types of contacts used in Mod I style inserts, one is solder, the other is pressure. The pressure contacts apply termination force via a set screw, and require being torque to values provided in the table below:

	20 amp. #12 contact	30 amp. #10 contact	40 amp. #8 contact	60 amp. #4 contact	100 amp. #1/0 contact	200 amp. #4/0 contact
Lb-in	N/A	15	25	20	50	100
N-M	N/A	1.7	2.8	2.3	5.7	11.3

A. Prepare end of cable by stripping jacket and insulation per tables shown on previous page. Remove any ridges or grooves by scarfing the edges to provide a smooth surface on the cable to insure good grommet sealing. Tin conductors to be soldered to within 1/16" of insulation. Use only resin flux for all soldering.

B. Slide the EX gland nut, cable grip, or anti-friction washer, grommet and cable adapter, over the cable in the order named. Be sure the right size EX gland or grommet has been selected to obtain a proper seal. See photo "YY".



C. Solder conductors in contacts, if solder type. TO ENSURE ENVIRONMENTAL SEALING, ALL CONTACTS MUST REMAIN IN PLACE EVEN IF EVERY ONE IS NOT BEING USED. The silicone insulation is heat resistant, but reasonable care must be exercised to prevent unnecessary heating. It is recommended that a DC induction soldering unit be used if possible. Do not use open flame soldering. It is recommended that heat shrink be applied over finished termination point.



D. Support the barrel assembly in a vise having smooth-faced jaws; with female receptacle have flange secured in vice for holding steady. The plug and receptacle keyways/keys are designed to withstand the assembly torque. See photo "MM".



E. Apply cable adaptor or insulation clamp nut by strap wrench, turning counterclockwise (left hand thread) until hand-tight. APPLY STRAP WRENCH TO CABLE ADAPTER OR INSULATION CLAMP AND TIGHTEN UNTIL IT SHOULDERS FULLY ON BARREL. Substantial resistance should be felt by assembler as he rotates adapter on final revolution. See photo "PP".

F. Slide Ex gland or grommet into cable adapter and engage either cable grip, or gland washer and gland nut. DRAW UP TIGHT WITH WRENCH. If mechanical clamp nut is used, tighten clamp screws as final step.

NOTE 1. Photo "YY" is an example of EX-13-3 Series Plug using Exd gland.



Star-Line EX® Assembly & Terminating Instructions

Electrical Connectors with MOD II Inserts

Individual contacts are crimped to their respective conductors outside of the connector where ample working space is available. The crimping operation can be done by hand or power operated tools. Reference page 86 of this catalog for proper tool information.

Terminated contacts are individually inserted into the insulation with a contact insertion tool. See photo “JJ”. Contacts may be inserted and removed without degrading contact retention or environmental capability. The front rigid portion of the insert functions to stabilize and ensure positive alignment of the contacts.

Contact cavities are clearly numbered on the front and rear insert face to facilitate identification during assembly, inspection, and maintenance.

All contact cavities, whether used or not, **must be populated** in order to maintain certification and proper environmental sealing.

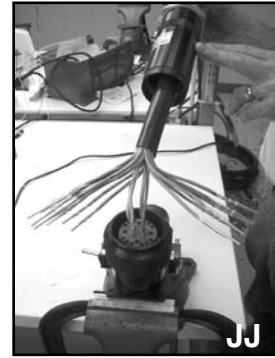

For Electrical Connectors with MOD III Inserts

Mod III connectors contain insulations that are factory installed and locked into position with a non-removable retaining ring. Each insulator assembly contains a resilient seal interposed between two rigid plastic insulators. Mod III contacts are rear insert-able and rear release-able for quick and easy circuit changes. Mod III contacts are retained in their respective cavities by means of collapsible metal collets. The main advantage of collet style retention are lower insertion forces, eliminating need for insertion tools, and higher retention forces. Contact cavities are clearly numbered on the front and rear insert face to facilitate identification during assembly, inspection, and maintenance. All contact cavities, whether used or not, **must be populated** in order to maintain certification and proper environmental sealing.

All connectors are shipped with the inserts factory installed in the barrel shell, and in the specified key position.

CRIMPING CONTACTS: Contacts are crimped outside of the connector with a proper tool. Check through the inspection hole in contact to make certain wires are fully bottomed in well before crimping.

Panel Mounting a Receptacle

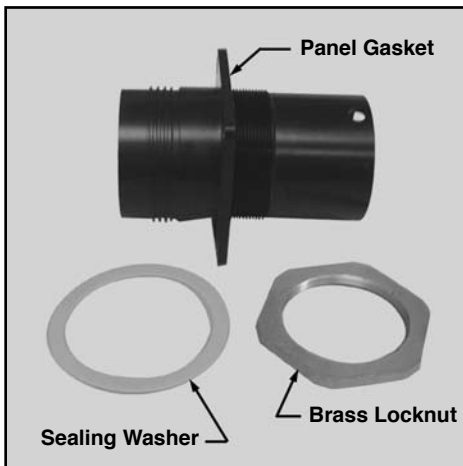

1. The panel receptacle is comprised of two basic pieces. The first is the actual panel receptacle assembly, where the mating plug enters, and the second is the panel adapter/potting chamber.
2. Following the termination and/or insertion of the contacts into their representative cavities, the panel adapter is the firmly tightened all the way until travel ceases.
3. The potting step can then be completed. After the potting compound has hardened, the completed receptacle assembly can be installed into the enclosure.
4. The square panel gasket is furnished for installation on the outer surface of the enclosure behind the square flange. The sealing washer and brass locknut should be fully tightened with proper tools. Following this step four proper length 10mm screws should be installed into holes in corner of front flange. (Brass locknut is not required when threading receptacle assembly into a flameproof enclosure.
5. For all increased safety panel mount receptacles:
In accordance with EN50019:2000, Clause 7.1, the increased safety enclosure certificate must include the use of the device as well as an electric strength test on the finished assembly.
6. The panel mount variant shall be installed in a suitably certified and dimensioned flameproof equipment when it's certificate allows such installation.

Star-Line EX[®] Potting Instructions

All cable adapters, other than ones suited for mating with an EX-certified gland, must be filled with encapsulant (potted). The material certified for use in filling this connector line is to be supplied by Amphenol Industrial part number 10- 838535. The user or installer shall consider the performance of these materials with regard to attack by aggressive substances that may be present in the hazardous area. This material is a two-component casting system with a 1:1 volumetric mix ratio. It has low exothermic qualities, peaking at only 102°F during cure. The material starts to harden in under 2 hours and fully cures at room temperature in 24. It can be quick cured in 2 hours at 140°F. The product is available in easy “mix & dispense” cartridges. More information is available by contacting:

Amphenol Industrial Operations, Technical Support
Phone: (520) 285-5130

Filling Depths

The Cable Adapter should be filled with the encapsulant to the following levels:

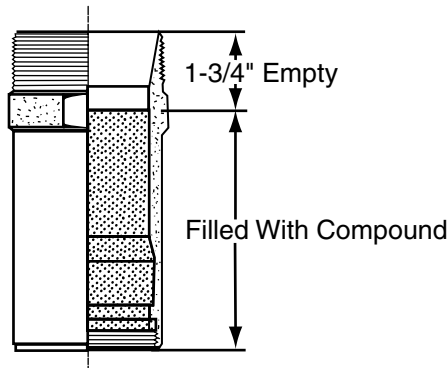

Cable Adapter

- In-line cable adapters are filled to within one & three quarter inches (1³/₄) of the end of the adapter. The goal is to have all the volume filled without interrupting the cable grommet from seating when the strain relief nut is installed.

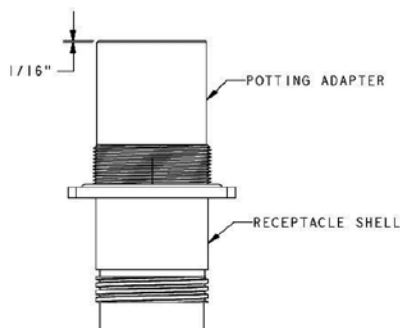

Panel Adapter (shown above)

- Bulkhead adapters should be filled to within 1/16” of the top.

Mixing Instructions

- CAUTION: Wear goggles or other eye protection during all operations.
- Remove the tape band from the mid-section of the cartridge.
- Squeeze cartridge slightly in area of the removed tape band to deform foil barrier.
- Push the threaded end of the mixing rod into small and fully threaded into it's mating thread within the tube.
- Push the mixing rod to the bottom of cartridge and begin plunging the mixing rod, the full length of the cartridge, while rotating the mixing rod approximately 90° with each stroke. Mix for the total number of 50 strokes. A stroke is one complete in and out cycle. On the last stroke, mixing rod should be fully extended outward.
- Grasp the cartridge firmly at the neck of the tube, and unscrew the mixing rod by turning counterclock-wise approximately 3 turns. Remove mixing rod.
- Install nozzle and remove bottom cap.
- Load tube into a standard painters caulk gun.
- Pot connectors in mated condition to assure contact alignment.
- Potting not required when using Exd/Exe gland option for plugs and in-line receptacles.



Star-Line EX[®] Potting Instructions

Volume Chart

The following chart illustrates how much potting compound is needed per connector. This is based on fill lengths of 3-7/8" (in-line adapters) and 1-3/4" (Panel mount adapters) and the smallest allowable cable diameter included for each particular shell.

* Note: These volumes are estimated. Necessary volumes may vary depending on conductor count, insulation, and jacket thickness.

Shell Size	Approx. Cement usage in a 6" cable adapter* (Fluid Ounces)	Approx. Cement usage in a bulkhead adapter* (Fluid Ounces)
12	1.6	.5
16	3.5	1.1
20	6.1	2.1
24	9.0	3.3
28	11.1	4.5

Recommendations

It is recommended where possible, that when mated sets of connectors are potted that the connector with the female insert be potted first, allowed to set and then the male be potted while it is mated to the previously potted female connector. This will ensure that the male contacts will be seated or 'aimed' properly at the female socket contact opposite it. The male contacts have a given amount of movement while not engaged, and if during initial potting procedures the male contacts are positioned beyond this movement range, they will not properly make contact with the socket contact.

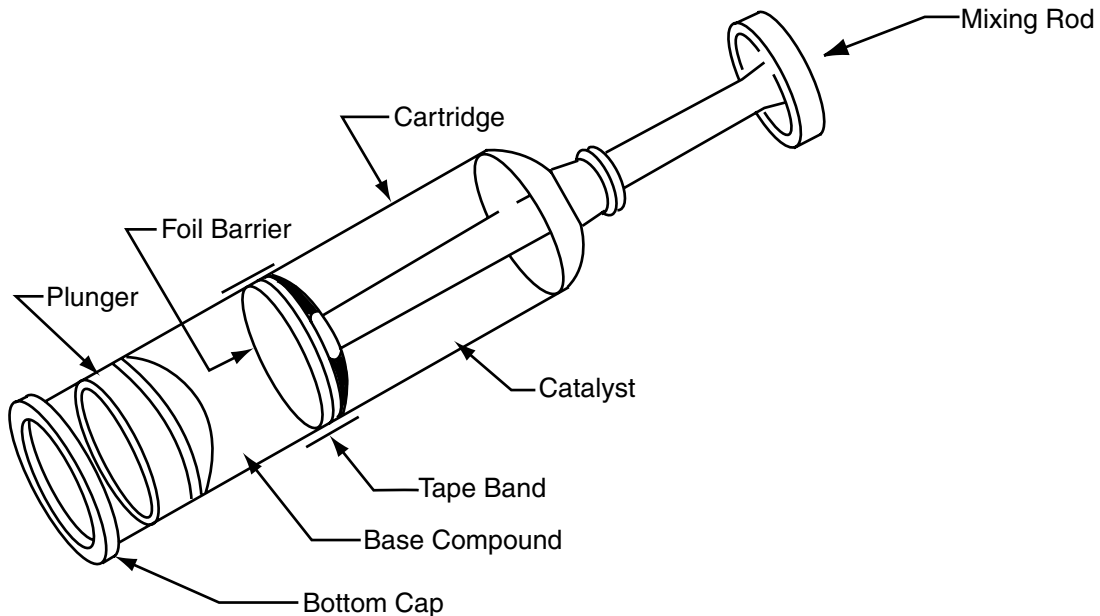



Rig-Power® Connectors (1000v AC/DC)

Connector Style	Insert Gender	Standard Part Number*	RIG-Radsok® Part Number*
Plug w/ Mech. Clamp	Dead Front Pin (Line side)	RIG-10P▲-XX-M-◆	RIG-R10P▲-XX-M-◆
Plug w/ Mech. Clamp	Socket Contact (Load Side)	RIG-10S▲-XX-M-◆	RIG-R10S▲-XX-M-◆
Cable Receptacle w/ Mech. Clamp	Dead Front Pin (Line side)	RIG-15P▲-XX-M-◆	RIG-R15P▲-XX-M-◆
Cable Receptacle w/ Mech. Clamp	Socket Contact (Load Side)	RIG-15S▲-XX-M-◆	RIG-R15S▲-XX-M-◆
Fixed Cable Receptacle w/ Mech. Clamp	Dead Front Pin (Line side)	RIG-17P▲-XX-M-◆	RIG-R17P▲-XX-M-◆
Fixed Cable Receptacle w/ Mech. Clamp	Socket Contact (Load Side)	RIG-17S▲-XX-M-◆	RIG-R17S▲-XX-M-◆
Panel Mount Receptacle (Bus Bar)	Dead Front Pin (Line side)	RIG-17PR-◆	RIG-R17PR-◆
Panel Mount Receptacle (Bus Bar)	Socket Contact (Load Side)	RIG-17SR-◆	RIG-R17SR-◆
Panel Mount Receptacle (Direct Cable Entry)	Dead Front Pin (Line side)	RIG-17PN-◆	RIG-R17PN-◆
Panel Mount Receptacle (Direct Cable Entry)	Socket Contact (Load Side)	RIG-17SN-◆	RIG-R17SN-◆

* ▲ Select Cable Size. See Cable Size & Amperage Guide below.
 XX - Select Cable Diameter Code #. See Grommet Selection Guide below.
 M designates Mechanical Clamp (For basketweave grip substitute K for M).
 ◆ Select standard color code from Color Code options below.
 Use Crimp Tool: T&B #TBM15

NOTE: Radsok® version not backward compatible with original contact design

Cable Size & Amperage Selection Guide (▲)

Cable Size	Standard Amperage	RIG-Radsok® Amperage	TBM 15 Die Code No.
2 = 313 kcmil	625	925	76
3 = 373 kcmil	700	1000	87
4 = 444 kcmil	800	1200	107
5 = 535 kcmil	900	1350	107
6 = 646 kcmil	1000	1500	107
7 = 777 kcmil	1135	1500	115

RIG-Power Grommet Selection Guide (XX)

Cable Diameter	Code No. (XX)
1.000-1.125	18
1.125-1.250	20
1.250-1.375	22
1.375-1.500	24
1.500-1.625	26
1.625-1.750	28
1.750-1.875	30

Color Code Options (◆)

Current Type	DC				AC			
	Blue	Orange	Yellow	Brown	Red	White	Black	Green
Standard Color Code	Blue	Orange	Yellow	Brown	Red	White	Black	Green
Part Number Suffix ◆	-BL	-OR	-Y	-BR	-R	-W	-BK	-G



NOTE: It is the responsibility of the user to ensure other components of their system have equal/greater amperage carrying capacity.

Single Pole Power



RIG-R10P7-22-M-R
RIG-Power® Plug w/Radsok® Pin
(Color Code Red)



RIG-R17SR-R
RIG-Power® Receptacle w/Radsok®
Busbar Socket (Color Code Red)



Mated Pair Starline EX Rig-Power w/Radsok®



EX-13-3-D2-C24-R386PN
StarLine EX Plug w/Radsok® Pin



EX-17-1-C24-R386SR
Starline EX Receptacle
w/Radsok® Socket

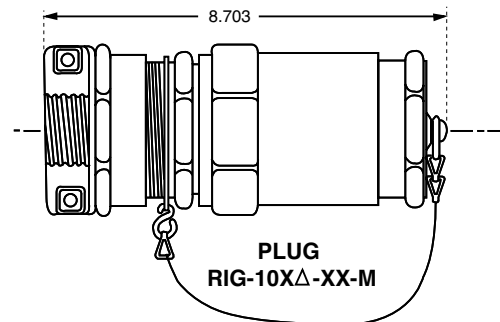
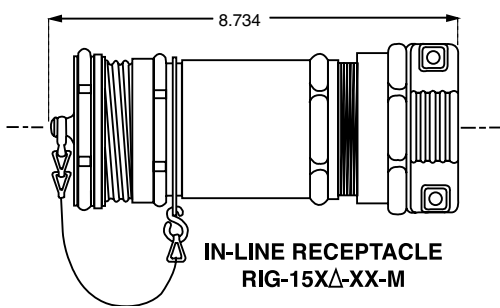

NOTE:
See page 20, shell size
C24 for full mounting
dimensions.

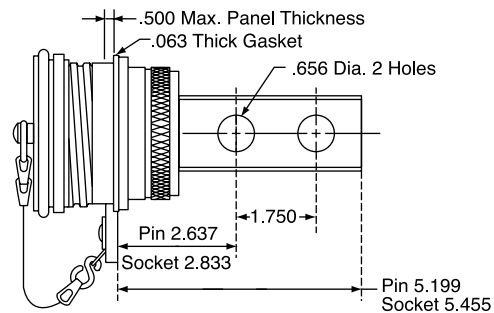
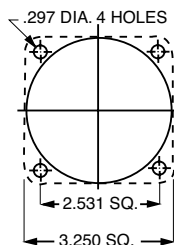

Single Pole Power Connectors

P-500™ / PD-501 POWER Connectors

Ampacity	Wire Size	Type of Termination	Gender	Part Number	Boot Part # (See Color Code)	Cable Sealing Range
900*	-	Stud	Socket	P-500126-BS-◆	-	-
900*	535MCM	Solder	Pin	PD-501-L	TMPC-10-◆	1.125 - 1.500
900*	535MCM	Crimp	Pin	P-500126-P	TMPC-10-◆	1.125 - 1.500
325	313MCM	Solder	Pin	PD-501-S	TMPC-10-◆	1.125 - 1.500

Note: Connectors are rated at 1000 Volts AC/DC when mounted on 5" centers.

Copper alloy, silver plated contacts for maximum conductivity.

Crimp tool required for P-500126-P is Thomas & Betts hex crimp using Tool # TBM15 & die catalog #15505 or BURNDY "YA"

* When used with 125° C rated cable.



TMPC-10-R

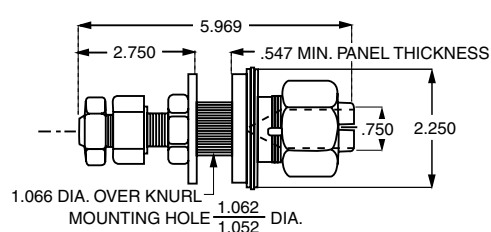

PANEL BOARD SOCKET
P-500126-BS

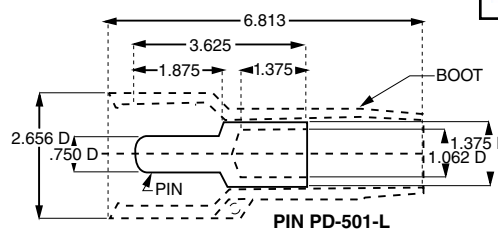

PIN PD-501-L

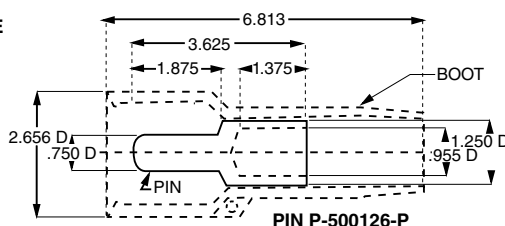

PIN P-500126-P

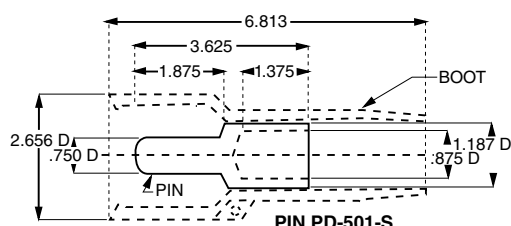

PIN PD-501-S

TMPC™ Connectors

Gender	Type of Termination	With Standard Contacts		With Radsok Contacts		Wire Size	Boot Part No.	Cable Sealing Range
		Part Number	Current Range	Part Number	Current Range			
Socket	7/8" Stud/Panel Board	TMPC-41777-L-◆	900-1135 amps	TMPC-41777-RL-◆	1500	N/A	N/A	N/A
Socket	2 Hole Bus Bar	TMPC-41777-24L	900-1135 amps	TMPC-41777-R24L	1500	N/A	N/A	N/A
Pin	Crimp	TMPC-40535-L	900 amps	TMPC-40535-RL	1500	444-535 kcmil	TMPC-10-◆	1.125-1.500
Pin	Crimp	TMPC-40777-L	900-1135 amps	TMPC-40777-RL	1500	646-777 kcmil	TMPC-10-◆	1.125-1.500

Note: TMPC Connectors are rated at 1000 Volts AC/DC when mounted on 5" centers.

Material is copper alloy, silver plated for maximum conductivity and corrosion resistance.

Recommended crimping tools are as follows: Anderson (Square D) Versa Crimp VC8 (four indent).

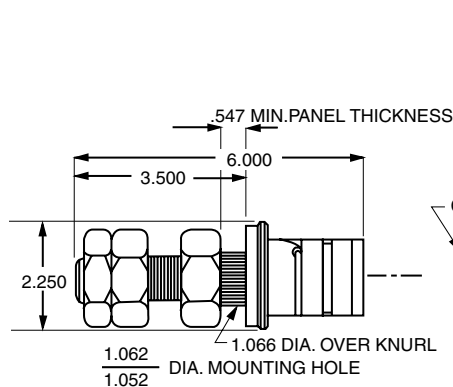

PANEL BOARD SOCKET
TMPC-41777-L

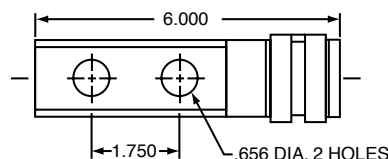
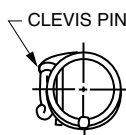
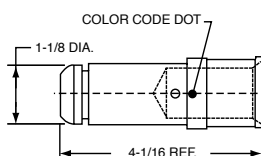

MOTOR BUS BAR MOUNT
SOCKET TMPC-41777-24L

TMPC POWER MOUNT



Amphenol® TMPC POWER MOUNT Flange Mounted Traction Motor Power Connector series featuring RADSOK® Contacts.

Amphenol Industrial Operations introduces the addition of our “NEW” TMPC Power Mount flange mounted connector series. The New TMPC Power Mount series is an addition to our time tested TMPC Single Pin power connector line. The TMPC Power Mount incorporates our existing TMPC connectors with RADSOK® contacts into our new thermoplastic molded receptacle flange.

Available in color codes per the NEC AC/DC Electrical requirements, the TMPC Power Mount series is designed to work with current IEEE Type P drilling cables (sizes range from 313 MCM through 777 MCM). The RADSOK® contacts allow for higher amperages and reduced insertion/removal forces when compared to similar products in the market.

Features & Benefits:

- RADSOK contact provide increased amperages than competition
- Contacts rated at 1500 amp for 777 MCM cables
- Contacts machined from high grade aluminum to offer longer life, more mating cycles
- Lower insertion/removal forces is a by-product of our RADSOK contacts
- Molded flange base mounts directly to Stainless or Aluminum panels, thus eliminating the need for added secondary mounting fixtures
- Color coded mounting bases and cable side boots available to help prevent cross mating, while allowing easier electrical phase identification
- Connector series comes complete with molded Hypalon caps and insulation boots
- Patent Pending

PLUG KIT PART NUMBER

COLOR	313 MCM	444 MCM	535 MCM	646 MCM	777 MCM
BLACK	TMPC-SP3-BK	TMPC-SP4-BK	TMPC-SP5-BK	TMPC-SP6-BK	TMPC-SP7-BK

COLOR OPTIONS AVAILABLE:
Black, Blue, Brown, Green, Gray,
Orange, Purple, Red, White, Yellow

- Plug Kit Consist of:
- Pin Contact
 - Boot (color designation)
 - Rubber Cover



RECEPTACLE KIT PART NUMBER

COLOR	FLANGE KIT W/ CONTACT	FLANGE KIT LESS CONTACT	BOOT PART
Black	TMPC-SR-BK	TMPC-SRLC-BK	TMPC-10-BK

COLOR OPTIONS AVAILABLE: Black, Blue,
Brown, Green, Gray, Orange, Purple, Red, White,
Yellow

- Receptacle Kit Consist of:
- Socket Contact (affixed into the flange)
 - Flange (color designation)
 - Rubber Cover



CONTACTS ONLY (FOR PIN RETENTION RING ADD -RR)

CABLE SIZE	BUSBAR CONTACT
313-777 MCM	TMPC-1
CABLE SIZE	PIN CONTACT
313-535 MCM	TMPC-40535-RL
646-777 MCM	TMPC-40777-RL

ACCESSORIES

DESCRIPTION	PART NUMBER
RECEPTACLE CAP	TMPC-SR-CAP
BOOT CAP	TMPC-SP-CAP
MOUNTING GASKET	TMPC-SR-G
BOOT RING 313 MCM	SR1-313R
BOOT RING 444 MCM	SR1-444R
BOOT RING 535 MCM	SR1-535R
BOOT RING 646 MCM	SR1-646R
BOOT RING 777 MCM	SR1-777R

Insert Configuration Listing

For Amphenol®/ Pyle® Star-Line, Star-Lok and Star-Line EX Connectors

Introduction

The Amphenol/Pyle Star-Line Insert Configuration Listing is issued primarily to identify various contact insert arrangements. For the engineer, it provides visual selection of the insert configuration needed to satisfy his requirements. For the end user, the list provides general information useful in the termination of plugs and receptacles. To aid the reader, the insert configurations are presented in numerical order, based on the number of contacts in each.

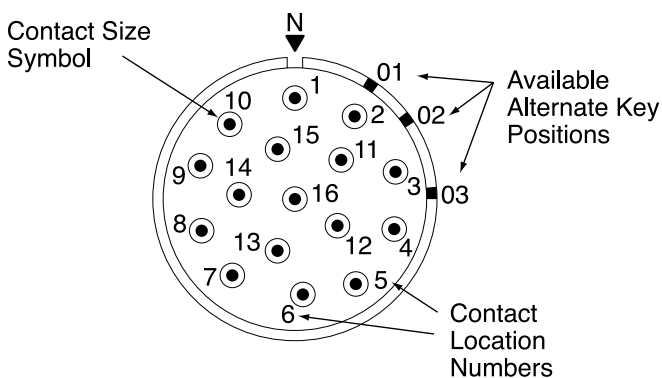

The male insert illustration shown left (and those on the following pages) is shown as it appears when viewed from the front. Contacts are shown by both physical position within the configuration and by contact number. The contact number corresponds to the contact position shown on the rear face of the insert illustrated as well as to both the front and rear faces of the mating insert. The symbol used to show contact location is indicative of contact size. For example, the contact symbol in this illustration represents a #8 contact. An explanation of contact symbols is presented on each page of the listing. Each drawing also provides data on normal and alternate key positions. Drawings are reduced from actual size of the insert configuration.

NOTE: Alternate keying or insert polarization is intended to resist improper intermating of plugs and receptacles of like shell sizes and like insert arrangements.

Contact Insert Ordering

Plug and receptacle contact inserts are selected according to requirements for Service Voltage Rating, Number of Contacts, Wire Size and Ampere Rating.

Mod I and II inserts may be purchased separately for assembly into the basic barrel. The Catalog Number for each is shown on the chart accompanying each drawing. Pin or socket inserts are interchangeable in male and female barrels.

Mod III inserts, as a unit, cannot be purchased separately because contact inserts are factory assembled to, and sealed in, the basic barrel. The Dash Number given with each Mod III configuration must be shown as a suffix to the basic barrel Catalog Number to identify the insert desired.

Arrangements are available with high amperage RADSOK® contacts specifically designed for Star-Line inserts. These are designated with an 'R' in the part number. For example: ZP-C28-R42PR would designate an insert with size 4/0 RADSOK pin contacts. ZP-C28-R42SR would designate an insert with size 4/0 socket contacts.

ELECTRICAL Ratings

Service Voltage Ratings

The voltage to which contact inserts are limited is a function of the dielectric separation between adjacent contacts and between contacts and shell.

The voltage rating is designated by a service voltage rating letter which is shown in the service voltage rating table with each contact configuration listing.

Service Voltage	Military Ratings MIL-5015 Specifications Non-Circuit Breaking		N.E.C. Ratings		Over Surface Distance Inches Nominal	Thru-Air Spacing Inches Nominal
			Non-Circuit	Circuit Breaking		
	D.C. Volts RMS	A.C. Volts RMS	D.C. RMS	A.C. RMS		
Instrument	250	200	–	–	1/16	–
A	700	500	250	240	1/8	1/16
D	1250	900	600	600	3/16	1/8
E	1750	1250	600	600	1/4	3/16
B	2450	1750	600	600	5/16	1/4
C	4200	3000	600	600	1	5/16

Three Classifications of Ampere Ratings

MS Ampere Ratings: (MIL-C-39029)

Based on the combination of the following:

The amount of current which an individual pin and socket contact may carry is a function of contact material and design efficiency of the pin and socket system as well as the ability of the primary conductor insulation to resist temperature rises due to inherent copper losses and bundling factors.

Total current carrying capacity of the connector is a function of the insert temperature which is rated at 225° F (107° C) for continuous operation. The total operating temperature is the summation of the ambient temperature plus the temperature rise resulting from the thermal losses of each contact.

MIL-W-5088 specifications may be used as a general reference on the subject inasmuch as pertinent cable derating data is included.

N.E.C. Non-Circuit-Breaking or Disconnect Ampere Ratings

The non-interrupting current ratings, shown in the table, are based on the temperature of the contacts being within the range specified by Underwriter's Laboratories, Inc. when wire sizes are selected in accordance with the National Electrical Code.

When multiple conductors are used, the load factor and temperature rise based on ambient and total insert temperature must be taken into consideration..

Contact Size AWG/ MCM	Non-Circuit Breaking Ampere Rating		† MV Drop	
	MS	N.E.C. ***	Solder Contacts	Crimp Contacts
#18	–	9	22	30
#16	13	16	21	29
#12	23	30	20	27
#10	33	40	16	26
# 8	46	50	12	23
# 4	80	90	10	22
#1/0	150	155	10	22
#4/0	225	225	8	22
350 MCM	–	325	8	–
500 MCM	–	750	–	30
535 MCM	–	839	–	–
646 MCM	–	937	–	–
777 MCM	–	1048	–	–

NOTE: The N.E.C. circuit breaking and non-circuit breaking ratings are based on test results of contacts and connectors. Consult the N.E.C. when selecting wire/cable for specific applications. Under certain conditions, a wire size may be rated higher or lower than the table indicates for a given contact size.

† Measurements made at extreme ends of mated contacts with probe touching contact and wire (MIL-5015 specifications).

** Based on temperature rise (National Electrical Code Requirement).

*** Based on Arcing Control (National Electrical Code Requirement).

For Amphenol Star-Line product insert de-rating information per the National Electric Code, please consult the Amphenol Industrial website, www.amphenol-industrial.com. Chart is located under LITERATURE tab.

Spare/Replacement Contacts for MOD II and MOD III Inserts

Contacts are machined copper alloy ranging in size (AWG) from #18 to 500 MCM.

Standard line contacts are silver plated but can also be furnished with gold over silver, gold over nickel, and other combinations of plating systems available upon request.

Pin contacts are of blended geometry to provide extra strength and protection against damage. Socket contacts are the closed entry type.

Contacts for MOD I inserts are not listed because these inserts are factory assembled and damage may be done to the resilient center insulation if contacts are inserted or removed by inexperienced personnel in the field.

MOD II

Size Awg/MCM	"W" Length	"C" Length	"W" Ground	Polarizing Standard	Polarizing "C"
18 Pin 18 Socket	ZP-4018-36L ZP-4118-36L				
16 Pin 16 Socket	ZP-4016-36L ZP-4116-36L		ZP-4016-37L		
12 Pin 12 Socket	ZP-4012-36L ZP-4112-36L		ZP-4012-37L3		
10 Pin 10 Socket	ZP-4010-36L ZP-4110-36L		ZP-4010-37L2		
8 Pin 8 Socket	ZP-4008-66L ZP-4108-66L				
4 Pin 4 Socket	ZP-4004-66L ZP-4104-66L			ZP-4804-66L ZP-4904-66L	
1/0 Pin 1/0 Socket	ZP-4100-66L	ZP-4000-66LB		ZP-4900-66LK	ZP-4800-66LKB
4/0 Pin 4/0 Socket	ZP-4141-76L	ZP-4041-76LB			
500 MCM Pin 500 MCM Socket		P-206053-CP P-206053-CS			
535 MCM Pin 535 MCM Socket		RIG-C24-535PN RIG-C24-535SN			
646-777 MCM Pin 646-777 MCM Socket		RIG-C24-386PN RIG-C24-386SN			

"W" length represents standard insert length for sizes 12, 16, 20 24 and 28. "C" length represents longer insert length for sizes C20, C24 and C28. Contacts in "C" length inserts are 1/2" longer than standard. Ground contacts are 1/8" longer than standard. Ground clips are part of inserts. "C" length ground contacts are 1/8" longer than "C" length line contacts.

For Amphenol Star-Line product insert de-rating information per the National Electric Code, please consult the Amphenol Industrial website, www.amphenol-industrial.com. Chart is located under LITERATURE tab.

Termination Data

Amphenol – Pyle Connectors Corporation's tools for contact crimping, insertion and removal are required for terminating and assembling contacts.

Contact Dimensions						
Contact Size AWG (mm)	WIRE WELL DIMENSIONS					
	Solder Mod I		Crimp* Mod II		Crimp* Mod III	
	Diameter	Depth	Diameter	Depth	Diameter	Depth
#18 (0.75)	.060" (1.52)	13/64" (5.15)	.059" (1.49)	3/8" (9.52)	.058" (1.47)	3/8" (9.52)
#16 (1.5)	.079" (2.00)	13/64" (5.15)	.079" (2.00)	1/2" (12.70)	.079" (2.00)	1/2" (12.70)
#12 (4.0)	.117" (2.97)	17/64" (6.47)	.113" (2.87)	17/32" (6.74)	.113" (2.87)	17/32" (13.49)
#10 (6.0)	.142" (3.61)	25/64" (9.92)	.142" (3.60)	19/32" (15.09)	.142" (3.60)	19/32" (15.08)
#8 (10.0)	.210" (5.33)	33/64" (9.12)	.189" (4.80)	3/4" (19.05)	.188" (4.77)	3/4" (19.05)
#4 (25.0)	.333" (8.45)	37/64" (14.63)	.289" (7.34)	53/64" (21.03)	.278" (7.06)	53/64" (21.03)
1/0 (50.0)	.470" (11.94)	41/64" (16.27)	.445" (11.30)	1-1/8" (28.58)	.455" (11.56)	15/16" (23.81)
4/0 (120.00)	.656" (16.7)	57/64" (22.62)			.656" (16.7)	15/16" (23.81)
350MCM (185.00)	.798" (20.27)	1-1/8" (28.58)				
500 MCM (240.00)			1.00" (25.40)	1-3/8" (34.93)		

* Crimp contacts have inspection hole.

Crimp Data		
Contact Size	Conductor Wire Size (AWG) Crimped	Crimp Retention Min. Force Lbs. (N)
#18 (0.75)	#18	38 (169.0)
	#20	19 (84.5)
	#22	15 (66.7)
#16 (1.5)	#16	50 (222.4)
	#18	38 (169.0)
	#20	19 (84.5)
#12 (4.0)	#12	110 (489.3)
	#14	70 (311.4)
	#16	50 (222.4)
#10 (6.0)	#10	180** (800.7)
	#12	110 (489.3)
	#14	70 (311.4)
#8 (10.0)	#8 to #10	225 (1000)
	#10	180 (800)
#4 (25.0)	#4 to #6	400 (1779)
	#6	300 (1334)
1/0 (50.0)	#2 to 1/0	550 (2447)
	1/0	700 (3114)
4/0 (120.00)	4/0	875 (3892)
	3/0	825 (3670)
	2/0	750 (3336)
500(240.00)	500 MCM	2500 (11120)
535 646 777	Recommend using Thomas & Betts TBM 15 crimp tool with appropriate sized dies.	

Torque Data for Pressure Contacts MOD I		
Contact/Conductor Size/Awg (mm)	Torque Req. In./Lbs. (N·m)	Retention Force Lbs. (N)
4/0 (120.00)	100 (11.3)	4/0 450 (2001.7)
		3/0 350 (1556.9)
		2/0 300 (1334.5)
1/0 (50.0)	50 (5.7)	1/0 250 (1112.0)
		#1 200 (889.6)
		#2 180 (800.7)
#4 (25.0)	20 (2.3)	#4 140 (622.8)
		#6 100 (444.8)
		#8 90 (400.3)
#8 (10.0)	25 (2.8)	#8 75 (333.6)
#10 (6.0)	15 (1.7)	#10 80 (355.9)
		#12 70 (311.4)
		#14 60 (266.9)

** Stranded wire

Thermocouple Contacts

Thermocouple contacts are available for use in all insert configurations. Contact can be either purchased separately or included in the insert/connector-please coordinate with the factory on this latter option. For crimp terminations-see tools shown on page 76. When soldering, please adhere to the following procedures: (1) clean wire and solder well with stainless scratch brush. (2) Use Handy and Harman Silver Solder Flux. (3) Use Handy and Harman AMS 2665 Silver Solder with flame torch. **IMPORTANT-Use** extreme care to prevent overheating the female contact, otherwise tension will be lost and result in poor contact. (4) Clean flux from all surfaces using boiling water or steam.

MOD I & II

Size	Gender	Cat. No.	Color Code	Thermocouple Material*
#16	Pin	ZP-4016-10MF	Black	Iron
	Socket	ZP-4116-10MF		
#16	Pin	ZP-4016-10NF	Yellow	Constantan
	Socket	ZP-4116-10NF		
#16	Pin	ZP-4016-10PO	White	Chromel
	Socket	ZP-4116-10PO		
#16	Pin	ZP-4016-10RO	Green	Alumel
	Socket	ZP-4116-10RO		
#16	Pin	ZP-4016-10CF	Red	Copper
	Socket	ZP-4116-10CF		

Table Temperature Range of Thermocouple Material

Material*	Temperature Range	
	Degrees Continuous	Short Time
Electrolytic Copper & Constantan	190-350°C	to 600°C
Chromel & Constantan	0-900°C	to 1100°C
Iron & Constantan	0-1100°C	to 1100°C
Chromel & Alumel	0-1100°C	to 1350°C

ISA Symbol	Nomenclature*	ISA Color Coding			Military Color Coding		Conductor Identification	
		(+)	(-)	Jacket	(+)	(-)	Positive (+)	Negative (-)
J	Iron/Constantan	White	Red	Black	Black	Yellow	Magnetic	Non-Magnetic
K	Chromel/Alumel	Yellow	Red	Yellow	White	Green	Non-Magnetic	Magnetic
T	Copper/Constantan	Blue	Red	Blue	Red	Yellow	Copper Color	Non-Magnetic
E	Chromel/Constantan	Purple	Red	Purple	White	Yellow	Non-Magnetic	Silver Color Non-Magnetic
B	Copper/Copper	Black	White	Black	Red	Red	Copper Color	Non-Magnetic
S	Alloy #11							

* Chromel and Alumel are registered trademarks of Hoskins Manufacturing Company.

For Amphenol Star-Line product insert de-rating information per the National Electric Code, please consult the Amphenol Industrial website, www.amphenol-industrial.com. Chart is located under LITERATURE tab.

Insert Configuration Index

For drawings and further information of insert arrangements listed see the referenced page numbers. Arrangements with RADSOK contacts are designated with an 'R' in front of the dash number in the part number. For availability of other arrangements, consult Amphenol Industrial Operations.

Insert Arrangement Number	MOD I	MOD II	MOD III	Radsok Contacts	Total Number of Contacts	18 (0.75)	16 (1.5)	12 (4.0)	10 (6.0)	8 (10.0)	4 (250)	1/0 (50.0)	4/0 (120.0)	313MCM	350 MCM (185.0)	373 MCM	444 MCM	535 MCM (240.0)	646-777 (300-400)	Page No.
RIG-C24-386		X			1														1	54
RIG-C24-R386		X		X	1														1	54
RIG-C24-535		X			1													1		54
RIG-C24-R535		X		X	1													1		54
RIG-C24-313		X			1									1						54
RIG-C24-R313		X		X	1									1						54
RIG-C24-373		X			1											1				54
RIG-C24-R373		X		X	1											1				54
RIG-C24-444		X			1												1			54
RIG-C24-R444		X		X	1												1			54
ZP-12-310		X(G)		X	7			7												64
ZP-12-14	X				4				4											56
ZP-12-314		X			4				4											56
ZP-12-316		X			4				4											56
ZP-12-22	X(G)				4				4											56
ZP-12-322		X(G)			4				4											56
ZP-12-323		X			17	17														70
ZP-12-24	X				5			5												59
ZP-12-324		X		X	5			5												59
ZP-12-326		X			5		3			2										61
ZP-12-27	X				3			3												55
ZP-12-327		X		X	3			3												55
ZP-12-330		X(G)		X	3			3												55
ZP-12-33	X				4		4													56
ZP-12-333		X			4		4													56
ZP-12-334		X(G)			10		10													67
ZP-12-348		X			7		7													64
ZP-12-53	X(G)				5			5												59
ZP-12-653			X(G)		5			5												59
ZP-12-354		X		X	7			7												65
ZP-12-355		X			10		10													67
ZP-12-56	X(G)				3				3											55
ZP-C-16-341	X												1							54
ZP-16-312		X(G)		X	19			19												71
ZP-16-16	X				5				5											59
ZP-16-316		X			5				5											59
ZP-16-321		X			37		37													74
ZP-16-22	X				4					4										57
ZP-16-322		X			4					4										57
ZP-16-324		X			18		16		2											70
ZP-16-325		X			16		16													69
ZP-16-28	X				4					4										57
ZP-16-328		X			4				4											57
ZP-16-29	X				9		8				1									66
ZP-16-333		X			61	61														79
ZP-16-335		X			27		24	3												73
ZP-16-37	X				26	18	4	4												73
ZP-16-38	X(G)				4					4										57
ZP-16-638			X(G)		4					4										57
ZP-16-640			X		55	55														77
ZP-16-344		X			21		11	10												72
ZP-16-346		X			9			6		3										66
ZP-16-349		X			14		12				2									68
ZP-16-355		X			19		19													71

(G) depicts arrangement with grounded contact

Insert Configuration Index

For drawings and further information of insert arrangements listed see the referenced page numbers. Arrangements with RADSOK contacts are designated with an 'R' in front of the dash number in the part number. For availability of other arrangements, consult Amphenol Industrial Operations.

Insert Arrangement Number	MOD I	MOD II	MOD III	Radsok Contacts	Total Number of Contacts	18 (0.75)	16 (1.5)	12 (4.0)	10 (6.0)	8 (10.0)	4 (250)	1/0 (50.0)	4/0 (120.0)	350 MCM (185.0)	500MCM (240.0)	646-777 (300-400)	Page No.
ZP-16-70	X				3						3						55
ZP-16-371	X			46	45	45				1							76
ZP-16-373		X(G)			27		24	3									73
ZP-16-74	X(G)				3						3						55
ZP-16-75	X(G)				5					5							59
ZP-16-376		X(G)			10			6	4								67
ZP-16-377		X		X	19			19									70
ZP-16-378		X(G)			7			7									65
ZP-16-381		X			10			6	4								67
ZP-20-313		X			68		68										79
ZP-20-323		X			38		35		3								75
ZP-20-329		X			64		62		2								79
ZP-20-331		X			22		20			2							73
ZP-20-32	X				20			20									72
ZP-20-332		X		X	20			20									72
ZP-20-334		X			20		16			4							72
ZP-20-35	X				60		60										78
ZP-20-38	X(G)				5						5						60
ZP-C20-40	X(G)				4							4					57
ZP-C20-640			X(G)		4							4					57
ZP-C20-42	X				4							4					58
ZP-20-43	X(G)				6				2		4						62 & 82
ZP-20-643			X(G)		6				2		4						62
ZP-20-344		X			81	70		11									80
ZP-20-345		X			90	90											80
ZP-20-46	X				6						4	2					62
ZP-20-646			X		6						4	2					62
ZP-20-48	X				6			3				3					62
ZP-20-648			X		6			3				3					62
ZP-20-49	X				5			3				2					61
ZP-20-649			X		5			3				2					61
ZP-20-350		X(G)		X	37			37									75
ZP-20-354		X			47		45			2							76
ZP-20-55	X				10			8				2					68
ZP-20-358		X			16					16							70
ZP-20-359		X			7					7							65
ZP-20-673			X		50		46			4							77
ZP-20-374		X			27			25			2						74
ZP-20-375		X			12				12								68
ZP-20-376		X		X	19			19									71
ZP-C20-379		X			1										1		54
ZP-20-84	X				5						5						60
ZP-20-384		X			5						5						60
ZP-20-386		X		X	37			37									74
ZP-20-387		X(G)		X	20			20									72
ZP-20-388		X(G)			19			19									71
ZP-24-313		X			100		100										81
ZP-C24-26	X(G)				4								4				58

(G) depicts arrangement with grounded contact

Insert Configuration Index

For drawings and further information of insert arrangements listed see the referenced page numbers. Arrangements with RADSOK contacts are designated with an 'R' in front of the dash number in the part number. For availability of other arrangements, consult Amphenol Industrial Operations.

Insert Arrangement Number	MOD I	MOD II	MOD III	Radsok Contacts	Total Number of Contacts	18 (0.75)	16 (1.5)	12 (4.0)	10 (6.0)	8 (10.0)	4 (250)	1/0 (50.0)	4/0 (120.0)	350 MCM (185.0)	500MCM (240.0)	646-777 (300-400)	Page No.
ZP-24-331		X			60		53	7									78
ZP-C24-36	X				37			35				2					75
ZP-C24-38	X				4								4				58
ZP-24-40	X				15		10					5					69
ZP-C24-47	X				15			10				5					69
ZP-C24-48	X				5			2					3				61
ZP-C24-49	X(G)				5							5					60
ZP-24-352		X(G)		X	58			58									78
ZP-C24-353		X			8			4				4					65
ZP-24-354		X			75		61	11		3							80
ZP-24-362		X			62		62										79
ZP-24-371		X			37		37										75
ZP-C24-72	X				6			3					3				63
ZP-C24-79	X				5							5					60
ZP-C24-680			X(G)		10			6				4					68
ZP-C24-81	X(G)				15			10				5					69
ZP-24-83	X				4							4					58
ZP-24-84	X				58			58									77
ZP-24-384		X		X	58			58									77
ZP-24-385		X			100		100										81
ZP-24-388		X			72		72										80
ZP-24-389		X			60		60										78
ZP-28-314		X			100		83	17									81
ZP-C28-15	X				47			43			3	1					76
ZP-C28-18	X				6			2						4			63 & 82
ZP-C28-R18	X				6			2						4			82
ZP-C28-21	X				8			4						4			66
ZP-28-322		X			143		143										81
ZP-C28-23	X(G)				5								5				61
ZP-28-324		X			55		41	5		3	6						77
ZP-C28-327		X			6							6					63
ZP-C28-328		X			29			23		2		4					74
ZP-28-339		X		X	42			42									76
ZP-C28-42	X(G)				6				2				4				64 & 83
ZP-C28-43	X(G)				8			4						4			66
ZP-C28-R44	X			X	7				1	3			4				64 & 83
ZPC28-R44																	83

(G) depicts arrangement with grounded contact

Insert Configurations

1 Contact (Dead Front Male Contact/Line Side)

front face of pin insert shown

Style	Wire Terminal Type	Shell Size	Insert Type	Dash Number	Catalog Number	Qty.	Size AWG (mm)	Current Rating	Voltage
Mod II	Crimp	C24	Pin Socket	386PN 386SN	RIG-C24-386PN RIG-C24-386SN	1	646-777 (300-400)	1135A	1000V
Mod II	Radsok Crimp	C24	Pin Socket	R386PN R386SN	RIG-C24-R386PN RIG-C24-R386SN	1	646-777 (300-400)	1135A	1000V
Mod II	Radsok Busbar	C24	Pin Socket	R386PR R386SR	RIG-C24-R386PR RIG-C24-R386SR	1	646-777 (300-400)	1135A	1000V

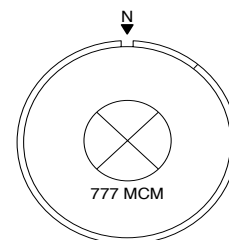

Mod II	Crimp	C24	Pin Socket	535PN 535SN	RIG-C24-535PN RIG-C24-535SN	1	535 (240)	900A	1000V
Mod II	Radsok Crimp	C24	Pin Socket	R535PN R535SN	RIG-C24-R535PN RIG-C24-R535SN	1	535 (240)	900A	1000V
Mod II	Crimp	C24	Pin Socket	R444PN R444SN	RIG-C24-444PN RIG-C24-444SN	1	444 (185)	800A	1000V
Mod II	Radsok Crimp	C24	Pin Socket	R444PN R444SN	RIG-C24-R444PN RIG-C24-R444SN	1	444 (185)	800A	1000V
Mod II	Crimp	C24	Pin Socket	R373PN R373SN	RIG-C24-373PN RIG-C24-373SN	1	373 (150)	700A	1000V
Mod II	Radsok Crimp	C24	Pin Socket	R373PN R373SN	RIG-C24-R373PN RIG-C24-R373SN	1	373 (150)	700A	1000V
Mod II	Crimp	C24	Pin Socket	R313PN R313SN	RIG-C24-313PN RIG-C24-313SN	1	313 (120)	625A	1000V
Mod II	Radsok Crimp	C24	Pin Socket	R313PN R313SN	RIG-C24-R313PN RIG-C24-R313SN	1	313 (120)	625A	1000V

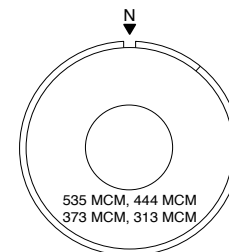

1 Contact

Style	Wire Terminal Type	Shell Size	Insert Type	Dash Number	Catalog Number	Qty.	Size AWG	Service Voltage Rating
Mod II	Crimp	C20	Pin Socket	379PN 379SN	ZP-C20-379PN ZP-C20-379SN	1	500MCM	D

NOTE: Will accept 535 standard stranding 500 MCM extra flexible cable.

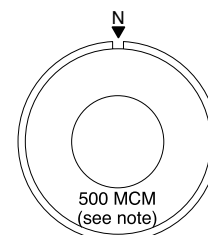

1 Contact

Style	Wire Terminal Type	Shell Size	Insert Type	Dash Number	Catalog Number	Qty.	Size AWG	Service Voltage Rating
Mod II	Crimp	C16	Pin Socket	341PN 341SN	ZP-C16-341PN ZP-C16-341SN	1	4/0	D

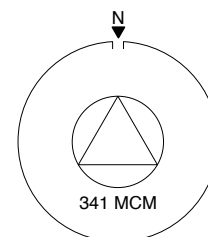

Grounding Contact Termination Symbol			Contact Symbols											
Solder Well	Pressure	Crimp	Wire Size AWG	18	16	12	10	8	4	1/0	4/0	350 MCM	500 MCM	646-777
			Metric	0.75	1.5	4.0	6.0	10.0	25.0	50.0	120.00	185.00	240.00	300-400

★ Pre-assembled insert should be ordered mounted in barrel.

SERVICE VOLTAGE RATING
A = 240V, D = 600V

Insert Configurations

3 Contacts

Style	Wire Terminal Type	Shell Size	Insert Type	Dash Number	Catalog Number	Qty.	Size AWG	Service Voltage Rating
Mod I	Solder	12	Pin Socket	27P 27S	ZP-12-27P ZP-12-27S	3	12	D
Mod II	Radsok Crimp	12	Pin Socket	327PN 327SN	ZP-12-327PN ZP-12-327SN			

front face of pin insert shown

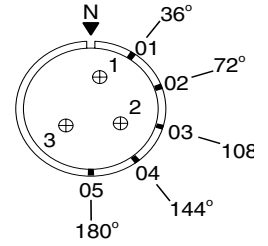

3 Contacts

Style	Wire Terminal Type	Shell Size	Insert Type	Dash Number	Catalog Number	Qty.	Size AWG	Service Voltage Rating
Mod II	Crimp Radsok	12	Pin Socket	330PN 330SN	ZP-12-330PN ZP-12-330SN	3	12	D

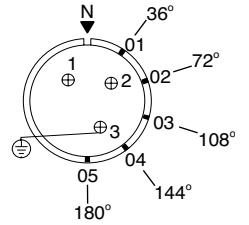

3 Contacts

Style	Wire Terminal Type	Shell Size	Insert Type	Dash Number	Catalog Number	Qty.	Size AWG	Service Voltage Rating
Mod I	Solder	12	Pin Socket	56P 56S	ZP-12-56P ZP-12-56S	3	8	A

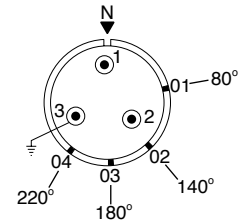

3 Contacts

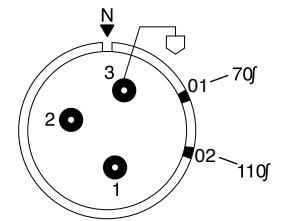

Style	Wire Terminal Type	Shell Size	Insert Type	Dash Number	Catalog Number	Qty.	Size AWG	Service Voltage Rating
Mod I	Solder	16	Pin Socket	74P 74S	ZP-16-74P ZP-16-74S	3	4	D
Mod I	Pressure	16	Pin Socket	74PR 74SR	ZP-16-74PR ZP-16-74SR			

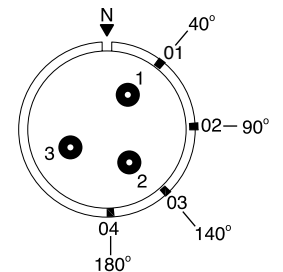

3 Contacts

Style	Wire Terminal Type	Shell Size	Insert Type	Dash Number	Catalog Number	Qty.	Size AWG	Service Voltage Rating
Mod I	Solder	16	Pin Socket	70P 70S	ZP-16-70P ZP-16-70S	3	4	D
Mod I	Pressure	16	Pin Socket	70PR 70SR	ZP-16-70PR ZP-16-70SR			



Grounding Contact Termination Symbol			Contact Symbols	○	●	⊕	○	⊙	●	⊕	⊖	⊕	⊖	⊕	⊖
			Wire Size AWG	18	16	12	10	8	4	1/0	4/0	350 MCM	500 MCM	646-777	
Solder Well	Pressure	Crimp	Metric	0.75	1.5	4.0	6.0	10.0	25.0	50.0	120.00	185.00	240.00	300-400	

★ Pre-assembled insert should be ordered mounted in barrel.

SERVICE VOLTAGE RATING
A = 240V, D = 600V

Insert Configurations

4 Contacts

Style	Wire Terminal Type	Shell Size	Insert Type	Dash Number	Catalog Number	Qty.	Size AWG	Service Voltage Rating
Mod I	Solder	12	Pin Socket	33P 33S	ZP-12-33P ZP-12-33S	4	16	D
Mod II	Crimp	12	Pin Socket	333PN 333SN	ZP-12-333PN ZP-12-333SN			

front face of pin insert shown

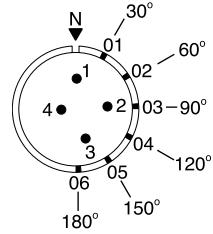

4 Contacts

Style	Wire Terminal Type	Shell Size	Insert Type	Dash Number	Catalog Number	Qty.	Size AWG	Service Voltage Rating
Mod I	Solder	12	Pin Socket	14P 14S	ZP-12-14P ZP-12-14S	4	10	D
Mod I	Pressure	12	Pin Socket	14PR 14SR	ZP-12-14PR ZP-12-14SR			
Mod II	Crimp	12	Pin Socket	314PN 314SN	ZP-12-314PN ZP-12-314SN			

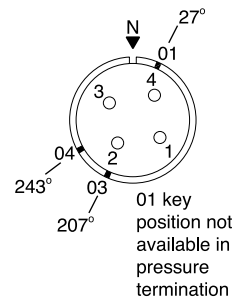

4 Contacts

Style	Wire Terminal Type	Shell Size	Insert Type	Dash Number	Catalog Number	Qty.	Size AWG	Service Voltage Rating
Mod II	Crimp	12	Pin Socket	316PN 316SN	ZP-12-316PN ZP-12-316SN	4	10	D

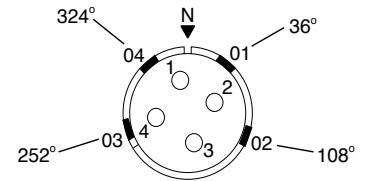

4 Contacts

Style	Wire Terminal Type	Shell Size	Insert Type	Dash Number	Catalog Number	Qty.	Size AWG	Service Voltage Rating
Mod I	Solder	12	Pin Socket	22P 22S	ZP-12-22P ZP-12-22S	4	10	D
Mod I	Pressure	12	Pin Socket	22PR 22SR	ZP-12-22PR ZP-12-22SR			
Mod II	Crimp	12	Pin Socket	322PN 322SN	ZP-12-322PN ZP-12-322SN			

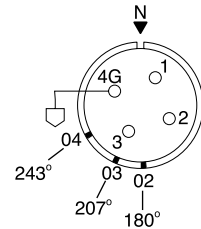

Grounding Contact Termination Symbol			Contact Symbols	○	●	⊕	○	⊙	●	⊕	△	□	○	⊗
⊕	⊕	⊕	Wire Size AWG	18	16	12	10	8	4	1/0	4/0	350 MCM	500 MCM	646-777
Solder Well	Pressure	Crimp	Metric	0.75	1.5	4.0	6.0	10.0	25.0	50.0	120.00	185.00	240.00	300-400

★ Pre-assembled insert should be ordered mounted in barrel.

SERVICE VOLTAGE RATING
A = 240V, D = 600V

Insert Configurations

4 Contacts

Style	Wire Terminal Type	Shell Size	Insert Type	Dash Number	Catalog Number
Mod I	Solder	16	Pin	28P	ZP-16-28P
			Socket	28S	ZP-16-28S
Mod II	Crimp	16	Pin	328PN	ZP-16-328PN
			Socket	328SN	ZP-16-328SN

Qty.	Size AWG	Service Voltage Rating
4	8	D



front face of pin insert shown

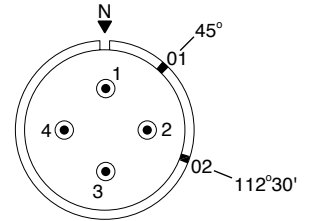

NOTE: Cannot be used with short cable adapter

4 Contacts

Style	Wire Terminal Type	Shell Size	Insert Type	Dash Number	Catalog Number
Mod I	Solder	16	Pin	22P	ZP-16-22P
			Socket	22S	ZP-16-22S
Mod I	Pressure	16	Pin	22PR	ZP-16-22PR
			Socket	22SR	ZP-16-22SR
Mod II	Crimp	16	Pin	322PN	ZP-16-322PN
			Socket	322SN	ZP-16-322SN

Qty.	Size AWG	Service Voltage Rating
4	4	D

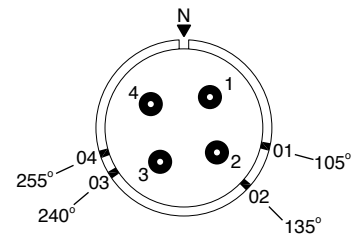

4 Contacts

Style	Wire Terminal Type	Shell Size	Insert Type	Dash Number	Catalog Number
Mod I	Solder	16	Pin	38P	ZP-16-38P
			Socket	38S	ZP-16-38S
Mod I	Pressure	16	Pin	38PR	ZP-16-38PR
			Socket	38SR	ZP-16-38SR
Mod III	Crimp	16	Pin	638PN	★
			Socket	638SN	★

Qty.	Size AWG	Service Voltage Rating
4	4	D

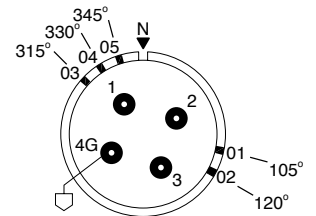

4 Contacts

Style	Wire Terminal Type	Shell Size	Insert Type	Dash Number	Catalog Number
Mod I	Solder	C20	Pin	40P	ZP-C20-40P
			Socket	40S	ZP-C20-40S
Mod I	Pressure	C20	Pin	40PR	ZP-C20-40PR
			Socket	40SR	ZP-C20-40SR
Mod III	Crimp	C20	Pin	640PN	★
			Socket	640SN	★

Qty.	Size AWG	Current Rating
4	1/0	D

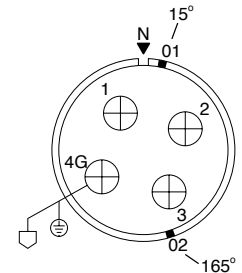

Grounding Contact Termination Symbol			Contact Symbols											
Solder Well	Pressure	Crimp	Wire Size AWG	18	16	12	10	8	4	1/0	4/0	350 MCM	500 MCM	646-777
			Metric	0.75	1.5	4.0	6.0	10.0	25.0	50.0	120.00	185.00	240.00	300-400

★ Pre-assembled insert should be ordered mounted in barrel.

SERVICE VOLTAGE RATING
A = 240V, D = 600V

Insert Configurations

4 Contacts

Style	Wire Terminal Type	Shell Size	Insert Type	Dash Number	Catalog Number
Mod I	Solder	C20	Pin Socket	42P 42S	ZP-C20-42P ZP-C20-42S
Mod I	Pressure	C20	Pin Socket	42PR 42SR	ZP-C20-42PR ZP-C20-42SR

Qty.	Size AWG	Service Voltage Rating
4	1/0	D



front face of pin insert shown

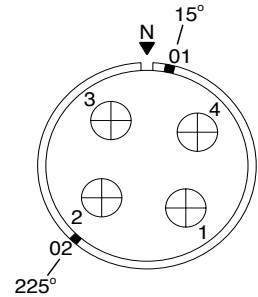

4 Contacts

Style	Wire Terminal Type	Shell Size	Insert Type	Dash Number	Catalog Number
Mod I	Solder	24	Pin Socket	83P 83S	ZP-24-83P ZP-24-83S

Qty.	Size AWG	Service Voltage Rating
4	4/0	D

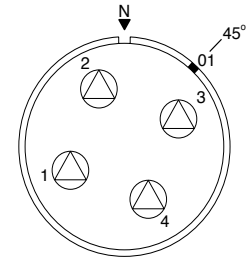

4 Contacts

Style	Wire Terminal Type	Shell Size	Insert Type	Dash Number	Catalog Number
Mod I	Solder	C24	Pin Socket	26P 26S	ZP-C24-26P ZP-C24-26S
Mod I	Pressure	C24	Pin Socket	26PR 26SR	ZP-C24-26PR ZP-C24-26SR

Qty.	Size AWG	Service Voltage Rating
4	4/0	D

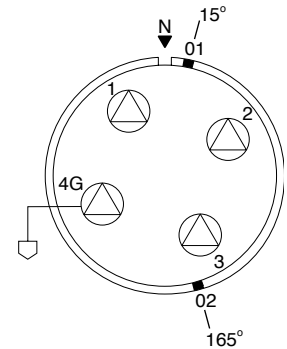

4 Contacts

Style	Wire Terminal Type	Shell Size	Insert Type	Dash Number	Catalog Number
Mod I	Solder	C24	Pin Socket	38P 38S	ZP-C24-38P ZP-C24-38S
Mod II	Pressure	C24	Pin Socket	38PR 38SR	ZP-C24-38PR ZP-C24-38SR

Qty.	Size AWG	Service Voltage Rating
4	4/0	D

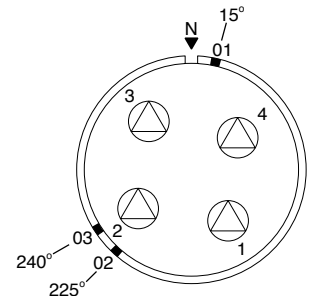

Grounding Contact Termination Symbol			Contact Symbols											
Solder Well	Pressure	Crimp	Wire Size AWG	18	16	12	10	8	4	1/0	4/0	350 MCM	500 MCM	646-777
			Metric	0.75	1.5	4.0	6.0	10.0	25.0	50.0	120.00	185.00	240.00	300-400

* Pre-assembled insert should be ordered mounted in barrel.

SERVICE VOLTAGE RATING
A = 240V, D = 600V

Insert Configurations

5 Contacts

Style	Wire Terminal Type	Shell Size	Insert Type	Dash Number	Catalog Number	Qty.	Size AWG	Service Voltage Rating
Mod I	Solder	12	Pin Socket	53P 53S	ZP-12-53P ZP-12-53S	5	12	D
Mod III	Crimp	12	Pin Socket	653PN 653SN	★ ★			

front face of pin insert shown

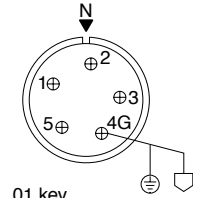

01 key position not available in pressure termination

5 Contacts

Style	Wire Terminal Type	Shell Size	Insert Type	Dash Number	Catalog Number	Qty.	Size AWG	Service Voltage Rating
Mod I	Solder	12	Pin Socket	24P 24S	ZP-12-24P ZP-12-24S	5	12	D
Mod II	Radsok Crimp	12	Pin Socket	324PN 324SN	ZP-12-324PN ZP-12-324SN			

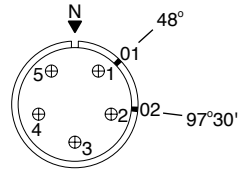

5 Contacts

Style	Wire Terminal Type	Shell Size	Insert Type	Dash Number	Catalog Number	Qty.	Size AWG	Service Voltage Rating
Mod I	Solder	16	Pin Socket	16P 16S	ZP-16-16P ZP-16-16S	5	8	D
Mod II	Crimp	16	Pin Socket	316PN 316SN	ZP-16-316PN ZP-16-316SN			

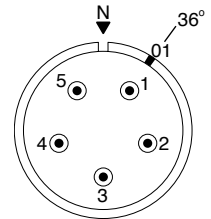

5 Contacts

Style	Wire Terminal Type	Shell Size	Insert Type	Dash Number	Catalog Number	Qty.	Size AWG	Service Voltage Rating
Mod I	Solder	16	Pin Socket	75P 75S	ZP-16-75P ZP-16-75S	5	8	D

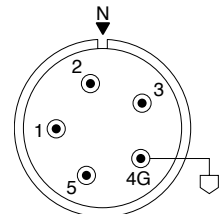

Grounding Contact Termination Symbol			Contact Symbols											
Solder Well	Pressure	Crimp	Wire Size AWG	18	16	12	10	8	4	1/0	4/0	350 MCM	500 MCM	646-777
			Metric	0.75	1.5	4.0	6.0	10.0	25.0	50.0	120.00	185.00	240.00	300-400

★ Pre-assembled insert should be ordered mounted in barrel.

SERVICE VOLTAGE RATING
A = 240V, D = 600V

Insert Configurations

5 Contacts

Style	Wire Terminal Type	Shell Size	Insert Type	Dash Number	Catalog Number
Mod I	Solder	20	Pin	84P	ZP-20-84P
			Socket	84S	ZP-20-84S
Mod I	Pressure	20	Pin	84PR	ZP-20-84PR
			Socket	84SR	ZP-20-84SR
Mod II	Crimp	20	Pin	384PN	ZP-20-384PN
			Socket	384SN	ZP-20-384SN

Qty.	Size AWG	Service Voltage Rating
5	4	D



front face of pin insert shown

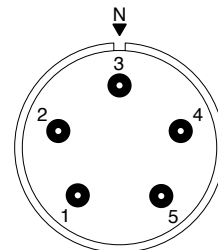

5 Contacts

Style	Wire Terminal Type	Shell Size	Insert Type	Dash Number	Catalog Number
Mod I	Solder	20	Pin	38P	ZP-20-38P
			Socket	38S	ZP-20-38S
Mod I	Pressure	20	Pin	38PR	ZP-20-38PR
			Socket	38SR	ZP-20-38SR

Qty.	Size AWG	Service Voltage Rating
5	4	D

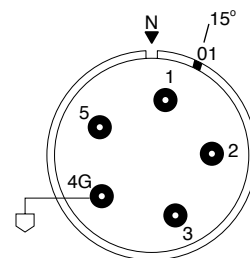

5 Contacts

Style	Wire Terminal Type	Shell Size	Insert Type	Dash Number	Catalog Number
Mod I	Solder	C24	Pin	79P	ZP-C24-79P
			Socket	79S	ZP-C24-79S
Mod I	Pressure	C24	Pin	79PR	ZP-C24-79PR
			Socket	79SR	ZP-C24-79SR

Qty.	Size AWG	Service Voltage Rating
5	1/0	E

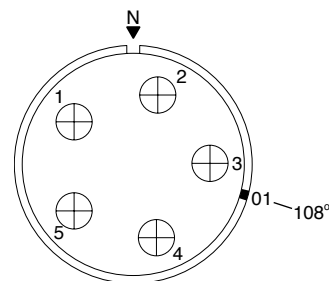

5 Contacts

Style	Wire Terminal Type	Shell Size	Insert Type	Dash Number	Catalog Number
Mod I	Solder	C24	Pin	49P	ZP-C24-49P
			Socket	49S	ZP-C24-49S
Mod I	Pressure	C24	Pin	49PR	ZP-C24-49PR
			Socket	49SR	ZP-C24-49SR

Qty.	Size AWG	Service Voltage Rating
5	1/0	E

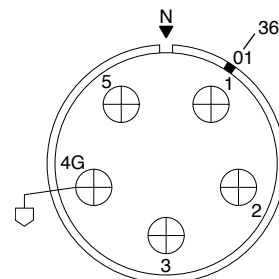

Grounding Contact Termination Symbol			Contact Symbols														
Solder Well	Pressure	Crimp	Wire Size AWG	18	16	12	10	8	4	1/0	4/0	350 MCM	500 MCM	646-777			
			Metric	0.75	1.5	4.0	6.0	10.0	25.0	50.0	120.00	185.00	240.00	300-400			

★ Pre-assembled insert should be ordered mounted in barrel.

SERVICE VOLTAGE RATING
A = 240V, D = 600V

Insert Configurations

5 Contacts

Style	Wire Terminal Type	Shell Size	Insert Type	Dash Number	Catalog Number
Mod I	Solder	C28	Pin Socket	23P 23S	ZP-C28-23P ZP-C28-23S
Mod I	Pressure	C28	Pin Socket	23PR 23SR	ZP-C28-23PR ZP-C28-23SR

Qty.	Size AWG	Service Voltage Rating
5	4/0	D



front face of pin insert shown

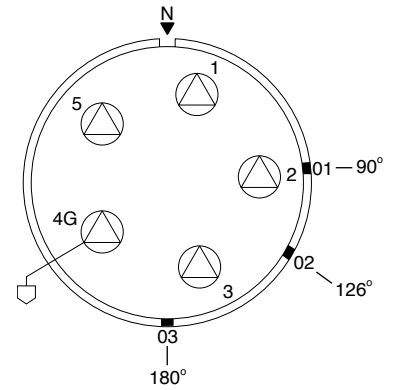

5 Contacts

Style	Wire Terminal Type	Shell Size	Insert Type	Dash Number	Catalog Number
Mod II	Crimp	12	Pin Socket	326PN 326SN	ZP-12-326PN ZP-12-326SN

Qty.	Size AWG	Service Voltage Rating
2	8	A
3	16	A

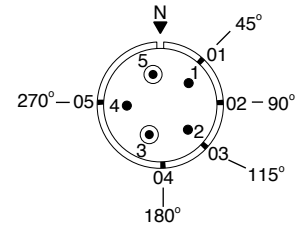

5 Contacts

Style	Wire Terminal Type	Shell Size	Insert Type	Dash Number	Catalog Number
Mod I	Solder	20	Pin Socket	49P 49S	ZP-20-49P ZP-20-49S
Mod III	Crimp	20	Pin Socket	649PN 649SN	★ ★

Qty.	Size AWG	Service Voltage Rating
2	1/0	E
3	12	E

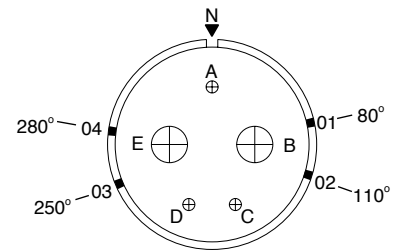

5 Contacts

Style	Wire Terminal Type	Shell Size	Insert Type	Dash Number	Catalog Number
Mod I	Solder	C24	Pin Socket	48P 48S	ZP-C24-48P ZP-C24-48S

Qty.	Size AWG	Service Voltage Rating
3	4/0	D
2	12	A

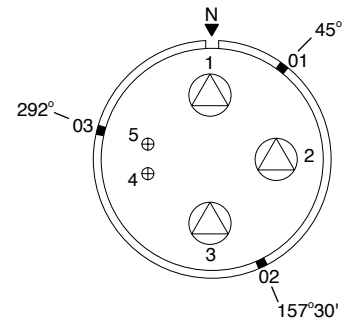

Grounding Contact Termination Symbol			Contact Symbols											
Solder Well	Pressure	Crimp	Wire Size AWG	18	16	12	10	8	4	1/0	4/0	350 MCM	500 MCM	646-777
			Metric	0.75	1.5	4.0	6.0	10.0	25.0	50.0	120.00	185.00	240.00	300-400

★ Pre-assembled insert should be ordered mounted in barrel.

SERVICE VOLTAGE RATING
A = 240V, D = 600V

Insert Configurations

6 Contacts

Style	Wire Terminal Type	Shell Size	Insert Type	Dash Number	Catalog Number
Mod I	Pressure	20	Pin	43PR	ZP-20-43PR
			Socket	43SR	ZP-20-43SR
Mod III	Crimp	20	Pin	643PN	★
			Socket	643SN	★

Qty.	Size AWG	Service Voltage Rating
4	4	D
2	10	D



front face of pin insert shown

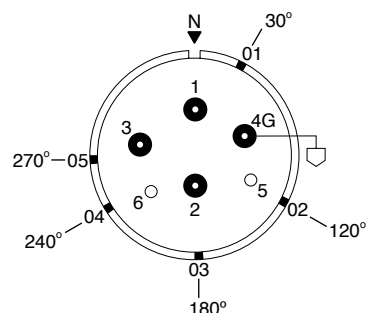

6 Contacts

Style	Wire Terminal Type	Shell Size	Insert Type	Dash Number	Catalog Number
Mod I	Solder	20	Pin	46PR	ZP-20-46P
			Socket	46SR	ZP-20-46S
Mod III	Crimp	20	Pin	646PN	★
			Socket	646SN	★

Qty.	Size AWG	Service Voltage Rating
2	1/0	A
4	4	A

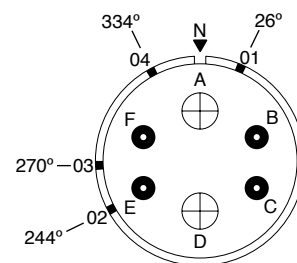

6 Contacts

Style	Wire Terminal Type	Shell Size	Insert Type	Dash Number	Catalog Number
Mod I	Solder	20	Pin	48P	ZP-20-48P
			Socket	48S	ZP-20-48S
Mod III	Crimp	20	Pin	648PN	★
			Socket	648SN	★

Qty.	Size AWG	Service Voltage Rating
3	1/0	D
3	12	D

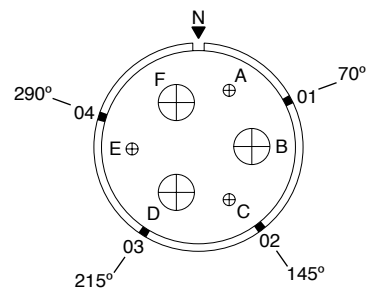

Grounding Contact Termination Symbol			Contact Symbols											
Solder Well	Pressure	Crimp	18	16	12	10	8	4	1/0	4/0	350 MCM	500 MCM	646-777	
			Metric	0.75	1.5	4.0	6.0	10.0	25.0	50.0	120.00	185.00	240.00	300-400

★ Pre-assembled insert should be ordered mounted in barrel.

SERVICE VOLTAGE RATING
A = 240V, D = 600V

Insert Configurations

front face of pin insert shown

6 Contacts

Style	Wire Terminal Type	Shell Size	Insert Type	Dash Number	Catalog Number	Qty.	Size AWG	Service Voltage Rating
Mod I	Solder	C24	Pin	72P	ZP-C24-72P	3	4/0	D
				72S	ZP-C24-72S	3	12	D

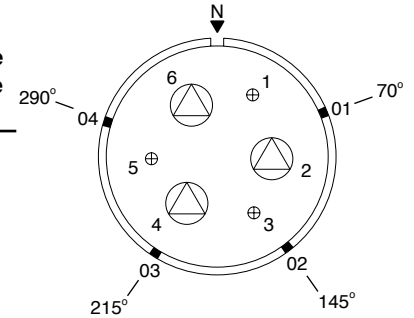

6 Contacts

Style	Wire Terminal Type	Shell Size	Insert Type	Dash Number	Catalog Number	Qty.	Size AWG	Service Voltage Rating
Mod II	Crimp	C28	Pin Socket	327PN	ZP-C28-327PN	6	1/0	D
				327SN	ZP-C28-327SN			

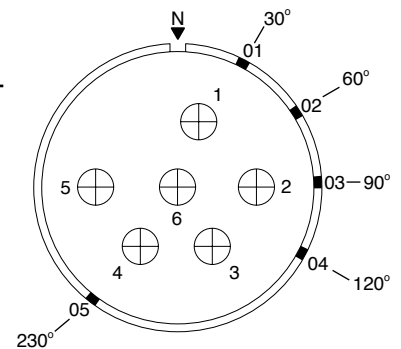

6 Contacts

Style	Wire Terminal Type	Shell Size	Insert Type	Dash Number	Catalog Number	Qty.	Size AWG	Service Voltage Rating
Mod I	Solder	C28	Pin Socket	18P	ZP-C28-18P	4	350 MCM	D
				18S	ZP-C28-18S	2	12	E

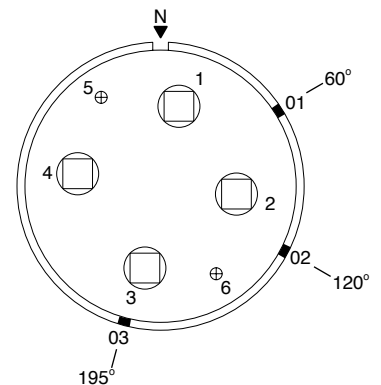

Grounding Contact Termination Symbol			Contact Symbols											
Solder Well	Pressure	Crimp	Wire Size AWG	18	16	12	10	8	4	1/0	4/0	350 MCM	500 MCM	646-777
			Metric	0.75	1.5	4.0	6.0	10.0	25.0	50.0	120.00	185.00	240.00	300-400

★ Pre-assembled insert should be ordered mounted in barrel.

SERVICE VOLTAGE RATING
A = 240V, D = 600V

Insert Configurations

front face of pin insert shown

6 Contacts

Style	Wire Terminal Type	Shell Size	Insert Type	Dash Number	Catalog Number	Qty.	Size AWG	Service Voltage Rating
Mod I	Solder	C28	Pin	42P	ZP-C28-42P	4	4/0	D
			Socket	42S	ZP-C28-42S	2	10	D
Mod I	Pressure	C28	Pin	42PR	ZP-C28-42PR			
			Socket	42SR	ZP-C28-42SR			
Mod I	Radsok Pressure	C28	Pin	R42PR	ZP-C28-R42PR			
			Socket	R42SR	ZP-C28-R42SR			

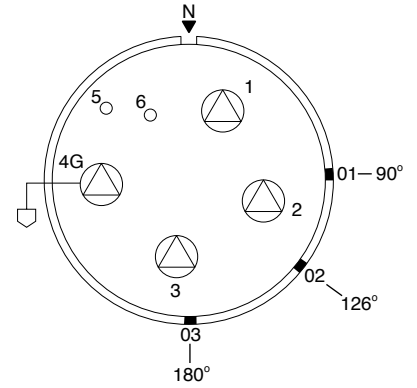

7 Contacts

Style	Wire Terminal Type	Shell Size	Insert Type	Dash Number	Catalog Number	Qty.	Size AWG	Service Voltage Rating
Mod I	Radsok Pressure	C28	Pin	R44PR	ZP-C28-R44PR	3	4/0	D
			Socket	R44SR	ZP-C28-R44SR	3	8	D
						1	10	D

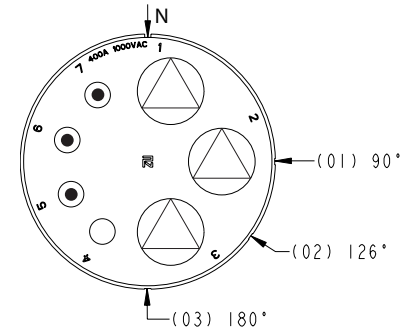

7 Contacts

Style	Wire Terminal Type	Shell Size	Insert Type	Dash Number	Catalog Number	Qty.	Size AWG	Service Voltage Rating
Mod II	Crimp	12	Pin	348PN	ZP-12-348PN	7	16	A
			Socket	348SN	ZP-12-348SN			

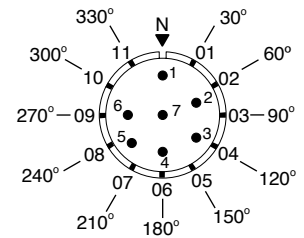

7 Contacts

Style	Wire Terminal Type	Shell Size	Insert Type	Dash Number	Catalog Number	Qty.	Size AWG	Service Voltage Rating
Mod II	Radsok Crimp	12	Pin	310PN	ZP-12-310PN	7	12	A
			Socket	310SN	ZP-12-310SN			

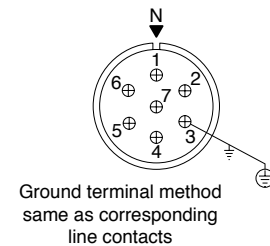

Grounding Contact Termination Symbol			Contact Symbols											
Solder Well	Pressure	Crimp	Wire Size AWG	18	16	12	10	8	4	1/0	4/0	350 MCM	500 MCM	646-777
			Metric	0.75	1.5	4.0	6.0	10.0	25.0	50.0	120.00	185.00	240.00	300-400

* Pre-assembled insert should be ordered mounted in barrel.

SERVICE VOLTAGE RATING
A = 240V, D = 600V

Insert Configurations

front face of pin insert shown

7 Contacts

Style	Wire Terminal Type	Shell Size	Insert Type	Dash Number	Catalog Number	Qty.	Size AWG	Service Voltage Rating
Mod II	Radsok Crimp	12	Pin Socket	354PN 354SN	ZP-12-354PN ZP-12-354SN	7	12	A

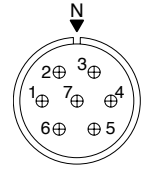

7 Contacts

Style	Wire Terminal Type	Shell Size	Insert Type	Dash Number	Catalog Number	Qty.	Size AWG	Service Voltage Rating
Mod II	Crimp	16	Pin Socket	378PN 378SN	ZP-16-378PN ZP-16-378SN	7	12	D

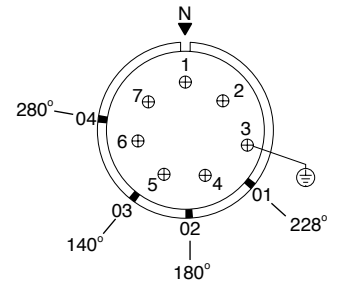

7 Contacts

Style	Wire Terminal Type	Shell Size	Insert Type	Dash Number	Catalog Number	Qty.	Size AWG	Service Voltage Rating
Mod II	Crimp	20	Pin Socket	359PN 359SN	ZP-20-359PN ZP-20-359SN	7	8	E

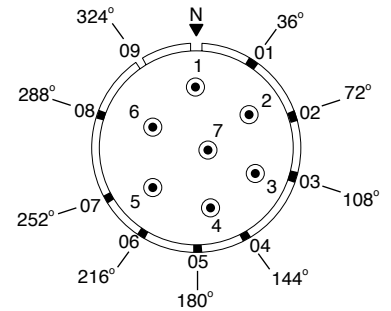

8 Contacts

Style	Wire Terminal Type	Shell Size	Insert Type	Dash Number	Catalog Number	Qty.	Size AWG	Service Voltage Rating
Mod II	Crimp	C24	Pin Socket	353PN 353SN	ZP-C24-353PN ZP-C24-353SN	4 4	1/0 12	B A

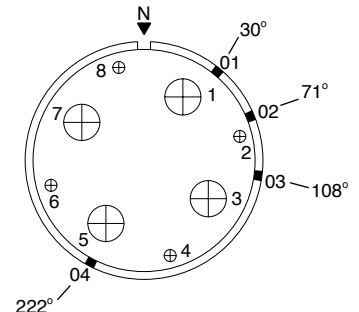

Grounding Contact Termination Symbol			Contact Symbols											
Solder Well	Pressure	Crimp	Wire Size AWG	18	16	12	10	8	4	1/0	4/0	350 MCM	500 MCM	646-777
			Metric	0.75	1.5	4.0	6.0	10.0	25.0	50.0	120.00	185.00	240.00	300-400

★ Pre-assembled insert should be ordered mounted in barrel.

SERVICE VOLTAGE RATING
A = 240V, D = 600V

Insert Configurations

front face of pin insert shown

8 Contacts

Style	Wire Terminal Type	Shell Size	Insert Type	Dash Number	Catalog Number	Qty.	Size AWG	Service Voltage Rating
Mod I	Solder	C28	Pin	21P	ZP-C28-21P	4	350 MCM	D
			Socket	21S	ZP-C28-21S	4	12 Relay	E

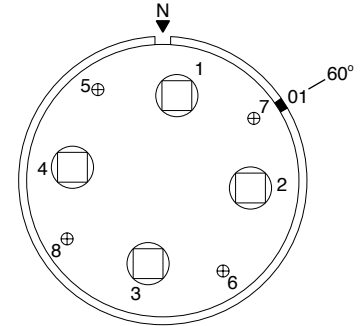

8 Contacts

Style	Wire Terminal Type	Shell Size	Insert Type	Dash Number	Catalog Number	Qty.	Size AWG	Service Voltage Rating
Mod I	Solder	C28	Pin	43P	ZP-C28-43P	4	350 MCM	D
			Socket	43S	ZP-C28-43S	4	12 Relay	E

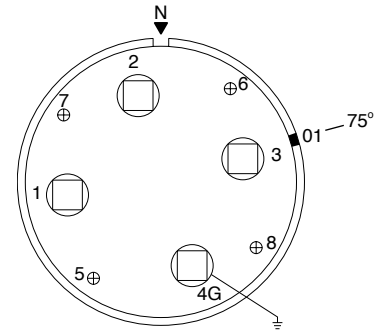

9 Contacts

Style	Wire Terminal Type	Shell Size	Insert Type	Dash Number	Catalog Number	Qty.	Size AWG	Service Voltage Rating
Mod I	Solder	16	Pin	29P	ZP-16-29P	1	4	D
			Socket	29S	ZP-16-29S	8	16	D

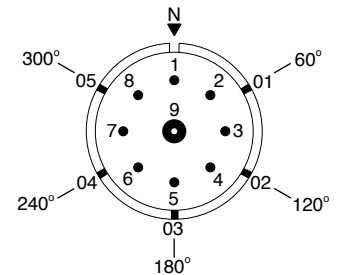

9 Contacts

Style	Wire Terminal Type	Shell Size	Insert Type	Dash Number	Catalog Number	Qty.	Size AWG	Service Voltage Rating
Mod II	Crimp	16	Pin	346PN	ZP-16-346PN	6	12	A
			Socket	346SN	ZP-16-346SN	3	8	A

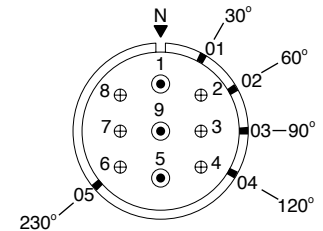

Grounding Contact Termination Symbol			Contact Symbols	○	●	⊕	○	⊙	●	⊕	△	□	○	⊗
			Wire Size AWG	18	16	12	10	8	4	1/0	4/0	350 MCM	500 MCM	646-777
Solder Well	Pressure	Crimp	Metric	0.75	1.5	4.0	6.0	10.0	25.0	50.0	120.00	185.00	240.00	300-400

★ Pre-assembled insert should be ordered mounted in barrel.

SERVICE VOLTAGE RATING
A = 240V, D = 600V

Insert Configurations

front face of pin insert shown

10 Contacts

Style	Wire Terminal Type	Shell Size	Insert Type	Dash Number	Catalog Number	Qty.	Size AWG	Service Voltage Rating
Mod II	Crimp	12	Pin Socket	355PN 355SN	ZP-12-355PN ZP-12-355SN	10	16	A

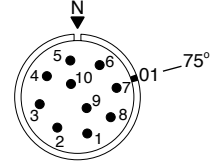

10 Contacts

Style	Wire Terminal Type	Shell Size	Insert Type	Dash Number	Catalog Number	Qty.	Size AWG	Service Voltage Rating
Mod II	Crimp	12	Pin Socket	334PN 334SN	ZP-12-334PN ZP-12-334SN	10	16	A

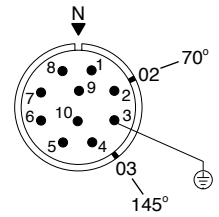

10 Contacts

Style	Wire Terminal Type	Shell Size	Insert Type	Dash Number	Catalog Number	Qty.	Size AWG	Service Voltage Rating
Mod II	Crimp	16	Pin Socket	381PN 381SN	ZP-16-381PN ZP-16-381SN	4 6	10 12	D D

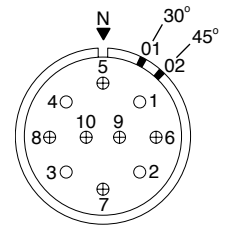

10 Contacts

Style	Wire Terminal Type	Shell Size	Insert Type	Dash Number	Catalog Number	Qty.	Size AWG	Service Voltage Rating
Mod II	Crimp	16	Pin Socket	376PN 376SN	ZP-16-376PN ZP-16-376SN	4 6	10 12	D D

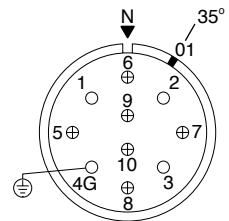

Grounding Contact Termination Symbol			Contact Symbols	○	●	⊕	○	⊙	●	⊕	△	□	○	⊗
⊕	⊕	⊕	Wire Size AWG	18	16	12	10	8	4	1/0	4/0	350 MCM	500 MCM	646-777
Solder Well	Pressure	Crimp	Metric	0.75	1.5	4.0	6.0	10.0	25.0	50.0	120.00	185.00	240.00	300-400

★ Pre-assembled insert should be ordered mounted in barrel.

SERVICE VOLTAGE RATING
A = 240V, D = 600V

Insert Configurations

front face of pin insert shown

10 Contacts

Style	Wire Terminal Type	Shell Size	Insert Type	Dash Number	Catalog Number	Qty.	Size AWG	Service Voltage Rating
Mod I	Solder	20	Pin Socket	55P	ZP-20-55P	2	1/0	D
				55S	ZP-20-55S	8	12	D

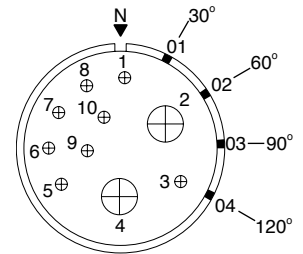

10 Contacts

Style	Wire Terminal Type	Shell Size	Insert Type	Dash Number	Catalog Number	Qty.	Size AWG	Service Voltage Rating
Mod III	Crimp	C24	Pin Socket	680PN	★	4	1/0	D
				680SN	★	6	12	D

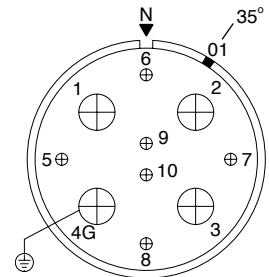

12 Contacts

Style	Wire Terminal Type	Shell Size	Insert Type	Dash Number	Catalog Number	Qty.	Size AWG	Service Voltage Rating
Mod II	Crimp	20	Pin Socket	375PN	ZP-20-375PN	12	10	D
				375SN	ZP-20-375SN			

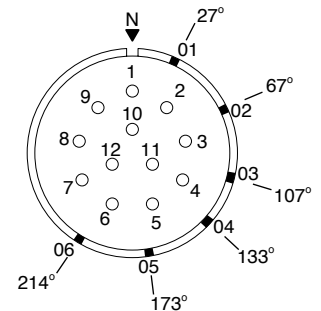

14 Contacts

Style	Wire Terminal Type	Shell Size	Insert Type	Dash Number	Catalog Number	Qty.	Size AWG	Service Voltage Rating
Mod II	Crimp	16	Pin Socket	349PN	ZP-16-349PN	2	4	D
				349SN	ZP-16-349SN	12	16	A

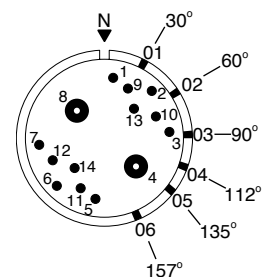

Grounding Contact Termination Symbol			Contact Symbols											
			○	●	⊕	○	⊙	●	⊕	⊗	⊕	⊗	⊕	⊗
Solder Well	Pressure	Crimp	Wire Size AWG	18	16	12	10	8	4	1/0	4/0	350 MCM	500 MCM	646-777
			Metric	0.75	1.5	4.0	6.0	10.0	25.0	50.0	120.00	185.00	240.00	300-400

★ Pre-assembled insert should be ordered mounted in barrel.

SERVICE VOLTAGE RATING
A = 240V, D = 600V

Insert Configurations

front face of pin insert shown

15 Contacts

Style	Wire Terminal Type	Shell Size	Insert Type	Dash Number	Catalog Number	Qty.	Size AWG	Service Voltage Rating
Mod I	Solder	24	Pin	40P	ZP-24-40P	5	1/0	D
			Socket	40S	ZP-24-40S	10	16	D

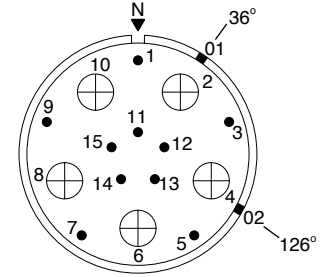

15 Contacts

Style	Wire Terminal Type	Shell Size	Insert Type	Dash Number	Catalog Number	Qty.	Size AWG	Service Voltage Rating
Mod I	Solder	C24	Pin	47P	ZP-C24-47P	5	1/0	D
			Socket	47S	ZP-C24-47S	10	12	A

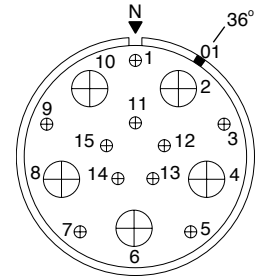

15 Contacts

Style	Wire Terminal Type	Shell Size	Insert Type	Dash Number	Catalog Number	Qty.	Size AWG	Service Voltage Rating
Mod I	Solder	C24	Pin	81P	ZP-C24-81P	5	1/0	D
			Socket	81S	ZP-C24-81S	10	12	A

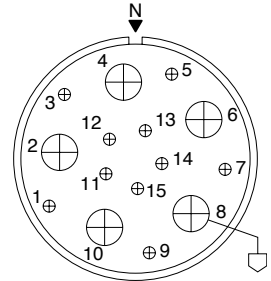

16 Contacts

Style	Wire Terminal Type	Shell Size	Insert Type	Dash Number	Catalog Number	Qty.	Size AWG	Service Voltage Rating
Mod II	Crimp	16	Pin	325PN	ZP-16-325PN	16	16	D
			Socket	325SN	ZP-16-325SN			

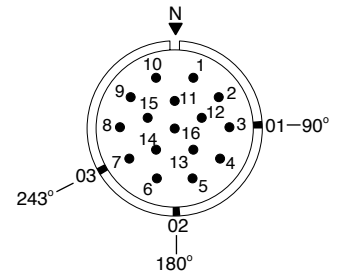

Grounding Contact Termination Symbol			Contact Symbols											
Solder Well	Pressure	Crimp	Wire Size AWG	18	16	12	10	8	4	1/0	4/0	350 MCM	500 MCM	646-777
			Metric	0.75	1.5	4.0	6.0	10.0	25.0	50.0	120.00	185.00	240.00	300-400

★ Pre-assembled insert should be ordered mounted in barrel.

SERVICE VOLTAGE RATING
A = 240V, D = 600V

Insert Configurations

front face of pin insert shown

16 Contacts

Style	Wire Terminal Type	Shell Size	Insert Type	Dash Number	Catalog Number	Qty.	Size AWG	Service Voltage Rating
Mod II	Crimp	20	Pin Socket	358PN 358SN	ZP-20-358PN ZP-20-358SN	16	8	A

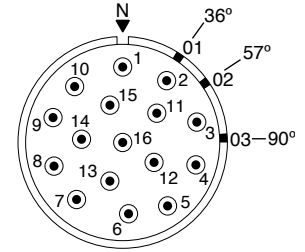

17 Contacts

Style	Wire Terminal Type	Shell Size	Insert Type	Dash Number	Catalog Number	Qty.	Size AWG	Service Voltage Rating
Mod II	Crimp	12	Pin Socket	323PN 323SN	ZP-12-323PN ZP-12-323SN	17	18	A

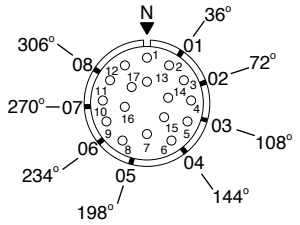

18 Contacts

Style	Wire Terminal Type	Shell Size	Insert Type	Dash Number	Catalog Number	Qty.	Size AWG	Service Voltage Rating
Mod II	Crimp	16	Pin Socket	324PN 324SN	ZP-16-324PN ZP-16-324SN	2 16	10 16	D D

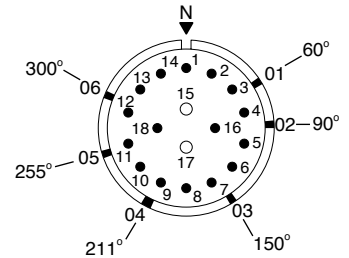

19 Contacts

Style	Wire Terminal Type	Shell Size	Insert Type	Dash Number	Catalog Number	Qty.	Size AWG	Service Voltage Rating
Mod II	Radsok Crimp	16	Pin Socket	377PN 377SN	ZP-16-377PN ZP-16-377SN	19	12	A

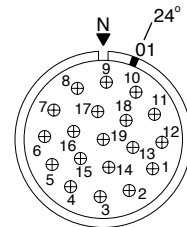

Grounding Contact Termination Symbol			Contact Symbols											
Solder Well	Pressure	Crimp	Wire Size AWG	18	16	12	10	8	4	1/0	4/0	350 MCM	500 MCM	646-777
			Metric	0.75	1.5	4.0	6.0	10.0	25.0	50.0	120.0	185.00	240.00	300-400

* Pre-assembled insert should be ordered mounted in barrel.

SERVICE VOLTAGE RATING
A = 240V, D = 600V

Insert Configurations

front face of pin insert shown

19 Contacts

Style	Wire Terminal Type	Shell Size	Insert Type	Dash Number	Catalog Number	Qty.	Size AWG	Service Voltage Rating
Mod II	Radsok Crimp	16	Pin Socket	312PN 312SN	ZP-16-312PN ZP-16-312SN	19	12	A

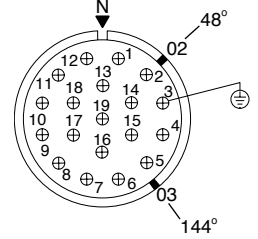

19 Contacts

Style	Wire Terminal Type	Shell Size	Insert Type	Dash Number	Catalog Number	Qty.	Size AWG	Service Voltage Rating
Mod II	Crimp	16	Pin Socket	355PN 355SN	ZP-16-355PN ZP-16-355SN	19	16	A

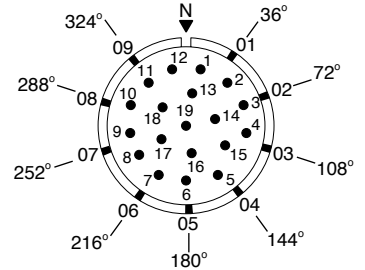

19 Contacts

Style	Wire Terminal Type	Shell Size	Insert Type	Dash Number	Catalog Number	Qty.	Size AWG	Service Voltage Rating
Mod II	Radsok Crimp	20	Pin Socket	376PN 376SN	ZP-20-376PN ZP-20-376SN	19	12	D

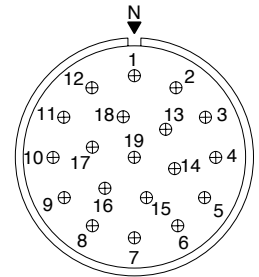

19 Contacts

Style	Wire Terminal Type	Shell Size	Insert Type	Dash Number	Catalog Number	Qty.	Size AWG	Service Voltage Rating
Mod II	Crimp	20	Pin Socket	388PN 388SN	ZP-20-388PN ZP-20-388SN	19	12	D

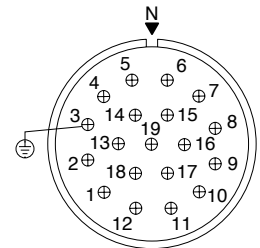

Grounding Contact Termination Symbol			Contact Symbols											
Solder Well	Pressure	Crimp	Wire Size AWG	18	16	12	10	8	4	1/0	4/0	350 MCM	500 MCM	646-777
			Metric	0.75	1.5	4.0	6.0	10.0	25.0	50.0	120.00	185.00	240.00	300-400

★ Pre-assembled insert should be ordered mounted in barrel.

SERVICE VOLTAGE RATING
A = 240V, D = 600V

Insert Configurations

front face of pin insert shown

20 Contacts

Style	Wire Terminal Type	Shell Size	Insert Type	Dash Number	Catalog Number
Mod I	Solder	20	Pin	32P	ZP-20-32P
			Socket	32S	ZP-20-32S
Mod II	Radsok Crimp	20	Pin	332PN	ZP-20-332PN
			Socket	332SN	ZP-20-332SN

Qty.	Size AWG	Service Voltage Rating
20	12	B Center A Outer

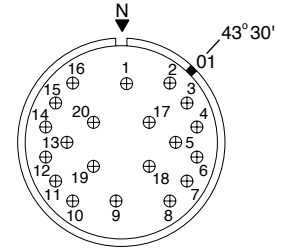

20 Contacts

Style	Wire Terminal Type	Shell Size	Insert Type	Dash Number	Catalog Number
Mod II	Radsok Crimp	20	Pin Socket	387PN 387SN	ZP-20-387PN ZP-20-387SN

Qty.	Size AWG	Service Voltage Rating
20	12	B Center A Outer

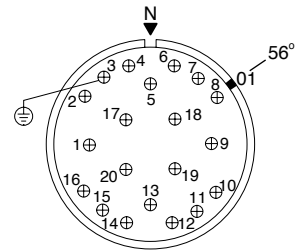

20 Contacts

Style	Wire Terminal Type	Shell Size	Insert Type	Dash Number	Catalog Number
Mod II	Crimp	20	Pin	334PN	ZP-20-334PN
			Socket	334SN	ZP-20-334SN

Qty.	Size AWG	Service Voltage Rating
4	8	D
16	16	D

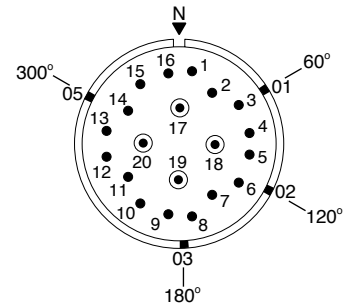

21 Contacts

Style	Wire Terminal Type	Shell Size	Insert Type	Dash Number	Catalog Number
Mod II	Crimp	16	Pin	344PN	ZP-16-344PN
			Socket	344SN	ZP-16-344SN

Qty.	Size AWG	Service Voltage Rating
10	12	A
11	16	A

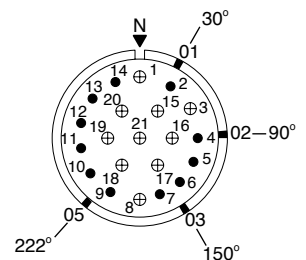

Grounding Contact Termination Symbol			Contact Symbols											
			Wire Size AWG	18	16	12	10	8	4	1/0	4/0	350 MCM	500 MCM	646-777
			Metric	0.75	1.5	4.0	6.0	10.0	25.0	50.0	120.00	185.00	240.00	300-400

★ Pre-assembled insert should be ordered mounted in barrel.

SERVICE VOLTAGE RATING
A = 240V, D = 600V

Insert Configurations

front face of pin insert shown

22 Contacts

Style	Wire Terminal Type	Shell Size	Insert Type	Dash Number	Catalog Number	Qty.	Size AWG	Service Voltage Rating
Mod II	Crimp	20	Pin Socket	331PN	ZP-20-331PN	2	8	E
				331SN	ZP-20-331SN	20	16	D

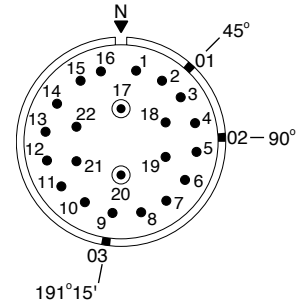

26 Contacts

Style	Wire Terminal Type	Shell Size	Insert Type	Dash Number	Catalog Number	Qty.	Size AWG	Service Voltage Rating
Mod I	Solder	16	Pin Socket	37P	ZP-16-37P	4	12	A
				37S	ZP-16-37S	4	16	A
						18	18	A

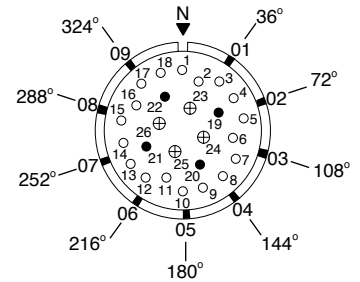

27 Contacts

Style	Wire Terminal Type	Shell Size	Insert Type	Dash Number	Catalog Number	Qty.	Size AWG	Service Voltage Rating
Mod II	Crimp	16	Pin Socket	335PN	ZP-16-335PN	3	12	A
				335SN	ZP-16-335SN	24	16	A

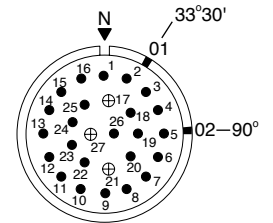

27 Contacts

Style	Wire Terminal Type	Shell Size	Insert Type	Dash Number	Catalog Number	Qty.	Size AWG	Service Voltage Rating
Mod II	Crimp	16	Pin Socket	373PN	ZP-16-373PN	24	16	A
				373SN	ZP-16-373SN	3	12	A

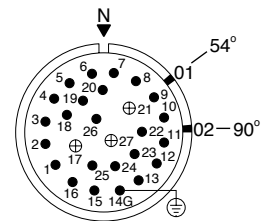

Grounding Contact Termination Symbol			Contact Symbols											
Solder Well	Pressure	Crimp	Wire Size AWG	18	16	12	10	8	4	1/0	4/0	350 MCM	500 MCM	646-777
			Metric	0.75	1.5	4.0	6.0	10.0	25.0	50.0	120.00	185.00	240.00	300-400

★ Pre-assembled insert should be ordered mounted in barrel.

SERVICE VOLTAGE RATING
A = 240V, D = 600V

Insert Configurations

front face of pin insert shown

27 Contacts

Style	Wire Terminal Type	Shell Size	Insert Type	Dash Number	Catalog Number	Qty.	Size AWG	Service Voltage Rating
Mod II	Crimp	20	Pin Socket	374PN	ZP-20-374PN	2	4	D
				374SN	ZP-20-374SN	25	12	A

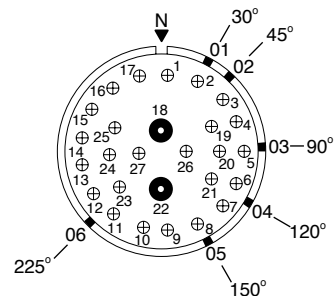

29 Contacts

Style	Wire Terminal Type	Shell Size	Insert Type	Dash Number	Catalog Number	Qty.	Size AWG	Service Voltage Rating
Mod II	Crimp	C28	Pin Socket	328PN	ZP-C28-328PN	4	1/0	D
				328SN	ZP-C28-328SN	2	8	D
						23	12	A

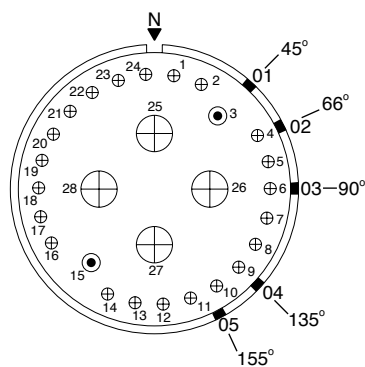

37 Contacts

Style	Wire Terminal Type	Shell Size	Insert Type	Dash Number	Catalog Number	Qty.	Size AWG	Service Voltage Rating
Mod II	Crimp	16	Pin Socket	321PN	ZP-16-321PN	37	16	A
				321SN	ZP-16-321SN			

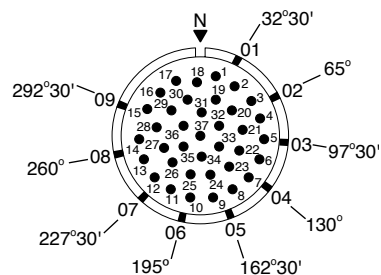

37 Contacts

Style	Wire Terminal Type	Shell Size	Insert Type	Dash Number	Catalog Number	Qty.	Size AWG	Service Voltage Rating
Mod II	Radsok Crimp	20	Pin Socket	386PN	ZP-20-386PN	37	12	A
				386SN	ZP-20-386SN			

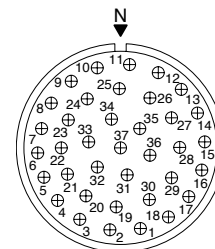

Grounding Contact Termination Symbol			Contact Symbols											
			○	●	⊕	○	⊙	●	⊕	△	□	○	⊗	
Solder Well	Pressure	Crimp	Wire Size AWG	18	16	12	10	8	4	1/0	4/0	350 MCM	500 MCM	646-777
			Metric	0.75	1.5	4.0	6.0	10.0	25.0	50.0	120.00	185.00	240.00	300-400

★ Pre-assembled insert should be ordered mounted in barrel.

SERVICE VOLTAGE RATING
A = 240V, D = 600V

Insert Configurations

front face of pin insert shown

37 Contacts

Style	Wire Terminal Type	Shell Size	Insert Type	Dash Number	Catalog Number	Qty.	Size AWG	Service Voltage Rating
Mod II	Radsok Crimp	20	Pin Socket	350PN	ZP-20-350PN	37	12	A
				350SN	ZP-20-350SN			

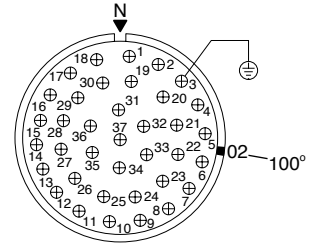

37 Contacts

Style	Wire Terminal Type	Shell Size	Insert Type	Dash Number	Catalog Number	Qty.	Size AWG	Service Voltage Rating
Mod II	Crimp	24	Pin Socket	371PN	ZP-24-371PN	37	16	D
				371SN	ZP-24-371SN			

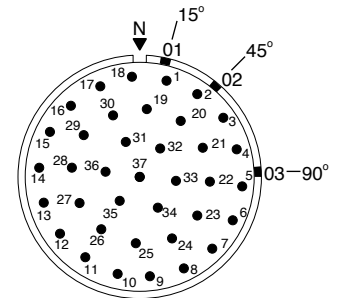

37 Contacts

Style	Wire Terminal Type	Shell Size	Insert Type	Dash Number	Catalog Number	Qty.	Size AWG	Service Voltage Rating
Mod I	Solder	C24	Pin Socket	36P	ZP-C24-36P	2	1/0	D
				36S	ZP-C24-36S	35	12	A

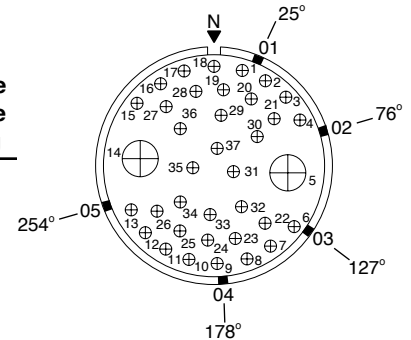

38 Contacts

Style	Wire Terminal Type	Shell Size	Insert Type	Dash Number	Catalog Number	Qty.	Size AWG	Service Voltage Rating
Mod II	Crimp	20	Pin Socket	323PN	ZP-20-323PN	3	10	A
				323SN	ZP-20-323SN	35	16	A

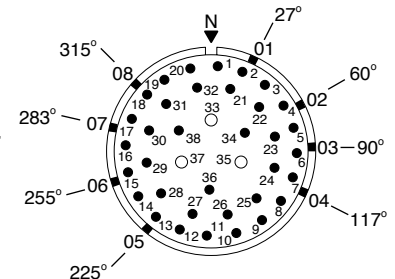

Grounding Contact Termination Symbol			Contact Symbols											
Solder Well	Pressure	Crimp	Wire Size AWG	18	16	12	10	8	4	1/0	4/0	350 MCM	500 MCM	646-777
			Metric	0.75	1.5	4.0	6.0	10.0	25.0	50.0	120.00	185.00	240.00	300-400

★ Pre-assembled insert should be ordered mounted in barrel.

SERVICE VOLTAGE RATING
A = 240V, D = 600V

Insert Configurations

front face of pin insert shown

42 Contacts

Style	Wire Terminal Type	Shell Size	Insert Type	Dash Number	Catalog Number	Qty.	Size AWG	Service Voltage Rating
Mod II	Radsok Crimp	28	Pin Socket	339PN 339SN	ZP-28-339PN ZP-28-339SN	42	12	D

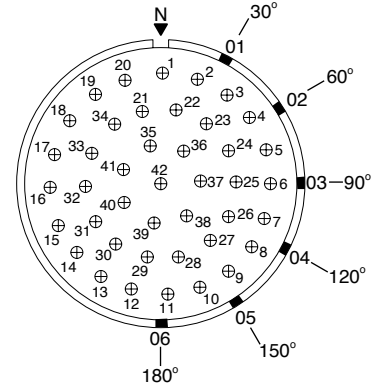

46 Contacts

Style	Wire Terminal Type	Shell Size	Insert Type	Dash Number	Catalog Number	Qty.	Size AWG	Service Voltage Rating
Mod II	Crimp	16	Pin Socket	371PN 371SN	ZP-16-371PN ZP-16-371SN	45 1	18 8	A A

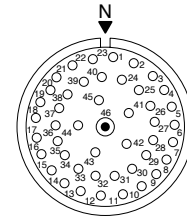

47 Contacts

Style	Wire Terminal Type	Shell Size	Insert Type	Dash Number	Catalog Number	Qty.	Size AWG	Service Voltage Rating
Mod II	Crimp	20	Pin Socket	354PN 354SN	ZP-20-354PN ZP-20-354SN	2 45	8 16	D A

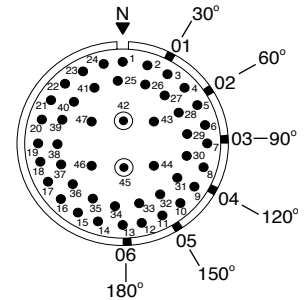

47 Contacts

Style	Wire Terminal Type	Shell Size	Insert Type	Dash Number	Catalog Number	Qty.	Size AWG	Service Voltage Rating
Mod I	Solder	C28	Pin Socket	15P 15S	ZP-C28-15P ZP-C28-15S	1 3 43	1/0 4 12	D D A

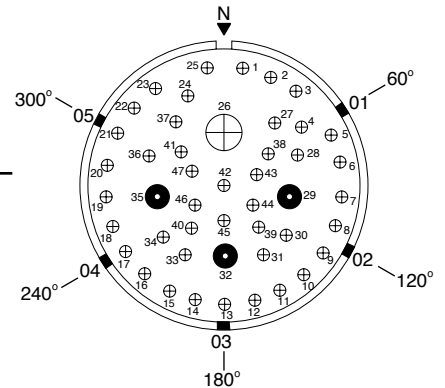

Grounding Contact Termination Symbol			Contact Symbols											
Solder Well	Pressure	Crimp	Wire Size AWG	18	16	12	10	8	4	1/0	4/0	350 MCM	500 MCM	646-777
			Metric	0.75	1.5	4.0	6.0	10.0	25.0	50.0	120.00	185.00	240.00	300-400

★ Pre-assembled insert should be ordered mounted in barrel.

SERVICE VOLTAGE RATING
A = 240V, D = 600V

Insert Configurations

50 Contacts

Style	Wire Terminal Type	Shell Size	Insert Type	Dash Number	Catalog Number
Mod III	Crimp	20	Pin	673PN	★
				673SN	★

Qty.	Size AWG	Service Voltage Rating
4	8	D
46	16	A



front face of pin insert shown

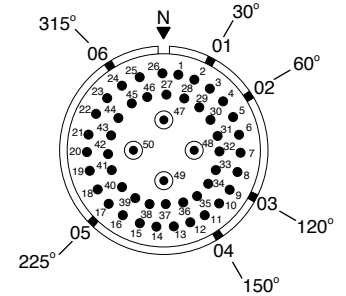

55 Contacts

Style	Wire Terminal Type	Shell Size	Insert Type	Dash Number	Catalog Number
Mod III	Crimp	16	Pin	640PN	★
				640SN	★

Qty.	Size AWG	Service Voltage Rating
55	18	Inst.

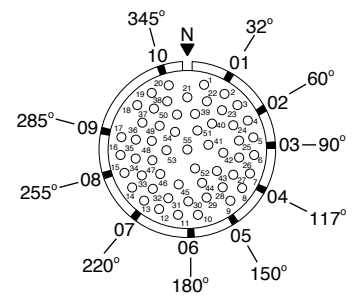

55 Contacts

Style	Wire Terminal Type	Shell Size	Insert Type	Dash Number	Catalog Number
Mod II	Crimp	28	Pin	324PN	ZP-28-324PN
				324SN	ZP-28-324SN

Qty.	Size AWG	Service Voltage Rating
3	8	D
6	4	D
5	12	A
41	16	A

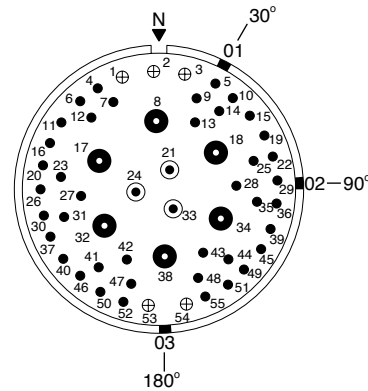

58 Contacts

Style	Wire Terminal Type	Shell Size	Insert Type	Dash Number	Catalog Number
Mod I	Solder	24	Pin	84P	ZP-24-84P
			Socket	84S	ZP-24-84S
Mod II	Radsok Crimp	24	Pin	384PN	ZP-24-384PN
				384SN	ZP-24-384SN

Qty.	Size AWG	Service Voltage Rating
58	12	A

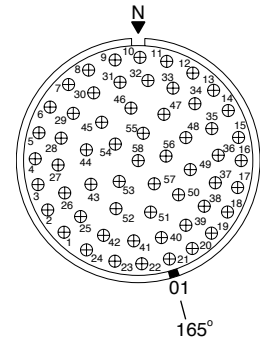

Grounding Contact Termination Symbol			Contact Symbols											
Solder Well	Pressure	Crimp	Wire Size AWG	18	16	12	10	8	4	1/0	4/0	350 MCM	500 MCM	646-777
			Metric	0.75	1.5	4.0	6.0	10.0	25.0	50.0	120.00	185.00	240.00	300-400

★ Pre-assembled insert should be ordered mounted in barrel.

SERVICE VOLTAGE RATING
A = 240V, D = 600V

Insert Configurations

58 Contacts

Style	Wire Terminal Type	Shell Size	Insert Type	Dash Number	Catalog Number	Qty.	Size AWG	Service Voltage Rating
Mod II	Radsok Crimp	24	Pin Socket	352PN 352SN	ZP-24-352PN ZP-24-352SN	58	12	A



front face of pin insert shown

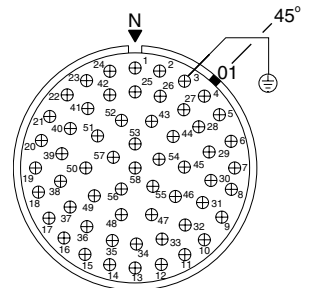

60 Contacts

Style	Wire Terminal Type	Shell Size	Insert Type	Dash Number	Catalog Number	Qty.	Size AWG	Service Voltage Rating
Mod I	Solder	20	Pin Socket	35P 35S	ZP-20-35P ZP-20-35S	60	16	A

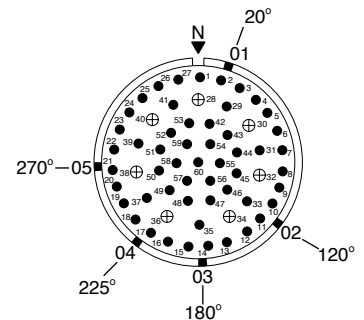

60 Contacts

Style	Wire Terminal Type	Shell Size	Insert Type	Dash Number	Catalog Number	Qty.	Size AWG	Service Voltage Rating
Mod II	Crimp	24	Pin Socket	331PN 331SN	ZP-24-331PN ZP-24-331SN	7 53	12 16	A A

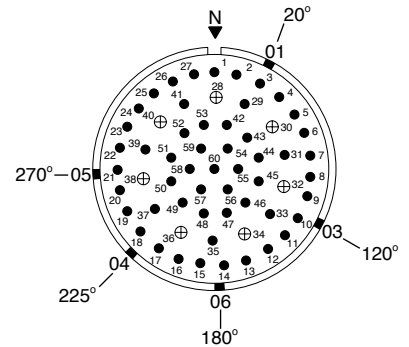

60 Contacts

Style	Wire Terminal Type	Shell Size	Insert Type	Dash Number	Catalog Number	Qty.	Size AWG	Service Voltage Rating
Mod II	Radsok Crimp	24	Pin Socket	389PN 389SN	ZP-24-389PN ZP-24-389SN	60	16	A

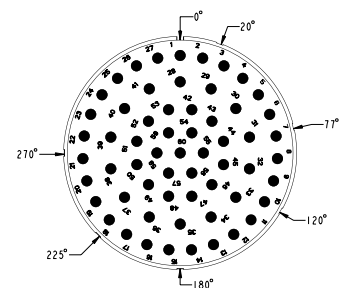

Grounding Contact Termination Symbol			Contact Symbols											
			○	●	⊕	○	⊙	●	⊕	⊖	⊗	⊘	⊙	⊚
Solder Well	Pressure	Crimp	Wire Size AWG	18	16	12	10	8	4	1/0	4/0	350 MCM	500 MCM	646-777
			Metric	0.75	1.5	4.0	6.0	10.0	25.0	50.0	120.00	185.00	240.00	300-400

★ Pre-assembled insert should be ordered mounted in barrel.

SERVICE VOLTAGE RATING
A = 240V, D = 600V

Insert Configurations

61 Contacts

Style	Wire Terminal Type	Shell Size	Insert Type	Dash Number	Catalog Number	Qty.	Size AWG	Service Voltage Rating
Mod II	Crimp	16	Pin Socket	333PN 333SN	ZP-16-333PN ZP-16-333SN	61	18	Inst.



front face of pin insert shown

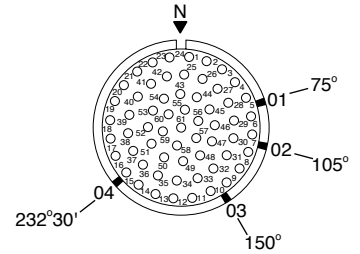

62 Contacts

Style	Wire Terminal Type	Shell Size	Insert Type	Dash Number	Catalog Number	Qty.	Size AWG	Service Voltage Rating
Mod II	Radsok Crimp	20	Pin Socket	362PN 362SN	ZP-24-362PN ZP-24-362SN	44 18	12 16	A

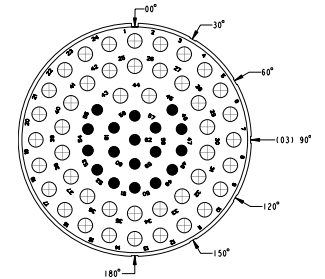

64 Contacts

Style	Wire Terminal Type	Shell Size	Insert Type	Dash Number	Catalog Number	Qty.	Size AWG	Service Voltage Rating
Mod II	Crimp	20	Pin Socket	329PN 329SN	ZP-20-329PN ZP-20-329SN	2 62	10 16	A A

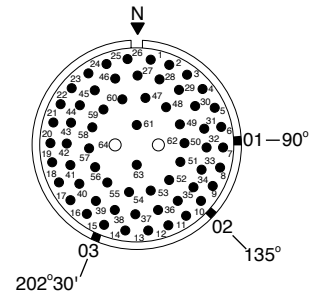

68 Contacts

Style	Wire Terminal Type	Shell Size	Insert Type	Dash Number	Catalog Number	Qty.	Size AWG	Service Voltage Rating
Mod II	Crimp	20	Pin Socket	313PN 313SN	ZP-20-313PN ZP-20-313SN	68	16	A

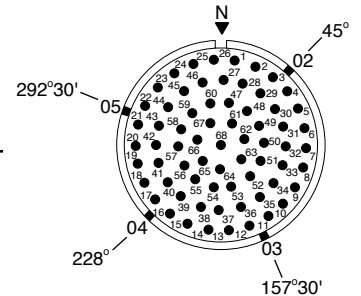

Grounding Contact Termination Symbol			Contact Symbols	Wire Size AWG	Metric	Service Voltage Rating
				18	0.75	A = 240V, D = 600V
Solder Well	Pressure	Crimp		16	1.5	
				12	4.0	
				10	6.0	
				8	10.0	
				4	25.0	
				1/0	50.0	
				4/0	120.00	
				350 MCM	185.00	
				500 MCM	240.00	
				646-777	300-400	

★ Pre-assembled insert should be ordered mounted in barrel.

Insert Configurations

72 Contacts

Style	Wire Terminal Type	Shell Size	Insert Type	Dash Number	Catalog Number	Qty.	Size AWG	Service Voltage Rating
Mod II	Radsok Crimp	24	Pin Socket	388PN 388SN	ZP-24-388PN ZP-24-388SN	72	16	A

front face of pin insert shown

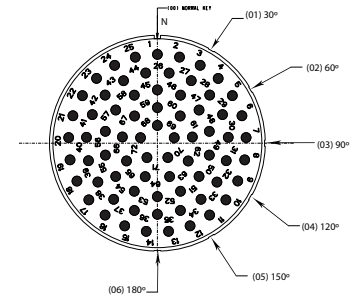

75 Contacts

Style	Wire Terminal Type	Shell Size	Insert Type	Dash Number	Catalog Number	Qty.	Size AWG	Service Voltage Rating
Mod II	Crimp	24	Pin Socket	354PN 354SN	ZP-24-354PN ZP-24-354SN	3 11 61	8 12 16	A A A

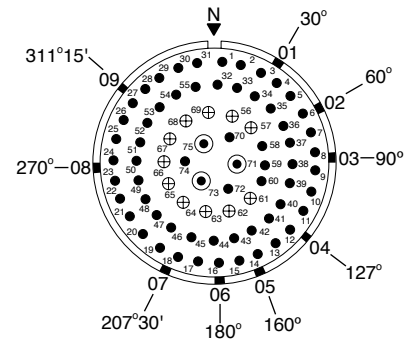

81 Contacts

Style	Wire Terminal Type	Shell Size	Insert Type	Dash Number	Catalog Number	Qty.	Size AWG	Service Voltage Rating
Mod II	Crimp	20	Pin Socket	344PN 344SN	ZP-20-344PN ZP-20-344SN	11 70	12 18	A A

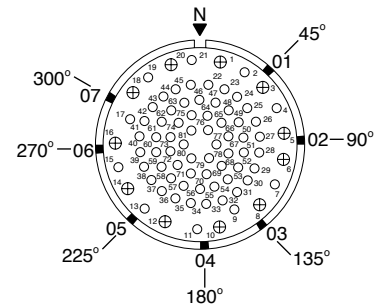

90 Contacts

Style	Wire Terminal Type	Shell Size	Insert Type	Dash Number	Catalog Number	Qty.	Size AWG	Service Voltage Rating
Mod II	Crimp	20	Pin Socket	345PN 345SN	ZP-20-345PN ZP-20-345SN	90	18	A

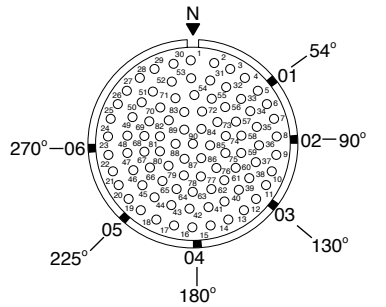

Grounding Contact Termination Symbol			Contact Symbols											
			○	●	⊕	○	⊙	⦿	⊕	⊔	⊕	⊕	⊕	⊕
Solder Well	Pressure	Crimp	Wire Size AWG	18	16	12	10	8	4	1/0	4/0	350 MCM	500 MCM	646-777
			Metric	0.75	1.5	4.0	6.0	10.0	25.0	50.0	120.00	185.00	240.00	300-400

★ Pre-assembled insert should be ordered mounted in barrel.

SERVICE VOLTAGE RATING
A = 240V, D = 600V

Insert Configurations

100 Contacts

Style	Wire Terminal Type	Shell Size	Insert Type	Dash Number	Catalog Number	Qty.	Size AWG	Service Voltage Rating
Mod II	Crimp	24	Pin Socket	313PN 313SN	ZP-24-313PN ZP-24-313SN	100	16	◆A



front face of pin insert shown

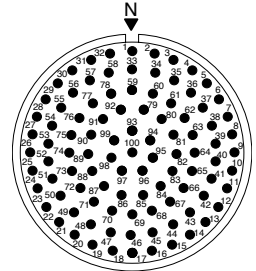

100 Contacts

Style	Wire Terminal Type	Shell Size	Insert Type	Dash Number	Catalog Number	Qty.	Size AWG	Service Voltage Rating
Mod II	Crimp	24	Pin Socket	385PN 385SN	ZP-24-385PN ZP-24-385SN	100	16	A

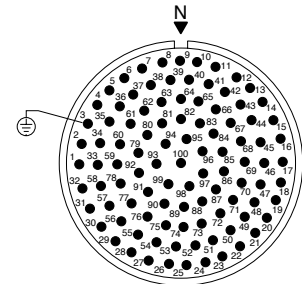

100 Contacts

Style	Wire Terminal Type	Shell Size	Insert Type	Dash Number	Catalog Number	Qty.	Size AWG	Service Voltage Rating
Mod II	Crimp	28	Pin Socket	314PN 314SN	ZP-28-314PN ZP-28-314SN	17 83	12 16	A A

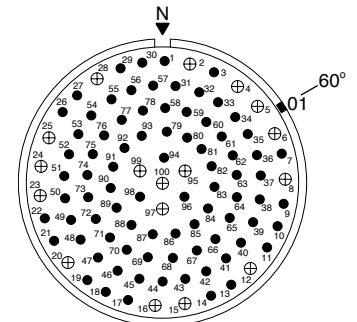

143 Contacts

Style	Wire Terminal Type	Shell Size	Insert Type	Dash Number	Catalog Number	Qty.	Size AWG	Service Voltage Rating
Mod II	Crimp	28	Pin Socket	322PN 322SN	ZP-28-322PN ZP-28-322SN	143	16	A

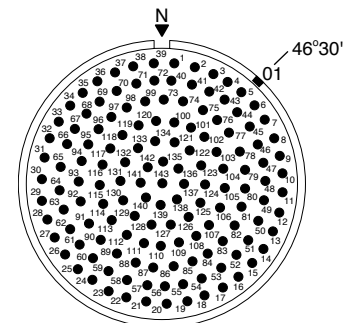

Grounding Contact Termination Symbol			Contact Symbols	Wire Size AWG	Metric	Service Voltage Rating
				18	0.75	A = 240V, D = 600V
Solder Well	Pressure	Crimp		16	1.5	
				12	4.0	
				10	6.0	
				8	10.0	
				4	25.0	
				1/0	50.0	
				4/0	120.00	
				350 MCM	185.00	
				500 MCM	240.00	
				646-777	300-400	

★ Pre-assembled insert should be ordered mounted in barrel.

V.F.D. Insert Configurations

A **variable-frequency drive (VFD)** controls the rotational speed of an alternating current (AC) electric motor by controlling the frequency of the electrical power supplied to the motor. VFD motors operate at varied voltages and frequencies, which in turn create higher operating temperatures - creating issues for most electrical connectors. Amphenol is able to meet the operating requirements of a VFD motor by incorporating a specially designed insert material. The inserts can carry a higher dielectric rating, allowing them to withstand the voltage spikes found in a VFD application.

In addition, Amphenol utilizes our patented RADSOK® contact design in our VFD inserts. The RADSOK® contacts allow a higher amperage, and result in lower temperature rise in our connectors. These specific inserts have been selected to accommodate the phase conductors, as well as grounding conductors present in VFD rated cables.

In addition, shielding contacts are provided in these inserts to allow for terminating the overall cable shield to reduce EMI. These inserts are all also rated to 1000 V.A.C.



6 Contacts

Style	Wire Terminal Type	Shell Size	Insert Type	Dash Number	Catalog Number
Mod I	Pressure	20	Pin	43PR	ZP-20-43PR
			Socket	43SR	ZP-20-43SR
Mod III	Crimp	20	Pin	643PN	★
			Socket	643SN	★

Qty.	Size AWG	Service Voltage Rating
4	4	D
2	10	D



front face of pin insert shown

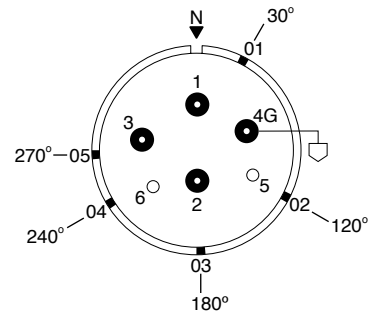

6 Contacts

Style	Wire Terminal Type	Shell Size	Insert Type	Dash Number	Catalog Number
Mod I	Solder	C28	Pin	18P	ZP-C28-18P
			Socket	18S	ZP-C28-18S
Mod I	Radsok Solder	C28	Pin	R18P	ZP-C28-R18P
			Socket	R18S	ZP-C28-R18S

Qty.	Size AWG	Service Voltage Rating
4	350 MCM	D
2	12	E

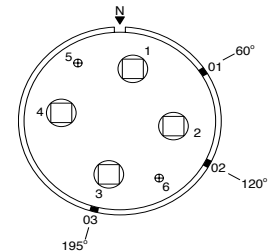

Grounding Contact Termination Symbol			Contact Symbols											
Solder Well	Pressure	Crimp	Wire Size AWG	18	16	12	10	8	4	1/0	4/0	350 MCM	500 MCM	646-777
			Metric	0.75	1.5	4.0	6.0	10.0	25.0	50.0	120.00	185.00	240.00	300-400

SERVICE VOLTAGE RATING
A = 240V, D = 600V

V.F.D. Insert Configurations

front face of pin insert shown

6 Contacts

Style	Wire Terminal Type	Shell Size	Insert Type	Dash Number	Catalog Number
Mod I	Solder	C28	Pin	42P	ZP-C28-42P
			Socket	42S	ZP-C28-42S
Mod I	Pressure	C28	Pin	42PR	ZP-C28-42PR
			Socket	42SR	ZP-C28-42SR
Mod I	Radsok Pressure	C28	Pin	R42PR	ZP-C28-R42PR
			Socket	R42SR	ZP-C28-R42SR

Qty.	Size AWG	Service Voltage Rating
4	4/0	D
2	10	D

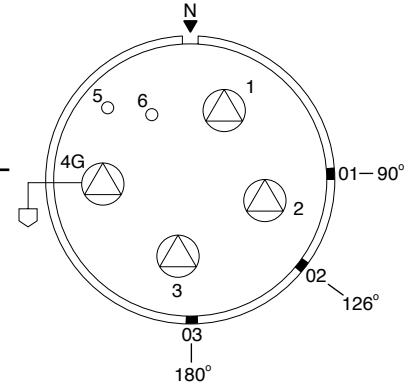

7 Contacts

Style	Wire Terminal Type	Shell Size	Insert Type	Dash Number	Catalog Number
Mod I	Radsok Pressure	C24	Pin	R44PR	ZP-C24-R44PR
			Socket	R44SR	ZP-C24-R44SR

Qty.	Size AWG	Service Voltage Rating
3	1/0	D
3	8	D

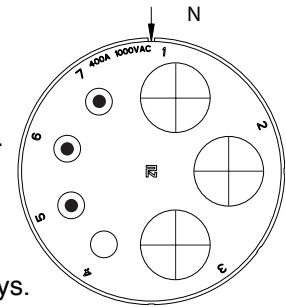

Refer to factory for current alternate keyways.

7 Contacts

Style	Wire Terminal Type	Shell Size	Insert Type	Dash Number	Catalog Number
Mod I	Radsok Pressure	C28	Pin	R44PR	ZP-C28-R44PR
			Socket	R44SR	ZP-C28-R44SR

Qty.	Size AWG	Service Voltage Rating
3	4/0	D
3	8	D
1	10	D

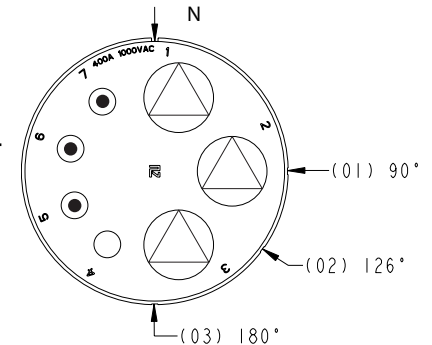

Grounding Contact Termination Symbol			Contact Symbols	○	●	⊕	○	⊙	●	⊕	△	□	○	⊗
			Wire Size AWG	18	16	12	10	8	4	1/0	4/0	350 MCM	500 MCM	646-777
Solder Well	Pressure	Crimp	Metric	0.75	1.5	4.0	6.0	10.0	25.0	50.0	120.00	185.00	240.00	300-400

★ Pre-assembled insert should be ordered mounted in barrel.

SERVICE VOLTAGE RATING
A = 240V, D = 600V

Connector Components Spare Parts and Accessories

Male Skirt for Straight Plug

Male skirts only for Mod I are designated by a four-digit number.

Example: ZP-W-1312 (Star-Line)

Male skirts only for Mod II are designated by a seven-digit number.

Example: ZP-W-1312-200 (Star-Line)

Mod II inserts must not be used in Mod I shells or Mod I inserts in Mod II shells as the method of accomplishing environmental sealing differs

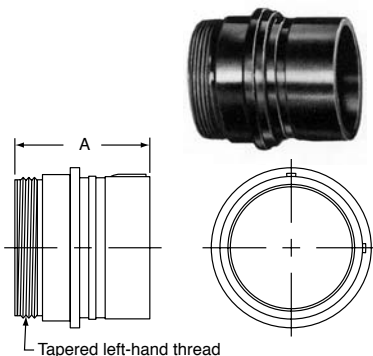

Shell Size	Cat. No. Mod I	DIMENSIONS	
		A	
12	ZP-W-1312	2-1/64	
16	ZP-W-1316	2-1/64	
20	ZP-W-1320	2-1/64	
C20	ZP-C-1320	2-33/64	
24	ZP-W-1324	2-1/64	
C24	ZP-C-1324	2-33/64	
28	ZP-W-1328	2-1/64	
C28	ZP-C-1328	2-33/64	

Female Skirt for In-Line Receptacle

Female skirts only for Mod I are designated by a four-digit number.

Example: ZP-WO-1512 (Star-Line)

Female skirts only for Mod II are designated by a seven-digit number.

Example: ZP-WO-1512-200 (Star-Line)

Mod II inserts must not be used in Mod I shells or Mod I inserts in Mod II shells as the method of accomplishing environmental sealing differs.

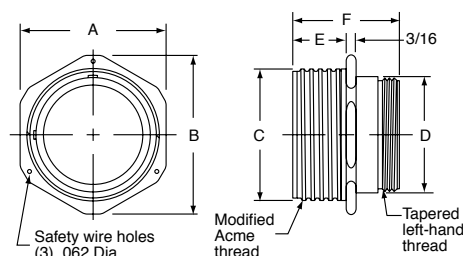

Shell Size	Cat. No. Mod I	DIMENSIONS					
		A	B	C	D	E	F
12	ZP-WO-1512	1-3/4	1-61/64	1-1/2	1-3/32	1	2-1/64
16	ZP-WO-1516	2-1/4	2-31/64	2	1-19/32	1	2-1/64
20	ZP-WO-1520	2-3/4	3-1/32	2-1/2	2-3/32	1	2-1/64
C20	ZP-CO-1520	2-3/4	3-1/32	2-1/2	2-3/32	1-1/2	2-33/64
24	ZP-WO-1524	3-1/4	3-9/16	3	2-19/32	1	2-1/64
C24	ZP-CO-1524	3-1/4	3-9/16	3	2-19/32	1-1/2	2-33/64
28	ZP-WO-1528	3-3/4	4-1/16	3-1/2	3-3/32	1	2-1/64
C28	ZP-CO-1528	3-3/4	4-1/16	3-1/2	3-3/32	1-1/2	2-33/64

Basic Barrel for Panel, Square Flange Receptacle

Square flange receptacles only for Mod I are designated by a four digit number.

Example: ZP-WO-1712 (Star-Line)

Square flange receptacles only for Mod II are designated by a seven digit number.

Example: ZP-WO-1712-200 (Star-Line)

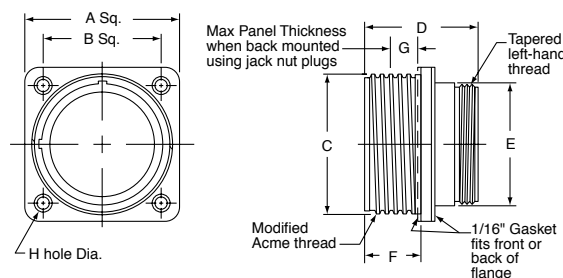

Shell Size	Cat. No. Mod I	DIMENSIONS							
		A	B	C	D	E	F	G	H
12	ZP-WO-1712	1-3/4	1-3/8	1-1/2	2-1/64	1-3/8	1	1/4	11/64
16	ZP-WO-1716	2-1/4	1-11/16	2	2-1/64	1-7/8	1	1/4	13/64
20	ZP-WO-1720	2-3/4	2-3/32	2-1/2	2-1/64	2-3/8	1	1/4	7/32
C20	ZP-CO-1720	2-3/4	2-3/32	2-1/2	2-33/64	2-3/8	1-1/2	3/4	7/32
24	ZP-WO-1724	3-1/4	2-17/32	3	2-1/64	2-7/8	1	1/4	9/32
C24	ZP-CO-1724	3-1/4	2-17/32	3	2-33/64	2-7/8	1-1/2	3/4	9/32
28	ZP-WO-1728	3-3/4	3-1/32	3-1/2	2-1/64	3-3/8	1	1/4	11/32
C28	ZP-CO-1728	3-3/4	3-1/32	3-1/2	2-33/64	3-3/8	1-1/2	3/4	11/32

Drill hole on panel 1/64" larger than Dimension "E" for front mounting or Dimension "C" for back mounting.

**Maximum panel thickness may be increased 1/8" when using Standard Coupling Nut Plugs.

Cable Grip Components

Gland washers are not required when grommets are used with basket weave cable grips.

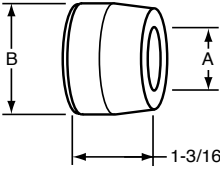

Grommets

Shell Size	Washer Dimensions	
	A	B
12	See cable dia.	1-7/32
16	column "A"	1-3/4
20 & C20	for cable	2-7/32
24 & C24	range	2-3/4
28 & C28		3-1/4

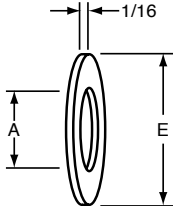

Gland Washers

Shell Size	Washer Dimensions	
	A	B
12	See cable dia.	1-1/4
16	column "A"	1-3/4
20 & C20	for cable	2-1/4
24 & C24	range	2-3/4
28 & C28		3-1/4

* Substitute Symbol for ▲ in Cable Adapter Catalog Number

Shell Size	Cable Dia. Dimension		Cable Dia. Code No.*	Grommets Oil Resistant Rubber Cat. No.	Gland Washer Steel Cat. No.	Basket Weave Grips		
	Min.	Max.				Stainless Steel Cat. No.	Nominal Length Inches	
12	.062	.125	02	ZP-6312-2C	ZP-8012-4E	ZP-5012-4E	3	
	.125	.250	04	ZP-6312-4C				
	.250	.375	06	ZP-6312-6C	ZP-8012-8E	ZP-5012-6E	4	
	.375	.500	08	ZP-6312-8C				
	.500	.625	10	ZP-6312-10C	ZP-8012-12E	ZP-5012-10E	6	
	.625	.750	12	ZP-6312-12C				
	.750	.875	14	ZP-6312-14C	ZP-8012-15E	ZP-5012-14E	7-1/2	
	.875	.937	15	ZP-6312-15C				
16	.250	.375	06	ZP-6316-6C	ZP-8016-8E	ZP-5016-6E	4	
	.375	.500	08	ZP-6316-8C				
	.500	.625	10	ZP-6316-10C	ZP-8016-12E	ZP-5016-10E	6	
	.625	.750	12	ZP-6316-12C				
	.750	.875	14	ZP-6316-14C	ZP-8016-16E	ZP-5016-14E	7-1/2	
	.875	1.000	16	ZP-6316-16C				
	1.000	1.125	18	ZP-6316-18C	ZP-8016-20E	ZP-5016-18E	9	
	1.125	1.250	20	ZP-6316-20C				
	1.250	1.375	22	ZP-6316-22C	ZP-8016-23E	ZP-5016-20E	10	
	1.375	1.437	23	ZP-6316-23C				
20/C20	.500	.625	10	ZP-6320-10C	ZP-8020-12E	ZP-5020-10E	6	
	.625	.750	12	ZP-6320-12C				
	.750	.875	14	ZP-6320-14C	ZP-8020-16E	ZP-5020-14E	7-1/2	
	.875	1.000	16	ZP-6320-16C				
	1.000	1.125	18	ZP-6320-18C	ZP-8020-20E	ZP-5020-18E	9	
	1.125	1.250	20	ZP-6320-20C				
	1.250	1.375	22	ZP-6320-22C	ZP-8020-24E	ZP-5020-20E	10	
	1.375	1.500	24	ZP-6320-24C				
	1.500	1.625	26	ZP-6320-26C	ZP-8020-28E	ZP-5020-24E	11	
	1.625	1.750	28	ZP-6320-28C				
	1.750	1.875	30	ZP-6320-30C	ZP-8020-31E	ZP-5020-28E	13	
	1.875	1.937	31	ZP-6320-31C				
	24/C24	.875	1.000	16	ZP-6324-16C	ZP-8024-16E	ZP-5024-16E	8-1/2
		1.000	1.125	18	ZP-6324-18C			
1.125		1.250	20	ZP-6324-20C	ZP-8024-20E	ZP-5024-20E	10	
1.250		1.375	22	ZP-6324-22C				
1.375		1.500	24	ZP-6324-24C	ZP-8024-24E	ZP-5024-24E	11	
1.500		1.625	26	ZP-6324-26C				
1.625		1.750	28	ZP-6324-28C	ZP-8024-28E	ZP-5024-28E	13	
1.750		1.875	30	ZP-6324-30C				
1.875		2.000	32	ZP-6324-32C	ZP-8024-32E	ZP-5024-32E	15	
2.000		2.125	34	ZP-6324-34C				
2.125		2.250	36	ZP-6324-36C	ZP-8024-36E	ZP-5024-36E	16	
2.250		2.375	38	ZP-6324-38C				
2.375		2.437	39	ZP-6324-39C	ZP-8024-39E	ZP-5024-39E	17-1/2	
28/C28		1.375	1.500	24				ZP-6328-24C
	1.500	1.625	26	ZP-6328-26C				
	1.625	1.750	28	ZP-6328-28C	ZP-8028-28E	ZP-5028-28E	13	
	1.750	1.875	30	ZP-6328-30C				
	1.875	2.000	32	ZP-6328-32C	ZP-8028-32E	ZP-5028-32E	15	
	2.000	2.125	34	ZP-6328-34C				
	2.125	2.250	36	ZP-6328-36C	ZP-8028-36E	ZP-5028-36E	16	
	2.250	2.375	38	ZP-6328-38C				
	2.375	2.500	40	ZP-6328-40C	ZP-8028-40E	ZP-5028-40E	17-1/2	
	2.500	2.625	42	ZP-6328-42C				
2.625	2.750	44	ZP-6328-44C	ZP-8028-44E	ZP-5028-46E	19		
2.750	2.875	46	ZP-6328-46C					
				ZP-8028-46E	ZP-5028-46E	19		

Connector Accessories

Coupling Nuts (Star-Line only)

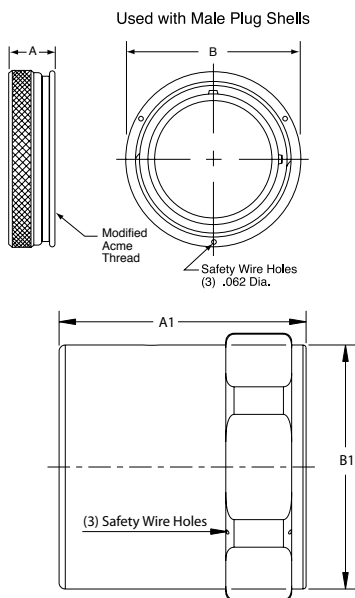

Shell Size	Catalog No. Standard Nut	DIMENSIONS	
		A	B
12	ZP-7012-10A	47/64	1-13/16
16	ZP-7016-10A	47/64	2-5/16
20/C20	ZP-7020-10A	47/64	2-13/16
24/C24	ZP-7024-10A	47/64	3-5/16
28/C28	ZP-7028-10A	47/64	3-13/16

Shell Size	Catalog No. Jacking Nut	DIMENSIONS	
		A	B
12	ZP-7012-30A	1-1/32	1-13/16
16	ZP-7016-30A	1-1/32	2-5/16
20/C20	ZP-7020-30A	1-1/32	2-13/16
24/C24	ZP-7024-30A	1-1/32	3-5/16
28/C28	ZP-7028-30A	1-1/32	3-13/16

Shell Size	Catalog No. Delay Nut	DIMENSIONS	
		A1	B1
12	ZP-7012-20A	3.09	1.71
16	ZP-7016-20A	3.09	2.00
20/C20	ZP-7020-20A	3.09	2.50
24/C24	ZP-7024-20A	3.75	3.00
28/C28	ZP-7028-20A	3.75	3.50

Insert Clamp Nuts

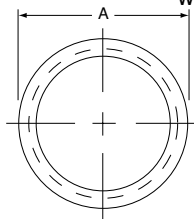
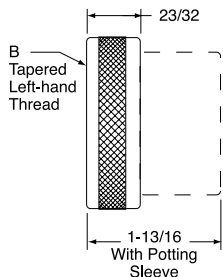

Used when open-back wiring is desired behind panelboards or within large junction boxes on which the basic barrel is mounted

Shell Size	Without Potting Sleeve Cat. No.	With Type 8200 Potting Sleeve Cat. No.	DIMENSIONS	
			A	B
12	ZP-W-7512	ZP-W-7512-B	1-11/32	1-3/32
16	ZP-W-7516	ZP-W-7516-B	1-27/32	1-19/32
20 & C20	ZP-W-7520	ZP-W-7520-B	1-11/32	2-3/32
24 & C24	ZP-W-7524	ZP-W-7524-B	2-27/32	2-19/32
28 & C28	ZP-W-7528	ZP-W-7528-B	3-11/32	3-3/32

Potting Sleeve

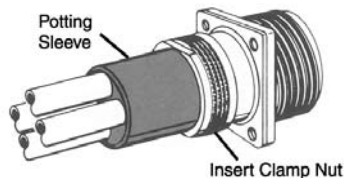

For use with insert clamp nut or panel board adapter to accept compound for sealing wire terminals. Potting sleeves are not for use with pressure-type contact units with insulator extension at back.

Shell Size	Catalog No.	Overall Length	DIMENSIONS	
			O. D.	I. D.
12	ZP-8212-11	1-1/4	1-3/64	55/64
16	ZP-8216-11	1-1/4	1-35/64	1-23/64
20 & C20	ZP-8220-11	1-1/4	2-3/64	1-55/64
24 & C24	ZP-8224-11	1-1/4	2-35/64	2-23/64
28 & C28	ZP-8228-11	1-1/4	2-63/64	2-51/64

Metal Potting Adapter

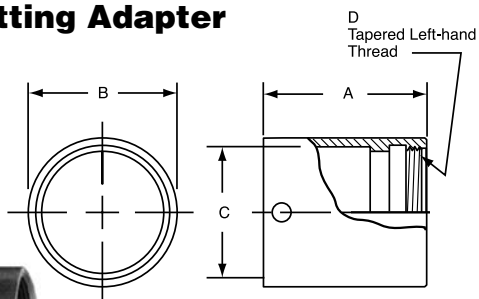

Shell Size	Standard Length Cat. No.	DIMENSIONS			
		A	B	C	D
12	ZP-8612-11	2-15/32	1.4675	1.12	1-3/32
16	ZP-8616-11	2-15/32	1.8575	1.62	1-19/32
20 & C20	ZP-8620-11	2-15/32	2.3675	2.12	2-3/32
24 & C24	ZP-8624-11	2-15/32	2.8425	2.62	2-19/32
28 & C28	ZP-8628-11	2-15/32	3.4325	3.12	3-3/32

Shell Size	Short Version Cat. No.	DIMENSIONS			
		A	B	C	D
12	ZP-8612-12	1-3/4	1.4675	1.12	1-3/32
16	ZP-8616-12	1-3/4	1.8575	1.62	1-19/32
20 & C20	ZP-8620-12	2	2.3675	2.12	2-3/32
24 & C24	NA				
28 & C28	NA				

Cable Adapter Components and Accessories

Conduit Adapters Tapped for Conduit

For use with all inserts other than those with pressure terminals.
Internal tapered pipe thread takes various types of threaded connectors.

Shell Size	NPT Conduit Tap Size	Catalog No.	DIMENSIONS				
			A	B	C	D	E
12	3/4	ZP-W-2812	2-5/8	1-13/32	1-1/2	1-3/8	3/4
16	1-1/4	ZP-W-2816	2-3/4	1-29/32	2	1-7/8	1-1/4
20 & C20	1-1/2	ZP-W-2820	2-7/8	2-13/32	2-1/2	2-3/8	1-1/2
24 & C24	2	ZP-W-2824	3	2-29/32	3	2-7/8	2
28 & C28	2-1/2	ZP-W-2828	3-15/32	3-13/32	3-1/2	3-3/8	2-1/2

Shell Size	Metric Conduit Tap Size	Catalog No.	DIMENSIONS				
			A Dim.	B Dim.	C Dim.	D Dim.	E Dim.
12	M25	ZP-W-2412-H402	4.00	1.39	1.50	1.38	M25
16	M40	ZP-W-2416-H402	6.00	1.89	2.00	1.88	M40
20 & C20	M50	ZP-W-2420-H40	6.00	2.39	2.50	2.38	M50
24 & C24	M63	ZP-W-2424-H402	6.00	2.89	3.00	2.88	M63
28 & C28	M75	ZP-W-2428-H402	6.00	3.9	3.50	3.38	M75

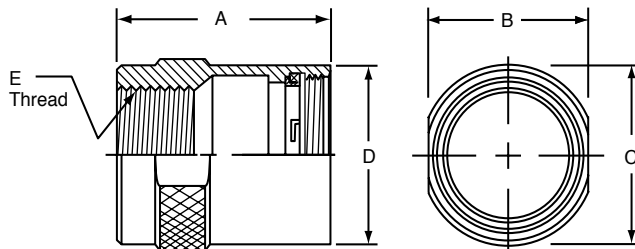
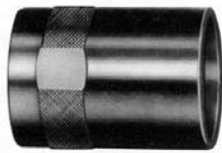

Cable Adapter

Thread Size	Shell Size	Standard Style Cat. No.	Long Style Cat. No.	Extra Long Style Cat. No.	DIMENSIONS			
					A			B
					Std.	Lg.	X Lg.	
1-3/8-12	12	ZP-W-2012	ZP-W-2412	ZP-W-2912	3	5-1/4	6-1/2	1-3/8
1-7/8-12	16	ZP-W-2016	ZP-W-2416	ZP-W-2916	3-1/4	5-1/2	6-3/4	1-7/8
2-3/8-12	20 & C20	ZP-W-2020	ZP-W-2420	ZP-W-2920	3-3/4	6	7-1/4	2-3/8
2-7/8-12	24 & C24	ZP-W-2024	ZP-W-2424	ZP-W-2924	4-1/4	6-1/2	7-3/4	2-7/8
3-3/8-12	28 & C28	ZP-W-2028	ZP-W-2428	ZP-W-2928	4-3/4	6-3/4	8	3-3/8

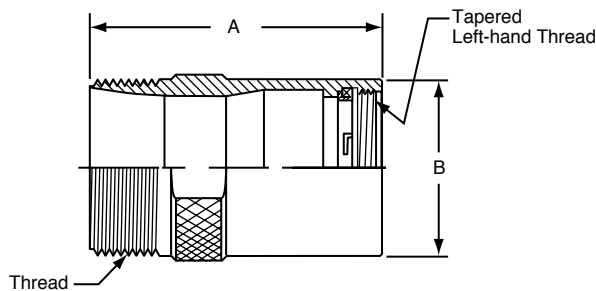

Cable Adapter Components and Accessories

Mechanical Clamp Nut

Shell Size	Catalog No.	DIMENSIONS			
		A	B	C	D
12	ZP-W-5312	2-3/8	1-3/4	7/8	2
16	ZP-W-5316	3	2-1/4	15/16	2-1/16
20 & C20	ZP-W-5320	3-3/4	2-3/4	1	2-1/8
24 & C24	ZP-W-5324	4-1/2	3-1/4	1-1/16	2-3/16
28 & C28	ZP-W-5328	5-1/8	3-3/4	1-1/8	2-1/4

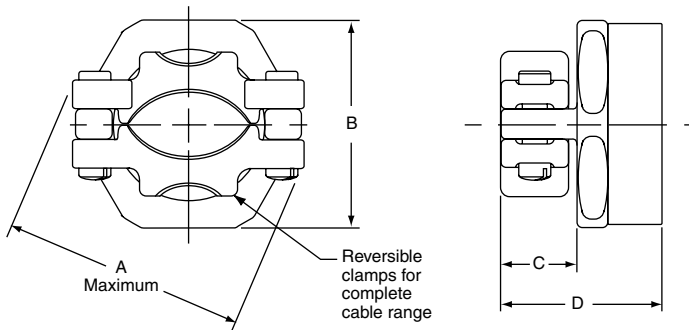

Panelboard Adapters (Star-Line only)

For Basic Barrels. Used when a completely external mounting is required. Gasket furnished may be used for front panel mounting only.

Shell Size	Catalog No.	DIMENSIONS								
		A	B	C	D	E	F	G	H	J
12	ZP-W-2112	1-5/8	1-1/4	1-1/8	1-3/32	3/32	9/16	3/4	1-3/8	3/16
16	ZP-W-2116	2-1/8	1-11/16	1-5/8	1-19/32	1/8	9/16	25/32	1-7/8	7/32
20 & C20	ZP-W-2120	2-5/8	2-3/32	2-1/8	2-3/32	5/32	9/16	13/16	2-3/8	9/32
24 & C24	ZP-W-2124	3-1/8	2-17/32	2-5/8	2-19/32	3/16	9/16	27/32	2-7/8	11/32
28 & C28	ZP-W-2128	3-3/4	3-1/32	3-1/8	2-3/32	9/32	29/64	27/32	3-3/8	11/32

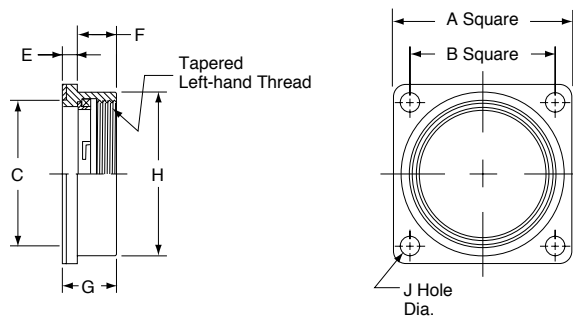

Cable Adapter Components and Accessories

Transition Adapters

Transition adapters provide for using cable adapters one shell size larger than that of the basic barrel selected. They are used when terminating shielded cables require an increase in adapter diameter for additional wiring space.

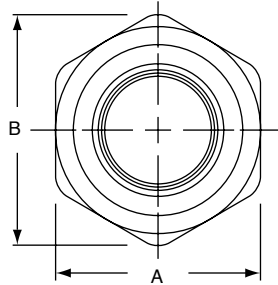
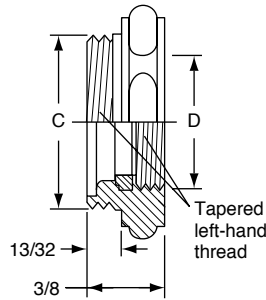
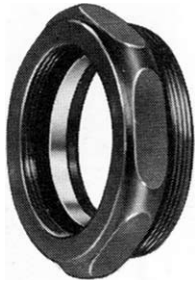

Shell Size	Adapter Shell Size	Catalog No.	DIMENSIONS			
			A	B	C	D
12	16	ZP-W-2316-40	2	2-15/64	1-19/32	1-3/32
16	20 & C20	ZP-W-2320-40	2-1/2	2-49/64	2-3/32	1-19/32
20 & C20	24 & C24	ZP-W-2324-40	3	3-9/32	2-19/32	2-3/32
24 & C24	28 & C28	ZP-W-2328-40	3-1/2	3-15/16	3-3/32	2-19/32

Gland Nut

Use plain, or with basket weave cable grip

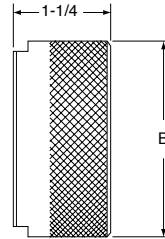
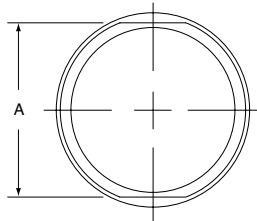

Shell Size	Catalog No.	DIMENSIONS	
		A	B
12	ZP-7312-10A	1-1/2	1-9/32
16	ZP-7316-10A	2	1-25/32
20 & C20	ZP-7320-10A	2-1/2	2-9/32
24 & C24	ZP-7324-10A	3	2-25/32
28 & C28	ZP-7328-10A	3-1/2	3-9/32

Safety Jam Nuts

To securely lock plug coupling nut or threaded dust cap. Jam nut cannot be used on barrels with hinged spring cover.

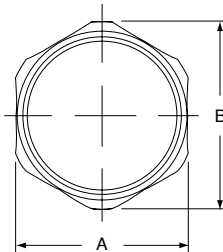
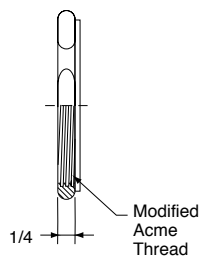

Shell Size	Catalog No.	DIMENSIONS	
		A	B
12	ZP-7212-10A	1-3/4	1-61/64
16	ZP-7216-10A	2-1/4	1-32/64
20 & C20	ZP-7220-10A	2-3/4	3-1/2
24 & C24	ZP-7224-10A	3-1/4	3-9/16

Connector Accessories - Protection Covers & Caps

Environmental Covers with Chain

Environmental covers are furnished with a six-inch length of stainless steel link chain. The chain is freely attached to a shouldered swivel post to avoid twisting when covers are applied or removed. The opposite end has a stainless steel ring for back of barrel attachment or a stainless steel eyelet for flange screw or separate screw attachment.

Example: ZP-W-5512-A (Starline)

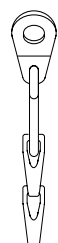

APPLICATION:

RING TYPE: For use with plugs and inline receptacles. To assemble slide ring over back end of barrel before applying cable adapter.

EYELET TYPE: For use with flange mount plugs and flange mount receptacles. To assemble attach eyelet to flange mounting screw or drill and tap hole in adjacent mounting surface.

Threaded Cap for Plugs



Shell Size	Cover Catalog No. with Ring and Chain	Cover Catalog No. with Eyelet and Chain	DIMENSIONS			
			A	D	E	F
12	ZP-W-5512-A	ZP-WF-5512-A	1-1/2	1-1/2	1-1/4	11/64
16	ZP-W-5516-A	ZP-WF-5516-A	2	1-1/2	1-3/4	13/64
20	ZP-W-5520-A	ZP-WF-5520-A	2-1/2	1-1/2	2-1/4	7/32
C20	ZP-C-5520-A	ZP-CF-5520-A	2-1/2	2	2-1/4	7/32
24	ZP-W-5524-A	ZP-WF-5524-A	3	1-1/2	2-3/4	9/32
C24	ZP-C-5524-A	ZP-CF-5524-A	3	2	2-3/4	9/32
28	ZP-W-5528-A	ZP-WF-5528-A	3-1/2	1-1/2	3-1/4	11/32
C28	ZP-C-5528-A	ZP-CF-5528-A	3-1/2	2	3-1/4	11/32

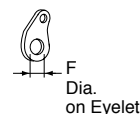
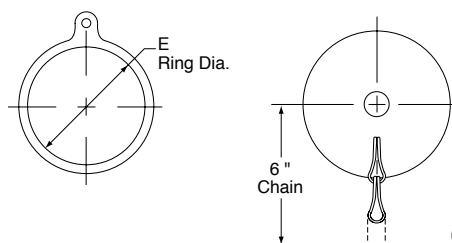
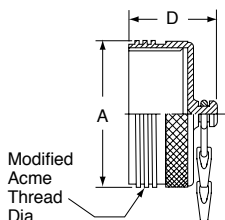

Threaded Cap for Receptacles

Cap has a captive gasket for sealing.



Shell Size	Cover Catalog No. with Ring and Chain	Cover Catalog No. with Eyelet and Chain	DIMENSIONS		
			E	F	G
12	ZP-W-5612-A	ZP-WF-5612-A	1-1/4	11/64	1-23/32
16	ZP-W-5616-A	ZP-WF-5616-A	1-3/4	13/64	2-7/32
20/C20	ZP-W-5620-A	ZP-WF-5620-A	2-1/4	7/32	2-23/32
24/C24	ZP-W-5624-A	ZP-WF-5624-A	2-3/4	9/32	3-7/32
28/C28	ZP-W-5628-A	ZP-WF-5628-A	3-1/4	11/32	3-23/32

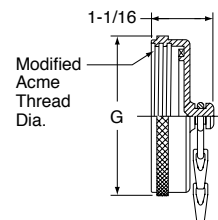

Connector Accessories - Protection Covers & Caps

Hinged Spring Door Covers-Gasketed

Covers have a stainless steel band to clamp over the coupling thread of female receptacles. The cover plate with a captive rubber gasket is pressed aluminum. A self-aligning seal is assured by the floating action of the cover on the center stainless-steel shouldered post. The hinge arm and support are machined aluminum extrusions.

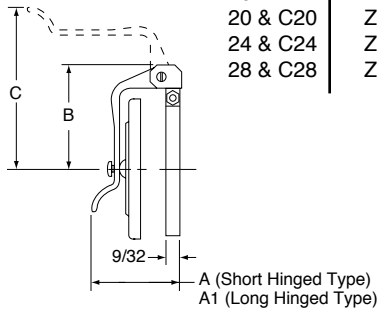
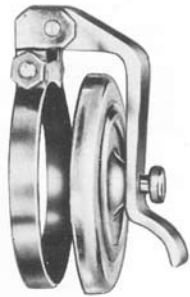

Shell Size	Short Hinged Type Catalog No.	DIMENSIONS		
		A	B	C
12	ZP-C-5712	1-19/32	1-1/2	2-1/2
16	ZP-C-5716	1-19/32	1-3/4	2-3/4
20 & C20	ZP-C-5720	1-41/64	2-9/64	3-9/16
24 & C24	ZP-C-5724	1-41/64	2-25/64	3-25/64
28 & C28	ZP-C-5728	1-41/64	2-5/8	3-5/8

APPLICATION:
SHORT HINGED TYPE:
To clear standard coupling nut - Use with Square Flange Receptacles when front or back mounted.

Shell Size	Long Hinged Type Catalog No.	DIMENSIONS		
		A1	B	C
12	ZP-C-5712-14	1-23/32	1-1/2	2-1/2
16	ZP-C-5716-14	1-23/32	1-3/4	2-3/4
20 & C20	ZP-C-5720-14	1-49/64	2-9/64	3-9/16
24 & C24	ZP-C-5724-14	1-49/64	2-25/64	3-25/64
28 & C28	ZP-C-5728-14	1-41/64	2-5/8	3-5/8

APPLICATION:
LONG HINGED TYPE:
To clear coupling jack nut - Use with Square Flange Receptacles when front mounted only.

Plastic Dust Caps

For temporary protection of assembled barrels while in storage and shipment.

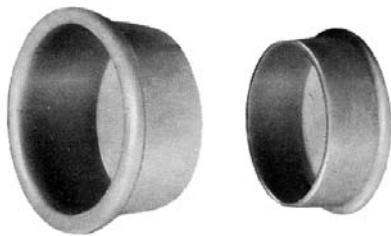

For Receptacles

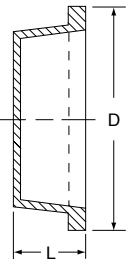

For Plugs

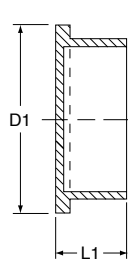

Shell Size	Receptacle Caps Catalog No.	DIMENSIONS	
		D	L
12	ZP-5612-11	1-3/4	5/8
16	ZP-5616-11	2-1/4	11/16
20 & C20	ZP-5620-11	2-22/32	21/32
24 & C24	ZP-5624-11	3-7/32	21/32
28 & C28	ZP-5628-11	3-15/16	1/2

Shell Size	Plug Caps Catalog No.	DIMENSIONS	
		D1	L1
12	ZP-5512-11	1-13/32	11/16
16	ZP-5516-11	1-29/32	11/16
20 & C20	ZP-5520-11	2-3/8	11/16
24 & C24	ZP-5524-11	2-29/32	11/16
28 & C28	ZP-5528-11	3-11/16	1/2

Conduit System Accessories

FS and FD Conduit Adapter Covers and Conduit Fitting Bodies

Adapter covers and Bodies have environmental resistance adequate for most general applications.

All adapter covers are supplied with screws and clips for mounting receptacle as well as bolts, washers and gasket for mounting cover to panel or conduit fitting body.

Cast aluminum alloy adapter covers accept type ZRLP barrels.

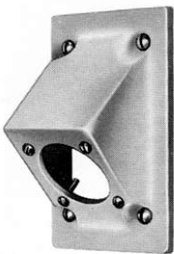
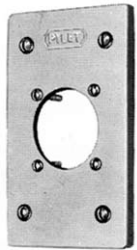

Conduit Adapter Covers - FS and FD Type

Style	Shell Size	Adapter Cover Catalog No.	DIMENSIONS (Including Barrel)				
			A	B	C	D	E
Straight	12	ZP-C-2512-11	2-7/8	4-5/16	1-1/2	3-1/4	1-7/8
	16	ZP-C-2516-11					
45 Degree	12	ZP-C-2512-13	2-7/8	4-5/16	2-5/16	3-1/4	1-7/8
	16	ZP-C-2516-13					

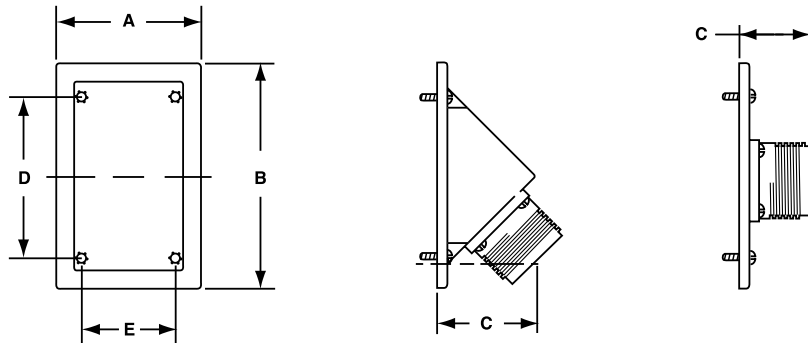

Conduit Fitting Bodies - FS and FD Type available in die cast copper-free aluminum or cadmium plated ferrous alloy

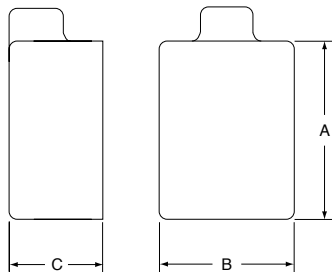

Die Cast Copper-Free Aluminum Type	Shell Size	Hub Size	Conduit Body Catalog No.	DIMENSIONS		
				A	B	C
FS	12	1/2	N-FS18	4-9/16	2-13/16	2-1/16
	12	3/4	N-FS28	4-9/16	2-13/16	2-1/16
	12	1	N-FS38	4-9/16	2-13/16	2-1/16
Cadmium Plated Ferrous Alloy Type	Shell Size	Hub Size	Conduit Body Catalog No.	DIMENSIONS		
				A	B	C
FD	16	1	N-FD38	4-9/16	2-13/16	3-1/16

Note: 1/2" and 3/4" hub deep junction boxes information available upon request.

Conduit System Accessories

Watertight Conduit Adapter Covers and Conduit Fitting Bodies

Adapter covers and Bodies have environmental resistance adequate for most general applications.

All adapter covers are supplied with screws and clips for mounting receptacle as well as bolts, washers and gasket for mounting cover to panel or conduit fitting body.

Cast aluminum alloy adapter covers accept type ZRLP barrels.

STRAIGHT COVER

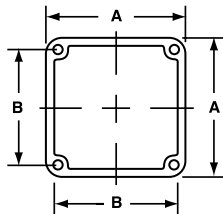
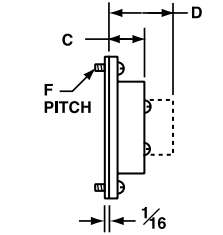
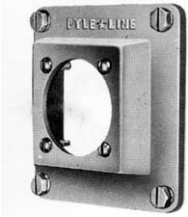

STANDARD COVER

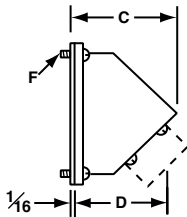

DEEP COVER

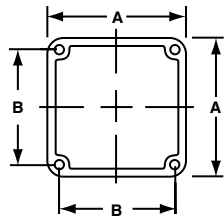

FITTING DIMENSIONS

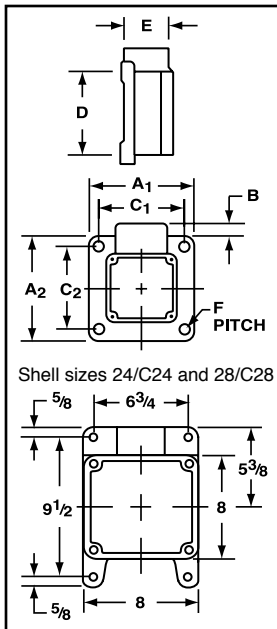

CONDUIT FITTING BODY

Mount with hub at top, bottom or either side.



Conduit Adapter Covers - Watertight Type

Style	Shell Size	Adapter Cover Catalog No.	DIMENSIONS (Including Barrel)				F Pitch UNC-2B
			A	B	C	D	
Straight	12	ZP-C-2512-10	4-3/16	3-9/16	1	1-27/32	1/4-20
	16	ZP-C-2516-10	4-3/16	3-9/16	1	1-27/32	1/4-20
	20/C20	ZP-C-2520-10	4-1/2	3-7/8	1-7/32	2-1/16	1/4-20
	24	ZP-C-2524-10	8	7	1-1/2	2-9/16	1/2-13
	C24	ZP-C-2524-10	8	7	1-1/2	2-27/32	1/2-13
	28	ZP-C-2528-10	8	7	1-1/2	2-9/32	1/2-13
	C28	ZP-C-2528-10	8	7	1-1/2	2-25/32	1/2-13

Above should not be used with pressure-type contact inserts.

Conduit Adapter Covers cont.

Shell Size	Adapter Cover Style		DIMENSIONS (Including Barrel)				F Pitch UNC-2B
	Standard Cat. No.	Deep Cat. No.	A	B	C	D	
12	ZP-C-2512-12		4-3/16	3-9/16	2-13/16	2-7/16	1/4-20
16	ZP-C-2516-12		4-3/16	3-9/16	2-15/16	2-17/32	1/4-20
16		P-202704-16	4-3/16	3-9/16	4-7/16	4-1/16	1/4-20
20	ZP-C-2520-12		4-1/2	3-7/8	3-39/64	3	1/4-20
C20			4-1/2	3-7/8	3-39/64	3-3/8	1/4-20
20/C20	ZP-C-2520-26		4-1/2	3-7/8	5	4-1/2	1/4-20
			4-1/2	3-7/8	5	4-7/8	1/4-20
24	ZP-C-2524-12		8	7	3-33/64	2-19/64	1/2-13
C24			8	7	3-33/64	2-21/32	1/2-13
24		P-202708-24	8	7	5-3/4	4-9/16	1/2-13
C24			8	7	5-3/4	5	1/2-13
28	ZP-C-2528-12		8	7	3-5/8	2-7/16	1/2-13
C28			8	7	3-5/8	2-3/4	1/2-13
28		P-202708-28	8	7	5-3/4	4-9/16	1/2-13
C28			8	7	5-3/4	5	1/2-13

Conduit Fitting Bodies - Cadmium Plated Ferrous Alloy

Shell Size	Conduit Body Hub Size	Conduit Body Cat. No.	DIMENSIONS							E	F
			A1	A2	B	C1	C2	D			
12 or 16	3/4	P-202760-42	5-1/4	5-1/4	25/64	4-5/8	4-5/8	4-3/16	2-3/8	9/32	
	1	P-202760-43	5-1/4	5-1/4	25/64	4-5/8	4-5/8	4-3/16	2-3/8	9/32	
	1-1/4	P-202760-64	5-1/4	5-1/4	25/64	4-5/8	4-5/8	4-3/16	2-3/8	9/32	
	1-1/2	P-202760-65	5-1/4	5-1/4	25/64	4-5/8	4-5/8	4-3/16	2-3/8	9/32	
20 or C20	1-1/4	JRZ-610064	6	6	9/16	5-1/4	5-1/4	4-1/2	3-3/4	9/32	
	1-1/2	JRZ-610065	6	6	9/16	5-1/4	5-1/4	4-1/2	3-3/4	9/32	
	2	JRZ-610066	6	6	9/16	5-1/4	5-1/4	4-1/2	3-3/4	9/32	
24 or C24	2-1/2	JR-720036-A	SEE BOTTOM DRAWING						3-3/4	7/16	
28 or C28	3	JRZ-820036-A	SEE BOTTOM DRAWING						4-1/2	7/16	

Contact Crimping Tools

TP-201411-AG HAND CRIMP TOOL COMPLETE KIT

This tool is complete with carrying case, checking gage, three contact locators and complete instructions for crimping #10 through #18 contacts of MOD II or MOD III design.

TP-201411-TO Hand crimp tool only (less locators)

TP-201411-16-18 Locator only for #16 and #18 pins and sockets

TP-201411-10-12 Locator only for #10 pin and sockets and #12 sockets

TP-201411-12P Locator only for all #12 pins any length

TP-201351-TC HAND CRIMP TOOL

This tool crimps #18 - #20 contacts utilizing thermocouple wire.

TP-201351-TL HAND CRIMP TOOL

This tool crimps #8 contacts only.

TP-201352-HAND/FOOT PNEUMATIC CRIMP TOOL

This tool is complete with foot control, checking gage, wrench, and complete instructions for crimping #10 through #18 contacts of MOD II or MOD III design.

Thomas & Betts TOOL NUMBER TBM15 AND DIE NUMBER 15505

To terminate 500 MCM contact.



TP-201328 CRIMP TOOL

TP-201328 PS-POWER SUPPLY

TP-201328 BC-CARRYING CASE

NOTE: Carrying case will accommodate crimp tool.

NOTE: Power supply will include 5 dies and locators.

TP-201328-F



* Foot control unit with 6 foot hose – Catalog No. TP-201328-F Normal operation 100 P.S.I.

TP-201328 Crimping Tool Only and Accessories for Contacts #12 through #4/0

Contact Size	Wire Size	Die Number	Check Gage	Color	(Locator)	
					Mod II	Mod III
12 W Length 12 C Length	12-14	TP-201328-12D	TP-201328-12G	Yellow	TP-201328-12 TP-201328-12C	TP-201328-12L
10 W Length 10 C Length	10-12	TP-201328-10D	TP-201328-10G	Black	TP-201328-10 TP-210328-10C	TP-210328-10L
8 W Length 8 C Length	8-10	TP-201328-8D	TP-201328-8G	Red	TP-201328-8 TP-201328-8C	TP-201328-8L
4 W Length 4 C Length	4-6	TP-201328-4D	TP-201328-4G	Brown	TP-201328-4 TP-201328-4C	TP-201328-4L
1/0	1/0-1 2	TP-201-328-0D TP-201328-2D	TP-201328-0G TP-201328-2G	Blue	TP-201328-0C	TP-201328-0L
4/0	4/0 - 3/0	TP-210328-41D	TP-201328-41G	Green	TP-201328-41	TP-201328-41L

Insertion and Removal Tools for MOD II & MOD III

Tools for Crimp Type Contacts

Insertion Tools

Used for inserting contacts after they are terminated to conductor. Pin and socket contacts have identical terminal ends; the same tool is used for both.



Size	Insertion Tool Catalog No.	
18	TP-201047-1	Use Same Tool for Pin or Socket
16	TP-201048-1	
12	TP-201049-1	
10	TP-201046-1	

Size	Expander Barrel Catalog No.	Tapered Lead Style	T-Bar Handle Style
8	TP-201007-A	TP-201007-B	–
4	TP-201033-A	TP-201033-B	–
0	TP-201000-EBL	TP-201000-TL	TP-201000-TH
0	TP-201000-EBS		

A separate expander barrel is required for each cavity of the contact inset.

An even number of long and short barrels should be used: Example: if the insert contains four cavities, use two long (EBL) and two short (EBS). Insert the short ones first and remove them last.

NOTE: EBS = Expander Barrel Short, EBL= Expander Barrel Long.

The T-Bar handle should be used in the insertion and extraction of the expander barrel for the 1/0 cavities –only one is required.

One tapered lead required only.

Removal Tools

Used for extracting contacts from the insert assembly after contacts have been seated. Expanders and taper leads are required for sizes 8, 4, 1/0 MOD II contacts only.

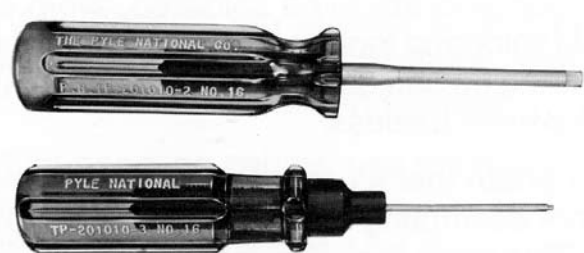

Removal Tools for MOD II

Size	Removal Tool Number for Pin	Removal Tool Number for Socket
18	TP-201459	TP-201011-3
16	TP-201459	TP-201010-3
12	TP-201459	TP-201009-3
10	TP-201459	TP-201008-3

STAR-LINE Connector Assembly and Termination Instructions

Proper assembly of multiple-contact connectors, for the most part requires common sense. The simplicity of these instructions is perhaps the reason why they are easily overlooked or taken for granted. These 27 reminders can help eliminate connector failures caused by improper assembly.

1. Read the assembly instructions carefully before actually starting to assemble connectors. Besides the matter of instruction on correct procedures, there are two important reasons for this preliminary step: To identify the various component parts, and to check for any missing parts.
2. Cut cable jackets and sheathing squarely and to correct length, using only wire strippers that have been approved for the operation. In preparing the individual wires in cables and harnesses for assembly, make allowances in length for reaching the outermost circle of contact cavities in the connector insert. This, of course, means that the conductors and the insulation should be cut progressively longer as they extend out from the center of the cable or harness to assure sufficient length for any necessary forming.
3. Follow specifications covering maximum cable stripping lengths for efficient cable grommet sealing. All wires should be cut squarely so that they will fit into contact wire wells correctly.
4. Before starting actual termination wires, it is essential that cables and harnesses be laid out in a specified order in accordance with the wiring diagram. Proper layout will reduce the need for twisting and crossover of conductors. If the wiring layout is not correct, the termination operation will be difficult or even impossible and the chances for making errors will be increased. Cable and harness assemblies having a spiral layout also must be matched carefully to the correct contacts in both the male and female inserts.
5. Some cables have a soft filler or braid on the conductors which, compresses when external pressure is applied. As a result, the cable diameter may be reduced to a point where the sealing range of the grommet is exceeded. In addition, the seal may take a permanent set and further reduce sealing efficiency. To avoid leakage at the seal under these conditions, it is suggested that, where construction of the cable permits, a metal ferrule be slipped under the cable jacket at the stressed position. This ferrule will serve as a compression supporting member and enable the gland seal to withstand high external pressures.
6. Use only correct size sealing grommets to assure resistance to moisture and other contaminants. Make certain that cable jacket is smooth where grommet is to seal. Remove any grooves or ridges if present by sanding or scarfing.
7. Use only the proper crimping tools that have been set or calibrated with precision gages.
8. When contacts are to be soldered, avoid direct contact of soldering tools to inserts. An open flame or hot soldering tip can carbonize insulating materials and make them useless.
9. Make certain that all contacts are the correct size before attempting to assemble them into insert cavities. This point is particularly important when both power and control types of contacts are used in the same connector.
10. Be sure that grounding contacts are correctly located.
11. Seat all contacts properly so that they will not be damaged or become disengaged during connector mating operations.
12. Use only the proper insertion tools and be sure that they are aligned axially when pushing contacts into their fully seated position.
13. When inserts have more cavities than conductors, plug unused cavities with either plain contacts or special seal plugs designed for the purpose. Some connectors require both a contact and seal plug in unused cavities to meet military specifications and to assure complete internal environmental sealing.
14. After all terminated contacts are inserted in their respective cavities and inspected, the cable adapter or insert clamp nut should be tightened with a wrench. This assembly operation should be done by placing the components in a vise with smooth-faced jaws and using a strap wrench.
15. If for any reason terminated conductors have to be removed from an insert because of any assembly error or change in circuitry, be sure to remove the cable clamp or insert clamp nut first before extracting the contact and reinserting it. This step is important because any attempt to remove the contacts when the resilient insulator components are compressed will result in damage.
16. When handling cables, use adequate support to prevent damage to the internal wires. Gland nuts and grommets are intended for sealing purposes and should not be used as a cable grip.
17. If one of the connector poles is a grounding wire, make sure that it is grounded properly before the connector is actually engaged.
18. When connectors having the same configuration are to be mounted close together, different or alternate keying arrangements should be used to prevent mismatching or cross-mating and possible damage to the electrical system or human injury.
19. Always inspect all aspects of connector assembly operations before putting connectors into actual operation.
20. Crimping and terminating of conductors to contacts must be done carefully. Make certain that wire strands are fully bottomed in contact wells by checking through inspection hole provided.
21. Soldering conductors to contacts must be done carefully and a non-conductive flux should be used to avoid corrosion or hygroscopic action. Do not use solder salts or acids because they may affect the dielectric properties of insulation materials.
22. Be careful not to damage wire grommets or contact retaining collets when inserting or extracting contacts.
23. Never try to straighten bent contacts. Straightening cannot be done properly and the plating on contacts will very likely be marred. This will result in a high resistance connection and will expose the base metal to possible corrosion.
24. Do not attempt to remove inserts that are bonded or locked in place in their shells.
25. Be certain that all components of connectors are assembled. Each part performs a vital function and it would not be included if it wasn't useful.
26. Each assembler of connectors should be his own inspector. Assembly workmanship is a significant factor in determining the quality of multiple-contact connectors. Quality cannot be "inspected" into connectors; it must be "built-in" during each and every assembly operation.
27. When potting connectors be sure to apply potting only in mated condition to assure that contacts will align properly.

Additional Amphenol® Industrial Connector Products



Amphe EX

The Amphe-EX™ is a new miniature explosion-proof threaded connector family from Amphenol Industrial. The Amphe-EX™ product line offers inserts that accommodate standard copper contacts, as well as coax and fiber optic contacts, to allow power and signal to pass through Hazardous rated areas. In addition, the Amphe-EX™ offers the availability of RJ45 and USB inserts. The Amphe-EX™ family provides an overall smaller package than most hazardous area connectors. The rugged AMPHE-EX™ connectors are ATEX and IECEx approved for Zone 1 (and Class 1, Div. 2) rated applications. Consult factory for certificate details. For more information, refer to Amphenol Catalog 12-056 or visit www.amphenol-industrial.com.



Amphenol Cable Glands

Amphenol Industrial Operations, the worldwide leader of explosion proof and hazardous environment interconnects, introduces a broad range of explosion proof and industrial cable glands. The cable gland products are designed to perform in the most demanding environments. Amphenol provides a complete line of EX Zone 1 and 2 rated cable glands along with general duty cable glands that are suitable for armored and unarmored cable. Brass and stainless steel types are available. IP66/68; deluge; NEMA rated products. SIRA/ATEX certified to Exd/Exe (Class I, Div. I) and CSA approved.

Reference Catalog 12-055



Cable Assemblies & Value Add Solutions

Amphenol Industrial, one of the world's premiere interconnect solutions providers, offers a complete array of cable assemblies and turnkey junction box options. From standard cable harnesses, to complete ATEX and IECEx rated junction boxes, Amphenol can provide all your value add solutions. Amphenol can provide simple cable assemblies using any of our full line of connectors. Also available are over-molded cable assemblies that provide a water tight, molded solution that requires no additional strain relief hardware.

For an overview of Amphenol Industrial Connector Products ask for Amphenol brochure SL-381. Call your local Amphenol sales office or 800-678-0141 for further information. The Industrial Overview brochure and all the product brochures listed above can be viewed, printed and downloaded from the Amphenol website: www.amphenol-industrial.com.



STAR-LINE Connectors with RADSOK® Contacts



RADSOK Contact Design:

- Socket cylinder within female contact has several equally spaced longitudinal beams twisted into a hyperbolic shape.
- As male pin is inserted, axial members in the female half deflect, imparting high current flow across the connection with minimal voltage loss.
- The hyperbolic, stamped grid configuration ensures a large, coaxial, face-to-face surface area engagement.
- Ideal for crimp termination applications requiring repeated mating cycles and high current with a low milli-volt drop.

Certain designs are available for variable frequency drive (VFD) applications. Consult Amphenol Industrial Operations for further information.



The new RADSOK contact design has been incorporated into the Star-Line connector family of connectors.

Insert arrangements with RADSOK's are shown in this catalog. For information on availability of additional inserts with RADSOK's consult Amphenol Industrial Operations.

Amphe-Power connectors with RADSOK sockets can handle up to 50% higher amperages than connectors with standard contacts. Current Amphe-Power product lines support from 50A to 500A continuous duty. RADSOK contacts are available in size 8 (69 amps), size 4 (120 amps), and size 0 (250 amps).



RADSOK Contact Advantages:

- Low contact resistance - the RADSOK contact's multiplicity of flat grid surfaces assures the greatest possible contact area on the mating pin. This results in longer life - reduced contact pressure yields reduced wear.
- Low milli-volt drop performance - due to the intimate contact provided by the spring force of the grid, the flat contact surface and the wiping action during insertion.
- Higher current capacity with minimized temperature rise. Lower overall contact resistance reduces heat build-up, thereby allowing higher current capacities at given temperature limits. Connectors with RADSOK contacts may be produced in various sizes with a variety of amperage capabilities.
- Reliability under vibration and shock. System inertia is minimized by the small package and the fact that the contact is under a spring load.
- High quality, consistency and lower cost with high speed, automated precision stamping and assembly technology

See Brochure SL-391, Amphenol Amphe-Power Connectors with RADSOK Technology for more information on other Amphenol connector types that incorporate RADSOK contacts.

Amphenol Industrial Oceanus Subsea Connectors

Amphenol Industrial Operations offers a broad range of harsh environment interconnect solutions. Our new OCEANUS Series of Connectors are tailored to meet the rugged demands of the subsea market. The OCEANUS series consists of 3 new product ranges: POSEIDON, AQUA POWER and SUBMARINER. The product family offers versatile, high performance characteristics including 9,000 PSI open face pressure ratings, underwater wet mate-able connectors, multi-pin configurations, high speed (coax and fiber optic) and over-molded cable assembly options.

POSEIDON



For more information
reference IDS-42

- 500 VDC Signal and 3kv Power contacts
- Up to 9,000 PSI open face pressure rating (6,000M)
- Configurable for use with Solid and Oil –Filled Cables
- Sealing caps, overmolding, and other options available
- Solder contacts range from 22 awg through 10 awg
- High Speed Coax (50 & 75 Ω) and Fiber Optic available
- MIL-C-24217/4-005 spec, IP68
- MIL-G-45204, Type II, Class 1 (50 microns Au)
- Intermateable/Intermountable with competitive products



AQUA POWER



For more information
reference IDS-43

- 316 stainless steel, Passivated per ATSM A967
- 500 vdc Signal and 3kv Power contacts
- Up to 9,000 PSI open face pressure rating (6,000 M)
- Configurable for use with Solid and Oil –Filled Cables
- Sealing caps, overmolding (straight or 90°)
- Custom build option available
- Optional coupling nut locking set screw available
- Operating Temperature -50°C to +60°C
- Solder contacts range from 20 awg through 2 awg
- IP68 rated



SUBMARINER



For more information
reference IDS-44

- ROVs and other Wet Mateable applications
- Numerous configurations available
- 1-16 contacts
- Molded high-insulation neoprene
- Heat-treated beryllium copper sockets, gold plating, and stainless steel bodies
- Operating Temperature -50°C to +60°C
- Up to 9,000 PSI open face pressure rating (6,000 M)



Amphenol Corporation

Amphenol Aerospace

Amphenol Industrial Operations

40-60 Delaware Avenue
Sidney, NY 13838-1395
Phone: 607-563-5011
1-800-678-0141

Fax: 607-563-5157
www.amphenol-aerospace.com
www.amphenol-industrial.com

SALES OFFICES

Amphenol Corporation

Amphenol Aerospace

Amphenol Industrial Operations

23276 South Pointe Drive, Suite 113
Laguna Hills, CA 92653
Phone: 949-855-4454
1-800-678-0141
Fax: 949-855-9115

Amphenol Corporation

Amphenol Aerospace

Amphenol Industrial Operations

2010 Corporate Ridge
McLean, VA 22101
Phone: 1-800-678-0141

For information on International Products, a North American office can be contacted:

Phone: 978-532-8800
Fax: 978-532-6800

Amphenol Industrial Operations

Amphenol Power Solutions

34190 Riviera Drive
Fraser, MI 48026
Phone: 586-294-7400
Fax: 586-294-7402
www.radsok.com

Amphenol Pcd

2 Technology Drive
Peabody, MA 01960
Phone: 978-532-8800
Fax: 978-532-6800
www.amphenolpcd.com

Amphenol Canada

20 Melford Drive
Scarborough, ON M1B 2X6
Canada
Phone: 416-291-4401
Fax: 416-292-0647
www.amphenolcanada.com

AUTHORIZED AMPHENOL DISTRIBUTORS

Corporate Headquarters

ALPHABETICAL LISTING

APD (All Product Distributors):

Arrow Electronics Englewood, CO

800-777-2776

Avnet EMG Dallas, TX

800-332-8638

PEI Genesis Philadelphia, PA

800-523-0727

Powell Electronics Philadelphia, PA

800-235-7880

TTI Inc. Fort Worth, TX

800-225-5884

Disadvantaged/Minority Distributors:

Cherokee Nation Dist. Stilwell, OK

918-696-2777

Electro Enterprises Oklahoma City, OK

800-324-6591

JRH Electronics Marlton, NJ

800-467-9309

AMPHENOL/PYLE INDUSTRIAL DISTRIBUTORS

Bartec-Technor ASA

Stavanger, Norway
Phone: 47 51 84 4100
Fax: 47 51 84 4103
www.bartec-technor.no

Crawford Electric Supply

10051 Porter Rd.
Laporte, TX 77571
Phone: 281-417-7540
Fax: 281-470-2659
www.cescoltd.com

EC Systems, Division of Nelson Dunn, Inc.

17707 Valley View Ave.
Cerritos, CA 90703
Phone: 1-800-635-3866
Fax: 714-523-9192
www.nelson-dunn.com

Gaffney-Kroese Supply

Piscataway, NJ 08854
Phone: 732-885-9000
Fax: 732-885-9555
E-mail: gksales@gaffney-kroese.com
www.gaffney-kroese.com

Geophysical Electrical Supply Co. (GESCO)

Houston, TX
Phone: 713-645-5999
Fax: 713-645-4999
E-mail: duggan@gesco-e.com
www.gesco-e.com

Hillcrest Enterprises

Ashland, VA
Phone: 800-848-3106 or 804-798-8390
Fax: 804-752-7830
E-mail: cordgrip@aol.com
www.plugs.cc

ITI Marine & Oilfield PTE, Ltd.

Joo Koon Crescent, Singapore
Phone: (65) 6266-6666
Fax: (65) 6266-0009

Jackson Power

Edmonton, Alberta Canada
Phone: 780-435-9275
Fax: 780-436-0308
E-mail: ljackson@jacksonpower.com
www.jacksonpower.com

National Oilwell Varco/L.S.I

12002 West Little York
Houston, TX 77041
Phone: 713-464-1393
Fax: 713-464-7731
www.nov.com/Supply_Chain/
Electrical_Products.aspx

PEI Genesis UK

George Curl Way
Southampton, SO182RZ
Phone: +44(0)2380621260
Phone: +44(0)8448716060
Fax: +44(0)8448716070
Email: peiuk@peigenesis.com
www.peigenesis.com

Steck Connections

Mississauga, Ontario, Canada
Phone: 905-608-2444
Fax: 905-608-2895
E-mail: steck@ican.net
www.steckconnections.com

Steiner Electric

Elk Grove Village, IL
Phone: 847-228-0400
Fax: 847-228-1352
E-mail: infor@stnr.com
www.steinerelectric.com

Wholesale Electric

Houston, TX
Phone: 800-486-8563 or 713-748-6100
Fax: 713-749-8415
E-mail: donniejr@wholesaleelectric.com
www.wholesaleelectric.com

INTERNATIONAL (Industrial Operations Offices)

Latin America

ARGENTINA

Amphenol Argentina

Avenida Callao 930, 2nd floor Office B Plaza
C1023AAP Buenos Aires, Argentina
Phone: (54 11) 48 15 68 86
Fax: (54 11) 48 14 57 79
E-mail: vendas@amphenol.com.ar

BRAZIL

Amphenol do Brasil Ltda.

Rua Diogo Moreira 132
CEP 05423-010
Sao Paulo - SP, Brazil
Phone: (55-11) 3815.1003
Fax: (55-11) 3815.1629
E-mail: vendas@amphenol.com.br

MEXICO

Amphenol Mexico

Prolongacion Reforma 61-6 B2
Col. Paseo de las Lomas
C.P. 01330 Mexico D.F., Mexico
Phone: (52-55) 5258.9984
Fax: (52-55) 5081.6890
E-mail: info@amphenolmexico.com

Europe

AUSTRIA & EASTERN EUROPE

Amphenol European Sales Oper.

P.O. Box 63, 3990 DB Houton
The Netherlands
Phone: 31 30 6358000
Fax: 31 30 6377899
E-mail: info@amphenol-nl.com

ENGLAND

Amphenol Limited

Thanet Way, Whitstable
Kent CT5 3JF, United Kingdom
Phone: (44-1-227) 773200
Fax: (44-1-227) 276571
www.amphenol.co.uk

FRANCE

Amphenol Socapex

Promenade de l'Arve, BP29
Thyez 74301 948 Cedex, France
Phone: (33-4) 50892800
Fax: (33-4) 5096-1941
www.amphenol-socapex.com

FRANCE

Amphenol-Air LB

29, Voie d'Y Vois
F-00810 Blagny, France
Phone: 33-3-2422-7849
Fax: 33-3-2422-7850
www.amphenol-airlb.fr

GERMANY

Amphenol-Tuchel Elect. GmbH

August-Haebusser Strasse 10
Postfach 1110
74001 Heilbronn, Germany
Phone: (49-7131) 929 0
Fax: (49-7131) 929 414
www.amphenol-tuchel.com

GERMANY

Amphenol-Air LB

Am Kleinbahnhof 4
D-66740 Saarlouis, Germany
Phone: (49-6831) 9810-87
Fax: (49-6831) 9810-30
www.amphenol-airlb.com

ITALY

Amphenol Italia S.p.A.

Via Barbaiana 5
20020 Lainate (Milano), Italy
Phone: 39-02-932541
Fax: 39-02-93254444
E-mail: info@amphenol-it.com

BENELUX

Amphenol European Sales Operations

Amphenol Benelux BV

P. O. Box 63, 3990 DB Houten
The Netherlands
Phone: 31-30-6358000
Fax: 31-30-6377034
E-mail: info@amphenol-nl.com

SPAIN & PORTUGAL

Amphenol Iberica

Edificio "Burgosol" - Oficina No. 55
c/Comunidad de Madrid, 35-bis,
28230 Las Rozas, Madrid, Spain

Phone: 34-91-6407303

Fax: 34-91-6407307

E-mail: infor@amphenol-it.com

SWITZERLAND

Amphenol Switzerland

P.O. Box 63, 3990 DB Houten,
The Netherlands
Phone: 31 30 6358000
Fax: 31 30 6377899
E-mail: info @amphenol-nl.com

Middle East / Africa

ISRAEL

Bar-Tec Ltd.

3 Hagavish St., P.O.B. 279
Kfir-Barcan Bldg., East Industrial Zone
Kfar Sava 44102, Israel
Phone: (972-9) 764.4100
Fax: (972-9) 7674324
E-mail: www.bar-tec.com

SOUTH AFRICA

Amphenol South Africa

30 Impapa Road
2196 Sandton - Chislehurst
South Africa
Tel: (27-11) 783-9517
Fax: (27-11) 783-9519
E-mail: amphenol_africa@csi.com

TURKEY

Amphenol Turkiye

Ayazaga Mah. Meydan Sk. No. 28
Beybi Giz Plaza, Kat. 26
34396 Maslak/Isanbul
Phone: 90(0212) 335 25 01
Fax: 90(0212) 335 25 00

Asia / Pacific

AUSTRALIA

Amphenol Australia Pty Ltd

2 Fiveways Blvd. Keysborough
Melbourne, Victoria 31733, Australia
Phone: 613 8796 8888
Fax: 613 8796 8801
E-mail: infor@amphenolaust.com.au

CHINA

Amphenol Shanghai Office

14/D, Dong Zhan Commercial Bldg.
669 Beijing Road West,
Shanghai, 200041, China
Phone: (86) 21 6267 5666
Fax: (86) 21 6272 7587

HONG KONG

Amphenol East Asia Ltd.

26/F Railway Plaza
39 Chatham Road South
Kowloon, Hong Kong
Phone: 852-9090-5325
Fax: 852-2691-1774

INDIA

Amphenol Interconnect India, Pvt. Ltd.

105 Bhosari Industrial Area
Pune, 411 026, India
Phone: (91-20) 27120 481
Fax: (91-20) 27120 581
E-mail: sales@amphenol-in.com

JAPAN

Amphenol Japan Mil Aero & Industrial

471-1, Deba, Ritto-city
Shiga 520-3041, Japan
Phone: 81-77553-8501
Fax: 81-77551-2200

KOREA

Amphenol Daeshin

#558 SoSa, SongNae
Bucheon City, Kyungki-Do
Korea 420-130
Phone: 82-32-680-3800
Fax: 82-32-673-2507

SINGAPORE

Amphenol East Asia, Ltd.

300 Beach Road
#34-06 The Concourse
Singapore 199555
Phone: 65-6294-2128
Fax: 65-6294-3522

TAIWAN

Amphenol Taiwan

No. 116, Lane 956, Zhong Shan Rd.
Taoyuan City, Taiwan, R.O.C. 330
Phone: (886-3) 379-5677
Fax: (886-3) 360-7259

Interconnects for Power Applications

For High Amperage and the Most Challenging Conditions



Star-Line®
with RADSOK®
and Backshell



Star-Line with VFD Inserts

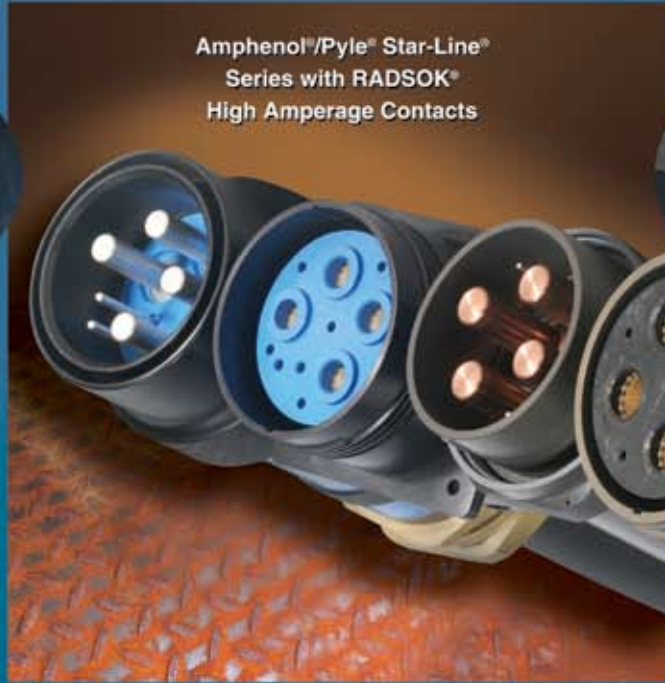

Amphenol®/Pyle® Star-Line®
Series with RADSOK®
High Amperage Contacts



Star-Line®
with RADSOK®
and Cable Gland



Star-Line® on Rapid Rig



Amphenol®
Overmolded
Cable
Assemblies



Amphenol® RADSOK®
Contact Technology



Amphenol®
Amphe-EX®
Series



Hyperbolic, Stamped Grid
Configuration



Amphenol® RIG Power Inserts
with EMI Shielding

Amphenol® RIG Power Star-Line

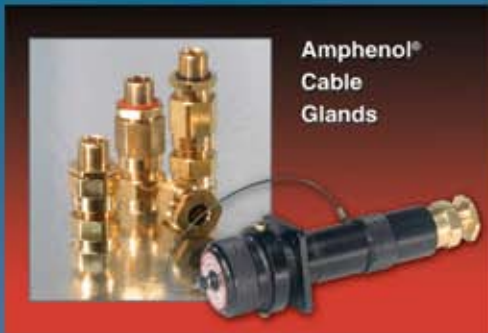

Amphenol®
Cable
Glands

Amphenol®

www.amphenol-industrial.com

AMPHENOL CORPORATION

Amphenol Industrial

Phone: 607-563-5011

40-60 Delaware Avenue

Sidney, NY 13838-1395

www.amphenol-industrial.com

Notice: Specifications are subject to change without notice. Contact your nearest Amphenol Corporation Sales Office for the latest specifications. All statements, information and data given herein are believed to be accurate and reliable but are presented without guarantee, warranty, or responsibility of any kind expressed or implied. Statements or suggestions concerning possible use of our products are made without representation or warranty that any such use is free of patent infringement and are not recommendations to infringe any patent. The user should not assume that all safety measures are indicated or that other measures may not be required. Specifications are typical and may not apply to all connectors.

Компания «Океан Электроники» предлагает заключение долгосрочных отношений при поставках импортных электронных компонентов на взаимовыгодных условиях!

Наши преимущества:

- Поставка оригинальных импортных электронных компонентов напрямую с производств Америки, Европы и Азии, а так же с крупнейших складов мира;
- Широкая линейка поставок активных и пассивных импортных электронных компонентов (более 30 млн. наименований);
- Поставка сложных, дефицитных, либо снятых с производства позиций;
- Оперативные сроки поставки под заказ (от 5 рабочих дней);
- Экспресс доставка в любую точку России;
- Помощь Конструкторского Отдела и консультации квалифицированных инженеров;
- Техническая поддержка проекта, помощь в подборе аналогов, поставка прототипов;
- Поставка электронных компонентов под контролем ВП;
- Система менеджмента качества сертифицирована по Международному стандарту ISO 9001;
- При необходимости вся продукция военного и аэрокосмического назначения проходит испытания и сертификацию в лаборатории (по согласованию с заказчиком);
- Поставка специализированных компонентов военного и аэрокосмического уровня качества (Xilinx, Altera, Analog Devices, Intersil, Interpoint, Microsemi, Actel, Aeroflex, Peregrine, VPT, Syfer, Eurofarad, Texas Instruments, MS Kennedy, Miteq, Cobham, E2V, MA-COM, Hittite, Mini-Circuits, General Dynamics и др.);

Компания «Океан Электроники» является официальным дистрибьютором и эксклюзивным представителем в России одного из крупнейших производителей разъемов военного и аэрокосмического назначения «JONHON», а так же официальным дистрибьютором и эксклюзивным представителем в России производителя высокотехнологичных и надежных решений для передачи СВЧ сигналов «FORSTAR».



JONHON

«JONHON» (основан в 1970 г.)

Разъемы специального, военного и аэрокосмического назначения:

(Применяются в военной, авиационной, аэрокосмической, морской, железнодорожной, горно- и нефтедобывающей отраслях промышленности)

«FORSTAR» (основан в 1998 г.)

ВЧ соединители, коаксиальные кабели, кабельные сборки и микроволновые компоненты:

(Применяются в телекоммуникациях гражданского и специального назначения, в средствах связи, РЛС, а так же военной, авиационной и аэрокосмической отраслях промышленности).



Телефон: 8 (812) 309-75-97 (многоканальный)

Факс: 8 (812) 320-03-32

Электронная почта: ocean@oceanchips.ru

Web: <http://oceanchips.ru/>

Адрес: 198099, г. Санкт-Петербург, ул. Калинина, д. 2, корп. 4, лит. А