1000 mA Buck-Boost DC/DC Converter with Synchronous Rectifier

NO. EA-333-180618

OUTLINE

The RP601x is a CMOS-based 1000 mA buck-boost DC/DC converter with synchronous rectifier. Internally, the RP601x consists of an oscillator circuit, a reference voltage unit, an error amplifier circuit, a switch control circuit, a mode control circuit, a soft-start circuit, an undervoltage lockout (UVLO) circuit, an overcurrent protection circuit, a thermal shutdown circuit and switching transistors.

The RP601x provides the forced PWM control or the PWM/ VFM auto switching control. The forced PWM control switches at fixed frequency rate in low output current in order to reduce noise. Likewise, the PWM/ VFM auto switching control automatically switches from PWM mode to VFM mode in low output current in order to achieve high efficiency. RICOH's unique control method can suppress a ripple voltage in the VFM mode, thus the RP601x can achieve both low ripple voltage at light load and high efficiency.

The RP601x can be switched into forced bypass mode in PWM/ VFM auto switching control by pulling the BP pin high. The RP601x features forced bypass mode with a typical 5 μ A current consumption that can maximize the battery life.

The RP601x is offered in a 16-bump WLCSP package measuring 1.95 mm x 1.95 mm which can achieve the smallest possible footprint solution on board where area is limited.

FEATURES

- Input Voltage Range (Maximum Rating)..... 2.3 V to 5.5 V (6.5 V)
- Output Voltage Range..... 2.75 V to 4.2 V
- Output Step Voltage..... Typ. 50 mV
- Output Voltage Setting..... Single-wire (S-Wire) interface⁽¹⁾
- Output Voltage Accuracy..... PWM mode = $\pm 2\%$, VFM mode = PWM mode + 2%
- Output Voltage Temperature Coefficient..... Typ. ± 50 ppm/ $^{\circ}\text{C}$
- Line Regulation..... Typ. 0.5% (PWM mode)
- Load Regulation..... Typ. 0.5% at $I_{\text{OUT}} = 10$ mA to 800 mA (PWM mode)
- Maximum Output Current..... Typ. 1.0 A
- Output Pulsed Current..... Max. 2.0 A
($t = 10$ ms, On Duty = 0.1 ($t_{\text{on}} = 1$ ms), $V_{\text{IN}} = 3.6$ V, $V_{\text{SET}} = 3.3$ V)
- BULX Current Limit..... Typ. 4.0 A
- Oscillator Frequency..... Typ. 2.4 MHz
- Built-in Driver ON Resistance..... Typ. Pch. 80 m Ω , Nch. 80 m Ω ($V_{\text{IN}} = 3.6$ V)
- Device Quiescent Current..... Typ. 45 μA (VFM mode)
- Standby Current..... Max. 5 μA
- Quiescent Current in Forced Bypass Mode..... Typ. 5 μA
- UVLO Detector Threshold..... Typ. 2.1 V
- Soft-start Function
- Power Good Function
- Thermal Shutdown
- Package..... WLCSP-16-P1, 1.95 mm x 1.95 mm

APPLICATIONS

- Power source for portable equipment such as laptops, PDAs, DSCs, cellular phones and smartphones
- Power source for Li-ion battery-used equipment

⁽¹⁾The default set output voltage (Default V_{SET}) is set by Fix Trimming (selectable from 2.75 V to 4.20 V in 0.05 V step)

SELECTION GUIDE

Selection Guide

Product Name	Package	Quantity per Reel	Pb Free	Halogen Free
RP601Zxxx*-E2-F	WLCSP-16-P1	5,000 pcs	Yes	Yes

xxx: Specify the default set output voltage (Default V_{SET}) from 2.75 V (275) to 4.20 V (420) in 0.05 V step.

*: Specify the auto-discharge function ⁽¹⁾ option.

A: Auto-discharge function included

B: Auto-discharge function not included

BLOCK DIAGRAM

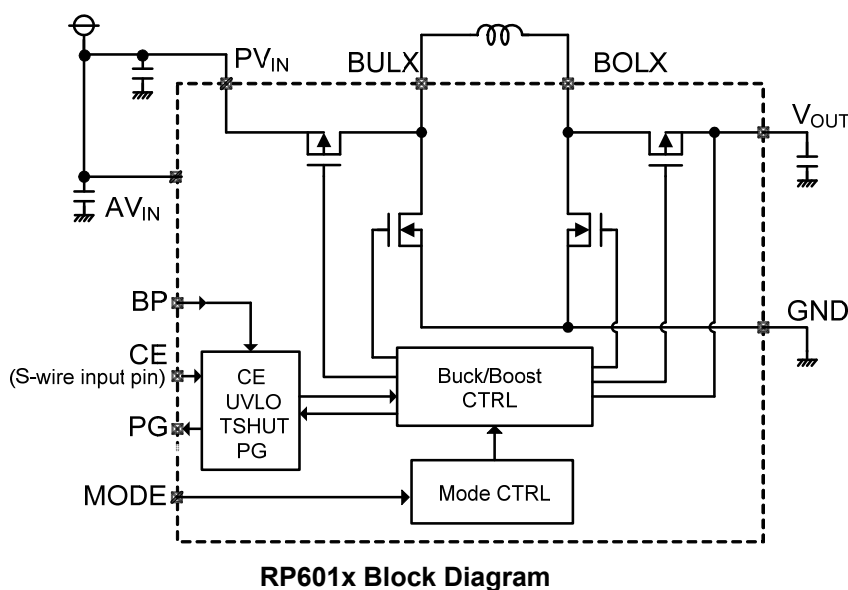

⁽¹⁾Auto-discharge function quickly lowers the output voltage to 0 V by releasing the electrical charge accumulated in the external capacitor when the chip enable signal is switched from the active mode to the standby mode.

RP601x

NO. EA-333-180618

PIN DESCRIPTION

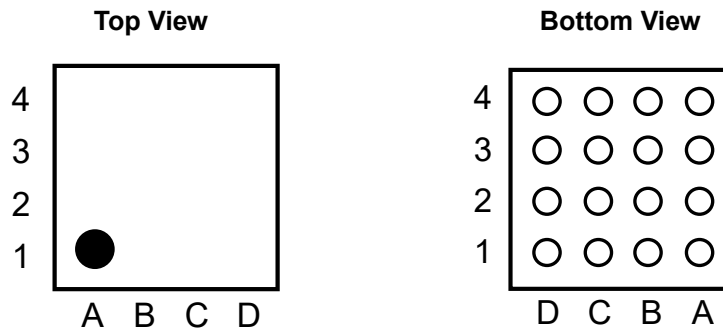

RP601x (WLCSP-16-P1) Pin Configuration

RP601x Pin Description

Pin No	Symbol	Pin Description
C3, C4	BOLX	Boost Switching Output LX
B3, B4	BULX	Buck Switching Output LX
D1	PG	Power Good Output Pin, Nch Open Drain
C1	CE	Chip Enable and S-Wire Control Input Pin
B1	BP	Forced Bypass Mode Setting Input Pin Forced Bypass Mode: "H"
A1	MODE	Mode Control Pin Forced PWM Control: "H" PWM/VFM Auto Switching Control: "L"
D3, D4	V _{OUT}	Buck-Boost Output Pin
A3	AV _{IN}	Analog Power Input Pin
A4	PV _{IN}	Power Input Pin
A2, B2, C2, D2	GND	Power GND Pin

Same symbol pins must be connected together (BOLX (C3 and C4), BULX (B3 and B4), and V_{OUT} (D3 and D4)). The AV_{IN} (A3) and PV_{IN} (A4) pins must be connected together in the application. GND must be tied to the ground in the application (A2, B2, C2, and D2).

Pin Truth Table

CE Pin	MODE Pin*1	BP Pin	Operation
"L"	-	-	OFF
"H"	"L"	"L"	PWM/ VFM Auto Switching Control Mode
		"H"	Forced Bypass Mode
	"H"	"L"	Forced PWM Control Mode
		"H"*2	Forced Bypass Mode

*1 The logic to the MODE pin should not be changed while CE = "H".

*2 The logic to the BP pin should not be changed while MODE = "H" and CE = "H".

ABSOLUTE MAXIMUM RATINGS

Absolute Maximum Ratings

Symbol	Item	Rating	Unit
V _{IN}	AV _{IN} / PV _{IN} Input Voltage	-0.3 to 6.5	V
V _{LX}	L _X Pin (BULX, BOLX) Voltage	-0.3 to V _{IN} + 0.3	V
V _{CE}	CE Pin Input Voltage	-0.3 to 6.5	V
V _{MODE}	MODE Pin Input Voltage	-0.3 to 6.5	V
V _{BP}	BP Pin Input Voltage	-0.3 to 6.5	V
V _{OUT}	V _{OUT} Pin Voltage	-0.3 to 6.5	V
P _D	Power Dissipation ⁽¹⁾ (WLCSP-16-P1, JEDEC STD. 51-9 Test Land Pattern)	1400	mW
T _j	Junction Temperature Range	-40 to 125	°C
T _{stg}	Storage Temperature Range	-55 to 125	°C

ABSOLUTE MAXIMUM RATINGS

Electronic and mechanical stress momentarily exceeded absolute maximum ratings may cause the permanent damages and may degrade the life time and safety for both device and system using the device in the field. The functional operation at or over these absolute maximum ratings are not assured.

RECOMMENDED OPERATING CONDITIONS

Recommended Operating Conditions

Symbol	Item	Rating	Unit
V _{IN}	Input Voltage	2.3 to 5.5	V
T _a	Operating Temperature	-40 to 85	°C

RECOMMENDED OPERATING CONDITIONS

All of electronic equipment should be designed that the mounted semiconductor devices operate within the recommended operating conditions. The semiconductor devices cannot operate normally over the recommended operating conditions, even if when they are used over such conditions by momentary electronic noise or surge. And the semiconductor devices may receive serious damage when they continue to operate over the recommended operating conditions.

⁽¹⁾ Refer to *POWEWR DISSIPATION* for detailed information.

RP601x

NO. EA-333-180618

ELECTRICAL CHARACTERISTICS**RP601x Electrical Characteristics**

(Ta = 25°C)

Symbol	Item	Conditions	Min.	Typ.	Max.	Unit	
I _{DD}	Quiescent Current	V _{IN} V _{IN} = 5.5 V, V _{SET} = 3.3 V, I _{OUT} = 0 mA	V _{MODE} = 0 V		35	60	μA
			V _{MODE} = 5.5 V		800		μA
		V _{OUT}			10		μA
I _{DD-BP}	Quiescent Current in Forced Bypass Mode	V _{IN} = 3.6 V, I _{OUT} = 0 mA		5.0		μA	
I _{standby}	Standby Current	V _{IN} = 5.5 V, V _{CE} = 0 V		0.1	5.0	μA	
V _{OUT}	Range of Output Voltage	Adjustable in 0.05 V step	2.75		4.2	V	
	Output Voltage Accuracy	PWM mode V _{IN} = 4.2 V	-2		2	%	
		VFM mode (Refer to <i>OUTPUT VOLTAGE ACCURACY (PWM MODE/VFM MODE)</i>)		PWM mode + 2.0		%	
ΔV _{OUT} /ΔTa	Feedback Output Voltage Temperature Coefficient	-40°C ≤ Ta ≤ 85°C		±50		ppm/°C	
ΔV _{OUT} /ΔV _{IN}	Line Regulation	V _{SET} = 3.3 V, 3.2 V ≤ V _{IN} ≤ 4.35 V, I _{OUT} = 300 mA, MODE = "H"		0.5		%	
ΔV _{OUT} /ΔI _{OUT}	Load Regulation	V _{IN} = 3.6 V, V _{SET} = 3.3 V, 10 mA ≤ I _{OUT} ≤ 800 mA MODE = "H"		0.5		%	
f _{osc}	Switching Frequency	V _{IN} = 4.2 V	2.16	2.4	2.64	MHz	
I _{LIMHS}	BULX Current Limit ⁽¹⁾	V _{IN} = 3.6 V		4.0		A	
I _{LIMSH}	Short Protection Current ⁽¹⁾	V _{IN} = 3.6 V, V _{OUT} = 0 V		1.2		A	
V _{SHORT}	Short Protection Detector Voltage	V _{OUT} = falling		1.6		V	
R _{ONP}	On Resistance of Pch Tr.	V _{IN} = 3.6 V, I _{Lx} = -100 mA		80		mΩ	
R _{ONN}	On Resistance of Nch Tr.	V _{IN} = 3.6 V, I _{Lx} = -100 mA		80		mΩ	
R _{DIS}	On Resistance of Discharge Tr. (RP601xxxxA.)	V _{IN} = 3.6 V, V _{CE} = 0 V		8.0		Ω	

⁽¹⁾ BULX Current Limit and Short Protection Current vary according to the switching duty ratio.

ELECTRICAL CHARACTERISTICS (continued)**RP601x Electrical Characteristics**

(Ta = 25°C)

Symbol	Item	Conditions	Min.	Typ.	Max.	Unit
IPGLK	PG Pin Leakage Current	V _{IN} = V _{CE} = 5.5 V, V _{PG} = 5.5 V	-1	0	1	μA
V _{CEH}	CE Input "H" Voltage	V _{IN} = 5.5 V	1.0			V
V _{CEL}	CE Input "L" Voltage	V _{IN} = 2.3 V			0.4	V
V _{MODEH}	MODE "H" Input Voltage	V _{IN} = 5.5 V	1.0			V
V _{MODEL}	MODE "L" Input Voltage	V _{IN} = 2.3 V			0.4	V
V _{BPH}	BP Input "H" Voltage	V _{IN} = 5.5 V	1.0			V
V _{BPL}	BP Input "L" Voltage	V _{IN} = 2.3 V			0.4	V
I _H	CE, MODE & BP Input "H" Current	V _{IN} = V _{CE} = V _{BP} = V _{MODE} = 5.5 V	-1	0	1	μA
I _L	CE, MODE & BP Input "L" Current	V _{CE} = V _{BP} = V _{MODE} = 0 V V _{IN} = 5.5 V	-1	0	1	μA
Maxduty	Maximum Duty Cycle at Boost-Mode			85		%
V _{UVLOD}	UVLO Detector Threshold	V _{IN} = falling	2.0	2.1		V
V _{UVLOR}	UVLO Released Threshold	V _{IN} = rising		V _{UVLOD} + 0.1	2.3	V
T _{TSD}	Thermal Shutdown Temperature	Junction Temperature		140		°C
T _{TSR}	Thermal Shutdown Released Temperature	Junction Temperature		100		°C
t _{start}	Soft-start Time ⁽¹⁾	V _{SET} = 3.3 V		350		μs
V _{PG}	PG Output "L" Voltage	I _{PG} = + 1 mA			0.4	V

All test items listed under ELECTRICAL CHARACTERISTICS are done under the pulse load condition (T_j ≈ Ta = 25°C) except Feedback Output Voltage Temperature Coefficient.

Test circuit is "OPEN LOOP" and GND = 0 V unless otherwise specified.

⁽¹⁾The inclination of the output voltage (V_{OUT}) during soft-start time is constant and not depending on the default set output voltage (Default V_{SET}) but the soft-start time can be changed depending on Default V_{SET}. Default V_{SET} is set by Fix Trimming (2.75 V to 4.20 V, in 0.05 V step).

RP601Z Product-specific Electrical Characteristics**(Ta = 25°C)**

Product name	V _{OUT} (PWM mode) (V)		
	MIN.	TYP.	MAX.
RP601Z275x	2.695	2.750	2.805
RP601Z280x	2.744	2.800	2.856
RP601Z285x	2.793	2.850	2.907
RP601Z290x	2.842	2.900	2.958
RP601Z295x	2.891	2.950	3.009
RP601Z300x	2.940	3.000	3.060
RP601Z305x	2.989	3.050	3.111
RP601Z310x	3.038	3.100	3.162
RP601Z315x	3.087	3.150	3.213
RP601Z320x	3.136	3.200	3.264
RP601Z325x	3.185	3.250	3.315
RP601Z330x	3.234	3.300	3.366
RP601Z335x	3.283	3.350	3.417
RP601Z340x	3.332	3.400	3.468
RP601Z345x	3.381	3.450	3.519
RP601Z350x	3.430	3.500	3.570
RP601Z355x	3.479	3.550	3.621
RP601Z360x	3.528	3.600	3.672
RP601Z365x	3.577	3.650	3.723
RP601Z370x	3.626	3.700	3.774
RP601Z375x	3.675	3.750	3.825
RP601Z380x	3.724	3.800	3.876
RP601Z385x	3.773	3.850	3.927
RP601Z390x	3.822	3.900	3.978
RP601Z395x	3.871	3.950	4.029
RP601Z400x	3.920	4.000	4.080
RP601Z405x	3.969	4.050	4.131
RP601Z410x	4.018	4.100	4.182
RP601Z415x	4.067	4.150	4.233
RP601Z420x	4.116	4.200	4.284

THEORY OF OPERATION

SOFT-START AND SET OUTPUT VOLTAGE (V_{SET}) ADJUSTMENT

The default set output voltage (Default V_{SET}) is set in the range of 2.75 V to 4.20 V in 0.05 V step by Fix Trimming. The inclination of soft-start time is constant and not depending on Default V_{SET} but the soft-start time can be changed depending on Default V_{SET} .

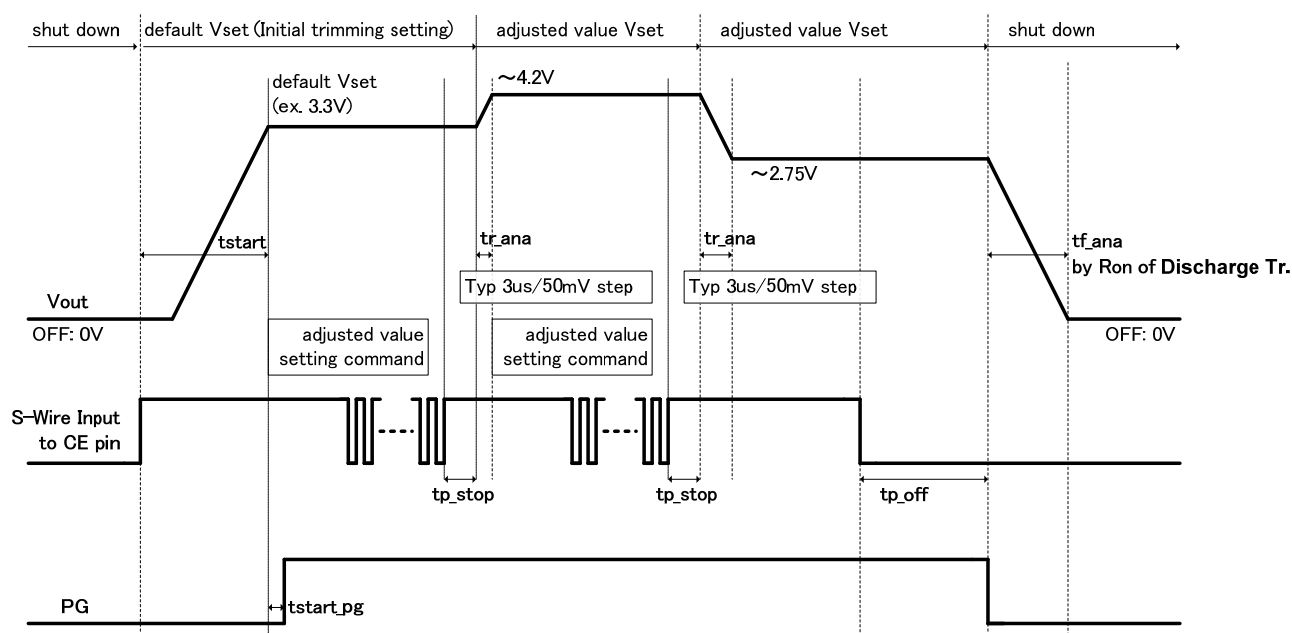

RP601x Timing Chart

UNDERVOLTAGE LOCKOUT (UVLO) CIRCUIT

If the input voltage (V_{IN}) becomes lower than the UVLO detector threshold (V_{UVLOD}), the UVLO circuit starts to operate, and P-channel and N-channel built-in switch transistors turn off. To restart the operation, V_{IN} needs to be higher than the UVLO released voltage (V_{UVLOR}).

OVERCURRENT PROTECTION CIRCUIT

Overcurrent protection circuit supervises the inductor peak current (the peak current flowing through P-channel built-transistor) in each switching cycle, and if the peak current exceeds the BULX current limit (I_{LIMHS}), it turns off P-channel transistor. I_{LXLIM} of the RP601x is set to Typ.4 A.

SHORT PROTECTION CIRCUIT

If the output voltage (V_{OUT}) becomes lower than a short-circuit protection detection voltage (V_{SHORT}), the BULX current limit (I_{LIMHS}) will be reduced to the short-circuit protection current (I_{LIMSH}) of typically 1.2A.

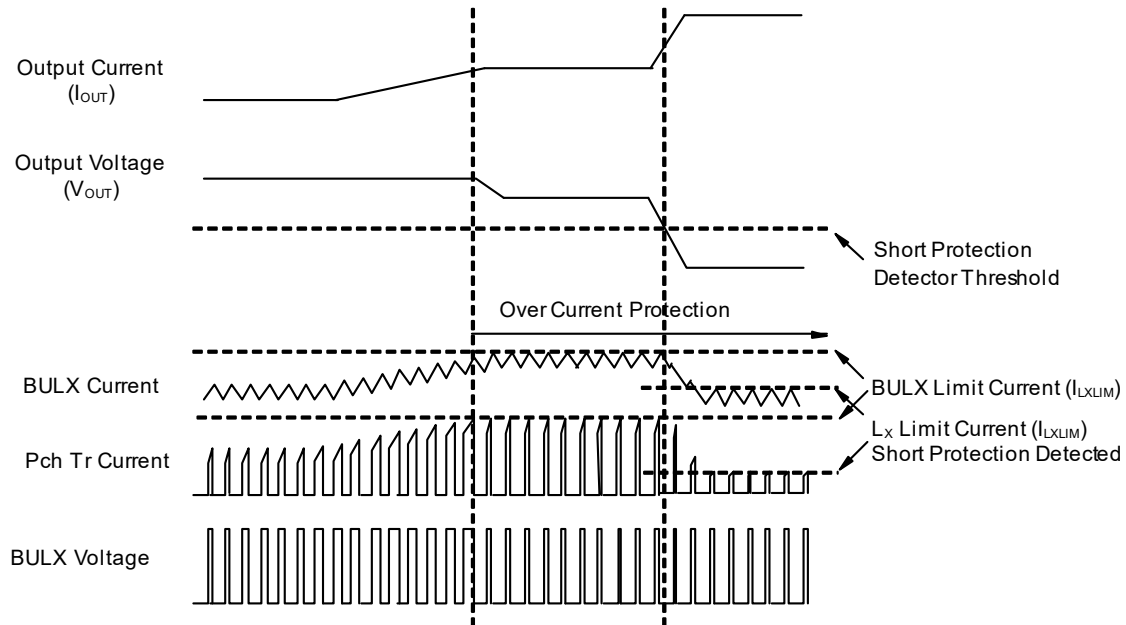

Overcurrent Protection & Short Protection

POWER GOOD (PG) FUNCTION

The RP601x contains a power good function using Nch open drain. If any abnormal condition is detected, the power good function turns Nch transistor on and switches the PG pin to low. If the cause of the abnormal condition is removed, the power good function turns Nch transistor off and switches the PG pin back to high. The followings are the abnormal conditions that the power good function can detect.

- CE = "L" (Shutdown)
- UVLO (Shutdown)
- Thermal Shutdown
- Short Protection Detection

Notes: The PG pin outputs "L" during soft-start.

SINGLE WIRE (S-WIRE) PULSE SIGNAL FIGURE

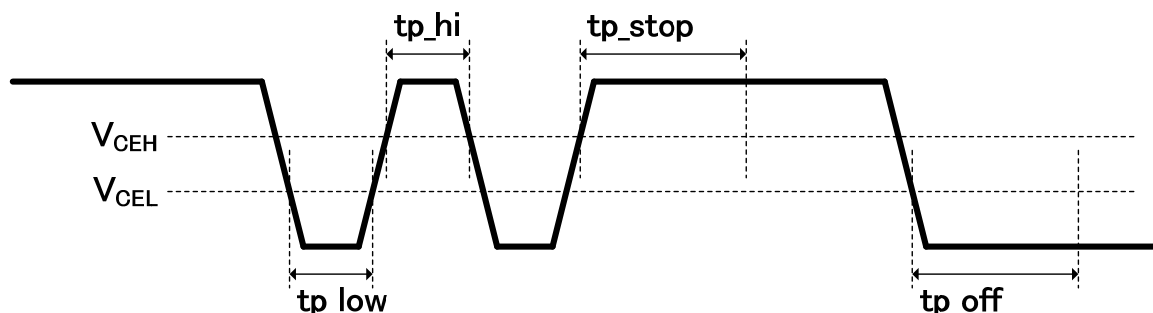

Single Wire (S-Wire) Pulse Signal Figure

Symbol	Item	Conditions	Min.	Typ.	Max.	Unit
tp_hi	S-Wire High Time		4	-	50	μs
tp_low	S-Wire Low Time		4	-	50	μs
tp_stop	S-Wire Setting Stop Time		120			μs
tp_off	S-Wire Setting Off Time		120			μs
tstart_pg	PG Output Delay Time	Starts from the completion point of tstart		32		μs
tr_ana	V _{OUT} Change Time	Starts from the completion of of tp_stop 1 step-up/ down (1 step = 50 mV)		3		μs

S-Wire pulse signal input is prohibited during the following two conditions:

1. During soft-start time (tstart)
2. During V_{OUT} change time (tr_ana) + S-Wire setting stop time (tp_stop)

The required transition time for each condition are listed below:

1. tstart = max. 500 μs (@4.2 V)
2. tr_ana + tp_stop + Stable time for Circuit = 470 μs (@2.75 V ↔ 4.2 V)

OUTPUT VOLTAGE ACCURACY (PWM MODE/ VFM MODE)

The output voltage (V_{OUT}) in the VFM mode is typically 2% higher than V_{OUT} in the PWM mode.

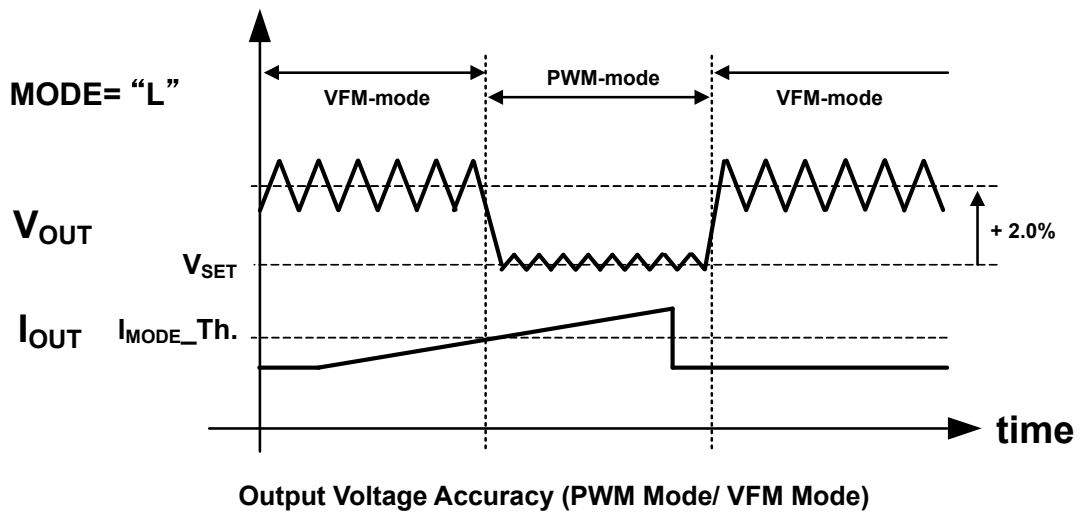

FORCED BYPASS MODE (PWM/ VFM Auto Switching Control)

In the forced bypass mode, the switching operation is stopped which makes the output voltage (V_{OUT}) same level as the input voltage (V_{IN}) and suppresses the supply current to typically $5 \mu A$.

In the PWM/ VFM auto switching control, the device can be switched into the forced bypass mode by setting the BP pin "H".

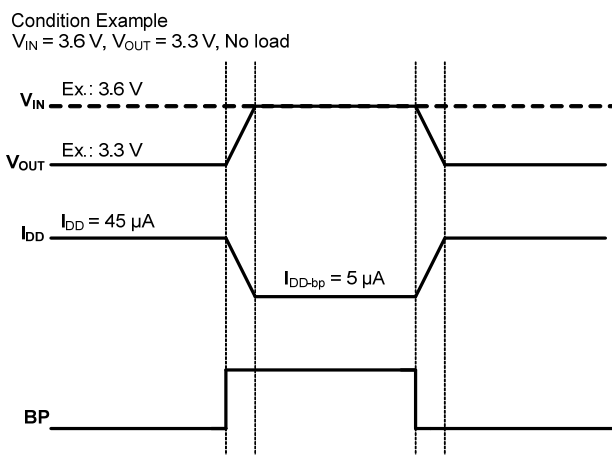

Forced Bypass Mode (PWM/ VFM Auto Switching Control)

- Even if the device is started up with BP = "H", the switching operation will be performed during soft-start.
- After soft-start with PG = "L" to "H", the device is automatically switched into the forced bypass mode.

RP601x

NO. EA-333-180618

SET OUTPUT VOLTAGE (V_{SET}) SETTING TABLE

The set output voltage (V_{SET}) is adjustable by sending a S-Wire input pulse signal from outside as shown in the table below.

Table 1. V_{SET} Setting Table (31 Steps)

Pulse Count	V_{SET} [V]				
0 (Default)	The default set output voltage (Default V_{SET}) set by Fix Trimming Setting, 2.75 V to 4.20 V in 0.05 V step				
1	Return to Default V_{SET}				
Pulse Count	V_{SET} [V]	Pulse Count	V_{SET} [V]	Pulse Count	V_{SET} [V]
2	2.75	12	3.25	22	3.75
3	2.8	13	3.3	23	3.8
4	2.85	14	3.35	24	3.85
5	2.9	15	3.4	25	3.9
6	2.95	16	3.45	26	3.95
7	3.0	17	3.5	27	4.0
8	3.05	18	3.55	28	4.05
9	3.1	19	3.6	29	4.1
10	3.15	20	3.65	30	4.15
11	3.2	21	3.7	31	4.2

If a S-Wire input pulse signal ≥ 32 pulse count, V_{SET} will be set to 4.2 V.
After the time lapse of S-Wire setting stop time (tp_{stop}), V_{SET} will be changed.

APPLICATION INFORMATION

TYPICAL APPLICATION CIRCUIT

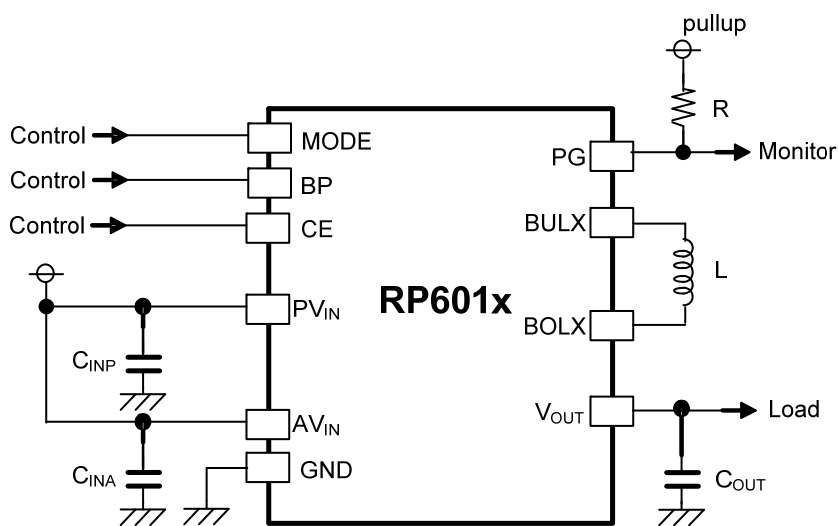

RP601x Typical Application

Recommended Capacitors

Symbol	Description
C_{INP}^{*1}	22 μ F x 1, Ceramic Capacitor, JMK107BJ226MA (TAIYO YUDEN)
C_{INA}	-
C_{OUT}^{*2}	22 μ F x 2, Ceramic Capacitor, JMK107BJ226MA (TAIYO YUDEN)

*1 Place C_{INP} as close as possible to PV_{IN} .

*2 Place C_{OUT} as close as possible to V_{OUT} .

Recommended Inductors

Symbol	Recommended Inductors
L	1.0 μ H, DFE201610C-1R0M (TOKO)
	1.0 μ H, TFM201610GHM-1R0MTAA (TDK)
	2.2 μ H, DFE252012P-2R2M (TOKO)

TECHNICAL NOTES

The performance of a power source circuit using this device is highly dependent on a peripheral circuit. A peripheral component or the device mounted on PCB should not exceed a rated voltage, a rated current or a rated power. When designing a peripheral circuit, please be fully aware of the following points.

- Place the bypass capacitor (C_{INP}) between the V_{INP} pin and the GND pin with shortest-distance wiring.
- Place the output capacitor (C_{OUT}) between the V_{OUT} pin and the GND pin with shortest-distance wiring. Use a ceramic capacitor for C_{OUT} having a low equivalent series resistance (ESR). Connect GND of C_{OUT} to the GND pin with shortest-distance wiring.
- Make the GND plane wide.
- Ensure the V_{INP} and GND lines are firmly connected. A large switching current flows through the V_{INP} , GND, inductor, BOLX, BULX and V_{OUT} lines. If their impedance is too high, noise pickup or unstable operation may result.
- When the built-in switches are turned off, the inductor may generate a spike-shaped high voltage. Use the high-breakdown voltage capacitor (C_{OUT}) which output voltage is 1.5 times or more than the set output voltage.
- Connect the BOLX pin and the inductor and the BULX pin with shortest-distance wiring.
- Use an inductor that has a low DC resistance, has an enough tolerable current and is less likely to cause magnetic saturation.

TYPICAL CHARACTERISTICS

Note: Typical Characteristics are intended to be used as reference data; they are not guaranteed.

1) Input Voltage vs. Output Voltage

RP601Z330x, MODE = L

L = DFE201610C (2016 size_1.0 μ H)

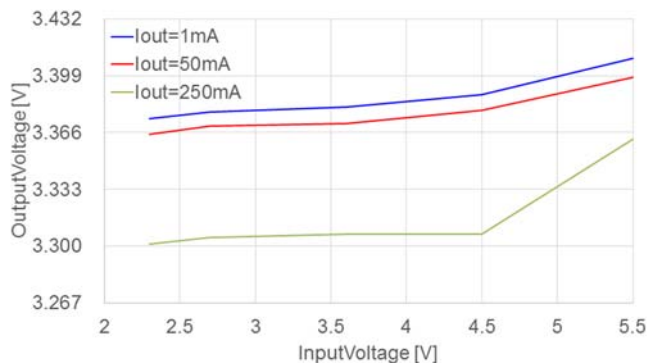

RP601Z330x, MODE = H

L = DFE201610C (2016 size_1.0 μ H)

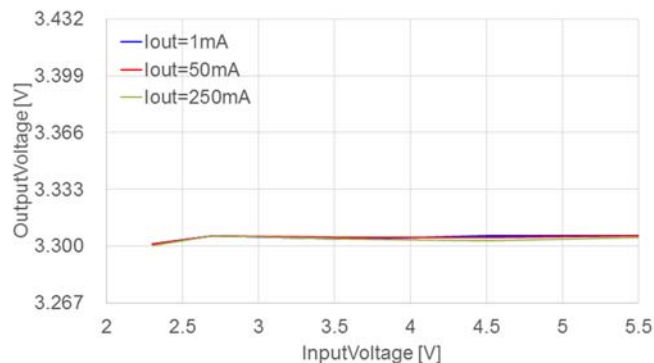

2-1) Output Current vs. Efficiency (for Different Input Voltages)

RP601Z330x, MODE = L

L = DFE201610C (2016 size_1.0 μ H)

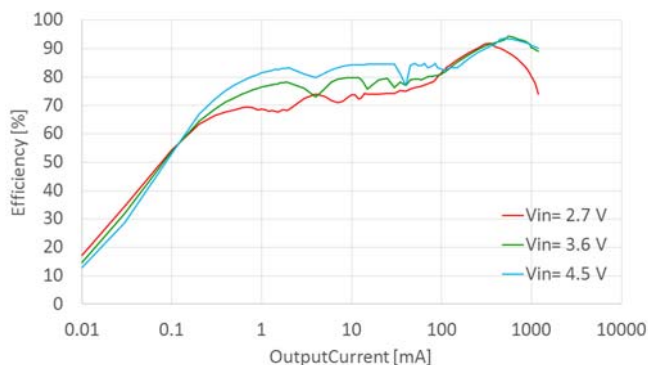

RP601Z330x, MODE = H

L = DFE201610C (2016 size_1.0 μ H)

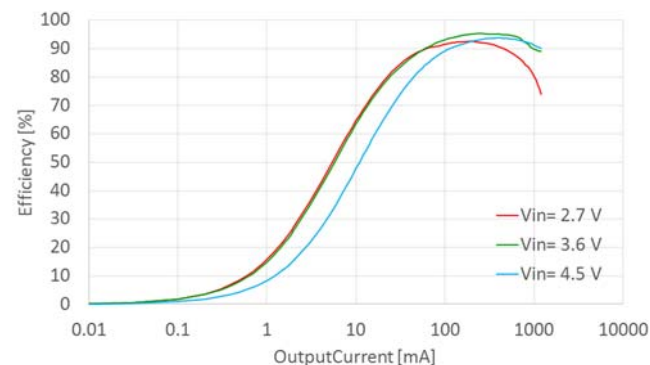

2-2) Output Current vs. Efficiency (for Different Inductors)

RP601Z330x, VIN = 3.6 V, MODE = L, L = 1.0 μ H

DFE201610C-1R0M (TOKO),
TFM201610GHM-1R0MTAA (TDK),
DFE201612E-1R0M (TOKO),
VLS201610HBX-1R0M (TDK)

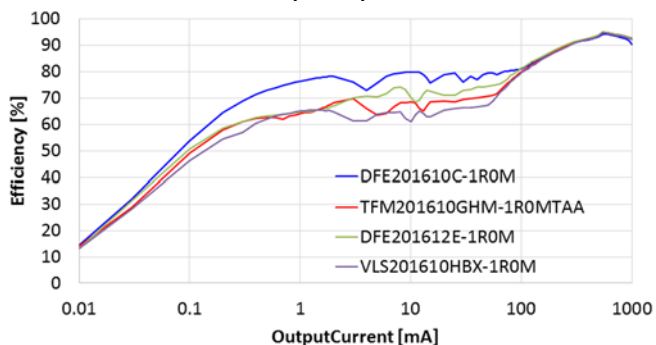

RP601Z330x, VIN = 3.6 V, MODE = L, L = 2.2 μ H

DFE252012P-2R2M (TOKO)

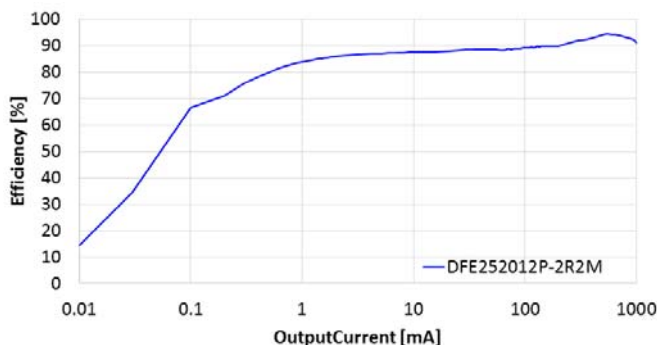

RP601x

NO. EA-333-180618

3) Output Current vs. Output Voltage RP601Z330x, MODE = L L = DFE201610C (2016 size_1.0 μ H)

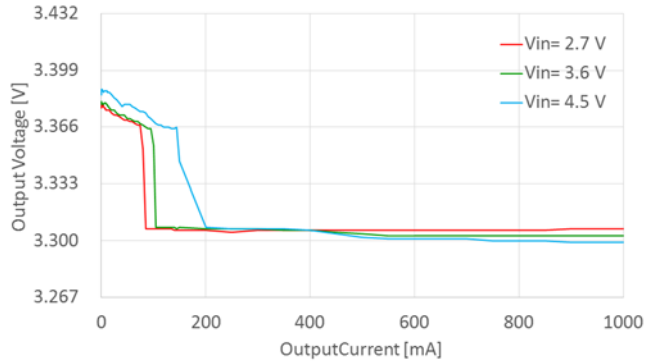

RP601Z330x, MODE = H L = DFE201610C (2016 size_1.0 μ H)

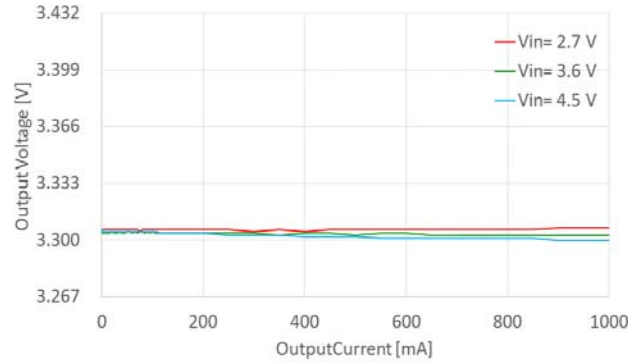

4) Temperature vs. Output Voltage RP601Z330x

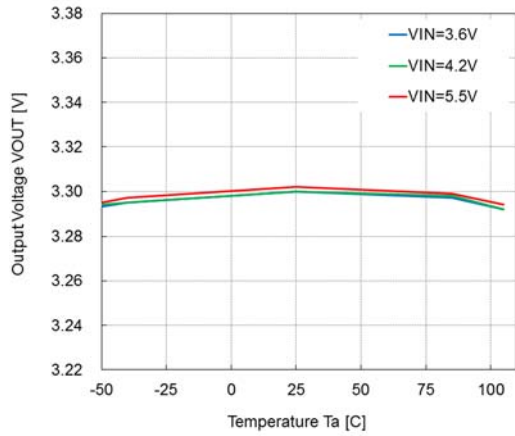

5) Temperature vs. Standby Current RP601Z330x, VIN = 5.5 V

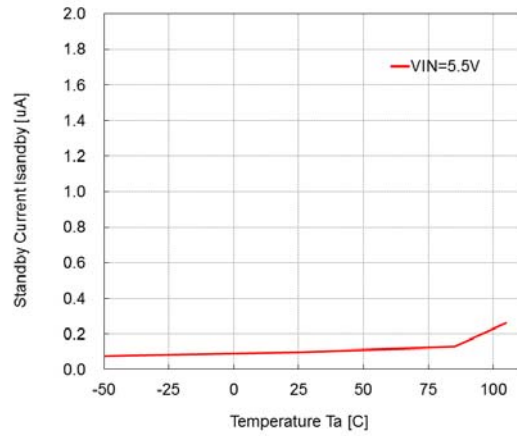

6) Input Voltage vs. Output Current
RP601Z275x, MODE = H

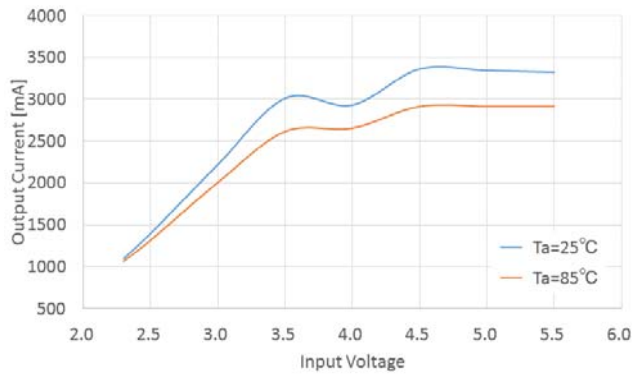

RP601Z330x, MODE = H

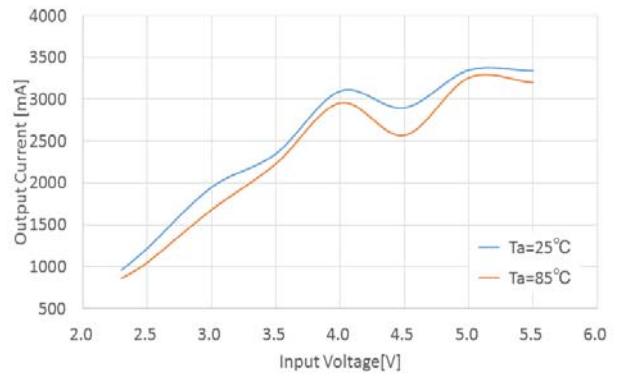

RP601Z420x, MODE = H

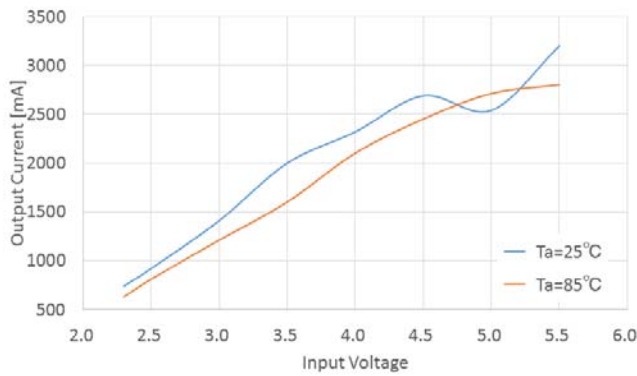

7) Temperature vs. Soft-start Time
RP601Z330x

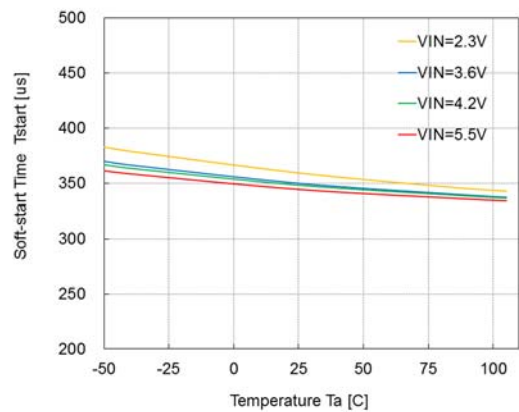

8) CE Start-up Waveform
RP601Z330x, VIN = 3.6 V, MODE = L
IOUT = 0 mA

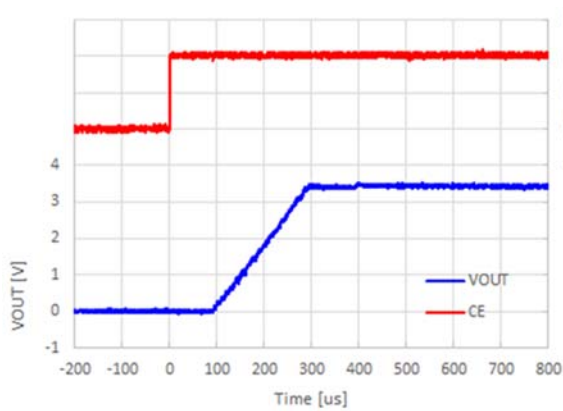

RP601Z330x, VIN = 3.6 V, MODE = H
IOUT = 0 mA

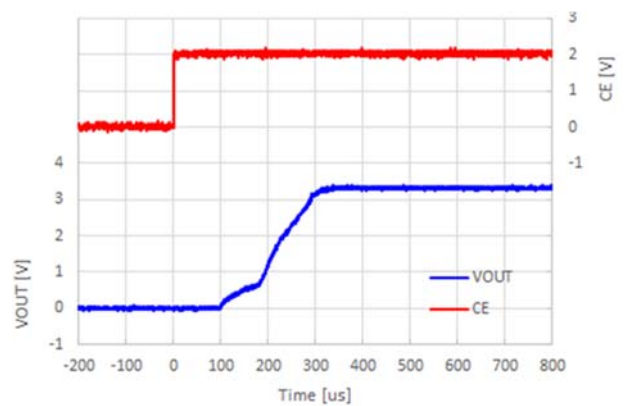

RP601x

NO. EA-333-180618

9) V_{OUT} Waveform

RP601Z275x, V_{IN} = 3.6 V, MODE = L
I_{OUT} = 10 mA, L = DFE201610C (2016 size 1.0 μH)

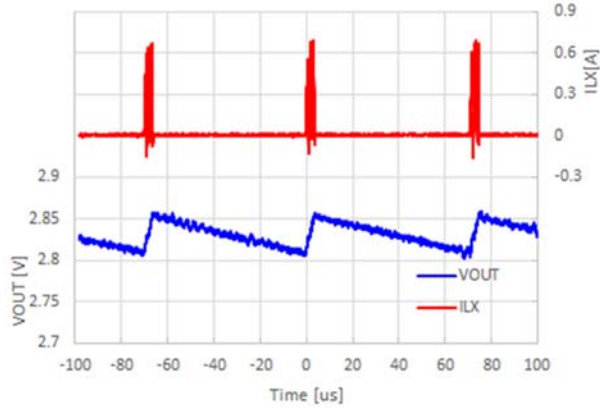

RP601Z275x, V_{IN} = 3.6 V, MODE = H
I_{OUT} = 0 mA, L = DFE201610C (2016 size 1.0 μH)

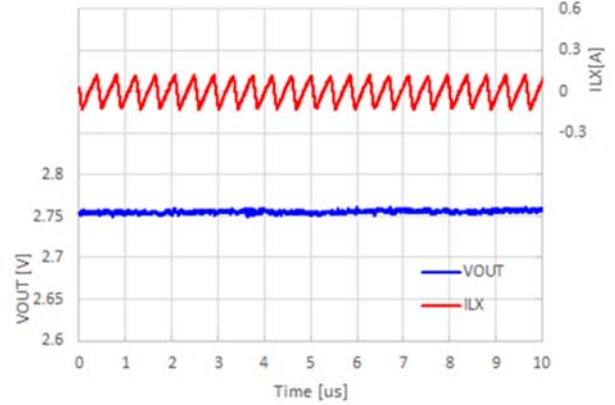

RP601Z330x, V_{IN} = 3.6 V, MODE = L
I_{OUT} = 10 mA, L = DFE201610C (2016 size 1.0 μH)

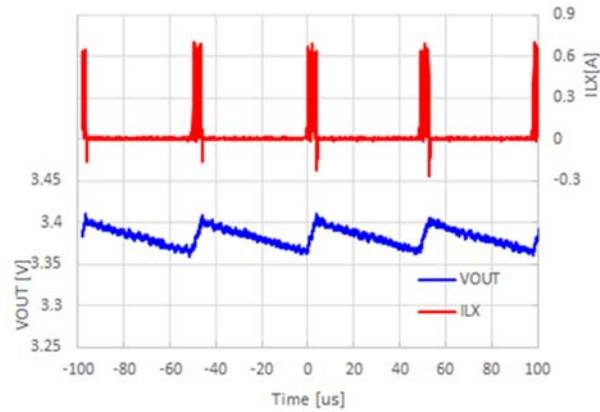

RP601Z330x, V_{IN} = 3.6 V, MODE = H
I_{OUT} = 0 mA, L = DFE201610C (2016 size 1.0 μH)

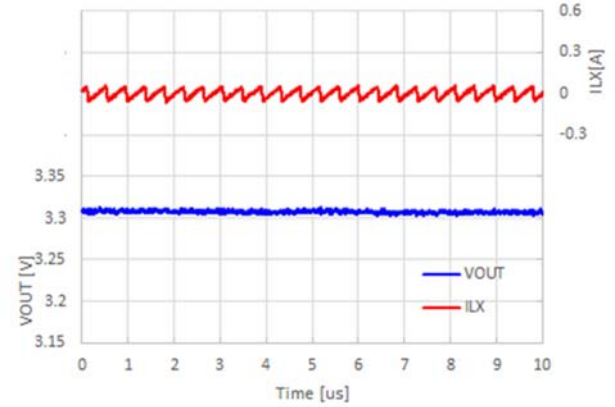

RP601Z420x, V_{IN} = 3.6 V, MODE = L
I_{OUT} = 10 mA, L = DFE252012C (2520 size 2.2 μH)

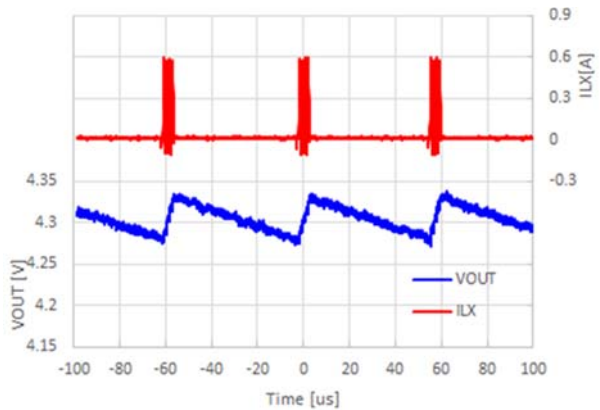

RP601Z420x, V_{IN} = 3.6 V, MODE = H
I_{OUT} = 0 mA, L = DFE201610C (2016 size 1.0 μH)

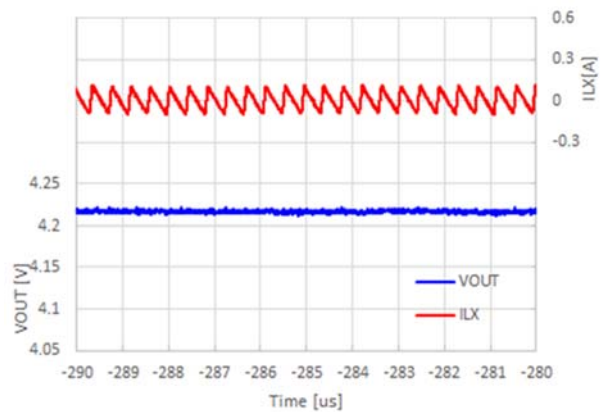

10) Load Transient Response Waveform

RP601Z330x, $V_{IN} = 3.6\text{ V}$, MODE = L

$I_{OUT} = 0\text{ mA} \leftrightarrow 500\text{ mA}$

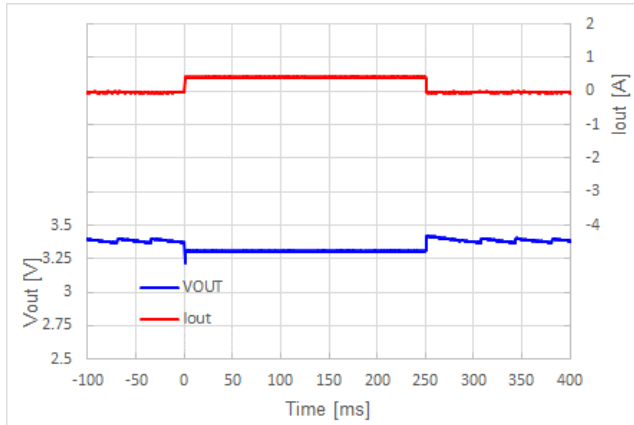

RP601Z330x, $V_{IN} = 3.6\text{ V}$, MODE = H

$I_{OUT} = 0\text{ mA} \leftrightarrow 500\text{ mA}$

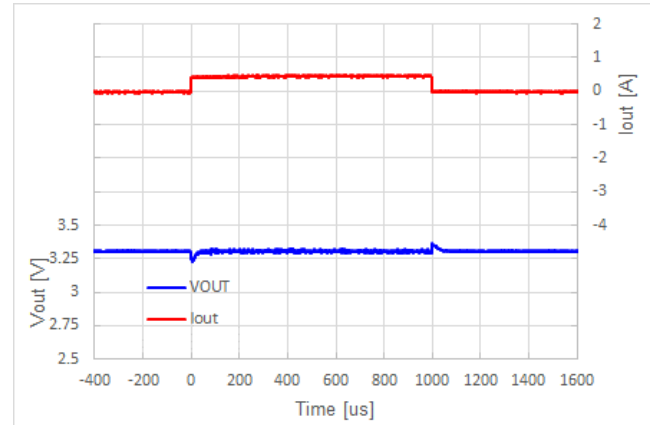

RP601Z330x, $V_{IN} = 3.6\text{ V}$, MODE = L

$I_{OUT} = 500\text{ mA} \leftrightarrow 1000\text{ mA}$

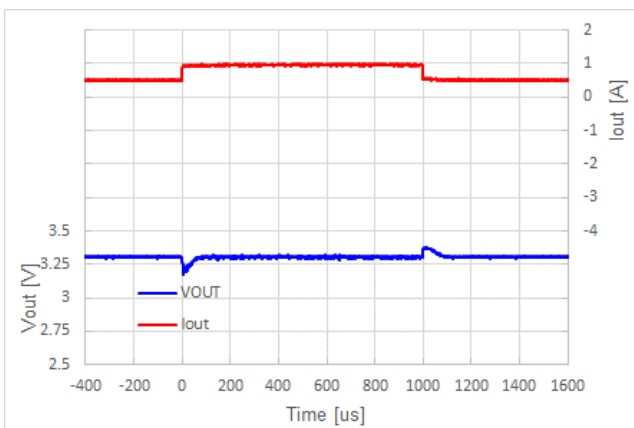

RP601Z330x, $V_{IN} = 3.6\text{ V}$, MODE = H

$I_{OUT} = 500\text{ mA} \leftrightarrow 1000\text{ mA}$

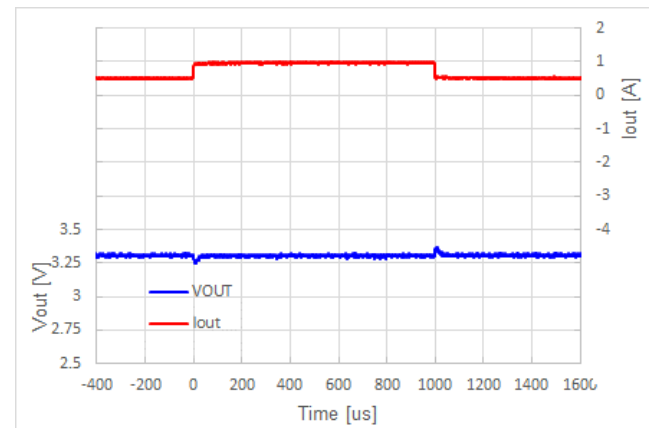

11) CE Start-up Waveform

RP601Z330x, $V_{IN} = 3.6\text{ V}$, MODE = L

$I_{OUT} = 0\text{ mA}$

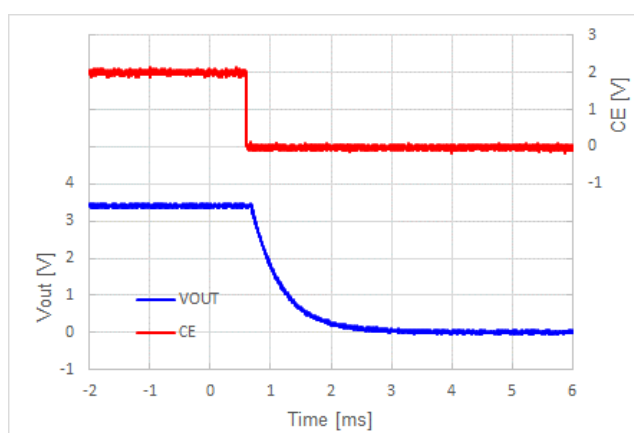

RP601Z330x, $V_{IN} = 3.6\text{ V}$, MODE = H

$I_{OUT} = 0\text{ mA}$

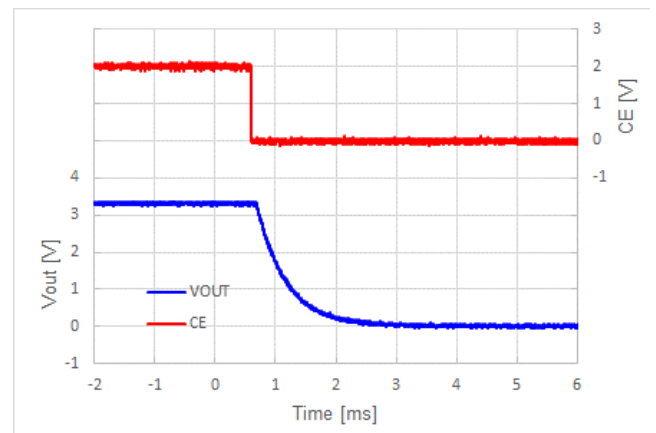

RP601x

NO. EA-333-180618

12) Input Transient Response Waveform

RP601Z330x, MODE = L

$I_{OUT} = 500 \text{ mA}$, $V_{IN} = 2.5 \text{ V} \leftrightarrow 4.5 \text{ V}$

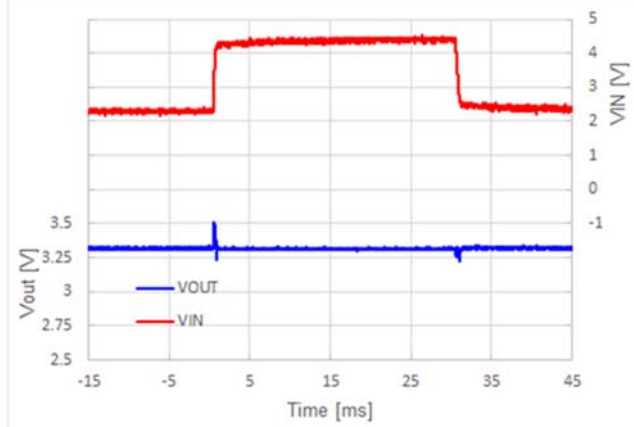

RP601Z330x, MODE = H

$I_{OUT} = 500 \text{ mA}$, $V_{IN} = 2.5 \text{ V} \leftrightarrow 4.5 \text{ V}$

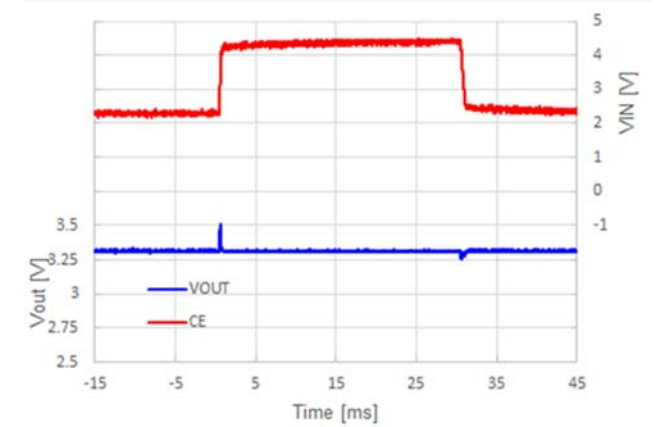

13) Transient Response Waveform When Changing V_{OUT} Using a Single-wire

RP601Zxxxx, $V_{IN} = 3.6 \text{ V}$, MODE = H, $I_{OUT} = 0 \text{ mA}$

$V_{OUT} = 2.75 \text{ V} \rightarrow 4.2 \text{ V}$

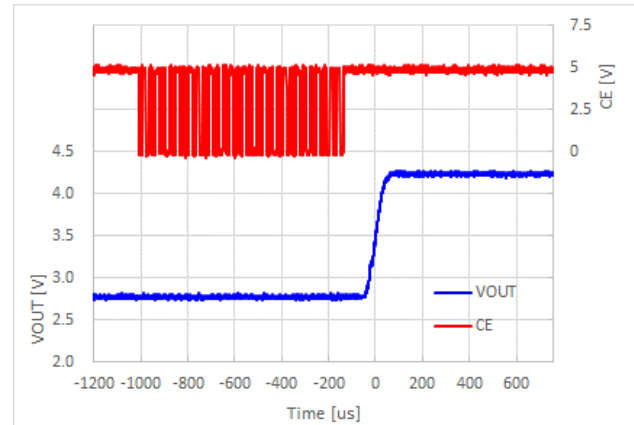

RP601Zxxxx, $V_{IN} = 3.6 \text{ V}$, MODE = H, $I_{OUT} = 0 \text{ mA}$

$V_{OUT} = 4.2 \text{ V} \rightarrow 2.75 \text{ V}$

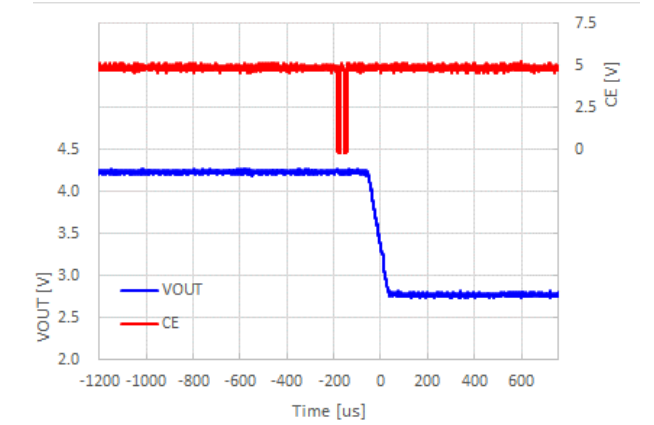

14) BP Switching Transient Response Waveform

RP601Z330x, $V_{IN} = 2.3 \text{ V}$, MODE = L

$I_{OUT} = 50 \text{ mA}$

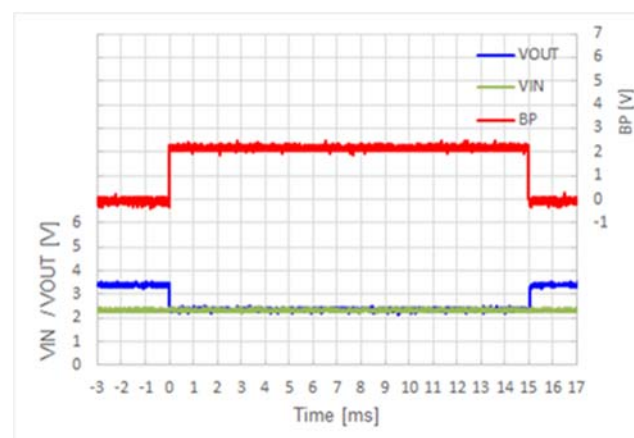

RP601Z330x, $V_{IN} = 5.5 \text{ V}$, MODE = L

$I_{OUT} = 50 \text{ mA}$

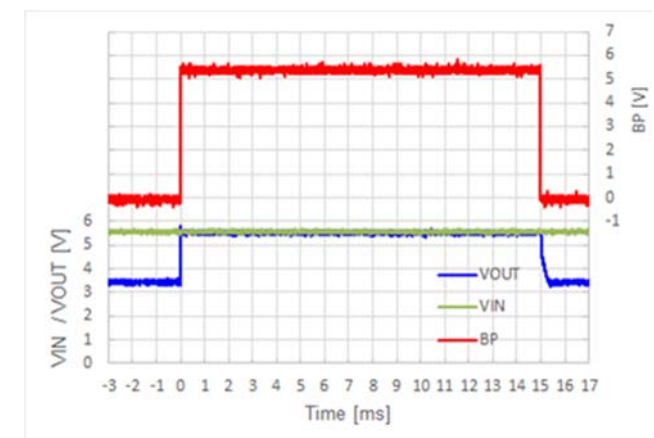

The power dissipation of the package is dependent on PCB material, layout, and environmental conditions. The following measurement conditions are based on JEDEC STD. 51-9.

Measurement Conditions

Item	Measurement Conditions
Environment	Mounting on Board (Wind Velocity = 0 m/s)
Board Material	Glass Cloth Epoxy Plastic (Four-Layer Board)
Board Dimensions	101.5 mm × 114.5 mm × 1.6 mm
Copper Ratio	Outer Layers (First and Fourth Layers): 60% Inner Layers (Second and Third Layers): 100%

Measurement Result

(Ta = 25°C, Tjmax = 125°C)

Item	Measurement Result
Power Dissipation	1400 mW
Thermal Resistance (θ_{ja})	$\theta_{ja} = 71^\circ\text{C/W}$

θ_{ja} : Junction-to-Ambient Thermal Resistance

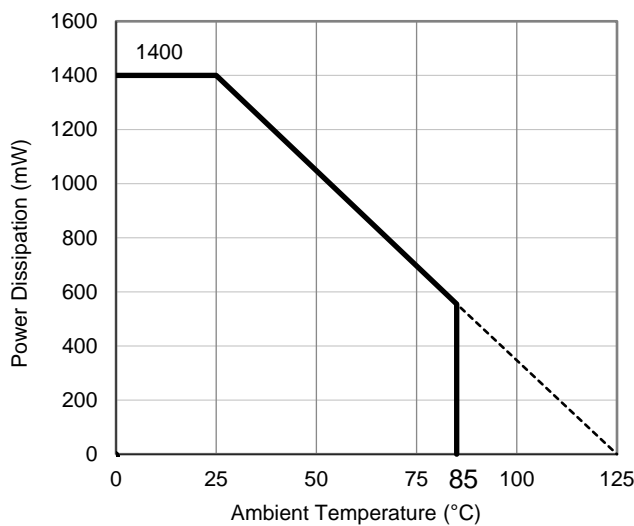

Power Dissipation vs. Ambient Temperature

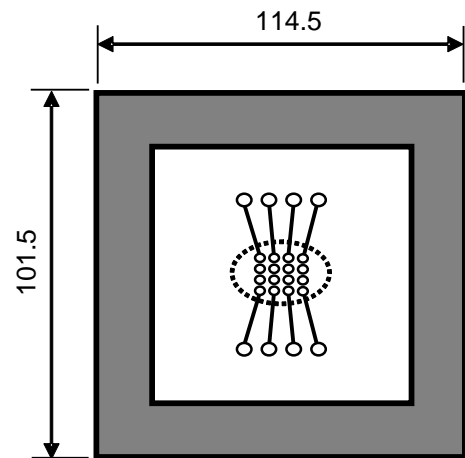

Measurement Board Pattern

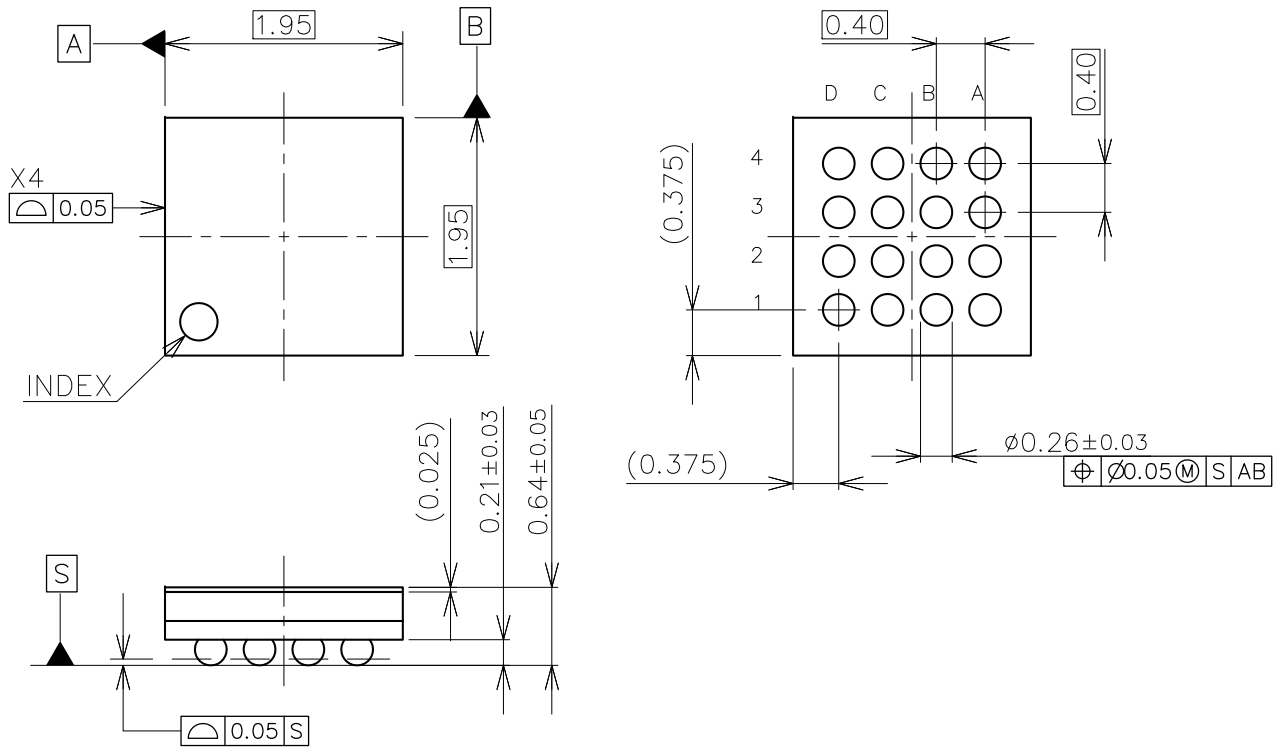

WLCSP-16-P1 Package Dimensions (Unit: mm)

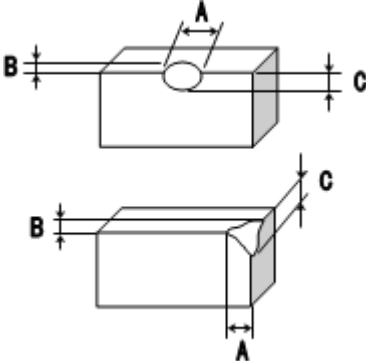
No.	Inspection Items	Inspection Criteria	Figure
1	Package chipping	$A \geq 0.2\text{mm}$ is rejected $B \geq 0.2\text{mm}$ is rejected $C \geq 0.2\text{mm}$ is rejected And, Package chipping to Si surface and to bump is rejected.	
2	Si surface chipping	$A \geq 0.2\text{mm}$ is rejected $B \geq 0.2\text{mm}$ is rejected $C \geq 0.2\text{mm}$ is rejected But, even if $A \geq 0.2\text{mm}$, $B \leq 0.1\text{mm}$ is acceptable.	
3	No bump	No bump is rejected.	
4	Marking miss	To reject incorrect marking, such as another product name marking or another lot No. marking.	
5	No marking	To reject no marking on the package.	
6	Reverse direction of marking	To reject reverse direction of marking character.	
7	Defective marking	To reject unreadable marking. (Microscope: X15/ White LED/ Viewed from vertical direction)	
8	Scratch	To reject unreadable marking character by scratch. (Microscope: X15/ White LED/ Viewed from vertical direction)	
9	Stain and Foreign material	To reject unreadable marking character by stain and foreign material. (Microscope: X15/ White LED/ Viewed from vertical direction)	



1. The products and the product specifications described in this document are subject to change or discontinuation of production without notice for reasons such as improvement. Therefore, before deciding to use the products, please refer to Ricoh sales representatives for the latest information thereon.
2. The materials in this document may not be copied or otherwise reproduced in whole or in part without prior written consent of Ricoh.
3. Please be sure to take any necessary formalities under relevant laws or regulations before exporting or otherwise taking out of your country the products or the technical information described herein.
4. The technical information described in this document shows typical characteristics of and example application circuits for the products. The release of such information is not to be construed as a warranty of or a grant of license under Ricoh's or any third party's intellectual property rights or any other rights.
5. The products listed in this document are intended and designed for use as general electronic components in standard applications (office equipment, telecommunication equipment, measuring instruments, consumer electronic products, amusement equipment etc.). Those customers intending to use a product in an application requiring extreme quality and reliability, for example, in a highly specific application where the failure or misoperation of the product could result in human injury or death (aircraft, spacevehicle, nuclear reactor control system, traffic control system, automotive and transportation equipment, combustion equipment, safety devices, life support system etc.) should first contact us.
6. We are making our continuous effort to improve the quality and reliability of our products, but semiconductor products are likely to fail with certain probability. In order to prevent any injury to persons or damages to property resulting from such failure, customers should be careful enough to incorporate safety measures in their design, such as redundancy feature, fire containment feature and fail-safe feature. We do not assume any liability or responsibility for any loss or damage arising from misuse or inappropriate use of the products.
7. Anti-radiation design is not implemented in the products described in this document.
8. The X-ray exposure can influence functions and characteristics of the products. Confirm the product functions and characteristics in the evaluation stage.
9. WLCSP products should be used in light shielded environments. The light exposure can influence functions and characteristics of the products under operation or storage.
10. There can be variation in the marking when different AOI (Automated Optical Inspection) equipment is used. In the case of recognizing the marking characteristic with AOI, please contact Ricoh sales or our distributor before attempting to use AOI.
11. Please contact Ricoh sales representatives should you have any questions or comments concerning the products or the technical information.



Ricoh is committed to reducing the environmental loading materials in electrical devices with a view to contributing to the protection of human health and the environment.

Ricoh has been providing RoHS compliant products since April 1, 2006 and Halogen-free products since April 1, 2012.

RICOH RICOH ELECTRONIC DEVICES CO., LTD.

<https://www.e-devices.ricoh.co.jp/en/>

Sales & Support Offices

Ricoh Electronic Devices Co., Ltd.

Shin-Yokohama Office (International Sales)

2-3, Shin-Yokohama 3-chome, Kohoku-ku, Yokohama-shi, Kanagawa, 222-8530, Japan
Phone: +81-50-3814-7687 Fax: +81-45-474-0074

Ricoh Americas Holdings, Inc.

675 Campbell Technology Parkway, Suite 200 Campbell, CA 95008, U.S.A.
Phone: +1-408-610-3105

Ricoh Europe (Netherlands) B.V.

Semiconductor Support Centre

Prof. W.H. Keesomlaan 1, 1183 DJ Amstelveen, The Netherlands
Phone: +31-20-5474-309

Ricoh International B.V. - German Branch

Semiconductor Sales and Support Centre

Oberrather Strasse 6, 40472 Düsseldorf, Germany
Phone: +49-211-6546-0

Ricoh Electronic Devices Korea Co., Ltd.

3F, Haesung Bldg, 504, Teheran-ro, Gangnam-gu, Seoul, 135-725, Korea
Phone: +82-2-2135-5700 Fax: +82-2-2051-5713

Ricoh Electronic Devices Shanghai Co., Ltd.

Room 403, No.2 Building, No.690 Bibo Road, Pu Dong New District, Shanghai 201203,
People's Republic of China
Phone: +86-21-5027-3200 Fax: +86-21-5027-3299

Ricoh Electronic Devices Shanghai Co., Ltd.

Shenzhen Branch

1205, Block D (Jinlong Building), Kingkey 100, Hongbao Road, Luohu District,
Shenzhen, China
Phone: +86-755-8348-7600 Ext 225

Ricoh Electronic Devices Co., Ltd.

Taipei office

Room 109, 10F-1, No.51, Hengyang Rd., Taipei City, Taiwan
Phone: +886-2-2313-1621/1622 Fax: +886-2-2313-1623

Mouser Electronics

Authorized Distributor

Click to View Pricing, Inventory, Delivery & Lifecycle Information:

[Ricoh Electronics:](#)

[RP601Z330A-E2-F](#) [RP601Z420A-E2-F](#) [RP601Z360A-E2-F](#)

Компания «Океан Электроники» предлагает заключение долгосрочных отношений при поставках импортных электронных компонентов на взаимовыгодных условиях!

Наши преимущества:

- Поставка оригинальных импортных электронных компонентов напрямую с производств Америки, Европы и Азии, а так же с крупнейших складов мира;
- Широкая линейка поставок активных и пассивных импортных электронных компонентов (более 30 млн. наименований);
- Поставка сложных, дефицитных, либо снятых с производства позиций;
- Оперативные сроки поставки под заказ (от 5 рабочих дней);
- Экспресс доставка в любую точку России;
- Помощь Конструкторского Отдела и консультации квалифицированных инженеров;
- Техническая поддержка проекта, помощь в подборе аналогов, поставка прототипов;
- Поставка электронных компонентов под контролем ВП;
- Система менеджмента качества сертифицирована по Международному стандарту ISO 9001;
- При необходимости вся продукция военного и аэрокосмического назначения проходит испытания и сертификацию в лаборатории (по согласованию с заказчиком);
- Поставка специализированных компонентов военного и аэрокосмического уровня качества (Xilinx, Altera, Analog Devices, Intersil, Interpoint, Microsemi, Actel, Aeroflex, Peregrine, VPT, Syfer, Eurofarad, Texas Instruments, MS Kennedy, Miteq, Cobham, E2V, MA-COM, Hittite, Mini-Circuits, General Dynamics и др.);

Компания «Океан Электроники» является официальным дистрибьютором и эксклюзивным представителем в России одного из крупнейших производителей разъемов военного и аэрокосмического назначения «**JONHON**», а так же официальным дистрибьютором и эксклюзивным представителем в России производителя высокотехнологичных и надежных решений для передачи СВЧ сигналов «**FORSTAR**».



JONHON

«**JONHON**» (основан в 1970 г.)

Разъемы специального, военного и аэрокосмического назначения:

(Применяются в военной, авиационной, аэрокосмической, морской, железнодорожной, горно- и нефтедобывающей отраслях промышленности)

«**FORSTAR**» (основан в 1998 г.)

ВЧ соединители, коаксиальные кабели, кабельные сборки и микроволновые компоненты:

(Применяются в телекоммуникациях гражданского и специального назначения, в средствах связи, РЛС, а так же военной, авиационной и аэрокосмической отраслях промышленности).



Телефон: 8 (812) 309-75-97 (многоканальный)

Факс: 8 (812) 320-03-32

Электронная почта: ocean@oceanchips.ru

Web: <http://oceanchips.ru/>

Адрес: 198099, г. Санкт-Петербург, ул. Калинина, д. 2, корп. 4, лит. А