

# 3M™ Pak 50 Boardmount Plug

.050" Through-Hole, Straight and Right Angle, with Ret. Clips, Flng. Option

P50 Series



- Contact design features two contact points and straight beam construction for connector reliability and low insertion force
- Retention clip secures connector for wave soldering eliminating additional hardware expenses
- Horizontal, parallel or vertical mating available
- Insulator design prevents mis-insertion errors and contact damage
- Available with and without flanges
- RoHS Compliant. See the Regulatory Information Appendix (RIA) in the "RoHS Compliance" section of [www.3Mconnector.com](http://www.3Mconnector.com) for compliance information (RIA E1 and C1 apply)

Date Modified: February 10, 2010

TS-2046-B  
Sheet 1 of 6

---

## Physical

### Insulator:

Material: Glass Filled Nylon

Flammability: UL 94V-0

Color: Black

Contact Material: Phosphor Bronze

### Plating:

Underplating: Nickel

Wiping Area: 10  $\mu$ " [ 0.25  $\mu$ m ] Gold

Solder Tails: Gold Flash

Retaining Clips: Tin-Copper

Mating Compatibility: TS-2047

---

## Electrical

**Current Rating:** 0.5 A

**Insulation Resistance:**  $> 1 \times 10^9 \Omega$  at 500 V<sub>DC</sub>

**Withstanding Voltage:** 500 V<sub>rms</sub> at Sea Level

---

## Environmental

**Temperature Rating:** -55°C to +85°C

**Process Rating:** 260°C Wave Solder Compatible

UL File No.: E68080

# 3M™ Pak 50 Boardmount Plug

.050" Through-Hole, Straight and Right Angle, with Ret. Clips, Flng. Option

P50 Series



Product Table / Dimensions for Straight with Flanges, with or without Retention Clips

| Contact Quantity | A                | B                | C                | D                |
|------------------|------------------|------------------|------------------|------------------|
| 20               | 25.43<br>[1.001] | 20.32<br>[0.800] | 15.83<br>[0.623] | 11.43<br>[0.450] |
| 26               | 29.24<br>[1.151] | 24.13<br>[0.950] | 19.64<br>[0.773] | 15.24<br>[0.600] |
| 30               | 31.78<br>[1.251] | 26.67<br>[1.050] | 22.18<br>[0.873] | 17.78<br>[0.700] |
| 32               | 33.05<br>[1.301] | 27.94<br>[1.100] | 23.45<br>[0.923] | 19.05<br>[0.750] |
| 34               | 34.32<br>[1.351] | 29.21<br>[1.150] | 24.72<br>[0.973] | 20.32<br>[0.800] |
| 40               | 38.13<br>[1.501] | 33.02<br>[1.300] | 28.53<br>[1.123] | 24.13<br>[0.950] |

| Contact Quantity | A                | B                | C                | D                |
|------------------|------------------|------------------|------------------|------------------|
| 50               | 44.48<br>[1.751] | 39.37<br>[1.550] | 34.88<br>[1.373] | 30.48<br>[1.200] |
| 52               | 45.75<br>[1.801] | 40.64<br>[1.600] | 36.15<br>[1.423] | 31.75<br>[1.250] |
| 60               | 50.83<br>[2.001] | 45.72<br>[1.800] | 41.23<br>[1.623] | 36.83<br>[1.450] |
| 68               | 55.91<br>[2.201] | 50.80<br>[2.000] | 46.31<br>[1.823] | 41.91<br>[1.650] |
| 80               | 63.53<br>[2.501] | 58.42<br>[2.300] | 53.93<br>[2.123] | 49.53<br>[1.950] |
| 100              | 76.23<br>[3.001] | 71.12<br>[2.800] | 66.63<br>[2.623] | 62.23<br>[2.450] |

With Retention Clips

Without Retention Clips

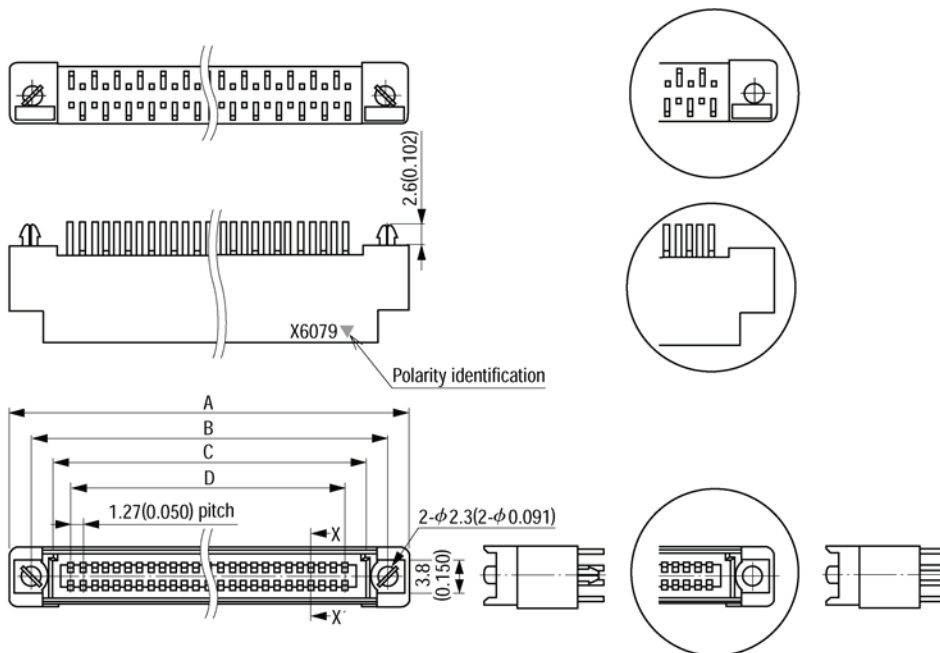

X-X' Cross Section



Shown with Retention Clips

TS-2046-B  
Sheet 2 of 5

# 3M™ Pak 50 Boardmount Plug

.050" Through-Hole, Straight and Right Angle, with Ret. Clips, Flng. Option

P50 Series

## Product Table / Dimensions for Straight without Flanges

| Contact Quantity | A                | B                | C                |
|------------------|------------------|------------------|------------------|
| 20               | 17.83<br>[0.702] | 15.83<br>[0.623] | 11.43<br>[0.450] |
| 26               | 21.64<br>[0.852] | 19.64<br>[0.773] | 15.24<br>[0.600] |
| 30               | 24.18<br>[0.952] | 22.18<br>[0.873] | 17.78<br>[0.700] |
| 32               | 25.45<br>[1.002] | 23.45<br>[0.923] | 19.05<br>[0.750] |
| 34               | 26.72<br>[1.052] | 24.72<br>[0.973] | 20.32<br>[0.800] |
| 40               | 30.53<br>[1.202] | 28.53<br>[1.123] | 24.13<br>[0.950] |

| Contact Quantity | A                | B                | C                |
|------------------|------------------|------------------|------------------|
| 50               | 36.88<br>[1.452] | 34.88<br>[1.373] | 30.48<br>[1.200] |
| 52               | 38.15<br>[1.502] | 36.15<br>[1.423] | 31.75<br>[1.250] |
| 60               | 43.23<br>[1.702] | 41.23<br>[1.623] | 36.83<br>[1.450] |
| 68               | 48.31<br>[1.902] | 46.31<br>[1.823] | 41.91<br>[1.650] |
| 80               | 55.93<br>[2.202] | 53.93<br>[2.123] | 49.53<br>[1.950] |
| 100              | 68.63<br>[2.702] | 66.63<br>[2.623] | 62.23<br>[2.450] |



### X-X' Cross Section

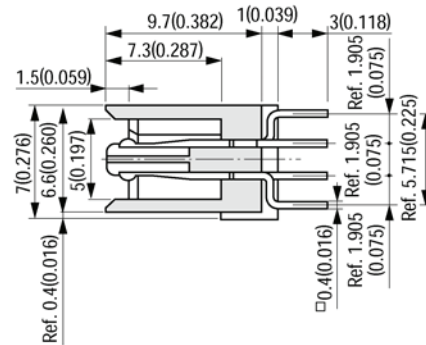

## Ordering Information

### P5X - XXXP - XXX - EA

Mounting Options:

- 0 = With Flanges
- 1 = Without Flanges, offered without retention clips only

Contact Quantity:  
See Table

Solder Tail and Clip Options:

- S1 = Straight without Retention Clips
- SR1 = Right Angle without Retention Clips
- R1 = Straight with Retention Clips
- RR1 = Right Angle with Retention Clips

TS-2046-B  
Sheet 3 of 5

# 3M™ Pak 50 Boardmount Plug

.050" Through-Hole, Straight and Right Angle, with Ret. Clips, Flng. Option

P50 Series

**Product Table / Dimensions for Right Angle with Flanges, with or without Retention Clips**

| Contact Quantity | A                | B                | C                | D                |
|------------------|------------------|------------------|------------------|------------------|
| 20               | 25.43<br>[1.001] | 20.32<br>[0.800] | 15.83<br>[0.623] | 11.43<br>[0.450] |
| 26               | 29.24<br>[1.151] | 24.13<br>[0.950] | 19.64<br>[0.773] | 15.24<br>[0.600] |
| 30               | 31.78<br>[1.251] | 26.67<br>[1.050] | 22.18<br>[0.873] | 17.78<br>[0.700] |
| 32               | 33.05<br>[1.301] | 27.94<br>[1.100] | 23.45<br>[0.923] | 19.05<br>[0.750] |
| 34               | 34.32<br>[1.351] | 29.21<br>[1.150] | 24.72<br>[0.973] | 20.32<br>[0.800] |
| 40               | 38.13<br>[1.501] | 33.02<br>[1.300] | 28.53<br>[1.123] | 24.13<br>[0.950] |

| Contact Quantity | A                | B                | C                | D                |
|------------------|------------------|------------------|------------------|------------------|
| 50               | 44.48<br>[1.751] | 39.37<br>[1.550] | 34.88<br>[1.373] | 30.48<br>[1.200] |
| 52               | 45.75<br>[1.801] | 40.64<br>[1.600] | 36.15<br>[1.423] | 31.75<br>[1.250] |
| 60               | 50.83<br>[2.001] | 45.72<br>[1.800] | 41.23<br>[1.623] | 36.83<br>[1.450] |
| 68               | 55.91<br>[2.201] | 50.80<br>[2.000] | 46.31<br>[1.823] | 41.91<br>[1.650] |
| 80               | 63.53<br>[2.501] | 58.42<br>[2.300] | 53.93<br>[2.123] | 49.53<br>[1.950] |
| 100              | 76.23<br>[3.001] | 71.12<br>[2.800] | 66.63<br>[2.623] | 62.23<br>[2.450] |

With Retention Clips

Without Retention Clips



**X-X' Cross Section**

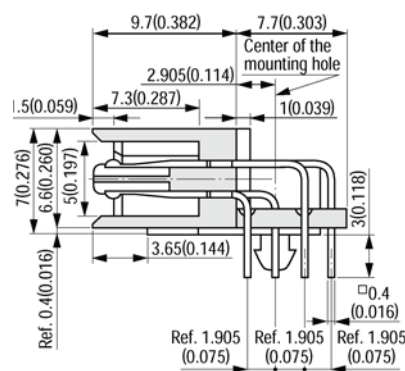

TS-2046-B  
Sheet 4 of 5

# 3M™ Pak 50 Boardmount Plug

.050" Through-Hole, Straight and Right Angle, with Ret. Clips, Flng. Option

P50 Series

Product Table / Dimensions for Right Angle without Flanges

| Contact Quantity | A                | B                | C                |
|------------------|------------------|------------------|------------------|
| 20               | 17.83<br>[0.702] | 15.83<br>[0.623] | 11.43<br>[0.450] |
| 26               | 21.64<br>[0.852] | 19.64<br>[0.773] | 15.24<br>[0.600] |
| 30               | 24.18<br>[0.952] | 22.18<br>[0.873] | 17.78<br>[0.700] |
| 32               | 25.45<br>[1.002] | 23.45<br>[0.923] | 19.05<br>[0.750] |
| 34               | 26.72<br>[1.052] | 24.72<br>[0.973] | 20.32<br>[0.800] |
| 40               | 30.53<br>[1.202] | 28.53<br>[1.123] | 24.13<br>[0.950] |

| Contact Quantity | A                | B                | C                |
|------------------|------------------|------------------|------------------|
| 50               | 36.88<br>[1.452] | 34.88<br>[1.373] | 30.48<br>[1.200] |
| 52               | 38.15<br>[1.502] | 36.15<br>[1.423] | 31.75<br>[1.250] |
| 60               | 43.23<br>[1.702] | 41.23<br>[1.623] | 36.83<br>[1.450] |
| 68               | 48.31<br>[1.902] | 46.31<br>[1.823] | 41.91<br>[1.650] |
| 80               | 55.93<br>[2.202] | 53.93<br>[2.123] | 49.53<br>[1.950] |
| 100              | 68.63<br>[2.702] | 66.63<br>[2.623] | 62.23<br>[2.450] |

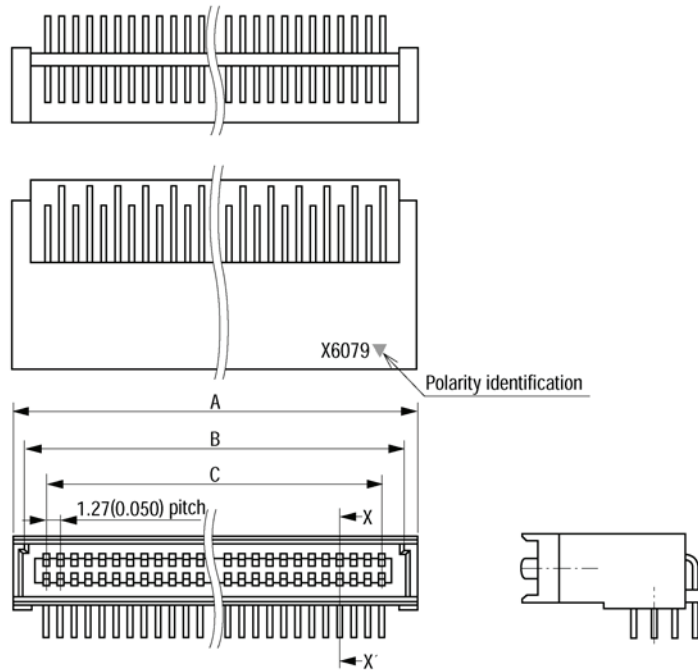

X-X' Cross Section

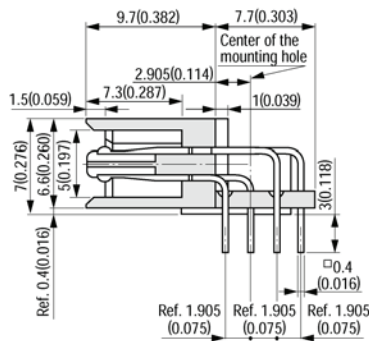

TS-2046-B  
Sheet 5 of 5

# 3M™ Pak 50 Boardmount Plug

.050" Through-Hole, Straight and Right Angle, with Ret. Clips, Flng. Option

P50 Series

## Printed Circuit Board Layout (Component Side View)

### STRAIGHT WITH FLANGES (with and without Retention Clips)

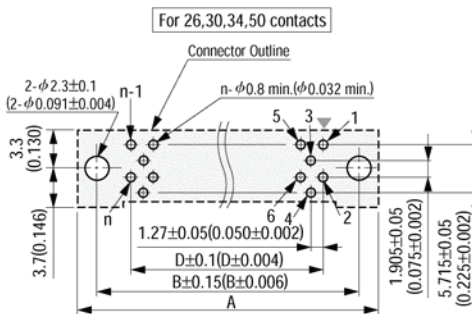

### STRAIGHT WITHOUT FLANGES



▼=Polarity identification  
Recommended PCB Thickness  $t = 1.6 \pm 0.19 (0.063 \pm 0.007)$   
"n" is number of contacts.

### RIGHT ANGLE WITH FLANGES (with and without Retention Clips)

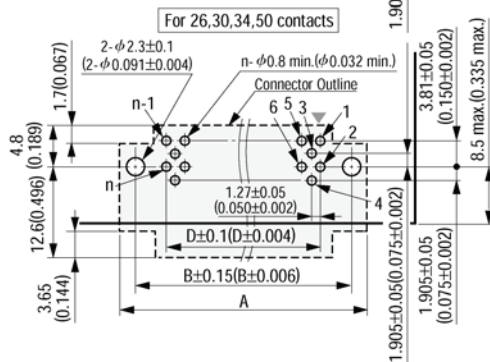

### RIGHT ANGLE WITHOUT FLANGES

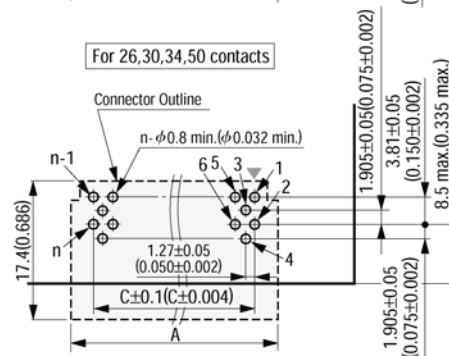
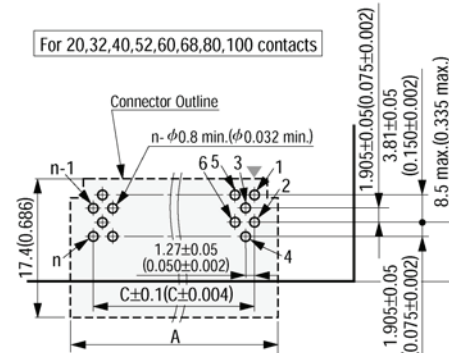

TS-2046-B  
Sheet 6 of 5

**Important Notice**

All statements, technical information, and recommendations related to 3M's products are based on information believed to be reliable, but the accuracy or completeness is not guaranteed. Before using this product, you must evaluate it and determine if it is suitable for your intended application. You assume all risks and liability associated with such use. Any statements related to the product which are not contained in 3M's current publications, or any contrary statements contained on your purchase order shall have no force or effect unless expressly agreed upon, in writing, by an authorized officer of 3M.

**Warranty; Limited Remedy; Limited Liability.**

This product will be free from defects in material and manufacture for a period of one (1) year from the time of purchase. **3M MAKES NO OTHER WARRANTIES INCLUDING, BUT NOT LIMITED TO, ANY IMPLIED WARRANTY OF MERCHANTABILITY OR FITNESS FOR A PARTICULAR PURPOSE.** If this product is defective within the warranty period stated above, your exclusive remedy shall be, at 3M's option, to replace or repair the 3M product or refund the purchase price of the 3M product. **Except where prohibited by law, 3M will not be liable for any indirect, special, incidental or consequential loss or damage arising from this 3M product, regardless of the legal theory asserted.**

**3M Electronics Solutions Division**

6801 River Place Blvd.  
Austin, TX 78726-9000  
U.S.A.  
1-800-225-5373  
[www.3Mconnector.com](http://www.3Mconnector.com)

Please recycle. Printed in USA.  
© 3M 2010. All rights reserved.  
RIA-2217B-E

3M is a trademark of 3M Company.

Компания «Океан Электроники» предлагает заключение долгосрочных отношений при поставках импортных электронных компонентов на взаимовыгодных условиях!

Наши преимущества:

- Поставка оригинальных импортных электронных компонентов напрямую с производств Америки, Европы и Азии, а так же с крупнейших складов мира;
- Широкая линейка поставок активных и пассивных импортных электронных компонентов (более 30 млн. наименований);
- Поставка сложных, дефицитных, либо снятых с производства позиций;
- Оперативные сроки поставки под заказ (от 5 рабочих дней);
- Экспресс доставка в любую точку России;
- Помощь Конструкторского Отдела и консультации квалифицированных инженеров;
- Техническая поддержка проекта, помощь в подборе аналогов, поставка прототипов;
- Поставка электронных компонентов под контролем ВП;
- Система менеджмента качества сертифицирована по Международному стандарту ISO 9001;
- При необходимости вся продукция военного и аэрокосмического назначения проходит испытания и сертификацию в лаборатории (по согласованию с заказчиком);
- Поставка специализированных компонентов военного и аэрокосмического уровня качества (Xilinx, Altera, Analog Devices, Intersil, Interpoint, Microsemi, Actel, Aeroflex, Peregrine, VPT, Syfer, Eurofarad, Texas Instruments, MS Kennedy, Miteq, Cobham, E2V, MA-COM, Hittite, Mini-Circuits, General Dynamics и др.);

Компания «Океан Электроники» является официальным дистрибьютором и эксклюзивным представителем в России одного из крупнейших производителей разъемов военного и аэрокосмического назначения «JONHON», а так же официальным дистрибьютором и эксклюзивным представителем в России производителя высокотехнологичных и надежных решений для передачи СВЧ сигналов «FORSTAR».



## JONHON

«JONHON» (основан в 1970 г.)

Разъемы специального, военного и аэрокосмического назначения:

(Применяются в военной, авиационной, аэрокосмической, морской, железнодорожной, горно- и нефтедобывающей отраслях промышленности)

«FORSTAR» (основан в 1998 г.)

ВЧ соединители, коаксиальные кабели, кабельные сборки и микроволновые компоненты:

(Применяются в телекоммуникациях гражданского и специального назначения, в средствах связи, РЛС, а так же военной, авиационной и аэрокосмической отраслях промышленности).



Телефон: 8 (812) 309-75-97 (многоканальный)

Факс: 8 (812) 320-03-32

Электронная почта: [ocean@oceanchips.ru](mailto:ocean@oceanchips.ru)

Web: <http://oceanchips.ru/>

Адрес: 198099, г. Санкт-Петербург, ул. Калинина, д. 2, корп. 4, лит. А