

# Round Water-resistant Connectors (M12)

## XS2

### Water- and Environment-resistive FA Connectors Save Wiring and Maintenance Effort

- Compact FA connectors satisfy IP67 requirements and ensure a 94V-0 fire retardant rating.
- A wide array of connectors makes a wiring system more modular, simplifies maintenance, and reduces downtime.
- Connectors with Cables and Connector Assemblies are available.
- Three types of Connector Assembly: Crimping, soldering, and screw-on.



### ■ Ratings and Specifications

Item	4,5 Poles	8 Poles
Rated current	4 A	1.5 A
Rated voltage	125 VDC, 250 VAC	36 VDC
Contact resistance	40 mΩ max. (20 mV max., 100 mA max.)	
Insulation resistance	1,000 MΩ min. (at 500 VDC)	
Dielectric strength (leakage current: 1 mA max.)	1,500 VAC for 1 min	1,000 VAC for 1 min
Degree of protection	IP67 (IEC60529)	
Insertion tolerance	200 times min.	

### ■ Material

Contact / Surface	Copper Alloy / Nickel base, Au 0.4 μm
Connector housing	PBT resin (UL94V-0)
Nut / Surface	Copper Alloy / Nickel plated
Cover (XS2F/H/W/R)	PBT resin (UL94V-0)
Body (XS2C/G)	PBT resin (UL94V-0)

### ■ PVC Cable

Item	3 cores	4 cores	5 cores	8 cores
Color	Black			Light Grey
Outer diameter	5 mm dia.	5.4 mm dia.	5.8 mm dia.	6 mm dia.
Conductor size	AWG22 0.34 mm <sup>2</sup> (43 × 0.1)			0.25 mm <sup>2</sup> (20 × 0.127)
Approvals	AWM			—
Features	Flame retardant			—
Temperature range	Cable fixed: -10 to +80°C / Cable moved: -0 to +60°C			-25°C to +70°C

### ■ PVC Cable (For IP69K)

Item	Standard	Heat-resistant
Color	Light Gray	Black
Outer diameter	6 mm dia.	
Conductor size	AWG20 0.5 mm <sup>2</sup> (100 × 0.08)	AWG20 0.5 mm <sup>2</sup> (45 × 0.12)
Approvals	CL3	—
Features	Flame retardant	Heat and chemical resistant
Temperature range	-25 to +70°C	-25 to +105°C

### ■ PUR Cable

Item	3 cores	4 cores	5 cores
Color	Black		
Outer diameter	4.3 mm dia.	4.7 mm dia.	5 mm dia.
Conductor size	AWG22 0.34 mm <sup>2</sup> (43 × 0.1)		
Approvals	AWM		
Features	Flame retardant Halogen free Oil resistance		
Temperature range	Cable fixed: -50 to +80°C / Cable moved: -25 to +80°C		

### ■ Construction

#### (XS2G Soldering Plug Connector Assembly)

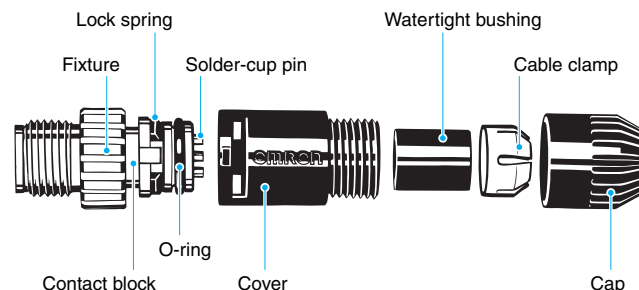

**Note:** 1. See "XS5/XS2 - Assembly Tooling and Accessories" datasheet for information regarding assembly, tooling and accessories that are common to the XS5 and XS2 connectors

2. See "XS5" datasheet for specifics regarding those connectors

# 4-Pin and 5-Pin Connectors with Cable Attached

## ■ XS2F - Socket on One Cable End

XS2F-M12PVC□□□□M PVC Cable  
 XS2F-M12PUR□□□□M PUR Cable



### Dimensions

(Unit: mm)

#### Straight



#### Angled



### Wiring Diagram

3 cores	4 cores	5 cores

## Ordering Information

Connector	Size	Cable material	Cores	Shape	Length (m)	Product description
Socket	M12	PVC	3	Angled	2	XS2F-M12PVC3A2M
					5	XS2F-M12PVC3A5M
					10	XS2F-M12PVC3A10M
				Straight	2	XS2F-M12PVC3S2M
					5	XS2F-M12PVC3S5M
					10	XS2F-M12PVC3S10M
			4	Angled	2	XS2F-M12PVC4A2M
					5	XS2F-M12PVC4A5M
					10	XS2F-M12PVC4A10M
				Straight	2	XS2F-M12PVC4S2M
					5	XS2F-M12PVC4S5M
					10	XS2F-M12PVC4S10M
			5	Angled	2	XS2F-M12PVC5A2M
					5	XS2F-M12PVC5A5M
					10	XS2F-M12PVC5A10M
		Straight		2	XS2F-M12PVC5S2M	
				5	XS2F-M12PVC5S5M	
				10	XS2F-M12PVC5S10M	
		PUR	3	Angled	2	XS2F-M12PUR3A2M
					5	XS2F-M12PUR3A5M
					10	XS2F-M12PUR3A10M
				Straight	2	XS2F-M12PUR3S2M
					5	XS2F-M12PUR3S5M
					10	XS2F-M12PUR3S10M
			4	Angled	2	XS2F-M12PUR4A2M
					5	XS2F-M12PUR4A5M
					10	XS2F-M12PUR4A10M
				Straight	2	XS2F-M12PUR4S2M
					5	XS2F-M12PUR4S5M
					10	XS2F-M12PUR4S10M
5	Angled		2	XS2F-M12PUR5A2M		
			5	XS2F-M12PUR5A5M		
			10	XS2F-M12PUR5A10M		
	Straight	2	XS2F-M12PUR5S2M			
		5	XS2F-M12PUR5S5M			
		10	XS2F-M12PUR5S10M			

## Model Number Legend

Use this model number legend to identify products from their model number. When ordering, use a model number from the table in *Ordering Information*.

**XS2F - M12**      **M**

1      2      3   4      5

**1. Screw Type**

M12: M12 size

**2. Cable type**

PVC: PVC cable

PUR: PUR cable

**3. Number of Poles**

3: 3 cores

4: 4 cores

5: 5 cores

**4. Shape**

A: Angled

S: Straight

**5. Cable Length**

2M: 2 m

5M: 5 m

10M: 10 m

# ■ XS2F - Socket on One Cable End with LED

XS2F-M12PVC□□□□MLED PVC Cable  
 XS2F-M12PUR□□□□MLED PUR Cable



## Dimensions

(Unit: mm)

Angled



## Wiring Diagram

**3 poles**

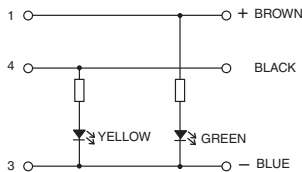

**4 poles**

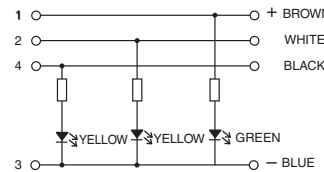

## Ordering Information

Connector Type	Shape	Size	Number of Poles	Cable Material	Cable Length (M)	Model	
Socket	Angled	M12	3	PVC	2	XS2F-M12PVC3A2MLED	
					5	XS2F-M12PVC3A5MLED	
					10	XS2F-M12PVC3A10MLED	
					4	2	XS2F-M12PVC4A2MLED
						5	XS2F-M12PVC4A5MLED
						10	XS2F-M12PVC4A10MLED
			3	PUR	2	XS2F-M12PUR3A2MLED	
					5	XS2F-M12PUR3A5MLED	
					10	XS2F-M12PUR3A10MLED	
					4	2	XS2F-M12PUR4A2MLED
						5	XS2F-M12PUR4A5MLED
						10	XS2F-M12PUR4A10MLED

## Model Number Legend

Use this model number legend to identify products from their model number. When ordering, use a model number from the table in *Ordering Information*.

XS2F - M12 □□□□ □A □□M LED  
 1 2 3 4 5 6

**1. Screw Type**

M12: M12 size

**2. Cable type**

PVC: PVC cable

PUR: PUR cable

**3. Number of Poles**

3: 3 cores

4: 4 cores

**4. Shape**

A: Angled

**5. Cable Length**

2M: 2 m

5M: 5 m

10M: 10 m

**6. LED**

LED: with LED

# ■ XS2F - Sockets on One Cable End with IP69K rating

## Dimensions

### Straight

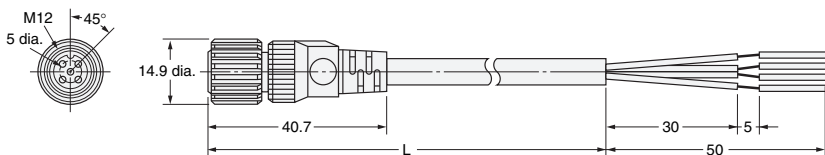
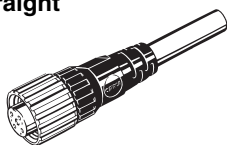

### Angled

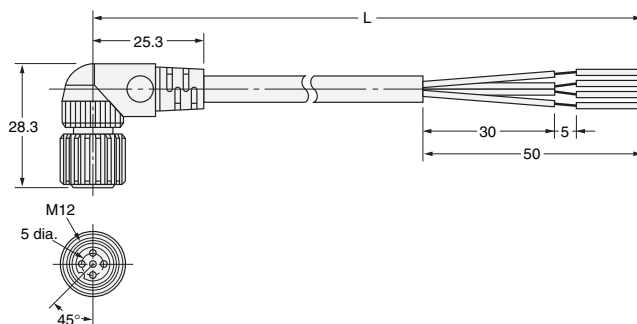

## Wiring Diagram



## Ordering Information

Connector	Size	Cable material	Cores	Shape	Length (m)	Product description
Socket	M12	Vibration Proof Robot Cable	4	Angled	2	XS2F-E422-D80-F
					5	XS2F-E422-G80-F
					10	XS2F-E422-J80-F
				Straight	2	XS2F-E421-D80-F
					5	XS2F-E421-G80-F
					10	XS2F-E421-J80-F
		Heat Resistant		Angled	2	XS2F-E422-D80-E
					5	XS2F-E422-G80-E
					10	XS2F-E422-J80-E
				Straight	2	XS2F-E421-D80-E
					5	XS2F-E421-G80-E
					10	XS2F-E421-J80-E

Note: XS2F-E42□□ models with -F are cRUus approved

## Model Number Legend

Use this model number legend to identify products from their model number. When ordering, use a model number from the table in *Ordering Information*.

XS2F - E42□□ - □80 - □  
1 2 3 4    5 6 7    8

1. Nut Material  
E: Stainless

2. Number of Poles  
4: 4 cores

3. Contact Plating  
2: 0.4-μm gold plating

4. Shape  
1: Straight  
2: Angled

5. Cable Length  
D: 2 m  
G: 5 m  
J: 10 m

6. Connections  
8: Brown, White, Blue, Black

7. Connectors on One End/Both Ends  
0: One End

8. Cable Specification  
F: Vibration Proof Robot Cable  
E: Heat-resistant cable

## ■ XS2H - Plugs on One Cable End

XS2H-M12PVC□□S□□M PVC Cable  
 XS2H-M12PUR□□S□□M PUR Cable



### Dimensions

(Unit: mm)

Straight



### Wiring Diagram

3 cores	4 cores	5 cores

### Ordering Information

Connector	Size	Cable material	Cores	Shape	Length (m)	Product description
Plug	M12	PVC	3	Straight	2	XS2H-M12PVC3S2M
					5	XS2H-M12PVC3S5M
					10	XS2H-M12PVC3S10M
			4		2	XS2H-M12PVC4S2M
					5	XS2H-M12PVC4S5M
					10	XS2H-M12PVC4S10M
			5		2	XS2H-M12PVC5S2M
					5	XS2H-M12PVC5S5M
					10	XS2H-M12PVC5S10M
		PUR	3		2	XS2H-M12PUR3S2M
					5	XS2H-M12PUR3S5M
					10	XS2H-M12PUR3S10M
			4		2	XS2H-M12PUR4S2M
					5	XS2H-M12PUR4S5M
					10	XS2H-M12PUR4S10M
5	2	XS2H-M12PUR5S2M				
	5	XS2H-M12PUR5S5M				

### Model Number Legend

Use this model number legend to identify products from their model number. When ordering, use a model number from the table in *Ordering Information*.

XS2H - M12 □□□□ □S □□M  
 1 2 3 4 5

**1. Screw Type**

M12: M12 size

**2. Cable type**

PVC: PVC cable

PUR: PUR cable

**3. Number of Poles**

3: 3 cores

4: 4 cores

5: 5 cores

**4. Shape**

S: Straight

**5. Cable Length**

2M: 2 m

5M: 5 m

10M: 10 m

## ■ XS2W - Socket and Plug on Cable Ends

XS2W-M12PVC□SS□□M PVC Cable  
 XS2W-M12PUR□SS□□M PUR Cable



### Dimensions

(Unit: mm)

Straight/Straight

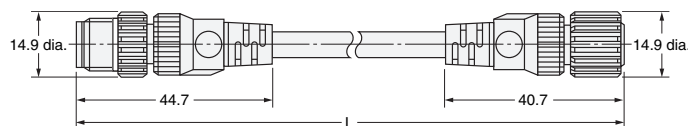

### Wiring Diagram

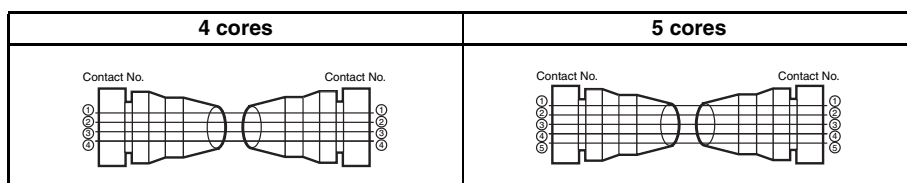

### Ordering Information

Connector	Size	Cable material	Cores	Shape		Length (m)	Product description
				Plug	Socket		
Both	M12	PVC	4	Straight	Straight	2	XS2W-M12PVC4SS2M
						5	XS2W-M12PVC4SS5M
						10	XS2W-M12PVC4SS10M
			5			2	XS2W-M12PVC5SS2M
						5	XS2W-M12PVC5SS5M
						10	XS2W-M12PVC5SS10M
		PUR	4			2	XS2W-M12PUR4SS2M
						5	XS2W-M12PUR4SS5M
						10	XS2W-M12PUR4SS10M
			5			2	XS2W-M12PUR5SS2M
						5	XS2W-M12PUR5SS5M
						10	XS2W-M12PUR5SS10M

### Model Number Legend

Use this model number legend to identify products from their model number. When ordering, use a model number from the table in *Ordering Information*.

XS2W - M12 □□□ □SS □□M  
 1 2 3 4 5

**1. Screw Type**

M12: M12 size

**2. Cable type**

PVC: PVC cable

PUR: PUR cable

**3. Number of Poles**

4: 4 cores

5: 5 cores

**4. Shape**

SS: Straight / Straight

**5. Cable Length**

2M: 2 m

5M: 5 m

1M: 10 m

# 4-Pin and 5-Pin Assembly Connector

## ■ XS2C - Sockets, Crimping / Soldering Terminals



### Dimensions

(Unit: mm)

XS2C-□4C□ (Crimping Model)

XS2C-□42□ (Soldering Model)

Straight

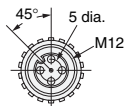

Angled

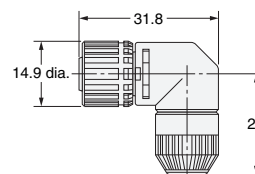
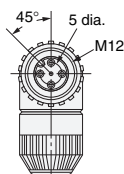

### Ordering Information

Suitable cable dia. (mm)	Cable connection direction	Connection method	Model	Minimum order
6-mm-dia. model (5 to 6 mm dia.)	Straight	Crimping	XS2C-D4C1	50
		Soldering	XS2C-D421	
	Angled	Crimping	XS2C-D4C2	
		Soldering	XS2C-D422	
4-mm-dia. model (4 to 5 mm dia.)	Straight	Crimping	XS2C-D4C3	
		Soldering	XS2C-D423	
	Angled	Crimping	XS2C-D4C4	
		Soldering	XS2C-D424	
3-mm-dia. model (3 to 4 mm dia.)	Straight	Crimping	XS2C-D4C5	
		Soldering	XS2C-D425	
	Angled	Crimping	XS2C-D4C6	
		Soldering	XS2C-D426	

Note: Crimping plug contacts are sold separately.

## ■ XS2U (Crimping Pin for XS2C)

### Dimensions

(Unit: mm)

XS2U-222□ (Socket Pin)



### Dimensions

Model	Suitable core size (mm <sup>2</sup> )	Dimension (mm)			No. of slits
		A	B	C	
XS2U-2221	0.18 to 0.3	16.7	6.1	0.8	1
XS2U-2222	0.5 to 0.75	16.8	6.2	1.3	0

Note: A special tool must be used for crimping. For details, refer to the "XS5/XS2 - Assembly Tooling and Accessories" datasheet.

### Ordering Information

Note: Orders are accepted in multiples of the minimum order.

Suitable core size (mm <sup>2</sup> )	Model	Minimum order
0.18 to 0.3	XS2U-2221	100
0.5 to 0.75	XS2U-2222	



## ■ XS2C - Sockets, Screw Terminals

### Dimensions

(Unit: mm)

**XS2C-D5S7 (5-core, Straight, Applicable Cable Outer Diameter: 8 mm)**

**XS2C-D5S9 (5-core, Straight, Applicable Cable Outer Diameter: 7 mm)**

**XS2C-D4S7 (4-core, Straight, Applicable Cable Outer Diameter: 8 mm)**

**XS2C-D4S9 (4-core, Straight, Applicable Cable Outer Diameter: 7 mm)**



**XS2C-D5S1 (5-core, Straight, Applicable Cable Outer Diameter: 6 mm)**

**XS2C-D4S□ (4-core, Straight, Applicable Cable Outer Diameter: 3, 4, or 6 mm)**



**XS2C-D5S2 (5-core, Angled, Applicable Cable Outer Diameter: 6 mm)**

**XS2C-D4S□ (4-core, Angled, Applicable Cable Outer Diameter: 3, 4, or 6 mm)**

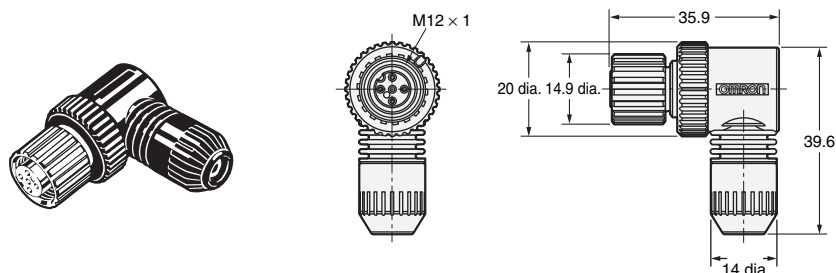

### Ordering Information

No. of poles	Suitable cable dia. (mm)	Straight connectors		Angled connectors		Minimum order
		Model	Model	Model	Model	
5	8-mm-dia. model (7 to 8 mm dia.)	<b>XS2C-D5S7</b>	—	—	—	50
	7-mm-dia. model (6 to 7 mm dia.)	<b>XS2C-D5S9</b>	—	—	—	
	6-mm-dia. model (5 to 6 mm dia.)	<b>XS2C-D5S1</b>	—	<b>XS2C-D5S2</b>	—	
4	8-mm-dia. model (7 to 8 mm dia.)	<b>XS2C-D4S7</b>	—	—	—	
	7-mm-dia. model (6 to 7 mm dia.)	<b>XS2C-D4S9</b>	—	—	—	
	6-mm-dia. model (5 to 6 mm dia.)	<b>XS2C-D4S1</b>	—	<b>XS2C-D4S2</b>	—	
	4-mm-dia. model (4 to 5 mm dia.)	<b>XS2C-D4S3</b>	—	<b>XS2C-D4S4</b>	—	
	3-mm-dia. model (3 to 4 mm dia.)	<b>XS2C-D4S5</b>	—	<b>XS2C-D4S6</b>	—	

## ■ XS2G - Plugs, Crimping / Soldering Terminals

### Dimensions

XS2G-□4C□ (Crimping Model)

XS2G-□42□ (Soldering Model)

Straight

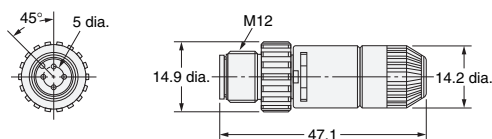
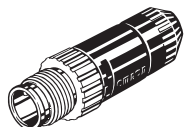

XS2G-D42□ (Soldering Model)

Angled

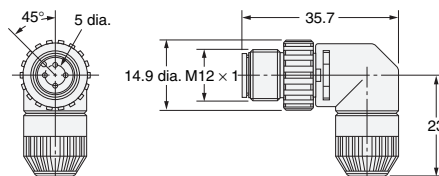
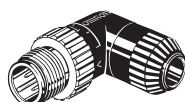

### Ordering Information

Suitable cable dia. (mm)	Cable connection direction	Connection method	Model	Minimum order
6-mm-dia. model (5 to 6 mm dia.)	Straight	Crimping	XS2G-D4C1	50
		Soldering	XS2G-D421	
4-mm-dia. model (4 to 5 mm dia.)	Straight	Crimping	XS2G-D4C3	
		Soldering	XS2G-D423	
	Angled	Soldering	XS2G-D424	
3-mm-dia. model (3 to 4 mm dia.)	Straight	Crimping	XS2G-D4C5	
		Soldering	XS2G-D425	
	Angled	Soldering	XS2G-D426	

Note: Crimping plug contacts are sold separately.

## ■ XS2U (Crimping Pin for XS2G)

### Dimensions

(Unit: mm)

XS2U-312□ (Plug Pin)

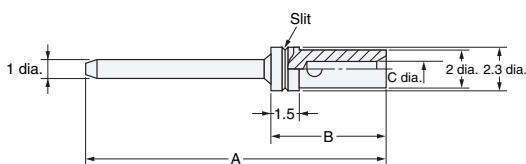

### Dimensions

Model	Suitable core size (mm <sup>2</sup> )	Dimension (mm)			No. of slits
		A	B	C	
XS2U-3121	0.18 to 0.3	20.0	6.1	0.8	1
XS2U-3122	0.5 to 0.75	20.1	6.2	1.3	0

Note: A special tool must be used for crimping. For details, refer to the "XS5/XS2 - Assembly Tooling and Accessories" datasheet.

### Ordering Information

Note: Orders are accepted in multiples of the minimum order.

Suitable core size (mm <sup>2</sup> )	Model	Minimum order
0.18 to 0.3	XS2U-3121	100
0.5 to 0.75	XS2U-3122	

## ■ XS2G - Plugs, Screw Terminals

### Dimensions

(Unit: mm)

**XS2G-D5S7 (5-core, Straight, Applicable Cable Outer Diameter: 8 mm)**

**XS2G-D5S9 (5-core, Straight, Applicable Cable Outer Diameter: 7 mm)**

**XS2G-D4S7 (4-core Straight, Applicable Cable Outer Diameter: 8 mm)**

**XS2G-D4S9 (4-core Straight, Applicable Cable Outer Diameter: 7 mm)**

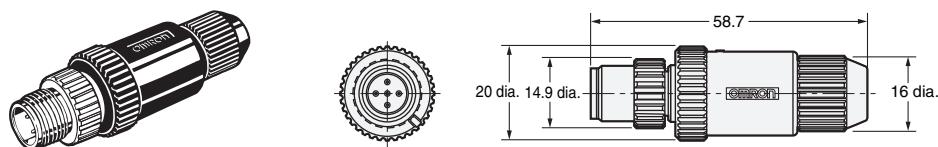

**XS2G-D5S1 (5-core Straight, Applicable Cable Outer Diameter: 6 mm)**

**XS2G-D4S□ (4-core, Straight, Applicable Cable Outer Diameter: 3, 4, or 6 mm)**



**XS2G-D5S2 (5-core, Angled, Applicable Cable Outer Diameter: 6 mm)**

**XS2G-D4S□ (4-core, Angled, Applicable Cable Outer Diameter: 3, 4, or 6 mm)**



### Ordering Information

No. of poles	Suitable cable dia. (mm)	Straight connectors		Angled connectors		Minimum order
		Model		Model		
5	8-mm-dia. model (7 to 8 mm dia.)	XS2G-D5S7		—		50
	7-mm-dia. model (6 to 7 mm dia.)	XS2G-D5S9		—		
	6-mm-dia. model (5 to 6 mm dia.)	XS2G-D5S1		XS2G-D5S2		
4	8-mm-dia. model (7 to 8 mm dia.)	XS2G-D4S7		—		
	7-mm-dia. model (6 to 7 mm dia.)	XS2G-D4S9		—		
	6-mm-dia. model (5 to 6 mm dia.)	XS2G-D4S1		XS2G-D4S2		
	4-mm-dia. model (4 to 5 mm dia.)	XS2G-D4S3		XS2G-D4S4		
	3-mm-dia. model (3 to 4 mm dia.)	XS2G-D4S5		XS2G-D4S6		

**Note:** XS2G Screw terminal Plugs cannot be connected to side by side to the CN1 and CN2 connectors of XS2R Y-Joint Sockets/Plugs.

# Y-Joint 4-Pin Plug/Socket Connectors

## ■ XS2R

### Dimensions

(Unit: mm)

#### XS2R-D426-□11-F

Connectors on Both Cable Ends (Y-Joint Plug/Socket)



#### Wiring Diagram



#### XS2R-D426-□10-F

Connectors on One Cable End (Y-Joint Plug/Socket)

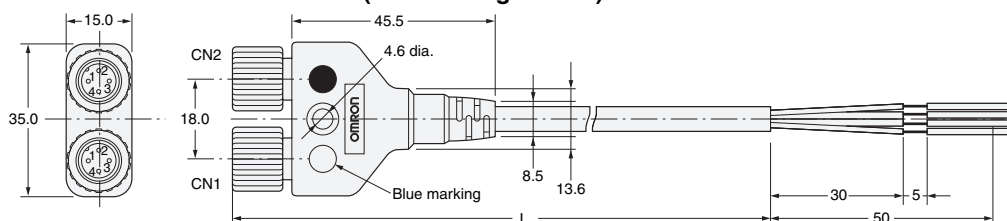

#### Wiring Diagram



#### XS2R-D426-1

Y-Joint Plug/Socket without Cable



#### Wiring Diagram

##### XS2R-D426-1

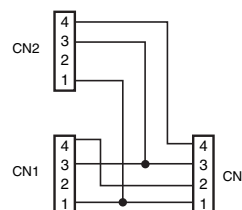

##### XS2R-D426-5

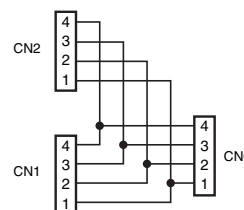

##### XS2R-D426-81

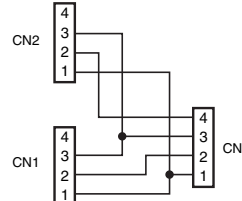

##### XS2R-D426-82

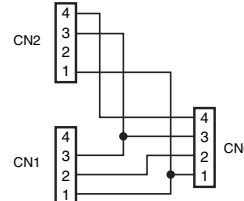

## Ordering Information

Type	Connector	Cable length L (m)	Model	Minimum order
With cable	Connectors on both cable ends	0.5	XS2R-D426-B11-F	5
		1	XS2R-D426-C11-F	
		2	XS2R-D426-D11-F	
		3	XS2R-D426-E11-F	
	Connector on one cable end	2	XS2R-D426-D10-F	
		5	XS2R-D426-G10-F	
Without cable	Y-Joint plug/socket	—	XS2R-D426-1	10
		—	XS2R-D426-5	
		—	XS2R-D426-81	
		—	XS2R-D426-82	

**Note:** XS2G Screw-on Plugs cannot be connected side-by-side to the CN1 and CN2 connectors. Consider using a crimping or soldering model instead.

# T-Joint Plug/Socket Connectors

## ■ XS2R

### Dimensions

XS2R-D422-1  
 XS2R-D422-5  
 Aggregate Models



(Unit: mm)

Wiring Diagram  
 XS2R-D422-1

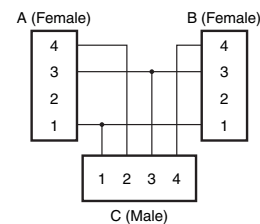

XS2R-D422-5

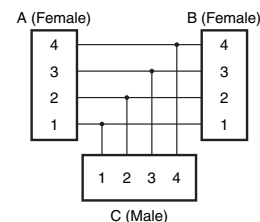

XS2R-D423-1  
 Bifurcated Model



Wiring Diagram

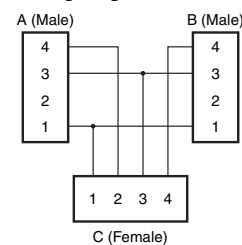

XS2R-D424-1  
 Daisy-chain Model



Wiring Diagram

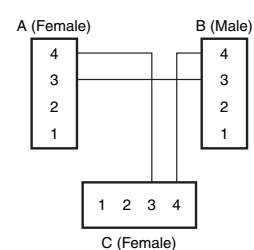

### Ordering Information

Type	Model	Minimum order
Aggregate model	XS2R-D422-1	20
	XS2R-D422-5	
Bifurcated model	XS2R-D423-1	
Daisy-chain model	XS2R-D424-1	

### Safety Precautions

#### ■ Correct Use - XS2R

Do not use this product under ambient conditions that exceed the ratings.  
 Before using the XS2R for Sensors, make sure that the wiring of the Sensors and the internal connections of the XS2R are correct.  
 See the end of this datasheet for XS2R Application examples.  
 See "XS5/XS2 - Assembly Tooling and Accessories" datasheet for information regarding assembly, tooling and accessories that are common to the XS5 and XS2 connectors

# Panel-mount Connectors

## ■ XS2P - Sockets

### Dimensions

(Unit: mm)

**XS2P-D421-2 (with Solder Cup Pins)**  
Rear Lock Model



**XS2P-D422-1 (with Through-hole PCB Pins)**  
**XS2P-D422-2 (with Solder Cup Pins)**  
Front Lock Model

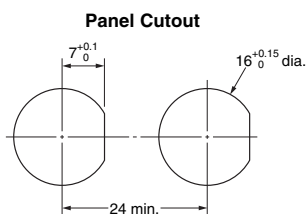

Note: The panel thickness is 1 to 4 mm.

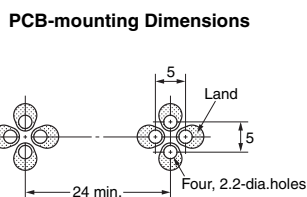

### Ordering Information

Lock method	Pin shape	Model	Minimum order
Rear lock	Solder cup pin	XS2P-D421-2	50
Front lock	Solder cup pin	XS2P-D422-2	
	Through-hole PCB pin	XS2P-D422-1	

## ■ XS2M - Plugs

### Dimensions

(Unit: mm)

**XS2M-D423**  
(Flange-mounting Model)

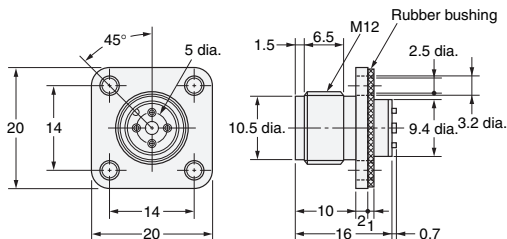
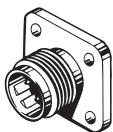

#### Panel Cutouts

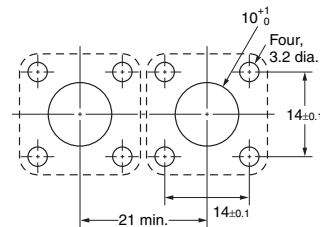

**XS2M-D424-1 (With PCB Pins)**  
**XS2M-D424-2 (With Solder Cup Pins)**  
(Screw-mounting Model)

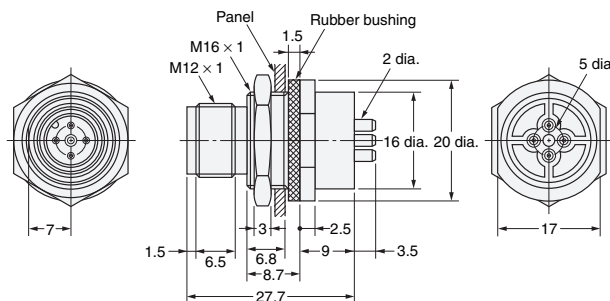
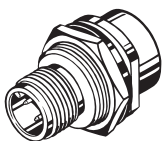

#### Panel Cutouts

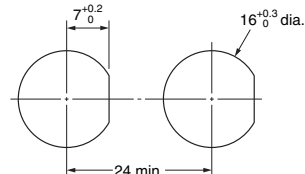

Note: The panel thickness is 1 to 4 mm.

#### PCB-mounting Dimensions

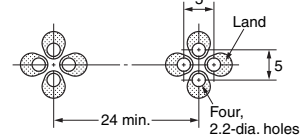

## Connectors for Embedding in Sensors

## ■ XS2M - Plugs

### Dimensions

(Unit: mm)

**XS2M-D421**  
(Embedded Plug with Screw Threads)

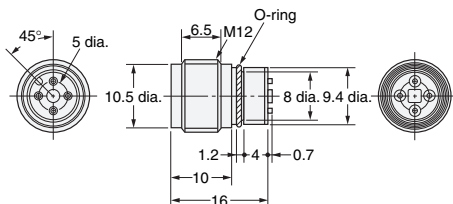

#### Mounted Dimensions



Note: After mounting, anchor the solder cups by injecting resin.

**XS2M-D422**  
(Embedded Plug without Screw Threads)

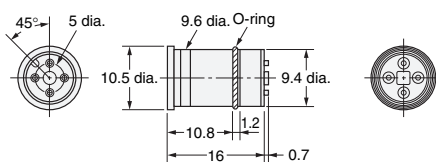

#### Mounted Dimensions

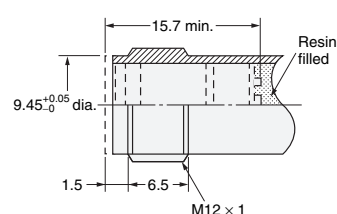

Note: After mounting, anchor the solder cups by injecting resin.

# 8-Pin Connector with Cable Attached/Panel-mount

## ■ XS2 □

### Ordering Information

Connector type	Cable connection direction	Number of cores	Cable length (m)	Model
Panel-mounting socket	—	—	—	XS2P-D821-2
				XS2P-D822-2
Panel-mounting plug				XS2M-D824-4
Plug on one cable end	Straight	8	0.3	XS2H-D821-AH0-C
			1	XS2H-D821-CH0-C
Socket on one cable end			2	XS2F-D821-DH0-C
			5	XS2F-D821-GH0-C
Plug and socket on cable ends			2	XS2W-D821-DH1-C
	5	XS2W-D821-GH1-C		

### Pin Numbers and Cable Lead Colors

XS2F/XS2H/XS2W cable lead colors	Pin number							
	1	2	3	4	5	6	7	8
	White	Brown	Green	Yellow	Gray	Pink	Blue	Shield

### Wiring Example





**Dimensions**

**XS2H Plug on One Cable End (M12)**

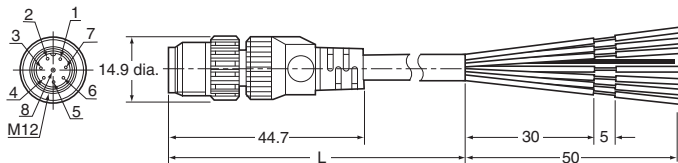
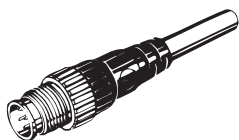

**XS2F Socket on One Cable End (M12)**

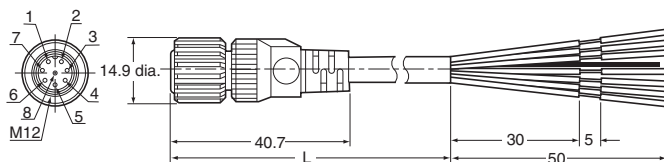
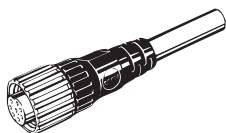

**XS2W Plug and Socket on Cable Ends (M12)**

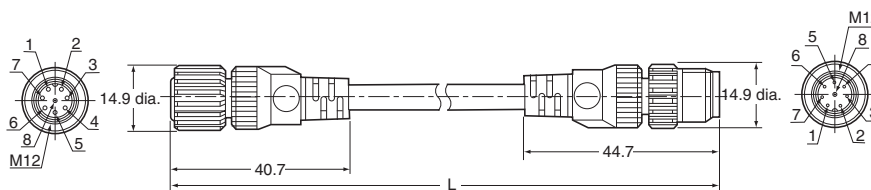
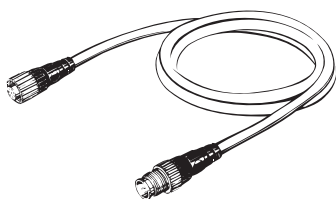

**XS2P-D821-2 Panel-mounting Socket (M12) with Solder Cup Pins and Rear Lock**

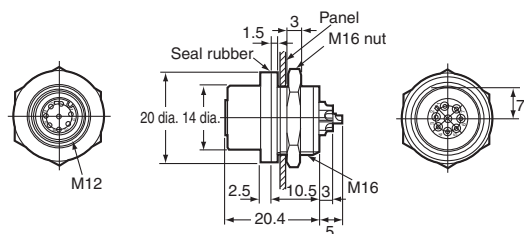

**XS2M-D824-4 Panel-mounting Plug (M12) with Solder Cup Pins and Front Lock**

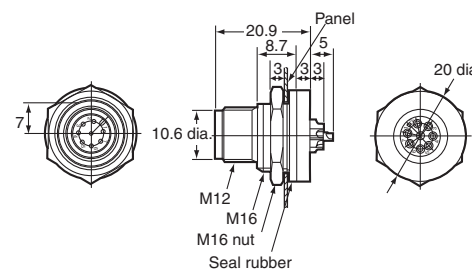

**XS2P-D822-2 Panel-mounting Socket (M12) with Solder Cup Pins and Front Lock**

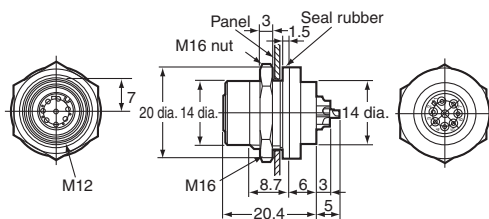

**Panel Cutouts**

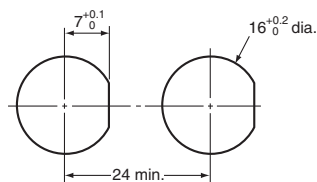

**Connector Pin Numbers (from Mating Side)**

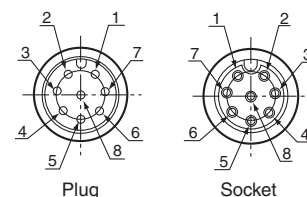

- Note:** 1. Mounting panel thickness: 1 to 4 mm.
- 2. Applicable core wire size for solder cup pins: 0.5 mm<sup>2</sup> max.
- 3. The M16 nut and seal rubber are included.

**Ordering Information**

Mounting method	Pin shape	Model	Minimum order
Embedded with screw threads	Solder cup pin	XS2M-D421	50
Embedded with no screw threads		XS2M-D422	
Flange-mounting		XS2M-D423	
Screw-mounting	Through-hole PCB pin	XS2M-D424-1	
	Solder cup pin	XS2M-D424-2	

# XS2R Application Examples

## XS2R-D422-1 (Aggregate Model)



- A pair of Two-wire Sensors or Three-wire Sensors can be connected as shown in the illustration.
- The XS2R-D422-5 has feedthrough connections, thus working as a connector for the extension cable.



## XS2R-D423-1 (Bifurcated Model)



- Two or Three-wire Sensor signals can be bifurcated.



## XS2R-D424-1 (Daisy Chain Model)

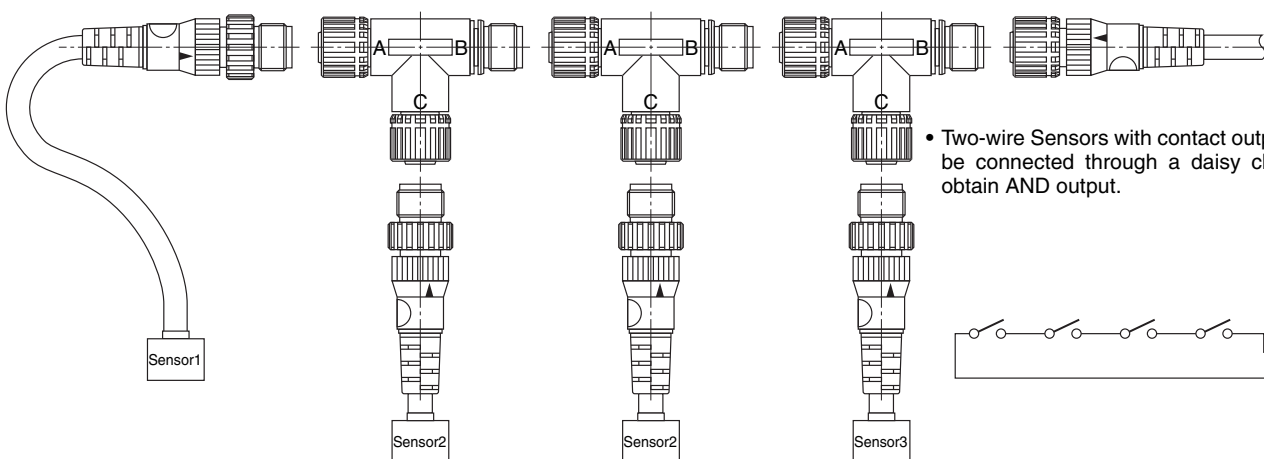

- Two-wire Sensors with contact output can be connected through a daisy chain to obtain AND output.

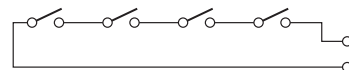

# List of XS2 Products - Summary

Name	Model		Appearance
<b>1.Connectors attached to Cable</b>	XS2W Sockets and Plugs on Cable Ends		
	XS2F Sockets on One Cable End		
	XS2H Plugs on One Cable End		
<b>2.Connector Assemblies (Crimping, Soldering, or Screw-on)</b>  Used to enable using connectors for sensor cables and relay cables.	XS2G Plug Assemblies		
	XS2C Socket Assemblies		
	XY2F Crimp Tool (for Crimping Connectors)		
	XW4Z Screwdriver (for Screw-on Connectors)		
<b>3.Terminal Box Connectors</b>  Used to enable using connectors for terminal boxes.	XS2P Panel-mounting Sockets		
<b>4.T-Joints and Y-Joints</b>  Used for branching and for daisy-chain connections.	XS2R T-Joint/Y-Joint Plug/Socket Connectors	T-Joints	
		Y-Joints	
<b>5.Sensor Connector Assemblies</b>  Used to enable using connectors in sensors.	XS2M Plugs	Embedded Plugs with Screw Threads	
		Embedded Plugs with No Screw Threads	
<b>6. Panel-mounting Connectors</b>  Used to enable using I/O box connectors mounted to panels.	XS2M Plugs	Flange-mounting Plugs	
		Screw-mounting Plugs	

**Note:** 1. See "XS5/XS2 - Assembly Tooling and Accessories" datasheet for information regarding assembly, tooling and accessories that are common to the XS5 and XS2 connectors  
 2. See "XS5" datasheet for specifics regarding those connectors

All sales are subject to Omron Electronic Components LLC standard terms and conditions of sale, which can be found at [http://www.components.omron.com/components/web/webfiles.nsf/sales\\_terms.html](http://www.components.omron.com/components/web/webfiles.nsf/sales_terms.html)

**ALL DIMENSIONS SHOWN ARE IN MILLIMETERS.**

To convert millimeters into inches, multiply by 0.03937. To convert grams into ounces, multiply by 0.03527.

---

**OMRON**<sup>®</sup>

**OMRON ELECTRONIC  
COMPONENTS LLC**

55 E. Commerce Drive, Suite B  
Schaumburg, IL 60173

**847-882-2288**

**OMRON ON-LINE**

Global - <http://www.omron.com>

USA - <http://www.components.omron.com>

Cat. No. X304-E-1c

08/12

Specifications subject to change without notice

Printed in USA

Компания «Океан Электроники» предлагает заключение долгосрочных отношений при поставках импортных электронных компонентов на взаимовыгодных условиях!

Наши преимущества:

- Поставка оригинальных импортных электронных компонентов напрямую с производств Америки, Европы и Азии, а так же с крупнейших складов мира;
- Широкая линейка поставок активных и пассивных импортных электронных компонентов (более 30 млн. наименований);
- Поставка сложных, дефицитных, либо снятых с производства позиций;
- Оперативные сроки поставки под заказ (от 5 рабочих дней);
- Экспресс доставка в любую точку России;
- Помощь Конструкторского Отдела и консультации квалифицированных инженеров;
- Техническая поддержка проекта, помощь в подборе аналогов, поставка прототипов;
- Поставка электронных компонентов под контролем ВП;
- Система менеджмента качества сертифицирована по Международному стандарту ISO 9001;
- При необходимости вся продукция военного и аэрокосмического назначения проходит испытания и сертификацию в лаборатории (по согласованию с заказчиком);
- Поставка специализированных компонентов военного и аэрокосмического уровня качества (Xilinx, Altera, Analog Devices, Intersil, Interpoint, Microsemi, Actel, Aeroflex, Peregrine, VPT, Syfer, Eurofarad, Texas Instruments, MS Kennedy, Miteq, Cobham, E2V, MA-COM, Hittite, Mini-Circuits, General Dynamics и др.);

Компания «Океан Электроники» является официальным дистрибьютором и эксклюзивным представителем в России одного из крупнейших производителей разъемов военного и аэрокосмического назначения «JONHON», а так же официальным дистрибьютором и эксклюзивным представителем в России производителя высокотехнологичных и надежных решений для передачи СВЧ сигналов «FORSTAR».



## JONHON

«JONHON» (основан в 1970 г.)

Разъемы специального, военного и аэрокосмического назначения:

(Применяются в военной, авиационной, аэрокосмической, морской, железнодорожной, горно- и нефтедобывающей отраслях промышленности)

«FORSTAR» (основан в 1998 г.)

ВЧ соединители, коаксиальные кабели,  
кабельные сборки и микроволновые компоненты:

(Применяются в телекоммуникациях гражданского и специального назначения, в средствах связи, РЛС, а так же военной, авиационной и аэрокосмической отраслях промышленности).



Телефон: 8 (812) 309-75-97 (многоканальный)

Факс: 8 (812) 320-03-32

Электронная почта: [ocean@oceanchips.ru](mailto:ocean@oceanchips.ru)

Web: <http://oceanchips.ru/>

Адрес: 198099, г. Санкт-Петербург, ул. Калинина, д. 2, корп. 4, лит. А