

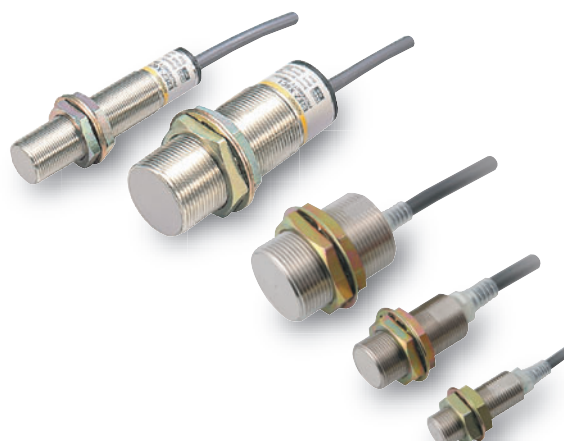

Chip-immune Inductive Proximity Sensor

- Correct operation even with aluminum or iron chips sticking to the Sensor.
Only the sensing object is detected.
- Pre-wired Smartclick Connector Models also available.



 Be sure to read *Safety Precautions* on page 7.

Ordering Information

Sensors [Refer to *Dimensions* on page 8.]
Pre-wired Models

Appearance	Sensing distance	Output configuration	Model		
			Operation mode		
			NO	NC	
	M12	2 mm	DC 2-Wire Models	E2EZ-X2D1-N 2M	E2EZ-X2D2-N 2M
			DC 3-wire, NPN	E2EZ-X4C1 2M	—
	M18	4 mm	DC 2-wire	E2EZ-X4D1-N 2M	E2EZ-X4D2-N 2M
			AC 2-wire	E2EZ-X4Y1 2M	—
			DC 3-wire, NPN	E2EZ-X8C1 2M	—
	M30	8 mm	DC 2-wire	E2EZ-X8D1-N 2M	E2EZ-X8D2-N 2M
			AC 2-wire	E2EZ-X8Y1 2M	—

Pre-wired Smartclick Connector Models (M12)

Appearance	Sensing distance	Output configuration	Model		
			Operation mode		
			NO	NC	
	M12	2 mm	DC 2-wire, (3)-(4) pin arrangement	E2EZ-X2D1-M1TJ 0.3M	—
			DC 2-wire, (1)-(4) pin arrangement	E2EZ-X2D1-M1TGJ 0.3M	—
	M18	4 mm	DC 2-wire, (3)-(4) pin arrangement	E2EZ-X4D1-M1TJ 0.3M	—
			DC 2-wire, (1)-(4) pin arrangement	E2EZ-X4D1-M1TGJ 0.3M	—
	M30	8 mm	DC 2-wire, (3)-(4) pin arrangement	E2EZ-X8D1-M1TJ 0.3M	—
			DC 2-wire, (1)-(4) pin arrangement	E2EZ-X8D1-M1TGJ 0.3M	—





Pre-wired Connector Models (M12)

Appearance	Sensing distance			Output configuration	Model	
					Operation mode	
					NO	NC
	M12	2 mm		DC 2-wire, (3)-(4) pin arrangement	E2EZ-X2D1-M1J 0.3M	—
				DC 2-wire, (1)-(4) pin arrangement	E2EZ-X2D1-M1GJ 0.3M	—
	M18	4 mm		DC 2-wire, (3)-(4) pin arrangement	E2EZ-X4D1-M1J 0.3M	—
				DC 2-wire, (1)-(4) pin arrangement	E2EZ-X4D1-M1GJ 0.3M	—
	M30	8 mm		DC 2-wire, (3)-(4) pin arrangement	E2EZ-X8D1-M1J 0.3M	—
				DC 2-wire, (1)-(4) pin arrangement	E2EZ-X8D1-M1GJ 0.3M	—

Accessories (Order Separately)

Sensor I/O Connectors (M12)

(Models for Pre-wired Connectors: A Connector is not provided with the Sensor. Be sure to order a Connector separately.) [Refer to Dimensions on XS2, XS5.]

Appearance	Cable length	Sensor I/O Connector model number	Applicable Proximity Sensor model number
Straight 	2 m	XS2F-D421-DD0	E2EZ-X□D1-M1J
	5 m	XS2F-D421-GD0	
L-shape 	2 m	XS2F-D422-DD0	
	5 m	XS2F-D422-GD0	
Straight 	2 m	XS2F-D421-DA0-A	E2EZ-X□D1-M1GJ
	5 m	XS2F-D421-GA0-A	
L-shape 	2 m	XS2F-D422-DA0-A	
	5 m	XS2F-D422-GA0-A	
Smartclick Connector Straight 	2 m	XS5F-D421-D80-A	E2EZ-X□D1-M1TJ E2EZ-X□D1-M1TGJ
	5 m	XS5F-D421-G80-A	

Mounting Brackets

Protective Covers

Sputter Protective Covers

Refer to Y92□ for details.

Ratings and Specifications

Model		E2EZ-X2D□-N E2EZ-X2D□-M1J E2EZ-X2D□-M1GJ	E2EZ-X4D□-N E2EZ-X4D□-M1J E2EZ-X4D□-M1GJ	E2EZ-X8D□-N E2EZ-X8D□-M1J E2EZ-X8D□-M1GJ	E2EZ-X4C1 E2EZ-X4Y1	E2EZ-X8C1 E2EZ-X8Y1
Item						
Sensing distance		2 mm ±10%	4 mm ±10%	8 mm ±10%	4 mm ±10%	8 mm ±10%
Set distance ^{*1}		0 to 1.6 mm	0 to 3.2 mm	0 to 6.4 mm	0 to 3.2 mm	0 to 6.4 mm
Differential travel		20% max. of sensing distance				
Detectable object		Ferrous metal (The sensing distance decreases with non-ferrous metal. Refer to <i>Engineering Data</i> on page 4.)				
Standard sensing object		Iron, 12 × 12 × 1 mm	Iron, 30 × 30 × 1 mm	Iron, 54 × 54 × 1 mm	Iron, 30 × 30 × 1 mm	Iron, 54 × 54 × 1 mm
Response frequency ^{*2}		200 Hz	100 Hz	30 Hz	C Models: 12 Hz Y Models: 5 Hz	C Models: 8 Hz Y Models: 5 Hz
Power supply voltage (operating voltage range)		12 to 24 VDC (10 to 30 VDC), ripple (p-p): 10% max.			C Models: 12 to 24 VDC (10 to 30 VDC), ripple (p-p): 10% max. Y Models: 100 to 220 VAC (90 to 250 VAC), 50/60 Hz	
Current consumption		---			C Models: 15 mA max.	
Leakage current		0.8 mA max.			Y Models: 2 mA max. at 100 VAC, 3 mA max. at 200 VAC	
Control output	Load current	3 to 100 mA max.			C Models: NPN open-collector output 100 mA max. at 12 VDC (30 VDC max.) 200 mA max. at 24 VDC (30 VDC max.) Y Models: 10 to 200 mA	
	Residual voltage	3 V max. (Load current: 100 mA, Cable length: 2 m)			C Models: 2 V max. (Load current: 200 mA, Cable length: 2 m) Y Models: Refer to residual voltage characteristic data Refer to page 4.	
Indicators		D1 Models: Operation indicator (red), Setting indicator (green) D2 Models: Operation indicator (red)			C Models: Detection indicator (red) Y Models: Operation indicator (red)	
Operation mode (with sensing object approaching)		D1 Models: NO D2 Models: NC For details, refer to the <i>Timing chart</i> on page 5.			NO For details, refer to the <i>Timing chart</i> on page 6.	
Protection circuits		Load short-circuit protection, Surge suppressor			C Models: Load short-circuit protection, Reverse polarity protection, Surge suppressor Y Models: Surge suppressor	
Ambient temperature range		Operating/Storage: 0 to 50°C (with no icing or condensation)				
Ambient humidity range		Operating/Storage: 35% to 95% (with no condensation)				
Temperature influence		±20% max. of sensing distance at 23°C in the temperature range of 0 to 50°C				
Voltage influence		±2.5% max. of sensing distance at rated voltage in the rated voltage ±10% range				
Insulation resistance		50 MΩ min. (at 500 VDC) between current-carrying parts and case				
Dielectric strength		1,000 VAC, 50/60 Hz for 1 minute between current-carrying parts and case			C Models: 1,000 VAC, 50/60 Hz for 1 min between current-carrying parts and case Y Models: 2,000 VAC, 50/60 Hz for 1 min between current-carrying parts and case	
Vibration resistance		Destruction: 10 to 55 Hz, 1.5-mm double amplitude for 2 hours each in X, Y, and Z directions				
Shock resistance		Destruction: 1,000 m/s ² 10 times each in X, Y, and Z directions				
Degree of protection		IEC 60529 IP67, in-house standards: oil-resistant				
Connection method		Pre-wired Models (Standard cable length: 2 m) and Pre-wired Connector Models				
Weight (packed state)		E2EZ-X2D□-N: Approx. 70 g E2EZ-X2D□-M1J: Approx. 40 g E2EZ-X2D□-M1GJ: Approx. 40 g	E2EZ-X4D□-N: Approx. 160 g E2EZ-X4D□-M1J: Approx. 90 g E2EZ-X4D□-M1GJ: Approx. 90 g	E2EZ-X8D□-N: Approx. 220 g E2EZ-X8D□-M1J: Approx. 160 g E2EZ-X8D□-M1GJ: Approx. 160 g	Approx. 170 g	Approx. 270 g
Materials	Case	Nickel-plated brass				
	Sensing surface	PBT			Heat-resistant ABS	
	Clamping nuts	Zinc-plated iron				
	Toothed washer	Zinc-plated iron				
Accessories		Instruction manual				

*1. Use the Sensor within the range in which the green indicator is ON.

*2. The response frequency is an average value. Measurement conditions are as follows: standard sensing object, a distance of twice the standard sensing object, and a set distance of half the sensing distance.

Engineering Data (Typical)

Sensing Area

E2EZ-X2

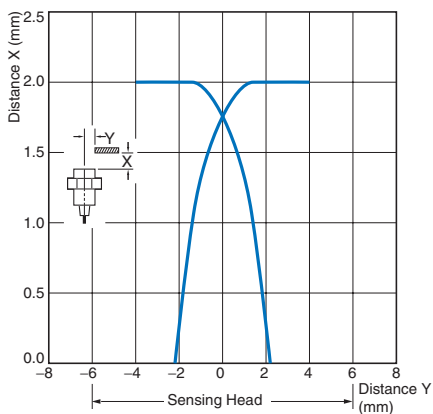

E2EZ-X4

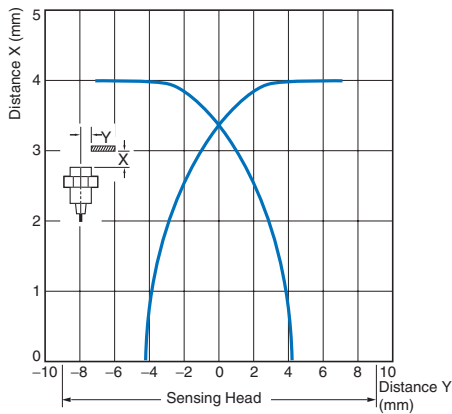

E2EZ-X8

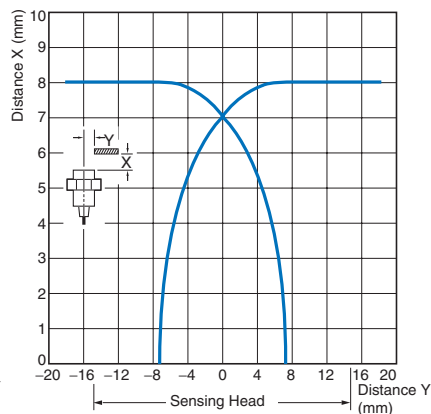

Influence of Sensing Object Size and Material

E2EZ-X2

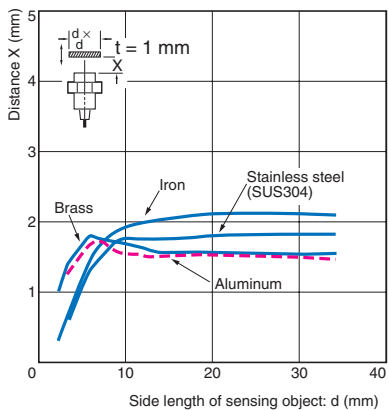

E2EZ-X4

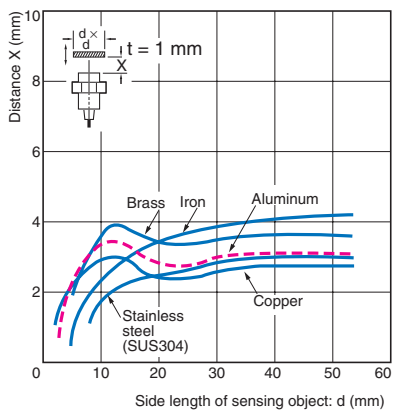

E2EZ-X8

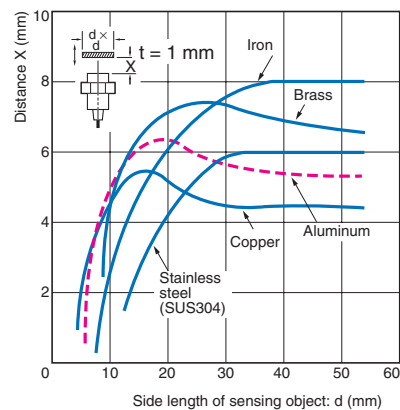

Residual Output Voltage

E2EZ-X□D□-N

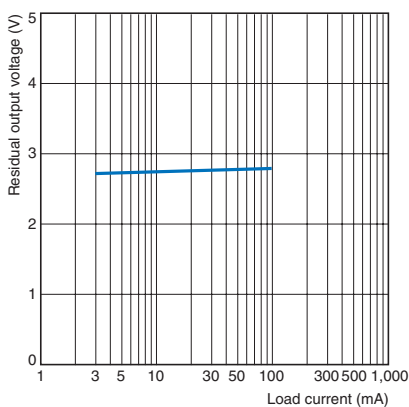

E2EZ-X4Y1/-X8Y1 at 100 VAC

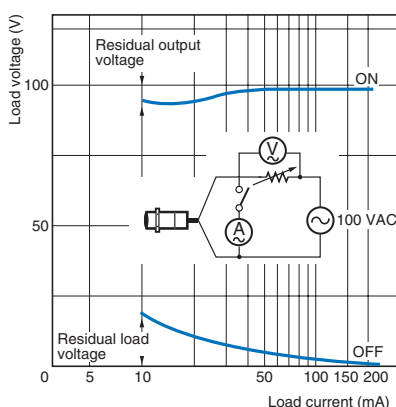

E2EZ-X4Y1/-X8Y1 at 200 VAC

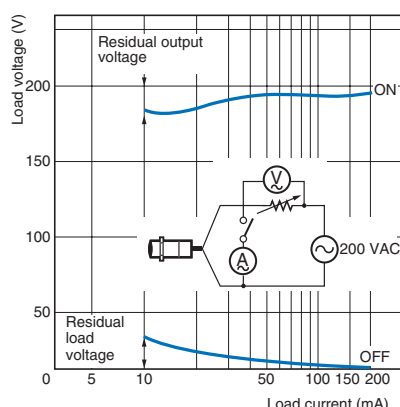

Leakage Current

E2EZ-X4Y1/-X8Y1

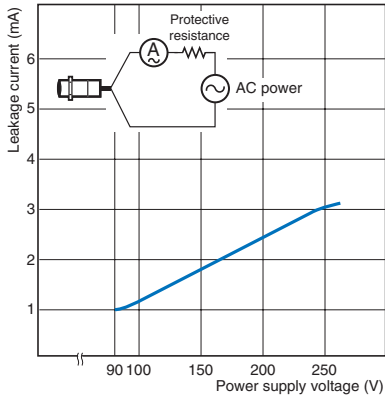

E2EZ-X□D□-N

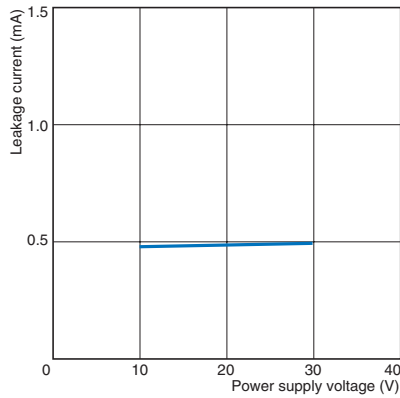

I/O Circuit Diagrams

DC 2-Wire Models

Operation mode	Model	Timing chart	Output circuit
NO	E2EZ-X2D1-N E2EZ-X4D1-N E2EZ-X8D1-N	<p>Non-sensing area Unstable sensing area Stable sensing area</p> <p>Set position</p> <p>Sensing object (%)</p> <p>Rated sensing distance: 100, 80(TYP), 0</p>	<p>Note: The load can be connected to either the +V or 0 V side.</p>
	E2EZ-X2D1-M1J E2EZ-X2D1-M1GJ E2EZ-X4D1-M1J E2EZ-X4D1-M1GJ E2EZ-X8D1-M1J E2EZ-X8D1-M1GJ	<p>ON Setting indicator (green)</p> <p>OFF Operation indicator (red)</p> <p>ON Control output</p> <p>OFF</p>	<p>(M1J) Connector Pin Arrangement: Note: Pins 1 and 2 are not used.</p> <p>(M1GJ) Connector Pin Arrangement: Note: Pins 2 and 3 are not used.</p> <p>Note: The load can be connected to either the +V or 0 V side.</p>
NC	E2EZ-X2D2-N E2EZ-X4D2-N E2EZ-X8D2-N	<p>Non-sensing area Sensing area</p> <p>Sensing object (%)</p> <p>Rated sensing distance: 100, 0</p> <p>ON Operation indicator (Red)</p> <p>OFF Control output</p> <p>ON</p> <p>OFF</p>	<p>Note: The load can be connected to either the +V or 0 V side.</p>

DC 3-wire Models

Operation mode	Model	Timing chart	Output circuit
NO	E2EZ-X4C1 E2EZ-X8C1	<p>Sensing object: Present (high), Not present (low)</p> <p>Load: Operate (high), Reset (low)</p> <p>Detection indicator (red): ON (high), OFF (low)</p>	<p>* 100 mA max. at 12 V, 200 mA max. at 24 V (load current).</p>

AC 2-Wire Models

Operation mode	Model	Timing chart	Output circuit
NO	E2EZ-X4Y1 E2EZ-X8Y1	<p>Sensing object: Present (high), Not present (low)</p> <p>Load: Operate (high), Reset (low)</p> <p>Operation indicator (red): ON (high), OFF (low)</p>	

Connections for Sensor I/O Connectors

Proximity Sensor		Sensor I/O Connectors		Connections
Model	Operation mode	Model	Model	
DC 2-Wire Models (IEC pin wiring)	NO	E2EZ-X□D1-M1GJ	XS2F-D42□-□A0-A 1: Straight 2: L-shape D: 2-m cable G: 5-m cable	
DC 2-Wire Models (previous pin wiring)		E2EZ-X□D1-M1J	XS2F-D42□-□D0 1: Straight 2: L-shape D: 2-m cable G: 5-m cable	
DC 2-Wire Models (IEC pin wiring)		E2EZ-X□D1-M1TGJ	XS5F-D421-□80-A D: 2-m cable G: 5-m cable	
DC 2-Wire Models (previous pin wiring)		E2EZ-X□D1-M1TJ		

Refer to the *Sensor I/O Connector Group Catalog* (Cat. No. X073) for details.

Safety Precautions

Refer to *Warranty and Limitations of Liability*.

⚠ WARNING

This product is not designed or rated for ensuring safety of persons either directly or indirectly. Do not use it for such purposes.



Precautions for Correct Use

Do not use this product under ambient conditions that exceed the ratings.

● Design

Influence of Surrounding Metal

When mounting the Sensor within a metal panel, ensure that the clearances given in the following table are maintained. Failure to maintain these distances may cause deterioration in the performance of the Sensor.

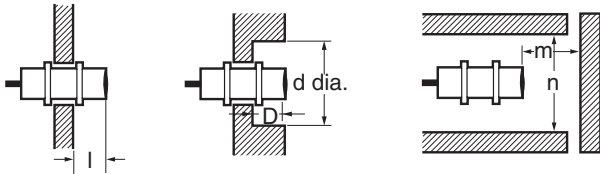

Influence of Surrounding Metal (Unit: mm)

Model	Item Embedded material	l	d	D	m	n
E2EZ-X2□	Iron	0	12	0	8	18
	Aluminum	2	25	2		36
E2EZ-X4□	Iron	0	18	0	16	27
	Aluminum	5	40	5		54
E2EZ-X8□	Iron	0	30	0	32	45
	Aluminum	10	70	10		90

Mutual Interference

When installing Sensors face-to-face or side-by-side, ensure that the minimum distances given in the following table are maintained.

Mutual Interference (Unit: mm)

Model	Item	A	B
E2EZ-X2□		30	20
E2EZ-X4□		40	50
E2EZ-X8□		60	100

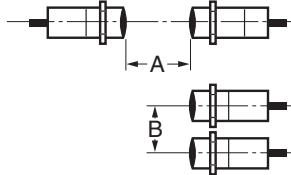

Aluminum and Iron Cuttings

Normally aluminum or iron cuttings will not be detected even if they adhere to or accumulate on the sensing surface.

Detection signals may be output for the following:

If this occurs, remove the cuttings from the sensing surface.

1. Relationship between the Size of the Cutting (d) and the Size of the Sensing Surface (D)

Cuttings of the size $d \geq \frac{2}{3}D$ on the sensing surface *

Cuttings of the size d* (Unit: mm)

Model	Size	D
E2EZ-X2□		10*
E2EZ-X4□		16
E2EZ-X8□		28

* E2EZ-X2□: $d \geq \frac{1}{3}D$ on the sensing surface.

2. Cuttings Pressed against the Sensing Surface

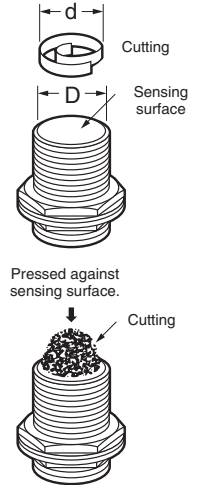

● Mounting

Do not tighten the nut with excessive force.

A washer must be used with the nut.

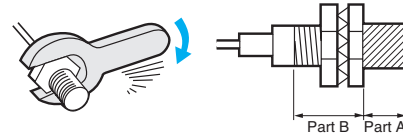

Note: 1. The allowable tightening strength depends on the distance from the edge of the head, as shown in the following table. (A is the distance from the edge of the head. B includes the nut on the head side. If the edge of the nut is in part A, the tightening torque for part A applies instead.)

2. The following torque assume washers are being used.

Model	Tightening Torque	
	Part A	Part B
E2EZ-X2D□-□	Dimension (mm)	Torque
E2EZ-X4D□-□	20	15 N·m
E2EZ-X8D□-□	22	29 N·m
E2EZ-X4C1		
E2EZ-X4Y1		
E2EZ-X8C1		
E2EZ-X8Y1		

Dimensions

Tolerance class IT16 applies to dimensions in this data sheet unless otherwise specified.

E2EZ-X2D□-N

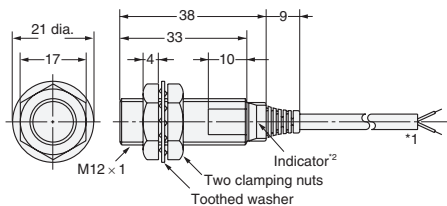

*1. 4-dia. vinyl-insulated round cable with 2 conductors (Conductor cross section: 0.3 mm², Insulator diameter: 1.3 mm), Standard length: 2 m
 *2. D1 Models: Operation indicator (red), Setting indicator (green), D2 Models: Operation indicator (red)

Pre-wired Connector Models (-M1J/M1GJ)

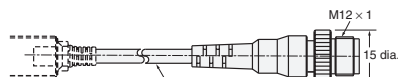

4-dia. vinyl-insulated round cable with 2 conductors (Conductor cross section: 0.3 mm², Insulator diameter: 1.3 mm), Standard length: 300 mm

E2EZ-X4D□-N

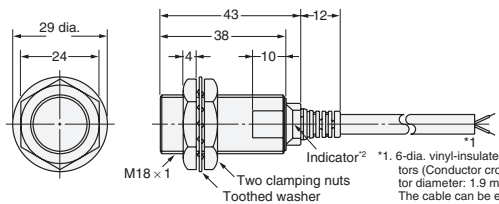

*1. 6-dia. vinyl-insulated round cable with 2 conductors (Conductor cross section: 0.5 mm², Insulator diameter: 1.9 mm), Standard length: 2 m
 The cable can be extended up to 200 m (separate metal conduit).
 *2. D1 Models: Operation indicator (red), Setting indicator (green)
 D2 Models: Operation indicator (red)

E2EZ-X8D□-N

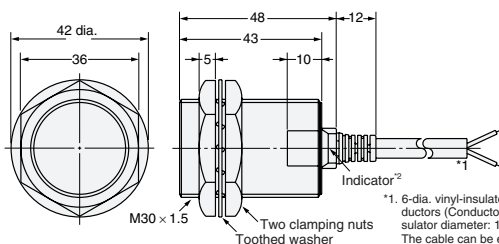

*1. 6-dia. vinyl-insulated round cable with 2 conductors (Conductor cross section: 0.5 mm², Insulator diameter: 1.9 mm), Standard length: 2 m
 The cable can be extended up to 200 m (separate metal conduit).
 *2. D1 Models: Operation indicator (red), Setting indicator (green)
 D2 Models: Operation indicator (red)

Pre-wired Connector Models (-M1J/M1GJ)

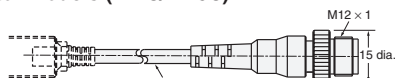

6-dia. vinyl-insulated round cable with 2 conductors (Conductor cross section: 0.5 mm², Insulator diameter: 1.9 mm), Standard length: 300 mm

Pre-wired Connector Models (-M1J/M1GJ)



6-dia. vinyl-insulated round cable with 2 conductors (Conductor cross section: 0.5 mm², Insulator diameter: 1.9 mm), Standard length: 300 mm

E2EZ-X4C1 E2EZ-X4Y1

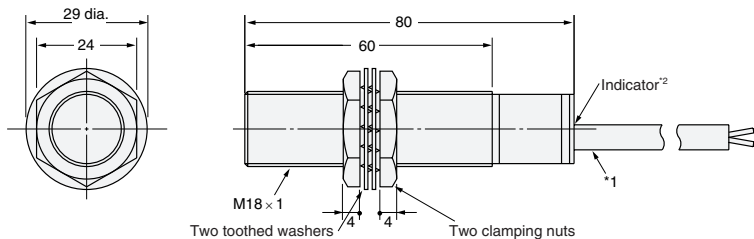
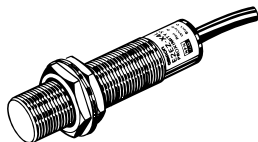

*1. C Models: 6-dia. vinyl-insulated round cable with 3 conductors (Conductor cross section: 0.5 mm², Insulator diameter: 1.9 mm), Standard length: 2 m
 Y Models: 6-dia. vinyl-insulated round cable with 2 conductors (Conductor cross section: 0.5 mm², Insulator diameter: 1.9 mm), Standard length: 2 m
 *2. C Models: Detection indicator (red), Y Models: Operation indicator (red)

E2EZ-X8C1 E2EZ-X8Y1

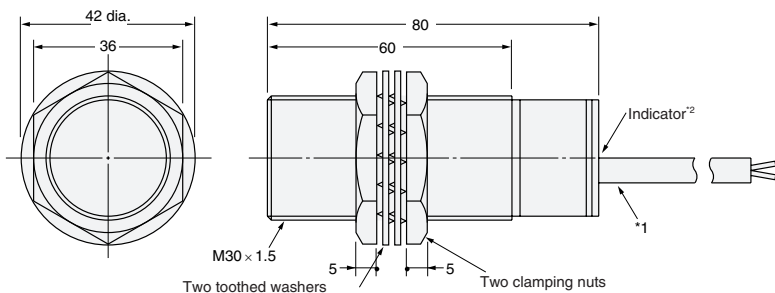
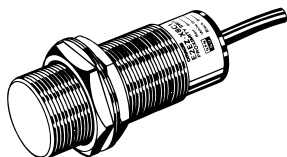

*1. C Models: 6-dia. vinyl-insulated round cable with 3 conductors (Conductor cross section: 0.5 mm², Insulator diameter: 1.9 mm), Standard length: 2 m
 Y Models: 6-dia. vinyl-insulated round cable with 2 conductors (Conductor cross section: 0.5 mm², Insulator diameter: 1.9 mm), Standard length: 2 m
 *2. C Models: Detection indicator (red), Y Models: Operation indicator (red)

Mounting Hole Dimensions

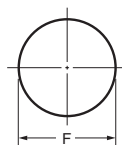

Model	F (mm)
E2EZ-X2□	12.5 dia. ^{+0.5} / ₋₀
E2EZ-X4□	18.5 dia. ^{+0.5} / ₋₀
E2EZ-X8□	30.5 dia. ^{+0.5} / ₋₀

Read and Understand This Catalog

Please read and understand this catalog before purchasing the products. Please consult your OMRON representative if you have any questions or comments.

Warranty and Limitations of Liability

WARRANTY

OMRON's exclusive warranty is that the products are free from defects in materials and workmanship for a period of one year (or other period if specified) from date of sale by OMRON.

OMRON MAKES NO WARRANTY OR REPRESENTATION, EXPRESS OR IMPLIED, REGARDING NON-INFRINGEMENT, MERCHANTABILITY, OR FITNESS FOR PARTICULAR PURPOSE OF THE PRODUCTS. ANY BUYER OR USER ACKNOWLEDGES THAT THE BUYER OR USER ALONE HAS DETERMINED THAT THE PRODUCTS WILL SUITABLY MEET THE REQUIREMENTS OF THEIR INTENDED USE. OMRON DISCLAIMS ALL OTHER WARRANTIES, EXPRESS OR IMPLIED.

LIMITATIONS OF LIABILITY

OMRON SHALL NOT BE RESPONSIBLE FOR SPECIAL, INDIRECT, OR CONSEQUENTIAL DAMAGES, LOSS OF PROFITS OR COMMERCIAL LOSS IN ANY WAY CONNECTED WITH THE PRODUCTS, WHETHER SUCH CLAIM IS BASED ON CONTRACT, WARRANTY, NEGLIGENCE, OR STRICT LIABILITY.

In no event shall the responsibility of OMRON for any act exceed the individual price of the product on which liability is asserted.

IN NO EVENT SHALL OMRON BE RESPONSIBLE FOR WARRANTY, REPAIR, OR OTHER CLAIMS REGARDING THE PRODUCTS UNLESS OMRON'S ANALYSIS CONFIRMS THAT THE PRODUCTS WERE PROPERLY HANDLED, STORED, INSTALLED, AND MAINTAINED AND NOT SUBJECT TO CONTAMINATION, ABUSE, MISUSE, OR INAPPROPRIATE MODIFICATION OR REPAIR.

Application Considerations

SUITABILITY FOR USE

OMRON shall not be responsible for conformity with any standards, codes, or regulations that apply to the combination of products in the customer's application or use of the products.

At the customer's request, OMRON will provide applicable third party certification documents identifying ratings and limitations of use that apply to the products. This information by itself is not sufficient for a complete determination of the suitability of the products in combination with the end product, machine, system, or other application or use.

The following are some examples of applications for which particular attention must be given. This is not intended to be an exhaustive list of all possible uses of the products, nor is it intended to imply that the uses listed may be suitable for the products:

- Outdoor use, uses involving potential chemical contamination or electrical interference, or conditions or uses not described in this catalog.
- Nuclear energy control systems, combustion systems, railroad systems, aviation systems, medical equipment, amusement machines, vehicles, safety equipment, and installations subject to separate industry or government regulations.
- Systems, machines, and equipment that could present a risk to life or property.

Please know and observe all prohibitions of use applicable to the products.

NEVER USE THE PRODUCTS FOR AN APPLICATION INVOLVING SERIOUS RISK TO LIFE OR PROPERTY WITHOUT ENSURING THAT THE SYSTEM AS A WHOLE HAS BEEN DESIGNED TO ADDRESS THE RISKS, AND THAT THE OMRON PRODUCTS ARE PROPERLY RATED AND INSTALLED FOR THE INTENDED USE WITHIN THE OVERALL EQUIPMENT OR SYSTEM.

PROGRAMMABLE PRODUCTS

OMRON shall not be responsible for the user's programming of a programmable product, or any consequence thereof.

Disclaimers

CHANGE IN SPECIFICATIONS

Product specifications and accessories may be changed at any time based on improvements and other reasons.

It is our practice to change model numbers when published ratings or features are changed, or when significant construction changes are made. However, some specifications of the products may be changed without any notice. When in doubt, special model numbers may be assigned to fix or establish key specifications for your application on your request. Please consult with your OMRON representative at any time to confirm actual specifications of purchased products.

DIMENSIONS AND WEIGHTS

Dimensions and weights are nominal and are not to be used for manufacturing purposes, even when tolerances are shown.

PERFORMANCE DATA

Performance data given in this catalog is provided as a guide for the user in determining suitability and does not constitute a warranty. It may represent the result of OMRON's test conditions, and the users must correlate it to actual application requirements. Actual performance is subject to the OMRON Warranty and Limitations of Liability.

ERRORS AND OMISSIONS

The information in this document has been carefully checked and is believed to be accurate; however, no responsibility is assumed for clerical, typographical, or proofreading errors, or omissions.

2010.8

In the interest of product improvement, specifications are subject to change without notice.

OMRON Corporation
Industrial Automation Company

<http://www.ia.omron.com/>

(c)Copyright OMRON Corporation 2010 All Right Reserved.

Компания «Океан Электроники» предлагает заключение долгосрочных отношений при поставках импортных электронных компонентов на взаимовыгодных условиях!

Наши преимущества:

- Поставка оригинальных импортных электронных компонентов напрямую с производств Америки, Европы и Азии, а так же с крупнейших складов мира;
- Широкая линейка поставок активных и пассивных импортных электронных компонентов (более 30 млн. наименований);
- Поставка сложных, дефицитных, либо снятых с производства позиций;
- Оперативные сроки поставки под заказ (от 5 рабочих дней);
- Экспресс доставка в любую точку России;
- Помощь Конструкторского Отдела и консультации квалифицированных инженеров;
- Техническая поддержка проекта, помощь в подборе аналогов, поставка прототипов;
- Поставка электронных компонентов под контролем ВП;
- Система менеджмента качества сертифицирована по Международному стандарту ISO 9001;
- При необходимости вся продукция военного и аэрокосмического назначения проходит испытания и сертификацию в лаборатории (по согласованию с заказчиком);
- Поставка специализированных компонентов военного и аэрокосмического уровня качества (Xilinx, Altera, Analog Devices, Intersil, Interpoint, Microsemi, Actel, Aeroflex, Peregrine, VPT, Syfer, Eurofarad, Texas Instruments, MS Kennedy, Miteq, Cobham, E2V, MA-COM, Hittite, Mini-Circuits, General Dynamics и др.);

Компания «Океан Электроники» является официальным дистрибьютором и эксклюзивным представителем в России одного из крупнейших производителей разъемов военного и аэрокосмического назначения «JONHON», а так же официальным дистрибьютором и эксклюзивным представителем в России производителя высокотехнологичных и надежных решений для передачи СВЧ сигналов «FORSTAR».



JONHON

«JONHON» (основан в 1970 г.)

Разъемы специального, военного и аэрокосмического назначения:

(Применяются в военной, авиационной, аэрокосмической, морской, железнодорожной, горно- и нефтедобывающей отраслях промышленности)

«FORSTAR» (основан в 1998 г.)

ВЧ соединители, коаксиальные кабели,
кабельные сборки и микроволновые компоненты:

(Применяются в телекоммуникациях гражданского и специального назначения, в средствах связи, РЛС, а так же военной, авиационной и аэрокосмической отраслях промышленности).



Телефон: 8 (812) 309-75-97 (многоканальный)

Факс: 8 (812) 320-03-32

Электронная почта: ocean@oceanchips.ru

Web: <http://oceanchips.ru/>

Адрес: 198099, г. Санкт-Петербург, ул. Калинина, д. 2, корп. 4, лит. А