

NCS2211

Low Distortion Audio Power Amplifier with Differential Output and Shutdown Mode

Product Description

The NCS2211 is a high performance, low distortion Class A/B audio amplifier. It is capable of delivering 1 W of output power into an 8 Ω speaker bridge-tied load (BTL). The NCS2211 will operate over a wide temperature range, and it is specified for single-supply voltage operation for portable applications.

It features low distortion performance, 0.2% typical THD + N @ 1 W and incorporates a shutdown/enable feature to extend battery life. The shutdown/enable feature will reduce the quiescent current to 1 μ A maximum.

The NCS2211 is designed to operate over the -40°C to $+85^{\circ}\text{C}$ temperature range, and is available in an 8-lead SOIC package and a 3 X 3 mm DFN8 package. The SOIC package is pin compatible with equivalent function and comparable performance to competitive devices as is the DFN8 package. The DFN8 has a low thermal resistance of only $70^{\circ}\text{C}/\text{W}$ plus has an exposed metal pad to facilitate heat conduction to copper PCB material.

Low distortion, high power, low quiescent current, and small packaging makes the NCS2211 suitable for applications including notebook and desktop computers, PDA's, and speaker phones.

Features

- Differential Output
- 1.0 W into an 8 Ω Speaker
- 1.5 W into a 4 Ω Speaker
- Single Supply Operation: 2.7 V to 5.5 V
- THD+N: 0.2% @ 1 W Output
- Low Quiescent Current: 20 mA Max
- Shutdown Current < 1.0 μ A
- Excellent Power Supply Rejection
- Two Package Options: SOIC-8 Package and DFN8
- Pin Compatible with Competitive Devices
- These are Pb-Free Devices

Applications

- Desktop Computers
- Notebook Computers
- PDA's
- Speaker Phones
- Games



ON Semiconductor®

<http://onsemi.com>

MARKING DIAGRAMS



SOIC-8
D SUFFIX
CASE 751

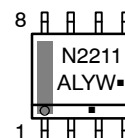

DFN8
MN SUFFIX
CASE 506BJ

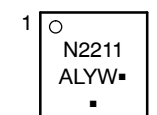

N2211 = Specific Device Code
A = Assembly Location
L = Wafer Lot
Y = Year
W = Work Week
▪ = Pb-Free Package

(Note: Microdot may be in either location)

PIN ASSIGNMENT

PIN	NAME	DESCRIPTION
1	Enable	Enable (LOW)/Shutdown (HIGH)
2	Bias	Bias Output at $(V_{CC}-V_{EE})/2$; Bypass with Capacitor to Reduce Noise
3	IN+	Non-Inverting Input
4	IN-	Inverting Input
5	OUT+	Output+
6	V _{CC}	Positive Supply (Bypass with 10 μ F in parallel with 0.1 μ F)
7	V _{EE}	Negative Supply (Connect to GND for Single-Supply Operation)
8	OUT-	Output-

ORDERING INFORMATION

See detailed ordering and shipping information in the package dimensions section on page 9 of this data sheet.

NCS2211

PIN CONNECTIONS for SOIC-8 and DFN8

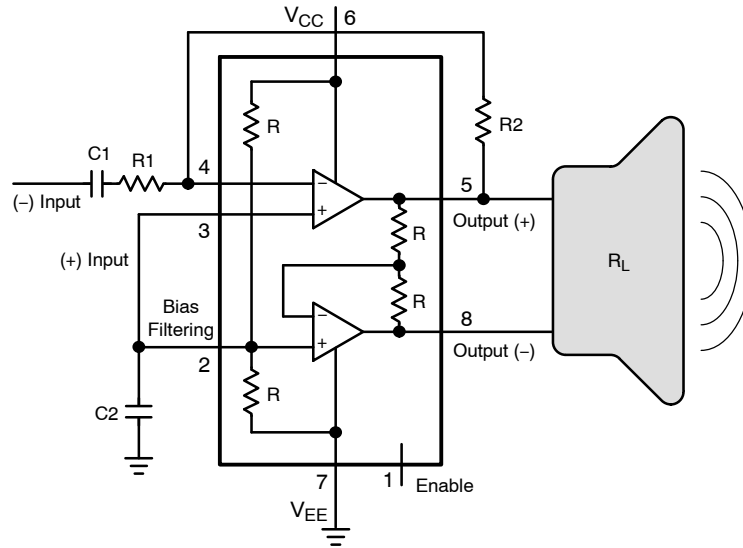
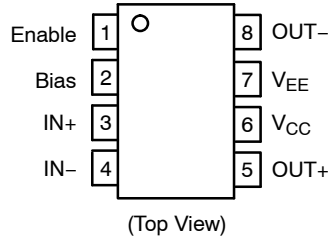

Figure 1. Block Diagram

	High	Low
Enable (Note 1)	Shutdown	Enabled

1. Enable (pin 1) must be actively driven for proper operation and cannot be left floating. See ENABLE/SHUTDOWN CONTROL in the specification table for proper logic threshold levels.

MAXIMUM RATINGS

Parameter	Symbol	Rating	Unit
Power Supply Voltages	V_{CC}	5.5	Vdc
Output Current	I_O	500	mA
Maximum Junction Temperature (Note 2)	T_J	150	°C
Operating Ambient Temperature	T_A	-40 to +85	°C
Storage Temperature Range	T_{stg}	-60 to +150	°C
Power Dissipation	P_D	(See Graph)	mW
Thermal Resistance, Junction-to-Air – SOIC-8 – DFN8 (Note 4)	θ_{JA}	117 70	°C/W
Moisture Sensitivity (Note 3)		Level 1	

Stresses exceeding Maximum Ratings may damage the device. Maximum Ratings are stress ratings only. Functional operation above the Recommended Operating Conditions is not implied. Extended exposure to stresses above the Recommended Operating Conditions may affect device reliability.

2. Power dissipation must be considered to ensure maximum junction temperature (T_J) is not exceeded.

3. For additional information, see Application Note AND8003/D

4. As mounted on an 80x80x1.5 mm FR4 PCB with 650 mm² and 2 oz (0.034 mm) thick copper heat spreader. Following JEDEC JESD/EIA 51.1, 51.2, 51.3 test guidelines.

NCS2211

DC ELECTRICAL CHARACTERISTICS ($V_{CC} = +5\text{ V}$, $A_{VD} = 2$, $R_L = 8\ \Omega$, $C_2 = 0.1\ \mu\text{F}$, $T_A = 25^\circ\text{C}$, unless otherwise specified)

Symbol	Characteristics	Conditions	Min	Typ	Max	Unit
POWER SUPPLY						
V_{CC}	Operating Voltage Range		2.7		5.5	V
$I_{S, ON}$	Power Supply Current – Enabled	$V_{CC} = 2.7\text{ V to } 5.5\text{ V}$ $T_A = -40^\circ\text{C to } +85^\circ\text{C}$ (Note 5)			20	mA
$I_{S, OFF}$	Power Supply Current – Shutdown	$V_{CC} = 2.7\text{ V to } 5.5\text{ V}$			1.0	μA
PSRR	Power Supply Rejection Ratio	$V_{CC} = 2.7\text{ V to } 5.5\text{ V}$ $T_A = -40^\circ\text{C to } +85^\circ\text{C}$		75		dB

ENABLE/SHUTDOWN CONTROL

V_{IH}	Enable Input High	Device Shutdown $V_{CC} = 2.7\text{ V to } 5.5\text{ V}$	$90\% \times V_{CC}$		V_{CC}	V
V_{IL}	Enable Input Low	Device Enabled $V_{CC} = 2.7\text{ V to } 5.5\text{ V}$	GND		$10\% \times V_{CC}$	V

OUTPUT CHARACTERISTICS

V_{OH}	Output High Voltage	From Either Output to GND $R_L = 8\ \Omega$		$V_{CC} - 0.400$		V
V_{OL}	Output Low Voltage	From Either Output to GND $R_L = 8\ \Omega$		0.400		V
$V_{out-off}$	Differential Output Offset Voltage	$V_{CC} = 2.7\text{ V to } 5.5\text{ V}$ (Note 5) $T_A = -40^\circ\text{C to } +85^\circ\text{C}$			± 50	mV
I_O	Output Current	Output to Output		350		mA

AC ELECTRICAL CHARACTERISTICS ($V_{CC} = +5\text{ V}$, $A_{VD} = 2$, $R_L = 8\ \Omega$, $C_2 = 0.1\ \mu\text{F}$, $T_A = 25^\circ\text{C}$, unless otherwise specified)

Symbol	Characteristics	Conditions	Min	Typ	Max	Unit
FREQUENCY DOMAIN PERFORMANCE						
GBW	Gain Bandwidth Product			12		MHz
	Phase Margin	$A_{VD} = +2$, $R_L = 8\ \Omega$, $V_{CC} = 5\text{ V}$		80		$^\circ$
THD+N	Total Harmonic Distortion	$V_{CC} = 5\text{ V}$, $f = 1\text{ kHz}$, $P = 1.0\text{ W into } 8\ \Omega$ $V_{CC} = 5\text{ V}$, $f = 1\text{ kHz}$, $P = 0.5\text{ W into } 8\ \Omega$ $V_{CC} = 3.3\text{ V}$, $f = 1\text{ kHz}$, $P = 0.35\text{ W into } 8\ \Omega$ $V_{CC} = 2.7\text{ V}$, $f = 1\text{ kHz}$, $P = 0.25\text{ W into } 8\ \Omega$		0.2 0.15 0.1 0.1		%

TIME DOMAIN RESPONSE

t_{ON}	Turn on delay	$V_{CC} = 5\text{ V}$		1		μs
t_{OFF}	Turn off delay	$V_{CC} = 5\text{ V}$		4		μs

5. Guaranteed by design and/or characterization.

TYPICAL PERFORMANCE CHARACTERISTICS

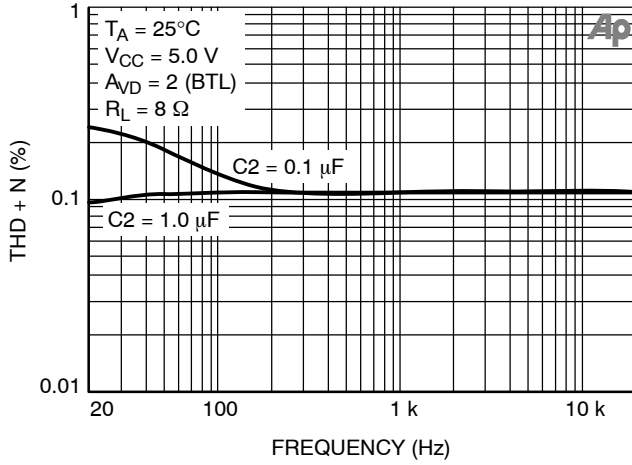

Figure 2. THD + N vs. Frequency
($P_L = 500 \text{ mW}$)

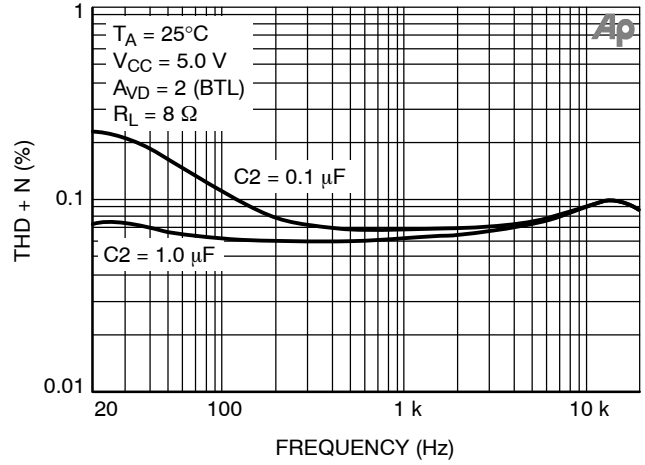

Figure 3. THD + N vs. Frequency
($P_L = 1 \text{ W}$)

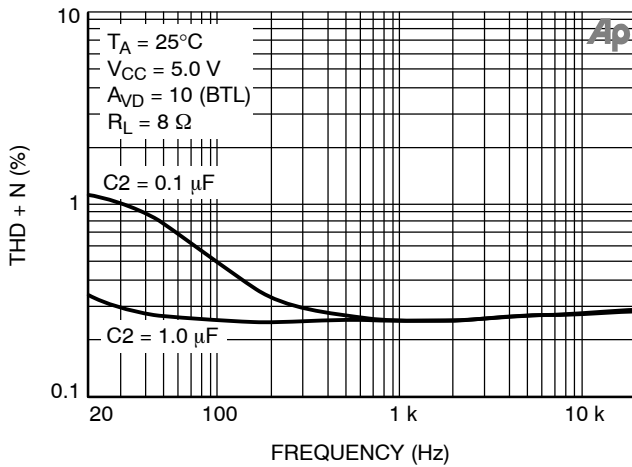

Figure 4. THD + N vs. Frequency
($P_L = 500 \text{ mW}$)

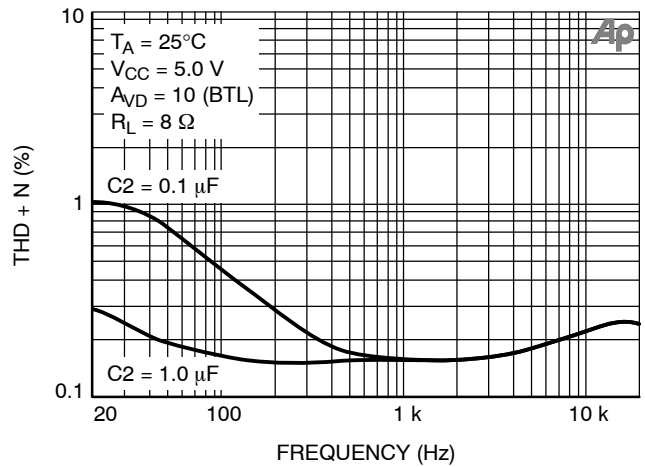

Figure 5. THD + N vs. Frequency
($P_L = 1 \text{ W}$)

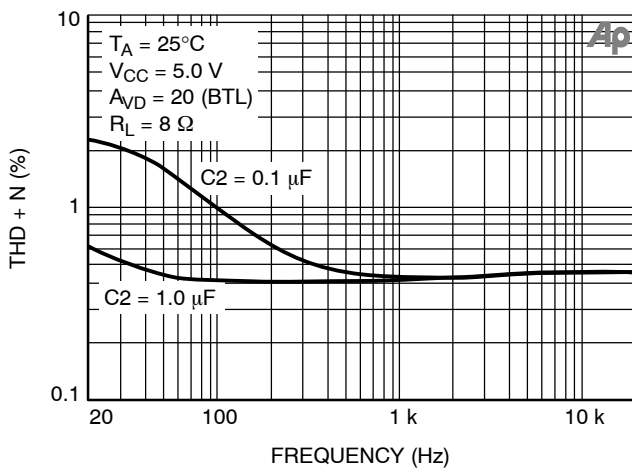

Figure 6. THD + N vs. Frequency
($P_L = 500 \text{ mW}$)

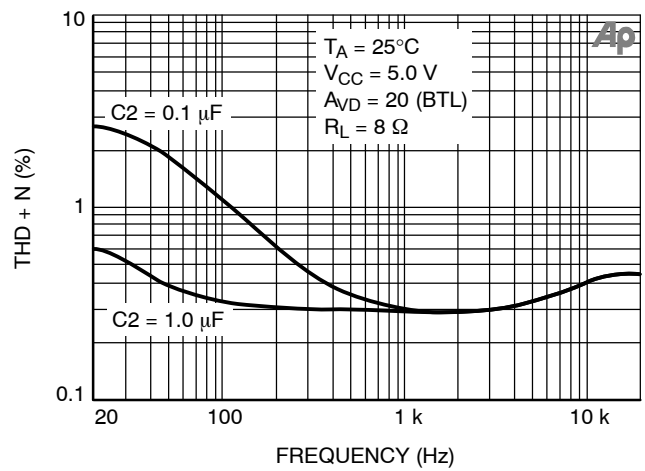

Figure 7. THD + N vs. Frequency
($P_L = 1 \text{ W}$)

TYPICAL PERFORMANCE CHARACTERISTICS

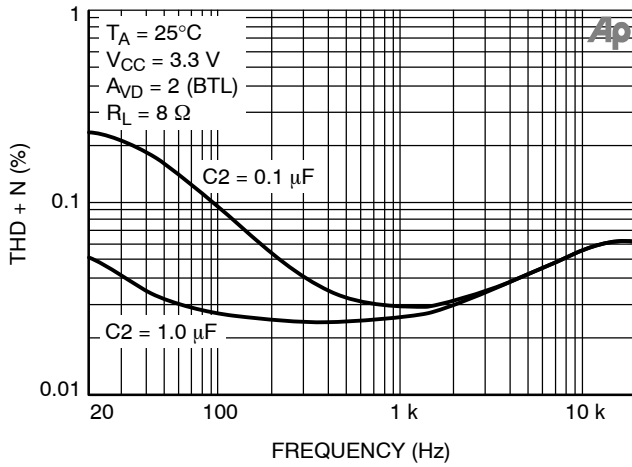

Figure 8. THD + N vs. Frequency
(P_L = 350 mW)

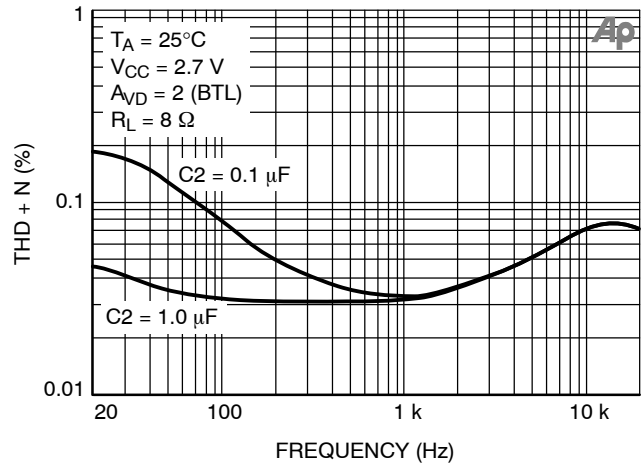

Figure 9. THD + N vs. Frequency
(P_L = 250 mW)

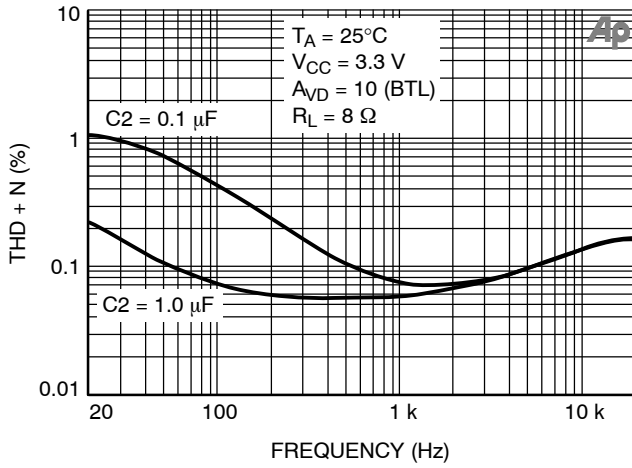

Figure 10. THD + N vs. Frequency
(P_L = 350 mW)

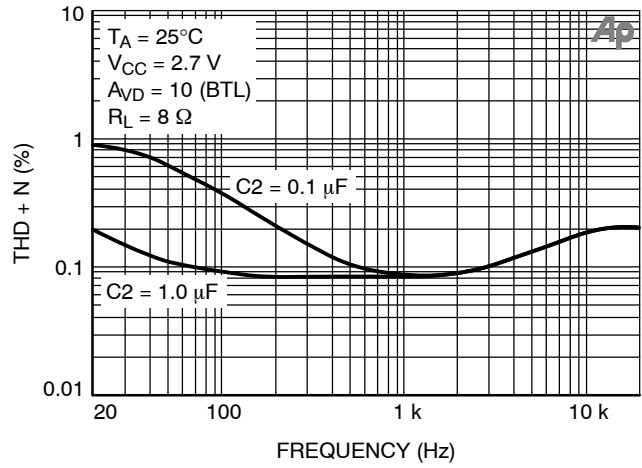

Figure 11. THD + N vs. Frequency
(P_L = 250 mW)

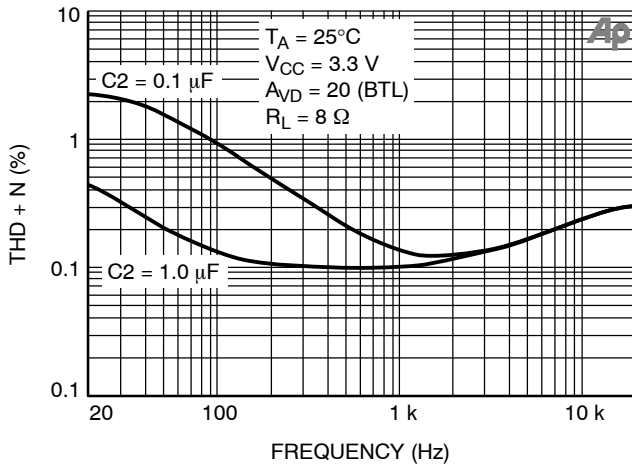

Figure 12. THD + N vs. Frequency
(P_L = 350 mW)

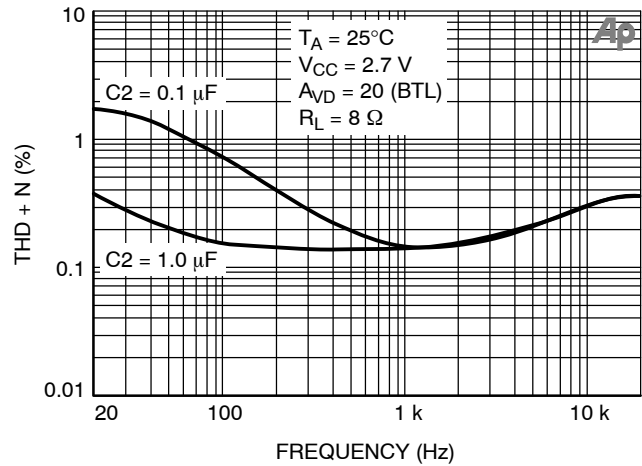

Figure 13. THD + N vs. Frequency
(P_L = 250 mW)

TYPICAL PERFORMANCE CHARACTERISTICS

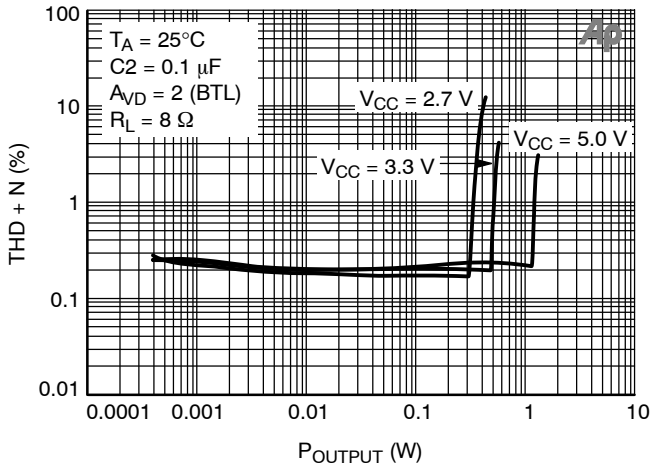

Figure 14. THD + N vs. P_{OUT}
(Frequency = 20 Hz)

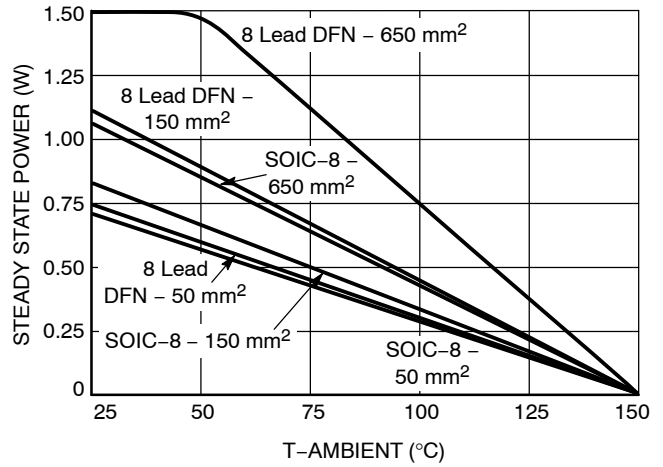

Figure 15. SOA Curve with PCB Copper Thickness 2 oz and Various Areas

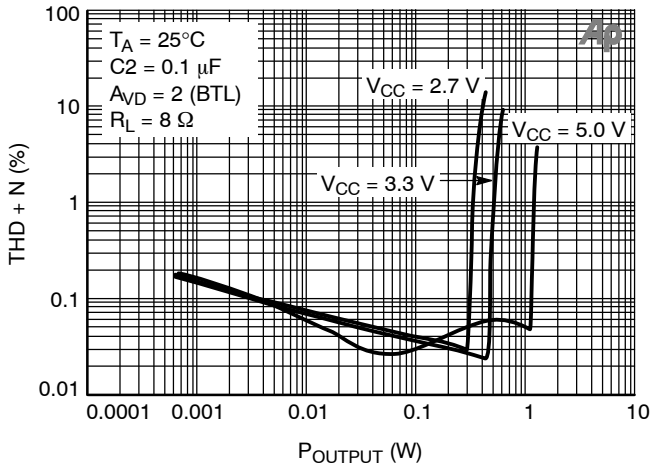

Figure 16. THD + N vs. P_{OUT}
(Frequency = 1 kHz)

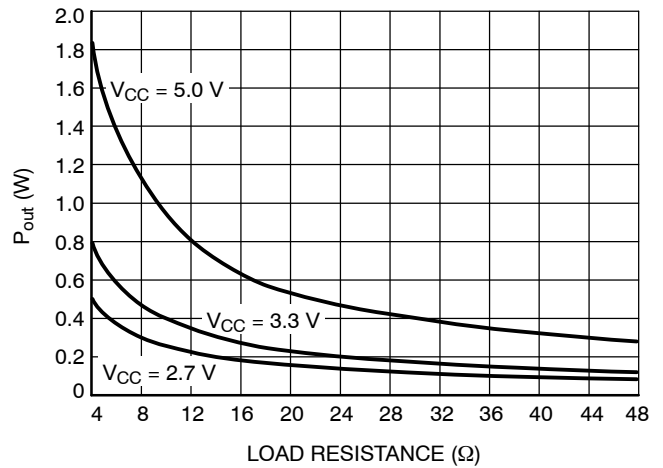

Figure 17. P_{out} vs. Load Resistance

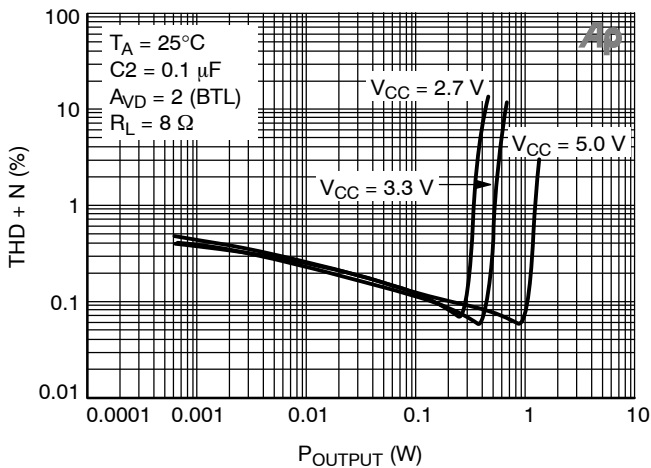

Figure 18. THD + N vs. P_{OUT}
(Frequency = 20 kHz)

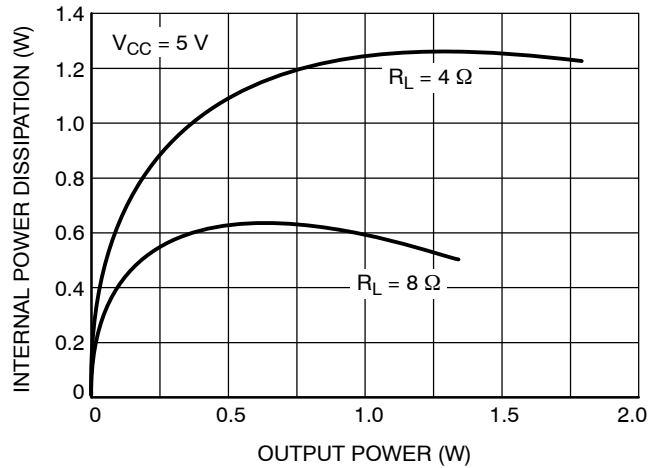

Figure 19. Power Dissipation vs. Output Power

NCS2211

TYPICAL PERFORMANCE CHARACTERISTICS

Channel 1: Enable Logic and OUT+ and OUT-

Channel 2: Differential Output

Time Base: 1 μ Sec per Division

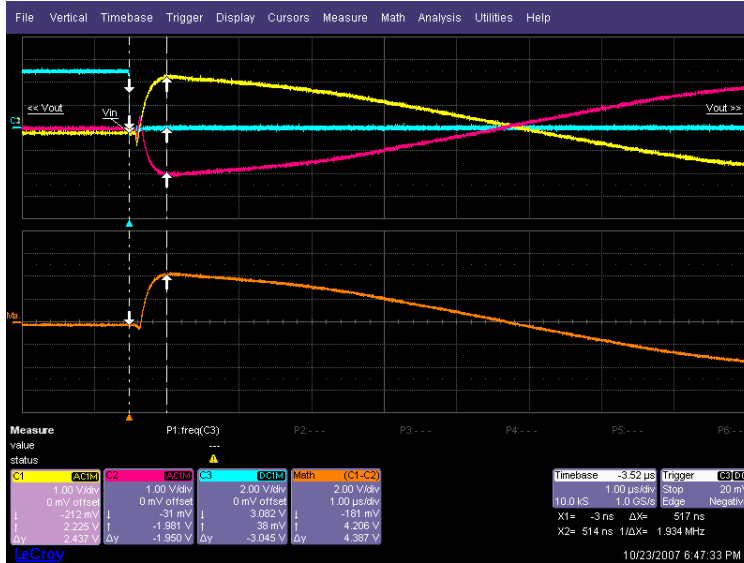

Figure 20. Turn-on Time

Channel 1: SHUTDOWN Logic and OUT+ and OUT-

Channel 2: Differential Output

Time Base: 5 μ Sec per Division

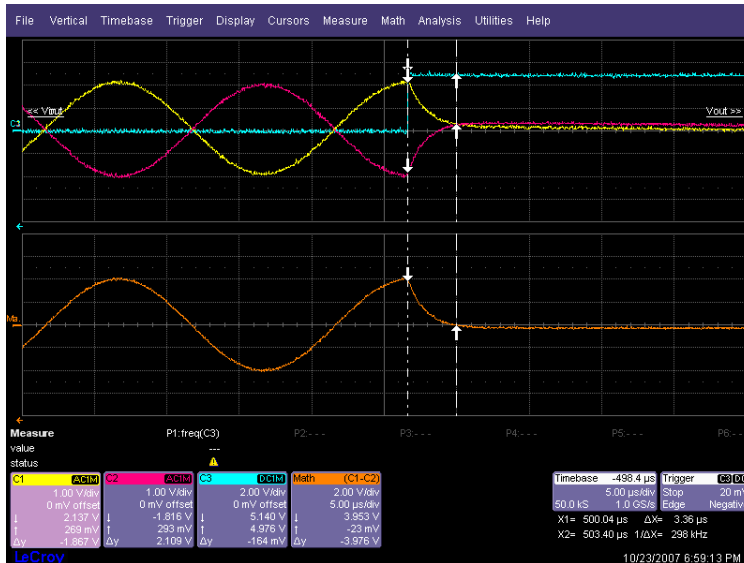

Figure 21. Turn-off Time

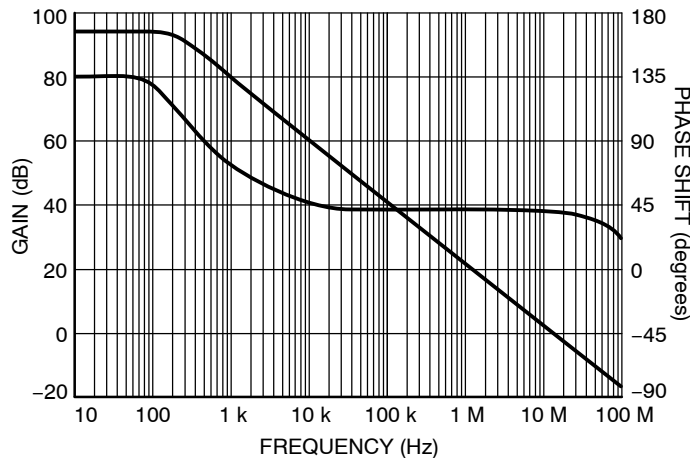

Figure 22. Gain and Phase Shift vs. Frequency

NCS2211

TYPICAL PERFORMANCE CHARACTERISTICS

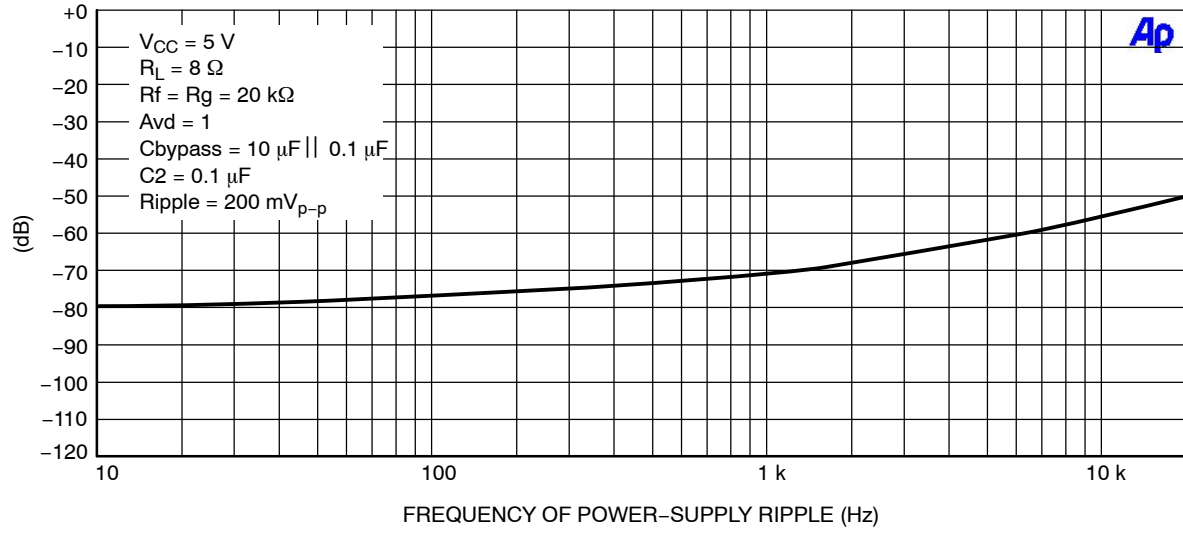

Figure 23. Power-Supply Rejection

NCS2211

APPLICATIONS INFORMATION

The NCS2211 is unity gain stable and therefore does not require any compensation, but a proper power-supply bypass is required as shown in Figure 24. Performance will be enhanced by adding a filter capacitor (C2) to the mid-supply node (pin 2). See Typical Performance Characteristics for details.

It is preferable to AC couple the input to avoid a large DC output offset.

Both outputs can be driven to within 400 mV of either supply rail with an 8 Ω load.

Typical Application of the Device:

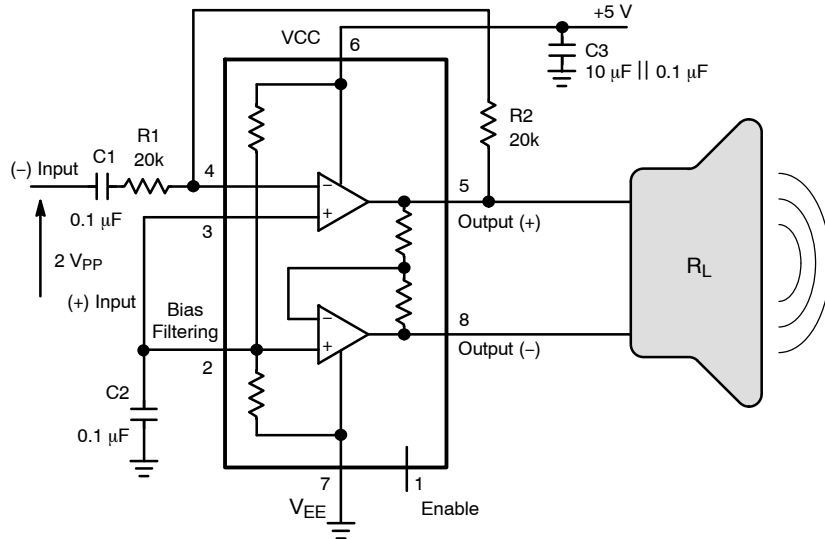

Figure 24.

THERMAL CONSIDERATIONS

Care must be taken to not exceed the maximum junction temperature of the device (150°C). Figure 15 shows the tradeoff between output power and junction temperature for different areas of exposed PCB copper (2 oz). If the maximum power is exceeded momentarily, normal circuit operation will be restored as soon as the die temperature is reduced. Leaving the device in an “overheated” condition for an extended period can result in device burnout. To ensure proper operation, it is important to observe the SOA curves.

GAIN

Since the output is differential, the gain from input to the speaker is: $A_{VD} = 2 \times R2/R1$. For low level input signals, THD will be optimized by pre-amplifying the signal and running the NCS2211 at gain $A_{VD} = 2$ and $C2=1 \mu F$.

BIAS FILTERING

Even though the NCS2211 will operate nominally with no filter capacitor on pin 2, THD performance will be improved dramatically with a filter capacitor installed (see Typical Performance Characteristics). In addition a C2 filter capacitor at pin 2 will suppress start-up popping noise. To insure optimal suppression the time constant of the bias filtering needs to be greater than the time constant of the input capacitive coupling circuit, that is $C2 \times 25 k > C1 \times R1$.

ORDERING INFORMATION

Device	Package	Shipping†
NCS2211DG	SOIC-8 (Pb-Free)	98 Units / Rail
NCS2211DR2G	SOIC-8 (Pb-Free)	2500 / Tape & Reel
NCS2211MNTXG	DFN-8 (Pb-Free)	3000 / Tape & Reel

†For information on tape and reel specifications, including part orientation and tape sizes, please refer to our Tape and Reel Packaging Specifications Brochure, BRD8011/D.

NCS2211

PACKAGE DIMENSIONS

DFN8 3x3, 0.5P
CASE 506BJ-01
ISSUE O

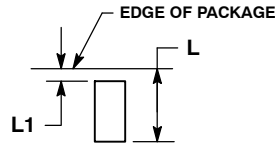
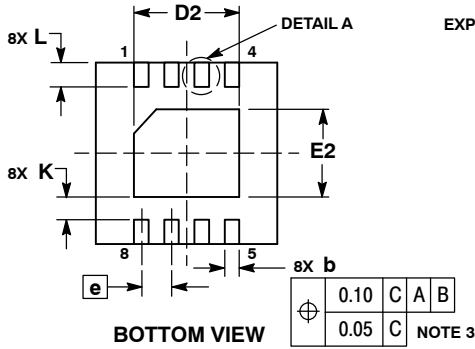
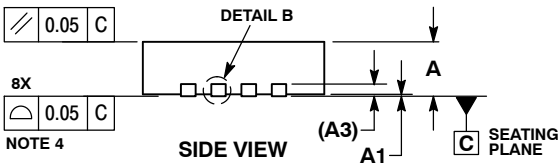
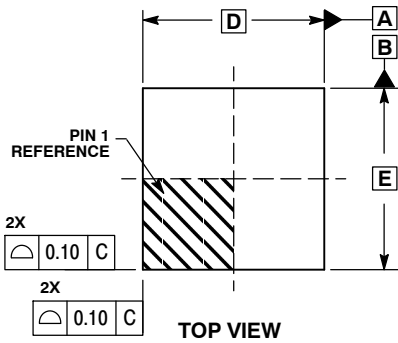

DETAIL A
OPTIONAL
CONSTRUCTION

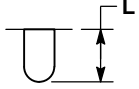

DETAIL A
OPTIONAL
CONSTRUCTION

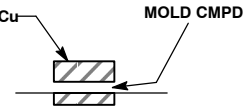

NOTES:

1. DIMENSIONS AND TOLERANCING PER ASME Y14.5M, 1994.
2. CONTROLLING DIMENSION: MILLIMETERS.
3. DIMENSION b APPLIES TO PLATED TERMINAL AND IS MEASURED BETWEEN 0.15 AND 0.30 MM FROM TERMINAL.
4. COPLANARITY APPLIES TO THE EXPOSED PAD AS WELL AS THE TERMINALS.

MILLIMETERS		
DIM	MIN	MAX
A	0.80	1.00
A1	0.00	0.05
A3	0.20	REF
b	0.18	0.30
D	3.00	BSC
D2	1.64	1.84
E	3.00	BSC
E2	1.35	1.55
e	0.50	BSC
K	0.20	---
L	0.30	0.50
L1	0.00	0.03

SOLDERMASK DEFINED MOUNTING FOOTPRINT

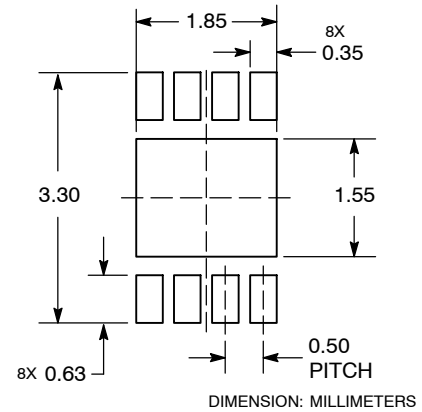

NCS2211

PACKAGE DIMENSIONS

SOIC-8 D SUFFIX CASE 751-07 ISSUE AH

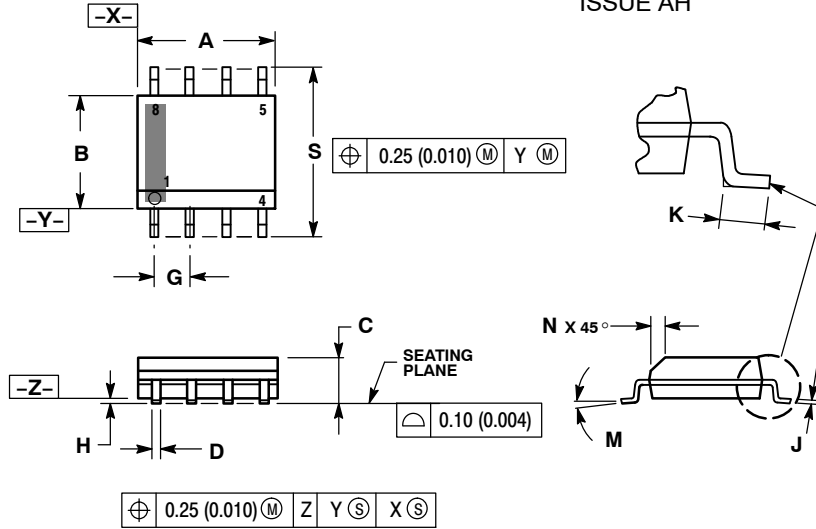

NOTES:

1. DIMENSIONING AND TOLERANCING PER ANSI Y14.5M, 1982.
2. CONTROLLING DIMENSION: MILLIMETER.
3. DIMENSION A AND B DO NOT INCLUDE MOLD PROTRUSION.
4. MAXIMUM MOLD PROTRUSION 0.15 (0.006) PER SIDE.
5. DIMENSION D DOES NOT INCLUDE DAMBAR PROTRUSION. ALLOWABLE DAMBAR PROTRUSION SHALL BE 0.127 (0.005) TOTAL IN EXCESS OF THE D DIMENSION AT MAXIMUM MATERIAL CONDITION.
6. 751-01 THRU 751-06 ARE OBSOLETE. NEW STANDARD IS 751-07.

DIM	MILLIMETERS		INCHES	
	MIN	MAX	MIN	MAX
A	4.80	5.00	0.189	0.197
B	3.80	4.00	0.150	0.157
C	1.35	1.75	0.053	0.069
D	0.33	0.51	0.013	0.020
G	1.27 BSC		0.050 BSC	
H	0.10	0.25	0.004	0.010
J	0.19	0.25	0.007	0.010
K	0.40	1.27	0.016	0.050
M	0°	8°	0°	8°
N	0.25	0.50	0.010	0.020
S	5.80	6.20	0.228	0.244

SOLDERING FOOTPRINT*

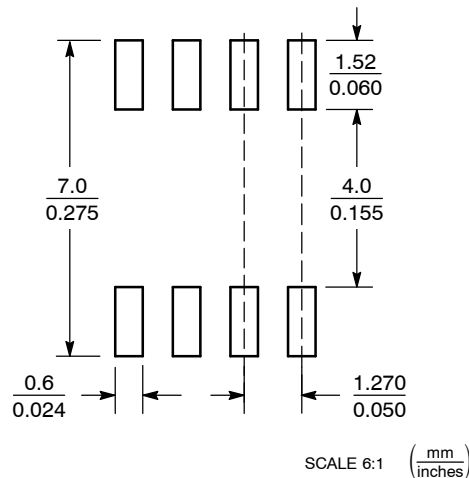

*For additional information on our Pb-Free strategy and soldering details, please download the ON Semiconductor Soldering and Mounting Techniques Reference Manual, SOLDERRM/D.

ON Semiconductor and are registered trademarks of Semiconductor Components Industries, LLC (SCILLC). SCILLC reserves the right to make changes without further notice to any products herein. SCILLC makes no warranty, representation or guarantee regarding the suitability of its products for any particular purpose, nor does SCILLC assume any liability arising out of the application or use of any product or circuit, and specifically disclaims any and all liability, including without limitation special, consequential or incidental damages. "Typical" parameters which may be provided in SCILLC data sheets and/or specifications can and do vary in different applications and actual performance may vary over time. All operating parameters, including "Typicals" must be validated for each customer application by customer's technical experts. SCILLC does not convey any license under its patent rights nor the rights of others. SCILLC products are not designed, intended, or authorized for use as components in systems intended for surgical implant into the body, or other applications intended to support or sustain life, or for any other application in which the failure of the SCILLC product could create a situation where personal injury or death may occur. Should Buyer purchase or use SCILLC products for any such unintended or unauthorized application, Buyer shall indemnify and hold SCILLC and its officers, employees, subsidiaries, affiliates, and distributors harmless against all claims, costs, damages, and expenses, and reasonable attorney fees arising out of, directly or indirectly, any claim of personal injury or death associated with such unintended or unauthorized use, even if such claim alleges that SCILLC was negligent regarding the design or manufacture of the part. SCILLC is an Equal Opportunity/Affirmative Action Employer. This literature is subject to all applicable copyright laws and is not for resale in any manner.

PUBLICATION ORDERING INFORMATION

LITERATURE FULFILLMENT:
Literature Distribution Center for ON Semiconductor
P.O. Box 5163, Denver, Colorado 80217 USA
Phone: 303-675-2175 or 800-344-3860 Toll Free USA/Canada
Fax: 303-675-2176 or 800-344-3867 Toll Free USA/Canada
Email: orderlit@onsemi.com

N. American Technical Support: 800-282-9855 Toll Free USA/Canada
Europe, Middle East and Africa Technical Support:
Phone: 421 33 790 2910
Japan Customer Focus Center
Phone: 81-3-5773-3850

ON Semiconductor Website: www.onsemi.com
Order Literature: <http://www.onsemi.com/orderlit>

For additional information, please contact your local Sales Representative

Компания «Океан Электроники» предлагает заключение долгосрочных отношений при поставках импортных электронных компонентов на взаимовыгодных условиях!

Наши преимущества:

- Поставка оригинальных импортных электронных компонентов напрямую с производств Америки, Европы и Азии, а так же с крупнейших складов мира;
- Широкая линейка поставок активных и пассивных импортных электронных компонентов (более 30 млн. наименований);
- Поставка сложных, дефицитных, либо снятых с производства позиций;
- Оперативные сроки поставки под заказ (от 5 рабочих дней);
- Экспресс доставка в любую точку России;
- Помощь Конструкторского Отдела и консультации квалифицированных инженеров;
- Техническая поддержка проекта, помощь в подборе аналогов, поставка прототипов;
- Поставка электронных компонентов под контролем ВП;
- Система менеджмента качества сертифицирована по Международному стандарту ISO 9001;
- При необходимости вся продукция военного и аэрокосмического назначения проходит испытания и сертификацию в лаборатории (по согласованию с заказчиком);
- Поставка специализированных компонентов военного и аэрокосмического уровня качества (Xilinx, Altera, Analog Devices, Intersil, Interpoint, Microsemi, Actel, Aeroflex, Peregrine, VPT, Syfer, Eurofarad, Texas Instruments, MS Kennedy, Miteq, Cobham, E2V, MA-COM, Hittite, Mini-Circuits, General Dynamics и др.);

Компания «Океан Электроники» является официальным дистрибьютором и эксклюзивным представителем в России одного из крупнейших производителей разъемов военного и аэрокосмического назначения «JONHON», а так же официальным дистрибьютором и эксклюзивным представителем в России производителя высокотехнологичных и надежных решений для передачи СВЧ сигналов «FORSTAR».



JONHON

«JONHON» (основан в 1970 г.)

Разъемы специального, военного и аэрокосмического назначения:

(Применяются в военной, авиационной, аэрокосмической, морской, железнодорожной, горно- и нефтедобывающей отраслях промышленности)

«FORSTAR» (основан в 1998 г.)

ВЧ соединители, коаксиальные кабели, кабельные сборки и микроволновые компоненты:

(Применяются в телекоммуникациях гражданского и специального назначения, в средствах связи, РЛС, а так же военной, авиационной и аэрокосмической отраслях промышленности).



Телефон: 8 (812) 309-75-97 (многоканальный)

Факс: 8 (812) 320-03-32

Электронная почта: ocean@oceanchips.ru

Web: <http://oceanchips.ru/>

Адрес: 198099, г. Санкт-Петербург, ул. Калинина, д. 2, корп. 4, лит. А