

**SIL type SSR with
9mm thickness
controls up to 3 A**

AQ8 RELAYS



RoHS compliant

FEATURES

- 1. Slim with 9 mm .354 inch thickness**
The thin type (45 mm long × 24 mm high × 9 mm wide) (1.772×.945×.354 inch) permits high density mounting.
- 2. Excellent in noise resistance**
Since the input and output are insulated by the phototriac coupler, the noise on the output side is not fed back to the input side.
- 3. Snubber circuit integrated**
The snubber circuit is integrated to prevent malfunction caused by the rapid rise of the voltage on the output side, such as inductive load and noise.
- 4. Zero-cross and random types are available.**
The zero-cross type generates minimal noise by suppressing occurrence of radio frequency interference (RFI) and electro-magnetic interference (EMI).
The random type features a short operation time which permits phase control.

- 5. High dielectric strength: 3,000 Vrms (between input and output)**
- 6. Two kinds of terminals distance are available. (5.08 mm and 7.62 mm) (.200 and .300 inch)**
- 7. High reliability, long life and maintenance-free**

TYPICAL APPLICATIONS

- 1. Most suitable as drivers for small size AC motors, solenoids, solenoid valves and so on.**
- 2. Copying equipment**
- 3. Air conditioners**
- 4. Industrial equipment such as NC machines, sequencers, robots, etc.**

ORDERING INFORMATION

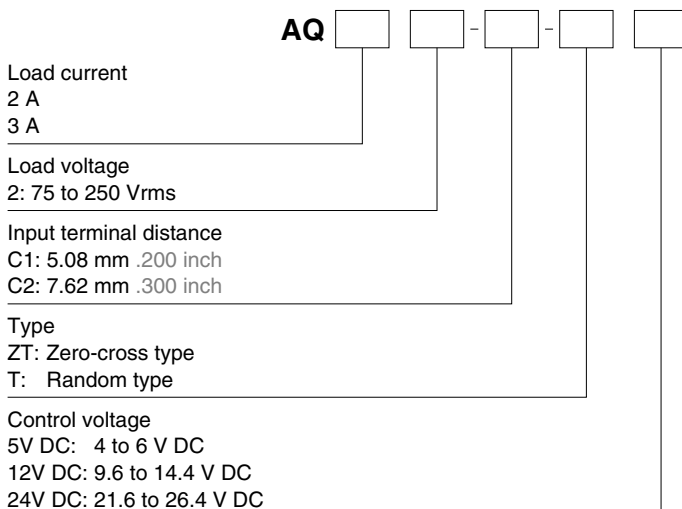

TYPES

Types	Load current	Load voltage	Control voltage	Input terminals distance (5.08 mm .200 inch type)	Input terminals distance (7.62 mm .300 inch type)
				Part No.	Part No.
Zero-cross type	2 A	75 to 250 Vrms	4 to 6 V DC	AQ2A2-C1-ZT5VDC	AQ2A2-C2-ZT5VDC
			9.6 to 14.4 V DC	AQ2A2-C1-ZT12VDC	AQ2A2-C2-ZT12VDC
			21.6 to 26.4 V DC	AQ2A2-C1-ZT24VDC	AQ2A2-C2-ZT24VDC
	3 A	75 to 250 Vrms	4 to 6 V DC	AQ3A2-C1-ZT5VDC	AQ3A2-C2-ZT5VDC
			9.6 to 14.4 V DC	AQ3A2-C1-ZT12VDC	AQ3A2-C2-ZT12VDC
			21.6 to 26.4 V DC	AQ3A2-C1-ZT24VDC	AQ3A2-C2-ZT24VDC
Random type	2 A	75 to 250 Vrms	4 to 6 V DC	AQ2A2-C1-T5VDC	AQ2A2-C2-T5VDC
			9.6 to 14.4 V DC	AQ2A2-C1-T12VDC	AQ2A2-C2-T12VDC
			21.6 to 26.4 V DC	AQ2A2-C1-T24VDC	AQ2A2-C2-T24VDC
	3 A	75 to 250 Vrms	4 to 6 V DC	AQ3A2-C1-T5VDC	AQ3A2-C2-T5VDC
			9.6 to 14.4 V DC	AQ3A2-C1-T12VDC	AQ3A2-C2-T12VDC
			21.6 to 26.4 V DC	AQ3A2-C1-T24VDC	AQ3A2-C2-T24VDC

Standard packing: Carton 20 pcs., Case 200 pcs.

RATING

1. Rating (Ambient temperature: 20°C, 68°F; Voltage ripple on the input side: 1% or less)

1) Zero-cross type

• 2 A type

Item	Part No.	AQ2A2-C1-ZT5VDC AQ2A2-C2-ZT5VDC	AQ2A2-C1-ZT12VDC AQ2A2-C2-ZT12VDC	AQ2A2-C1-ZT24VDC AQ2A2-C2-ZT24VDC	Remarks
Input side	Rated voltage	5 V DC	12 V DC	24 V DC	*1
	Control voltage	4 to 6 V DC	9.6 to 14.4 V DC	21.6 to 26.4 V DC	
	Input impedance	Approx. 0.18 kΩ	Approx. 0.55 kΩ	Approx. 1.4 kΩ	
	Drop-out voltage	Min. 0.5 V	Min. 1.2 V	Min. 2.4 V	
Load side	Max. load current	2 A*2			At ambient temperature of 30°C or less
	Load voltage	75 to 250 Vrms			
	Frequency	45 to 65 Hz			
	Repetitive peak OFF voltage	600 V			
	Non-repetitive surge current	30 A*3			In one cycle at 60 Hz
	Max. "OFF-state" leakage current	5 mA (200 Vrms applied)			at 60 Hz
	Max. "ON-state" voltage drop	1.6 V			at max. carrying current
	Min. load current	50 mA*4			
OFF state dV/dt	50 V/μs			At ambient temperature of 80°C	

• 3 A type

Item	Part No.	AQ3A2-C1-ZT5VDC AQ3A2-C2-ZT5VDC	AQ3A2-C1-ZT12VDC AQ3A2-C2-ZT12VDC	AQ3A2-C1-ZT24VDC AQ3A2-C2-ZT24VDC	Remarks
Input side	Rated voltage	5 V DC	12 V DC	24 V DC	*1
	Control voltage	4 to 6V DC	9.6 to 14.4V DC	21.6 to 26.4V DC	
	Input impedance	Approx. 0.18 kΩ	Approx. 0.55 kΩ	Approx. 1.4 kΩ	
	Drop-out voltage	Min. 0.5 V	Min. 1.2 V	Min. 2.4 V	
Load side	Max. load current	3 A*2			At ambient temperature of 30°C or less
	Load voltage	75 to 250 Vrms			
	Frequency	45 to 65 Hz			
	Repetitive peak OFF voltage	600 V			
	Non-repetitive surge current	80 A*3			In one cycle at 60 Hz
	Max. "OFF-state" leakage current	5 mA (200 Vrms applied)			at 60 Hz
	Max. "ON-state" voltage drop	1.6 V			at max. carrying current
	Min. load current	50 mA*4			
OFF state dV/dt	50 V/μs			At ambient temperature of 80°C	

Notes: *1. Refer to REFERENCE DATA "3. Characteristics of input current vs. input voltage".

*2. Refer to REFERENCE DATA "1. Characteristics of load current vs. ambient temperature".

*3. Refer to REFERENCE DATA "2. Characteristics of non-repetitive surge current vs. carrying time".

*4. When the load current is less than the rated minimum load current, please refer to "Cautions for Use of Solid State Relays".

2) Random type

• 2 A type

Item	Part No.	AQ2A2-C1-T5VDC AQ2A2-C2-T5VDC	AQ2A2-C1-T12VDC AQ2A2-C2-T12VDC	AQ2A2-C1-T24VDC AQ2A2-C2-T24VDC	Remarks
Input side	Rated voltage	5 V DC	12 V DC	24 V DC	*1
	Control voltage	4 to 6 V DC	9.6 to 14.4 V DC	21.6 to 26.4 V DC	
	Input impedance	Approx. 0.3 kΩ	Approx. 0.8 kΩ	Approx. 1.8 kΩ	
	Drop-out voltage	Min. 0.5 V	Min. 1.2 V	Min. 2.4 V	
Load side	Max. load current	2 A*2			At ambient temperature of 30°C or less
	Load voltage	75 to 250 Vrms			
	Frequency	45 to 65 Hz			
	Repetitive peak OFF voltage	600 V			
	Non-repetitive surge current	30 A*3			In one cycle at 60 Hz
	Max. "OFF-state" leakage current	5 mA (200 Vrms applied)			at 60 Hz
	Max. "ON-state" voltage drop	1.6 V			at max. carrying current
	Min. load current	50 mA*4			
OFF state dV/dt	50 V/μs			At ambient temperature of 80°C	

• 3 A type

Item	Part No.	AQ3A2-C1-T5VDC AQ3A2-C2-T5VDC	AQ3A2-C1-T12VDC AQ3A2-C2-T12VDC	AQ3A2-C1-T24VDC AQ3A2-C2-T24VDC	Remarks
Input side	Rated voltage	5 V DC	12 V DC	24 V DC	*1
	Control voltage	4 to 6 V DC	9.6 to 14.4 V DC	21.6 to 26.4 V DC	
	Input impedance	Approx. 0.3 kΩ	Approx. 0.8 kΩ	Approx. 1.8 kΩ	
	Drop-out voltage	Min. 0.5 V	Min. 1.2 V	Min. 2.4 V	
Load side	Max. load current	3 A*2			At ambient temperature of 30°C or less
	Load voltage	75 to 250 Vrms			
	Frequency	45 to 65 Hz			
	Repetitive peak OFF voltage	600 V			
	Non-repetitive surge current	80 A*3			In one cycle at 60 Hz
	Max. "OFF-state" leakage current	5 mA (200 Vrms applied)			at 60 Hz
	Max. "ON-state" voltage drop	1.6 V			at max. carrying current
	Min. load current	50 mA*4			
OFF state dV/dt	50 V/μs			At ambient temperature of 80°C	

Notes: *1. Refer to REFERENCE DATA "3. Characteristics of input current vs. input voltage".

*2. Refer to REFERENCE DATA "1. Characteristics of load current vs. ambient temperature".

*3. Refer to REFERENCE DATA "2. characteristics of non-repetitive surge current vs. carrying time".

*4. When the load current is less than the rated minimum load current, please refer to "Cautions for Use of Solid State Relays".

2. Characteristics (Ambient temperature: 20°C 68°F; Input voltage ripple: 1% or less)

Item	Type	Zero-cross type	Random type	Remarks
Operate time, max.		1/2 cycle of voltage sine wave +1 ms	1 ms	
Release time, max.		1/2 cycle of voltage sine wave +1 ms		
Insulation resistance, min.		10 ⁹ Ω between input and output		at 500 V DC
Breakdown voltage		3,000 Vrms between input and output		For 1 minute
Vibration resistance	Destructive	10 to 55 Hz at double amplitude of 3 mm		1 hour for X, Y, Z axis
	Functional	10 to 55 Hz at double amplitude of 3 mm		10 min. for X, Y, Z axis
Shock resistance	Destructive	Min. 980 m/s ² {100 G}		5 times each for X, Y, Z axis
	Functional	Min. 980 m/s ² {100 G}		4 times each for X, Y, Z axis
Ambient temperature		-30 to +80°C -22 to +176°F		Non-condensing at low temperatures
Storage temperature		-30 to +100°C -22 to +212°F		Non-condensing at low temperatures
Operational method		Zero-cross (Turn ON and Turn OFF)	Random turn ON, zero-cross turn OFF	

REFERENCE DATA

1. Characteristics of load current vs. ambient temperature
 Use load current within range specified in the figure below.

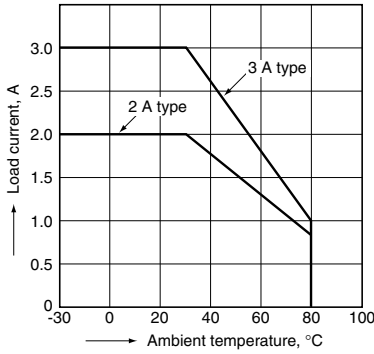

2.-(1) Characteristics of non-repetitive surge current vs. carrying time*
 (2 A type)

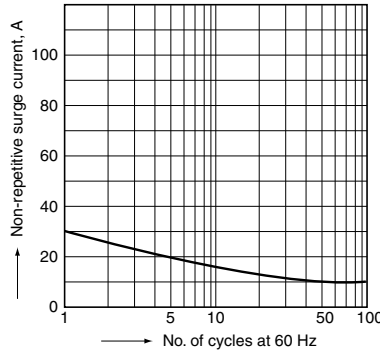

2.-(2) Characteristics of non-repetitive surge current vs. carrying time*
 (3 A type)

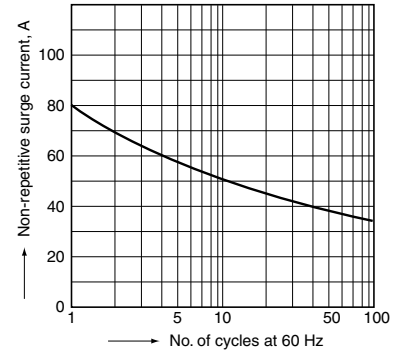

Note: * The above chart shows non-repetitive maximum rating. If a surge current is applied repeatedly, please keep it approximately 50% or less than the values shown in the above graph.

3. Characteristics of input current vs. input voltage
 ---zero-cross type
 ---Random type

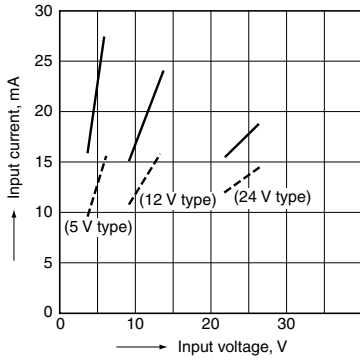

4.-(1) Characteristics of load current vs. ambient temperature for adjacent mounting
 (2 A type)
 Conditions: Natural cooling

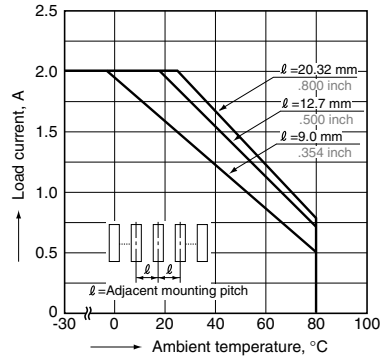

4.-(2) Characteristics of load current vs. ambient temperature for adjacent mounting
 (3 A type)
 Conditions: Natural cooling

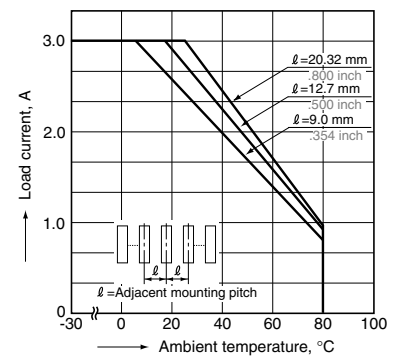

DIMENSIONS (mm inch)

The CAD data of the products with a **CAD** mark can be downloaded from: <https://industrial.panasonic.com/ac/e/>

(Common for zero-cross and random types)

1. Input terminals distance 5.08 mm .200 inch

1) 2 A type

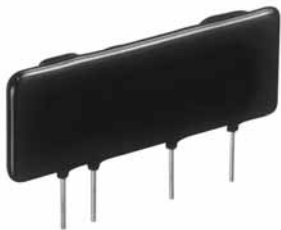

External dimensions

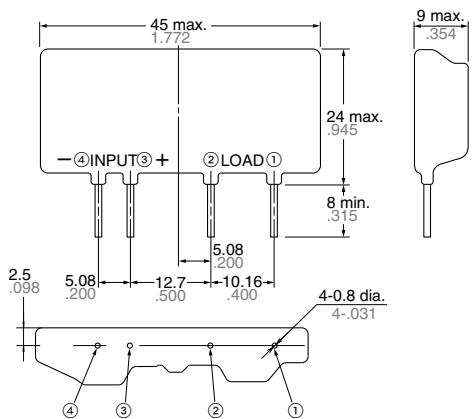

General tolerance: $\pm 0.5 \pm .020$

Mounting hole location (Bottom view)

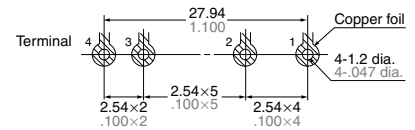

Tolerance: $\pm 0.1 \pm .004$

2) 3 A type

CAD

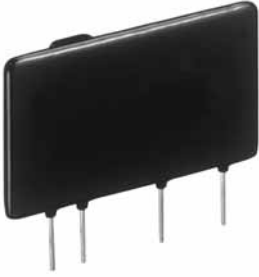

External dimensions



General tolerance: $\pm 0.5 \pm .020$

Mounting hole location (Bottom view)



Tolerance: $\pm 0.1 \pm .004$

2. Input terminals distance 7.62 mm .300 inch

1) 2 A type

CAD

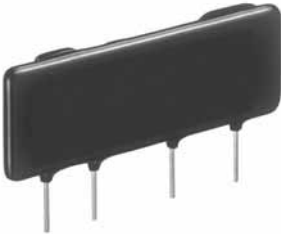

External dimensions



General tolerance: $\pm 0.5 \pm .020$

Mounting hole location (Bottom view)



Tolerance: $\pm 0.1 \pm .004$

2) 3 A type

CAD

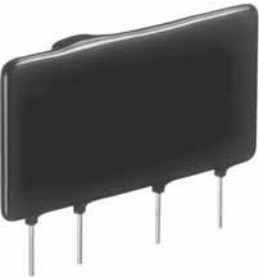

External dimensions



General tolerance: $\pm 0.5 \pm .020$

Mounting hole location (Bottom view)



Tolerance: $\pm 0.1 \pm .004$

SCHEMATIC AND WIRING DIAGRAMS

Schematic	Output configuration	Load	Wiring diagram
	1 Form A	AC	
	1 Form A	AC	

NOTES

1. When used for the load less than rated

In case of the load current less than rated, malfunction may result from the residual voltage across the both ends of the load even if the solid state relay is turned off. Use a dummy resistor as a countermeasure.

The total of the current through the resistor and the load current must exceed the min. rated load current.



In case the dummy resistor is not used, keep in mind that the residual voltage becomes as follows:

Example:

For the inductive load by the 20 mA load current and the 200 Vrms load voltage, the load impedance becomes 10 kΩ and $V_e/V = 14\%$ is estimated from the right above graph. Accordingly, the 28 V voltage remains across the both ends of the load when the solid state relay is turned off.

• Characteristics of residual voltage vs. load impedance



2. when the terminal is bent

Care shall be taken neither to apply mechanical stresses to the mold area of the solid state relay nor to bend the terminal 45 degrees or more.



Recommended Temperature Controllers

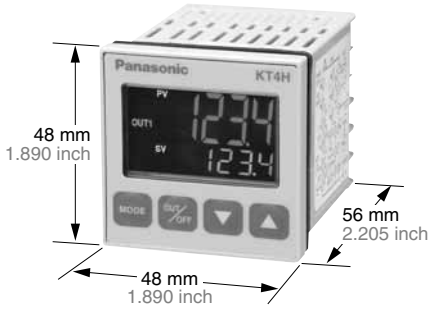

<KT4H Temperature Controller>

Our temperature controller is recommended for use with our Solid State Relays.

Features

- Space saving requiring only a depth of 65 mm
- Data collection possible through a PLC using RS485 communication
- Tool port is standard for easy data setting
- Inverted LCD + backlight for good legibility with large characters
- Excellent operability and rich optional control functions

Substitute part numbers

Power supply	Control output	Part No.
100 to 240 Vrms	Non-contact voltage output	AKT4H112100

* For detailed product information about temperature controllers, please refer to our website:
https://industrial.panasonic.com/ac/e/fasys/component/temperature_controller/

Please contact

Panasonic Corporation

Electromechanical Control Business Division

■ 1006, Oaza Kadoma, Kadoma-shi, Osaka 571-8506, Japan
industrial.panasonic.com/ac/e/

Panasonic[®]

©Panasonic Corporation 2018

Mouser Electronics

Authorized Distributor

Click to View Pricing, Inventory, Delivery & Lifecycle Information:

Panasonic:

[AQ2A1-C1-T5VDC](#) [AQ2A1-C1-ZT5VDC](#) [AQ2A1-C1-T24VDC](#) [AQ2A1-C1-T12VDC](#) [AQ3A1-C1-T5VDC](#) [AQ2A1-C1-ZT24VDC](#) [AQ3A1-C1-ZT24VDC](#) [AQ3A1-C1-ZT5VDC](#) [AQ2A1-C1-ZT12VDC](#) [AQ3A1-C2-ZT5VDC](#) [AQ2A1-C2-ZT12VDC](#) [AQ2A1-C2-ZT24VDC](#) [AQ2A1-C2-T12VDC](#) [AQ2A1-C2-T24VDC](#) [AQ2A1-C2-T5VDC](#) [AQ2A1-C2-ZT5VDC](#) [AQ3A1-C1-T24VDC](#)

Компания «Океан Электроники» предлагает заключение долгосрочных отношений при поставках импортных электронных компонентов на взаимовыгодных условиях!

Наши преимущества:

- Поставка оригинальных импортных электронных компонентов напрямую с производств Америки, Европы и Азии, а так же с крупнейших складов мира;
- Широкая линейка поставок активных и пассивных импортных электронных компонентов (более 30 млн. наименований);
- Поставка сложных, дефицитных, либо снятых с производства позиций;
- Оперативные сроки поставки под заказ (от 5 рабочих дней);
- Экспресс доставка в любую точку России;
- Помощь Конструкторского Отдела и консультации квалифицированных инженеров;
- Техническая поддержка проекта, помощь в подборе аналогов, поставка прототипов;
- Поставка электронных компонентов под контролем ВП;
- Система менеджмента качества сертифицирована по Международному стандарту ISO 9001;
- При необходимости вся продукция военного и аэрокосмического назначения проходит испытания и сертификацию в лаборатории (по согласованию с заказчиком);
- Поставка специализированных компонентов военного и аэрокосмического уровня качества (Xilinx, Altera, Analog Devices, Intersil, Interpoint, Microsemi, Actel, Aeroflex, Peregrine, VPT, Syfer, Eurofarad, Texas Instruments, MS Kennedy, Miteq, Cobham, E2V, MA-COM, Hittite, Mini-Circuits, General Dynamics и др.);

Компания «Океан Электроники» является официальным дистрибьютором и эксклюзивным представителем в России одного из крупнейших производителей разъемов военного и аэрокосмического назначения «JONHON», а так же официальным дистрибьютором и эксклюзивным представителем в России производителя высокотехнологичных и надежных решений для передачи СВЧ сигналов «FORSTAR».



JONHON

«JONHON» (основан в 1970 г.)

Разъемы специального, военного и аэрокосмического назначения:

(Применяются в военной, авиационной, аэрокосмической, морской, железнодорожной, горно- и нефтедобывающей отраслях промышленности)

«FORSTAR» (основан в 1998 г.)

ВЧ соединители, коаксиальные кабели, кабельные сборки и микроволновые компоненты:

(Применяются в телекоммуникациях гражданского и специального назначения, в средствах связи, РЛС, а так же военной, авиационной и аэрокосмической отраслях промышленности).



Телефон: 8 (812) 309-75-97 (многоканальный)

Факс: 8 (812) 320-03-32

Электронная почта: ocean@oceanchips.ru

Web: <http://oceanchips.ru/>

Адрес: 198099, г. Санкт-Петербург, ул. Калинина, д. 2, корп. 4, лит. А