

# SUPPLEMENT

Catalog

# 2014

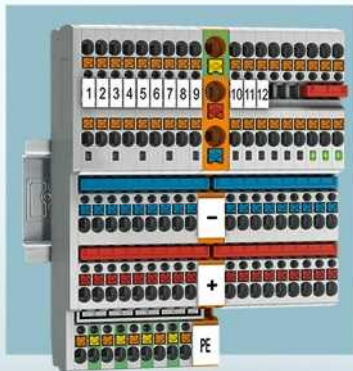
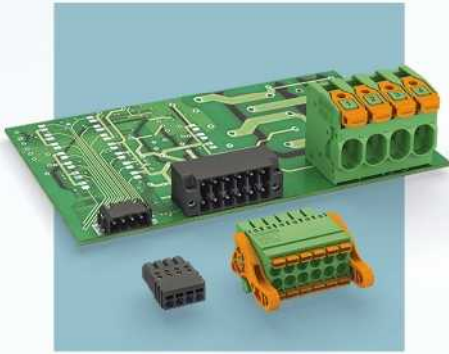

# The Phoenix Contact catalog system



## 1 PCB connection technology and electronics housing

- PCB terminal blocks and plug connectors
- Electronics housing



## 2 Connection technology for field devices

- Plug connectors
- Cables and connectors



## 3 Modular terminal blocks

- Modular terminal blocks



## 4 Sensor/actuator cabling and industrial plug connectors

- Sensor/actuator cabling
- Cables and connectors
- Plug connectors



## 5 Marking systems, tools, and mounting material

- Marking and labeling
- Tools
- Installation and mounting material



## 6 Surge protection and power supply units

- Lightning monitoring system
- Surge protection and interference filters
- Power supply units and UPS
- Protective devices



## 7 Interface technology and switching devices

- Electronic switching devices and motor control
- Measurement and control technology • Monitoring and signaling
- Relay modules • System cabling for controllers



## 8 Control technology, I/O systems and automation infrastructure

- Ethernet networks • Functional safety • HMIs and industrial PCs • I/O systems
- Industrial lighting and signaling • Industrial communication technology
- Fieldbus components and systems • Wireless data communication
- Process infrastructure • Software • Controllers

	<b>2   PCB connection technology and electronics housing</b>	Catalog 1
	<b>40   Connection technology for field devices</b>	Catalog 2
	<b>86   Modular terminal blocks</b>	Catalog 3
	<b>174   Sensor/actuator cabling and industrial connectors</b>	Catalog 4
	<b>240   Marking systems, tools, and mounting material</b>	Catalog 5
	<b>302   Surge protection and power supplies</b>	Catalog 6
	<b>322   Interface technology and switching devices</b>	Catalog 7
	<b>374   Control technology, I/O systems, and automation infrastructure</b>	Catalog 8
	<b>434   Index</b>	

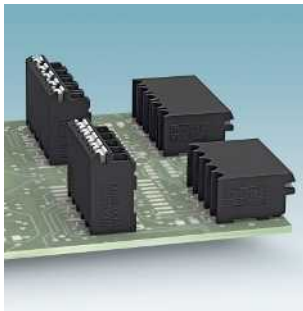

SMD PCB terminal blocks with push-in spring connection up to 1.5 mm<sup>2</sup>, 3.5 and 3.81 mm pitch  
**SPT-SMD 1,5/ ...-H-... R32** Page 7  
**SPT-SMD 1,5/ ...-V-... R32** Page 7

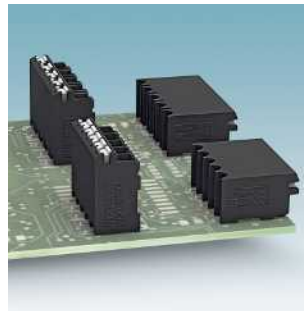

SMD PCB terminal blocks with push-in spring connection up to 1.5 mm<sup>2</sup>, 5.0 and 5.08 mm pitch  
**SPT-SMD 1,5/ ...-H-5,0 R32** Page 9  
**SPT-SMD 1,5/ ...-V-5,0 R32** Page 9



THR PCB terminal blocks with push-in spring connection up to 1.5 mm<sup>2</sup>, 3.5 and 3.81 mm pitch  
**SPT-THR 1,5/ ...-H-3,5 P26** Page 10  
**SPT-THR 1,5/...-V-3,5 P26** Page 11

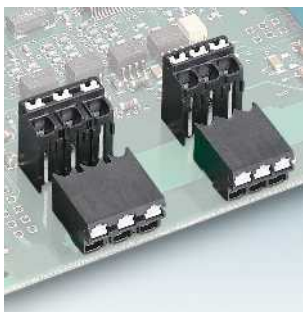

THR PCB terminal blocks with push-in spring connection up to 1.5 mm<sup>2</sup>, 5.0 and 5.08 mm pitch  
**SPT-THR 1,5/ ...-H-5,0 P26** Page 12  
**SPT-THR 1,5/ ...-V-5,0 P26** Page 13

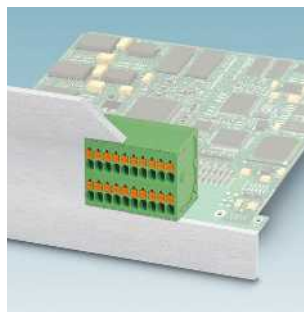

Double-row PCB terminal block with push-in spring connection up to 1.5 mm<sup>2</sup>, 3.5 mm pitch  
**SPTD 1,5/ ...-H-3,5** Page 15

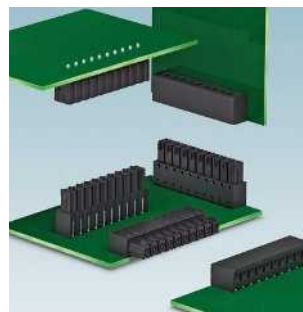

Inverted headers for reflow processes, 3.5 mm pitch  
**IMC 1,5/ ...-G-3,5 P20 THR** Page 16  
**IMCV 1,5/ ...-G-3,5 P20 THR** Page 17

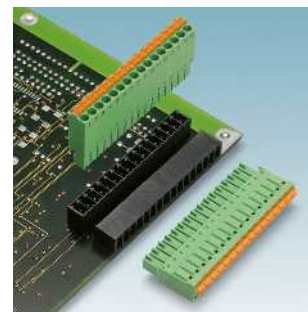

Single-level headers, 13 to 20-pos., for reflow processes, 3.81 mm pitch  
**MC 1,5/...-G-3,81 P20 THR** Page 18  
**MCV 1,5/...-G-3,81 P20 THR** Page 19



Taped single-level headers, 13 to 20-pos., for reflow processes, 3.81 mm pitch  
**MC 1,5/...-G-3,81 P20 THRR...** Page 20  
**MCV 1,5/...-G-3,81 P20 THRR...** Page 21

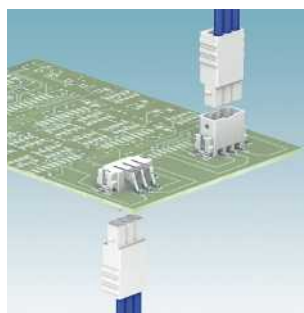

Plugs with push-in spring connection up to 0.75 mm<sup>2</sup>, 2.5 mm pitch  
**PTSM 0,5/ ...-HV-2,5-SMD WH R32** Page 23  
**PTSM 0,5/ ...-HTB-2,5-SMD WH R32** Page 23

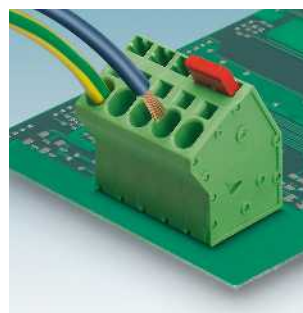

Angled PCB terminal blocks with push-in spring connection up to 6 mm<sup>2</sup>, 7.5 mm pitch  
**SPTA 5/ ...-7,5-ZB** Page 25

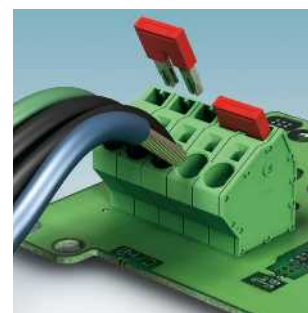

Angled PCB terminal blocks with push-in spring connection up to 6 mm<sup>2</sup>, 10 mm pitch  
**SPTA 16/ ...-10,0-ZB** Page 27

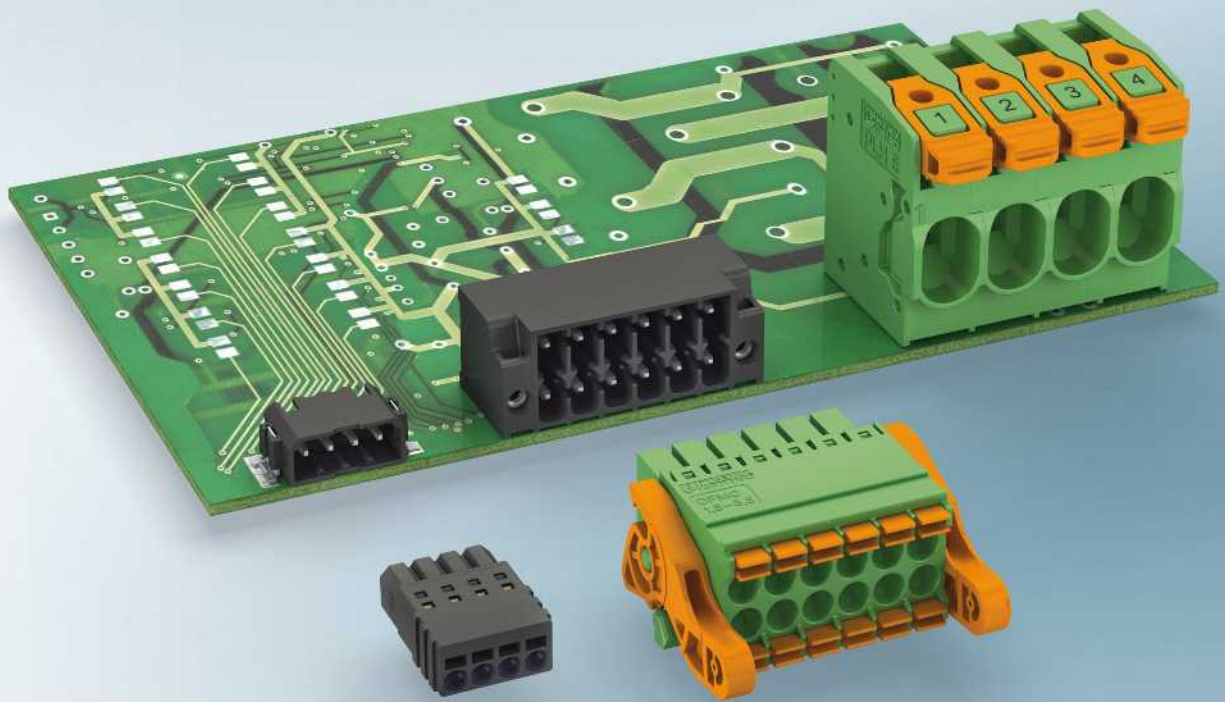

Feed-through terminal blocks with push-in spring connection up to 16 mm<sup>2</sup> for high-current applications

**PWO 16-UW**

Page 29

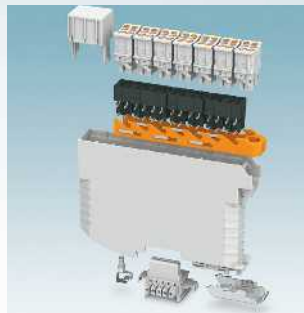

ME-IO electronics housing with front connection

**ME-IO 18, 8... HSC...**

Page 30  
Page 30



PCO... power connector for ME MAX housing

**PCO ....-L KMGY PBR 42A...**

Page 38  
Page 38



ME TBUS 4P1S and ME TBUS ADAPTER for ME and ME MAX housing

**ME ....TBUS 1,5/4P1S KMGY ME ....TBUS ADAPTER KMGY** Page 39  
Page 39

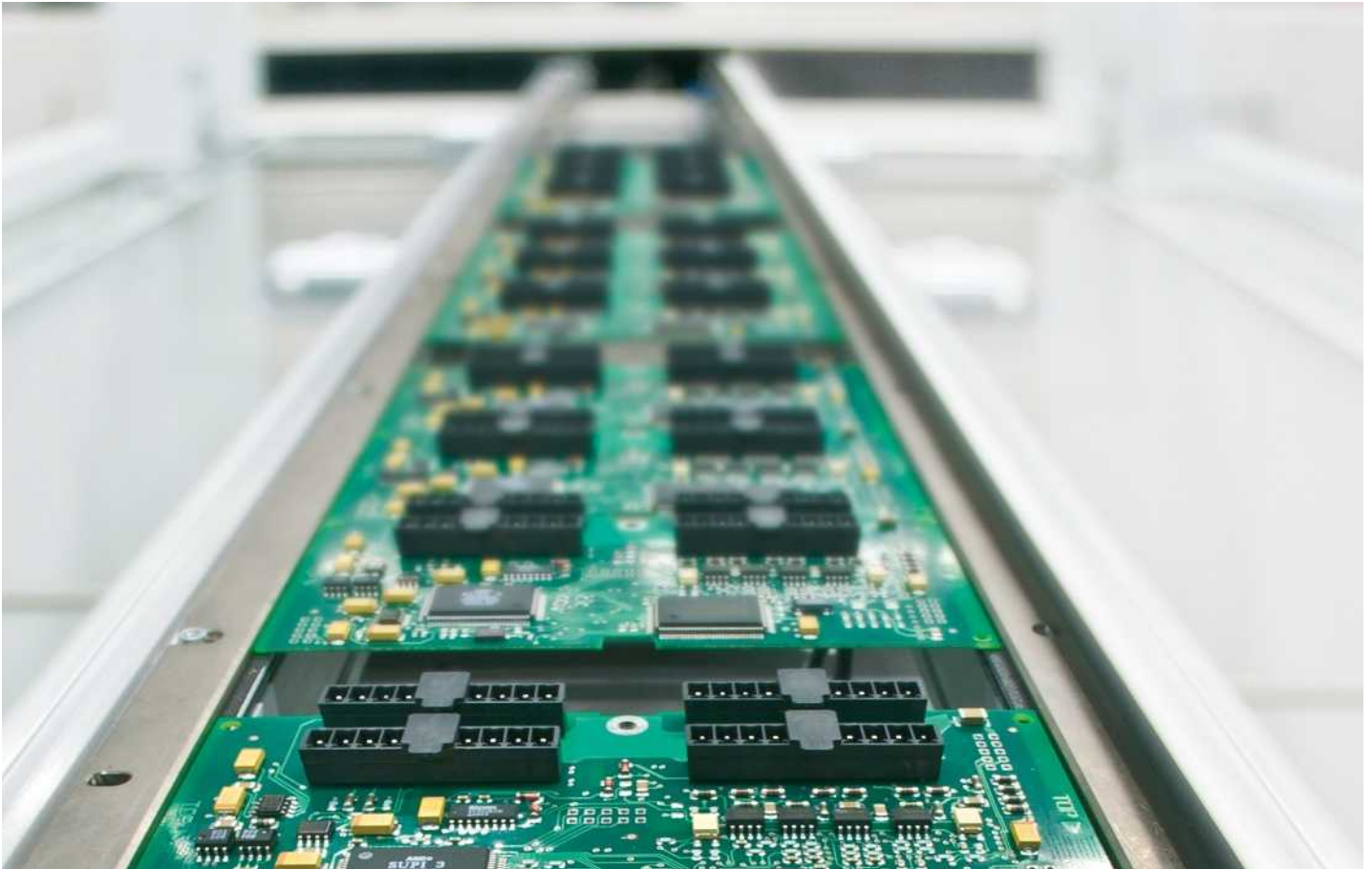

### SMD- Surface Mount Device

Generally the term SMD or SMT (surface mount technology) refers to the dominant production method currently used for assemblies in electronics production. In this case solder paste is applied to the contact surfaces of the PCB. The surface contacts of the component are dipped in this paste and soldered by means of the reflow soldering process.

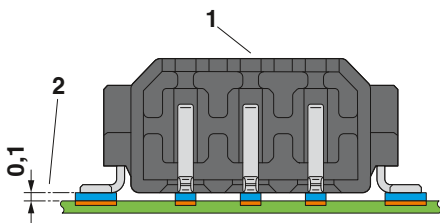

### Properties of SMD/THR components in the reflow process

- Resistance to high temperatures
- Suction areas (1) for automatic PCB assembly by means of pick-and-place
- Stability in the case of mechanical loads
- Coplanarity (2) (evenness) of the SMD contacts

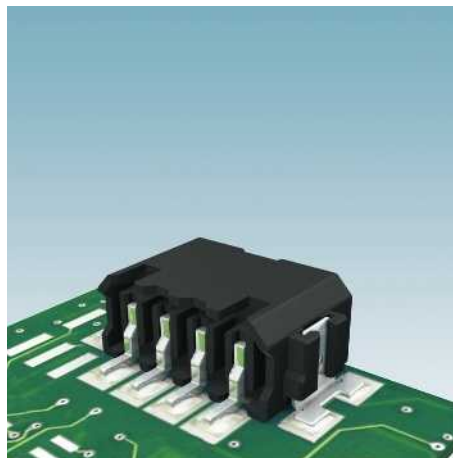

### PTSM 0,5...SMD

In addition to the SMD contacts, the components have anchor metal on the side. This ensures that the insertion and withdrawal force of the plugs does not overload the contact points.

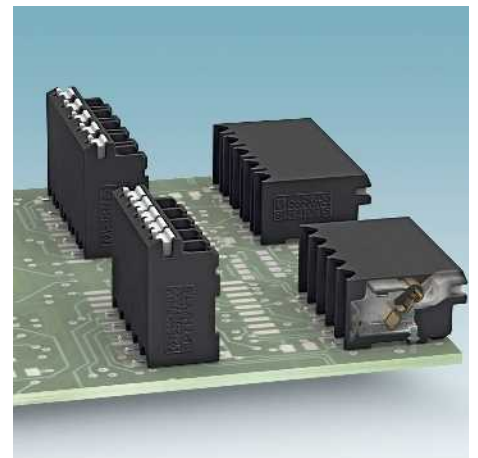

### SPT-SMD 1,5...

Additional solder pins on the side position the component on the PCB and prevent it moving during the process. Moreover, they absorb the force when the conductors are connected.

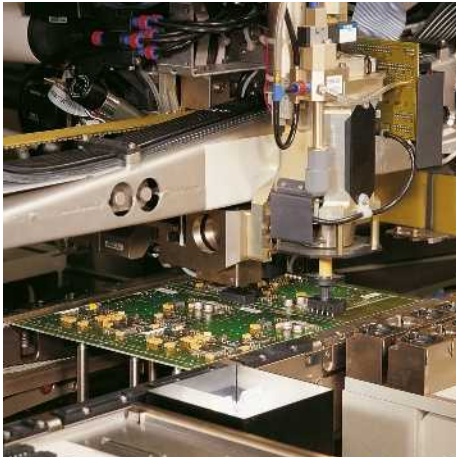

The qualification of the SMD connectors is based on IPC/JEDEC J-STD020 indicating the MSL (Moisture Sensitive Level) and the max. processing temperatures. The SMD/THR components meet MSL 1 or 2 which means that dry bag packaging is not required.



The standard tape width for tape-on-reel packaging supports automatic PCB assembly in pick-and-place applications.

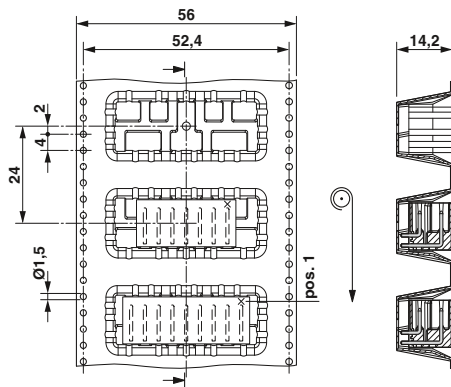

Dimensional drawings of tape reels and suction areas and pads can be found online at [phoenixcontact.net/products](http://phoenixcontact.net/products).

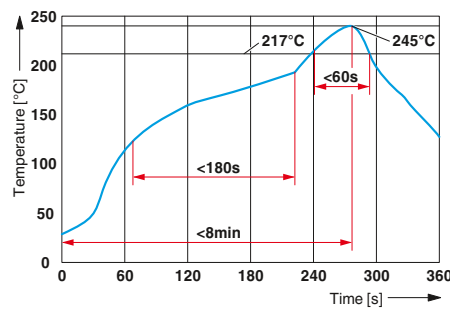

**Reflow soldering**

The reflow process and the required temperature profiles are described in SMD standards DIN EN 61760-1 or also IEC 60068-2-58. The profiles described are usually used for test purposes, but are also recommended for the application.

## PCB terminal blocks with 2.54 to 7.62 mm pitch

### SMD PCB terminal blocks with push-in spring connection up to 1.5 mm<sup>2</sup>

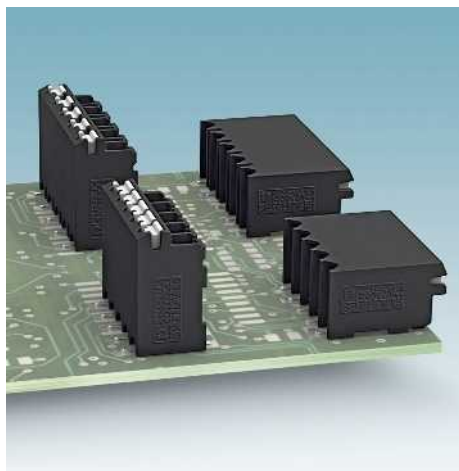





- Push-in direct plug-in technology for solid and stranded conductors
- Suitable for use in SMD processes
- Horizontal and vertical design with a 3.5 mm and 3.81 mm pitch
- High stability due to anchor pins or two soldering pads per position
- Supplied in taped packaging according to IEC 60286-3 for automatic assembly
- Touch connection for voltage testing using a 1 mm Ø test pin

#### Notes:

Dimensional drawings of tape reels and place pads can be found online at [phoenixcontact.net/products](http://phoenixcontact.net/products).

1) Current carrying capacity curve available on request.

#### For accessories, see Catalog 1

For all types	Type	Page
	Screwdriver <b>SZS 0,4 x 2,5</b> Order No. 1205037	
	Marker cards <b>SK 3,5/2,8 or SK 3,81/2,8</b>	796
	Ferrules with and without plastic sleeve	834
	Crimping pliers for 0.25 to 6 mm <sup>2</sup> <b>CRIMPFOX 6</b> Order No. 1212034	
	Test plug <b>MPS-MT 1-S</b> Order No. 1944372	831

#### Technical data

Technical data in accordance to IEC / DIN VDE	
Rated current / conductor cross section	[A] / [mm <sup>2</sup> ]
Rated insulation voltage for pollution degree 2	[V]
Pitch	[mm]
Connection capacity	
Solid / stranded	[mm <sup>2</sup> ] / [mm <sup>2</sup> ] / AWG
Stranded with ferrules without plastic sleeve	[mm <sup>2</sup> ]
Stranded with ferrules with plastic sleeve	[mm <sup>2</sup> ]
Insulation coordination	
Surge voltage category / pollution degree	
Rated insulation voltage	[V]
Rated surge voltage	[kV]
Approval data (UL/CUL)	Use Group
Nominal voltage	[V]
Nominal current	[A]
Connection capacity AWG	AWG
Approval data (CSA)	Use Group
Nominal voltage	[V]
Nominal current	[A]
Connection capacity AWG	AWG
General data	
Stripping length	[mm]
Type of insulation material / insulation material group	
Inflammability class according to UL 94	
Drill hole diameter / pin dimensions	[mm]

#### SPT-SMD 1,5/...H...R...

13.5 <sup>1)</sup> / 1.5			13.5 <sup>1)</sup> / 1.5		
160			160		
3.5 / 3.81			3.5 / 3.81		
0.2 - 1.5 / 0.2 - 1.5 / 24 - 16			0.2 - 1.5 / 0.2 - 1.5 / 24 - 16		
0.2 - 1.5			0.2 - 1.5		
0.2 - 0.75			0.2 - 0.75		
III / 3	III / 2	II / 2	III / 3	III / 2	II / 2
160	160	320	160	160	320
2.5	2.5	2.5	2.5	2.5	2.5
B	C	D	B	C	D
-	-	-	-	-	-
-	-	-	-	-	-
-	-	-	-	-	-
B	C	D	B	C	D
-	-	-	-	-	-
-	-	-	-	-	-
-	-	-	-	-	-
8			8		
LCP / IIIa			LCP / IIIa		
V0			V0		
1.1 / 0.7 x 0.3			1.1 / 0.7 x 0.3		

#### SPT-SMD 1,5/...V...R...

No. of pos.	Dim. a [mm]
2	3.50
3	7.00
4	10.50
5	14.00
6	17.50
7	21.00
8	24.50
9	28.00
10	31.50
11	35.00
12	38.50
2	3.81
3	7.62
4	11.43
5	15.24
6	19.05
7	22.86
8	26.67
9	30.48
10	34.29
11	38.10
12	41.91





Taped PCB terminal block, connection direction horizontal to the PCB



Taped PCB terminal block, connection direction vertical to the PCB

Dimensional drawing

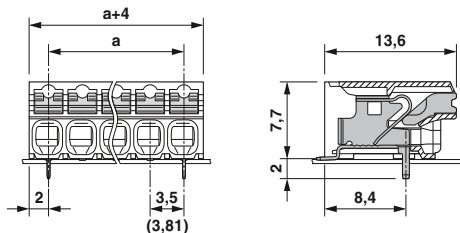

Dimensional drawing

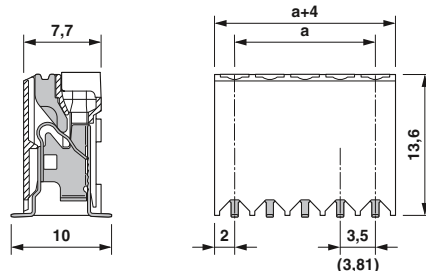

Drilling diagram

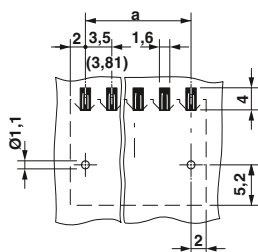

Drilling diagram

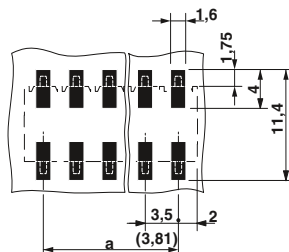

Ordering data

Type	Order No.	Pcs. / Pkt.
Pitch 3.5 mm, color: black		
SPT-SMD 1,5/ 2-H-3,5 R24	1824527	300
SPT-SMD 1,5/ 3-H-3,5 R24	1824530	300
SPT-SMD 1,5/ 4-H-3,5 R44	1824543	300
SPT-SMD 1,5/ 5-H-3,5 R44	1824556	300
SPT-SMD 1,5/ 6-H-3,5 R44	1824569	300
SPT-SMD 1,5/ 7-H-3,5 R44	1824572	300
SPT-SMD 1,5/ 8-H-3,5 R72	1824585	300
SPT-SMD 1,5/ 9-H-3,5 R72	1824598	300
SPT-SMD 1,5/10-H-3,5 R72	1824608	300
SPT-SMD 1,5/11-H-3,5 R72	1824611	300
SPT-SMD 1,5/12-H-3,5 R72	1824624	300
3.81 mm pitch, color: black		
SPT-SMD 1,5/ 2-H-3,81 R24	1824637	300
SPT-SMD 1,5/ 3-H-3,81 R24	1824640	300
SPT-SMD 1,5/ 4-H-3,81 R44	1824653	300
SPT-SMD 1,5/ 5-H-3,81 R44	1824666	300
SPT-SMD 1,5/ 6-H-3,81 R44	1824679	300
SPT-SMD 1,5/ 7-H-3,81 R44	1824682	300
SPT-SMD 1,5/ 8-H-3,81 R72	1824695	300
SPT-SMD 1,5/ 9-H-3,81 R72	1824705	300
SPT-SMD 1,5/10-H-3,81 R72	1824718	300
SPT-SMD 1,5/11-H-3,81 R72	1824721	300
SPT-SMD 1,5/12-H-3,81 R72	1824734	300

Ordering data

Type	Order No.	Pcs. / Pkt.
Pitch 3.5 mm, color: black		
SPT-SMD 1,5/ 2-V-3,5 R24	1824080	200
SPT-SMD 1,5/ 3-V-3,5 R32	1824093	200
SPT-SMD 1,5/ 4-V-3,5 R44	1824103	200
SPT-SMD 1,5/ 5-V-3,5 R44	1824116	200
SPT-SMD 1,5/ 6-V-3,5 R44	1824129	200
SPT-SMD 1,5/ 7-V-3,5 R44	1824132	200
SPT-SMD 1,5/ 8-V-3,5 R72	1824145	200
SPT-SMD 1,5/ 9-V-3,5 R72	1824158	200
SPT-SMD 1,5/10-V-3,5 R72	1824161	200
SPT-SMD 1,5/11-V-3,5 R72	1824174	200
SPT-SMD 1,5/12-V-3,5 R72	1824187	200
3.81 mm pitch, color: black		
SPT-SMD 1,5/ 2-V-3,81 R24	1824190	200
SPT-SMD 1,5/ 3-V-3,81 R32	1824200	200
SPT-SMD 1,5/ 4-V-3,81 R44	1824213	200
SPT-SMD 1,5/ 5-V-3,81 R44	1824226	200
SPT-SMD 1,5/ 6-V-3,81 R44	1824239	200
SPT-SMD 1,5/ 7-V-3,81 R44	1824242	200
SPT-SMD 1,5/ 8-V-3,81 R72	1824255	200
SPT-SMD 1,5/ 9-V-3,81 R72	1824268	200
SPT-SMD 1,5/10-V-3,81 R72	1824271	200
SPT-SMD 1,5/11-V-3,81 R72	1824284	200
SPT-SMD 1,5/12-V-3,81 R72	1824297	200

## PCB terminal blocks with 2.54 to 7.62 mm pitch

### SMD PCB terminal blocks with push-in spring connection up to 1.5 mm<sup>2</sup>

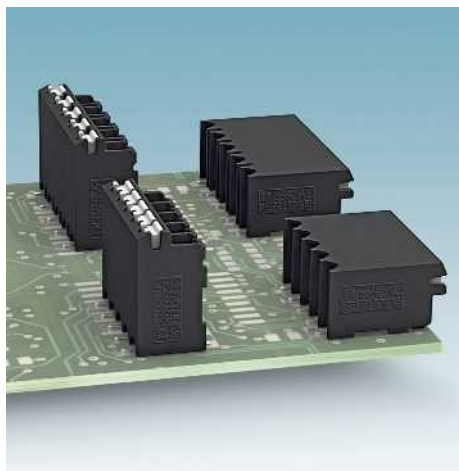





- Push-in direct plug-in technology for solid and stranded conductors
- Suitable for use in SMD processes
- Horizontal and vertical design with a 5.0 mm and 5.08 mm pitch
- High stability due to anchor pins or two soldering pads per position
- Supplied in taped packaging according to IEC 60286-3 for automatic assembly
- Touch connection for voltage testing using a 1 mm Ø test pin

#### Notes:

Dimensional drawings of tape reels and place pads can be found online at [phoenixcontact.net/products](http://phoenixcontact.net/products).

1) Current carrying capacity curve available on request.

#### For accessories, see Catalog 1

For all types	Type	Page
	Screwdriver <b>SZS 0,4 x 2,5</b> Order No. 1205037	
	Marker cards <b>SK 5/3,8 or SK 5,08/3,8</b>	798
	Ferrules with and without plastic sleeve	834
	Crimping pliers for 0.25 to 6 mm <sup>2</sup> <b>CRIMPFOX 6</b> Order No. 1212034	
	Test plug <b>MPS-MT 1-S</b> Order No. 1944372	831

#### Technical data

Technical data in accordance to IEC / DIN VDE	
Rated current / conductor cross section	[A] / [mm <sup>2</sup> ]
Rated insulation voltage for pollution degree 2	[V]
Pitch	[mm]
Connection capacity	
Solid / stranded	[mm <sup>2</sup> ] / [mm <sup>2</sup> ] / AWG
Stranded with ferrules without plastic sleeve	[mm <sup>2</sup> ]
Stranded with ferrules with plastic sleeve	[mm <sup>2</sup> ]
Insulation coordination	
Surge voltage category / pollution degree	
Rated insulation voltage	[V]
Rated surge voltage	[kV]
Approval data (UL/CUL)	Use Group
Nominal voltage	[V]
Nominal current	[A]
Connection capacity AWG	AWG
Approval data (CSA)	Use Group
Nominal voltage	[V]
Nominal current	[A]
Connection capacity AWG	AWG
General data	
Stripping length	[mm]
Type of insulation material / insulation material group	
Inflammability class according to UL 94	
Drill hole diameter / pin dimensions	[mm]

#### SPT-SMD 1,5/...H..R

13.5 <sup>1)</sup> / 1.5		
320		
5 / 5.08		
0.2 - 1.5 / 0.2 - 1.5 / 24 - 16		
0.2 - 1.5		
0.2 - 0.75		
III / 3	III / 2	II / 2
250	320	500
4	4	4
B	C	D
-	-	-
-	-	-
-	-	-
B	C	D
-	-	-
-	-	-
-	-	-
8		
LCP / IIIa		
V0		
1.1 / 0.7 x 0.3 mm		

#### SPT-SMD 1,5/...V...R...

13.5 <sup>1)</sup> / 1.5		
320		
5 / 5.08		
0.2 - 1.5 / 0.2 - 1.5 / 24 - 16		
0.2 - 1.5		
0.2 - 0.75		
III / 3	III / 2	II / 2
250	320	500
4	4	4
B	C	D
-	-	-
-	-	-
-	-	-
B	C	D
-	-	-
-	-	-
-	-	-
8		
LCP / IIIa		
V0		
1.1 / 0.7 x 0.3 mm		

No. of pos.	Dim. a [mm]
2	5.00
3	10.00
4	15.00
5	20.00
6	25.00
7	30.00
8	35.00
9	40.00
10	45.00
11	50.00
12	55.00
2	5.08
3	10.16
4	15.24
5	20.32
6	25.40
7	30.48
8	35.56
9	40.64
10	45.72
11	50.80
12	55.88



Taped PCB terminal block, connection direction horizontal to the PCB



Taped PCB terminal block, connection direction vertical to the PCB

Dimensional drawing

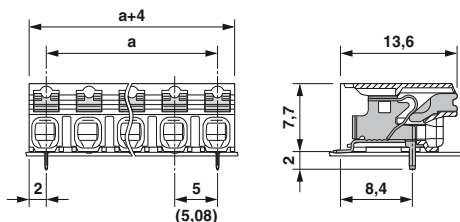

Dimensional drawing

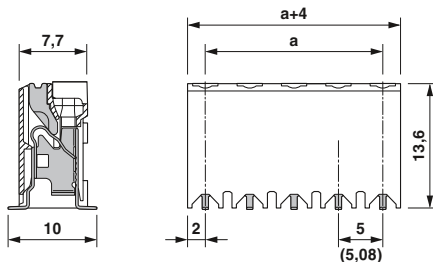

Drilling diagram

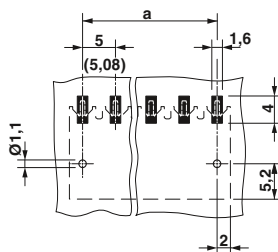

Drilling diagram

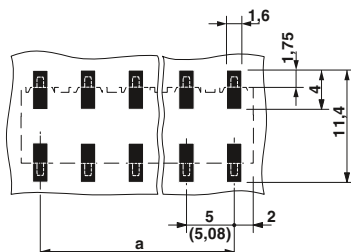

Ordering data

Type	Order No.	Pcs. / Pkt.
Pitch 5.0 mm, color: black		
SPT-SMD 1,5/ 2-H-5,0 R24	1824747	300
SPT-SMD 1,5/ 3-H-5,0 R32	1824750	300
SPT-SMD 1,5/ 4-H-5,0 R44	1824763	300
SPT-SMD 1,5/ 5-H-5,0 R44	1824776	300
SPT-SMD 1,5/ 6-H-5,0 R44	1824789	300
SPT-SMD 1,5/ 7-H-5,0 R88	1824792	300
SPT-SMD 1,5/ 8-H-5,0 R88	1824802	300
SPT-SMD 1,5/ 9-H-5,0 R88	1824815	300
SPT-SMD 1,5/10-H-5,0 R88	1824828	300
SPT-SMD 1,5/11-H-5,0 R88	1824831	300
SPT-SMD 1,5/12-H-5,0 R88	1824844	300
Headers, 5.08 mm pitch, color: black		
SPT-SMD 1,5/ 2-H-5,08 R24	1824857	300
SPT-SMD 1,5/ 3-H-5,08 R32	1824860	300
SPT-SMD 1,5/ 4-H-5,08 R44	1824873	300
SPT-SMD 1,5/ 5-H-5,08 R44	1824885	300
SPT-SMD 1,5/ 6-H-5,08 R44	1824899	300
SPT-SMD 1,5/ 7-H-5,08 R88	1824909	300
SPT-SMD 1,5/ 8-H-5,08 R88	1824912	300
SPT-SMD 1,5/ 9-H-5,08 R88	1824925	300
SPT-SMD 1,5/10-H-5,08 R88	1824938	300
SPT-SMD 1,5/11-H-5,08 R88	1824941	300
SPT-SMD 1,5/12-H-5,08 R88	1824954	300

Ordering data

Type	Order No.	Pcs. / Pkt.
Pitch 5.0 mm, color: black		
SPT-SMD 1,5/ 2-V-5,0 R24	1824307	200
SPT-SMD 1,5/ 3-V-5,0 R32	1824310	200
SPT-SMD 1,5/ 4-V-5,0 R44	1824323	200
SPT-SMD 1,5/ 5-V-5,0 R44	1824336	200
SPT-SMD 1,5/ 6-V-5,0 R44	1824349	200
SPT-SMD 1,5/ 7-V-5,0 R88	1824352	200
SPT-SMD 1,5/ 8-V-5,0 R88	1824365	200
SPT-SMD 1,5/ 9-V-5,0 R88	1824378	200
SPT-SMD 1,5/10-V-5,0 R88	1824381	200
SPT-SMD 1,5/11-V-5,0 R88	1824394	200
SPT-SMD 1,5/12-V-5,0 R88	1824404	200
Headers, 5.08 mm pitch, color: black		
SPT-SMD 1,5/ 2-V-5,08 R24	1824417	200
SPT-SMD 1,5/ 3-V-5,08 R32	1824420	200
SPT-SMD 1,5/ 4-V-5,08 R44	1824433	200
SPT-SMD 1,5/ 5-V-5,08 R44	1824446	200
SPT-SMD 1,5/ 6-V-5,08 R44	1824459	200
SPT-SMD 1,5/ 7-V-5,08 R88	1824462	200
SPT-SMD 1,5/ 8-V-5,08 R88	1824475	200
SPT-SMD 1,5/ 9-V-5,08 R88	1824488	200
SPT-SMD 1,5/10-V-5,08 R88	1824491	200
SPT-SMD 1,5/11-V-5,08 R88	1824501	200
SPT-SMD 1,5/12-V-5,08 R88	1824514	200

## PCB terminal blocks with 2.54 to 7.62 mm pitch

### THR PCB terminal blocks with push-in spring connection up to 1.5 mm<sup>2</sup>

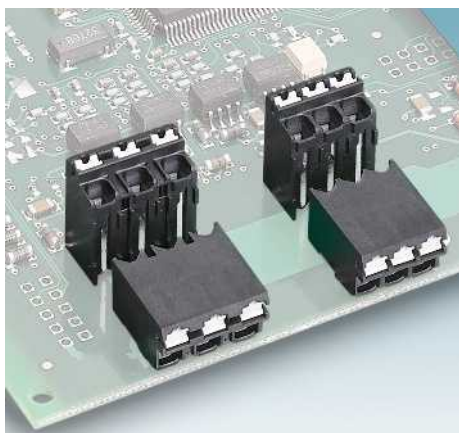

- Push-in direct plug-in technology for solid or stranded conductors
- Suitable for use in SMT reflow processes
- Horizontal and vertical design with 3.5 mm and 3.81 mm pitch
- Two solder pins for a high level of stability on the PCB
- Standard pin length of 2.6 mm also suitable for wave soldering processes
- Supplied in tape-on-reel packing according to IEC 60286-3 for automated mounting in the reflow process with pin length of 2.0 mm
- Touch connection for voltage testing using a 1 mm Ø test pin

#### Notes:





Dimensional drawings of tape reels and place pads can be found online at [phoenixcontact.net/products](http://phoenixcontact.net/products).

1) Current carrying capacity curve upon request.



Pin length of 2.6 mm, box-packaged PCB terminal blocks, connection direction horizontal to the PCB

#### For accessories, see Catalog 1

For all types	Type	Page
	Screwdriver SZS 0,4 x 2,5 Order No. 1205037	
	Ferrules with and without plastic sleeve	834
	Crimping pliers for 0.25 to 6 mm <sup>2</sup> CRIMPFOX 6 Order No. 1212034	
	Test plug MPS-MT 1-S Order No. 1944372	831

#### Dimensional drawing

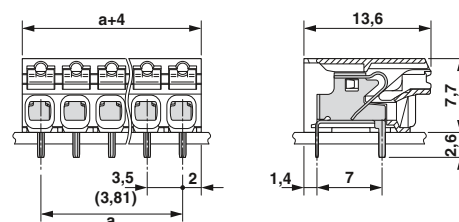

#### Drilling diagram

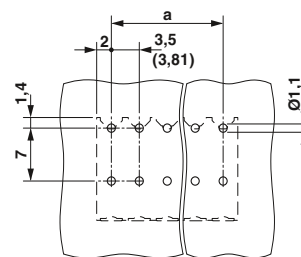

#### Technical data

Technical data in accordance to IEC / DIN VDE	
Rated current / conductor cross section	[A] / [mm <sup>2</sup> ]
Rated insulation voltage for pollution degree 2	[V]
Pitch	[mm]
Connection capacity	
Solid / stranded	[mm <sup>2</sup> ] / [mm <sup>2</sup> ] / AWG
Stranded with ferrules without plastic sleeve	[mm <sup>2</sup> ]
Stranded with ferrules with plastic sleeve	[mm <sup>2</sup> ]
Multi-conductor connection capacity (two conductors with the same cross section)	
Solid / stranded	[mm <sup>2</sup> ]
Stranded with ferrules without plastic sleeve	[mm <sup>2</sup> ]
Stranded with TWIN ferrule with plastic sleeve	[mm <sup>2</sup> ]
Insulation coordination	
Surge voltage category / pollution degree	III / 3 III / 2 II / 2
Rated insulation voltage	[V]
Rated surge voltage	[kV]
Approval data (UL/CUL)	Use Group
Nominal voltage	[V]
Nominal current	[A]
Connection capacity AWG	AWG
Approval data (CSA)	Use Group
Nominal voltage	[V]
Nominal current	[A]
Connection capacity AWG	AWG
General data	
Stripping length	[mm]
Type of insulation material / insulation material group	
Inflammability class according to UL 94	
Drill hole diameter / pin dimensions	[mm]

13.5 <sup>1)</sup> / 1.5		
160		
3.5 / 3.81		
0.2 - 1.5 / 0.2 - 1.5 / 24 - 16		
0.2 - 1.5		
0.2 - 0.75		
- / -		
-		
-		
III / 3	III / 2	II / 2
160	160	320
2.5	2.5	2.5
B	C	D
-	-	-
-	-	-
-	-	-
B	C	D
-	-	-
-	-	-
-	-	-
-	-	-
8		
LCP / IIIa		
V0		
1.1 / 0.7 x 0.3		

No. of pos.	Dim. a [mm]
2	3.50
3	7.00
4	10.50
5	14.00
6	17.50
7	21.00
8	24.50
9	28.00
10	31.50
11	35.00
12	38.50

#### Ordering data

Type	Order No.	Pcs. / Pkt.
<b>Pitch 3.5 mm, color: black</b>		
SPT-THR 1,5/ 2-H-3,5 P26	1822752	370
SPT-THR 1,5/ 3-H-3,5 P26	1822765	240
SPT-THR 1,5/ 4-H-3,5 P26	1822778	170
SPT-THR 1,5/ 5-H-3,5 P26	1822781	150
SPT-THR 1,5/ 6-H-3,5 P26	1822794	130
SPT-THR 1,5/ 7-H-3,5 P26	1822804	110
SPT-THR 1,5/ 8-H-3,5 P26	1822817	80
SPT-THR 1,5/ 9-H-3,5 P26	1822820	80
SPT-THR 1,5/10-H-3,5 P26	1822833	60
SPT-THR 1,5/11-H-3,5 P26	1822846	60
SPT-THR 1,5/12-H-3,5 P26	1822859	60
<b>3.81 mm pitch, color: black</b>		
SPT-THR 1,5/ 2-H-3,81 P26	1822862	350
SPT-THR 1,5/ 3-H-3,81 P26	1822875	240
SPT-THR 1,5/ 4-H-3,81 P26	1822888	170
SPT-THR 1,5/ 5-H-3,81 P26	1822891	130
SPT-THR 1,5/ 6-H-3,81 P26	1822901	110
SPT-THR 1,5/ 7-H-3,81 P26	1822914	80
SPT-THR 1,5/ 8-H-3,81 P26	1822927	80
SPT-THR 1,5/ 9-H-3,81 P26	1822930	60
SPT-THR 1,5/10-H-3,81 P26	1822943	60
SPT-THR 1,5/11-H-3,81 P26	1822956	60
SPT-THR 1,5/12-H-3,81 P26	1822969	60



Pin length of 2.6 mm, box-packaged PCB terminal blocks, connection direction vertical to the PCB



Pin length of 2.0 mm, taped PCB terminal blocks, connection direction horizontal to the PCB



Pin length of 2.0 mm, taped PCB terminal blocks, connection direction vertical to the PCB



### Dimensional drawing

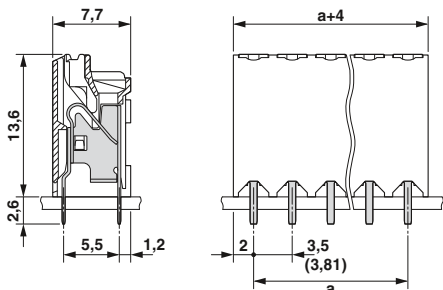

### Drilling diagram

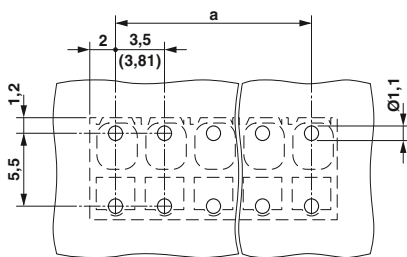

### Ordering data

Type	Order No.	Pcs. / Pkt.
<b>Pitch 3.5 mm, color: black</b>		
SPT-THR 1,5/ 2-V-3,5 P26	1822312	540
SPT-THR 1,5/ 3-V-3,5 P26	1822325	350
SPT-THR 1,5/ 4-V-3,5 P26	1822338	250
SPT-THR 1,5/ 5-V-3,5 P26	1822341	220
SPT-THR 1,5/ 6-V-3,5 P26	1822354	190
SPT-THR 1,5/ 7-V-3,5 P26	1822367	160
SPT-THR 1,5/ 8-V-3,5 P26	1822370	120
SPT-THR 1,5/ 9-V-3,5 P26	1822383	120
SPT-THR 1,5/10-V-3,5 P26	1822396	90
SPT-THR 1,5/11-V-3,5 P26	1822406	90
SPT-THR 1,5/12-V-3,5 P26	1822419	90
<b>3.81 mm pitch, color: black</b>		
SPT-THR 1,5/ 2-V-3,81 P26	1822422	510
SPT-THR 1,5/ 3-V-3,81 P26	1822435	350
SPT-THR 1,5/ 4-V-3,81 P26	1822448	250
SPT-THR 1,5/ 5-V-3,81 P26	1822451	190
SPT-THR 1,5/ 6-V-3,81 P26	1822464	160
SPT-THR 1,5/ 7-V-3,81 P26	1822477	120
SPT-THR 1,5/ 8-V-3,81 P26	1822480	120
SPT-THR 1,5/ 9-V-3,81 P26	1822493	90
SPT-THR 1,5/10-V-3,81 P26	1822503	90
SPT-THR 1,5/11-V-3,81 P26	1822516	90
SPT-THR 1,5/12-V-3,81 P26	1822529	60



### Dimensional drawing

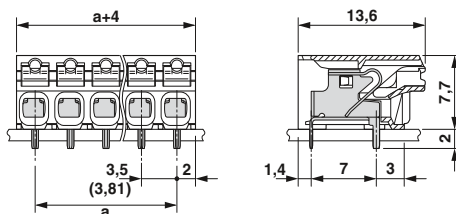

### Drilling diagram

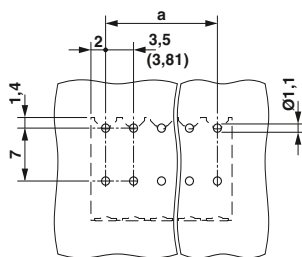

### Ordering data

Type	Order No.	Pcs. / Pkt.
<b>Pitch 3.5 mm, color: black</b>		
SPT-THR 1,5/ 2-H-3,5 P20 R24	1823638	250
SPT-THR 1,5/ 3-H-3,5 P20 R32	1823641	250
SPT-THR 1,5/ 4-H-3,5 P20 R32	1823654	250
SPT-THR 1,5/ 5-H-3,5 P20 R32	1823667	250
SPT-THR 1,5/ 6-H-3,5 P20 R44	1823670	250
SPT-THR 1,5/ 7-H-3,5 P20 R44	1823683	250
SPT-THR 1,5/ 8-H-3,5 P20 R44	1823696	250
SPT-THR 1,5/ 9-H-3,5 P20 R72	1823706	250
SPT-THR 1,5/10-H-3,5 P20 R72	1823719	250
SPT-THR 1,5/11-H-3,5 P20 R72	1823722	250
SPT-THR 1,5/12-H-3,5 P20 R72	1823735	250
<b>3.81 mm pitch, color: black</b>		
SPT-THR 1,5/ 2-H-3,81 P20 R24	1823748	250
SPT-THR 1,5/ 3-H-3,81 P20 R32	1823751	250
SPT-THR 1,5/ 4-H-3,81 P20 R32	1823764	250
SPT-THR 1,5/ 5-H-3,81 P20 R32	1823777	250
SPT-THR 1,5/ 6-H-3,81 P20 R44	1823780	250
SPT-THR 1,5/ 7-H-3,81 P20 R44	1823793	250
SPT-THR 1,5/ 8-H-3,81 P20 R44	1823803	250
SPT-THR 1,5/ 9-H-3,81 P20 R72	1823816	250
SPT-THR 1,5/10-H-3,81 P20 R72	1823829	250
SPT-THR 1,5/11-H-3,81 P20 R72	1823832	250
SPT-THR 1,5/12-H-3,81 P20 R72	1823845	250



### Dimensional drawing

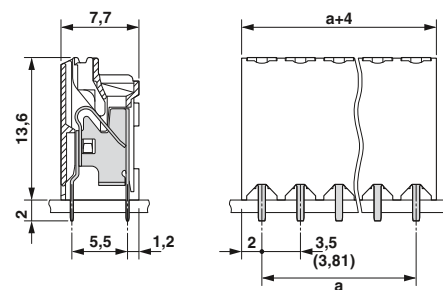

### Drilling diagram

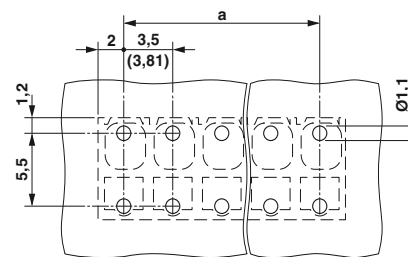

### Ordering data

Type	Order No.	Pcs. / Pkt.
<b>Pitch 3.5 mm, color: black</b>		
SPT-THR 1,5/ 2-V-3,5 P20 R24	1823191	180
SPT-THR 1,5/ 3-V-3,5 P20 R24	1823201	180
SPT-THR 1,5/ 4-V-3,5 P20 R44	1823214	180
SPT-THR 1,5/ 5-V-3,5 P20 R44	1823227	180
SPT-THR 1,5/ 6-V-3,5 P20 R44	1823230	180
SPT-THR 1,5/ 7-V-3,5 P20 R44	1823243	180
SPT-THR 1,5/ 8-V-3,5 P20 R72	1823256	180
SPT-THR 1,5/ 9-V-3,5 P20 R72	1823269	180
SPT-THR 1,5/10-V-3,5 P20 R72	1823272	180
SPT-THR 1,5/11-V-3,5 P20 R72	1823285	180
SPT-THR 1,5/12-V-3,5 P20 R72	1823298	180
<b>3.81 mm pitch, color: black</b>		
SPT-THR 1,5/ 2-V-3,81 P20 R24	1823308	180
SPT-THR 1,5/ 3-V-3,81 P20 R24	1823311	180
SPT-THR 1,5/ 4-V-3,81 P20 R44	1823324	180
SPT-THR 1,5/ 5-V-3,81 P20 R44	1823337	180
SPT-THR 1,5/ 6-V-3,81 P20 R44	1823340	180
SPT-THR 1,5/ 7-V-3,81 P20 R44	1823353	180
SPT-THR 1,5/ 8-V-3,81 P20 R72	1823366	180
SPT-THR 1,5/ 9-V-3,81 P20 R72	1823379	180
SPT-THR 1,5/10-V-3,81 P20 R72	1823382	180
SPT-THR 1,5/11-V-3,81 P20 R72	1823395	180
SPT-THR 1,5/12-V-3,81 P20 R72	1823405	180

## PCB terminal blocks with 2.54 to 7.62 mm pitch

### THR PCB terminal blocks with push-in spring connection up to 1.5 mm<sup>2</sup>

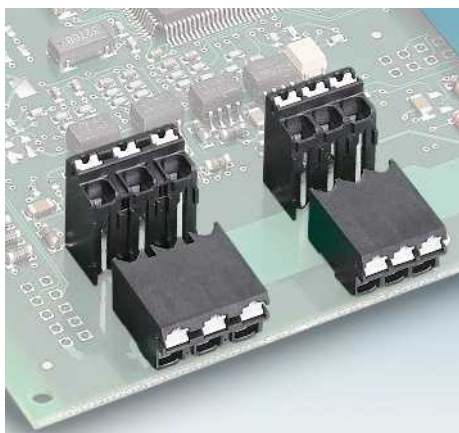

- Push-in direct plug-in technology for solid or stranded conductors
- Suitable for use in SMT reflow processes
- Horizontal and vertical design with 5.0 mm and 5.08 mm pitch
- Two solder pins for a high level of stability on the PCB
- Standard pin length of 2.6 mm also suitable for wave soldering processes
- Supplied in tape-on-reel packing according to IEC 60286-3 for automated mounting in the reflow process with pin length of 2.0 mm
- Touch connection for voltage testing using a 1 mm Ø test pin

#### Notes:





Dimensional drawings of tape reels and place pads can be found online at [phoenixcontact.net/products](http://phoenixcontact.net/products).

1) Current carrying capacity curve upon request.



Pin length of 2.6 mm, box-packaged PCB terminal blocks, connection direction horizontal to the PCB

#### For accessories, see Catalog 1

For all types	Type	Page
	Screwdriver SZS 0,4 x 2,5 Order No. 1205037	
	Ferrules with and without plastic sleeve	834
	Crimping pliers for 0.25 to 6 mm <sup>2</sup> CRIMPFOX 6 Order No. 1212034	
	Test plug MPS-MT 1-S Order No. 1944372	831

#### Dimensional drawing

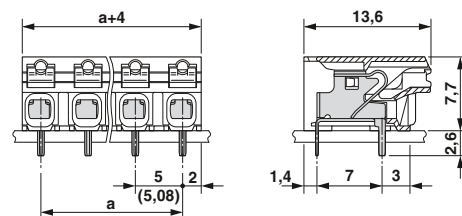

#### Drilling diagram

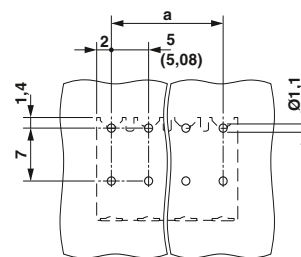

#### Technical data

Technical data in accordance to IEC / DIN VDE	
Rated current / conductor cross section	[A] / [mm <sup>2</sup> ]
Rated insulation voltage for pollution degree 2	[V]
Pitch	[mm]
Connection capacity	
Solid / stranded	[mm <sup>2</sup> ] / [mm <sup>2</sup> ] / AWG
Stranded with ferrules without plastic sleeve	[mm <sup>2</sup> ]
Stranded with ferrules with plastic sleeve	[mm <sup>2</sup> ]
Multi-conductor connection capacity (two conductors with the same cross section)	
Solid / stranded	[mm <sup>2</sup> ]
Stranded with ferrules without plastic sleeve	[mm <sup>2</sup> ]
Stranded with TWIN ferrule with plastic sleeve	[mm <sup>2</sup> ]
Insulation coordination	
Surge voltage category / pollution degree	III / 3 III / 2 II / 2
Rated insulation voltage	[V]
Rated surge voltage	[kV]
Approval data (UL/CUL)	Use Group
Nominal voltage	[V]
Nominal current	[A]
Connection capacity AWG	AWG
Approval data (CSA)	Use Group
Nominal voltage	[V]
Nominal current	[A]
Connection capacity AWG	AWG
General data	
Stripping length	[mm]
Type of insulation material / insulation material group	
Inflammability class according to UL 94	
Drill hole diameter / pin dimensions	[mm]

13.5 <sup>1)</sup> / 1.5		
320		
5 / 5.08		
0.2 - 1.5 / 0.2 - 1.5 / 24 - 16		
0.2 - 1.5		
0.2 - 0.75		
- / -		
-		
-		
III / 3	III / 2	II / 2
250	320	500
4	4	4
B	C	D
-	-	-
-	-	-
-	-	-
B	C	D
-	-	-
-	-	-
-	-	-
-	-	-
8		
LCP / IIIa		
V0		
1.1 / 0.7 x 0.3 mm		

No. of pos.	Dim. a [mm]
2	5.00
3	10.00
4	15.00
5	20.00
6	25.00
7	30.00
8	35.00
9	40.00
10	45.00
11	50.00
12	55.00

#### Ordering data

Type	Order No.	Pcs. / Pkt.
Pitch 5.0 mm, color: black		
SPT-THR 1,5/ 2-H-5,0 P26	1822972	300
SPT-THR 1,5/ 3-H-5,0 P26	1822985	190
SPT-THR 1,5/ 4-H-5,0 P26	1822998	130
SPT-THR 1,5/ 5-H-5,0 P26	1823007	110
SPT-THR 1,5/ 6-H-5,0 P26	1823010	80
SPT-THR 1,5/ 7-H-5,0 P26	1823023	60
SPT-THR 1,5/ 8-H-5,0 P26	1823036	60
SPT-THR 1,5/ 9-H-5,0 P26	1823049	40
SPT-THR 1,5/10-H-5,0 P26	1823052	40
SPT-THR 1,5/11-H-5,0 P26	1823065	40
SPT-THR 1,5/12-H-5,0 P26	1823078	40
Headers, 5.08 mm pitch, color: black		
SPT-THR 1,5/ 2-H-5,08 P26	1823081	300
SPT-THR 1,5/ 3-H-5,08 P26	1823094	190
SPT-THR 1,5/ 4-H-5,08 P26	1823104	130
SPT-THR 1,5/ 5-H-5,08 P26	1823117	110
SPT-THR 1,5/ 6-H-5,08 P26	1823120	80
SPT-THR 1,5/ 7-H-5,08 P26	1823133	60
SPT-THR 1,5/ 8-H-5,08 P26	1823146	60
SPT-THR 1,5/ 9-H-5,08 P26	1823159	40
SPT-THR 1,5/10-H-5,08 P26	1823162	40
SPT-THR 1,5/11-H-5,08 P26	1823175	40
SPT-THR 1,5/12-H-5,08 P26	1823188	40



Pin length of 2.6 mm, box-packaged PCB terminal blocks, connection direction vertical to the PCB



Pin length of 2.0 mm, taped PCB terminal blocks, connection direction horizontal to the PCB



Pin length of 2.0 mm, taped PCB terminal blocks, connection direction vertical to the PCB



### Dimensional drawing

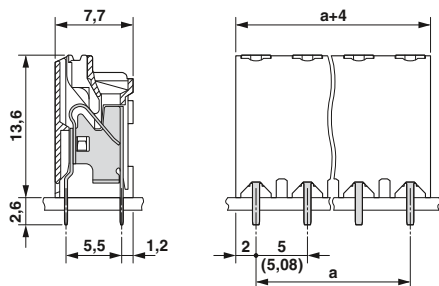

### Drilling diagram

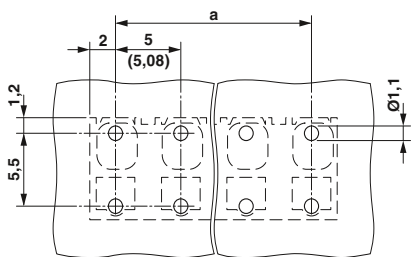

### Dimensional drawing

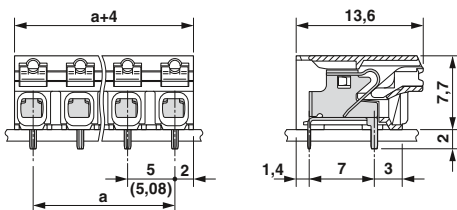

### Drilling diagram

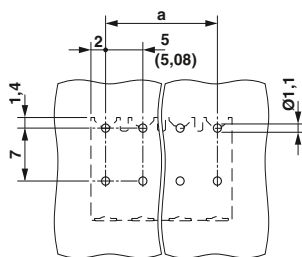

### Dimensional drawing

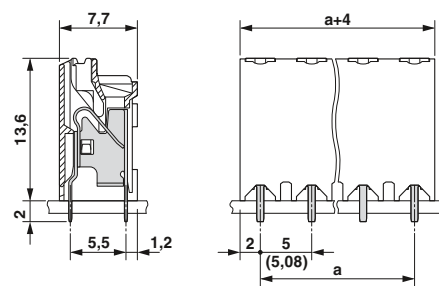

### Drilling diagram

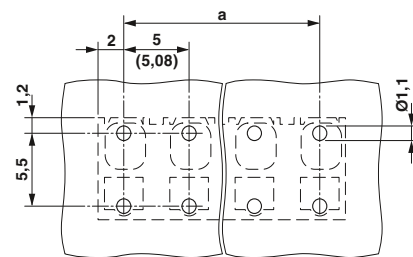

### Ordering data

Type	Order No.	Pcs. / Pkt.
Pitch 5.0 mm, color: black		
SPT-THR 1,5/ 2-V-5,0 P26	1822532	440
SPT-THR 1,5/ 3-V-5,0 P26	1822545	280
SPT-THR 1,5/ 4-V-5,0 P26	1822558	190
SPT-THR 1,5/ 5-V-5,0 P26	1822561	160
SPT-THR 1,5/ 6-V-5,0 P26	1822574	120
SPT-THR 1,5/ 7-V-5,0 P26	1822587	90
SPT-THR 1,5/ 8-V-5,0 P26	1822590	90
SPT-THR 1,5/ 9-V-5,0 P26	1822600	60
SPT-THR 1,5/10-V-5,0 P26	1822613	60
SPT-THR 1,5/11-V-5,0 P26	1822626	60
SPT-THR 1,5/12-V-5,0 P26	1822639	60
Headers, 5.08 mm pitch, color: black		
SPT-THR 1,5/ 2-V-5,08 P26	1822642	440
SPT-THR 1,5/ 3-V-5,08 P26	1822655	280
SPT-THR 1,5/ 4-V-5,08 P26	1822668	190
SPT-THR 1,5/ 5-V-5,08 P26	1822671	160
SPT-THR 1,5/ 6-V-5,08 P26	1822684	120
SPT-THR 1,5/ 7-V-5,08 P26	1822697	90
SPT-THR 1,5/ 8-V-5,08 P26	1822707	90
SPT-THR 1,5/ 9-V-5,08 P26	1822710	60
SPT-THR 1,5/10-V-5,08 P26	1822723	60
SPT-THR 1,5/11-V-5,08 P26	1822736	60
SPT-THR 1,5/12-V-5,08 P26	1822749	60

### Ordering data

Type	Order No.	Pcs. / Pkt.
Pitch 5.0 mm, color: black		
SPT-THR 1,5/ 2-H-5,0 P20 R24	1823858	250
SPT-THR 1,5/ 3-H-5,0 P20 R32	1823861	250
SPT-THR 1,5/ 4-H-5,0 P20 R32	1823874	250
SPT-THR 1,5/ 5-H-5,0 P20 R56	1823887	250
SPT-THR 1,5/ 6-H-5,0 P20 R56	1823890	250
SPT-THR 1,5/ 7-H-5,0 P20 R56	1823900	250
SPT-THR 1,5/ 8-H-5,0 P20 R56	1823913	250
SPT-THR 1,5/ 9-H-5,0 P20 R88	1823926	250
SPT-THR 1,5/10-H-5,0 P20 R88	1823939	250
SPT-THR 1,5/11-H-5,0 P20 R88	1823942	250
SPT-THR 1,5/12-H-5,0 P20 R88	1823955	250
Headers, 5.08 mm pitch, color: black		
SPT-THR 1,5/ 2-H-5,08 P20 R24	1823968	250
SPT-THR 1,5/ 3-H-5,08 P20 R32	1823971	250
SPT-THR 1,5/ 4-H-5,08 P20 R32	1823984	250
SPT-THR 1,5/ 5-H-5,08 P20 R56	1823997	250
SPT-THR 1,5/ 6-H-5,08 P20 R56	1824006	250
SPT-THR 1,5/ 7-H-5,08 P20 R56	1824019	250
SPT-THR 1,5/ 8-H-5,08 P20 R56	1824022	250
SPT-THR 1,5/ 9-H-5,08 P20 R88	1824035	250
SPT-THR 1,5/10-H-5,08 P20 R88	1824048	250
SPT-THR 1,5/11-H-5,08 P20 R88	1824051	250
SPT-THR 1,5/12-H-5,08 P20 R88	1824064	250

### Ordering data

Type	Order No.	Pcs. / Pkt.
Pitch 5.0 mm, color: black		
SPT-THR 1,5/ 2-V-5,0 P20 R24	1823418	180
SPT-THR 1,5/ 3-V-5,0 P20 R32	1823421	180
SPT-THR 1,5/ 4-V-5,0 P20 R56	1823434	180
SPT-THR 1,5/ 5-V-5,0 P20 R56	1823447	180
SPT-THR 1,5/ 6-V-5,0 P20 R56	1823450	180
SPT-THR 1,5/ 7-V-5,0 P20 R56	1823463	180
SPT-THR 1,5/ 8-V-5,0 P20 R88	1823476	180
SPT-THR 1,5/ 9-V-5,0 P20 R88	1823489	180
SPT-THR 1,5/10-V-5,0 P20 R88	1823492	180
SPT-THR 1,5/11-V-5,0 P20 R88	1823502	180
SPT-THR 1,5/12-V-5,0 P20 R88	1823515	180
Headers, 5.08 mm pitch, color: black		
SPT-THR 1,5/ 2-V-5,08 P20 R24	1823528	180
SPT-THR 1,5/ 3-V-5,08 P20 R32	1823531	180
SPT-THR 1,5/ 4-V-5,08 P20 R56	1823544	180
SPT-THR 1,5/ 5-V-5,08 P20 R56	1823557	180
SPT-THR 1,5/ 6-V-5,08 P20 R56	1823560	180
SPT-THR 1,5/ 7-V-5,08 P20 R56	1823573	180
SPT-THR 1,5/ 8-V-5,08 P20 R88	1823586	180
SPT-THR 1,5/ 9-V-5,08 P20 R88	1823599	180
SPT-THR 1,5/10-V-5,08 P20 R88	1823609	180
SPT-THR 1,5/11-V-5,08 P20 R88	1823612	180
SPT-THR 1,5/12-V-5,08 P20 R88	1823625	180

## PCB terminal blocks with 2.54 to 7.62 mm pitch

### Double-level PCB terminal blocks with push-in spring connection up to 1.5 mm<sup>2</sup>

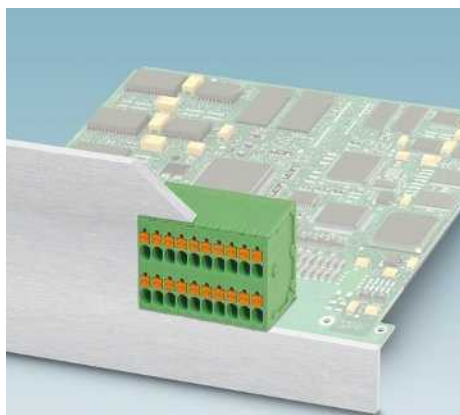





- Push-in connection with spring lever for tool-free conductor connection
- Unique integration into front panels in two rows
- Conductor cross sections up to 1.5 mm<sup>2</sup> with ferrule
- Printing area at the front
- Touch connection for voltage testing using a 1 mm test pin

#### Notes:

1) Current carrying capacity curve upon request.

#### For accessories, see Catalog 1

For all types	Type	Page
	Marker cards <b>SK 3,5/2,8</b>	796
	Screwdriver <b>SZS 0,4 x 2,5</b> Order No. <b>1205037</b>	
	Ferrules with and without plastic sleeve	834
	Crimping pliers for 0.25 to 6 mm <sup>2</sup> <b>CRIMPFOX 6</b> Order No. <b>1212034</b>	
	Test plug <b>MPS-MT 1-S</b> Order No. <b>1944372</b>	831

#### Technical data

Technical data in accordance to IEC / DIN VDE

Rated current / conductor cross section [A] / [mm<sup>2</sup>]

Rated insulation voltage for pollution degree 2 [V]

Pitch [mm]

Connection capacity

Solid / stranded [mm<sup>2</sup>] / [mm<sup>2</sup>] / AWG

Stranded with ferrules without plastic sleeve [mm<sup>2</sup>]

Stranded with ferrules with plastic sleeve [mm<sup>2</sup>]

Insulation coordination

Surge voltage category / pollution degree

Rated insulation voltage [V]

Rated surge voltage [kV]

Approval data (UL/CUL) Use Group

Nominal voltage [V]

Nominal current [A]

Connection capacity AWG

Approval data (CSA) Use Group

Nominal voltage [V]

Nominal current [A]

Connection capacity AWG

General data

Stripping length [mm]

Type of insulation material / insulation material group

Inflammability class according to UL 94

Drill hole diameter / pin dimensions [mm]

10<sup>1)</sup> / 1.5

200

3.5

0.14 - 1.5 / 0.14 - 1.5 / 24 - 14

0.2 - 1.5

0.2 - 1.5

III / 3 III / 2 II / 2

160 200 400

2.5 2.5 2.5

B C D

- - -

- - -

- - -

B C D

- - -

- - -

- - -

8

PA / I

V0

1.3 / 0.6 x 1.0 mm

No. of pos. Dim. a [mm]

2 3.50

3 7.00

4 10.50

5 14.00

6 17.50

7 21.00

8 24.50

9 28.00

10 31.50

11 35.00

12 38.50





Horizontal connection direction

Dimensional drawing

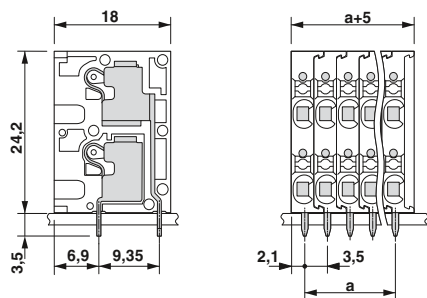

Drilling diagram

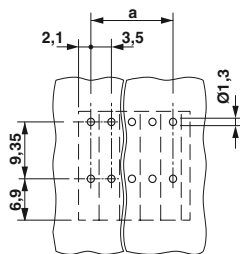

Ordering data

Type	Order No.	Pcs. / Pkt.
3.5 mm pitch, color: green		
SPTD 1,5/ 2-H-3,5	1841490	100
SPTD 1,5/ 3-H-3,5	1841500	100
SPTD 1,5/ 4-H-3,5	1841513	100
SPTD 1,5/ 5-H-3,5	1841526	100
SPTD 1,5/ 6-H-3,5	1841539	100
SPTD 1,5/ 7-H-3,5	1841542	100
SPTD 1,5/ 8-H-3,5	1841555	100
SPTD 1,5/ 9-H-3,5	1841568	100
SPTD 1,5/10-H-3,5	1841571	100
SPTD 1,5/11-H-3,5	1841584	100
SPTD 1,5/12-H-3,5	1841597	100

### Inverted headers for reflow processes

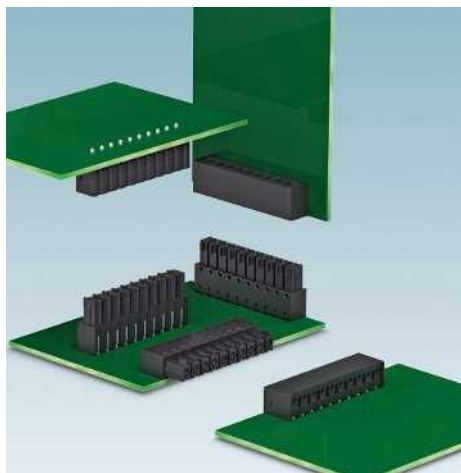

- Inverted headers with a 3.5 mm pitch
- Plug-in direction parallel or vertical to the PCB
- Versions with snap-in lug for locking inverted plugs with self-locking flanges
- You can find user notes and recommendations for the THR procedure in Catalog 1
- Combination with MC 1,5 pin strips for the PCB/PCB connection

#### Notes:

In accordance with DIN EN 61984, COMBICON connectors have no switching power. During designated use, they must not be plugged in or disconnected when carrying voltage or under load.

#### COMBICON select

Possible combinations for connectors can be found in COMBICON select at [phoenixcontact.net/products](http://phoenixcontact.net/products).

<sup>1)</sup> Current carrying capacity curve upon request.



2.0 mm pin length  
Box-packaged headers,  
Plug-in direction parallel to the PCB

### For accessories, see Catalog 1

For all types	Type	Page
	Marker cards SK 3,5/2,8	796

### Dimensional drawing

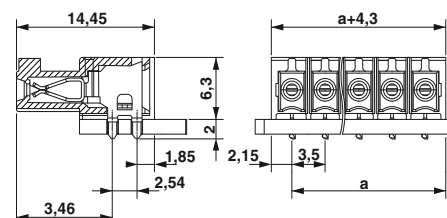

### Drilling diagram

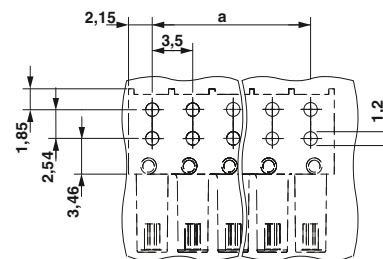

### Technical data

Technical data in accordance to IEC / DIN VDE	
Rated current	[A] 8 <sup>1)</sup>
Rated insulation voltage for pollution degree 2	[V] 160
Pitch	[mm] 3.5
Insulation coordination	
Surge voltage category / pollution degree	III / 3 III / 2 II / 2
Rated insulation voltage	[V] 160 160 320
Rated surge voltage	[kV] 2.5 2.5 2.5
Approval data (UL/CUL)	Use Group B C D
Nominal voltage	[V] - - -
Nominal current	[A] - - -
Connection capacity AWG	AWG - - -
Approval data (CSA)	Use Group B C D
Nominal voltage	[V] - - -
Nominal current	[A] - - -
Connection capacity AWG	AWG - - -
General data	
Type of insulation material / insulation material group	LCP / IIIa
Inflammability class according to UL 94	V0
Drill hole diameter / pin dimensions	[mm] 1.2 / 0.8 x 0.8 mm

### Ordering data

Type	Order No.	Pcs. / Pkt.
Pitch 3.5 mm, color: black		
IMC 1,5/ 2-G-3,5 P20 THR	1830414	50
IMC 1,5/ 3-G-3,5 P20 THR	1830427	50
IMC 1,5/ 4-G-3,5 P20 THR	1830430	50
IMC 1,5/ 5-G-3,5 P20 THR	1830443	50
IMC 1,5/ 6-G-3,5 P20 THR	1830456	50
IMC 1,5/ 7-G-3,5 P20 THR	1830469	50
IMC 1,5/ 8-G-3,5 P20 THR	1830472	50
IMC 1,5/ 9-G-3,5 P20 THR	1830485	50
IMC 1,5/10-G-3,5 P20 THR	1830498	50
IMC 1,5/11-G-3,5 P20 THR	1830508	50
IMC 1,5/12-G-3,5 P20 THR	1830511	50



Pin length of 2.0 mm, with snap-in lug, box-packaged headers, plug-in direction parallel to the PCB



2.0 mm pin length Box-packaged headers, Plug-in direction vertical to the PCB



Pin length of 2.0 mm, with snap-in lug, box-packaged headers, plug-in direction vertical to the PCB

### Dimensional drawing

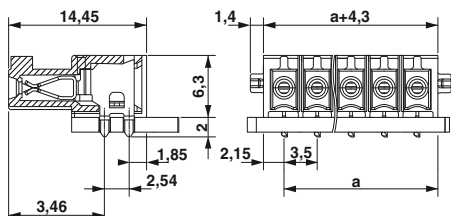

### Dimensional drawing

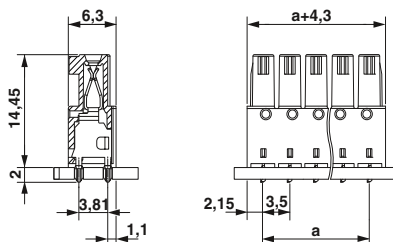

### Dimensional drawing

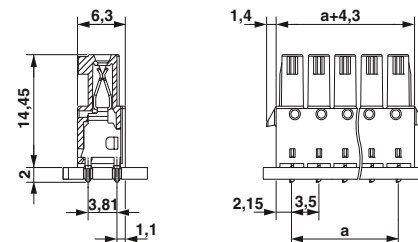

### Drilling diagram

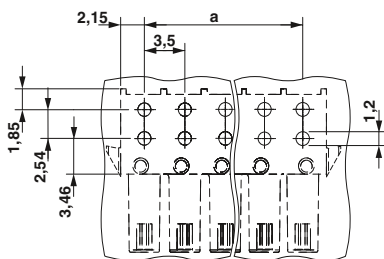

### Drilling diagram

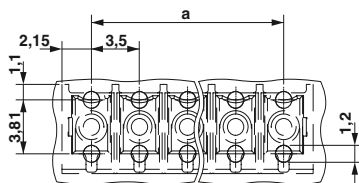

### Drilling diagram

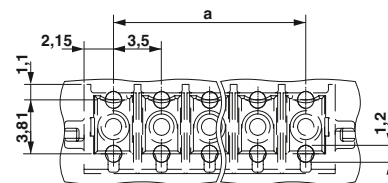

### Ordering data

Type	Order No.	Pcs. / Pkt.
Pitch 3.5 mm, color: black		
IMC 1,5/ 2-G-3,5 RN P20 THR	1830566	50
IMC 1,5/ 3-G-3,5 RN P20 THR	1830579	50
IMC 1,5/ 4-G-3,5 RN P20 THR	1830582	50
IMC 1,5/ 5-G-3,5 RN P20 THR	1830595	50
IMC 1,5/ 6-G-3,5 RN P20 THR	1830605	50
IMC 1,5/ 7-G-3,5 RN P20 THR	1830618	50
IMC 1,5/ 8-G-3,5 RN P20 THR	1830621	50
IMC 1,5/ 9-G-3,5 RN P20 THR	1830634	50
IMC 1,5/10-G-3,5 RN P20 THR	1830647	50
IMC 1,5/11-G-3,5 RN P20 THR	1830650	50
IMC 1,5/12-G-3,5 RN P20 THR	1830663	50

### Ordering data

Type	Order No.	Pcs. / Pkt.
Pitch 3.5 mm, color: black		
IMCV 1,5/ 2-G-3,5 P20 THR	1830715	50
IMCV 1,5/ 3-G-3,5 P20 THR	1830728	50
IMCV 1,5/ 4-G-3,5 P20 THR	1830731	50
IMCV 1,5/ 5-G-3,5 P20 THR	1830744	50
IMCV 1,5/ 6-G-3,5 P20 THR	1830757	50
IMCV 1,5/ 7-G-3,5 P20 THR	1830760	50
IMCV 1,5/ 8-G-3,5 P20 THR	1830773	50
IMCV 1,5/ 9-G-3,5 P20 THR	1830786	50
IMCV 1,5/10-G-3,5 P20 THR	1830799	50
IMCV 1,5/11-G-3,5 P20 THR	1830809	50
IMCV 1,5/12-G-3,5 P20 THR	1830812	50

### Ordering data

Type	Order No.	Pcs. / Pkt.
Pitch 3.5 mm, color: black		
IMCV 1,5/ 2-G-3,5 RN P20 THR	1830867	50
IMCV 1,5/ 3-G-3,5 RN P20 THR	1830870	50
IMCV 1,5/ 4-G-3,5 RN P20 THR	1830883	50
IMCV 1,5/ 5-G-3,5 RN P20 THR	1830896	50
IMCV 1,5/ 6-G-3,5 RN P20 THR	1830906	50
IMCV 1,5/ 7-G-3,5 RN P20 THR	1830919	50
IMCV 1,5/ 8-G-3,5 RN P20 THR	1830922	50
IMCV 1,5/ 9-G-3,5 RN P20 THR	1830935	50
IMCV 1,5/10-G-3,5 RN P20 THR	1830948	50
IMCV 1,5/11-G-3,5 RN P20 THR	1830951	50
IMCV 1,5/12-G-3,5 RN P20 THR	1830964	50

## Connector systems with a 3.5/3.81 and 5.08 mm pitch

### Single-level header for reflow processes

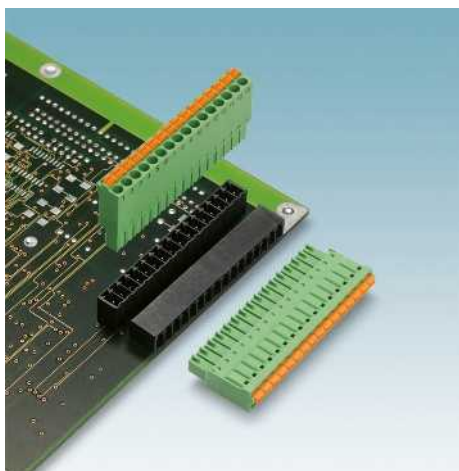

- 13 to 20 pos. headers with a 3.81 mm pitch
- High-precision pin strips for increased tolerance requirements
- Short 2.0 mm pin for reduced overhang in 1.6 mm PCBs
- You can find user notes and recommendations for the THR procedure in Catalog 1
- For further numbers of positions, visit [phoenixcontact.net/products](http://phoenixcontact.net/products)

#### Notes:

In accordance with DIN EN 61984, COMBICON connectors have no switching power. During designated use, they must not be plugged in or disconnected when carrying voltage or under load.

#### COMBICON select

Possible combinations for connectors can be found in COMBICON select at [phoenixcontact.net/products](http://phoenixcontact.net/products).



CP-MSTB and SK 3,... may only be used after reflow soldering.

Dimensional drawings of the free space for solder paste, the tape, and pick-and-place pads can be found online at [phoenixcontact.net/products](http://phoenixcontact.net/products).



Pin length 2.0 mm,  
Box-packaged headers,  
Plug-in direction parallel to the PCB

#### For accessories, see Catalog 1

For all types	Type	Page
	Coding profile CP-MSTB Order No. 1734634	
	Marker cards SK 3,5/2,8 or SK 3,81/2,8	796

#### Dimensional drawing

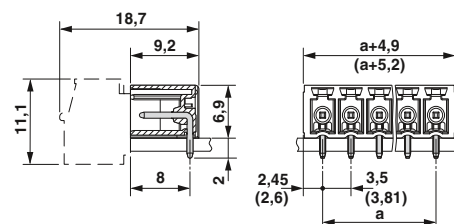

#### Drilling diagram

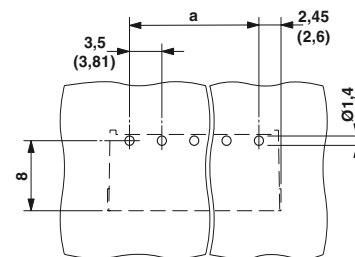

#### Technical data

Technical data in accordance to IEC / DIN VDE	
Rated current	[A] 8
Rated insulation voltage for pollution degree 2	[V] 160
Pitch	[mm] 3.81
Insulation coordination	
Surge voltage category / pollution degree	III / 3 III / 2 II / 2
Rated insulation voltage	[V] 160 160 250
Rated surge voltage	[kV] 2.5 2.5 2.5
Approval data (UL/CUL)	Use Group B C D
Nominal voltage	[V] - - -
Nominal current	[A] - - -
Connection capacity AWG	AWG - - -
Approval data (CSA)	Use Group B C D
Nominal voltage	[V] - - -
Nominal current	[A] - - -
Connection capacity AWG	AWG - - -
General data	
Type of insulation material / insulation material group	LCP / IIIa
Inflammability class according to UL 94	V0
Drill hole diameter / pin dimensions	[mm] 1.4 / 0.8 x 0.8 mm

#### Ordering data

Type	Order No.	Pcs. / Pkt.
<b>3.81 mm pitch, color: black</b>		
MC 1,5/13-G-3,81 P20 THR	1829056	50
MC 1,5/14-G-3,81 P20 THR	1829069	50
MC 1,5/15-G-3,81 P20 THR	1829072	50
MC 1,5/16-G-3,81 P20 THR	1829085	50
MC 1,5/17-G-3,81 P20 THR	1829098	50
MC 1,5/18-G-3,81 P20 THR	1829108	50
MC 1,5/19-G-3,81 P20 THR	1829111	50
MC 1,5/20-G-3,81 P20 THR	1829124	50



Pin length 2.0 mm, with threaded flange  
Box-packaged headers,  
Plug-in direction parallel to the PCB



Pin length 2.0 mm,  
Box-packaged headers,  
Plug-in direction vertical to the PCB



Pin length 2.0 mm, with threaded flange  
Box-packaged headers,  
Plug-in direction vertical to the PCB

### Dimensional drawing

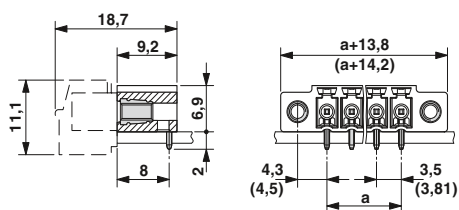

### Drilling diagram

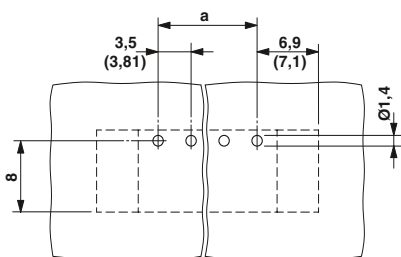

### Dimensional drawing

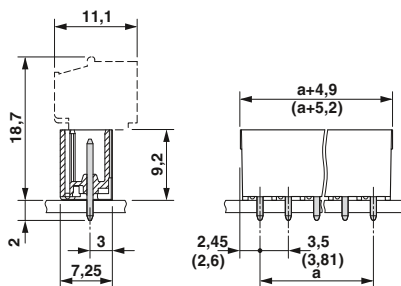

### Drilling diagram

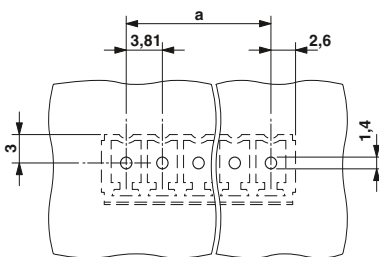

### Dimensional drawing

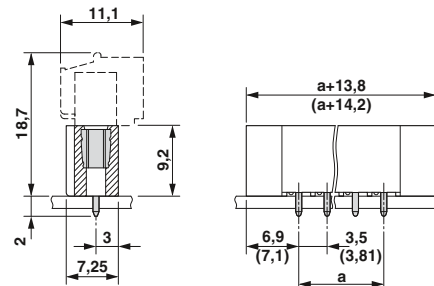

### Drilling diagram

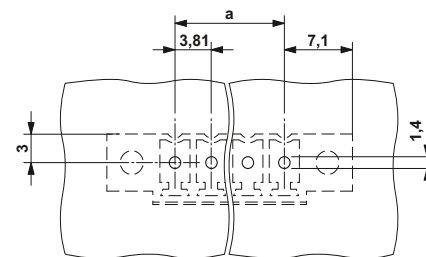

### Ordering data

Type	Order No.	Pcs. / Pkt.
3.81 mm pitch, color: black		
MC 1,5/13-GF-3,81 P20 THR	1829137	50
MC 1,5/14-GF-3,81 P20 THR	1829140	50
MC 1,5/15-GF-3,81 P20 THR	1829153	50
MC 1,5/16-GF-3,81 P20 THR	1829166	50
MC 1,5/17-GF-3,81 P20 THR	1829179	50
MC 1,5/18-GF-3,81 P20 THR	1829182	50
MC 1,5/19-GF-3,81 P20 THR	1829195	50
MC 1,5/20-GF-3,81 P20 THR	1829205	50

### Ordering data

Type	Order No.	Pcs. / Pkt.
3.81 mm pitch, color: black		
MCV 1,5/13-G-3,81 P20 THR	1828895	50
MCV 1,5/14-G-3,81 P20 THR	1828905	50
MCV 1,5/15-G-3,81 P20 THR	1828918	50
MCV 1,5/16-G-3,81 P20 THR	1828921	50
MCV 1,5/17-G-3,81 P20 THR	1828934	50
MCV 1,5/18-G-3,81 P20 THR	1828947	50
MCV 1,5/19-G-3,81 P20 THR	1828950	50
MCV 1,5/20-G-3,81 P20 THR	1828963	50

### Ordering data

Type	Order No.	Pcs. / Pkt.
3.81 mm pitch, color: black		
MCV 1,5/13-GF-3,81 P20 THR	1828976	50
MCV 1,5/14-GF-3,81 P20 THR	1828989	50
MCV 1,5/15-GF-3,81 P20 THR	1828992	50
MCV 1,5/16-GF-3,81 P20 THR	1829001	50
MCV 1,5/17-GF-3,81 P20 THR	1829014	50
MCV 1,5/18-GF-3,81 P20 THR	1829027	50
MCV 1,5/19-GF-3,81 P20 THR	1829030	50
MCV 1,5/20-GF-3,81 P20 THR	1829043	50

# PCB connection technology and electronics housing

## Connector systems with a 3.5/3.81 and 5.08 mm pitch

### Single-level header for reflow processes



- 13 to 20 pos. headers with a 3.81 mm pitch
- High-precision pin strips for increased tolerance requirements
- Short 2.0 mm pin for reduced overhang in 1.6 mm PCBs
- Tape-on-reel packing according to IEC 60286-3 for automated mounting
- Tape width corresponds to order designation, e.g., R32 = 32 mm tape width
- You can find user notes and recommendations for the THR procedure in Catalog 1
- For further numbers of positions, visit [phoenixcontact.net/products](http://phoenixcontact.net/products)

#### Notes:

In accordance with DIN EN 61984, COMBICON connectors have no switching power. During designated use, they must not be plugged in or disconnected when carrying voltage or under load.

#### COMBICON select

Possible combinations for connectors can be found in COMBICON select at [phoenixcontact.net/products](http://phoenixcontact.net/products).



CP-MSTB and SK 3,... may only be used after reflow soldering.

Pick and place pads for taped THR articles usually protrude beyond the components. The PCB layout must ensure that collisions are avoided when components are assembled. Dimensional drawings of the pick and place pads can be found online at [phoenixcontact.net/products](http://phoenixcontact.net/products).



Pin length 2.0 mm,  
Taped headers,  
Plug-in direction parallel to the PCB

### For accessories, see Catalog 1

For all types	Type	Page
	Coding profile CP-MSTB Order No. 1734634	
	Marker cards SK 3,5/2,8 or SK 3,81/2,8	796

### Dimensional drawing

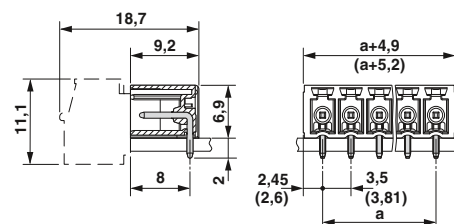

### Drilling diagram

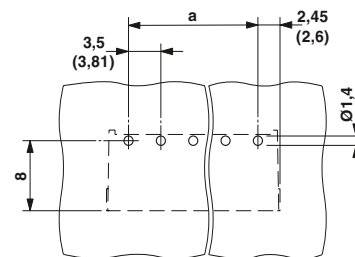

### Technical data

Technical data in accordance to IEC / DIN VDE

Rated current	[A]	8
Rated insulation voltage for pollution degree 2	[V]	-
Pitch	[mm]	-
Insulation coordination		
Surge voltage category / pollution degree		III / 3 III / 2 II / 2
Rated insulation voltage	[V]	160
Rated surge voltage	[kV]	
Approval data (UL/CUL)	Use Group	B C D
Nominal voltage	[V]	- - -
Nominal current	[A]	- - -
Connection capacity AWG	AWG	- - -
Approval data (CSA)	Use Group	B C D
Nominal voltage	[V]	- - -
Nominal current	[A]	- - -
Connection capacity AWG	AWG	- - -
General data		
Type of insulation material / insulation material group		- / -
Inflammability class according to UL 94		-

No. of pos.	Dim. a [mm]
13	45.72
14	49.53
15	53.34
16	57.15
17	60.96
18	64.77
19	68.58
20	72.39

### Ordering data

Type	Order No.	Pcs. / Pkt.
<b>3.81 mm pitch, color: black</b>		
MC 1,5/13-G-3,81 P20 THRR72	1828691	470
MC 1,5/14-G-3,81 P20 THRR88	1828701	470
MC 1,5/15-G-3,81 P20 THRR88	1828714	470
MC 1,5/16-G-3,81 P20 THRR88	1828727	470
MC 1,5/17-G-3,81 P20 THRR88	1828730	470
MC 1,5/18-G-3,81 P20 THRR88	1828743	470
MC 1,5/19-G-3,81 P20 THRR104	1828756	470
MC 1,5/20-G-3,81 P20 THRR104	1828769	470



Pin length 2.0 mm, with threaded flange,  
Taped headers,  
Plug-in direction parallel to the PCB



Pin length 2.0 mm,  
Taped headers,  
Plug-in direction vertical to the PCB



Pin length 2.0 mm, with threaded flange,  
Taped headers,  
Plug-in direction vertical to the PCB

### Dimensional drawing

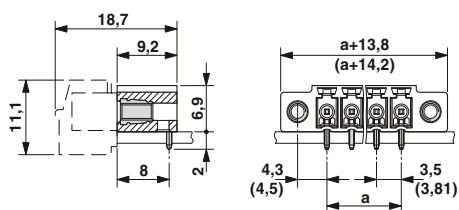

### Drilling diagram

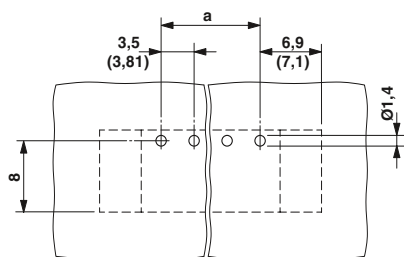

### Ordering data

Type	Order No.	Pcs. / Pkt.
3.81 mm pitch, color: black		
MC 1,5/13-GF-3,81 P20 THRR72	1828772	470
MC 1,5/14-GF-3,81 P20 THRR88	1828785	470
MC 1,5/15-GF-3,81 P20 THRR88	1828798	470
MC 1,5/16-GF-3,81 P20 THRR88	1828808	470
MC 1,5/17-GF-3,81 P20 THRR88	1828811	470
MC 1,5/18-GF-3,81 P20 THRR88	1828824	470
MC 1,5/19-GF-3,81 P20 THRR104	1828837	470
MC 1,5/20-GF-3,81 P20 THRR104	1828840	470

### Dimensional drawing

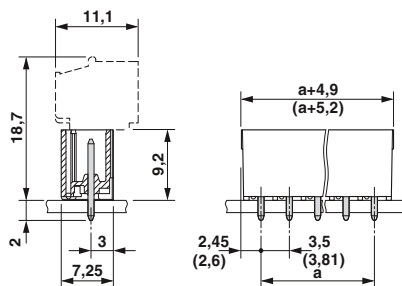

### Drilling diagram

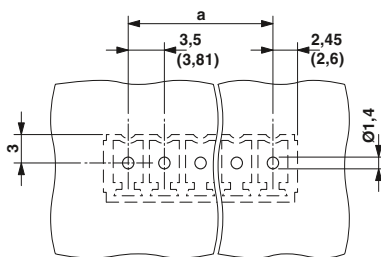

### Ordering data

Type	Order No.	Pcs. / Pkt.
3.81 mm pitch, color: black		
MCV 1,5/13-G-3,81 P20 THRR72	1828536	200
MCV 1,5/14-G-3,81 P20 THRR88	1828549	200
MCV 1,5/15-G-3,81 P20 THRR88	1828522	200
MCV 1,5/16-G-3,81 P20 THRR88	1828565	200
MCV 1,5/17-G-3,81 P20 THRR88	1828578	200
MCV 1,5/18-G-3,81 P20 THRR88	1828581	200
MCV 1,5/19-G-3,81 P20 THRR104	1828594	200
MCV 1,5/20-G-3,81 P20 THRR104	1828604	200

### Dimensional drawing

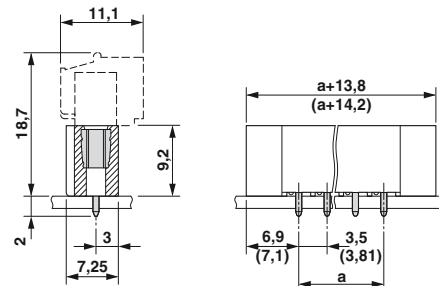

### Drilling diagram

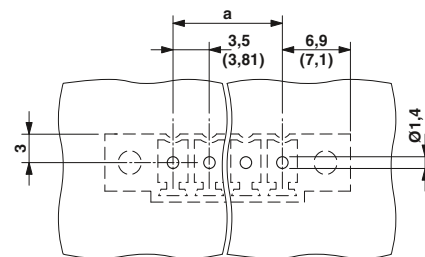

### Ordering data

Type	Order No.	Pcs. / Pkt.
3.81 mm pitch, color: black		
MCV 1,5/13-GF-3,81 P20 THRR72	1828617	200
MCV 1,5/14-GF-3,81 P20 THRR88	1828620	200
MCV 1,5/15-GF-3,81 P20 THRR88	1828633	200
MCV 1,5/16-GF-3,81 P20 THRR88	1828646	200
MCV 1,5/17-GF-3,81 P20 THRR88	1828659	200
MCV 1,5/18-GF-3,81 P20 THRR88	1828662	200
MCV 1,5/19-GF-3,81 P20 THRR104	1828675	200
MCV 1,5/20-GF-3,81 P20 THRR104	1828688	200

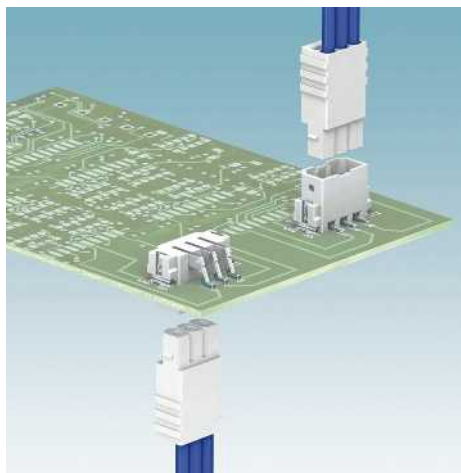

### Plug with spring-cage connection up to 0.75 mm<sup>2</sup>



- Specifically designed for use in reflow and SMT processes
- High current carrying capacity of 6 A
- Robust solder anchor for secure, mechanical fixing to the surface
- Supplied in taped packaging according to IEC 60286-3 for automatic assembly
- Compatible with PTSM...-/PTPM...plugs
- 2.5 mm pitch

<b>Notes:</b>
PTSM plugs and headers are also available in black.
<b>COMBICON select</b> Possible combinations for connectors can be found in COMBICON select at <a href="http://phoenixcontact.net/products">phoenixcontact.net/products</a> .
Pick and place pads for taped THR articles usually protrude beyond the components. The PCB layout must ensure that collisions are avoided when components are assembled. Dimensional drawings of the pick and place pads can be found online at <a href="http://phoenixcontact.net/products">phoenixcontact.net/products</a> .
1) Current carrying dependent upon plug used
2) 0.75 mm <sup>2</sup> possible, terminates the conductor insulation before the terminal block.

#### For accessories, see Catalog 1

For all types	Type	Page
	Screwdriver <b>SZS 0,4 X 2,0</b> Order No. 1205202	
	Ferrules with and without plastic sleeve	834
	Crimping pliers for 0.25 to 6 mm <sup>2</sup> <b>CRIMPFOX 6</b> Order No. 1212034	

#### Technical data

Technical data in accordance to IEC / DIN VDE	
Rated current	[A]
Rated insulation voltage for pollution degree 2	[V]
Pitch	[mm]
Connection capacity	
Solid / stranded	[mm <sup>2</sup> ] / [mm <sup>2</sup> ] / AWG
Stranded with ferrules without plastic sleeve	[mm <sup>2</sup> ]
Stranded with ferrules with plastic sleeve	[mm <sup>2</sup> ]
Insulation coordination	
Surge voltage category / pollution degree	
Rated insulation voltage	[V]
Rated surge voltage	[kV]
Approval data (UL/CUL)	Use Group
Nominal voltage	[V]
Nominal current	[A]
Connection capacity AWG	AWG
Approval data (CSA)	Use Group
Nominal voltage	[V]
Nominal current	[A]
Connection capacity AWG	AWG
General data	
Type of insulation material / insulation material group	
Inflammability class according to UL 94	

PTSM 0,5/...-HV-2,5-SMD R..			PTSM 0,5/ ...-HTB-2,5-SMD WH R32			PTSM 0,5/ 1-2,5-H SMD WH L R24		
6 <sup>1)</sup>			6 <sup>1)</sup>			6 <sup>1)</sup> / 0.5		
160			160			250		
2.5			2.5			-		
- / - / -			- / - / -			0.14 - 0.5 / 0.2 - 0.5 <sup>2)</sup> / 26 - 20		
-			-			0.25 - 0.5		
-			-			-		
III / 3	III / 2	II / 2	III / 3	III / 2	II / 2	III / 3	III / 2	II / 2
125	160	250	125	160	250	63	250	320
2.5	2.5	2.5	2.5	2.5	2.5	2.5	2.5	2.5
B	C	D	B	C	D	B	C	D
-	-	-	-	-	-	150	-	-
-	-	-	-	-	-	5	-	-
-	-	-	-	-	-	26-20	-	-
B	C	D	B	C	D	B	C	D
-	-	-	-	-	-	-	-	-
-	-	-	-	-	-	-	-	-
-	-	-	-	-	-	-	-	-
PA / I			PA / I			PA / I		
V0			V0			V0		

No. of pos.	Dim. a [mm]
1	
2	2.50
3	5.00
4	7.50
5	10.00
6	12.50
7	15.00
8	17.50





Vertical header  
for SMD applications



Through board header  
for SMD applications



1-pos. horizontal PCB terminal block for SMD  
applications

### Dimensional drawing

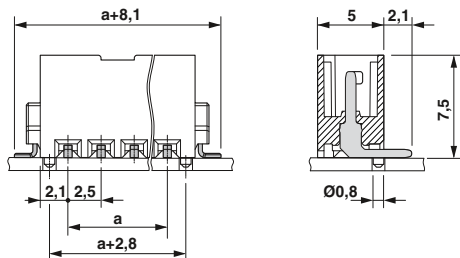

### Dimensional drawing

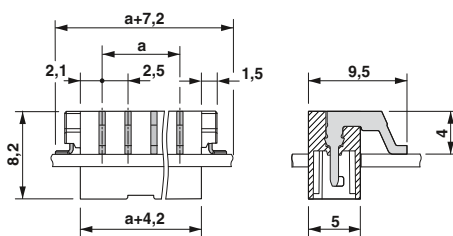

### Dimensional drawing

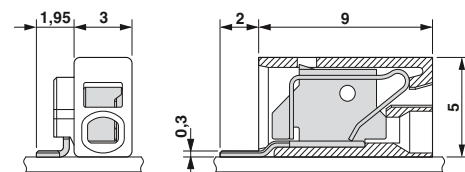

### Drilling diagram

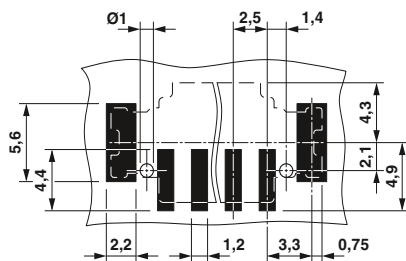

### Drilling diagram

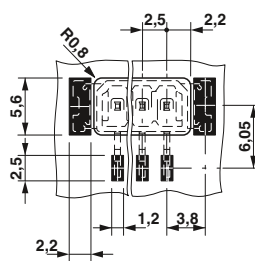

### Drilling diagram

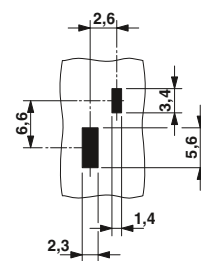

### Ordering data

Type  
2.5 mm pitch, color: white

Order No. Pcs. / Pkt.

PTSM 0,5/ 2-HV-2,5-SMD WH R32	1778696	500
PTSM 0,5/ 3-HV-2,5-SMD WH R32	1778706	500
PTSM 0,5/ 4-HV-2,5-SMD WH R44	1778719	400
PTSM 0,5/ 5-HV-2,5-SMD WH R44	1778722	400
PTSM 0,5/ 6-HV-2,5-SMD WH R44	1778735	400
PTSM 0,5/ 7-HV-2,5-SMD WH R44	1778748	400
PTSM 0,5/ 8-HV-2,5-SMD WH R44	1778751	400

### Ordering data

Type  
2.5 mm pitch, color: white

Order No. Pcs. / Pkt.

PTSM 0,5/ 2-HTB-2,5-SMD WH R32	1830126	330
PTSM 0,5/ 3-HTB-2,5-SMD WH R32	1830139	330
PTSM 0,5/ 4-HTB-2,5-SMD WH R44	1830142	330
PTSM 0,5/ 5-HTB-2,5-SMD WH R44	1830155	330
PTSM 0,5/ 6-HTB-2,5-SMD WH R44	1830168	330
PTSM 0,5/ 7-HTB-2,5-SMD WH R44	1830171	330
PTSM 0,5/ 8-HTB-2,5-SMD WH R44	1830184	330

### Ordering data

Type  
2.5 mm pitch, color: white

Order No. Pcs. / Pkt.

PTSM 0,5/ 1-2,5-H SMD WH L R24	1840035	1000

### PCB terminal blocks, 7.5 mm pitch

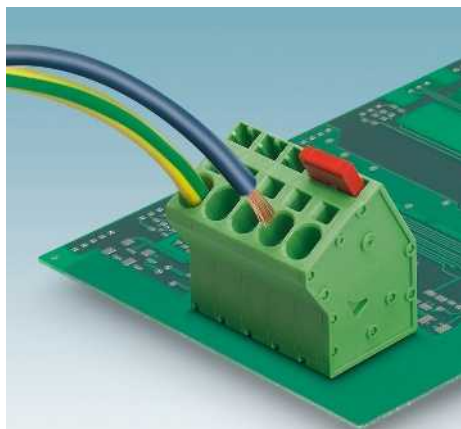





- SPTA 5 PCB terminal block with push-in spring connection for conductor cross sections up to 6 mm<sup>2</sup> and a current carrying capacity of 41 A
- Fully insulated bridges (FBSK) with different numbers of positions, e.g., for potential distribution
- Fast connection technology, thanks to tool-free direct plug-in principle
- Unrestricted 600-V-UL approval thanks to compact zig-zag pinning
- Conductor connection direction: 30° to the PCB
- Single-position terminal blocks with double pinning

#### Notes:

When aligning versions with double pinning, other rated insulation voltages can occur.

1) Please observe the current carrying capacity curves and laboratory data sheets. Further current carrying capacity curves on request.

#### For accessories, see Catalog 1

For all types	Type	Page
	Screwdriver SZF 1-0,6 x 3,5 Order No. 1204517	
	Crimping pliers for 0.25 to 6 mm <sup>2</sup> CRIMPFOX 6 Order No. 1212034	
	Ferrules with and without plastic sleeve	834
	Bridge FBSK ...-7,5	830

#### Current carrying capacity curve

Type: SPTA 5/...-7,5

Tested according to DIN EN 60512-5-2:2003-01

Reduction factor = 1

Number of positions: 4

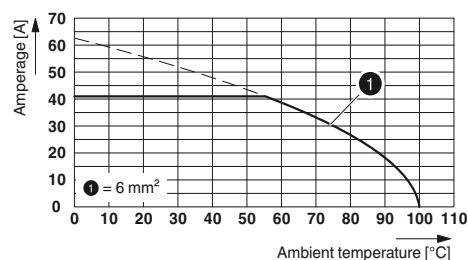

#### Technical data

Technical data in accordance to IEC / DIN VDE	
Rated current / conductor cross section	[A] / [mm <sup>2</sup> ]
Rated insulation voltage for pollution degree 2	[V]
Pitch	[mm]
Connection capacity	
Solid / stranded	[mm <sup>2</sup> ] / [mm <sup>2</sup> ] / AWG
Stranded with ferrules without plastic sleeve	[mm <sup>2</sup> ]
Stranded with ferrules with plastic sleeve	[mm <sup>2</sup> ]
Multi-conductor connection capacity (two conductors with the same cross section)	
Solid / stranded	[mm <sup>2</sup> ]
Stranded with ferrules without plastic sleeve	[mm <sup>2</sup> ]
Stranded with TWIN ferrule with plastic sleeve	[mm <sup>2</sup> ]
Insulation coordination	
Surge voltage category / pollution degree	
Rated insulation voltage	[V]
Rated surge voltage	[kV]
Approval data (UL/CUL)	Use Group
Nominal voltage	[V]
Nominal current	[A]
Connection capacity AWG	AWG
Approval data (CSA)	Use Group
Nominal voltage	[V]
Nominal current	[A]
Connection capacity AWG	AWG
General data	
Stripping length	[mm]
Type of insulation material / insulation material group	
Inflammability class according to UL 94	
Drill hole diameter / pin dimensions	[mm]

#### SPTA 5/1-7,5

Rated current / conductor cross section			41 <sup>1)</sup> / 6		
Rated insulation voltage for pollution degree 2			1000		
Pitch			7.5		
Connection capacity					
Solid / stranded			0.2 - 6 / 0.2 - 6 / 24 - 8		
Stranded with ferrules without plastic sleeve			0.25 - 6		
Stranded with ferrules with plastic sleeve			0.25 - 4		
Multi-conductor connection capacity (two conductors with the same cross section)					
Solid / stranded			- / -		
Stranded with ferrules without plastic sleeve			-		
Stranded with TWIN ferrule with plastic sleeve			0.25 - 1.5		
Insulation coordination					
Surge voltage category / pollution degree			III / 3	III / 2	II / 2
Rated insulation voltage			630	1000	1000
Rated surge voltage			6	6	6
Approval data (UL/CUL)			B	C	D
Nominal voltage			-	-	-
Nominal current			-	-	-
Connection capacity AWG			-	-	-
Approval data (CSA)			B	C	D
Nominal voltage			-	-	-
Nominal current			-	-	-
Connection capacity AWG			-	-	-
General data					
Stripping length			15		
Type of insulation material / insulation material group			PA / I		
Inflammability class according to UL 94			V0		
Drill hole diameter / pin dimensions			2.1 / 1.7 x 0.8		

#### SPTA 5/...-7,5-ZB

No. of pos.	Dim. a [mm]
1	0.00
2	7.50
3	15.00
4	22.50
5	30.00
6	37.50
7	45.00
8	52.50
9	60.00
10	67.50
11	75.00
12	82.50



Single PCB terminal block, 30° angled connection direction, double pinning



30° angled connection direction, zigzag pinning, 600 V UL approval



### Dimensional drawing

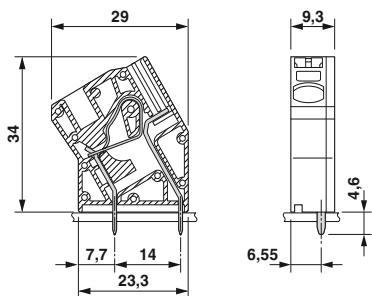

### Drilling diagram

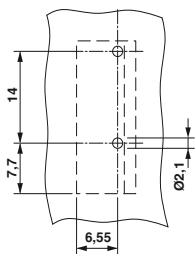

### Dimensional drawing

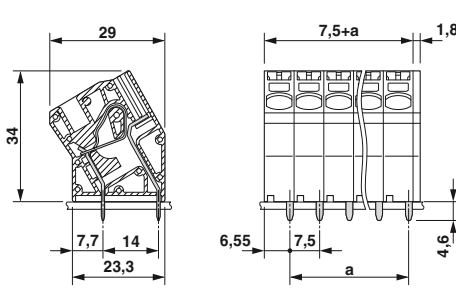

### Drilling diagram

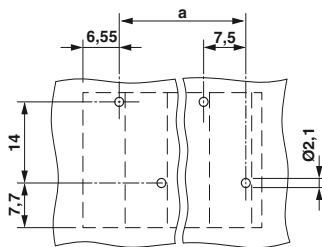

### Ordering data

Type Order No. Pcs. / Pkt.  
7.5 mm pitch, color: green

SPTA 5/ 1-7,5 1819079 50

### Ordering data

Type Order No. Pcs. / Pkt.  
7.5 mm pitch, color: green

SPTA 5/ 2-7,5-ZB	1819082	50
SPTA 5/ 3-7,5-ZB	1819095	50
SPTA 5/ 4-7,5-ZB	1819105	50
SPTA 5/ 5-7,5-ZB	1819118	50
SPTA 5/ 6-7,5-ZB	1819121	50
SPTA 5/ 7-7,5-ZB	1819134	50
SPTA 5/ 8-7,5-ZB	1819147	50
SPTA 5/ 9-7,5-ZB	1819150	50
SPTA 5/10-7,5-ZB	1819163	50
SPTA 5/11-7,5-ZB	1819176	50
SPTA 5/12-7,5-ZB	1819189	50

### PCB terminal blocks, angled, 10 mm pitch

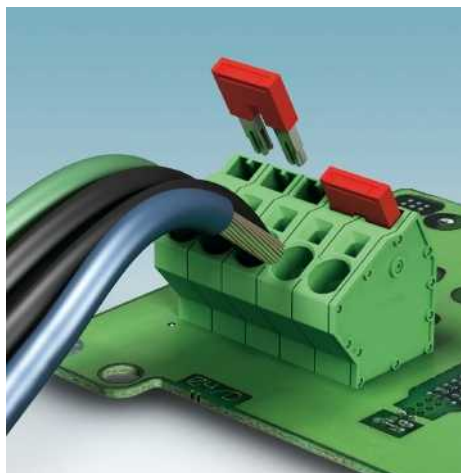

- SPTA 16 PCB terminal block with push-in spring connection for conductor cross sections up to 16 mm<sup>2</sup> and a current carrying capacity of 76 A
- Fully insulated bridges (FBSK) with different number of positions, e. g. for potential distribution
- Fast connection method thanks to principle of direct plug-in without tools
- Unrestricted 600-V-UL approval thanks to compact zig-zag pinning
- Conductor connection direction: 30° to the PCB
- Single-position terminal blocks with double pinning

#### Notes:

When aligning versions with double pinning, other rated insulation voltages can occur.

<sup>1)</sup> Please observe the current carrying capacity curves and laboratory data sheets. Further current carrying capacity curves on request.

#### For accessories, see Catalog 1

For all types	Type	Page
	Screwdriver SZF 2-0,8 x4,0 Order No. 1204520	
	Crimping pliers for 0.25 to 6 mm <sup>2</sup> CRIMPFOX 6 Order No. 1212034	
	Crimping pliers for 10 to 16 mm <sup>2</sup> CRIMPFOX 16 S Order No. 1207983	
	Fixed bridge FBSK ...-10/ZFKDS 10	830

#### Current carrying capacity curve

Type: SPTA 16/...-10,0

Tested according to DIN EN 60512-5-2:2003-01

Reduction factor = 1

Number of positions: 4

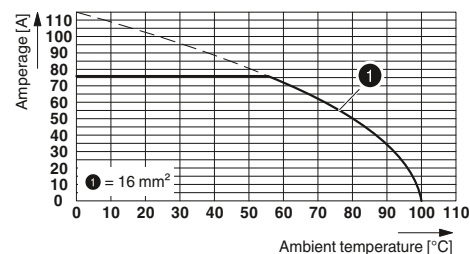

#### Technical data

Technical data in accordance to IEC / DIN VDE	
Rated current / conductor cross section	[A] / [mm <sup>2</sup> ]
Rated insulation voltage for pollution degree 2	[V]
Pitch	[mm]
Solid & multi-strand / stranded	[mm <sup>2</sup> ] / [mm <sup>2</sup> ] / AWG
Stranded with ferrules without plastic sleeve	[mm <sup>2</sup> ]
Stranded with ferrules with plastic sleeve	[mm <sup>2</sup> ]
Multi-conductor connection capacity (two conductors with the same cross section)	
Solid & multi-strand / stranded	[mm <sup>2</sup> ]
Stranded with ferrules without plastic sleeve	[mm <sup>2</sup> ]
Stranded with TWIN ferrule with plastic sleeve	[mm <sup>2</sup> ]
Insulation coordination	
Surge voltage category / pollution degree	
Rated insulation voltage	[V]
Rated surge voltage	[kV]
Approval data (UL/CUL)	Use Group
Nominal voltage	[V]
Nominal current	[A]
Connection capacity AWG	AWG
Approval data (CSA)	Use Group
Nominal voltage	[V]
Nominal current	[A]
Connection capacity AWG	AWG
General data	
Stripping length	[mm]
Type of insulation material / insulation material group	
Inflammability class according to UL 94	
Drill hole diameter / pin dimensions	[mm]

#### SPTA 16/1-10,0

Rated current / conductor cross section			76 <sup>1)</sup> / 10		
Rated insulation voltage for pollution degree 2			1000		
Pitch			10		
Solid & multi-strand / stranded			0.75 - 10 / 0.75 - 16 / 18 - 4		
Stranded with ferrules without plastic sleeve			0.75 - 16		
Stranded with ferrules with plastic sleeve			0.75 - 10		
Multi-conductor connection capacity (two conductors with the same cross section)					
Solid & multi-strand / stranded			- / -		
Stranded with ferrules without plastic sleeve			-		
Stranded with TWIN ferrule with plastic sleeve			0.75 - 4		
Insulation coordination					
Surge voltage category / pollution degree			III / 3   III / 2   II / 2		
Rated insulation voltage			1000   1000   1000		
Rated surge voltage			8   8   6		
Approval data (UL/CUL)			B   C   D		
Nominal voltage			-		
Nominal current			-		
Connection capacity AWG			-		
Approval data (CSA)			B   C   D		
Nominal voltage			-		
Nominal current			-		
Connection capacity AWG			-		
General data					
Stripping length			18		
Type of insulation material / insulation material group			PA / I		
Inflammability class according to UL 94			V0		
Drill hole diameter / pin dimensions			1.7 / 1.2 x 1		

#### SPTA 16/...-10,0-ZB

Rated current / conductor cross section			76 <sup>1)</sup> / 10		
Rated insulation voltage for pollution degree 2			1000		
Pitch			10		
Solid & multi-strand / stranded			0.75 - 10 / 0.75 - 16 / 18 - 4		
Stranded with ferrules without plastic sleeve			0.75 - 16		
Stranded with ferrules with plastic sleeve			0.75 - 10		
Multi-conductor connection capacity (two conductors with the same cross section)					
Solid & multi-strand / stranded			- / -		
Stranded with ferrules without plastic sleeve			-		
Stranded with TWIN ferrule with plastic sleeve			0.75 - 4		
Insulation coordination					
Surge voltage category / pollution degree			III / 3   III / 2   II / 2		
Rated insulation voltage			1000   1000   1000		
Rated surge voltage			8   8   6		
Approval data (UL/CUL)			B   C   D		
Nominal voltage			-		
Nominal current			-		
Connection capacity AWG			-		
Approval data (CSA)			B   C   D		
Nominal voltage			-		
Nominal current			-		
Connection capacity AWG			-		
General data					
Stripping length			18		
Type of insulation material / insulation material group			PA / I		
Inflammability class according to UL 94			V0		
Drill hole diameter / pin dimensions			1.7 / 1.2 x 1		

No. of pos.	Dim. a [mm]
1	0.00
2	10.00
3	20.00
4	30.00
5	40.00
6	50.00
7	60.00
8	70.00
9	80.00



Single PCB terminal block,  
30° angled connection direction,  
double pinning



30° angled connection direction,  
zigzag pinning, 600 V UL approval



Dimensional drawing

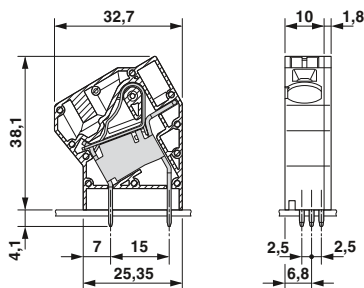

Drilling diagram

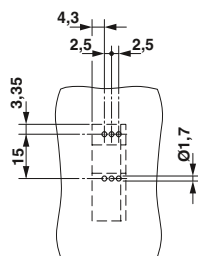

Dimensional drawing

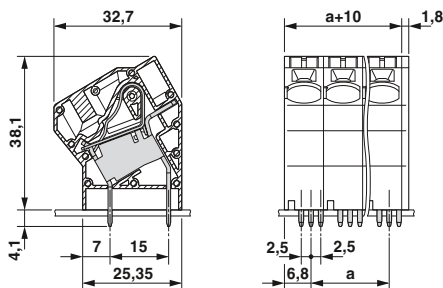

Drilling diagram

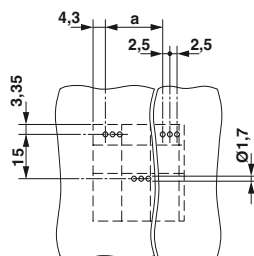

Ordering data

Type	Order No.	Pcs. / Pkt.
10 mm pitch, color: green		
SPTA 16/ 1-10,0	1819192	50

Ordering data

Type	Order No.	Pcs. / Pkt.
10 mm pitch, color: green		
SPTA 16/ 2-10,0-ZB	1819202	50
SPTA 16/ 3-10,0-ZB	1819215	50
SPTA 16/ 4-10,0-ZB	1819228	50
SPTA 16/ 5-10,0-ZB	1819231	50
SPTA 16/ 6-10,0-ZB	1819244	50
SPTA 16/ 7-10,0-ZB	1819257	50
SPTA 16/ 8-10,0-ZB	1819260	50
SPTA 16/ 9-10,0-ZB	1819273	50

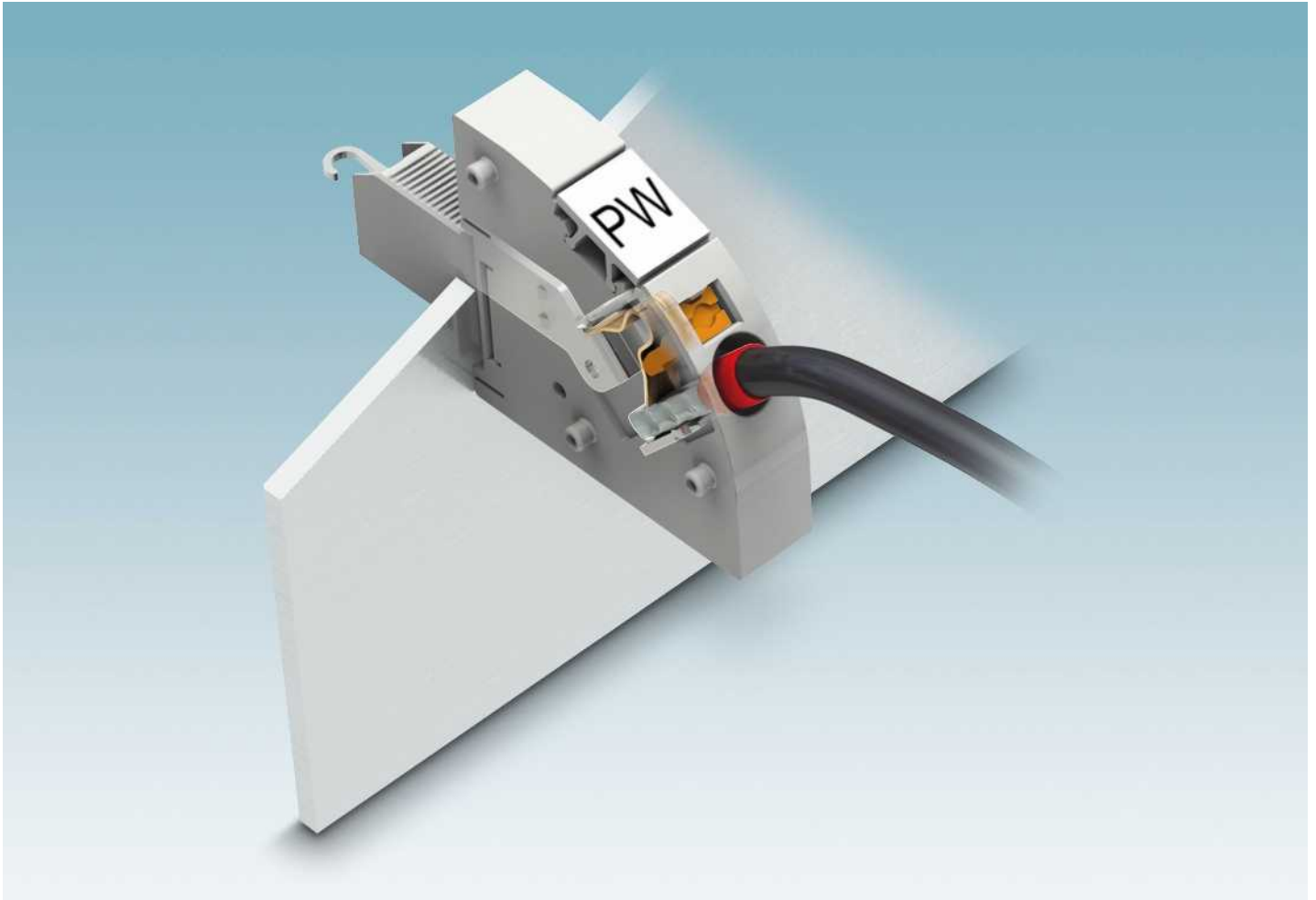

The 45° push-in spring connection enables quick, tool-free, and space-saving connection. The solid conductor or a conductor with ferrule is simply inserted into the terminal point and pressed against the current bar by the spring. It is only when fine-strand conductors without ferrules are connected and when this connection is released that it is necessary to use a standard bladed screwdriver. The perfect connection for rapid wiring in the field.



Optimally seal the potting compounds - molded feed-through terminal blocks from Phoenix Contact

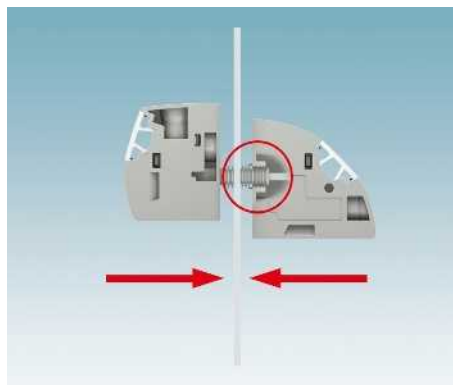

The terminal blocks consist of an internal and external element. These pass through the housing panel and snap together without the need for tools. The engagement mechanism ensures a tight fit, however thick the panel.

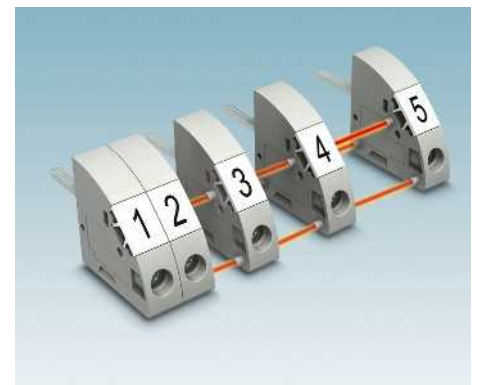

The various engagement pin versions can be used to create pre-assembled blocks for fast mounting.

### PWO 16... high-current feed-through terminal blocks with screw connection



- Outside the device with convenient push-in connection
- Inside the device with classic screw connection
- The two halves of the terminal can be easily assembled by simply snapping them together
- Automatic panel thickness compensation
- Flange plates as alternative mounting options

**Notes:**  
 Inside = left side of portrait photos  
 Outside = right side of portrait photos

Corresponding screws for fixing the panel feed-through terminal blocks are supplied as standard.



16 mm<sup>2</sup> panel feed-through terminal block, external part with push-in connection, internal part with screw connection

#### Accessories

For all types	Type
	Flange plate PWO 16-F Order No. 1705659

#### Dimensional drawing

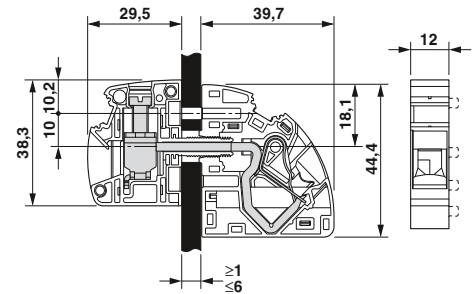

#### Drilling diagram

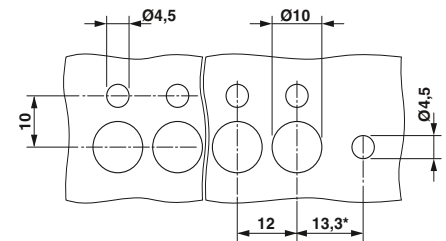

#### Technical data

Technical data in accordance to IEC / DIN VDE		
Current/conductor cross section	[A] / [mm <sup>2</sup> ]	76 / 16 // 76 / 16
Rated voltage	[V]	1000
Connection capacity		
Solid / stranded	[mm <sup>2</sup> ]/[mm <sup>2</sup> ]/AWG	1.5 - 16 / 1.5 - 16 / 14 - 4
Stranded with ferrules without plastic sleeve	[mm <sup>2</sup> ]	1.5 - 16
Stranded with ferrules with plastic sleeve	[mm <sup>2</sup> ]	1.5 - 16
Multi-conductor connection capacity (two conductors with the same cross section)		
Solid / stranded	[mm <sup>2</sup> ]	- / -
Stranded with ferrules without plastic sleeve	[mm <sup>2</sup> ]	-
Stranded with TWIN ferrule with plastic sleeve	[mm <sup>2</sup> ]	1.5 - 4
Cross section with insertion bridge (solid/stranded)	[mm <sup>2</sup> ]	- / -
Insulation coordination		
Surge voltage category / pollution degree		III / 3    III / 2    II / 2
Rated insulation voltage	[V]	800    1000    1000
Rated surge voltage	[kV]	6    6    6
Approval data (UL/CUL)	Use Group	B    C    D
Nominal voltage	[V]	-    -    -
Nominal current	[A]	-    -    -
Connection capacity AWG	AWG	-    -    -
Approval data (CSA)	Use Group	B    C    D
Nominal voltage	[V]	-    -    -
Nominal current	[A]	-    -    -
Connection capacity AWG	AWG	-    -    -
General data		
Stripping length	[mm]	18
Cable lug connection: thread / tightening torque		
Insulation material		PA
Inflammability class according to UL 94		V0
Panel thickness	[mm]	1 - 6

#### Ordering data

Type	Order No.	Pcs. / Pkt.
Panel feed-through terminal block		
PWO 16-UW	1844387	50
Panel feed-through terminal block, with engagement pin		
PWO 16-UW/S	1844390	50

ZB 12.../ZBF 12... marking material (see Catalog 5)

TMT (EX9,5)R marking material (see online catalog)

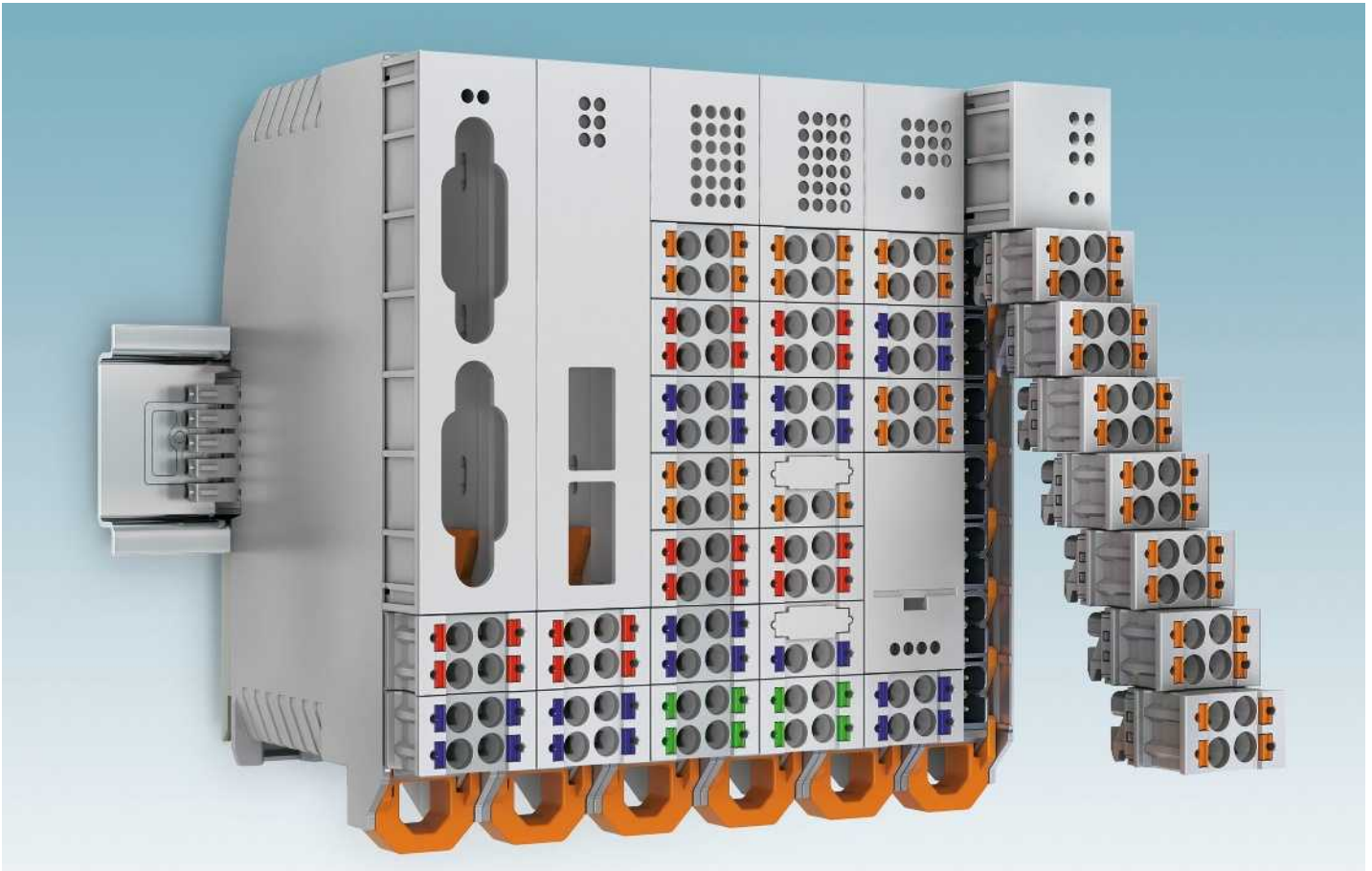

The ME-IO housing is particularly suitable for applications with a small amount of installation space. The push-in front connection technology as well as the compact design enable devices with up to 36 positions to be implemented in a confined space.

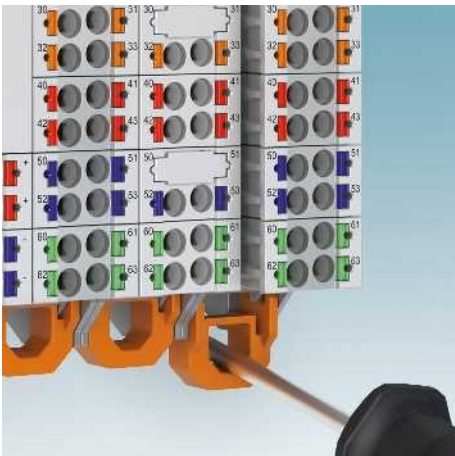

The Lock & Release system provides secure and defined locking and release for plugs and headers.

Releasing the lever automatically ejects the plug from the header. The contact system between the plug and header is interrupted, but the plugs do not fall out.

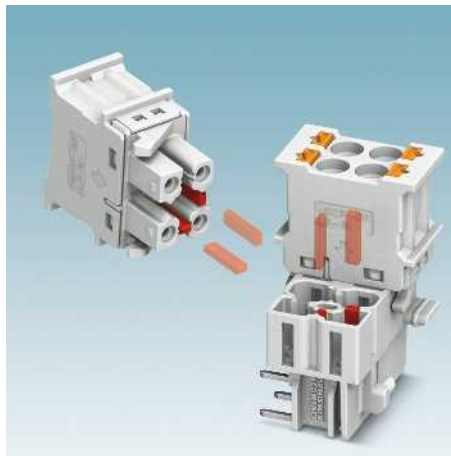

Coding with CP-DMC... coding profile prevents mismatching in the device.

The HSCP-... plugs and HSCH ... headers are mounted with corresponding CP-DMC ... coding profiles. If the coding profile is mounted between the same positions, the plug cannot be plugged in.

The coding can be implemented later on site or is provided in pre-assembled versions.

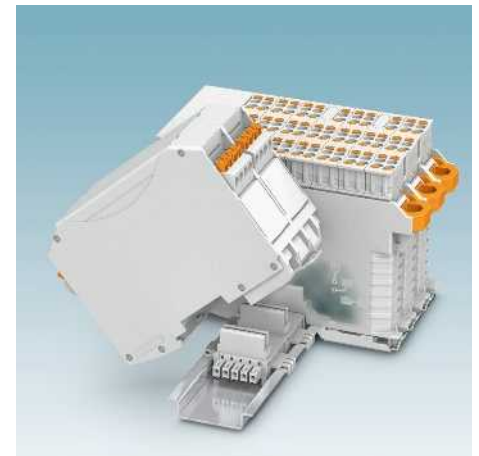

The ME 18,8 TBUS connector can be snapped onto the NS 35/7,5 DIN rail to connect individual modules together. This means that the signal and supply voltage can be implemented in the device system without any wiring.

The bus connector is compatible with the bus system of the ME TBUS and ME MAX housing ranges, thereby enabling the creation of complex devices with quick and convenient mounting.





**Flexible modular principle**

The flexible housing concept of ME-IO offers numerous solutions. Thanks to the variety of covering hoods, plugs, and headers, there is no doubt a solution for your special requirements.

An overview of predefined assembly versions is shown on the next page.

**Lock & Release**

The Lock & Release system is available in four lengths. It is available in 3, 5, 7, and 9 units. The length of Lock & Release defines the possible plug area.

**Various covering hoods**

Covering hoods are available in lengths from 2 to 7 units. This means that the appropriate hood can be used for display and operating elements as well as data connectors.

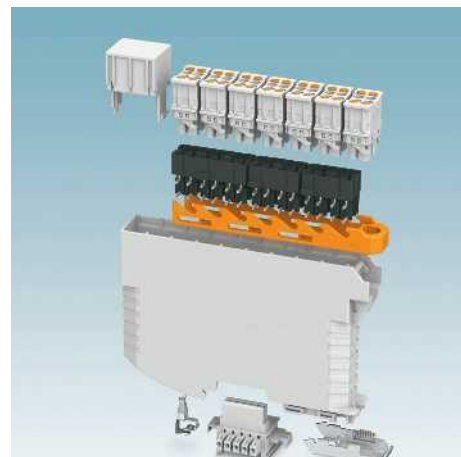

**Plug version with TWIN connection**

The TWIN connector is characterized by the connection of two conductors to one connection terminal. It is used to loop through signals or to distribute potential or power.

The 2 and 4-pos. plug versions can be flexibly combined for sophisticated device solutions.





**Color options for the plug**

The spring levers of plugs can also be produced in other standard colors. This enables easy conductor/terminal point assignment during installation.

The plug and electronics housing can be produced in non-standard colors as well.

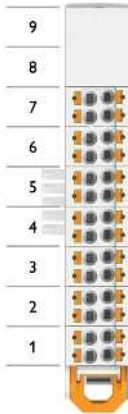
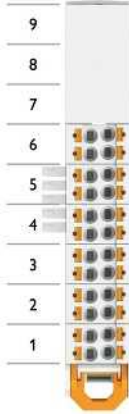
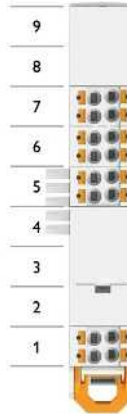
**Exploded view of the ME-IO housing system**

### Matrix for selection

			Example 1			Example 2			Example 3		
											
			28-pos.	20-pos. + 4 TWIN connections	26-pos.	24-pos.	6-pos. + 4 TWIN connections	22-pos.	12-pos. + 2 TWIN connections		
			Quantity (fitted position)			Quantity (fitted position)			Quantity (fitted position)		
<b>Lower housing part with Lock &amp; Release</b>											
	Order No.	Type									
	2201960	ME-IO 18,8 B/FE 9/9U TBUS 7035	1 x	1 x	1 x	1 x	1 x	1 x	1 x		
	2201961	ME-IO 18,8 B/FE 7/9U TBUS 7035									
	2201962	ME-IO 18,8 B/FE 5/9U TBUS 7035									
<b>Covering hood</b>											
	2201799	ME-IO 18,8 C 2U 7035	1 x (8-9)	1 x (8-9)	1 x (8-9)					1 x (8-9)	
	2201800	ME-IO 18,8 C 3U 7035				1 x (7-9)	1 x (7-9)	1 x (7-9)			
	2201801	ME-IO 18,8 C 3U S1 7035								1 x (2-4)	
	2201802	ME-IO 18,8 C 4U 7035									
	2201803	ME-IO 18,8 C 5U 7035									
	2201804	ME-IO 18,8 C 6U 7035									
<b>Header</b>											
	2201788	HSCH 2,5-3U/12 9005	1 x (5-7)	1 x (5-7)	1 x (5-7)					1 x (5-7)	
	2201789	HSCH 2,5-2U/ 8 9005	2 x (1-4)	1 x (3-4)	1 x (1-2)	3 x (1-6)	2 x (3-6)	2x(1-2 & 5-6)			
	2201790	HSCH 2,5-2U-TTTT 9005		1 x (1-2)			1 x (1-2)				
	2201791	HSCH 2,5-2U-TT00 9005								1 x (1-2)	
	2201792	HSCH 2,5-2U-2220 9005			1 x (3-4)			1 x (3-4)			
<b>Plug with push-in spring connection</b>											
	2201780	HSCP-SP 2,5-1U/ 4 7035	7 x (1-7)	5 x (3-7)	6x(1-3 & 5-7)	6 x (1-6)	4 x (3-6)	5x(1-3 & 5-6)	3 x (5-7)		
	2201781	HSCP-SP 2,5-1U-TT 7035		2 x (1-2)			2 x (1-2)		1 x (1)		
	2201782	HSCP-SP 2,5-1U-20 7035			1 x (4)			1 x (4)			

**Notes:**

For the functionality of the Lock & Release system, note the positioning of the header. A side-by-side arrangement of the HSCH 2,5-3U/12 9005 header is not possible. In the examples, the quantities of covering hoods, headers, and plugs and their respective position for fitting are specified. Data sheets for the housing system with connectors are available at [phoenixcontact.net/products](http://phoenixcontact.net/products). Numerous other configurations are possible.

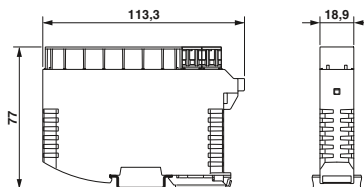

Example 4			Example 5			Example 6	Example 7		Example 8	Example 9
20-pos.	12-pos. + 4 TWIN connections	18-pos.	16-pos.	8-pos. + 4 TWIN connections	14-pos.	12-pos.	8-pos.	4 TWIN connections	24-pos.	36-pos.
Quantity (fitted position)			Quantity (fitted position)			Quantity (fitted position)	Quantity (fitted position)		Quantity (fitted position)	Quantity (fitted position)
									1 x	1 x
1 x	1 x	1 x	1 x	1 x	1 x	1 x	1 x	1 x		
									1 x (4-6)	
1 x (6-9)	1 x (6-9)	1 x (6-9)	1 x (5-9)	1 x (5-9)	1 x (5-9)	1 x (4-9)	1 x (3-9)	1 x (3-9)		
1 x (3-5)	1 x (3-5)	1 x (3-5)				1 x (1-3)			2 x (1-3 & 7-9)	1 x (7-9)
1 x (1-2)	1 x (1-2)		2 x (1-4)	1 x (3-4)	1 x (3-4)		1 x (1-2)			3 x (1-6)
		1 x (1-2)			1 x (1-2)			1 x (1-2)		
5 x (1-5)	3 x (3-5) 2 x (1-2)	4 x (1 & 3-5) 1 x (2)	4 x (1-4)	2 x (3-4) 2 x (1-2)	3 x (1 & 3-4) 1 x (2)	3 x (1-3)	2 x (1-2)		6 x (1-3 & 7-9)	9 x (1-9)
								2 x (1-2)		



### ME-IO... electronics housing with front connection

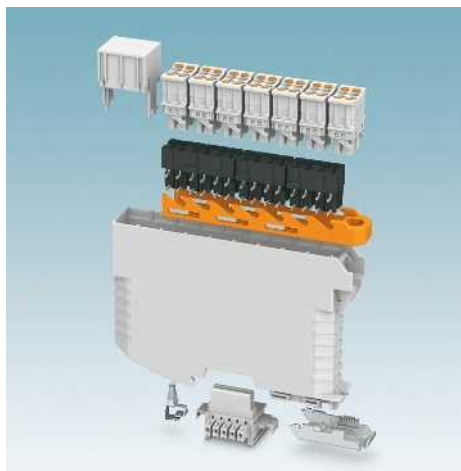

#### Mounting principle:

- Electronic components and HSC headers can be assembled and soldered in a single step.
- Lock & Release and headers are snapped in. The pressure springs are inserted in the rear grips provided.
- The PCB can be easily snapped into the housing thanks to the guide edges in the lower housing part.
- The covering hood is placed on the free area and snapped into the HSC headers.
- The HSC plugs are marked with an arrow to indicate the plug-in direction.

#### HSC headers and plugs:

The headers are available in two and three-unit sizes and the plugs in one unit. Two plugs fit on the HSCH 2,5-2U... and three plugs fit on the HSCH 2,5-3U...

The HSC headers differ with regard to the number of terminal points and require the relevant plug versions:

- 12 terminal points – 3 x 4-pos.
- 8 terminal points – 2 x 4-pos.
- 6 terminal points – 1 x 4-pos. and 1 x 2-pos.
- 4 terminal points – 2 x 2 TWIN connections
- 2 terminal points – 1 x 2 TWIN connections and ME-IO 18,8 C 3U S1 7035

#### Notes:

Additional housing dimensions and details of PCB layout, dimensions, and assembly areas can be found in the download center at: [phoenixcontact.net/products](http://phoenixcontact.net/products)



Width: 18.8 mm

#### Ordering data

Ordering data		
Type	Order No.	Pcs. / Pkt.
<b>Description</b>		
<b>Housing base</b> , pre-assembled, with metal foot catch, with integrated functional earth ground contact, without TBUS plug, color: light gray, including Lock & Release in		
3 units		
5 units		
7 units		
9 units		
<b>Covering hood</b> , in various units, color: light gray		
2 units, dimension a = 22 mm		
3 units, dimension a = 33 mm		
3 units, for covering 1 unit header, dimension a = 33 mm		
4 units, dimension a = 44 mm		
5 units, dimension a = 55 mm		
6 units, dimension a = 66 mm		
7 units, dimension a = 77 mm		
<b>HSC header</b> , touch proof, in 2 units, color: black		
8 connections		
4 connections		
2 connections		
6 connections		
<b>HSC header</b> , touch proof, in 3 units, color: black, please note the positioning		
12 connections		
<b>HSC push-in plug</b> , for touch-proof HSC headers, in 1 unit, with integrated test connection, color: light gray		
4-pos.		
Partially assembled, 2-pos.		
2 TWIN connections		
<b>DIN rail connector</b> , 5-pos.		
<b>Coding profile</b> , for header and push-in plug, color: natural		
Accessories		

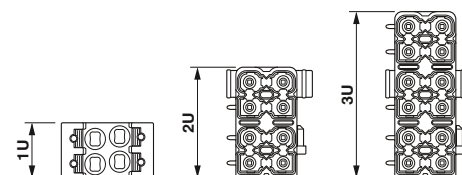



Width: 18.8 mm

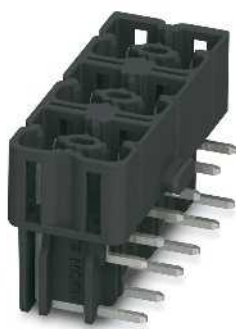

Touch-proof headers



Connector plugs for touch-proof headers

### Ordering data

Type	Order No.	Pcs. / Pkt.
ME-IO 18,8 C 2U 7035	2201799	10
ME-IO 18,8 C 3U 7035	2201800	10
ME-IO 18,8 C 3U S1 7035	2201801	10
ME-IO 18,8 C 4U 7035	2201802	10
ME-IO 18,8 C 5U 7035	2201803	10
ME-IO 18,8 C 6U 7035	2201804	10
ME-IO 18,8 C 7U 7035	2201805	10

### Ordering data

Type	Order No.	Pcs. / Pkt.
HSCH 2,5-2U/ 8 9005	2201789	50
HSCH 2,5-2U-TTTT 9005	2201790	50
HSCH 2,5-2U-TT00 9005	2201791	50
HSCH 2,5-2U-2220 9005	2201792	50
HSCH 2,5-3U/12 9005	2201788	50

### Ordering data

Type	Order No.	Pcs. / Pkt.
HSCP-SP 2,5-1U/ 4 7035	2201780	50
HSCP-SP 2,5-1U-TT 7035	2201781	50
HSCP-SP 2,5-1U-20 7035	2201782	50

### Accessories

--	--	--

### Accessories

--	--	--

### Accessories

ME 18,8 TBUS 1,5/5-ST-3,81KMGY	2201813	50
CP-DMC 1,5-THR NAT	1790647	60

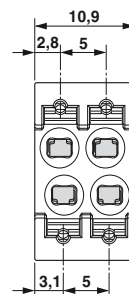
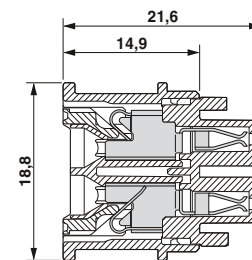
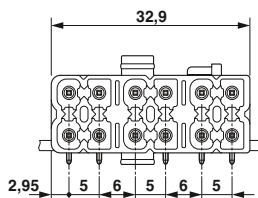
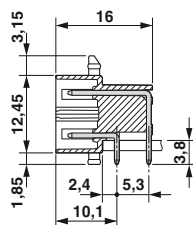
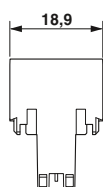
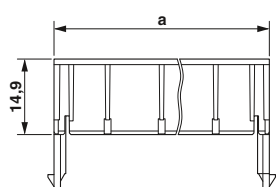

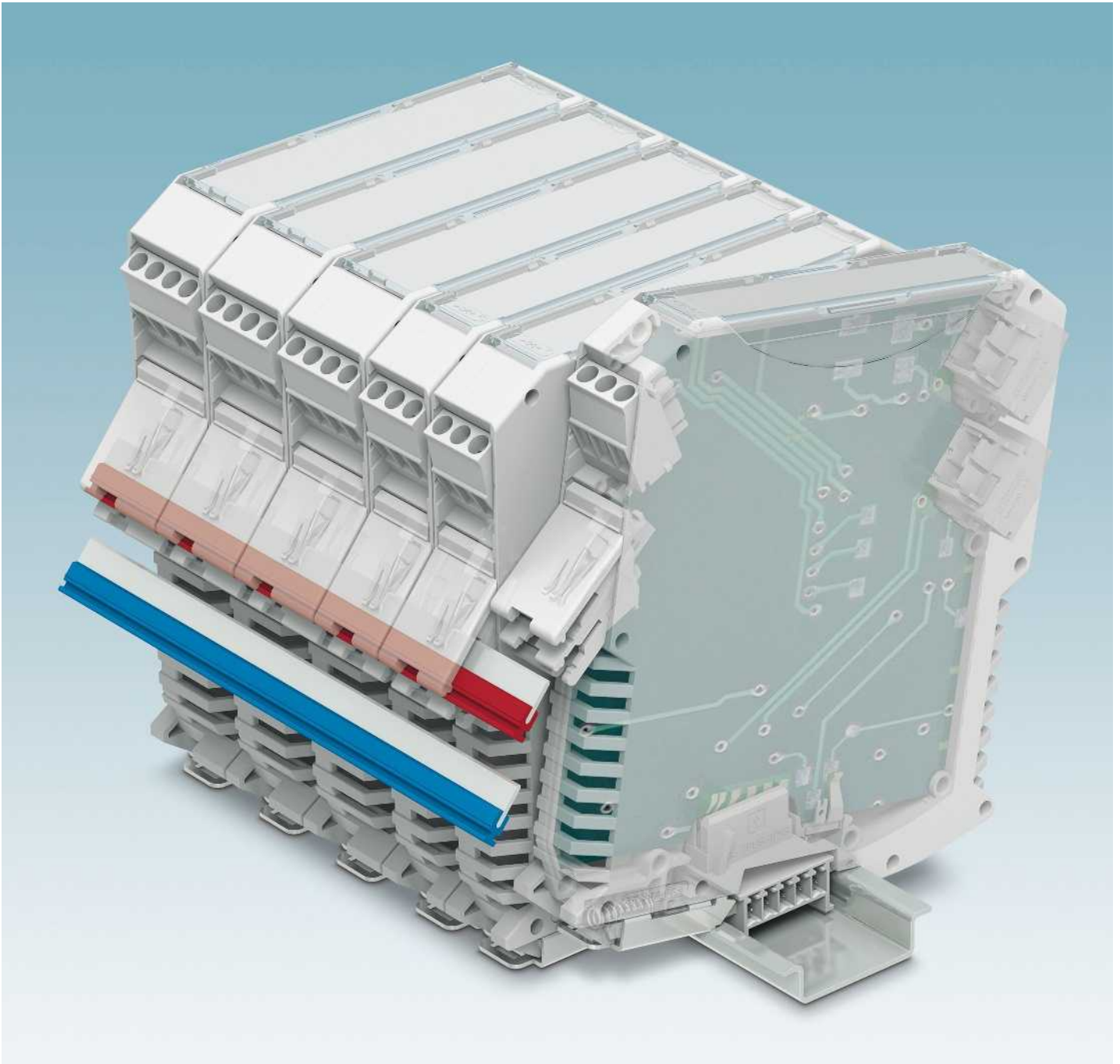

Together with the PBR jumper, the new PCO power connector enables the transmission of high levels of power between modules in ME MAX housings.

The new ME TBUS 4P1S enables the easy implementation of serial and parallel circuits for module-to-module connection in the DIN rail.

The ME TBUS ADAPTER allows even more effective use of ME TBUS technology for modules with a design width from 35 mm. ME TBUS 4P1S and the ME TBUS ADAPTER can be used in ME and ME MAX housings.

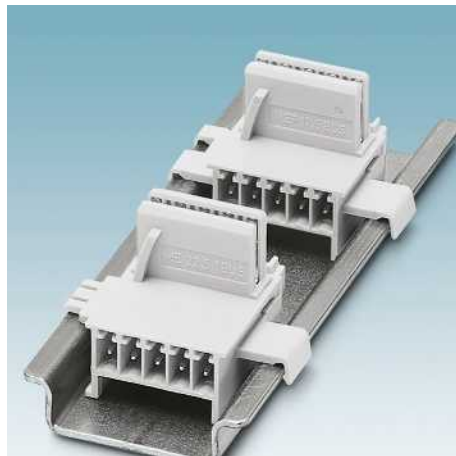
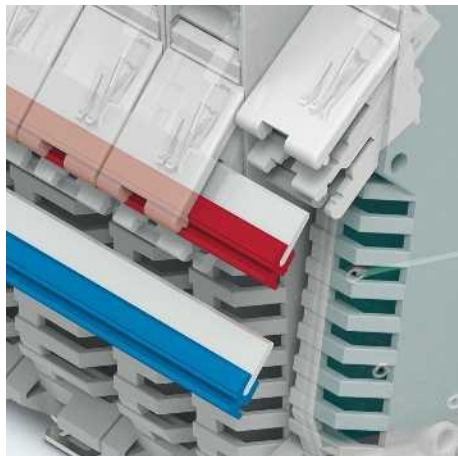

#### **PCO... power connector for ME MAX housing**

The PCO power connector is used to transmit power of up to 42 A (8 A per module) and 60 V DC between modules in ME MAX housings. There are no restrictions on the mounting and removal of modules from the group while in the off-load state.

The PCO connector can be soldered to other electronic components in the wave soldering process. For additional information, please refer to the data sheets at [phoenixcontact.net/products](http://phoenixcontact.net/products). Cross connection is achieved by simply inserting the PBR jumper.

#### **ME... TBUS 4P1S: serial and parallel connection in the DIN rail**

The ME TBUS 4P1S enables the serial and parallel connection of modules via the DIN rail: 4 positions are intended for parallel circuits and 1 position for serial circuits.

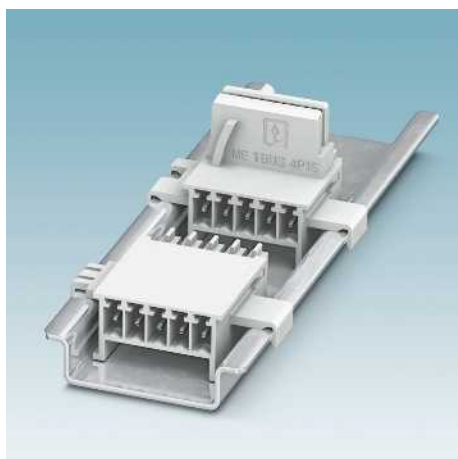

#### **ME TBUS ADAPTER: easy extension**

From a housing width of 35 mm, the ME TBUS ADAPTER is the ideal solution for the efficient use of the TBUS system.

In addition, by using the ME TBUS ADAPTER there is more PCB area available for mounting in the housing as there is no T-tap.

### PCO... power connector for ME MAX housing

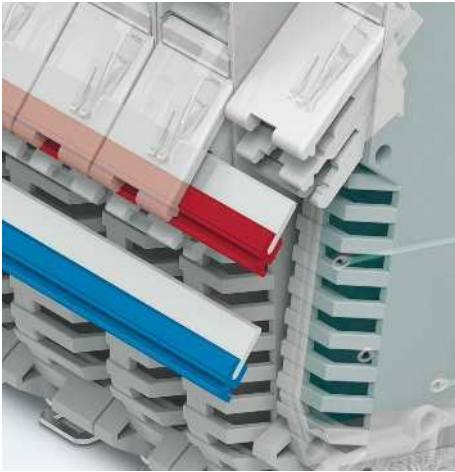

The PCO... power connector can be used together with the PBR... jumper in ME MAX housing.

#### Technical data:

- Voltage up to 60 V DC
- Total current of 42 A
- 8 A per module
- 2-pos.
- With orthogonal pin outlet
- Designed for parallel connections
- ME MAX connection technology and accessories can also be used without restriction



Description
<b>Power bus connector</b> , suitable for ME MAX 17,5, ME MAX 35, 2-pos., color: light gray
<b>Power bus connector</b> , suitable for ME MAX 22,5, ME MAX 45, ME MAX 67,5, and ME MAX 90; 2-pos.; color: light gray

<b>Jumper</b> , for connecting device modules when using power bus connectors; can be cut to length using diagonal cutter; supplied length: 500 mm; Color: light gray Color: blue Color: red
---

#### Ordering data

Type	Order No.	Pcs. / Pkt.
PCO 17,5-L KMGY	2201684	50
PCO 22,5-L KMGY	2201685	50

#### Accessories

PBR 42A KMGY	2201917	10
PBR 42A BU	2201916	10
PBR 42A RD	2201915	10



**ME TBUS 4P1S and ME TBUS ADAPTER for ME and ME MAX housing**

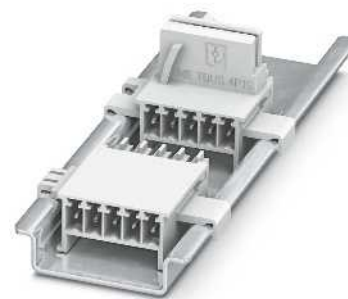

The ME... TBUS 4P1S enables the implementation of parallel circuits together with serial circuits, which connect various modules on the DIN rail in ME and ME MAX housings.

Technical data:

- Voltage up to 50 V
- Currents up to 8 A per position
- 4 parallel positions
- 1 serial position

The ME... TBUS ADAPTER is particularly useful for using wider modules in the ME and ME MAX housing more efficiently together with the ME... TBUS.

Technical data:

- Voltage up to 125 V
- Currents up to 8 A per position
- 5 parallel positions
- No tap in the electronics housing

Description	No. of pos.
<b>ME TBUS connector</b> , suitable for ME and ME MAX housing, 5 positions (4 parallel positions and 1 serial position); color: light gray	
17.5 mm design width	5
22.5 mm design width	5
<b>Adapter for extending the ME TBUS connector</b> , suitable for ME and ME MAX housing, 5 parallel positions; color: light gray	
17.5 mm design width	5
22.5 mm design width	5

Ordering data		
Type	Order No.	Pcs. / Pkt.
<b>ME 17,5 TBUS 1,5/4P1S KMGY</b>	<b>2201731</b>	50
<b>ME 22,5 TBUS 1,5/4P1S KMGY</b>	<b>2201732</b>	50
<b>ME 17,5 TBUS ADAPTER KMGY</b>	<b>2201757</b>	50
<b>ME 22,5 TBUS ADAPTER KMGY</b>	<b>2201756</b>	50



RJ45 industrial connectors, IP20  
Page 44



Push-pull industrial connectors, version 14  
with RJ45 insert  
Page 46



Push-pull industrial connectors, version 14  
with FO insert  
Page 48



Modular distribution panel, panel mounting  
frame  
Page 50



M12 device connectors XL  
Page 54



M12 power device connectors  
Page 56



M23 cable and coupler connectors, hybrid,  
SPEEDCON fast locking system  
Page 63



M23 device connectors, hybrid  
Page 64



SUNCLIX micon, AC-Y connectors  
Page 70



SUNCLIX micon, mains connector plugs  
Page 70

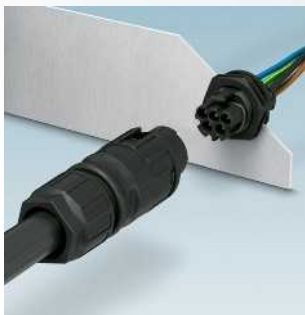
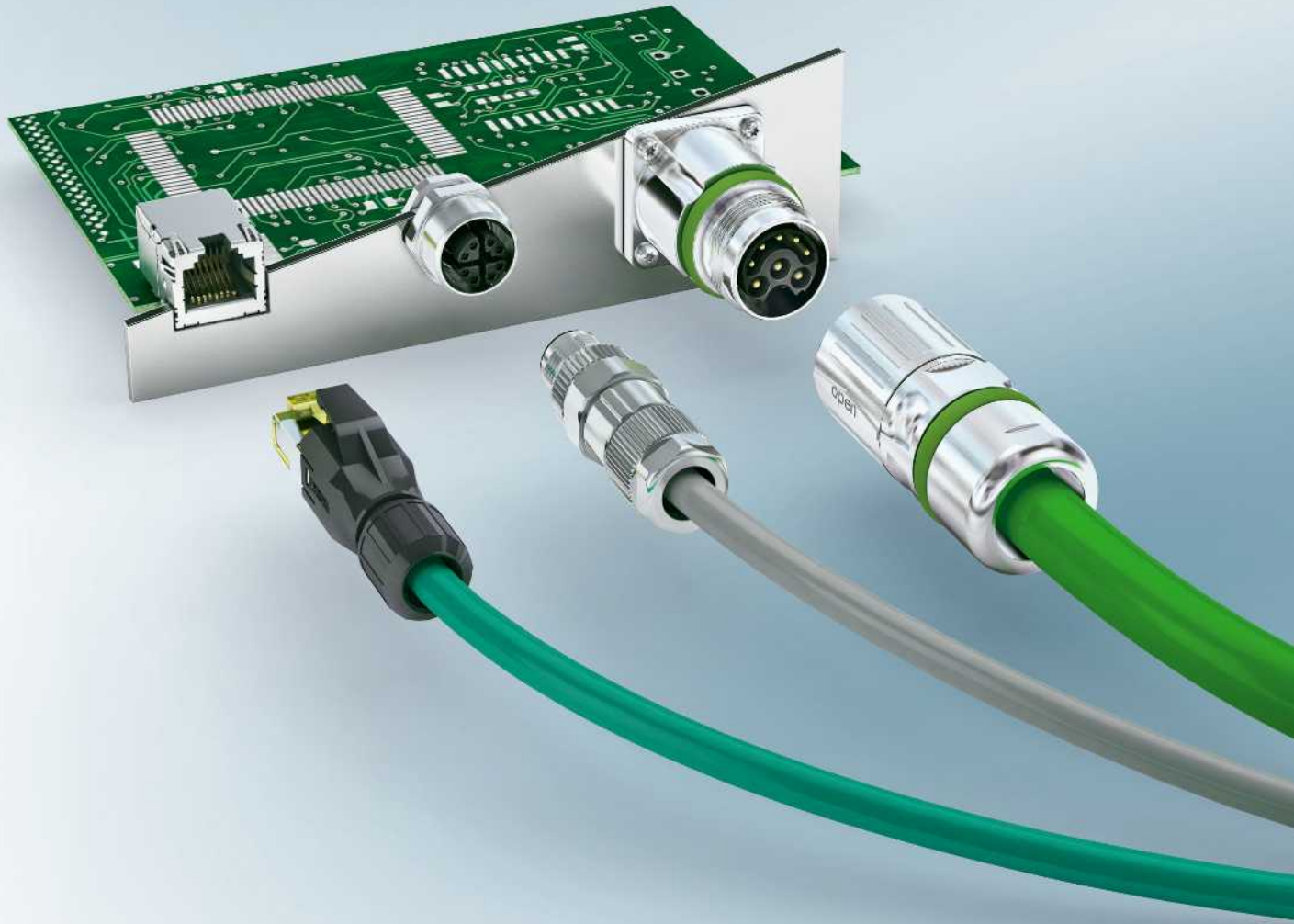

Photovoltaic AC connectors

Page 76



AC charging cables

Page 80



Mobile AC charging cables

Page 83



Combined charging system charging cables

Page 84

# Connection technology for field devices

## Data connectors

### Unique variety for copper and fiber optics

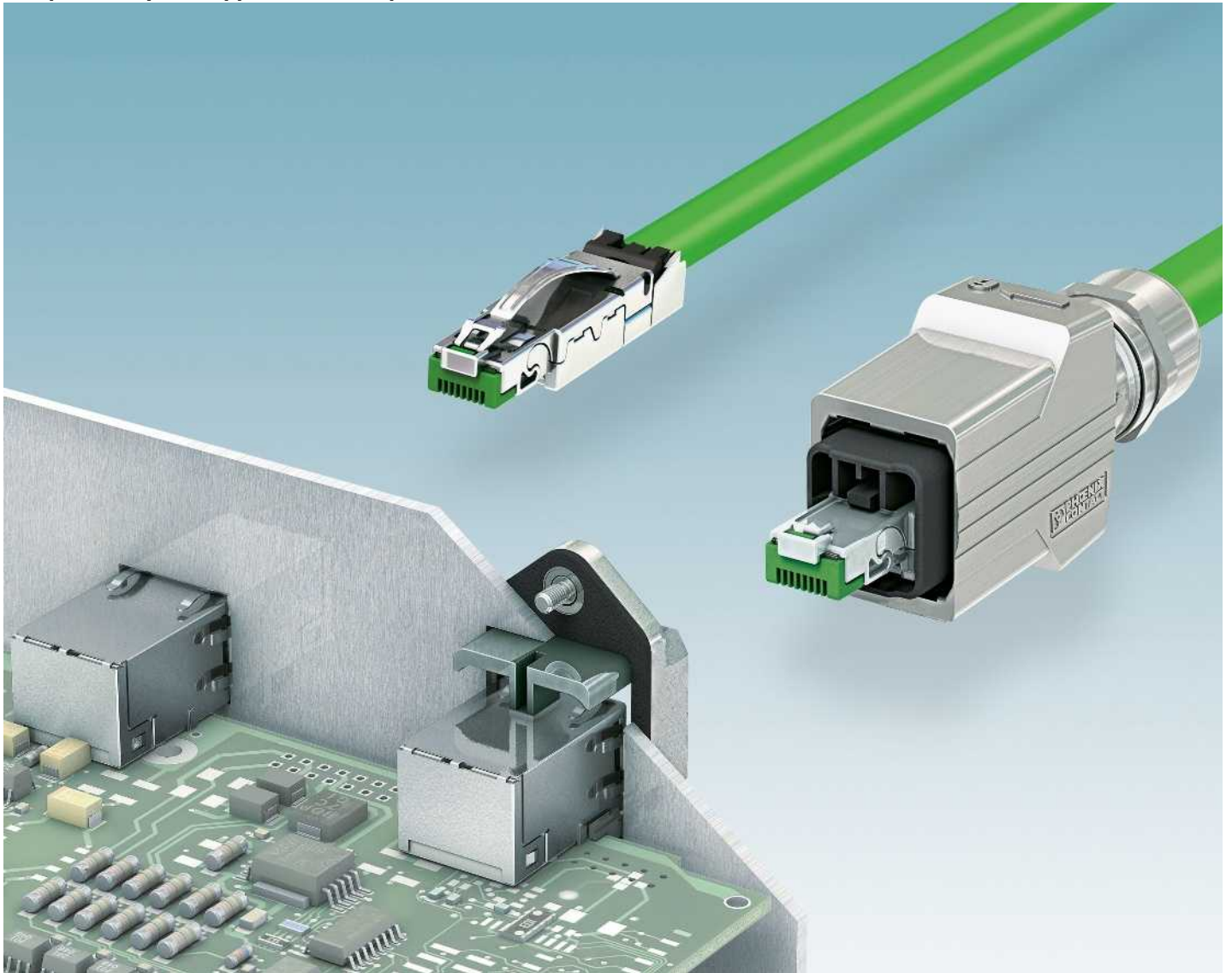

For compact device connection



For flexible cable connection



For easy cabling

The right connection for every application



Modern industrial automation requires connectors for large quantities of data in robust packaging. Benefit now from powerful connectors and cables for on-site assembly.



High requirements are placed on components used for outdoor data transmission, in fields such as telecommunications, renewable energies, and offshore applications. Whether you're concerned about UV, temperature or humidity, the connectors from Phoenix Contact offer ideal protection.



Phoenix Contact offers an extensive and forward-looking product range for modern building cabling which impresses with its easy installation. Our patch cables and patch fields allow you to install flexible and fault-tolerant cabling.

The right connection technology for every application



**Fast assembly without special tools**  
– with IDC and Piercecon® fast connection



**Fast assembly in the field**  
using professional tools

### RJ45 industrial connectors, IP20

- Optimized for industrial use with a high degree of resistance to vibration
- High resistance to ESD and EMI for reliable transmission
- Easy handling, thanks to one-piece design
- Metal locking



**RJ45 industrial, straight cable outlet**



**RJ45 industrial, cable outlet at the top**

	Technical data				Technical data			
	Ethernet printing		PROFINET printing		Ethernet printing		PROFINET printing	
Degree of protection	IP20		IP20		IP20		IP20	
Connection cross section AWG	26 ... 24		23 ... 22		26 ... 24		23 ... 22	
Transmission speed	10 Gbps		1 Gbps		10 Gbps		1 Gbps	
Housing material	Zinc die-cast		Zinc die-cast		Zinc die-cast		Zinc die-cast	
External cable diameter	5 mm ... 9 mm		5 mm ... 9 mm		5 mm ... 9 mm		5 mm ... 9 mm	
Insertion/withdrawal cycles	≥ 750		≥ 750		≥ 750		≥ 750	
Temperature data								
Ambient temperature (operation)	-20°C ... 70°C		-20°C ... 70°C		-20°C ... 70°C		-20°C ... 70°C	
	Ordering data				Ordering data			
	Order No.	Pcs. / Pkt.	Order No.	Pcs. / Pkt.	Order No.	Pcs. / Pkt.	Order No.	Pcs. / Pkt.
Description	Ethernet printing		PROFINET printing		Ethernet printing		PROFINET printing	
<b>RJ45 industrial connector, 8-pos.</b>	1406333	1	1406334	1	1406336	1	1406337	1
Value pack	1406351	30	1406352	30	1406354	30	1406355	30
	Accessories				Accessories			
<b>Stripping tool</b> , for multiple-stage repositioning of shielded conductors	VS-CABLE-STRIP-VARIO	1657407	1		VS-CABLE-STRIP-VARIO	1657407	1	
<b>Electronic diagonal cutter</b> , tapered head, without chamfer, with opening spring, non-reflective phosphate-treated surface, punched version	MICROFOX-SP-1	1212487	1		MICROFOX-SP-1	1212487	1	
<b>Markers for terminal blocks, roll</b> , unmarked, can be marked with: THERMOMARK ROLL, THERMOMARK X, THERMOMARK S1.1	TMT 5 R	0816430	1		TMT 5 R	0816430	1	
White	TMT 5 R RD	0816427	1		TMT 5 R RD	0816427	1	
Red	TMT 5 R GN	0816401	1		TMT 5 R GN	0816401	1	
Green								
<b>Marker for terminal blocks, sheet</b> , white, unmarked, can be marked with: BLUEMARK CLED, BLUEMARK LED, plotter	UC-TMF 5	0818153	10		UC-TMF 5	0818153	10	

RJ45 industrial connectors, IP20



RJ45 industrial, cable outlet at the bottom

	Technical data			
	Ethernet printing	PROFINET printing		
Degree of protection	IP20	IP20		
Connection cross section AWG	26 ... 24	23 ... 22		
Transmission speed	10 Gbps	1 Gbps		
Housing material	Zinc die-cast	Zinc die-cast		
External cable diameter	5 mm ... 9 mm	5 mm ... 9 mm		
Insertion/withdrawal cycles	≥ 750	≥ 750		
Temperature data				
Ambient temperature (operation)	-20°C ... 70°C	-20°C ... 70°C		
Ordering data				
Description	Order No.	Pcs. / Pkt.	Order No.	Pcs. / Pkt.
	Ethernet printing		PROFINET printing	
<b>RJ45 industrial connector, 8-pos.</b>	1406339	1	1406340	1
Value pack	1406357	30	1406358	30
Accessories				
<b>Stripping tool</b> , for multiple-stage repositioning of shielded conductors	<b>VS-CABLE-STRIP-VARIO</b>	1657407	1	
<b>Electronic diagonal cutter</b> , tapered head, without chamfer, with opening spring, non-reflective phosphate-treated surface, punched version	<b>MICROFOX-SP-1</b>	1212487	1	
<b>Markers for terminal blocks, roll</b> , unmarked, can be marked with: THERMOMARK ROLL, THERMOMARK X, THERMOMARK S1.1	<b>TMT 5 R</b>	0816430	1	
White	<b>TMT 5 R RD</b>	0816427	1	
Red	<b>TMT 5 R GN</b>	0816401	1	
Green				
<b>Marker for terminal blocks, sheet</b> , white, unmarked, can be marked with: BLUEMARK CLED, BLUEMARK LED, plotter	<b>UC-TMF 5</b>	0818153	10	

# Connection technology for field devices

## Data connectors – RJ45 connectors

### Push-pull industrial connectors, version 14

- High resistance to ESD and EMI for reliable transmission
- Easy handling, thanks to one-piece design
- Locking system to prevent unintentional removal
- Consistent 360° shielding concept



Push-pull Advance, straight cable outlet



Push-pull Advance, cable outlet at the top

	Technical data		Technical data			
	Ethernet printing	PROFINET printing	Ethernet printing	PROFINET printing		
Degree of protection	IP65/67	IP65/67	IP65/67	IP65/67		
Connection cross section AWG	26 ... 24	23 ... 22	26 ... 24	23 ... 22		
Transmission speed	10 Gbps	1 Gbps	10 Gbps	1 Gbps		
Housing material	Zinc die-cast	Zinc die-cast	Zinc die-cast	Zinc die-cast		
External cable diameter	5.5 mm ... 10 mm	5.5 mm ... 10 mm	5.5 mm ... 10 mm	5.5 mm ... 10 mm		
Insertion/withdrawal cycles	≥ 750	≥ 750	≥ 750	≥ 750		
Temperature data						
Ambient temperature (operation)	-40°C ... 70°C	-40°C ... 70°C	-40°C ... 70°C	-40°C ... 70°C		
	Ordering data					
	Order No.	Pcs. / Pkt.	Order No.	Pcs. / Pkt.		
Description	Ethernet printing		PROFINET printing			
Value pack	1407890	1	1407889	1		
	1467901	10	1408039	10		
Description	Ethernet printing		PROFINET printing			
Value pack	1468007	1	1408027	1		
	1467807	10	1408092	10		
	Accessories		Accessories			
	VS-CABLE-STRIP-VARIO	1657407	1	VS-CABLE-STRIP-VARIO	1657407	1
Stripping tool, for multiple-stage repositioning of shielded conductors						
Electronic diagonal cutter, tapered head, without chamfer, with opening spring, non-reflective phosphate-treated surface, punched version	MICROFOX-SP-1	1212487	1	MICROFOX-SP-1	1212487	1



**Push-pull industrial connectors,  
version 14**



**Push-pull Advance,  
cable outlet at the bottom**

Degree of protection	
Connection cross section AWG	
Transmission speed	
Housing material	
External cable diameter	
Insertion/withdrawal cycles	
Temperature data	
Ambient temperature (operation)	

Technical data		
	Ethernet printing	PROFINET printing
Degree of protection	IP65/67	IP65/67
Connection cross section AWG	26 ... 24	23 ... 22
Transmission speed	10 Gbps	1 Gbps
Housing material	Zinc die-cast	Zinc die-cast
External cable diameter	5.5 mm ... 10 mm	5.5 mm ... 10 mm
Insertion/withdrawal cycles	≥ 750	≥ 750
Ambient temperature (operation)	-40°C ... 70°C	-40°C ... 70°C

Description	
Value pack	

Ordering data			
Order No.	Pcs. / Pkt.	Order No.	Pcs. / Pkt.
Ethernet printing		PROFINET printing	
1408011	1	1407895	1
1467804	10	1408046	10

Stripping tool, for multiple-stage repositioning of shielded conductors	
Electronic diagonal cutter, tapered head, without chamfer, with opening spring, non-reflective phosphate-treated surface, punched version	

Accessories		
Accessories	Order No.	Pcs. / Pkt.
VS-CABLE-STRIP-VARIO	1657407	1
MICROFOX-SP-1	1212487	1

# Connection technology for field devices

## Data connectors – fiber optic connectors

### Push-pull industrial connectors, version 14

- Available for POF, PCF, and GOF
- Easy handling, thanks to one-piece design
- Locking system to prevent unintentional removal



Push-pull Advance, straight cable outlet



Push-pull Advance, cable outlet at the top

	Technical data			Technical data		
	POF (Polymer Optical Fiber)	PCF (Polymer Cladded Fiber)	GOF (Glass Optical Fiber)	POF (Polymer Optical Fiber)	PCF (Polymer Cladded Fiber)	GOF (Glass Optical Fiber)
Degree of protection	IP65/67	IP65/67	IP65/67	IP65/67	IP65/67	IP65/67
Housing material	Zinc die-cast	Zinc die-cast	Zinc die-cast	Zinc die-cast	Zinc die-cast	Zinc die-cast
External cable diameter	5.5 mm ... 10 mm	5.5 mm ... 10 mm	5.5 mm ... 10 mm	5.5 mm ... 10 mm	5.5 mm ... 10 mm	5.5 mm ... 10 mm
Insertion/withdrawal cycles	≥ 750	≥ 750	≥ 750	≥ 750	≥ 750	≥ 750
Temperature data						
Ambient temperature (operation)	-40°C ... 70°C	-40°C ... 70°C	-40°C ... 70°C	-40°C ... 70°C	-40°C ... 70°C	-40°C ... 70°C
	Ordering data			Ordering data		
	Order No.	Pcs. / Pkt.	Order No.	Pcs. / Pkt.	Order No.	Pcs. / Pkt.
Description	POF (Polymer Optical Fiber)	PCF (Polymer Cladded Fiber)	GOF (Glass Optical Fiber)	POF (Polymer Optical Fiber)	PCF (Polymer Cladded Fiber)	GOF (Glass Optical Fiber)
	<b>Push-pull Advance, SC-RJ connector</b>					
Value pack	1407896 1	1407897 1	1407898 1	1408028 1	1408029 1	1408030 1
	1408047 10	1408048 10	1408049 10	1408093 10	1408094 10	1408095 10
	Accessories			Accessories		
SC-RJ cutting tool set, for polymer fiber (POF), for field assembly of connectors	TF-SCRJ-POF KONF SET	1405246	1	TF-SCRJ-POF KONF SET	1405246	1
Tool set for PCF	On request			On request		
Tool set for GOF	On request			On request		

**Push-pull industrial connectors,  
version 14**



**Push-pull Advance,  
cable outlet at the bottom**

Technical data						
	POF (Polymer Optical Fiber)	PCF (Polymer Cladded Fiber)	GOF (Glass Optical Fiber)			
Degree of protection	IP65/67	IP65/67	IP65/67			
Housing material	Zinc die-cast	Zinc die-cast	Zinc die-cast			
External cable diameter	5.5 mm ... 10 mm	5.5 mm ... 10 mm	5.5 mm ... 10 mm			
Insertion/withdrawal cycles	≥ 750	≥ 750	≥ 750			
Temperature data						
Ambient temperature (operation)	-40°C ... 70°C	-40°C ... 70°C	-40°C ... 70°C			
Ordering data						
Description	Order No.	Pcs. / Pkt.	Order No.	Pcs. / Pkt.	Order No.	Pcs. / Pkt.
	POF (Polymer Optical Fiber)		PCF (Polymer Cladded Fiber)		GOF (Glass Optical Fiber)	
<b>Push-pull Advance, SC-RJ connector</b>	<b>1407902</b>	<b>1</b>	<b>1407904</b>	<b>1</b>	<b>1407905</b>	<b>1</b>
Value pack	<b>1408053</b>	<b>10</b>	<b>1408055</b>	<b>10</b>	<b>1408056</b>	<b>10</b>
Accessories						
<b>SC-RJ cutting tool set, for polymer fiber (POF), for field assembly of connectors</b>	<b>TF-SCRJ-POF KONF SET</b>		<b>1405246</b>	<b>1</b>		
<b>Tool set for PCF</b>	On request					
<b>Tool set for GOF</b>	On request					

# Connection technology for field devices

## Data connector – patch panel, terminal outlet

### Modular distribution panel

- 19" distribution field with space for 8 modules, with a total of 48 x RJ45
- Front release without special tool
- Plug and Play – thanks to pre-assembled modules
- Up to 10 Gbps (Class E<sub>A</sub>)
- Cable length according to customer requirements
- Optimized strain relief for every module
- GHMT certification



Assembled modules for 19" mounting frames



19" mounting frame

	Technical data			Technical data		
Electrical data						
Transmission speed	10 Gbps			-		
Transmission characteristics (category)	Class E <sub>A</sub>			-		
Material data						
Housing material	High-grade steel			Steel, powder-coated		
Inflammability class according to UL 94	V0			V0		
Connection data						
External cable diameter	18 mm			-		
Insertion/withdrawal cycles	≥ 750			-		
Temperature data						
Ambient temperature (operation)	-20°C ... 60°C			-20°C ... 60°C		
	Ordering data			Ordering data		
Description	Type	Order No.	Pcs. / Pkt.	Type	Order No.	Pcs. / Pkt.
<b>19" frame, empty, for using 8 modules (RJ45)</b>						
Gray (similar to RAL 7035) Black (similar to RAL 9005)				<b>CUC-PP-FRAME-19</b> <b>CUC-PP-FRAME-19 BK</b>	<b>1407986</b> <b>1409140</b>	<b>1</b> <b>1</b>
<b>Module, RJ45 to RJ45</b> , consisting of two housings each with 6 x RJ45 10 Gbps (Class E <sub>A</sub> ) pre-assembled with multi-cable, variable length, GHMT-certified.	<b>CUC-PP-MODUL-RJ45:6-RJ45:6/...</b>	<b>1407995</b>	<b>1</b>			
<b>Patch bay, 19"</b> , for orderly cabling in the control cabinet						
Gray, with plastic hooks Gray, with metal hooks Black, with metal hooks				<b>CUC-PP-PATCHBAY</b> <b>CUC-PP-PATCHBAY-MH</b> <b>CUC-PP-PATCHBAY-MH BK</b>	<b>1407994</b> <b>1409283</b> <b>1409284</b>	<b>1</b> <b>1</b> <b>1</b>
<b>Dummy frame, size of one module, for use in the frame</b>	<b>CUC-PP-MODUL-COVER</b>	<b>1407988</b>	<b>1</b>			

### Ordering example for modules of variable length:

For an RJ45 module with a cable length of 25.0 m, the ordering data is as follows:

Order No.	Length [m]
1407995	25
	Max. 80 m
	Increment: 1.5 m ... 80 m = 0.5 m



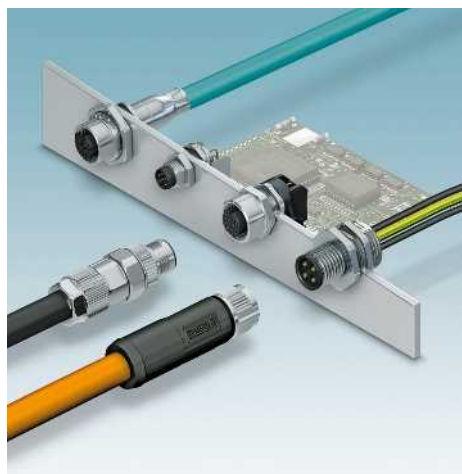
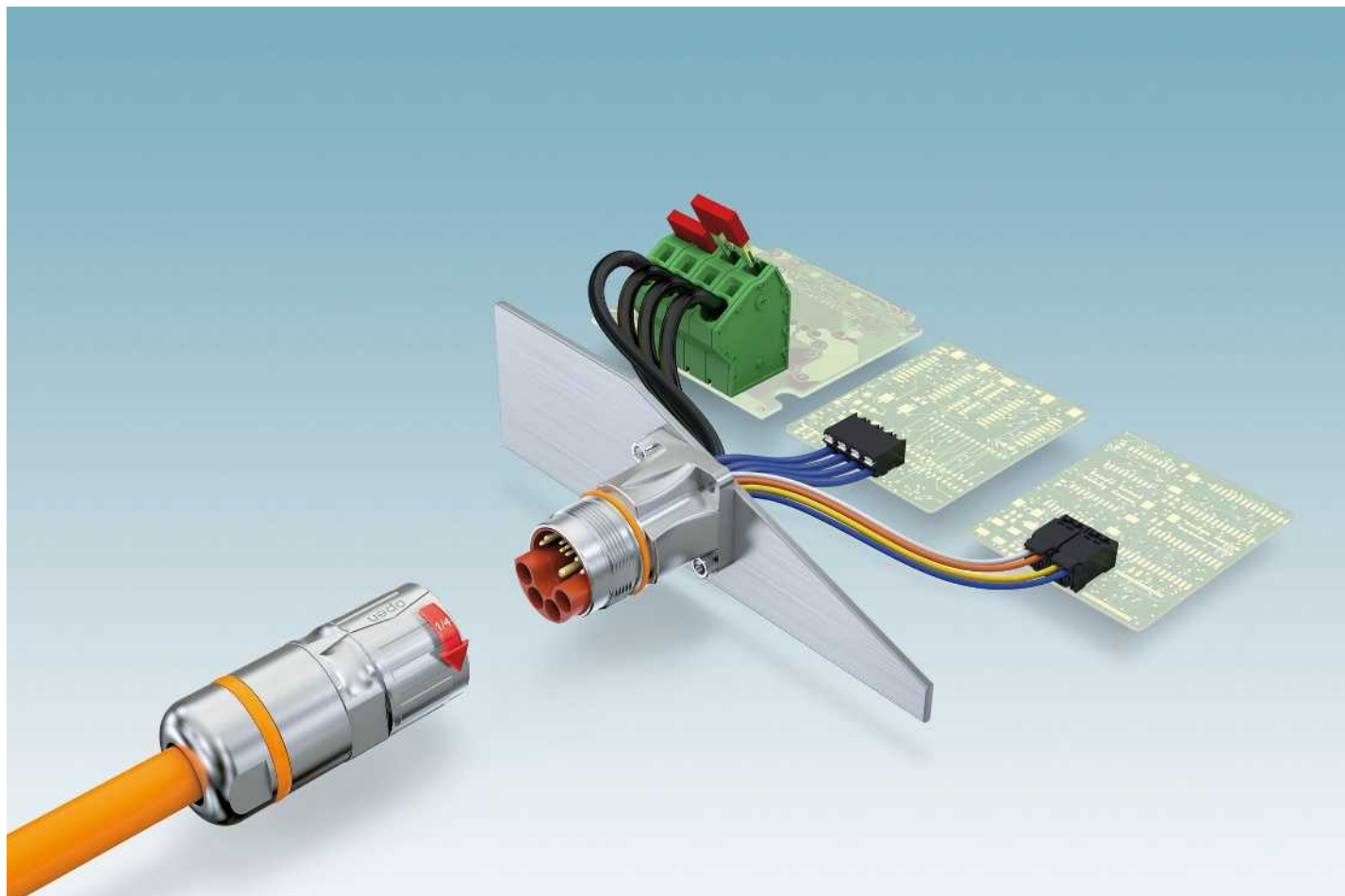

### M5 to M12 circular connectors

Circular connectors for signals, data, and power.

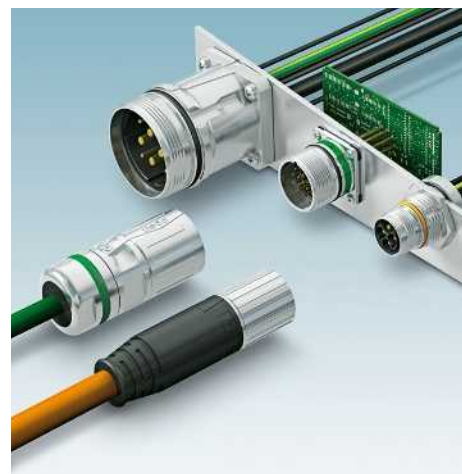

### M17 to M58 circular connectors

Circular connectors for signals, data, and power.



**M12 rear mounting XL**

The new device connectors for rear mounting feature an optimized housing contour with additional tightening limitation. This simplifies the housing cutout on the device and protects the O-ring during mounting.



**M12 front mounting XL**

The wrench flat on the new device connectors for front mounting has been enlarged and now features additional tightening limitation. This simplifies the device cutout and increases security and tightness when mounting.



**M12 power front/rear mounting XL**

The M12 XL housing design has also been introduced for the M12 power device connectors with S- and T-coding. This addition means that there is now a consistent design available for the M12 device connectors for signal and power.



**M12 power for 230 V/16 A**

The M12 power series has been extended with the 2+PE (S-coded) pin assignment. The M12 design means that a compact mains voltage plug is now available for 230 V and up to 16 A.



**M23 hybrid cable and coupler connector**

Special hybrid lines allow signals, data, and power to be transmitted using just one connector.



**M23 hybrid device connectors**

Angled, rotatable, and straight housing versions are available for front mounting on the device side.

# Connection technology for field devices

## M5 to M12 circular connectors

### M12 device connectors XL, rear mounting

- M16 fastening thread
- With 0.5 m long litz wires
- Tightening limitation
- Wrench size 19



4-, 5-, 8-pos.



12-, 17-pos.

	Technical data			Technical data							
	4-pos.	5-pos.	8-pos.	12-pos.	17-pos.						
General data											
M12 circular connector according to:	IEC 61076-2-101	IEC 61076-2-101	IEC 61076-2-101	IEC 61076-2-101	IEC 61076-2-101	-					
Pollution degree	3	3	3	3	3	-					
Degree of protection	IP67	IP67	IP67	IP67	IP67	-					
Connection method	Individual wires	Individual wires	Individual wires	Individual wires	Individual wires	-					
Electrical data											
Rated voltage	250 V	60 V	30 V	30 V	30 V	-					
Rated current	4 A	4 A	2 A	1.5 A	1.5 A	-					
Contact resistance	≤ 3 mΩ	≤ 3 mΩ	≤ 3 mΩ	≤ 3 mΩ	≤ 3 mΩ	-					
Material data											
Material contact/contact surface	CuZn/Au	CuZn/Au	CuZn/Au	CuZn/Au	CuZn/Au	-/-					
Contact carrier material	PA 66	PA 66	PA 66	PA 66	PA 66	-					
Inflammability class according to UL 94	V0	V0	V0	V0	V0	-					
Cable type	TPE litz wire	TPE litz wire	TPE litz wire	TPE litz wire	TPE litz wire	-					
Temperature data											
Plug/socket	-25 ... 85	-25 ... 85	-25 ... 85	-25 ... 85	-25 ... 85	-					
	Ordering data			Ordering data							
Description	Coding	Order No.	Pcs. / Pkt.	Order No.	Pcs. / Pkt.	Order No.	Pcs. / Pkt.	Order No.	Pcs. / Pkt.	Order No.	Pcs. / Pkt.
		4-pos.	5-pos.	8-pos.	12-pos.	17-pos.					
<b>Device connectors</b>											
Socket	A - standard	1411584	1	1411586	1	1411588	1	1411589	1	1411590	1
Plug	A - standard	1411591	1	1411593	1	1411595	1	1411596	1	1411597	1
Socket	D - data	1411585	1								
Plug	D - data	1411592	1								
Socket	B - inverse			1411587	1						
Plug	B - inverse			1411594	1						

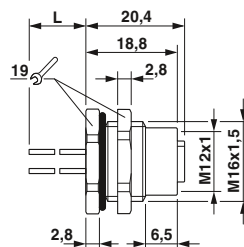

Dimensions: socket

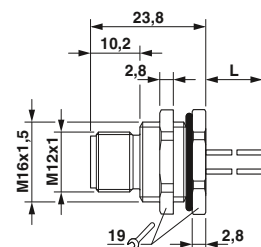

Dimensions: plug



**M12 device connectors XL, front mounting**

- M16 fastening thread
- With 0.5 m long litz wires
- Tightening limitation
- Wrench size 19



4-, 5-, 8-pos.



12-, 17-pos.

	Technical data			Technical data							
	4-pos.	5-pos.	8-pos.	12-pos.	17-pos.						
General data											
M12 circular connector according to:	IEC 61076-2-101	IEC 61076-2-101	IEC 61076-2-101	IEC 61076-2-101	IEC 61076-2-101	-					
Pollution degree	3	3	3	3	3	-					
Degree of protection	IP67	IP67	IP67	IP67	IP67	-					
Connection method	Individual wires	Individual wires	Individual wires	Individual wires	Individual wires	-					
Electrical data											
Rated voltage	250 V	60 V	30 V	30 V	30 V	-					
Rated current	4 A	4 A	2 A	1.5 A	1.5 A	-					
Contact resistance	≤ 3 mΩ	≤ 3 mΩ	≤ 3 mΩ	≤ 3 mΩ	≤ 3 mΩ	-					
Material data											
Material contact/contact surface	CuZn/Au	CuZn/Au	CuZn/Au	CuZn/Au	CuZn/Au	-/-					
Contact carrier material	PA 66	PA 66	PA 66	PA 66	PA 66	-					
Inflammability class according to UL 94	V0	V0	V0	V0	V0	-					
Cable type	TPE litz wire	TPE litz wire	TPE litz wire	TPE litz wire	TPE litz wire	-					
Temperature data											
Plug/socket	-25 ... 85	-25 ... 85	-25 ... 85	-25 ... 85	-25 ... 85	-					
Description	Coding	Ordering data			Ordering data						
		Order No.	Pcs. / Pkt.	Order No.	Pcs. / Pkt.	Order No.	Pcs. / Pkt.				
<b>Device connectors</b>		<b>4-pos.</b>		<b>5-pos.</b>		<b>8-pos.</b>		<b>12-pos.</b>		<b>17-pos.</b>	
Socket	A - standard	1411568	1	1411571	1	1411573	1	1411574	1	1411576	1
Plug	A - standard	1411577	1	1411579	1	1411581	1	1411582	1	1411583	1
Socket	D - data	1411569	1								
Plug	D - data	1411578	1								
Socket	B - inverse			1411572	1						
Plug	B - inverse			1411580	1						

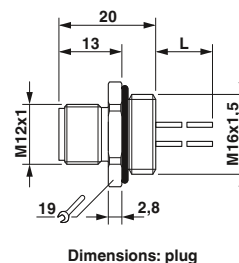
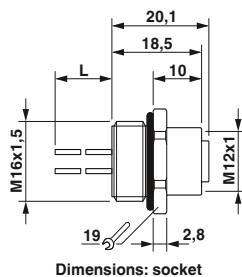

# Connection technology for field devices

## M5 to M12 circular connectors

### M12 power device connectors XL, rear mounting

- M16 fastening thread
- With 0.5 m long litz wires
- Tightening limitation
- Wrench size 19



S-coded, 3-pos. + PE



T-coded, 4-pos.

	Technical data	Technical data
General data		
Pollution degree	3	3
Degree of protection	IP67	IP67
Connection method	Individual wires	Individual wires
Electrical data		
Rated voltage	630 V	60 V
Rated current	12 A	12 A
Contact resistance	≤ 3 mΩ	≤ 3 mΩ
Material data		
Material contact/contact surface	CuZn/Au	CuZn/Au
Contact carrier material	PA	PA
Inflammability class according to UL 94	V0	V0
Cable type	PP litz wire	PP litz wire
Temperature data		
Plug/socket	-25 ... 85 [°C]	-25 ... 85
	Ordering data	Ordering data
Description		
<b>Power device connectors</b>		
Socket	<b>SACC-DSI-M12FSS-4P-M16XL/0,5PE</b>	<b>SACC-DSI-M12FST-4P-M16XL/0,5</b>
Plug	<b>SACC-DSI-M12MSS-4P-M16XL/0,5PE</b>	<b>SACC-DSI-M12MST-4P-M16XL/0,5</b>
	<b>Order No.</b>	<b>Order No.</b>
	1411598	1411599
	1411603	1411604
	<b>Pcs. / Pkt.</b>	<b>Pcs. / Pkt.</b>
	1	1
	1	1

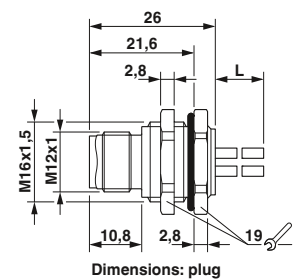
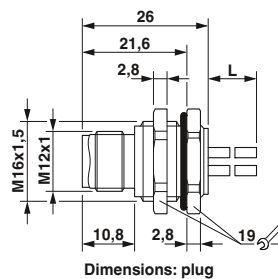
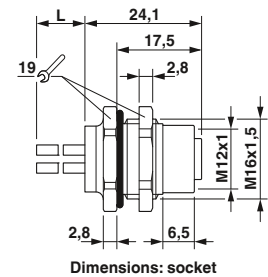
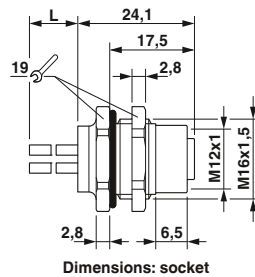

**M12 power device connectors XL, front mounting**

- M16 fastening thread
- With 0.5 m long litz wires
- Tightening limitation
- Wrench size 19



S-coded, 3-pos. + PE



T-coded, 4-pos.

	Technical data	Technical data				
General data						
Pollution degree	3	3				
Degree of protection	IP67	IP67				
Connection method	Individual wires	Individual wires				
Electrical data						
Rated voltage	630 V	60 V				
Rated current	12 A	12 A				
Contact resistance	≤ 3 mΩ	≤ 3 mΩ				
Material data						
Material contact/contact surface	CuZn/Au	CuZn/Au				
Contact carrier material	PA	PA				
Inflammability class according to UL 94	V0	V0				
Cable type	PP litz wire	PP litz wire				
Temperature data						
Plug/socket	-25 ... 85 [°C]	-25 ... 85				
	Ordering data	Ordering data				
Description	Type	Order No.	Pcs. / Pkt.	Type	Order No.	Pcs. / Pkt.
<b>Power device connectors</b>						
Socket	SACC-E-M12FSS-4P-M16XL/0,5 PE	1411605	1	SACC-E-M12FST-4P-M16XL/0,5	1411606	1
Plug	SACC-E-M12MSS-4P-M16XL/0,5 PE	1411607	1	SACC-E-M12MST-4P-M16XL/0,5	1411608	1

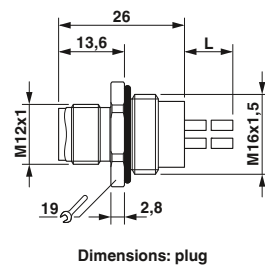
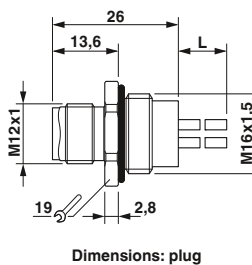
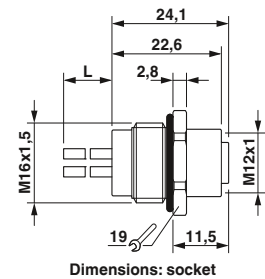
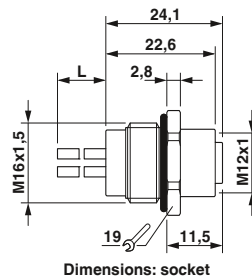

# Connection technology for field devices

## M5 to M12 circular connectors

### M12 power device connectors, 2-pos. + PE

- M16 fastening thread
- With 0.5 m long litz wires
- S-coded



Rear mounting



Front mounting

		Technical data			Technical data		
General data							
Pollution degree		3			3		
Degree of protection		IP67			IP67		
Connection method		Individual wires			Individual wires		
Electrical data							
Rated voltage		630 V			630 V		
Rated current		16 A			16 A		
Contact resistance		≤ 3 mΩ			≤ 3 mΩ		
Material data							
Material contact/contact surface		CuZn/Au			CuZn/Au		
Contact carrier material		PA			PA		
Inflammability class according to UL 94		V0			V0		
Cable type		PP litz wire			PP litz wire		
Temperature data							
Plug/socket		[-25 ... 105 °C]			[-25 ... 105 °C]		
		Ordering data			Ordering data		
Description	Coding	Type	Order No.	Pcs. / Pkt.	Type	Order No.	Pcs. / Pkt.
<b>Power device connectors</b>							
Socket	S power	SACC-DSI-M12FSS-3P-M16/0,5 PE	1411652	1	SACC-E-M12FSS-3P-M16/0,5 PE	1411654	1
Plug	S power	SACC-DSI-M12MSS-3P-M16/0,5 PE	1411653	1	SACC-E-M12MSS-3P-M16/0,5 PE	1411655	1

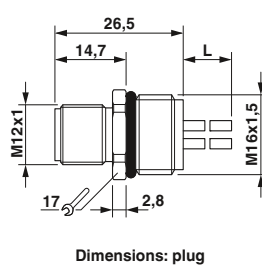
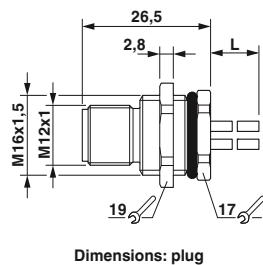
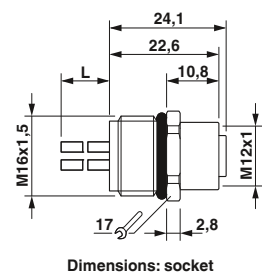
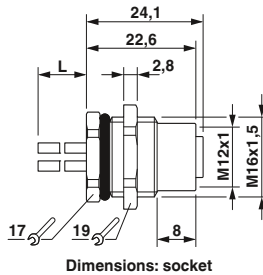



### Mechanical and electrical data

#### Mechanical data

Housing material:	Copper zinc alloy (CuZn), die-cast zinc (GD-Zn)
Housing surface:	Nickel-plated/thick layer passivated (can be coated)
Insulating body:	Polyamide (PA 66)
Contact material:	Copper zinc alloy (CuZn)
Contact surface:	Nickel-plated (Ni) with gold coating (Au)
Contact connection method:	Crimp version
Sealing and O-ring:	Fluorocarbon rubber (FKM)
Ambient temperature:	-40°C ... 130°C
Cable entry:	Cable and coupler connectors for outer cable diameter of 7.5 - 18 mm, shielded
Type of locking:	M23 SPEEDCON screw locking
Mech. insertion/withdrawal cycles:	Standard: 100
Protection class:	IP67 in the locked state

#### Electrical data

No. of positions	13 (4+4+4+PE), CAT5				13 (8+4+PE)							
Contacts	4	+	4	+	4	+	PE	8	+	4	+	PE
Contact Ø [mm]	0.8		1.0		2.0		2.0	1.0		2.0		2.0
<b>Litz wire cross sections</b>												
Cable and coupler connectors:												
Max. cable Ø of 18 mm	[mm <sup>2</sup> ]	0.08 ... 0.5	0.06 ... 1.0	0.25 ... 4.0	0.25 ... 4.0	0.06 ... 1.0	0.25 ... 4.0	0.25 ... 4.0				
Device connector:	[mm <sup>2</sup> ]	0.08 ... 0.5	0.06 ... 1.0	0.25 ... 4.0	0.25 ... 4.0	0.06 ... 1.0	0.25 ... 4.0	0.25 ... 4.0				
Nominal current per contact at 25°C <sup>1)</sup>												
		3.6	8	30	-	8	30	-				
<b>Specifications according to DIN EN 61984:2009</b>												
Rated voltage	[V AC/DC]	50	50	630/850	-	50	630/850	-				
Test/surge voltage	[kV AC]	1.5	1.5	6	-	1.5	6	-				
Surge voltage category												
III												
Pollution degree <sup>2)</sup>												
3												
Installation height												
Up to 3000												
Cable clamping area <sup>3)</sup> Max. Ø [mm]												
18												

<sup>1)</sup> The effective current carrying capacity must be determined using a derating curve, if necessary, according to the application.

<sup>2)</sup> The values specified assume that the connector pair is correctly locked and is only disconnected for testing and maintenance purposes. If the connector is unlocked and exposed to ambient conditions, and if there is a danger of contamination, the connector must be sealed using a protective cap ≥ IP54.

<sup>3)</sup> The cable clamping areas specified on the following pages may vary depending on the cable material/structure. Selection and testing is the responsibility of the user.

Contact chamber numbering (view of plug-in side)				
No. of positions	Pin		Socket	
13-pos., CAT5 (4 + 4 + 4 + PE) Crimp				
13-pos. (8 + 4 + PE) Crimp				

# Connection technology for field devices

## M17 to M58 circular connectors

### M23 cable connector, hybrid, SPEEDCON fast locking system

- 4 x power + PE, 4 x signal, 4 x data
- 4 x power + PE, 8 x signal



Cable connector, socket assembly



Cable connector, pin assembly

Description		Ordering data		Ordering data					
		Order No.	Pcs. / Pkt.	Order No.	Pcs. / Pkt.	Order No.	Pcs. / Pkt.		
	Cable clamping area	4 x signal + CAT5		8 x signal		4 x signal + CAT5		8 x signal	
<b>Cable connector</b> , with contact carrier, <b>without</b> contacts, crimp connection									
Universal gasket	7.5 mm ... 18 mm	1621517	1	1621524	1	1621529	1	1621534	1
	7.5 mm ... 9 mm	1621520	1	1621525	1	1621530	1	1621535	1
	9 mm ... 12 mm	1621521	1	1621526	1	1621531	1	1621536	1
	12 mm ... 15 mm	1621522	1	1621527	1	1621532	1	1621537	1
	15 mm ... 18 mm	1621523	1	1621528	1	1621533	1	1621538	1
Accessories		Accessories		Accessories					
		Crimp contacts Color rings, 50 pcs. in set (to be ordered separately)		See page 66 See Catalog 2, page 367		See page 66 See Catalog 2, page 367			

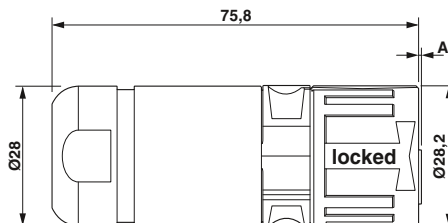

Pin version: dimension A = 0.2 mm,  
socket version: dimension A = 0 mm



**M23 coupler connector, hybrid**

- 4 x power + PE, 4 x signal, 4 x data
- 4 x power + PE, 8 x signal



**Coupler connector,  
socket assembly**



**Coupler connector,  
pin assembly**

		Ordering data				Ordering data			
Description	Cable clamping area	Order No.	Pcs. / Pkt.	Order No.	Pcs. / Pkt.	Order No.	Pcs. / Pkt.	Order No.	Pcs. / Pkt.
		4 x signal + CAT5		8 x signal		4 x signal + CAT5		8 x signal	
<b>Coupler connector</b> , with contact carrier, <b>without</b> contacts, crimp connection									
Universal gasket	7.5 mm ... 18 mm	1621539	1	1621544	1	1621549	1	1621554	1
	7.5 mm ... 9 mm	1621540	1	1621545	1	1621550	1	1621555	1
	9 mm ... 12 mm	1621541	1	1621546	1	1621551	1	1621556	1
	12 mm ... 15 mm	1621542	1	1621547	1	1621552	1	1621557	1
	15 mm ... 18 mm	1621543	1	1621548	1	1621553	1	1621558	1
		Accessories				Accessories			
<b>Crimp contacts</b>		See page 66				See page 66			
<b>Color rings</b> , 50 pcs. in set (to be ordered separately)		See Catalog 2, page 367				See Catalog 2, page 367			

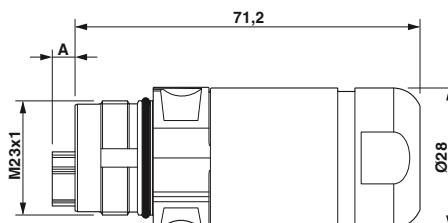

Pin version: dimension A = 4.7 mm,  
socket version: dimension A = 0 mm

# Connection technology for field devices

## M17 to M58 circular connectors

### M23 device connectors, hybrid, straight

- 4 x power + PE, 4 x signal, 4 x data
- 4 x power + PE, 8 x signal



Device connector, straight, socket assembly



Device connector, straight, pin assembly

Description	Ordering data				Ordering data			
	Order No.	Pcs. / Pkt.	Order No.	Pcs. / Pkt.	Order No.	Pcs. / Pkt.	Order No.	Pcs. / Pkt.
Device connector, with contact carrier, without contacts	1621567	1	1621568	1	1621569	1	1621570	1
Flange dimensions: 26 mm x 26 mm								
Crimp contacts Color rings, 50 pcs. in set (to be ordered separately)	See page 66 See Catalog 2, page 367				See page 66 See Catalog 2, page 367			

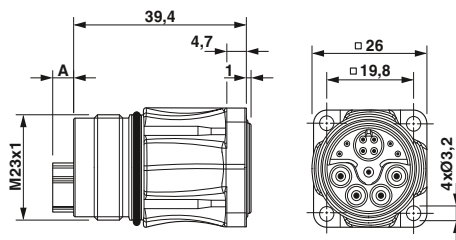

Pin version: dimension A = 4.75 mm,  
socket version: dimension A = 0 mm

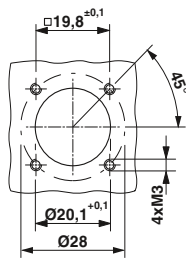

Installation dimensions

**M23 device connector, hybrid, angled, rotatable**

- 4 x power + PE, 4 x signal, 4 x data
- 4 x power + PE, 8 x signal
- Housing can be freely rotated by 310°



Device connector, angled, rotatable, socket assembly



Device connector, angled, rotatable, pin assembly

Ordering data			
Order No.	Pcs. / Pkt.	Order No.	Pcs. / Pkt.
4 x signal + CAT5		8 x signal	
1621563	1	1621564	1
1621559	1	1621560	1
Accessories			
See page 66 See Catalog 2, page 367			

Ordering data			
Order No.	Pcs. / Pkt.	Order No.	Pcs. / Pkt.
4 x signal + CAT5		8 x signal	
1621565	1	1621566	1
1621561	1	1621562	1
Accessories			
See page 66 See Catalog 2, page 367			

Description
Device connector, with contact carrier, <b>without</b> contacts
Flange dimensions: 26 mm x 26 mm
Device connector, with contact carrier, <b>without</b> contacts
Flange dimensions: 28 mm x 28 mm
Crimp contacts
Color rings, 50 pcs. in set (to be ordered separately)

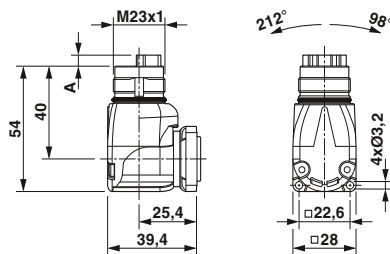

Pin version: dimension A = 4.7 mm, socket version: dimension A = 0 mm

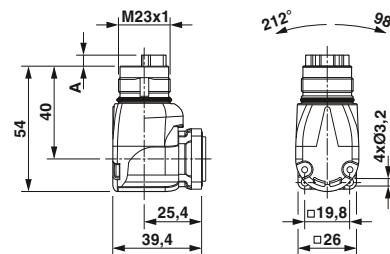

Pin version: dimension A = 4.7 mm, socket version: dimension A = 0 mm

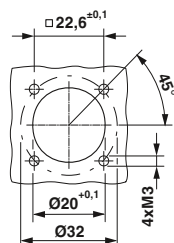

Installation dimensions

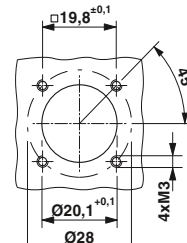

Installation dimensions

### Crimp contacts



**Crimp contacts,  
socket**



**Crimp contacts,  
pin**

Description	Connection cross section [mm <sup>2</sup> ]	Ordering data			Ordering data		
		Type	Order No.	Pcs. / Pkt.	Type	Order No.	Pcs. / Pkt.
<b>Contacts, Ø 0.8 mm</b>	0.08 mm <sup>2</sup> ... 0.25 mm <sup>2</sup>	SF-08KS010	1621571	100	SF-08KP010	1621574	100
	0.34 mm <sup>2</sup> ... 0.5 mm <sup>2</sup>	SF-08KS020	1621573	100	SF-08KP020	1621575	100
<b>Contacts, Ø 1.0 mm</b>	0.06 mm <sup>2</sup> ... 0.25 mm <sup>2</sup>	ST-10KS010	1618239	100	ST-10KP010	1618255	100
	0.34 mm <sup>2</sup> ... 0.5 mm <sup>2</sup>	ST-10KS020	1618251	100	ST-10KP020	1618256	100
	0.5 mm <sup>2</sup> ... 1.0 mm <sup>2</sup>	ST-10KS030	1618254	100	ST-10KP030	1618261	100
<b>Contacts, Ø 2.0 mm</b>	0.25 mm <sup>2</sup> ... 1.0 mm <sup>2</sup>	SF-20KS021	1621576	50	SF-20KP021	1621579	50
	1.0 mm <sup>2</sup> ... 2.5 mm <sup>2</sup>	SF-20KS022	1621577	50	SF-20KP022	1621580	50
	2.5 mm <sup>2</sup> ... 4.0 mm <sup>2</sup>	SF-20KS023	1621578	50	SF-20KP023	1621581	50





Flexibility is required when it comes to the structure of a sustainable power supply system. A combination of various sources of renewable energy – even in conjunction with storage technologies – is already proving cost-effective. What is striking here is that miniaturization is more than just a trend; it is a recognized method of increasing system efficiency.

In photovoltaics, the micro inverter, the little brother of the string inverter, is particularly gaining in popularity. It can even be used cost-effectively in locations that are clearly less than ideal. Double-figure percentage increases in yield in comparison to string inverters mean that even areas that are not ideal can be used cost-effectively.

SUNCLIX micon, the connection system for the AC-side of micro inverters, simplifies installation using components which have proven themselves a million times over.



**AC-Y connectors**

The AC-Y connectors consist of two 3-pos. connections, which are connected to each other via the trunk line without the risk of polarity reversal. In addition to accommodating the trunk line, the coupling side also accommodates the drop line, which serves as a connection to the inverter.



**Mains connector plugs**

The mains connector plugs provide the connecting link between the PV system and mains. Depending on the system structure, the mains can be connected via the plug or coupling side of the AC Y-connector. The free cable end is either connected in a distributor box or fed into an incoming mains feeder box via a cable sleeve.



**Protective caps**

Dust protection caps (brown) made from biodegradable plastic protect the pin connector pattern from contamination during transport. When it comes to installation, they can be easily removed from the plug without any special tools. During installation, the IP protective caps (black) are inserted as an end cap on the last connector in order to protect it from atmospheric influences.



**Contact removal tool**

The locking mechanism on the connector is extremely robust and prevents unintentional release. The contact removal tool enables the lock to be opened easily and quickly. Thanks to an additional latch, it does not fall out of the plug housing once it has been released.

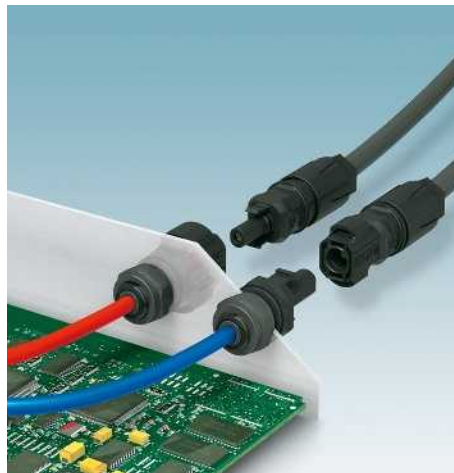

**DC connectors**

With the SUNCLIX DC connector as a device plug or for field assembly, you can also impress with performance and quality on the module side.

# Connection technology for field devices

## Photovoltaic AC connectors

### SUNCLIX micon

- Pre-assembled sets for minimum effort at the installation site
- Customer-specific versions on request
- Networked cables
- Proven SUNCLIX contact technology for optimum system performance



AC Y-distributor



Mains connector plug for the coupling side

	Technical data			Technical data		
	North American version	European version		North American version	European version	
General data						
Degree of protection	IP67	IP67		IP67	IP67	
Electrical data						
Rated voltage	600 V	400 V		600 V	400 V	
Rated current						
	Trunk line	20 A	20 A	20 A	20 A	
	Drop line	5 A	5 A	-	-	
Conductor cross section						
	Trunk line	12 AWG	2.5 mm <sup>2</sup>	12 AWG	2.5 mm <sup>2</sup>	
	Drop line	14 AWG	0.75 mm <sup>2</sup>	-	-	
No. of pos.						
	Trunk line	3	3	3	3	
	Drop line	3	3	-	-	
Cable length						
	Trunk line	1150 mm	1150 mm	1000 mm	1000 mm	
	Drop line	500 mm	500 mm	-	-	
Temperature data						
Ambient temperature (operation)	-40°C ... 90°C		-40°C ... 85°C	-40°C ... 90°C		-40°C ... 85°C
	Ordering data			Ordering data		
Description	Type	Order No.	Pcs. / Pkt.	Type	Order No.	Pcs. / Pkt.
<b>AC Y-distributor</b> for PV microinverters incl. dust protection caps						
North American version	PV-MI-YC-1,15-3-12-NA-0,50-OE	1706518	1			
European version	PV-MI-YC-1,15-3-25-EU-0,50-OE	1621351	1			
<b>Mains connector plug</b> of the AC Y-distributor incl. IP protective cap and contact removal tool						
North American version				PV-MI-YC-GC-P-1,00-3-12-NA SET	1707091	1
European version				PV-MI-YC-GC-P-1,00-3-25-EU SET	1621349	1
<b>Patch cable</b> for extending the trunk line incl. dust protection caps						
North American version						
European version						
	Accessories			Accessories		
<b>Dust protection cap, IP40</b> , for SUNCLIX micon						
Coupling side	PV-MI-YC-CARRIER-CAP-TS	1706599	5	PV-MI-YC-CARRIER-CAP-TS	1706599	5
Plug side	PV-MI-YC-CARRIER-CAP-TP	1706608	5	PV-MI-YC-CARRIER-CAP-TP	1706608	5
<b>Protective cap, IP67</b> , for SUNCLIX micon						
Coupling side	PV-MI-YC-PROTECTION-CAP-TS	1706515	1	PV-MI-YC-PROTECTION-CAP-TS	1706515	1
Plug side	PV-MI-YC-PROTECTION-CAP-TP	1706610	1	PV-MI-YC-PROTECTION-CAP-TP	1706610	1
<b>Contact removal tool</b> , for SUNCLIX micon, trunk line						
	PV-MI-YC-UNLOCKTOOL	1706514	5	PV-MI-YC-UNLOCKTOOL	1706514	5





Mains connector plug  
for the plug side



Patch cable

Technical data	
North American version	European version
IP67	IP67
600 V	400 V
20 A	20 A
-	-
12 AWG	2.5 mm <sup>2</sup>
-	-
3	3
-	-
1000 mm	1000 mm
-	-
-40°C ... 90°C	-40°C ... 85°C

Technical data	
North American version	European version
IP67	IP67
600 V	400 V
20 A	20 A
-	-
12 AWG	2.5 mm <sup>2</sup>
-	-
3	3
-	-
1000 mm	1000 mm
-	-
-40°C ... 90°C	-40°C ... 85°C

Ordering data		
Type	Order No.	Pcs. / Pkt.
PV-MI-YC-GC-S-1,00-3-12-NA SET	1707092	1
PV-MI-YC-GC-S-1,00-3-25-EU SET	1621350	1

Ordering data		
Type	Order No.	Pcs. / Pkt.
PV-MI-YC-PATCH-1,00-3-12-NA	1707090	10
PV-MI-YC-PATCH-1,00-3-25-EU	1621352	10

Accessories		
Type	Order No.	Pcs. / Pkt.
PV-MI-YC-CARRIER-CAP-TS	1706599	5
PV-MI-YC-CARRIER-CAP-TP	1706608	5
PV-MI-YC-PROTECTION-CAP-TS	1706515	1
PV-MI-YC-PROTECTION-CAP-TP	1706610	1
PV-MI-YC-UNLOCKTOOL	1706514	5

Accessories		
Type	Order No.	Pcs. / Pkt.
PV-MI-YC-CARRIER-CAP-TS	1706599	5
PV-MI-YC-CARRIER-CAP-TP	1706608	5
PV-MI-YC-PROTECTION-CAP-TS	1706515	1
PV-MI-YC-PROTECTION-CAP-TP	1706610	1
PV-MI-YC-UNLOCKTOOL	1706514	5

## Photovoltaic AC connectors

### Cable installation

#### Cable splice kit

- Cable-to-cable connection
- IP67 for outdoor applications
- Accepts three conductors, 1.5 mm<sup>2</sup> to 25 mm<sup>2</sup> (16 to 4 AWG)

#### Cable terminator

- End-of-run cable terminator
- IP67 for outdoor applications
- Accepts three conductors, 1.5 mm<sup>2</sup> to 25 mm<sup>2</sup> (16 to 4 AWG)



Cable splice kit



Cable terminator

	Technical data			Technical data		
General data						
Degree of protection	IP67			IP67		
Connection method	Screw connection within housing			-		
Electrical data						
Rated voltage	600 V AC/DC			600 V AC/DC		
Rated current	30 A			-		
Conductor cross section [mm <sup>2</sup> // AWG]	1.5 mm <sup>2</sup> ... 25 mm <sup>2</sup> // 16 ... 4			1.5 mm <sup>2</sup> ... 25 mm <sup>2</sup> // 16 ... 4		
Cable diameter	9.5 mm ... 13 mm (0.37 ... 0.51 in.)			9.5 mm ... 13 mm (0.37 ... 0.51 in.)		
Temperature data						
Ambient temperature (operation)	-40°C ... 90°C			-40°C ... 90°C		
	Ordering data			Ordering data		
Description	Type	Order No.	Pcs. / Pkt.	Type	Order No.	Pcs. / Pkt.
<b>Cable splice kit</b> - 3 conductors	<b>PV-MI-CABLE SPLICE 3P</b>	<b>1812403</b>	<b>1</b>			
<b>Cable terminator</b> - 3 conductors				<b>PV-MI-CABLE TERMINATOR 3P</b>	<b>1812416</b>	<b>1</b>



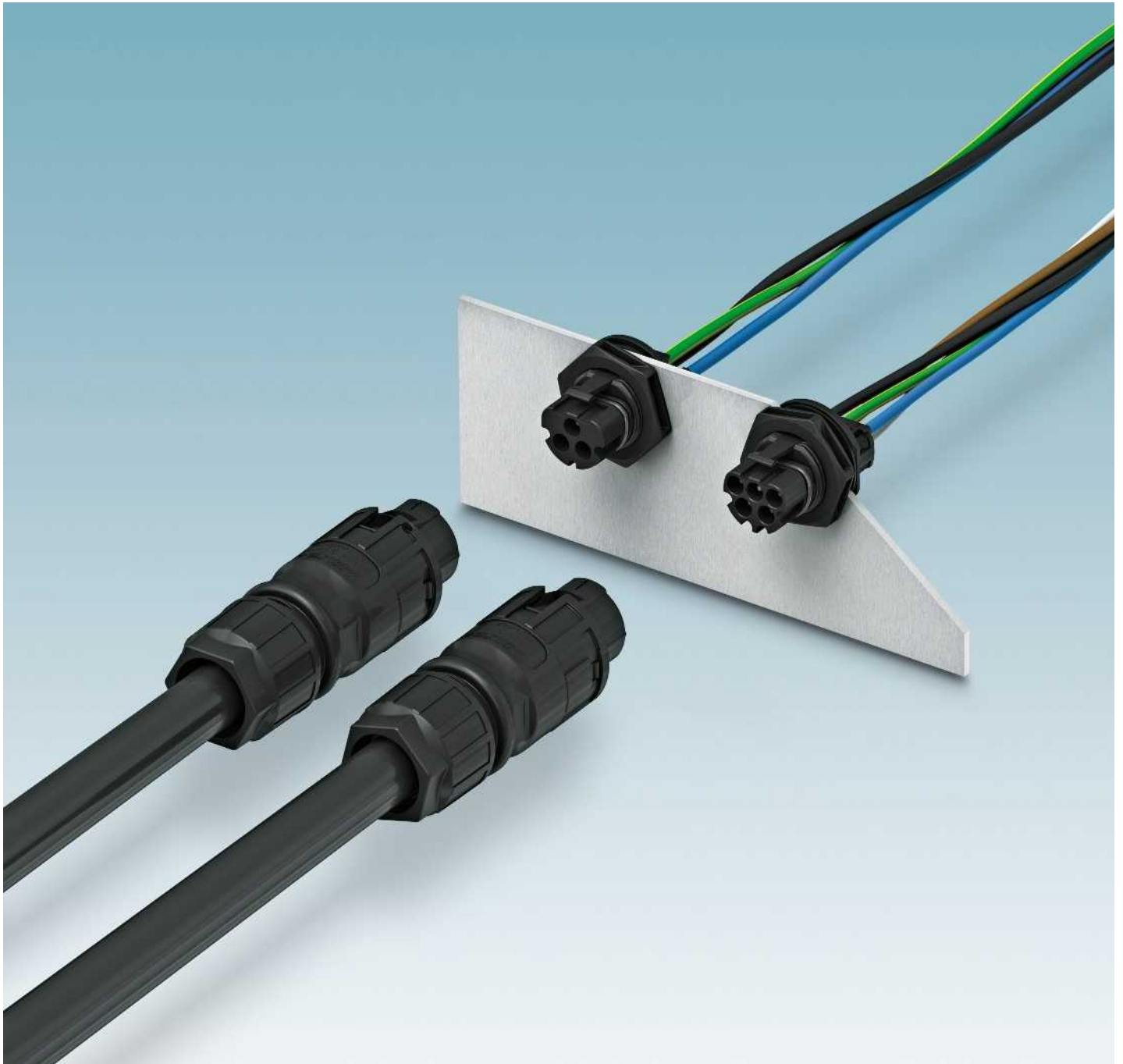

#### **IP-protected circular connectors for power electronics**

The new power connectors in the PRC series enable you to reliably and conveniently connect 3 and 5-wire cables to your device (e.g., a solar inverter). The device connectors with crimp connection are supplied pre-assembled with punched-on litz wires or alternatively they can be self-assembled.



Remove the cable sheath, strip the wires, and conveniently connect with screw connection



Snap the contact carrier into the plug housing



Tighten the cable gland



– Sealable for protection against tampering



– UV-resistant plastic for safe outdoor use



– Secure latching to be disconnected using tool



– Fully flexible for the device manufacturer: Pre-assembled panel feed-through or flexible and rapid self-assembly.



– The mechanical coding ensures that 3- and 5-pos. connectors are not accidentally connected to each other.



– Everything from a single source: Phoenix Contact supplies connectors for all the interfaces on a solar inverter.

# Connection technology for field devices

## Photovoltaic AC connectors

### Cable connectors

- Snaps in automatically when inserted, released using a screwdriver
- Screw connection of 1.5 mm<sup>2</sup> to 6 mm<sup>2</sup>
- With lagging PE contact



3-pos.,  
socket contacts



5-pos.,  
socket contacts

	Technical data			Technical data		
General data						
Degree of protection	IP65/IP68			IP65/IP68		
Conductor cross section	1.5 mm <sup>2</sup> ... 6 mm <sup>2</sup>			1.5 mm <sup>2</sup> ... 6 mm <sup>2</sup>		
Electrical data						
Rated voltage	690 V			690 V		
Rated current	35 A			30 A		
Material data						
Contact surface material	Silver-plated			Silver-plated		
Material of grip body	PPE			PPE		
Inflammability class according to UL 94	V0			V0		
Temperature data						
Ambient temperature (operation)	-40°C ... 100°C (dependent on the derating curve)			-40°C ... 100°C (dependent on the derating curve)		
	Ordering data			Ordering data		
Description	Type	Order No.	Pcs. / Pkt.	Type	Order No.	Pcs. / Pkt.
<b>Cable connector</b> , with screw connection for cable diameter:						
8 mm ... 21 mm	PRC 3-FC-FS6 8-21	1410661	1	PRC 5-FC-FS6 8-21	1410656	1
8 mm ... 12 mm	PRC 3-FC-FS6 8-12	1410658	1	PRC 5-FC-FS6 8-12	1410629	1
12 mm ... 16 mm	PRC 3-FC-FS6 12-16	1409217	1	PRC 5-FC-FS6 12-16	1409205	1
16 mm ... 25 mm	PRC 3-FC-FS6 16-21	1410659	1	PRC 5-FC-FS6 16-21	1410655	1
	Accessories			Accessories		
<b>Protective cap</b>	PRC COVER F	1409236	50	PRC COVER F	1409236	50
<b>Test plug</b> , black, 1.5 mm <sup>2</sup> ... 6 mm <sup>2</sup> with screw connection, for cables with diameter 8 mm ... 21 mm	PRC 3-TC-FS6 8-21	1621326	50	PRC 5-TC-FS6 8-21	1621325	50

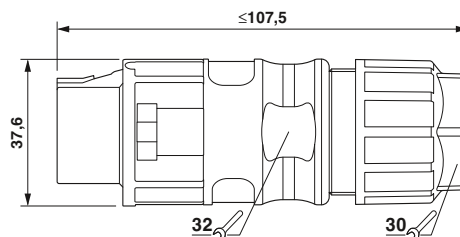
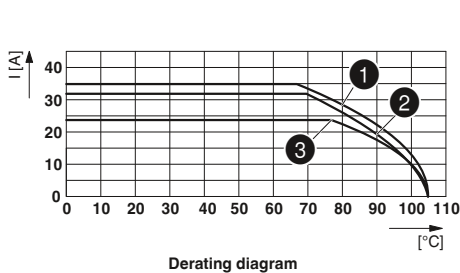

Device connectors

- Snaps in automatically when inserted, released using a screwdriver
- Pre-assembled with litz wires or for self-assembly
- IP65 when not plugged in
- With capacitive PE contact



Pin contacts with litz wires



Pin contact carrier without contacts

General data	
Degree of protection (when plugged in)	
Electrical data	
Rated voltage	
Rated current	
Material data	
Contact surface material	
Material of grip body	
Inflammability class according to UL 94	
Temperature data	
Ambient temperature (operation)	

Technical data			
3-pos.		5-pos.	
IP65/IP68 (2m/24h)			
690 V		690 V	
35 A		30 A	
Silver-plated			
PPE			
V0			
-40°C ... 100°C (dependent on the derating curve)			

Technical data			
3-pos.		5-pos.	
IP65/IP68 (2m/24h)			
690 V		690 V	
35 A		30 A	
Silver-plated			
PPE			
V0			
-40°C ... 100°C (dependent on the derating curve)			

Ordering data	
Description	
M25 device connector incl. locking nut, cable length 150 mm, with conductor cross section:	
2.5 mm <sup>2</sup>	1409219
4 mm <sup>2</sup>	1409220
6 mm <sup>2</sup>	1409221
Contact carrier incl. locking nut, without contacts, for crimp contacts, conductor cross section of 2.5 mm <sup>2</sup> ... 6 mm <sup>2</sup>	
	1409218

Ordering data			
Order No.	Pcs. / Pkt.	Order No.	Pcs. / Pkt.
3-pos.		5-pos.	
1409219	10	1409211	10
1409220	10	1409212	10
1409221	10	1409213	10

Ordering data			
Order No.	Pcs. / Pkt.	Order No.	Pcs. / Pkt.
3-pos.		5-pos.	
1409218	50	1409206	50

Accessories	
Description	
Protective cap	PRC COVER M
Replacement locking nut	FT NUT M25 BK
Crimp contacts CK 2,5, silver-plated contact surface for conductor cross section:	
2.5 mm <sup>2</sup>	CK2,5-M-2,5 AG
4 mm <sup>2</sup>	CK2,5-M-4 AG
6 mm <sup>2</sup>	CK2,5-M-6 AG

Accessories			
Description	Order No.	Pcs. / Pkt.	
Protective cap	1409237	50	
Replacement locking nut	1457937	100	
CK2,5-M-2,5 AG	1409207	100	
CK2,5-M-4 AG	1409208	100	
CK2,5-M-6 AG	1409209	100	

Accessories			
Description	Order No.	Pcs. / Pkt.	
Protective cap	1409237	50	
Replacement locking nut	1457937	100	
CK2,5-M-2,5 AG	1409207	100	
CK2,5-M-4 AG	1409208	100	
CK2,5-M-6 AG	1409209	100	

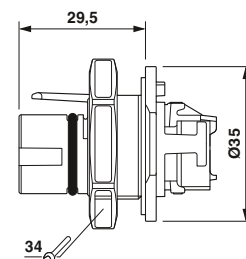
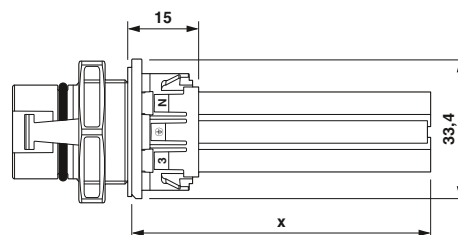
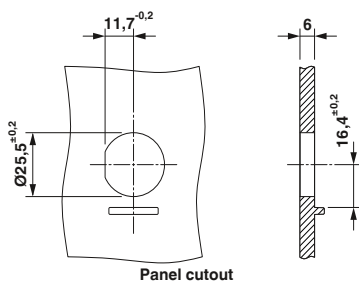



The development of a widespread charging infrastructure in conjunction with renewable energy is an important step toward a mobile future. Internationally standardized charging systems are used to establish an electrical connection between the electric vehicle and the infrastructure (e.g., a charging station). In terms of the charging interfaces required, a distinction is made between:

- Vehicle inlets
- Socket outlets on the charging station
- Charging cables with connectors (charging plug on the vehicle), plugs (charging plug in the infrastructure), and integrated IC-CPD control units.

International standards ensure uniform connection for charging stations and vehicles:

- Type 1 according to SAE J1772 (USA, Japan)
- Type 2 according to IEC-62196 (Europe)
- GB standard (China).

The charging plugs from Phoenix Contact offer reliable, standard-compliant solutions for a consistent charging interface for all applications.

This is implemented, for example, with the Combined Charging System (CCS), which was developed by major German automobile manufacturers in cooperation with Phoenix Contact. The electric vehicle can be charged conventionally with AC at home, for example. In addition, the vehicle-side inlet is also designed for rapid DC charging. Only short stops are required for the charging process - e.g., on the go at rest stops.





**AC type 1**

The type 1 AC charging system is based on standard SAE J1772. It is primarily used in the USA and Japan. The lock is implemented using a lever system.



**AC type 2**

The type 2 AC charging system, developed for Europe, is designed according to the IEC 62196-2 standard. It supports single- and three-phase charging. An electromechanical actuator lock safeguards the charging process.



**AC GB**

The AC charging system standardized according to the Chinese GB standard enables both single- and three-phase charging. Charging takes place securely thanks to a special lever system.



**DC CCS type 1**

In the USA, the type 1 DC CCS charging system is used for fast DC charging, according to SAE J1772 and IEC 62196-3. The lever locking mechanism is also supported by an additional actuator lock.



**DC CCS type 2**

In Europe, the type 2 DC CCS charging system is the vanguard for rapid DC charging according to IEC-62196-3. The electromechanical actuator lock prevents premature removal during the charging process.



**DC GB**

The DC GB charging system is based on the GB standard. It offers rapid DC charging for Chinese charging stations. The lever lock is also supported by an additional actuator lock.

# Connection technology for field devices

## Charging cables for electric vehicles

### Type 1 AC charging cables with open cable end

Type 1 AC charging cables with open cable end are primarily installed in charging stations and wall boxes in the USA and Japan. They are used to charge electric vehicles with alternating current.

Notes:
Further cable types and lengths are available on request.
Color variants for housing and cables are available on request.
Additional charging cables with higher rated currents are available on request.
All connectors are supplied with a protective cap.



Type 1 AC connector, with AWG cable



Type 1 AC connector, with metric cable

	Technical data		Technical data					
	16 A	30 A	20 A	32 A				
Rated current	16 A	30 A	20 A	32 A				
Number of phases	1	1	1	1				
Rated voltage	240 V AC	240 V AC	250 V AC	250 V AC				
Standards	SAE J1772	SAE J1772	SAE J1772	SAE J1772				
Charging mode	AC level 2	AC level 2	Mode 3	Mode 3				
Resistor coding	150 Ω (Lever actuated) 480 Ω (Lever not actuated)	150 Ω (Lever actuated) 480 Ω (Lever not actuated)	150 Ω (Lever actuated) 480 Ω (Lever not actuated)	150 Ω (Lever actuated) 480 Ω (Lever not actuated)				
Ambient temperature (Operation)	-30°C ... 50°C	-30°C ... 50°C	-30°C ... 50°C	-30°C ... 50°C				
Number of power contacts	3 (L1, N, PE)	3 (L1, N, PE)	3 (L1, N, PE)	3 (L1, N, PE)				
Insertion/withdrawal cycles	> 10000	> 10000	> 10000	> 10000				
Insertion/withdrawal force	< 100 N	< 100 N	< 100 N	< 100 N				
Type of protection (when plugged in)	IP44	IP44	IP44	IP44				
Degree of protection (with protective cap)	IP24	IP24	IP24	IP24				
Degree of protection (when not plugged in)	IP20	IP20	IP20	IP20				
<b>Cable data</b>								
Cable type	Straight	Straight	Spiraled	Spiraled				
Cable length	4 m	4 m	4 m	4 m				
Cable diameter	9.4 mm ± 0.2	16.4 mm ± 0.2	10.5 mm ± 0.5	13.9 mm ± 0.5				
Cable structure	3 x 14 AWG + 1 x 18 AWG	3 x 10 AWG + 1 x 18 AWG	3 x 2.5 mm <sup>2</sup> + 1 x 0.5 mm <sup>2</sup>	3 x 6.0 mm <sup>2</sup> + 1 x 0.5 mm <sup>2</sup>				
Sheath color	Black	Black	Black	Black				
<b>Ordering data</b>								
Description	Order No.	Pcs. / Pkt.	Order No.	Pcs. / Pkt.	Order No.	Pcs. / Pkt.	Order No.	Pcs. / Pkt.
	16 A		30 A		20 A		32 A	
AC charging cable with open cable end, mode 3, type 1	1621484	1	1409949	1	1621670	1	1621794	1

**Type 2 AC charging cables with open cable end**

Type 2 AC charging cables with open cable end are installed in charging stations and wall boxes in European infrastructure. They are used to charge electric vehicles with alternating current.

<b>Notes:</b>
Further cable types and lengths are available on request.
Color variants for housing and cables are available on request.
Additional charging cables with higher rated currents are available on request.
All connectors are supplied with a protective cap.



**Type 2 AC connector, 20 A**



**Type 2 AC connector, 32 A**



Rated current	20 A	20 A
Number of phases	1	3
Rated voltage	250 V AC	480 V AC
Standards	IEC 62196-2	IEC 62196-2
Charging mode	Mode 3	Mode 3
Resistor coding	680 Ω (between PE and PP)	680 Ω (between PE and PP)
Ambient temperature (Operation)	-30°C ... 50°C	-30°C ... 50°C
Number of power contacts	3 (L1, N, PE)	5 (L1, L2, L3, N, PE)
Insertion/withdrawal cycles	> 10000	> 10000
Insertion/withdrawal force	< 100 N	< 100 N
Type of protection (when plugged in)	IP44	IP44
Degree of protection (with protective cap)	IP24	IP24
Degree of protection (when not plugged in)	IP20	IP20
<b>Cable data</b>		
Cable type	Straight	Straight
Cable length	4 m	4 m
Cable diameter	10.5 mm ±0.5	13 mm ±0.5
Cable structure	3 x 2.5 mm <sup>2</sup> + 1 x 0.5 mm <sup>2</sup>	5 x 2.5 mm <sup>2</sup> + 1 x 0.5 mm <sup>2</sup>
Sheath color	Black	Black

Technical data	
20 A	20 A
Rated current	20 A
Number of phases	3
Rated voltage	480 V AC
Standards	IEC 62196-2
Charging mode	Mode 3
Resistor coding	680 Ω (between PE and PP)
Ambient temperature (Operation)	-30°C ... 50°C
Number of power contacts	5 (L1, L2, L3, N, PE)
Insertion/withdrawal cycles	> 10000
Insertion/withdrawal force	< 100 N
Type of protection (when plugged in)	IP44
Degree of protection (with protective cap)	IP24
Degree of protection (when not plugged in)	IP20
<b>Cable data</b>	
Cable type	Straight
Cable length	4 m
Cable diameter	13 mm ±0.5
Cable structure	5 x 2.5 mm <sup>2</sup> + 1 x 0.5 mm <sup>2</sup>
Sheath color	Black

Technical data	
32 A	32 A
Rated current	32 A
Number of phases	3
Rated voltage	480 V AC
Standards	IEC 62196-2
Charging mode	Mode 3
Resistor coding	220 Ω (between PE and PP)
Ambient temperature (Operation)	-30°C ... 50°C
Number of power contacts	5 (L1, L2, L3, N, PE)
Insertion/withdrawal cycles	> 10000
Insertion/withdrawal force	< 100 N
Type of protection (when plugged in)	IP44
Degree of protection (with protective cap)	IP24
Degree of protection (when not plugged in)	IP20
<b>Cable data</b>	
Cable type	Straight
Cable length	4 m
Cable diameter	17 mm ±0.5
Cable structure	5 x 6 mm <sup>2</sup> + 1 x 0.5 mm <sup>2</sup>
Sheath color	Black

Description	Ordering data	
	Order No.	Pcs. / Pkt.
<b>AC charging cable with open cable end, mode 3, type 2</b>		
	<b>1409319</b>	<b>1</b>

Description	Ordering data	
	Order No.	Pcs. / Pkt.
<b>AC charging cable with open cable end, mode 3, type 2</b>		
	<b>1409320</b>	<b>1</b>

Description	Ordering data	
	Order No.	Pcs. / Pkt.
<b>AC charging cable with open cable end, mode 3, type 2</b>		
	<b>1405198</b>	<b>1</b>

# Connection technology for field devices

## Charging cables for electric vehicles

### Type 1 and type 1 mobile AC charging cables (mode 3)

The mobile AC charging cables enable electric vehicles to be charged with alternating current at European charging stations or wall boxes at home and while on the move. They can easily be stored inside the vehicle.

<b>Notes:</b>
Further cable types and lengths are available on request.
Color variants for housing and cables are available on request.
All connectors and plugs are supplied with a protective cap.



**Type 1 AC connector with type 2 plug**



**Type 2 AC connector with type 2 plug**



	Technical data		Technical data	
	20 A	32 A	20 A	32 A
Rated current	20 A	32 A	20 A	32 A
Number of phases	1	1	1	3
Rated voltage	250 V AC	250 V AC	250 V AC	480 V AC
Standards	IEC 62196-2	IEC 62196-2	IEC 62196-2	IEC 62196-2
Charging mode	Mode 3	Mode 3	Mode 3	Mode 3
Ambient temperature (Operation)	-30°C ... 50°C	-30°C ... 50°C	-30°C ... 50°C	-30°C ... 50°C
Number of power contacts	3 (L1, N, PE)	3 (L1, N, PE)	3 (L1, N, PE)	5 (L1, L2, L3, N, PE)
Insertion/withdrawal cycles	> 10000	> 10000	> 10000	> 10000
Insertion/withdrawal force	< 100 N	< 100 N	< 100 N	< 100 N
Type of protection (when plugged in)	IP44	IP44	IP44	IP44
Degree of protection (with protective cap)	IP24	IP24	IP24	IP24
Degree of protection (when not plugged in)	IP20	IP20	IP20	IP20
<b>Cable data</b>				
Cable type	Straight	Straight	Straight	Straight
Cable length	4 m	4 m	4 m	4 m
Cable diameter	10.5 mm ±0.5	13.9 mm ±0.5	10.5 mm ±0.5	17 mm ±0.5
Cable structure	3 x 2.5 mm <sup>2</sup> + 1 x 0.5 mm <sup>2</sup>	3 x 6 mm <sup>2</sup> + 1 x 0.5 mm <sup>2</sup>	3 x 2.5 mm <sup>2</sup> + 1 x 0.5 mm <sup>2</sup>	5 x 6 mm <sup>2</sup> + 1 x 0.5 mm <sup>2</sup>
Sheath color	Black	Black	Black	Black
<b>Ordering data</b>				
Description	Order No.	Pcs. / Pkt.	Order No.	Pcs. / Pkt.
	20 A		32 A	
<b>AC charging cable with plug, mode 3</b>	1621481	1	1410090	1
<b>Ordering data</b>				
Description	Order No.	Pcs. / Pkt.	Order No.	Pcs. / Pkt.
	20 A		32 A	
<b>AC charging cable with plug, mode 3</b>	1405193	1	1404569	1

**Type 1 and type 2 mobile AC charging cables (mode 2)**

The mobile AC charging cables with In Cable Control and Protection Device (IC-CPD) enable electric vehicles to be charged with alternating current at a normal, European socket at home and while on the move. Standardized communication with the vehicle as well as the safety equipment are integrated in the IC-CPD.



**Type 1 AC connector with IC-CPD and SCHUKO plug**



**Type 2 AC connector with IC-CPD and SCHUKO plug**

**Notes:**  
All connectors are supplied with a protective cap.

	Technical data			Technical data		
Rated current	6 A ... 13 A			6 A ... 13 A		
Number of phases	1			1		
Rated voltage	200 V AC ... 250 V AC			200 V AC ... 250 V AC		
Frequency	50 Hz			50 Hz		
Charging power	1.4 kW ... 3 kW			1.4 kW ... 3 kW		
Standards	IEC 61851-1			IEC 61851-1		
Charging mode	Mode 2			Mode 2		
Ambient temperature (Operation)	-30°C ... 40°C			-30°C ... 40°C		
Tripping characteristics / residual current	Type A/30 mA			Type A/30 mA		
Infrastructure plug	SCHUKO (type AF)			SCHUKO (type AF)		
Temperature sensor (infrastructure plug)	Available			Available		
Degree of protection (IC-CPD)	IP67			IP67		
Type of protection (when plugged in)	IP44			IP44		
Degree of protection (with protective cap)	IP24			IP24		
Degree of protection (when not plugged in)	IP20			IP20		
<b>Cable data</b>						
Cable type	Straight			Straight		
Cable length	4 m			4 m		
Cable diameter	10.5 mm ±0.5			10.5 mm ±0.5		
Cable structure	3 x 2.5 mm <sup>2</sup> + 2 x 0.5 mm <sup>2</sup>			3 x 2.5 mm <sup>2</sup> + 2 x 0.5 mm <sup>2</sup>		
Sheath color	Red			Red		
<b>Ordering data</b>						
Description	<b>Type</b>	<b>Order No.</b>	<b>Pcs. / Pkt.</b>	<b>Type</b>	<b>Order No.</b>	<b>Pcs. / Pkt.</b>
	AC charging cable with IC-CPD, mode 2	EV-ICCPD-T1C-EU-S-13A1-A-GEN2	1621797		1	EV-ICCPD-T2C-EU-S-13A1-A

# Connection technology for field devices

## Charging cables for electric vehicles

### Combined charging system (CCS) DC charging cables type 1 and type 2

The CCS DC charging cables with open cable end are connected directly to a DC charging station. They are suitable for fast DC charging of electric vehicles.

The CCS connector is compatible with the CCS inlet, which also accommodates an AC connector.



**Type 1 combined DC connector,  
with AWG cable**



**Type 2 combined DC connector,  
with metric cable**

<b>Notes:</b>
Further cable types and lengths are available on request.
Color variants for housing and cables are available on request.

	Technical data			Technical data		
	60 A	125 A	200 A	60 A	125 A	200 A
Rated current	60 A	125 A	200 A	60 A	125 A	200 A
Rated voltage	600 V DC	600 V DC	600 V DC	850 V DC	850 V DC	850 V DC
Standards	SAE J1772	SAE J1772	SAE J1772	IEC 62196-3	IEC 62196-3	IEC 62196-3
Charging mode	DC level 2	DC level 2	DC level 2	Mode 4	Mode 4	Mode 4
Resistor coding	150 Ω (Lever actuated) 480 Ω (Lever not actuated)	150 Ω (Lever actuated) 480 Ω (Lever not actuated)	150 Ω (Lever actuated) 480 Ω (Lever not actuated)	1500 Ω (between PE and PP)	1500 Ω (between PE and PP)	1500 Ω (between PE and PP)
Ambient temperature (Operation)	-30°C ... 50°C	-30°C ... 50°C	-30°C ... 50°C	-30°C ... 50°C	-30°C ... 50°C	-30°C ... 50°C
Number of power contacts	3 (PE, DC+, DC-)	3 (PE, DC+, DC-)	3 (PE, DC+, DC-)	3 (PE, DC+, DC-)	3 (PE, DC+, DC-)	3 (PE, DC+, DC-)
Insertion/withdrawal cycles	> 10000	> 10000	> 10000	> 10000	> 10000	> 10000
Insertion/withdrawal force	< 100 N	< 100 N	< 100 N	< 100 N	< 100 N	< 100 N
Temperature sensor	Pt1000	Pt1000	Pt1000	Pt1000	Pt1000	Pt1000
Type of protection (when plugged in)	IP44	IP44	IP44	IP44	IP44	IP44
Degree of protection (when not plugged in)	IP20	IP20	IP20	IP24	IP24	IP24
<b>Cable data</b>						
Cable type	Straight	Straight	Straight	Straight	Straight	Straight
Cable length	5 m	5 m	5 m	4,5 m	5 m	5 m
Cable diameter	20.6 mm ± 0.2	32.2 mm ± 0.2	37.4 mm ± 0.2	19 mm ± 0.2	28.2 mm ± 0.2	32 mm ± 0.2
Cable structure	3 x 6 AWG + 3 x 2 x 18 AWG	2 x 1 AWG + 1 x 3 AWG + 3 x 2 x 18 AWG	2 x 00 AWG + 1 x 1 AWG + 3 x 2 x 18 AWG	3 x 16 mm <sup>2</sup> + 3 x 2 x 0.75 mm <sup>2</sup>	2 x 50 mm <sup>2</sup> + 1 x 25 mm <sup>2</sup> + 3 x 2 x 0.75 mm <sup>2</sup>	2 x 70 mm <sup>2</sup> + 1 x 35 mm <sup>2</sup> + 3 x 2 x 0.75 mm <sup>2</sup>
Sheath color	Black	Black	Black	Black	Black	Black
<b>Ordering data</b>						
Description	Order No.	Pcs. / Pkt.	Order No.	Pcs. / Pkt.	Order No.	Pcs. / Pkt.
	60 A		125 A		200 A	
<b>DC charging cable with open cable end, combined charging system (CCS)</b>	1621488	1	1409950	1	1621489	1
	1618306	1	1409060	1	1621653	1

**DC charging cables  
GB standard (China)**

DC GB charging cables with open cable end are installed in Chinese charging stations with a stationary AC/DC converter. They are suitable for fast DC charging of electric vehicles.



**DC GB connector,  
with metric cable**

<b>Notes:</b>
Further cable types and lengths are available on request.
Color variants for housing and cables are available on request.

Technical data	
Rated current	60 A
Rated voltage	750 V DC
Standards	GB/T Part 3
Charging mode	Mode 4
Resistor coding	1000 Ω
Ambient temperature (Operation)	-30°C ... 50°C
Number of power contacts	3
Insertion/withdrawal cycles	> 10000
Insertion/withdrawal force	< 100 N
Type of protection (when plugged in)	IP55
Cable data	
Cable type	Straight
Cable length	5 m
Cable diameter	20,2 mm ± 0.2
Cable structure	3 x 16 mm <sup>2</sup> + 2 x 2.5 mm <sup>2</sup> + 9 x 0.5 mm <sup>2</sup>
Sheath color	Black

Ordering data			
Description	Type	Order No.	Pcs. / Pkt.
<b>DC charging cable with open cable end, GB/T</b>	<b>EV-GBM4C-DC60A-5,0M16ESBK00</b>	<b>1621468</b>	<b>1</b>



FAME plug-in test system with push-in connection, for wall and DIN rail mounting

PT ... Page 92



FAME plug-in test system with screw connection, for wall and DIN rail mounting

UT ... Page 94



FAME test plug, multi-position, freely configurable contact tabs

FTPR ..., FTP ... Page 96



Ordering example for configurable test plugs with twist grip or standard grip

Page 97



Blind plugs, coding profile, and colored test sockets

Page 98



Accessories  
Bridges and cover profiles

Page 100



FAME plug-in test system with push-in connection, VDE types, for wall and DIN rail mounting

PT ... Page 102

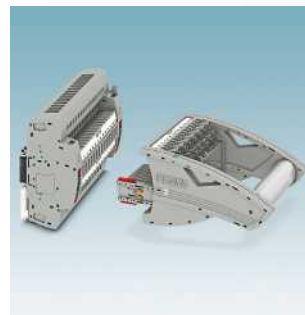

FAME plug-in test system with screw connection, VDE types, for wall and DIN rail mounting

UT ... Page 128



Push-in knife disconnect terminal blocks

PT 1,5..., PTT 1,5... Page 156

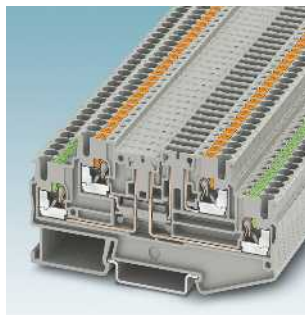

Push-in double-level disconnect and knife disconnect terminal blocks

PTT 2,5... Page 158

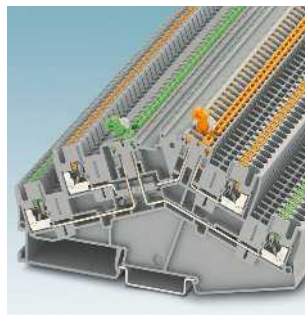

Push-in double-level disconnect and knife disconnect terminal blocks in desk design

PTTBS ... Page 160



Screw connection disconnect and knife disconnect terminal blocks with fuse plug

UT ...-TG Page 162  
UTT ...-TG Page 164



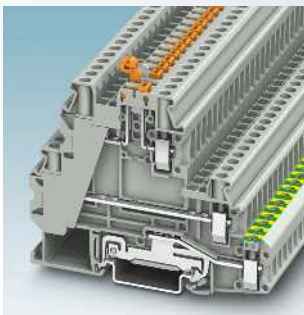
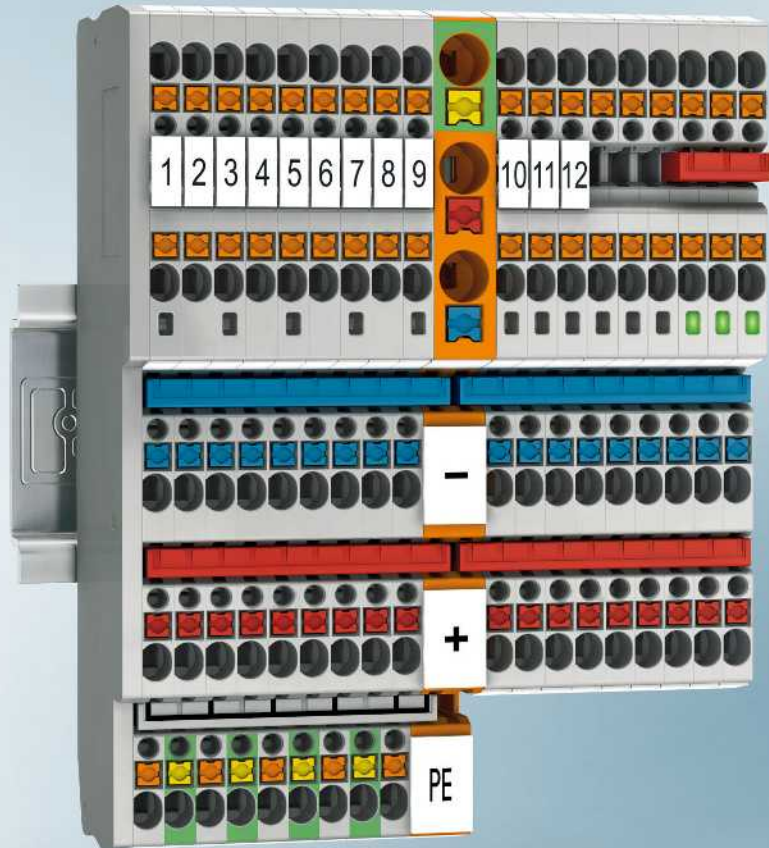

Screw connection multi-level function and lever-type fuse terminal blocks with PE foot

UT 4...-TG/MT  
UT 4...-HESI

Page 166  
Page 168



Fast connection hybrid knife disconnect terminal block with single-sided screw connection

QTCU 2,5-TWIN-MT

Page 172

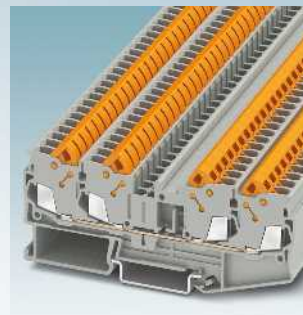

Fast connection feed-through and ground terminal blocks

QTC 2,5-QUATTRO

Page 173

## Modular terminal blocks

### FAME plug-in test system

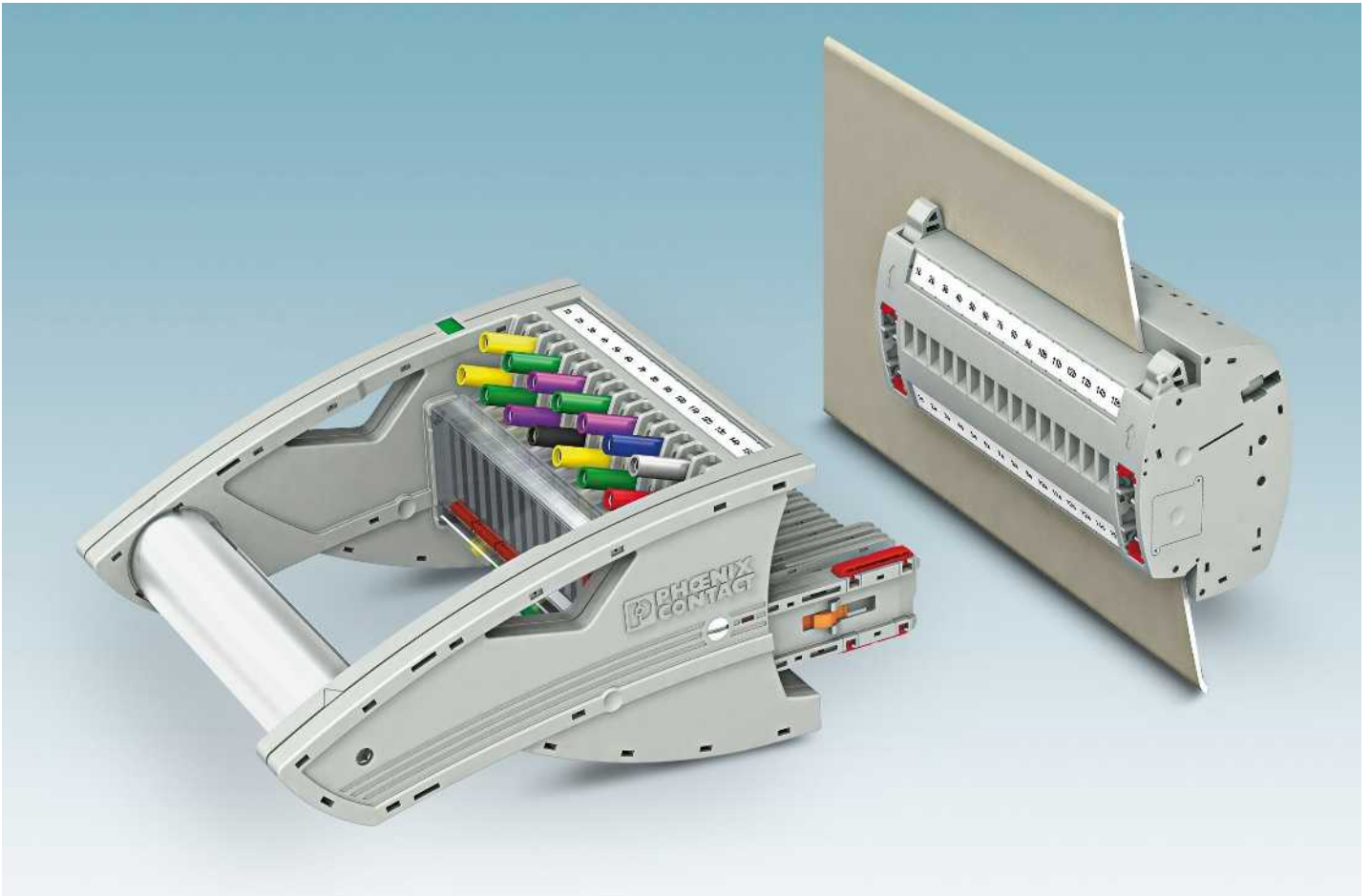

FAME is the innovative test system for all measuring and testing tasks in network protection technology for medium and high-voltage switchgear. With the modular system, you can now perform manual testing automatically, safely, and more quickly. Suitable for every application, the modular system can be directly integrated into the control cabinet panel or used as a DIN rail version.

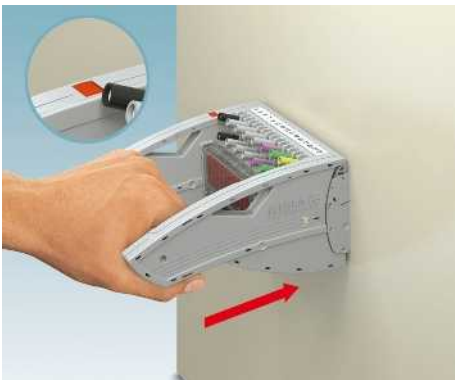

The test plug is completely inserted and engaged, the display window turns red. All test contacts are contacted according to the test setup.



The twist grip is turned upward as far as it will go, the display window turns yellow. Test contacts with short contact tab lengths (e.g., current transformers) are once again connected to the protective device.

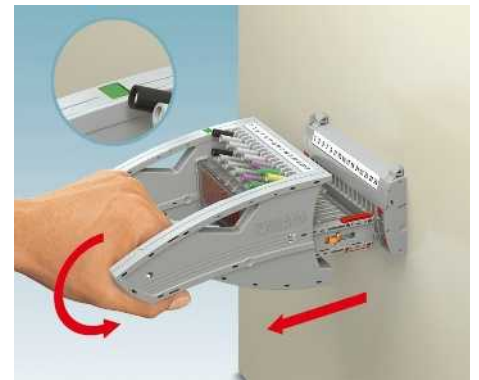

The twist grip must be turned back to its starting position. Now the mechanism releases the plug so it can be fully removed. The display window turns green.

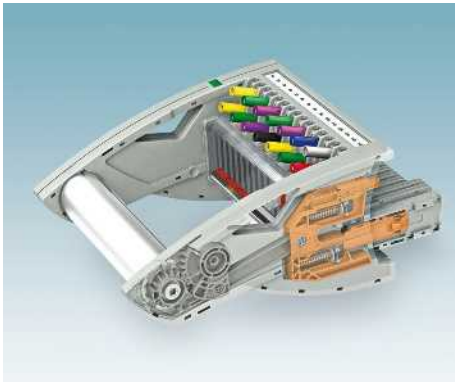

Preprogrammed short-circuit and switching operations depend on consistent insertion and removal of the test plug. Undefined contact states are effectively avoided thanks to the twist grip mechanism.

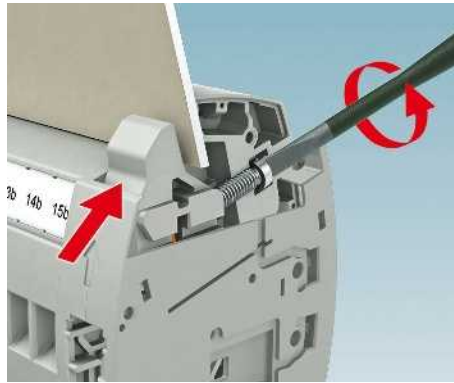

The patented wall fastening is easy to use and has a robust design. Even tolerances in the panel cutout of up to 4 mm are compensated.

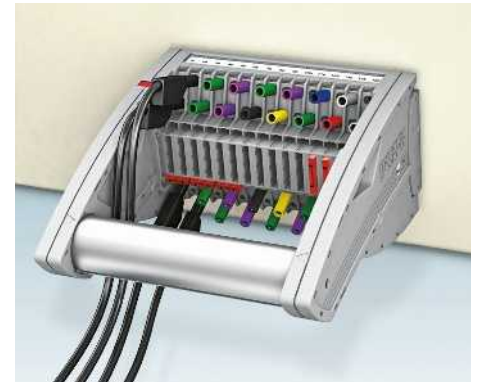

The offset test socket arrangement enables the use of CAT III and CAT IV/1000 V safety test leads according to EN 61010-031 in a confined space.

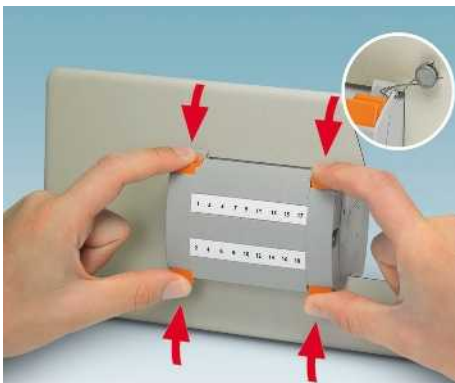

FAME test terminal strips have an IP20 design. Blind plugs without switching function can be inserted and secured with seals. These can only be released with two-hand operation.

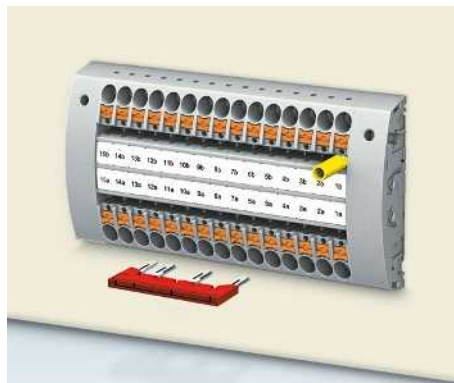

In addition to the two marking grooves, the test terminal strips for wall mounting also offer two function shafts, or six function shafts in the case of the DIN rail version, inside the control cabinet for forming and grounding the star point.

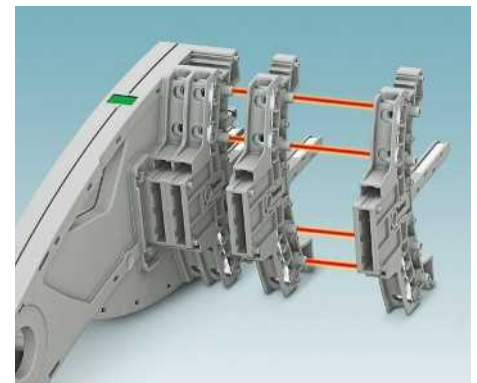

The compact and modular design of the system, as well as the plugs and test terminal strips, provides an extensive range of options for every application with positions from 4 to 25.



All applications which do not involve testing through the closed door and the open rack mounting can be implemented with the DIN rail version. Terminal points and plug-in zone can be operated from one direction.

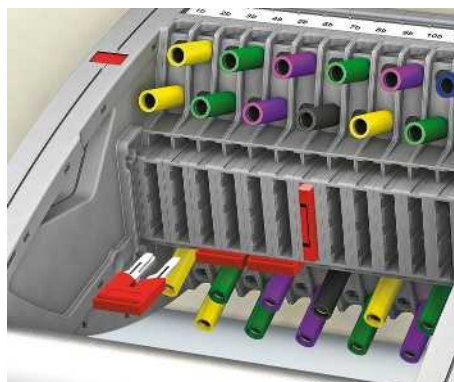

The test plug provides three function shafts between the 4 mm test contacts. Horizontally aligned, as leading short-circuit jumper - vertically aligned as through connection in the plug.



The coding profiles can be applied by the user according to their application. VDE-compliant versions are pre-coded on delivery. This ensures maximum safety.

## FAME 2 – safe in every operating state

The new, modular FAME measuring transducer test system enables all transformer testing tasks to be carried out quickly and safely.

The automatically generated transformer short circuit, the twist grip mechanism, and the shock-proof design provide maximum safety during measurement.

### Normal operation

Closed N/O contact

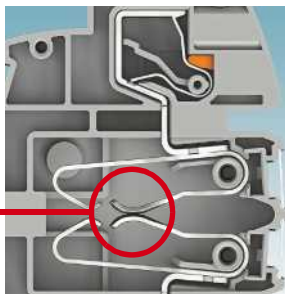

### Transformer short circuit

Leading short circuit by means of auxiliary contact

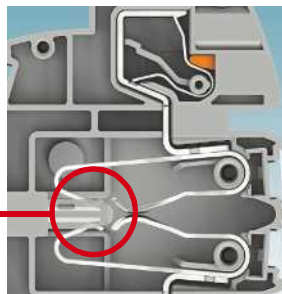

### Test operation

N/O contact connected via test socket

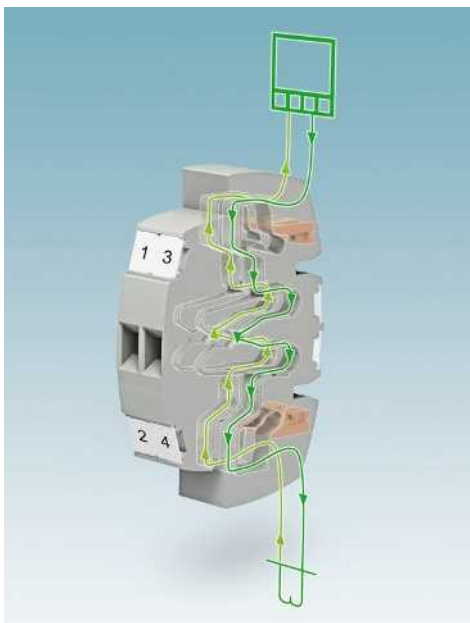
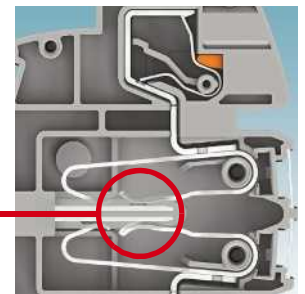

Due to the N/C contact function of the FAME 2 system, additional power plugs are not required for normal operation. If desired, the plug-in zone can be covered with a blind plug to prevent unauthorized access.

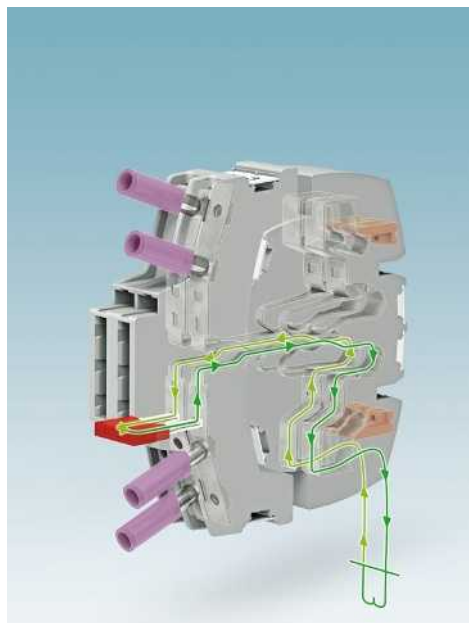

When replacing the protective device or even in the case of a relay test, a leading short circuit of the current transformer (for the purpose of signal splitting) can be easily carried out by means of a jumper inserted crossways.

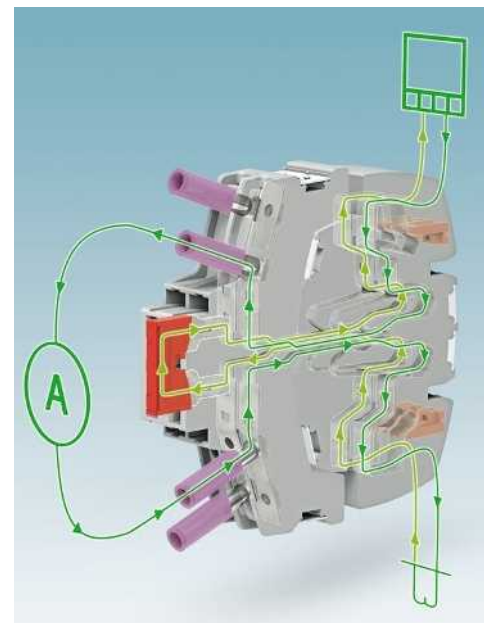

With the jumper simply inserted lengthways in the test plug, test equipment can be easily looped into the current path via the 4 mm test sockets.

Medium-voltage circuit example with star point grounding in the test terminal strip

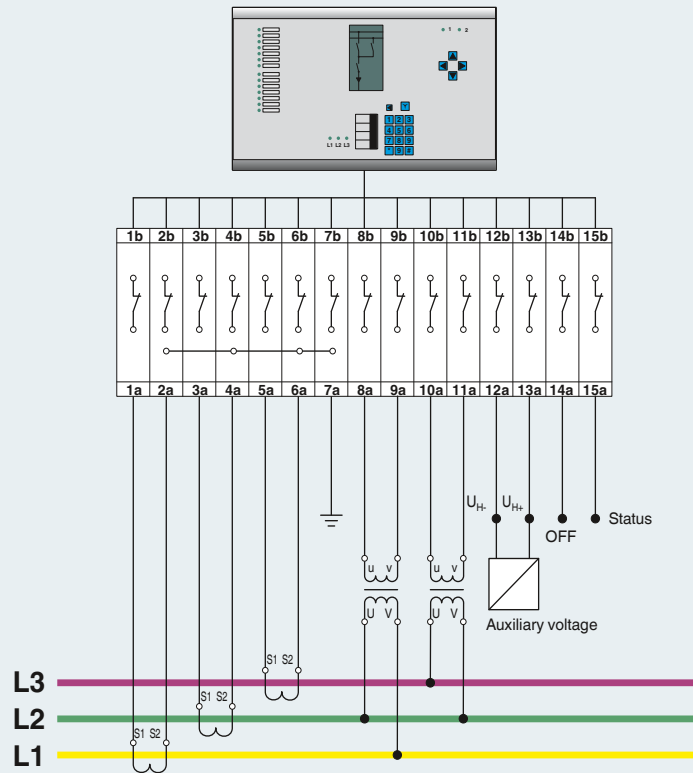

Test terminal strip with current transformer, voltage transducer, and signals

Test plug with current transformer, voltage transducer, and signals

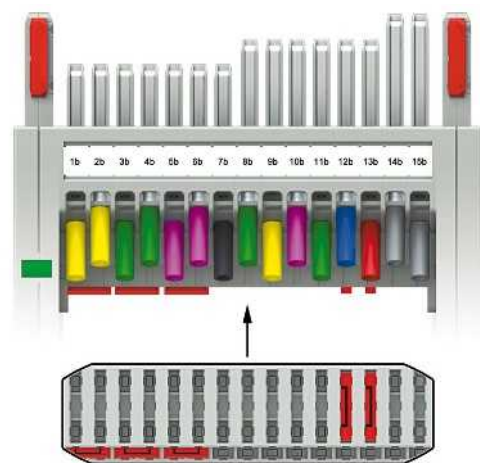
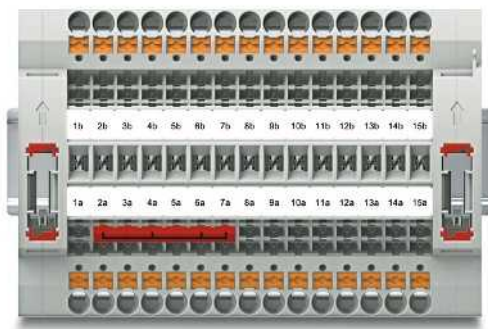

Test terminal strip, blind plug

Order No.	Type	Required quantity
3069864	PTRE 6-2/15	1
3069886	FBP 2/15	1

Jumper

3032470	FBS 6-8	1
---------	---------	---

Test plug

Order No.	Type	Required quantity
3001693	FTFR 2/15	1

Jumper

3030284	FBS 2-8	3
3030297	FBS 3-8	2

## FAME plug-in test system

### Test terminal strip, multi-position with PT ... push-in connection, for PTWE ... wall mounting



The modular FAME measuring transducer test system, with the innovative push-in connection technology, enables all transformer testing tasks to be carried out quickly and safely. The transformer is short-circuited and the testing device is looped in automatically through the insertion process.

- The test terminal strips can be used universally for current and voltage transducers
- The test terminal strip can be mounted on the control cabinet door or on the DIN rail
- Signal and status messages can be wired in combination in a test terminal strip
- The correct switching sequence when removing the test plug is ensured by a locking device and a mechanical drive in the twist grip
- All test signals can be connected with touch-proof safety test leads (CAT III and CAT IV/1000 V according to EN 61010-031)
- All versions listed can be equipped with coding for the matching test plug
- Star points of the current transformer can easily be created in the test terminal strip on the rear by means of FBS jumpers.
- You can find corresponding accessories from page 99

Notes:
To create panel cutouts, see phoenixcontact.net/products.
1) Derating curve available on request.
2) Rated surge voltage of 5 kV.



6 (10) mm<sup>2</sup>, 30 A, 4 ... 25-pos. test terminal strip, for wall mounting

Max. electrical data	
<b>Rated data</b>	
Rated voltage	[V] 400 <sup>2)</sup>
Nominal current / cross section	[A] / [mm <sup>2</sup> ] 24 <sup>1)</sup> /6
Rated cross section	[mm <sup>2</sup> ] 6
Cross section range	AWG 20 - 8
<b>Connection capacity</b>	
1 conductor	[mm <sup>2</sup> ] 0.5 - 10
2 stranded conductors with a TWIN ferrule	[mm <sup>2</sup> ] 0.5 - 6
Plug-in connection cross sections	[mm <sup>2</sup> ] 1 - 10
<b>General data</b>	
Stripping length	[mm] 12
Tightening torque for wall fastening	[Nm] 0.8 - 1
Panel thickness	[mm] 1 - 4
Insulating material	PA
Inflammability class according to UL 94	V0

Technical data			
I <sub>max</sub> [A]	U <sub>max</sub> [V]	max. Ø [mm <sup>2</sup> ]	AWG
30	400 <sup>2)</sup>	0.5 - 10	20 - 8
IEC 60947-7-1			
IEC	UL/CUL	CSA	IEC/EN 60079-7
<b>Connection capacity</b>			
		ferrule	
		with/without plastic sleeve	
solid	stranded	0.5 - 6	0.5 - 6
0.5 - 10	0.5 - 6	1 - 6	0.5 - 1.5
1 - 10	-	1 - 6	1 - 6
<b>Ordering data</b>			
Type	I <sub>max</sub>	Order No.	Pcs. / Pkt.
PTWE 6-2/4		3069827	1
PTWE 6-2/5		3069828	1
PTWE 6-2/9		3069832	1
PTWE 6-2/10		3069833	1
PTWE 6-2/12		3069835	1
PTWE 6-2/14		3069837	1
PTWE 6-2/15		3069838	1
PTWE 6-2/17		3069840	1
PTWE 6-2/19		3069842	1
PTWE 6-2/20		3069843	1
PTWE 6-2/21		3069844	1
PTWE 6-2/22		3069845	1
PTWE 6-2/25		3069848	1

Description	No. of pos.	Color
<b>Test terminal strip</b> , for wall mounting,		
4-pos.		gray
5-pos.		gray
9-pos.		gray
10-pos.		gray
12-pos.		gray
14 pos.		gray
15-pos.		gray
17-pos.		gray
19 pos.		gray
20 pos.		gray
21 pos.		gray
22 pos.		gray
25 pos.		gray

Jumper	No. of pos.	Color
	2	red
	3	red
	4	red
	5	red
	6	red
	10	red
<b>Jumper</b>	16	red
<b>Pre-assembled bridge</b> , labeled		
3-pos., positions 1, 3	3	red
4-pos., positions 1, 4	4	red
5-pos., positions 1, 3, 5	5	red
10-pos., positions 1, 4, 7, 10	10	red
<b>Cover profile</b> , supply length 1 m		transparent
<b>Cover profile holder</b> , can be snapped on and sealed		gray
<b>Screwdriver</b>		

Type	I <sub>max</sub>	Order No.	Pcs. / Pkt.
FBS 2-8	24 A	3030284	10
FBS 3-8	24 A	3030297	10
FBS 4-8	24 A	3030307	10
FBS 5-8	24 A	3030310	10
FBS 6-8	24 A	3032470	10
FBS 10-8	24 A	3030323	10
FBSR 16-8	24 A	3033816	10
FBS 1/3-8	24 A	3032363	10
FBS 1/4-8	24 A	3032376	10
FBS 1/3/5-8	24 A	3032389	10
FBS 1/4/7/10-8	24 A	3032402	10
AP RSC-T		3059139	10
APH-UTWE 6-2		3069057	10
SF-SL 0,8X4,0-100		1212551	10

Accessories			
<b>Accessories</b>			
UC-TM 8, UCT-TM 8, ZB 8 or TMT (EX9,5)R (see Catalog 5)			

Test terminal strip, multi-position with PT ... push-in connection, for PTRE ... DIN rail mounting



6 (10) mm<sup>2</sup>, 30 A, 4 ... 25-pos. test terminal strip, for DIN rail mounting

**Notes:**  
 1) Derating curve available on request.  
 2) Rated surge voltage of 5 kV.

**Max. electrical data**

Rated data	
Rated voltage	[V]
Nominal current / cross section	[A] / [mm <sup>2</sup> ]
Rated cross section	[mm <sup>2</sup> ]
Cross section range	AWG
Connection capacity	
1 conductor	[mm <sup>2</sup> ]
2 stranded conductors with a TWIN ferrule	[mm <sup>2</sup> ]
Plug-in connection cross sections	[mm <sup>2</sup> ]
General data	
Stripping length	[mm]
Insulating material	
Inflammability class according to UL 94	

**Technical data**

I <sub>max</sub> [A]	U <sub>max</sub> [V]	max. Ø [mm <sup>2</sup> ]	AWG
30	400 <sup>2)</sup>	0.5 - 10	20 - 8
IEC 60947-7-1			
IEC	UL/CUL	CSA	IEC/EN 60079-7
400 <sup>2)</sup>	-	-	-
24 <sup>1)</sup> /6	-	-	-
6	-	-	-
20 - 8	-	-	-
Connection capacity		ferrule	
	solid	stranded	with/without plastic sleeve
0.5 - 10		0.5 - 6	0.5 - 6
			0.5 - 1.5
1 - 10	-	1 - 6	1 - 6
12			
PA			
V0			

Description	No. of pos.	Color
<b>Test terminal strip, for DIN rail mounting,</b>		
4-pos.		gray
5-pos.		gray
9-pos.		gray
10-pos.		gray
12-pos.		gray
14 pos.		gray
15-pos.		gray
17-pos.		gray
19 pos.		gray
20 pos.		gray
21 pos.		gray
22 pos.		gray
25 pos.		gray

**Ordering data**

Type	I <sub>max</sub>	Order No.	Pcs. / Pkt.
PTRE 6-2/4		3069849	1
PTRE 6-2/5		3069850	1
PTRE 6-2/9		3069854	1
PTRE 6-2/10		3069855	1
PTRE 6-2/12		3069861	1
PTRE 6-2/14		3069863	1
PTRE 6-2/15		3069864	1
PTRE 6-2/17		3069866	1
PTRE 6-2/19		3069868	1
PTRE 6-2/20		3069869	1
PTRE 6-2/21		3069870	1
PTRE 6-2/22		3069871	1
PTRE 6-2/25		3069874	1

<b>Jumper</b>		
	2	red
	3	red
	4	red
	5	red
	6	red
	10	red
<b>Jumper</b>		
	16	red
<b>Pre-assembled bridge, labeled</b>		
3-pos., positions 1, 3	3	red
4-pos., positions 1, 4	4	red
5-pos., positions 1, 3, 5	5	red
10-pos., positions 1, 4, 7, 10	10	red
Cover profile, supply length 1 m		transparent
End brackets, for AP-ME cover profile, sealable, with storage option for jumpers		gray
Holder, for AP-ME cover profile		gray
<b>Screwdriver</b>		

**Accessories**

Type	I <sub>max</sub>	Order No.	Pcs. / Pkt.
FBS 2-8	24 A	3030284	10
FBS 3-8	24 A	3030297	10
FBS 4-8	24 A	3030307	10
FBS 5-8	24 A	3030310	10
FBS 6-8	24 A	3032470	10
FBS 10-8	24 A	3030323	10
FBSR 16-8	24 A	3033816	10
FBS 1/3-8	24 A	3032363	10
FBS 1/4-8	24 A	3032376	10
FBS 1/3/5-8	24 A	3032389	10
FBS 1/4/7/10-8	24 A	3032402	10
AP-ME METER		3034361	10
APH-ME		3034374	10
APT-ME		3034358	10
SF-SL 0,8X4,0-100		1212551	10

**Lateral groove labeling**

UC-TM 8, UCT-TM 8, ZB 8 or TMT (EX9,5)R (see Catalog 5)

## FAME plug-in test system

### Test terminal strip, multi-position with UT ... screw connection, for UTWE ... wall mounting



The modular FAME measuring transducer test system, with universal screw connection technology, enables all transformer testing tasks to be carried out quickly and safely. The transformer is short-circuited and the testing device is looped in automatically through the insertion process.

- The test terminal strips can be used universally for current and voltage transducers
- The test terminal strip can be mounted on the control cabinet door or on the DIN rail
- Signal and status messages can be wired in combination in a test terminal strip
- The correct switching sequence when removing the test plug is ensured by a locking device and a mechanical drive in the twist grip
- All test signals can be connected with touch-proof safety test leads (CAT III and CAT IV/1000 V according to EN 61010-031)
- All versions listed can be equipped with coding for the matching test plug
- Star points of the current transformer can easily be created in the test terminal strip on the rear by means of FBS jumpers
- You can find corresponding accessories from page 99

<b>Notes:</b>
To create panel cutouts, see phoenixcontact.net/products.
1) Derating curve available on request.
2) Rated surge voltage of 5 kV.



6 (10) mm<sup>2</sup>, 30 A, 4 ... 25-pos. test terminal strip, for wall mounting

<b>Max. electrical data</b>	
<b>Rated data</b>	
Rated voltage	[V] 400 <sup>2)</sup>
Nominal current / cross section	[A] / [mm <sup>2</sup> ] 24 <sup>1)</sup> /6
Rated cross section	[mm <sup>2</sup> ] 6
Cross section range	AWG 24 - 8
<b>Connection capacity</b>	
1 conductor	[mm <sup>2</sup> ] 0.2 - 10
2 conductors (of the same type)	[mm <sup>2</sup> ] 0.2 - 2.5
2 stranded conductors with a TWIN ferrule	[mm <sup>2</sup> ] 0.2 - 2.5
<b>General data</b>	
Stripping length	[mm] 10
Screw thread	M4
Tightening torque	[Nm] 1.5 - 1.8
Tightening torque for wall fastening	[Nm] 0.8 - 1
Panel thickness	[mm] 1 - 4
Insulating material	PA
Inflammability class according to UL 94	V0

Technical data			
I <sub>max</sub> [A]	U <sub>max</sub> [V]	max. Ø [mm <sup>2</sup> ]	AWG
30	400 <sup>2)</sup>	0.2 - 10	24 - 8
IEC 60947-7-1			
IEC	UL/CUL	CSA	IEC/EN 60079-7
<b>Connection capacity</b>		<b>ferrule</b>	
solid	stranded	with/without plastic sleeve	
0.2 - 10	0.2 - 10	0.25 - 6	0.25 - 6
0.2 - 2.5	0.2 - 2.5	0.25 - 1.5	-
			0.5 - 2.5

Description	No. of pos.	Color
<b>Test terminal strip</b> , for wall mounting,		
4-pos.		gray
5-pos.		gray
9-pos.		gray
10-pos.		gray
12-pos.		gray
14 pos.		gray
15-pos.		gray
17-pos.		gray
19 pos.		gray
20 pos.		gray
21 pos.		gray
22 pos.		gray
25 pos.		gray

Ordering data			
Type	I <sub>max</sub>	Order No.	Pcs. / Pkt.
UTWE 6-2/4		3069650	1
UTWE 6-2/5		3069651	1
UTWE 6-2/9		3069656	1
UTWE 6-2/10		3069658	1
UTWE 6-2/12		3069660	1
UTWE 6-2/14		3069663	1
UTWE 6-2/15		3069664	1
UTWE 6-2/17		3069667	1
UTWE 6-2/19		3069672	1
UTWE 6-2/20		3069673	1
UTWE 6-2/21		3069800	1
UTWE 6-2/22		3069801	1
UTWE 6-2/25		3069804	1

Jumper		
	2	red
	3	red
	4	red
	5	red
	6	red
	10	red
<b>Jumper</b>		
	16	red
<b>Pre-assembled bridge</b> , labeled		
3-pos., positions 1, 3	3	red
4-pos., positions 1, 4	4	red
5-pos., positions 1, 3, 5	5	red
10-pos., positions 1, 4, 7, 10	10	red
<b>Cover profile</b> , supply length 1 m		transparent
<b>Cover profile holder</b> , can be snapped on and sealed		gray
<b>Screwdriver</b>		

Accessories			
FBS 2-8	24 A	3030284	10
FBS 3-8	24 A	3030297	10
FBS 4-8	24 A	3030307	10
FBS 5-8	24 A	3030310	10
FBS 6-8	24 A	3032470	10
FBS 10-8	24 A	3030323	10
FBSR 16-8	24 A	3033816	10
FBS 1/3-8	24 A	3032363	10
FBS 1/4-8	24 A	3032376	10
FBS 1/3/5-8	24 A	3032389	10
FBS 1/4/7/10-8	24 A	3032402	10
AP RSC-T		3059139	10
APH-UTWE 6-2		3069057	10
SF-SL 0,8X4,0-100		1212551	10

Lateral groove labeling	UC-TM 8, UCT-TM 8, ZB 8 or TMT (EX9,5)R (see Catalog 5)
-------------------------	---



### Test terminal strip, multi-position with UT ... screw connection, for UTRE ... DIN rail mounting



6 (10) mm<sup>2</sup>, 30 A, 4 ... 25-pos. test terminal strip, for DIN rail mounting

#### Notes:

1) Derating curve available on request.

2) Rated surge voltage of 5 kV.

#### Max. electrical data

#### Rated data

Rated voltage	[V]	400 <sup>2)</sup>
Nominal current / cross section	[A] / [mm <sup>2</sup> ]	24 <sup>1)</sup> /6
Rated cross section	[mm <sup>2</sup> ]	6
Cross section range	AWG	24 - 8

#### Connection capacity

1 conductor	[mm <sup>2</sup> ]	0.2 - 10
2 conductors (of the same type)	[mm <sup>2</sup> ]	0.2 - 2.5
2 stranded conductors with a TWIN ferrule	[mm <sup>2</sup> ]	0.2 - 2.5

#### General data

Stripping length	[mm]	10
Screw thread		M4
Tightening torque	[Nm]	1.5 - 1.8
Insulating material		PA
Inflammability class according to UL 94		V0

#### Technical data

I <sub>max</sub> [A]	U <sub>max</sub> [V]	max. Ø [mm <sup>2</sup> ]	AWG
30	400 <sup>2)</sup>	0.2 - 10	24 - 8

IEC 60947-7-1	UL/CUL	CSA	IEC/EN 60079-7
---------------	--------	-----	----------------

400 <sup>2)</sup>	-	-	-
24 <sup>1)</sup> /6	-	-	-
6	-	-	-
24 - 8	-	-	-

solid	stranded	ferrule	
		with/without plastic sleeve	
0.2 - 10	0.2 - 10	0.25 - 6	0.25 - 6
0.2 - 2.5	0.2 - 2.5	0.25 - 1.5	-
			0.5 - 2.5

#### Ordering data

Description	No. of pos.	Color	Type	I <sub>max</sub>	Order No.	Pcs. / Pkt.
<b>Test terminal strip, for DIN rail mounting,</b>						
4-pos.		gray	UTRE 6-2/4		3069805	1
5-pos.		gray	UTRE 6-2/5		3069806	1
9-pos.		gray	UTRE 6-2/9		3069810	1
10-pos.		gray	UTRE 6-2/10		3069811	1
12-pos.		gray	UTRE 6-2/12		3069813	1
14 pos.		gray	UTRE 6-2/14		3069815	1
15-pos.		gray	UTRE 6-2/15		3069816	1
17-pos.		gray	UTRE 6-2/17		3069818	1
19 pos.		gray	UTRE 6-2/19		3069820	1
20 pos.		gray	UTRE 6-2/20		3069821	1
21 pos.		gray	UTRE 6-2/21		3069822	1
22 pos.		gray	UTRE 6-2/22		3069823	1
25 pos.		gray	UTRE 6-2/25		3069826	1

#### Accessories

Accessories	No. of pos.	Color	Type	I <sub>max</sub>	Order No.	Pcs. / Pkt.
<b>Jumper</b>						
	2	red	FBS 2-8	24 A	3030284	10
	3	red	FBS 3-8	24 A	3030297	10
	4	red	FBS 4-8	24 A	3030307	10
	5	red	FBS 5-8	24 A	3030310	10
	6	red	FBS 6-8	24 A	3032470	10
	10	red	FBS 10-8	24 A	3030323	10
<b>Jumper</b>						
	16	red	FBSR 16-8	24 A	3033816	10
<b>Pre-assembled bridge, labeled</b>						
3-pos., positions 1, 3	3	red	FBS 1/3-8	24 A	3032363	10
4-pos., positions 1, 4	4	red	FBS 1/4-8	24 A	3032376	10
5-pos., positions 1, 3, 5	5	red	FBS 1/3/5-8	24 A	3032389	10
10-pos., positions 1, 4, 7, 10	10	red	FBS 1/4/7/10-8	24 A	3032402	10
<b>Cover profile, supply length 1 m</b>		transparent	<b>AP-ME METER</b>		3034361	10
<b>End brackets, for AP-ME cover profile, sealable, with storage option for jumpers</b>		gray	<b>APH-ME</b>		3034374	10
<b>Holder, for AP-ME cover profile</b>		gray	<b>APT-ME</b>		3034358	10
<b>Screwdriver</b>			<b>SF-SL 0,8X4,0-100</b>		1212551	10
<b>Lateral groove labeling</b>						
UC-TM 8, UCT-TM 8, ZB 8 or TMT (EX9,5)R (see Catalog 5)						

## FAME plug-in test system

### Test plug, multi-position, freely-configurable contact tabs FTPR ... and FTP ...



The test plugs allow the switching sequence of the individual functions to be carried out with safe chronological disconnection with a switching operation via three different contact tab lengths. Configure the lengths of the contact tabs of the test plug to suit your application. We can provide you with a test plug according to your requirements in next to no time.

- The test plugs can be easily configured and ordered with just a click of the mouse in the product area on our website at [phoenixcontact.net/products](http://phoenixcontact.net/products)
- To order via fax or e-mail, please use the ordering data as shown in the ordering example on the following page

- The test plugs are characterized by:
- User-friendly twist grip function with latching
  - Robust and warp resistant design
  - Mechanically secure, molded contact tabs
  - High-quality contact surfaces for reliable transmission of signals
  - Strain relief for the connected test leads on the plug
  - Flexibility in the number of positions thanks to the modular design (additional options on request)
  - Large-surface marking options for each contact
  - Use of CLIPLINE complete accessories for testing, bridging, and marking
  - Additional test leads, assembled with ring and fork-type cable lugs, can be attached with test sockets
  - All test signals can be connected with touch-proof safety test leads (CAT III and CAT IV/1000 V according to EN 61010-031)
  - You can find corresponding accessories from page 99

<b>Notes:</b>
1) Rated surge voltage of 5 kV.



24 A, 4 ... 25-pos. test plug with twist grip or standard grip, 4 mm test sockets

<b>Max. electrical data</b>	
<b>Rated data</b>	
Rated voltage	[V] 400 <sup>1)</sup>
Nominal current / cross section	[A] / [mm <sup>2</sup> ] 24/2.5
Cross section range	AWG 20 - 14
<b>Connection capacity</b>	
1 conductor	[mm <sup>2</sup> ] -
<b>General data</b>	
Tightening torque: test socket screw	[Nm] 0.5 - 0.6
Insulating material	PA
Inflammability class according to UL 94	V0

Technical data			
I <sub>max</sub> [A]	U <sub>max</sub> [V]	max. Ø [mm <sup>2</sup> ]	AWG
24	400 <sup>1)</sup>	0.5 - 2.5	20 - 14
IEC	UL/CUL	CSA	IEC/EN 60079-7
IEC	UL/CUL	CSA	IEC/EN 60079-7
solid	stranded	ferrule with/without plastic sleeve	
1 conductor	0.5 - 2.5	-	-
<b>General data</b>			
Tightening torque: test socket screw	[Nm] 0.5 - 0.6		
Insulating material	PA		
Inflammability class according to UL 94	V0		

Description	Color
<b>Test plug, with twist grip, 4-pos.</b>	gray
5-pos.	gray
9-pos.	gray
10-pos.	gray
12-pos.	gray
14 pos.	gray
15-pos.	gray
17-pos.	gray
19 pos.	gray
20 pos.	gray
21 pos.	gray
22 pos.	gray
25 pos.	gray
<b>Test plug, with standard grip, 4-pos.</b>	gray
5-pos.	gray
9-pos.	gray
10-pos.	gray
12-pos.	gray
14 pos.	gray
15-pos.	gray
17-pos.	gray
19 pos.	gray
20 pos.	gray
21 pos.	gray
22 pos.	gray
25 pos.	gray

Ordering data		
Type	Order No.	Pcs. / Pkt.
FTPR-2/4	3001681	1
FTPR-2/5	3001683	1
FTPR-2/9	3001687	1
FTPR-2/10	3001688	1
FTPR-2/12	3001690	1
FTPR-2/14	3001692	1
FTPR-2/15	3001693	1
FTPR-2/17	3001696	1
FTPR-2/19	3001698	1
FTPR-2/20	3001699	1
FTPR-2/21	3001700	1
FTPR-2/22	3001701	1
FTPR-2/25	3001704	1
FTP-2/4	3001706	1
FTP-2/5	3001707	1
FTP-2/9	3001711	1
FTP-2/10	3001712	1
FTP-2/12	3001714	1
FTP-2/14	3001716	1
FTP-2/15	3001717	1
FTP-2/17	3001720	1
FTP-2/19	3001723	1
FTP-2/20	3001724	1
FTP-2/21	3001725	1
FTP-2/22	3001726	1
FTP-2/25	3001729	1

<b>Fork-type cable lug</b> , insulated according to UL	red
	blue
<b>Ring cable lug</b> , insulated according to UL	red
	blue

Accessories		
Accessories	Order No.	Pcs.
C-FCI 1,5/M3	3240032	100
C-FCI 2,5/M3	3240037	100
C-RCI 1,5/M3	3240016	100
C-RCI 2,5/M3	3240021	100

<b>Marking</b>	UC-TM 8, UCT-TM 8, ZB 8 or TMT (EX9,5)R (see Catalog 5)
----------------	---

**Ordering example: configurable test plug with twist grip function**

To ensure that your order is correct, you need a defined view of how everything is counted. This is achieved when the status window in the top view is on the left-hand side. Position 1 is then on the left.

Each position of a test plug is described by a contact tab feature that is selected. The following features are possible:

- S** Short contact tab, gray
- M** Medium contact tab, gray
- L** Long contact tab, gray
- LGN** Long contact tab, green
- N** No contact tab, gray

Each position with a contact tab is supplied fitted with two gray test sockets.

**Ordering example:**  
A 15-pos. test plug with twist grip needs to be configured as follows:

- Pos. 1 Short contact tab, gray
- Pos. 2 Short contact tab, gray
- Pos. 3 Short contact tab, gray
- Pos. 4 Short contact tab, gray
- Pos. 5 Short contact tab, gray
- Pos. 6 Short contact tab, gray
- Pos. 7 Short contact tab, gray
- Pos. 8 No contact tab, gray
- Pos. 9 No contact tab, gray
- Pos. 10 Medium contact tab, gray
- Pos. 11 Medium contact tab, gray
- Pos. 12 Medium contact tab, gray
- Pos. 13 Medium contact tab, gray
- Pos. 14 Long contact tab, green
- Pos. 15 Long contact tab, green

**The order data for this ordering example is therefore:**

Order No.	Pos. 1	Pos. 2	Pos. 3	Pos. 4	Pos. 5	Pos. 6	Pos. 7	Pos. 8	Pos. 9	Pos. 10	Pos. 11	Pos. 12	Pos. 13	Pos. 14	Pos. 15
3001693	/S	/S	/S	/S	/S	/S	/S	/N	/N	/M	/M	/M	/M	/LGN	/LGN

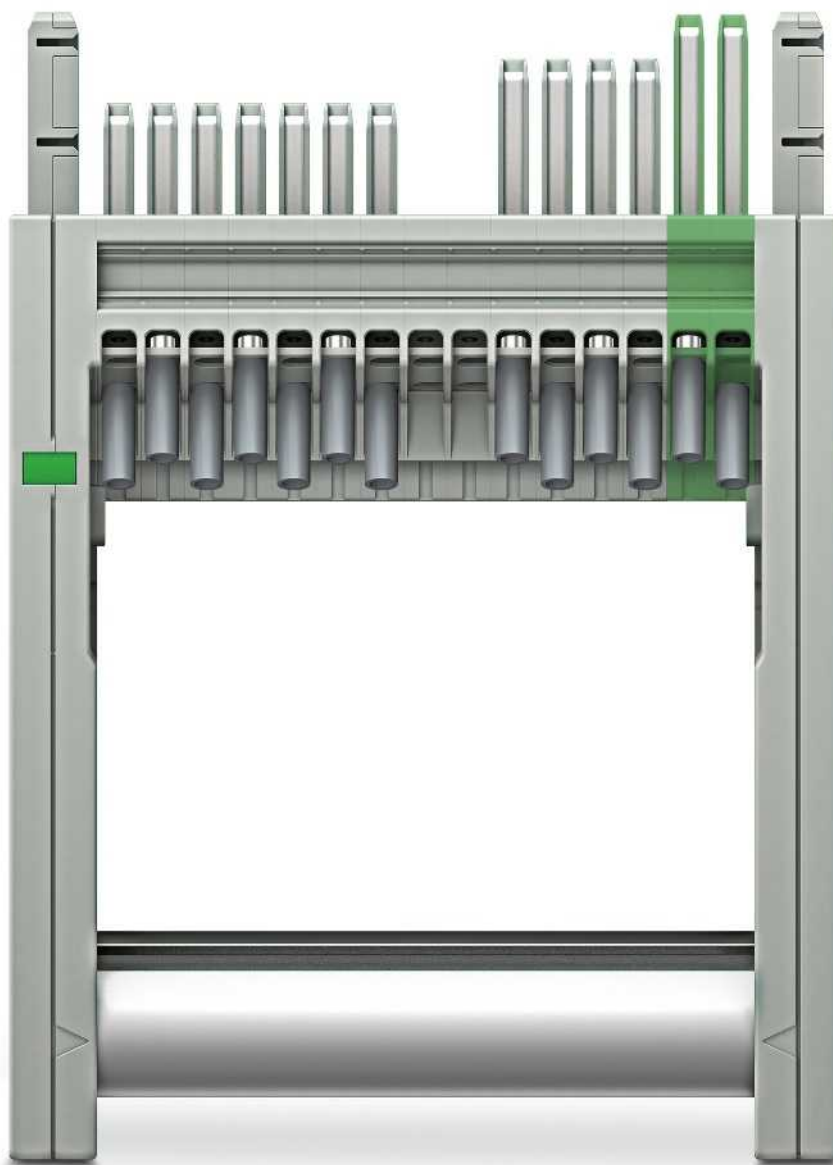

## FAME plug-in test system

### Blind plug, multi-position, sealable FBP-2/...

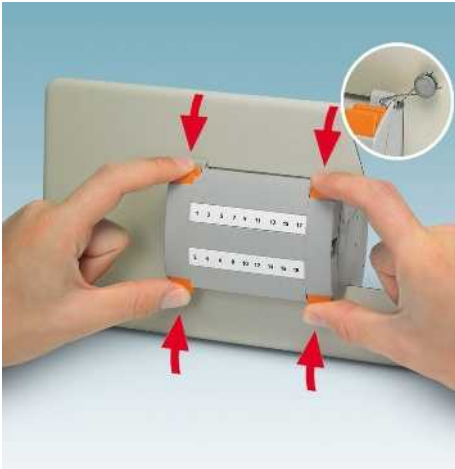

During normal operation, the blind plug acts as a protective cover for the test terminal strip and is characterized by:

- Secure latching on the test terminal strip
- The robust latching can only be released with two-hand operation
- The optional seal protects against unauthorized actuation
- Large-surface marking options
- The coding profile set can be used to assign test terminal strips and blind plugs according to the specific application, see right-hand page



Blind plug 4 ... 25-pos.

General data	
Insulating material	PA
Inflammability class according to UL 94	V0

Technical data	
Insulating material	PA
Inflammability class according to UL 94	V0

Description	Color
<b>Blind plug, 4-pos.</b>	gray
5-pos.	gray
9-pos.	gray
10-pos.	gray
12-pos.	gray
14 pos.	gray
15-pos.	gray
17-pos.	gray
19 pos.	gray
20 pos.	gray
21 pos.	gray
22 pos.	gray
25 pos.	gray

Ordering data		
Type	Order No.	Pcs. / Pkt.
FBP-2/4	3069875	1
FBP-2/5	3069876	1
FBP-2/9	3069880	1
FBP-2/10	3069881	1
FBP-2/12	3069883	1
FBP-2/14	3069885	1
FBP-2/15	3069886	1
FBP-2/17	3069888	1
FBP-2/19	3069890	1
FBP-2/20	3069891	1
FBP-2/21	3069892	1
FBP-2/22	3069893	1
FBP-2/25	3069896	1

Lateral groove labeling
-------------------------

Accessories
UC-TM 8, UCT-TM 8, ZB 8 or TMT (EX9,5)R (see Catalog 5)

PC-...-TRI coding profile set



- The coding profile set can be used to assign test terminal strips and test plugs according to the specific application
- Maximum safety is therefore ensured for all testing tasks

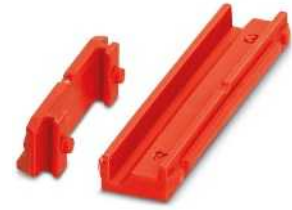

General data

Material  
Inflammability class according to UL 94

Technical data

PA  
V0

Ordering data

Description	Color
Coding profile set, for the test terminal strip	red
Coding profile set, for FTP-2 and FTPR-2 test plugs and FBP-2 blind plugs	red

Type	Order No.	Pcs. / Pkt.
PC-UTWE-TRI	3069897	50
PC-FTP-TRI	3069898	50

Colored PSBJ ... test sockets

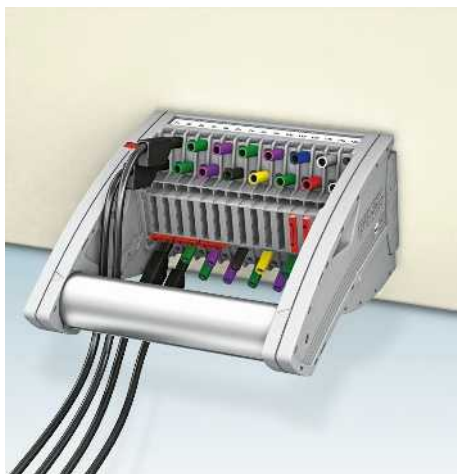

- 4 mm safety test leads with fixed insulation according to EN 61010-031 CAT III and CAT IV up to 1000 V can be coded in true color
- Additional test leads, assembled with ring and fork-type cable lugs (see accessories, e.g., page 96) can be attached with test sockets



Description	Color
Test socket, insulated	transparent
	red
	blue
	yellow
	green
	violet
	black
	gray
	brown

Ordering data

Type	Order No.	Pcs. / Pkt.
PSBJ-URTK 6 FARBLOS	3026450	10
PSBJ-URTK 6 RD	3026719	10
PSBJ-URTK 6 BU	3026434	10
PSBJ-URTK 6 YE	3026405	10
PSBJ-URTK 6 GN	3026418	10
PSBJ-URTK 6 VT	3026421	10
PSBJ-URTK 6 BK	3026447	10
PSBJ-URTK 6 GY	3026612	10
PSBJ-URTK 6 BN	3026971	10

# Modular terminal blocks

## FAME plug-in test system

### Jumper, red, 8.2 mm pitch, FBS ...

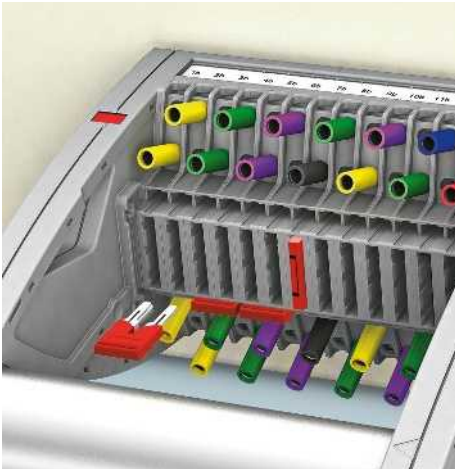

– The FBS ...-8 plug-in bridges are used for short-circuiting, as star-point jumpers, and also to establish grounding in connection with a PE modular terminal block on the terminal strip



		Ordering data			
Description	No. of pos.	Type	I <sub>max</sub>	Order No.	Pcs. / Pkt.
<b>Jumper</b>	2	FBS 2-8	41 A	3030284	10
	3	FBS 3-8		3030297	10
	4	FBS 4-8		3030307	10
	5	FBS 5-8		3030310	10
	6	FBS 6-8		3032470	10
	10	FBS 10-8		3030323	10
<b>Jumper</b>	16	FBSR 16-8	32 A	3033816	10

### Jumper with extraction tool, red, 8.2 mm pitch, FBSRH ...

– The FBSRH ...-8 bridges have a molded extraction tool which means that they can be used conveniently and without tools for individual bridging tasks. This enables a transformer short circuit to be created in test disconnect terminal blocks, for example.



		Ordering data			
Description	No. of pos.	Type	I <sub>max</sub>	Order No.	Pcs. / Pkt.
<b>Jumper, with extraction tool</b>	2	FBSRH 2-8	32 A	3033802	10
	3	FBSRH 3-8		3033803	10
	4	FBSRH 4-8		3033804	10

**Pre-assembled bridge, red, 8.2 mm pitch**

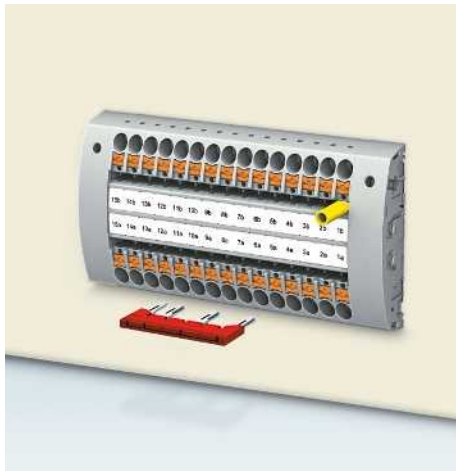

- Plug-in star-point jumpers or jumpers for bridging several positions can be supplied pre-configured without additional expense
- The bridges are printed and provide unique identification for bridging between non-adjacent terminal blocks



Description	No. of pos.
<b>Pre-assembled bridge, labeled</b>	
3-pos., positions 1, 3	3
4-pos., positions 1, 4	4
5-pos., positions 1, 3, 5	5
10-pos., positions 1, 4, 7, 10	10

Ordering data					
Type	I <sub>max</sub>	Order No.	Pcs. / Pkt.		
<b>FBS 1/3-8</b>	41 A	<b>3032363</b>	10		
<b>FBS 1/4-8</b>		<b>3032376</b>	10		
<b>FBS 1/3/5-8</b>		<b>3032389</b>	10		
<b>FBS 1/4/7/10-8</b>		<b>3032402</b>	10		

**Cover profiles for test plug or test terminal strip mounted on DIN rail**



- The AP-FTP cover profile prevents undesired changes to the star point, feed-through, and short-circuit jumpers on the completely assembled test plug
- To mount, gently release the side screw connection of the plug and snap the profile into place
- The APH-ME end bracket is used in conjunction with the AP-ME cover for the DIN rail mounted test terminal strip



General data	
Material	PVC

Technical data			
----------------	--	--	--

Description	Color
<b>Cover profile</b> , supply length 1 m	transparent
<b>Cover profile</b> , supply length 1 m	transparent
<b>Cover profile</b> , supply length 1 m	transparent
<b>End brackets</b> , for AP-ME cover profile, sealable, with storage option for jumpers	gray
<b>Cover profile holder</b> , can be snapped on and sealed	gray

Ordering data				
Type		Order No.	Pcs. / Pkt.	
<b>AP-FTP</b>	METER	<b>3069899</b>	1	
<b>AP-ME</b>	METER	<b>3034361</b>	10	
<b>AP RSC-T</b>		<b>3059139</b>	10	
<b>APH-ME</b>		<b>3034374</b>	10	
<b>APH-UTWE 6-2</b>		<b>3069057</b>	10	

## FAME plug-in test system

### Test terminal strip with PT ... push-in connection, VDE type A7, for wall and DIN rail mounting

The **VDE A7** version described here is suitable as a plug-in test system in single-system current, voltage, and power relays, wattmetric and ground fault wiper relays, detuning level controllers or reverse power protection for generators.

- The test plugs are assembled with jumpers and contact tab lengths according to the circuit diagram
- A transparent covering hood protects the jumpers. The covering hood can only be removed by dismantling the test plug
- All VDE-specified 7, 14, and 19-pos. versions are supplied with exclusive coding for the matching test plug and blind plug
- The components are supplied pre-marked according to the VDE Directive
- Test signals can be connected with touch-proof safety test leads (CAT III and IV/1000 V according to EN 61010-031)
- The test plugs are equipped with two gray test sockets per position, for further color versions, see the range of accessories
- Additional test leads, assembled with ring and fork-type cable lugs, can be attached with test sockets
- Other VDE versions available on request

Notes:
To create panel cutouts, see <a href="http://phoenixcontact.net/products">phoenixcontact.net/products</a> .
1) Derating curve available on request.
2) Rated surge voltage of 5 kV.

Long contacts  
Short contacts

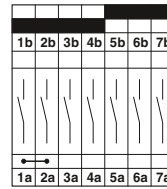

A7



6 (10) mm<sup>2</sup>, 30 A, test terminal strip, for wall mounting, VDE coded type A7

Max. electrical data	
<b>Rated data</b>	
Rated voltage	[V] 400 <sup>2)</sup>
Nominal current / cross section	[A] / [mm <sup>2</sup> ] 24 <sup>1)</sup> /6
Rated cross section	[mm <sup>2</sup> ] 6
Cross section range	AWG 20 - 8
<b>Connection capacity</b>	
1 conductor	[mm <sup>2</sup> ] 0.5 - 10
2 stranded conductors with a TWIN ferrule	[mm <sup>2</sup> ] 0.5 - 6
Plug-in connection cross sections	[mm <sup>2</sup> ] 1 - 10
<b>General data</b>	
Stripping length	[mm] 12
Tightening torque for wall fastening	[Nm] 0.8 - 1
Panel thickness	[mm] 1 - 4
Tightening torque: test socket screw	[Nm] -
Insulating material	PA
Inflammability class according to UL 94	V0

Technical data			
$I_{max}$ [A]	$U_{max}$ [V]	max. Ø [mm <sup>2</sup> ]	AWG
30	400 <sup>2)</sup>	0.5 - 10	20 - 8
IEC 60947-7-1			
IEC	UL/CUL	CSA	IEC/EN 60079-7
<b>Connection capacity</b>			
solid		stranded	
0.5 - 10		0.5 - 6	
		ferrule	
		with/without plastic sleeve	
		0.5 - 6	
		0.5 - 1.5	
1 - 10		1 - 6	
		1 - 6	

Description	Color
Test terminal strip, for wall mounting	gray
Test terminal strip, for mounting on NS 35...	gray
Test plug, with twist grip	gray
With standard handle	gray
Test plug, 1-pos., with cover	gray
Blind plug, sealable	gray

Ordering data		
Type	Order No.	Pcs. / Pkt.
PTWE 6-2/A7	3069436	1

Test socket, insulated	transparent
	red
	blue
	yellow
	green
	violet
	black
	gray
	brown
Cover profile, supply length 1 m	transparent
Cover profile holder, can be snapped on and sealed	gray
Cover profile, supply length 1 m	transparent
End brackets, for AP-ME cover profile, sealable, with storage option for jumpers	gray
Holder, for AP-ME cover profile	gray
Fork-type cable lug, insulated according to UL	red
	blue
Ring cable lug, insulated according to UL	red
	blue
Screwdriver	SF-SL 0,8X4,0-100
Lateral groove labeling	UC-TM 8, UCT-TM 8, ZB 8 or TMT (EX9,5)R (see Catalog 5)

Accessories		
AP RSC-T	3059139	10
APH-UTWE 6-2	3069057	10
SF-SL 0,8X4,0-100	1212551	10
UC-TM 8, UCT-TM 8, ZB 8 or TMT (EX9,5)R (see Catalog 5)		





6 (10) mm<sup>2</sup>, 30 A, test terminal strip, for DIN rail mounting, VDE coded type A7



24 A, test plug, bridge assignment according to circuit diagram, VDE coded type A7



Blind plug, VDE coded type A7

Technical data			
I <sub>max</sub> [A]	U <sub>max</sub> [V]	max. Ø [mm <sup>2</sup> ]	AWG
30	400 <sup>2)</sup>	0.5 - 10	20 - 8
IEC 60947-7-1			
IEC	UL/CUL	CSA	IEC/EN 60079-7
400 <sup>2)</sup>	-	-	-
24 <sup>1)</sup> /6	-	-	-
6	-	-	-
20 - 8	-	-	-
solid	stranded	ferrule with/without plastic sleeve	
0.5 - 10	0.5 - 6	0.5 - 6	0.5 - 6 0.5 - 1.5
1 - 10	-	1 - 6	1 - 6
12	-	-	-
-	-	-	-
-	-	-	-
-	-	-	-
PA	-	-	-
V0	-	-	-

Technical data			
I <sub>max</sub> [A]	U <sub>max</sub> [V]	max. Ø [mm <sup>2</sup> ]	AWG
24	400 <sup>2)</sup>	0.5 - 2.5	20 - 14
IEC			
UL/CUL	CSA	IEC/EN 60079-7	
400 <sup>2)</sup>	-	-	-
24/2.5	-	-	-
6	-	-	-
20 - 14	-	-	-
solid	stranded	ferrule with/without plastic sleeve	
-	0.5 - 2.5	-	-
-	-	-	-
-	-	-	-
0.5 - 0.6	-	-	-
PA	-	-	-
V0	-	-	-

Technical data			
		max. Ø [mm <sup>2</sup> ]	AWG
-	-	-	-
IEC			
UL/CUL	CSA	IEC/EN 60079-7	
-	-	-	-
-	-	-	-
-	-	-	-
-	-	-	-
solid	stranded	ferrule with/without plastic sleeve	
-	-	-	-
-	-	-	-
-	-	-	-
PA	-	-	-
V0	-	-	-

Ordering data		
Type	Order No.	Pcs. / Pkt.
PTRE 6-2/A7	3069449	1

Ordering data		
Type	Order No.	Pcs. / Pkt.
FTPR-2/A7	3069484	1
FTP-2/A7	3069470	1
FTP-2/1	3069469	1

Ordering data		
Type	Order No.	Pcs. / Pkt.
FBP-2/A7	3069497	1

Accessories			
AP-ME	METER	3034361	10
APH-ME		3034374	10
APT-ME		3034358	10
SF-SL 0,8X4,0-100		1212551	10

Accessories			
PSBJ-URTK 6 FARBLOS		3026450	10
PSBJ-URTK 6 RD		3026719	10
PSBJ-URTK 6 BU		3026434	10
PSBJ-URTK 6 YE		3026405	10
PSBJ-URTK 6 GN		3026418	10
PSBJ-URTK 6 VT		3026421	10
PSBJ-URTK 6 BK		3026447	10
PSBJ-URTK 6 GY		3026612	10
PSBJ-URTK 6 BN		3026971	10
C-FCI 1,5/M3		3240032	100
C-FCI 2,5/M3		3240037	100
C-RCI 1,5/M3		3240016	100
C-RCI 2,5/M3		3240021	100

Accessories			
UC-TM 8, UCT-TM 8, ZB 8 or TMT (EX9,5)R			

UC-TM 8, UCT-TM 8, ZB 8 or TMT (EX9,5)R (see Catalog 5)

UC-TM 8, UCT-TM 8, ZB 8 or TMT (EX9,5)R (see Catalog 5)

UC-TM 8, UCT-TM 8, ZB 8 or TMT (EX9,5)R (see Catalog 5)

## FAME plug-in test system

### Test terminal strip with PT ... push-in connection, VDE type B7, for wall and DIN rail mounting

The **VDE B7** version described here is suitable as a plug-in test system in digital differential protection as an addition to the F19 plug-in test system, see page 120.

- The test plugs are assembled with jumpers and contact tab lengths according to the circuit diagram
- A transparent covering hood protects the jumpers. The covering hood can only be removed by dismantling the test plug
- All VDE-specified 7, 14, and 19-pos. versions are supplied with exclusive coding for the matching test plug and blind plug
- The components are supplied pre-marked according to the VDE Directive
- Test signals can be connected with touch-proof safety test leads (CAT III and IV/1000 V according to EN 61010-031)
- The test plugs are equipped with two gray test sockets per position, for further color versions, see the range of accessories
- Additional test leads, assembled with ring and fork-type cable lugs, can be attached with test sockets
- Other VDE versions available on request

Notes:
To create panel cutouts, see <a href="http://phoenixcontact.net/products">phoenixcontact.net/products</a> .
<sup>1)</sup> Derating curve available on request.
<sup>2)</sup> Rated surge voltage of 5 kV.

Long contacts  
Short contacts

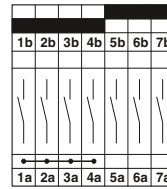

**6 (10) mm<sup>2</sup>, 30 A, test terminal strip, for wall mounting, VDE coded type B7**

Max. electrical data	
<b>Rated data</b>	
Rated voltage	[V] 400 <sup>2)</sup>
Nominal current / cross section	[A] / [mm <sup>2</sup> ] 24 <sup>1)</sup> /6
Rated cross section	[mm <sup>2</sup> ] 6
Cross section range	AWG 20 - 8
<b>Connection capacity</b>	
1 conductor	[mm <sup>2</sup> ] 0.5 - 10
2 stranded conductors with a TWIN ferrule	[mm <sup>2</sup> ] 0.5 - 6
Plug-in connection cross sections	[mm <sup>2</sup> ] 1 - 10
<b>General data</b>	
Stripping length	[mm] 12
Tightening torque for wall fastening	[Nm] 0.8 - 1
Panel thickness	[mm] 1 - 4
Tightening torque: test socket screw	[Nm] -
Insulating material	PA
Inflammability class according to UL 94	V0

Technical data			
$I_{max}$ [A]	$U_{max}$ [V]	max. Ø [mm <sup>2</sup> ]	AWG
<b>30</b>	<b>400<sup>2)</sup></b>	<b>0.5 - 10</b>	<b>20 - 8</b>
IEC 60947-7-1			
IEC	UL/CUL	CSA	IEC/EN 60079-7
<b>Connection capacity</b>			
solid		stranded	
0.5 - 10		0.5 - 6	
		ferrule	
		with/without plastic sleeve	
		0.5 - 6	
		0.5 - 1.5	
1 - 10		1 - 6	
		1 - 6	
<b>General data</b>			
Stripping length		[mm] 12	
Tightening torque for wall fastening		[Nm] 0.8 - 1	
Panel thickness		[mm] 1 - 4	
Tightening torque: test socket screw		[Nm] -	
Insulating material		PA	
Inflammability class according to UL 94		V0	

Description	Color
<b>Test terminal strip</b> , for wall mounting	gray
<b>Test terminal strip</b> , for mounting on NS 35...	gray
<b>Test plug</b> , with twist grip	gray
With standard handle	gray
<b>Test plug</b> , 1-pos., with cover	gray
<b>Blind plug</b> , sealable	gray

<b>Test socket</b> , insulated	transparent
	red
	blue
	yellow
	green
	violet
	black
	gray
	brown
<b>Cover profile</b> , supply length 1 m	transparent
<b>Cover profile holder</b> , can be snapped on and sealed	gray
<b>Cover profile</b> , supply length 1 m	transparent
<b>End brackets</b> , for AP-ME cover profile, sealable, with storage option for jumpers	gray
<b>Holder</b> , for AP-ME cover profile	gray
<b>Fork-type cable lug</b> , insulated according to UL	red
	blue
<b>Ring cable lug</b> , insulated according to UL	red
	blue

<b>Screwdriver</b>	SF-SL 0,8X4,0-100
<b>Lateral groove labeling</b>	UC-TM 8, UCT-TM 8, ZB 8 or TMT (EX9,5)R (see Catalog 5)

Ordering data		
Type	Order No.	Pcs. / Pkt.
<b>PTWE 6-2/B7</b>	<b>3069437</b>	<b>1</b>

Accessories		
<b>AP RSC-T</b>	<b>3059139</b>	<b>10</b>
<b>APH-UTWE 6-2</b>	<b>3069057</b>	<b>10</b>
<b>SF-SL 0,8X4,0-100</b>	<b>1212551</b>	<b>10</b>
<b>UC-TM 8, UCT-TM 8, ZB 8 or TMT (EX9,5)R</b> (see Catalog 5)		



6 (10) mm<sup>2</sup>, 30 A, test terminal strip, for DIN rail mounting, VDE coded type B7



24 A, test plug, bridge assignment according to circuit diagram, VDE coded type B7



Blind plug, VDE coded type B7

Technical data			
I <sub>max</sub> [A]	U <sub>max</sub> [V]	max. Ø [mm <sup>2</sup> ]	AWG
30	400 <sup>2)</sup>	0.5 - 10	20 - 8
IEC 60947-7-1			
IEC	UL/CUL	CSA	IEC/EN 60079-7
400 <sup>2)</sup>	-	-	-
24 <sup>1)</sup> /6	-	-	-
6	-	-	-
20 - 8	-	-	-
solid	stranded	ferrule with/without plastic sleeve	
0.5 - 10	0.5 - 6	0.5 - 6	0.5 - 6 0.5 - 1.5
1 - 10	-	1 - 6	1 - 6
12	-	-	-
-	-	-	-
-	-	-	-
-	-	-	-
PA	-	-	-
V0	-	-	-

Technical data			
I <sub>max</sub> [A]	U <sub>max</sub> [V]	max. Ø [mm <sup>2</sup> ]	AWG
24	400 <sup>2)</sup>	0.5 - 2.5	20 - 14
IEC			
UL/CUL	CSA	IEC/EN 60079-7	
400 <sup>2)</sup>	-	-	-
24/2.5	-	-	-
6	-	-	-
20 - 14	-	-	-
solid	stranded	ferrule with/without plastic sleeve	
-	0.5 - 2.5	-	-
-	-	-	-
-	-	-	-
0.5 - 0.6	-	-	-
PA	-	-	-
V0	-	-	-

Technical data			
		max. Ø [mm <sup>2</sup> ]	AWG
-	-	-	-
IEC			
UL/CUL	CSA	IEC/EN 60079-7	
-	-	-	-
-	-	-	-
-	-	-	-
-	-	-	-
solid	stranded	ferrule with/without plastic sleeve	
-	-	-	-
-	-	-	-
-	-	-	-
PA	-	-	-
V0	-	-	-

Ordering data		
Type	Order No.	Pcs. / Pkt.
PTRE 6-2/B7	3069450	1

Ordering data		
Type	Order No.	Pcs. / Pkt.
FTPR-2/B7	3069485	1
FTP-2/B7	3069471	1
FTP-2/1	3069469	1

Ordering data		
Type	Order No.	Pcs. / Pkt.
FBP-2/B7	3069498	1

Accessories			
AP-ME	METER	3034361	10
APH-ME		3034374	10
APT-ME		3034358	10
SF-SL	0,8X4,0-100	1212551	10

Accessories			
PSBJ-URTK 6 FARBLOS		3026450	10
PSBJ-URTK 6 RD		3026719	10
PSBJ-URTK 6 BU		3026434	10
PSBJ-URTK 6 YE		3026405	10
PSBJ-URTK 6 GN		3026418	10
PSBJ-URTK 6 VT		3026421	10
PSBJ-URTK 6 BK		3026447	10
PSBJ-URTK 6 GY		3026612	10
PSBJ-URTK 6 BN		3026971	10
C-FCI 1,5/M3		3240032	100
C-FCI 2,5/M3		3240037	100
C-RCI 1,5/M3		3240016	100
C-RCI 2,5/M3		3240021	100

Accessories			
UC-TM 8, UCT-TM 8, ZB 8 or TMT (EX9,5)R			

UC-TM 8, UCT-TM 8, ZB 8 or TMT (EX9,5)R (see Catalog 5)

UC-TM 8, UCT-TM 8, ZB 8 or TMT (EX9,5)R (see Catalog 5)

UC-TM 8, UCT-TM 8, ZB 8 or TMT (EX9,5)R (see Catalog 5)

## FAME plug-in test system

### Test terminal strip with PT ... push-in connection, VDE type E7, for wall and DIN rail mounting

The **VDE E7** version described here is suitable as a plug-in test system for single-stage automatic frequency load shedding (AFLS) and as rotor ground fault protection.

- The test plugs are assembled according to the circuit diagram
- A transparent covering hood protects the jumpers. The covering hood can only be removed by dismantling the test plug
- All VDE-specified 7, 14, and 19-pos. versions are supplied with exclusive coding for the matching test plug and blind plug
- The components are supplied pre-marked according to the VDE Directive
- Test signals can be connected with touch-proof safety test leads (CAT III and IV/1000 V according to EN 61010-031)
- The test plugs are equipped with two gray test sockets per position, for further color versions, see the range of accessories
- Additional test leads, assembled with ring and fork-type cable lugs, can be attached with test sockets
- Other VDE versions available on request

Notes:	
To create panel cutouts, see <a href="http://phoenixcontact.net/products">phoenixcontact.net/products</a> .	
1) Derating curve available on request.	
2) Rated surge voltage of 5 kV.	

Long contacts  
Short contacts

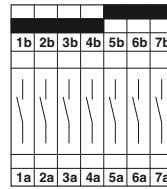

E7



6 (10) mm<sup>2</sup>, 30 A, test terminal strip, for wall mounting, VDE coded type E7

Max. electrical data	
<b>Rated data</b>	
Rated voltage	[V] 400 <sup>2)</sup>
Nominal current / cross section	[A] / [mm <sup>2</sup> ] 24 <sup>1)</sup> /6
Rated cross section	[mm <sup>2</sup> ] 6
Cross section range	AWG 20 - 8
Connection capacity	
1 conductor	[mm <sup>2</sup> ] 0.5 - 10
2 stranded conductors with a TWIN ferrule	[mm <sup>2</sup> ] 0.5 - 6
Plug-in connection cross sections	[mm <sup>2</sup> ] 1 - 10
General data	
Stripping length	[mm] 12
Tightening torque for wall fastening	[Nm] 0.8 - 1
Panel thickness	[mm] 1 - 4
Tightening torque: test socket screw	[Nm] -
Insulating material	PA
Inflammability class according to UL 94	V0

Technical data			
$I_{max}$ [A]	$U_{max}$ [V]	max. Ø [mm <sup>2</sup> ]	AWG
30	400 <sup>2)</sup>	0.5 - 10	20 - 8
IEC 60947-7-1			
IEC	UL/CUL	CSA	IEC/EN 60079-7
solid		stranded	
		ferrule	
		with/without plastic sleeve	
0.5 - 10	0.5 - 6	0.5 - 6	0.5 - 6
		1 - 4	0.5 - 1.5
1 - 10	-	1 - 6	1 - 6

Description	Color
<b>Test terminal strip</b> , for wall mounting	gray
<b>Test terminal strip</b> , for mounting on NS 35...	gray
<b>Test plug</b> , with twist grip	gray
With standard handle	gray
<b>Test plug</b> , 1-pos., with cover	gray
<b>Blind plug</b> , sealable	gray

<b>Test socket</b> , insulated	transparent
	red
	blue
	yellow
	green
	violet
	black
	gray
	brown
<b>Cover profile</b> , supply length 1 m	transparent
<b>Cover profile holder</b> , can be snapped on and sealed	gray
<b>Cover profile</b> , supply length 1 m	transparent
<b>End brackets</b> , for AP-ME cover profile, sealable, with storage option for jumpers	gray
<b>Holder</b> , for AP-ME cover profile	gray
<b>Fork-type cable lug</b> , insulated according to UL	red
	blue
<b>Ring cable lug</b> , insulated according to UL	red
	blue
<b>Screwdriver</b>	SF-SL 0,8X4,0-100
<b>Lateral groove labeling</b>	UC-TM 8, UCT-TM 8, ZB 8 or TMT (EX9,5)R (see Catalog 5)

Ordering data		
Type	Order No.	Pcs. / Pkt.
<b>PTWE 6-2/E7</b>	3069438	1

Accessories		
<b>AP RSC-T</b>	3059139	10
<b>APH-UTWE 6-2</b>	3069057	10
<b>SF-SL 0,8X4,0-100</b>	1212551	10
<b>UC-TM 8, UCT-TM 8, ZB 8 or TMT (EX9,5)R (see Catalog 5)</b>		



6 (10) mm<sup>2</sup>, 30 A, test terminal strip, for DIN rail mounting, VDE coded type E7



24 A, test plug, bridge assignment according to circuit diagram, VDE coded type E7



Blind plug, VDE coded type E7

Technical data			
I <sub>max</sub> [A]	U <sub>max</sub> [V]	max. Ø [mm <sup>2</sup> ]	AWG
30	400 <sup>2)</sup>	0.5 - 10	20 - 8
IEC 60947-7-1			
IEC	UL/CUL	CSA	IEC/EN 60079-7
400 <sup>2)</sup>	-	-	-
24 <sup>1)</sup> /6	-	-	-
6	-	-	-
20 - 8	-	-	-
solid	stranded	ferrule with/without plastic sleeve	
0.5 - 10	0.5 - 6	0.5 - 6	0.5 - 6 0.5 - 1.5
1 - 10	-	1 - 6	1 - 6
12	-	-	-
-	-	-	-
-	-	-	-
-	-	-	-
PA	-	-	-
V0	-	-	-

Technical data			
I <sub>max</sub> [A]	U <sub>max</sub> [V]	max. Ø [mm <sup>2</sup> ]	AWG
24	400 <sup>2)</sup>	0.5 - 2.5	20 - 14
IEC			
UL/CUL	CSA	IEC/EN 60079-7	
400 <sup>2)</sup>	-	-	-
24/2.5	-	-	-
6	-	-	-
20 - 14	-	-	-
solid	stranded	ferrule with/without plastic sleeve	
-	0.5 - 2.5	-	-
-	-	-	-
-	-	-	-
0.5 - 0.6	-	-	-
PA	-	-	-
V0	-	-	-

Technical data			
		max. Ø [mm <sup>2</sup> ]	AWG
		-	-
IEC			
UL/CUL	CSA	IEC/EN 60079-7	
-	-	-	-
-	-	-	-
-	-	-	-
-	-	-	-
solid	stranded	ferrule with/without plastic sleeve	
-	-	-	-
-	-	-	-
-	-	-	-
PA	-	-	-
V0	-	-	-

Ordering data		
Type	Order No.	Pcs. / Pkt.
PTRE 6-2/E7	3069451	1
FTPR-2/E7	3069486	1
FTP-2/E7	3069472	1
FTP-2/1	3069469	1
FBP-2/E7	3069499	1

Ordering data		
Type	Order No.	Pcs. / Pkt.
FTPR-2/E7	3069486	1
FTP-2/E7	3069472	1
FTP-2/1	3069469	1

Ordering data		
Type	Order No.	Pcs. / Pkt.
FBP-2/E7	3069499	1

Accessories			
AP-ME	METER	3034361	10
APH-ME		3034374	10
APT-ME		3034358	10
SF-SL 0,8X4,0-100		1212551	10

Accessories			
PSBJ-URTK 6 FARBLOS		3026450	10
PSBJ-URTK 6 RD		3026719	10
PSBJ-URTK 6 BU		3026434	10
PSBJ-URTK 6 YE		3026405	10
PSBJ-URTK 6 GN		3026418	10
PSBJ-URTK 6 VT		3026421	10
PSBJ-URTK 6 BK		3026447	10
PSBJ-URTK 6 GY		3026612	10
PSBJ-URTK 6 BN		3026971	10
C-FCI 1,5/M3		3240032	100
C-FCI 2,5/M3		3240037	100
C-RCI 1,5/M3		3240016	100
C-RCI 2,5/M3		3240021	100

Accessories			
UC-TM 8, UCT-TM 8, ZB 8 or TMT (EX9,5)R			

UC-TM 8, UCT-TM 8, ZB 8 or TMT (EX9,5)R (see Catalog 5)

UC-TM 8, UCT-TM 8, ZB 8 or TMT (EX9,5)R (see Catalog 5)

UC-TM 8, UCT-TM 8, ZB 8 or TMT (EX9,5)R (see Catalog 5)

## FAME plug-in test system

### Test terminal strip with PT ... push-in connection, VDE type A14, for wall and DIN rail mounting

The **VDE A14** version described here is suitable as a plug-in test system for three-stage automatic frequency load shedding (AFLS), as zero-power comparison protection, and as stator and rotor ground fault protection.

- The test plugs are assembled according to the circuit diagram
- A transparent covering hood protects the jumpers. The covering hood can only be removed by dismantling the test plug
- All VDE-specified 7, 14, and 19-pos. versions are supplied with exclusive coding for the matching test plug and blind plug
- The components are supplied pre-marked according to the VDE Directive
- Test signals can be connected with touch-proof safety test leads (CAT III and IV/1000 V according to EN 61010-031)
- The test plugs are equipped with two gray test sockets per position, for further color versions, see the range of accessories
- Additional test leads, assembled with ring and fork-type cable lugs, can be attached with test sockets
- Other VDE versions available on request

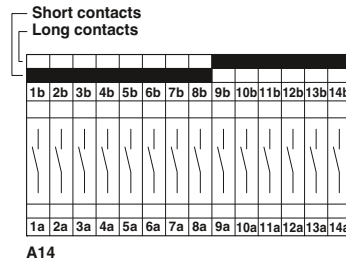

6 (10) mm<sup>2</sup>, 30 A, test terminal strip, for wall mounting, VDE coded type A14

Notes:
To create panel cutouts, see phoenixcontact.net/products.
<sup>1)</sup> Derating curve available on request.
<sup>2)</sup> Rated surge voltage of 5 kV.

Max. electrical data	
<b>Rated data</b>	
Rated voltage	[V] 400 <sup>2)</sup>
Nominal current / cross section	[A] / [mm <sup>2</sup> ] 24 <sup>1)</sup> /6
Rated cross section	[mm <sup>2</sup> ] 6
Cross section range	AWG 20 - 8
Connection capacity	
1 conductor	[mm <sup>2</sup> ] 0.5 - 10
2 stranded conductors with a TWIN ferrule	[mm <sup>2</sup> ] 0.5 - 6
Plug-in connection cross sections	[mm <sup>2</sup> ] 1 - 10
General data	
Stripping length	[mm] 12
Tightening torque for wall fastening	[Nm] 0.8 - 1
Panel thickness	[mm] 1 - 4
Tightening torque: test socket screw	[Nm] -
Insulating material	PA
Inflammability class according to UL 94	V0

Technical data			
$I_{max}$ [A]	$U_{max}$ [V]	max. $\varnothing$ [mm <sup>2</sup> ]	AWG
30	400 <sup>2)</sup>	0.5 - 10	20 - 8
IEC 60947-7-1	UL/CUL	CSA	IEC/EN 60079-7
Connection capacity		ferrule	
solid	stranded	with/without plastic sleeve	
0.5 - 10	0.5 - 6	0.5 - 6	0.5 - 6
1 - 10	-	1 - 6	1 - 6

Description	Color
Test terminal strip, for wall mounting	gray
Test terminal strip, for mounting on NS 35...	gray
Test plug, with twist grip	gray
With standard handle	gray
Test plug, 1-pos., with cover	gray
Blind plug, sealable	gray

Ordering data		
Type	Order No.	Pcs. / Pkt.
PTWE 6-2/A14	3069439	1

Test socket, insulated	transparent
	red
	blue
	yellow
	green
	violet
	black
	gray
	brown
Cover profile, supply length 1 m	transparent
Cover profile holder, can be snapped on and sealed	gray
Cover profile, supply length 1 m	transparent
End brackets, for AP-ME cover profile, sealable, with storage option for jumpers	gray
Holder, for AP-ME cover profile	gray
Fork-type cable lug, insulated according to UL	red
	blue
Ring cable lug, insulated according to UL	red
	blue
Screwdriver	SF-SL 0,8X4,0-100

Accessories		
AP RSC-T	3059139	10
APH-UTWE 6-2	3069057	10
SF-SL 0,8X4,0-100	1212551	10

Lateral groove labeling	UC-TM 8, UCT-TM 8, ZB 8 or TMT (EX9,5)R (see Catalog 5)
-------------------------	---



6 (10) mm<sup>2</sup>, 30 A, test terminal strip, for DIN rail mounting, VDE coded type A14



24 A, test plug, bridge assignment according to circuit diagram, VDE coded type A14



Blind plug, VDE coded type A14

Technical data			
I <sub>max</sub> [A]	U <sub>max</sub> [V]	max. Ø [mm <sup>2</sup> ]	AWG
30	400 <sup>2)</sup>	0.5 - 10	20 - 8
IEC 60947-7-1			
IEC	UL/CUL	CSA	IEC/EN 60079-7
400 <sup>2)</sup>	-	-	-
24 <sup>1)</sup> /6	-	-	-
6	-	-	-
20 - 8	-	-	-
solid	stranded	ferrule with/without plastic sleeve	
0.5 - 10	0.5 - 6	0.5 - 6	0.5 - 6 0.5 - 1.5
1 - 10	-	1 - 6	1 - 6
12	-	-	-
-	-	-	-
-	-	-	-
-	-	-	-
PA	-	-	-
V0	-	-	-

Technical data			
I <sub>max</sub> [A]	U <sub>max</sub> [V]	max. Ø [mm <sup>2</sup> ]	AWG
24	400 <sup>2)</sup>	0.5 - 2.5	20 - 14
IEC			
UL/CUL	CSA	IEC/EN 60079-7	
400 <sup>2)</sup>	-	-	-
24/2.5	-	-	-
6	-	-	-
20 - 14	-	-	-
solid	stranded	ferrule with/without plastic sleeve	
-	0.5 - 2.5	-	-
-	-	-	-
-	-	-	-
0.5 - 0.6	-	-	-
PA	-	-	-
V0	-	-	-

Technical data			
		max. Ø [mm <sup>2</sup> ]	AWG
		-	-
IEC			
UL/CUL	CSA	IEC/EN 60079-7	
-	-	-	-
-	-	-	-
-	-	-	-
-	-	-	-
solid	stranded	ferrule with/without plastic sleeve	
-	-	-	-
-	-	-	-
-	-	-	-
PA	-	-	-
V0	-	-	-

Ordering data		
Type	Order No.	Pcs. / Pkt.
PTRE 6-2/A14	3069452	1

Ordering data		
Type	Order No.	Pcs. / Pkt.
FTPR-2/A14	3069487	1
FTP-2/A14	3069474	1
FTP-2/1	3069469	1

Ordering data		
Type	Order No.	Pcs. / Pkt.
FBP-2/A14	3069500	1

Accessories			
AP-ME	METER	3034361	10
APH-ME		3034374	10
APT-ME		3034358	10
SF-SL	0,8X4,0-100	1212551	10

Accessories			
PSBJ-URTK 6 FARBLOS		3026450	10
PSBJ-URTK 6 RD		3026719	10
PSBJ-URTK 6 BU		3026434	10
PSBJ-URTK 6 YE		3026405	10
PSBJ-URTK 6 GN		3026418	10
PSBJ-URTK 6 VT		3026421	10
PSBJ-URTK 6 BK		3026447	10
PSBJ-URTK 6 GY		3026612	10
PSBJ-URTK 6 BN		3026971	10
C-FCI 1,5/M3		3240032	100
C-FCI 2,5/M3		3240037	100
C-RCI 1,5/M3		3240016	100
C-RCI 2,5/M3		3240021	100

Accessories			
UC-TM 8, UCT-TM 8, ZB 8 or TMT (EX9,5)R			

UC-TM 8, UCT-TM 8, ZB 8 or TMT (EX9,5)R (see Catalog 5)

UC-TM 8, UCT-TM 8, ZB 8 or TMT (EX9,5)R (see Catalog 5)

UC-TM 8, UCT-TM 8, ZB 8 or TMT (EX9,5)R (see Catalog 5)

## FAME plug-in test system

### Test terminal strip with PT ... push-in connection, VDE type B14, for wall and DIN rail mounting

The **VDE B14** version described here is suitable as a plug-in test system in overcurrent directional protection, distance protection for high and medium voltage, as well as voltage regulation.

- The test plugs are assembled with jumpers and contact tab lengths according to the circuit diagram
- A transparent covering hood protects the jumpers. The covering hood can only be removed by dismantling the test plug
- All VDE-specified 7, 14, and 19-pos. versions are supplied with exclusive coding for the matching test plug and blind plug
- The components are supplied pre-marked according to the VDE Directive
- Test signals can be connected with touch-proof safety test leads (CAT III and IV/1000 V according to EN 61010-031)
- The test plugs are equipped with two gray test sockets per position, for further color versions, see the range of accessories
- Additional test leads, assembled with ring and fork-type cable lugs, can be attached with test sockets
- Other VDE versions available on request

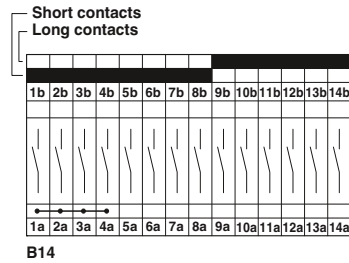

**6 (10) mm<sup>2</sup>, 30 A, test terminal strip, for wall mounting, VDE coded type B14**

Notes:
To create panel cutouts, see phoenixcontact.net/products.
1) Derating curve available on request.
2) Rated surge voltage of 5 kV.

Max. electrical data	
<b>Rated data</b>	
Rated voltage	[V] 400 <sup>2)</sup>
Nominal current / cross section	[A] / [mm <sup>2</sup> ] 24 <sup>1)</sup> /6
Rated cross section	[mm <sup>2</sup> ] 6
Cross section range	AWG 20 - 8
Connection capacity	
1 conductor	[mm <sup>2</sup> ] 0.5 - 10
2 stranded conductors with a TWIN ferrule	[mm <sup>2</sup> ] 0.5 - 6
Plug-in connection cross sections	[mm <sup>2</sup> ] 1 - 10
General data	
Stripping length	[mm] 12
Tightening torque for wall fastening	[Nm] 0.8 - 1
Panel thickness	[mm] 1 - 4
Tightening torque: test socket screw	[Nm] -
Insulating material	PA
Inflammability class according to UL 94	V0

Technical data			
$I_{max}$ [A]	$U_{max}$ [V]	max. $\varnothing$ [mm <sup>2</sup> ]	AWG
<b>30</b>	<b>400<sup>2)</sup></b>	<b>0.5 - 10</b>	<b>20 - 8</b>
IEC 60947-7-1			
IEC	UL/CUL	CSA	IEC/EN 60079-7
Connection capacity		ferrule	
solid	stranded	with/without plastic sleeve	
0.5 - 10	0.5 - 6	0.5 - 6	0.5 - 6
1 - 10	-	1 - 6	1 - 6

Description	Color
<b>Test terminal strip</b> , for wall mounting	gray
<b>Test terminal strip</b> , for mounting on NS 35...	gray
<b>Test plug</b> , with twist grip	gray
With standard handle	gray
<b>Test plug</b> , 1-pos., with cover	gray
<b>Blind plug</b> , sealable	gray

Ordering data		
Type	Order No.	Pcs. / Pkt.
<b>PTWE 6-2/B14</b>	<b>3069440</b>	<b>1</b>

<b>Test socket</b> , insulated	transparent red blue yellow green violet black gray brown
<b>Cover profile</b> , supply length 1 m	transparent
<b>Cover profile holder</b> , can be snapped on and sealed	gray
<b>Cover profile</b> , supply length 1 m	transparent
<b>End brackets</b> , for AP-ME cover profile, sealable, with storage option for jumpers	gray
<b>Holder</b> , for AP-ME cover profile	gray
<b>Fork-type cable lug</b> , insulated according to UL	red blue
<b>Ring cable lug</b> , insulated according to UL	red blue
<b>Screwdriver</b>	SF-SL 0,8X4,0-100

Accessories		
<b>AP RSC-T</b>	<b>3059139</b>	<b>10</b>
<b>APH-UTWE 6-2</b>	<b>3069057</b>	<b>10</b>
<b>SF-SL 0,8X4,0-100</b>	<b>1212551</b>	<b>10</b>

<b>Lateral groove labeling</b>	<b>UC-TM 8, UCT-TM 8, ZB 8 or TMT (EX9,5)R (see Catalog 5)</b>
--------------------------------	--





6 (10) mm<sup>2</sup>, 30 A, test terminal strip, for DIN rail mounting, VDE coded type B14



24 A, test plug, bridge assignment according to circuit diagram, VDE coded type B14



Blind plug, VDE coded type B14

Technical data			
I <sub>max</sub> [A]	U <sub>max</sub> [V]	max. Ø [mm <sup>2</sup> ]	AWG
30	400 <sup>2)</sup>	0.5 - 10	20 - 8
IEC 60947-7-1			
IEC			
UL/CUL	CSA	IEC/EN 60079-7	
400 <sup>2)</sup>	-	-	-
24 <sup>1)</sup> /6	-	-	-
6	-	-	-
20 - 8	-	-	-
solid	stranded	ferrule with/without plastic sleeve	
0.5 - 10	0.5 - 6	0.5 - 6	0.5 - 6 0.5 - 1.5
1 - 10	-	1 - 6	1 - 6
12	-	-	-
-	-	-	-
-	-	-	-
-	-	-	-
PA	-	-	-
V0	-	-	-

Technical data			
I <sub>max</sub> [A]	U <sub>max</sub> [V]	max. Ø [mm <sup>2</sup> ]	AWG
24	400 <sup>2)</sup>	0.5 - 2.5	20 - 14
IEC			
UL/CUL	CSA	IEC/EN 60079-7	
400 <sup>2)</sup>	-	-	-
24/2.5	-	-	-
6	-	-	-
20 - 14	-	-	-
solid	stranded	ferrule with/without plastic sleeve	
-	0.5 - 2.5	-	-
-	-	-	-
-	-	-	-
0.5 - 0.6	-	-	-
PA	-	-	-
V0	-	-	-

Technical data			
		max. Ø [mm <sup>2</sup> ]	AWG
		-	-
IEC			
UL/CUL	CSA	IEC/EN 60079-7	
-	-	-	-
-	-	-	-
-	-	-	-
-	-	-	-
solid	stranded	ferrule with/without plastic sleeve	
-	-	-	-
-	-	-	-
-	-	-	-
PA	-	-	-
V0	-	-	-

Ordering data		
Type	Order No.	Pcs. / Pkt.
PTRE 6-2/B14	3069453	1
FTPR-2/B14	3069488	1
FTP-2/B14	3069475	1
FTP-2/1	3069469	1
FBP-2/B14	3069501	1

Ordering data		
Type	Order No.	Pcs. / Pkt.
PTRE 6-2/B14	3069453	1
FTPR-2/B14	3069488	1
FTP-2/B14	3069475	1
FTP-2/1	3069469	1
FBP-2/B14	3069501	1

Ordering data		
Type	Order No.	Pcs. / Pkt.
PTRE 6-2/B14	3069453	1
FTPR-2/B14	3069488	1
FTP-2/B14	3069475	1
FTP-2/1	3069469	1
FBP-2/B14	3069501	1

Accessories			
AP-ME	METER	3034361	10
APH-ME		3034374	10
APT-ME		3034358	10
SF-SL 0,8X4,0-100		1212551	10

Accessories			
PSBJ-URTK 6 FARBLOS		3026450	10
PSBJ-URTK 6 RD		3026719	10
PSBJ-URTK 6 BU		3026434	10
PSBJ-URTK 6 YE		3026405	10
PSBJ-URTK 6 GN		3026418	10
PSBJ-URTK 6 VT		3026421	10
PSBJ-URTK 6 BK		3026447	10
PSBJ-URTK 6 GY		3026612	10
PSBJ-URTK 6 BN		3026971	10
C-FCI 1,5/M3		3240032	100
C-FCI 2,5/M3		3240037	100
C-RCI 1,5/M3		3240016	100
C-RCI 2,5/M3		3240021	100

Accessories			
UC-TM 8, UCT-TM 8, ZB 8 or TMT (EX9,5)R			

UC-TM 8, UCT-TM 8, ZB 8 or TMT (EX9,5)R (see Catalog 5)

UC-TM 8, UCT-TM 8, ZB 8 or TMT (EX9,5)R (see Catalog 5)

UC-TM 8, UCT-TM 8, ZB 8 or TMT (EX9,5)R (see Catalog 5)

## FAME plug-in test system

### Test terminal strip with PT ... push-in connection, VDE type C14, for wall and DIN rail mounting

The **VDE C14** version described here is suitable as a plug-in test system in overcurrent time protection, unbalanced load protection, and stator ground fault protection for busbar operation.

- The test plugs are assembled with jumpers and contact tab lengths according to the circuit diagram
- A transparent covering hood protects the jumpers. The covering hood can only be removed by dismantling the test plug
- All VDE-specified 7, 14, and 19-pos. versions are supplied with exclusive coding for the matching test plug and blind plug
- The components are supplied pre-marked according to the VDE Directive
- Test signals can be connected with touch-proof safety test leads (CAT III and IV/1000 V according to EN 61010-031)
- The test plugs are equipped with two gray test sockets per position, for further color versions, see the range of accessories
- Additional test leads, assembled with ring and fork-type cable lugs, can be attached with test sockets
- Other VDE versions available on request

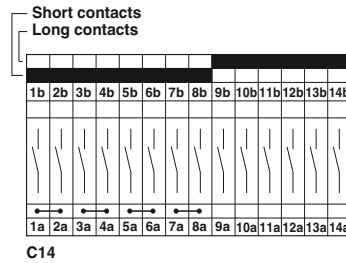

6 (10) mm<sup>2</sup>, 30 A, test terminal strip, for wall mounting, VDE coded type C14

Notes:
To create panel cutouts, see phoenixcontact.net/products.
<sup>1)</sup> Derating curve available on request.
<sup>2)</sup> Rated surge voltage of 5 kV.

Max. electrical data	
<b>Rated data</b>	
Rated voltage	[V] 400 <sup>2)</sup>
Nominal current / cross section	[A] / [mm <sup>2</sup> ] 24 <sup>1)</sup> /6
Rated cross section	[mm <sup>2</sup> ] 6
Cross section range	AWG 20 - 8
<b>Connection capacity</b>	
1 conductor	[mm <sup>2</sup> ] 0.5 - 10
2 stranded conductors with a TWIN ferrule	[mm <sup>2</sup> ] 0.5 - 6
Plug-in connection cross sections	[mm <sup>2</sup> ] 1 - 10
<b>General data</b>	
Stripping length	[mm] 12
Tightening torque for wall fastening	[Nm] 0.8 - 1
Panel thickness	[mm] 1 - 4
Tightening torque: test socket screw	[Nm] -
Insulating material	PA
Inflammability class according to UL 94	V0

Technical data			
$I_{max}$ [A]	$U_{max}$ [V]	max. Ø [mm <sup>2</sup> ]	AWG
30	400 <sup>2)</sup>	0.5 - 10	20 - 8
IEC 60947-7-1	UL/CUL	CSA	IEC/EN 60079-7
<b>Connection capacity</b>			
solid	stranded	ferrule with/without plastic sleeve	
0.5 - 10	0.5 - 6	0.5 - 6	0.5 - 6
1 - 10	-	1 - 6	1 - 6

Description	Color
<b>Test terminal strip</b> , for wall mounting	gray
<b>Test terminal strip</b> , for mounting on NS 35...	gray
<b>Test plug</b> , with twist grip	gray
With standard handle	gray
<b>Test plug</b> , 1-pos., with cover	gray
<b>Blind plug</b> , sealable	gray

Ordering data		
Type	Order No.	Pcs. / Pkt.
<b>PTWE 6-2/C14</b>	3069441	1

<b>Test socket</b> , insulated	transparent
	red
	blue
	yellow
	green
	violet
	black
	gray
	brown
<b>Cover profile</b> , supply length 1 m	transparent
<b>Cover profile holder</b> , can be snapped on and sealed	gray
<b>Cover profile</b> , supply length 1 m	transparent
<b>End brackets</b> , for AP-ME cover profile, sealable, with storage option for jumpers	gray
<b>Holder</b> , for AP-ME cover profile	gray
<b>Fork-type cable lug</b> , insulated according to UL	red
	blue
<b>Ring cable lug</b> , insulated according to UL	red
	blue
<b>Screwdriver</b>	SF-SL 0,8X4,0-100

Accessories		
<b>AP RSC-T</b>	3059139	10
<b>APH-UTWE 6-2</b>	3069057	10
<b>SF-SL 0,8X4,0-100</b>	1212551	10

<b>Lateral groove labeling</b>	UC-TM 8, UCT-TM 8, ZB 8 or TMT (EX9,5)R (see Catalog 5)
--------------------------------	---



6 (10) mm<sup>2</sup>, 30 A, test terminal strip, for DIN rail mounting, VDE coded type C14



24 A, test plug, bridge assignment according to circuit diagram, VDE coded type C14



Blind plug, VDE coded type C14

Technical data			
I <sub>max</sub> [A]	U <sub>max</sub> [V]	max. Ø [mm <sup>2</sup> ]	AWG
30	400 <sup>2)</sup>	0.5 - 10	20 - 8
IEC 60947-7-1			
IEC			
UL/CUL	CSA	IEC/EN 60079-7	
400 <sup>2)</sup>	-	-	-
24 <sup>1)</sup> /6	-	-	-
6	-	-	-
20 - 8	-	-	-
solid	stranded	ferrule with/without plastic sleeve	
0.5 - 10	0.5 - 6	0.5 - 6	0.5 - 6 0.5 - 1.5
1 - 10	-	1 - 6	1 - 6
12	-	-	-
-	-	-	-
-	-	-	-
-	-	-	-
PA	-	-	-
V0	-	-	-

Technical data			
I <sub>max</sub> [A]	U <sub>max</sub> [V]	max. Ø [mm <sup>2</sup> ]	AWG
24	400 <sup>2)</sup>	0.5 - 2.5	20 - 14
IEC			
UL/CUL	CSA	IEC/EN 60079-7	
400 <sup>2)</sup>	-	-	-
24/2.5	-	-	-
6	-	-	-
20 - 14	-	-	-
solid	stranded	ferrule with/without plastic sleeve	
-	0.5 - 2.5	-	-
-	-	-	-
-	-	-	-
0.5 - 0.6	-	-	-
PA	-	-	-
V0	-	-	-

Technical data			
		max. Ø [mm <sup>2</sup> ]	AWG
-	-	-	-
IEC			
UL/CUL	CSA	IEC/EN 60079-7	
-	-	-	-
-	-	-	-
-	-	-	-
-	-	-	-
solid	stranded	ferrule with/without plastic sleeve	
-	-	-	-
-	-	-	-
-	-	-	-
PA	-	-	-
V0	-	-	-

Ordering data		
Type	Order No.	Pcs. / Pkt.
PTRE 6-2/C14	3069454	1
FTP-2/C14	3069489	1
FTP-2/C14	3069476	1
FTP-2/1	3069469	1
FBP-2/C14	3069502	1

Ordering data		
Type	Order No.	Pcs. / Pkt.
FTP-2/C14	3069489	1
FTP-2/C14	3069476	1
FTP-2/1	3069469	1
FBP-2/C14	3069502	1

Ordering data		
Type	Order No.	Pcs. / Pkt.
FBP-2/C14	3069502	1

Accessories			
AP-ME	METER	3034361	10
APH-ME		3034374	10
APT-ME		3034358	10
SF-SL	0,8X4,0-100	1212551	10

Accessories			
PSBJ-URTK 6 FARBLOS		3026450	10
PSBJ-URTK 6 RD		3026719	10
PSBJ-URTK 6 BU		3026434	10
PSBJ-URTK 6 YE		3026405	10
PSBJ-URTK 6 GN		3026418	10
PSBJ-URTK 6 VT		3026421	10
PSBJ-URTK 6 BK		3026447	10
PSBJ-URTK 6 GY		3026612	10
PSBJ-URTK 6 BN		3026971	10
C-FCI 1,5/M3		3240032	100
C-FCI 2,5/M3		3240037	100
C-RCI 1,5/M3		3240016	100
C-RCI 2,5/M3		3240021	100

Accessories			
UC-TM 8, UCT-TM 8, ZB 8 or TMT (EX9,5)R			

UC-TM 8, UCT-TM 8, ZB 8 or TMT (EX9,5)R (see Catalog 5)

UC-TM 8, UCT-TM 8, ZB 8 or TMT (EX9,5)R (see Catalog 5)

UC-TM 8, UCT-TM 8, ZB 8 or TMT (EX9,5)R (see Catalog 5)

## FAME plug-in test system

### Test terminal strip with PT ... push-in connection, VDE type B19, for wall and DIN rail mounting

The **VDE B19** version described here is suitable as a plug-in test system in distance protection for high voltage.

- The test plugs are assembled with jumpers and contact tab lengths according to the circuit diagram
- A transparent covering hood protects the jumpers. The covering hood can only be removed by dismantling the test plug
- All VDE-specified 7, 14, and 19-pos. versions are supplied with exclusive coding for the matching test plug and blind plug
- The components are supplied pre-marked according to the VDE Directive
- Test signals can be connected with touch-proof safety test leads (CAT III and IV/1000 V according to EN 61010-031)
- The test plugs are equipped with two gray test sockets per position, for further color versions, see the range of accessories
- Additional test leads, assembled with ring and fork-type cable lugs, can be attached with test sockets
- Other VDE versions available on request

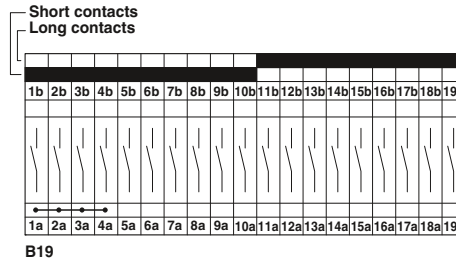

6 (10) mm<sup>2</sup>, 30 A, test terminal strip, for wall mounting, VDE coded type B19

Notes:	
To create panel cutouts, see <a href="http://phoenixcontact.net/products">phoenixcontact.net/products</a> .	
1) Derating curve available on request.	
2) Rated surge voltage of 5 kV.	

Max. electrical data	
<b>Rated data</b>	
Rated voltage	[V] 400 <sup>2)</sup>
Nominal current / cross section	[A] / [mm <sup>2</sup> ] 24 <sup>1)</sup> /6
Rated cross section	[mm <sup>2</sup> ] 6
Cross section range	AWG 20 - 8
Connection capacity	
1 conductor	[mm <sup>2</sup> ] 0.5 - 10
2 stranded conductors with a TWIN ferrule	[mm <sup>2</sup> ] 0.5 - 6
Plug-in connection cross sections	[mm <sup>2</sup> ] 1 - 10
General data	
Stripping length	[mm] 12
Tightening torque for wall fastening	[Nm] 0.8 - 1
Panel thickness	[mm] 1 - 4
Tightening torque: test socket screw	[Nm] -
Insulating material	PA
Inflammability class according to UL 94	V0

Technical data			
$I_{max}$ [A]	$U_{max}$ [V]	max. Ø [mm <sup>2</sup> ]	AWG
30	400 <sup>2)</sup>	0.5 - 10	20 - 8
IEC 60947-7-1	UL/CUL	CSA	IEC/EN 60079-7
Connection capacity		ferrule	
solid	stranded	with/without plastic sleeve	
0.5 - 10	0.5 - 6	0.5 - 6	0.5 - 6
1 - 10	-	1 - 6	1 - 6

Description	Color
<b>Test terminal strip</b> , for wall mounting	gray
<b>Test terminal strip</b> , for mounting on NS 35...	gray
<b>Test plug</b> , with twist grip	gray
With standard handle	gray
<b>Test plug</b> , 1-pos., with cover	gray
<b>Blind plug</b> , sealable	gray

<b>Test socket</b> , insulated	transparent
	red
	blue
	yellow
	green
	violet
	black
	gray
	brown
<b>Cover profile</b> , supply length 1 m	transparent
<b>Cover profile holder</b> , can be snapped on and sealed	gray
<b>Cover profile</b> , supply length 1 m	transparent
<b>End brackets</b> , for AP-ME cover profile, sealable, with storage option for jumpers	gray
<b>Holder</b> , for AP-ME cover profile	gray
<b>Fork-type cable lug</b> , insulated according to UL	red
	blue
<b>Ring cable lug</b> , insulated according to UL	red
	blue
<b>Screwdriver</b>	SF-SL 0,8X4,0-100
<b>Lateral groove labeling</b>	UC-TM 8, UCT-TM 8, ZB 8 or TMT (EX9,5)R (see Catalog 5)

Ordering data		
Type	Order No.	Pcs. / Pkt.
<b>PTWE 6-2/B19</b>	3069442	1

Accessories		
Type	Order No.	Pcs. / Pkt.
<b>AP RSC-T</b>	3059139	10
<b>APH-UTWE 6-2</b>	3069057	10
<b>SF-SL 0,8X4,0-100</b>	1212551	10



6 (10) mm<sup>2</sup>, 30 A, test terminal strip, for DIN rail mounting, VDE coded type B19



24 A, test plug, bridge assignment according to circuit diagram, VDE coded type B19



Blind plug, VDE coded type B19

Technical data			
I <sub>max</sub> [A]	U <sub>max</sub> [V]	max. Ø [mm <sup>2</sup> ]	AWG
30	400 <sup>2</sup> )	0.5 - 10	20 - 8
IEC 60947-7-1			
IEC	UL/CUL	CSA	IEC/EN 60079-7
400 <sup>2</sup> )	-	-	-
24 <sup>1</sup> )/6	-	-	-
6	-	-	-
20 - 8	-	-	-
solid	stranded	ferrule with/without plastic sleeve	
0.5 - 10	0.5 - 6	0.5 - 6	0.5 - 6 0.5 - 1.5
1 - 10	-	1 - 6	1 - 6
12	-	-	-
-	-	-	-
-	-	-	-
-	-	-	-
PA	-	-	-
V0	-	-	-

Technical data			
I <sub>max</sub> [A]	U <sub>max</sub> [V]	max. Ø [mm <sup>2</sup> ]	AWG
24	400 <sup>2</sup> )	0.5 - 2.5	20 - 14
IEC			
UL/CUL	CSA	IEC/EN 60079-7	
400 <sup>2</sup> )	-	-	-
24/2.5	-	-	-
6	-	-	-
20 - 14	-	-	-
solid	stranded	ferrule with/without plastic sleeve	
-	0.5 - 2.5	-	-
-	-	-	-
-	-	-	-
0.5 - 0.6	-	-	-
PA	-	-	-
V0	-	-	-

Technical data			
		max. Ø [mm <sup>2</sup> ]	AWG
		-	-
IEC			
UL/CUL	CSA	IEC/EN 60079-7	
-	-	-	-
-	-	-	-
-	-	-	-
-	-	-	-
solid	stranded	ferrule with/without plastic sleeve	
-	-	-	-
-	-	-	-
-	-	-	-
PA	-	-	-
V0	-	-	-

Ordering data		
Type	Order No.	Pcs. / Pkt.
PTRE 6-2/B19	3069455	1
FTPR-2/B19	3069490	1
FTP-2/B19	3069477	1
FTP-2/1	3069469	1
FBP-2/B19	3069503	1

Ordering data		
Type	Order No.	Pcs. / Pkt.
PTRE 6-2/B19	3069455	1
FTPR-2/B19	3069490	1
FTP-2/B19	3069477	1
FTP-2/1	3069469	1
FBP-2/B19	3069503	1

Ordering data		
Type	Order No.	Pcs. / Pkt.
PTRE 6-2/B19	3069455	1
FTPR-2/B19	3069490	1
FTP-2/B19	3069477	1
FTP-2/1	3069469	1
FBP-2/B19	3069503	1

Accessories			
AP-ME	METER	3034361	10
APH-ME		3034374	10
APT-ME		3034358	10
SF-SL 0,8X4,0-100		1212551	10

Accessories			
PSBJ-URTK 6 FARBLOS		3026450	10
PSBJ-URTK 6 RD		3026719	10
PSBJ-URTK 6 BU		3026434	10
PSBJ-URTK 6 YE		3026405	10
PSBJ-URTK 6 GN		3026418	10
PSBJ-URTK 6 VT		3026421	10
PSBJ-URTK 6 BK		3026447	10
PSBJ-URTK 6 GY		3026612	10
PSBJ-URTK 6 BN		3026971	10
C-FCI 1,5/M3		3240032	100
C-FCI 2,5/M3		3240037	100
C-RCI 1,5/M3		3240016	100
C-RCI 2,5/M3		3240021	100

Accessories			
UC-TM 8, UCT-TM 8, ZB 8 or TMT (EX9,5)R			

UC-TM 8, UCT-TM 8, ZB 8 or TMT (EX9,5)R (see Catalog 5)

UC-TM 8, UCT-TM 8, ZB 8 or TMT (EX9,5)R (see Catalog 5)

UC-TM 8, UCT-TM 8, ZB 8 or TMT (EX9,5)R (see Catalog 5)

## FAME plug-in test system

### Test terminal strip with PT ... push-in connection, VDE type C19, for wall and DIN rail mounting

The **VDE C19** version described here is suitable as a plug-in test system in distance protection as system busbar protection, overcurrent directional protection, and current comparison protection for cables.

- The test plugs are assembled with jumpers and contact tab lengths according to the circuit diagram
- A transparent covering hood protects the jumpers. The covering hood can only be removed by dismantling the test plug
- All VDE-specified 7, 14, and 19-pos. versions are supplied with exclusive coding for the matching test plug and blind plug
- The components are supplied pre-marked according to the VDE Directive
- Test signals can be connected with touch-proof safety test leads (CAT III and IV/1000 V according to EN 61010-031)
- The test plugs are equipped with two gray test sockets per position, for further color versions, see the range of accessories
- Additional test leads, assembled with ring and fork-type cable lugs, can be attached with test sockets
- Other VDE versions available on request

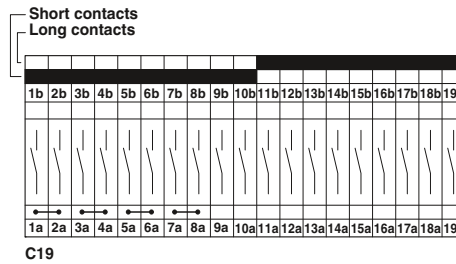

6 (10) mm<sup>2</sup>, 30 A, test terminal strip, for wall mounting, VDE coded type C19

Notes:
To create panel cutouts, see phoenixcontact.net/products.
<sup>1)</sup> Derating curve available on request.
<sup>2)</sup> Rated surge voltage of 5 kV.

Max. electrical data	
<b>Rated data</b>	
Rated voltage	[V] 400 <sup>2)</sup>
Nominal current / cross section	[A] / [mm <sup>2</sup> ] 24 <sup>1)</sup> /6
Rated cross section	[mm <sup>2</sup> ] 6
Cross section range	AWG 20 - 8
<b>Connection capacity</b>	
1 conductor	[mm <sup>2</sup> ] 0.5 - 10
2 stranded conductors with a TWIN ferrule	[mm <sup>2</sup> ] 0.5 - 6
Plug-in connection cross sections	[mm <sup>2</sup> ] 1 - 10
<b>General data</b>	
Stripping length	[mm] 12
Tightening torque for wall fastening	[Nm] 0.8 - 1
Panel thickness	[mm] 1 - 4
Tightening torque: test socket screw	[Nm] -
Insulating material	PA
Inflammability class according to UL 94	V0

Technical data			
I <sub>max</sub> [A]	U <sub>max</sub> [V]	max. Ø [mm <sup>2</sup> ]	AWG
30	400 <sup>2)</sup>	0.5 - 10	20 - 8
IEC 60947-7-1	UL/CUL	CSA	IEC/EN 60079-7
<b>Connection capacity</b>		<b>ferrule</b>	
solid	stranded	with/without plastic sleeve	
0.5 - 10	0.5 - 6	0.5 - 6	0.5 - 6
1 - 10	-	1 - 6	1 - 6

Description	Color
<b>Test terminal strip</b> , for wall mounting	gray
<b>Test terminal strip</b> , for mounting on NS 35...	gray
<b>Test plug</b> , with twist grip	gray
With standard handle	gray
<b>Test plug</b> , 1-pos., with cover	gray
<b>Blind plug</b> , sealable	gray

Ordering data		
Type	Order No.	Pcs. / Pkt.
<b>PTWE 6-2/C19</b>	3069443	1

<b>Test socket</b> , insulated	transparent
	red
	blue
	yellow
	green
	violet
	black
	gray
	brown
<b>Cover profile</b> , supply length 1 m	transparent
<b>Cover profile holder</b> , can be snapped on and sealed	gray
<b>Cover profile</b> , supply length 1 m	transparent
<b>End brackets</b> , for AP-ME cover profile, sealable, with storage option for jumpers	gray
<b>Holder</b> , for AP-ME cover profile	gray
<b>Fork-type cable lug</b> , insulated according to UL	red
	blue
<b>Ring cable lug</b> , insulated according to UL	red
	blue
<b>Screwdriver</b>	SF-SL 0,8X4,0-100

Accessories		
<b>AP RSC-T</b>	3059139	10
<b>APH-UTWE 6-2</b>	3069057	10
<b>SF-SL 0,8X4,0-100</b>	1212551	10

<b>Lateral groove labeling</b>	UC-TM 8, UCT-TM 8, ZB 8 or TMT (EX9,5)R (see Catalog 5)
--------------------------------	---



6 (10) mm<sup>2</sup>, 30 A, test terminal strip, for DIN rail mounting, VDE coded type C19



24 A, test plug, bridge assignment according to circuit diagram, VDE coded type C19



Blind plug, VDE coded type C19

Technical data			
I <sub>max</sub> [A]	U <sub>max</sub> [V]	max. Ø [mm <sup>2</sup> ]	AWG
30	400 <sup>2</sup> )	0.5 - 10	20 - 8
IEC 60947-7-1			
IEC			
UL/CUL	CSA	IEC/EN 60079-7	
400 <sup>2</sup> )	-	-	-
24 <sup>1</sup> )/6	-	-	-
6	-	-	-
20 - 8	-	-	-
solid	stranded	ferrule with/without plastic sleeve	
0.5 - 10	0.5 - 6	0.5 - 6	0.5 - 6 0.5 - 1.5
1 - 10	-	1 - 6	1 - 6
12	-	-	-
-	-	-	-
-	-	-	-
-	-	-	-
PA	-	-	-
V0	-	-	-

Technical data			
I <sub>max</sub> [A]	U <sub>max</sub> [V]	max. Ø [mm <sup>2</sup> ]	AWG
24	400 <sup>2</sup> )	0.5 - 2.5	20 - 14
IEC			
UL/CUL	CSA	IEC/EN 60079-7	
400 <sup>2</sup> )	-	-	-
24/2.5	-	-	-
6	-	-	-
20 - 14	-	-	-
solid	stranded	ferrule with/without plastic sleeve	
-	0.5 - 2.5	-	-
-	-	-	-
-	-	-	-
0.5 - 0.6	-	-	-
PA	-	-	-
V0	-	-	-

Technical data			
		max. Ø [mm <sup>2</sup> ]	AWG
		-	-
IEC			
UL/CUL	CSA	IEC/EN 60079-7	
-	-	-	-
-	-	-	-
-	-	-	-
-	-	-	-
solid	stranded	ferrule with/without plastic sleeve	
-	-	-	-
-	-	-	-
-	-	-	-
PA	-	-	-
V0	-	-	-

Ordering data		
Type	Order No.	Pcs. / Pkt.
PTRE 6-2/C19	3069456	1
FTPR-2/C19	3069491	1
FTP-2/C19	3069478	1
FTP-2/1	3069469	1
FBP-2/C19	3069504	1

Ordering data		
Type	Order No.	Pcs. / Pkt.
PTRE 6-2/C19	3069456	1
FTPR-2/C19	3069491	1
FTP-2/C19	3069478	1
FTP-2/1	3069469	1
FBP-2/C19	3069504	1

Ordering data		
Type	Order No.	Pcs. / Pkt.
PTRE 6-2/C19	3069456	1
FTPR-2/C19	3069491	1
FTP-2/C19	3069478	1
FTP-2/1	3069469	1
FBP-2/C19	3069504	1

Accessories			
		Order No.	Pcs. / Pkt.
AP-ME	METER	3034361	10
APH-ME		3034374	10
APT-ME		3034358	10
SF-SL 0,8X4,0-100		1212551	10

Accessories			
		Order No.	Pcs. / Pkt.
PSBJ-URTK 6 FARBLOS		3026450	10
PSBJ-URTK 6 RD		3026719	10
PSBJ-URTK 6 BU		3026434	10
PSBJ-URTK 6 YE		3026405	10
PSBJ-URTK 6 GN		3026418	10
PSBJ-URTK 6 VT		3026421	10
PSBJ-URTK 6 BK		3026447	10
PSBJ-URTK 6 GY		3026612	10
PSBJ-URTK 6 BN		3026971	10
C-FCI 1,5/M3		3240032	100
C-FCI 2,5/M3		3240037	100
C-RCI 1,5/M3		3240016	100
C-RCI 2,5/M3		3240021	100

Accessories			
		Order No.	Pcs. / Pkt.
UC-TM 8, UCT-TM 8, ZB 8 or TMT (EX9,5)R			

UC-TM 8, UCT-TM 8, ZB 8 or TMT (EX9,5)R (see Catalog 5)

UC-TM 8, UCT-TM 8, ZB 8 or TMT (EX9,5)R (see Catalog 5)

UC-TM 8, UCT-TM 8, ZB 8 or TMT (EX9,5)R (see Catalog 5)

## FAME plug-in test system

### Test terminal strip with PT ... push-in connection, VDE type D19, for wall and DIN rail mounting

The **VDE D19** version described here is suitable as a plug-in test system for electromechanical differential protection for transformers.

- The test plugs are assembled with jumpers and contact tab lengths according to the circuit diagram
- A transparent covering hood protects the jumpers. The covering hood can only be removed by dismantling the test plug
- All VDE-specified 7, 14, and 19-pos. versions are supplied with exclusive coding for the matching test plug and blind plug
- The components are supplied pre-marked according to the VDE Directive
- Test signals can be connected with touch-proof safety test leads (CAT III and IV/1000 V according to EN 61010-031)
- The test plugs are equipped with two gray test sockets per position, for further color versions, see the range of accessories
- Additional test leads, assembled with ring and fork-type cable lugs, can be attached with test sockets
- Other VDE versions available on request

Notes:
To create panel cutouts, see <a href="http://phoenixcontact.net/products">phoenixcontact.net/products</a> .
<sup>1)</sup> Derating curve available on request.
<sup>2)</sup> Rated surge voltage of 5 kV.

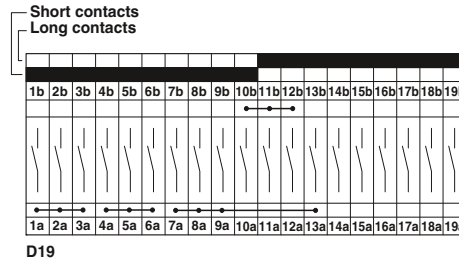

Max. electrical data	
<b>Rated data</b>	
Rated voltage	[V] 400 <sup>2)</sup>
Nominal current / cross section	[A] / [mm <sup>2</sup> ] 24 <sup>1)</sup> /6
Rated cross section	[mm <sup>2</sup> ] 6
Cross section range	AWG 20 - 8
Connection capacity	
1 conductor	[mm <sup>2</sup> ] 0.5 - 10
2 stranded conductors with a TWIN ferrule	[mm <sup>2</sup> ] 0.5 - 6
Plug-in connection cross sections	[mm <sup>2</sup> ] 1 - 10
General data	
Stripping length	[mm] 12
Tightening torque for wall fastening	[Nm] 0.8 - 1
Panel thickness	[mm] 1 - 4
Tightening torque: test socket screw	[Nm] -
Insulating material	PA
Inflammability class according to UL 94	V0

Description	Color
<b>Test terminal strip</b> , for wall mounting	gray
<b>Test terminal strip</b> , for mounting on NS 35...	gray
<b>Test plug</b> , with twist grip	gray
With standard handle	gray
<b>Test plug</b> , 1-pos., with cover	gray
<b>Blind plug</b> , sealable	gray

<b>Test socket</b> , insulated	transparent red blue yellow green violet black gray brown
<b>Cover profile</b> , supply length 1 m	transparent
<b>Cover profile holder</b> , can be snapped on and sealed	gray
<b>Cover profile</b> , supply length 1 m	transparent
<b>End brackets</b> , for AP-ME cover profile, sealable, with storage option for jumpers	gray
<b>Holder</b> , for AP-ME cover profile	gray
<b>Fork-type cable lug</b> , insulated according to UL	red blue
<b>Ring cable lug</b> , insulated according to UL	red blue
<b>Screwdriver</b>	SF-SL 0,8X4,0-100
<b>Lateral groove labeling</b>	UC-TM 8, UCT-TM 8, ZB 8 or TMT (EX9,5)R (see Catalog 5)



6 (10) mm<sup>2</sup>, 30 A, test terminal strip, for wall mounting, VDE coded type D19

Technical data			
$I_{max}$ [A]	$U_{max}$ [V]	max. Ø [mm <sup>2</sup> ]	AWG
<b>30</b>	<b>400<sup>2)</sup></b>	<b>0.5 - 10</b>	<b>20 - 8</b>
IEC 60947-7-1	UL/CUL	CSA	IEC/EN 60079-7
Connection capacity		ferrule	
solid	stranded	with/without plastic sleeve	
0.5 - 10	0.5 - 6	0.5 - 6	0.5 - 6
1 - 10	-	1 - 6	1 - 6

Ordering data			
Type	Order No.	Pcs. / Pkt.	
<b>PTWE 6-2/D19</b>	<b>3069444</b>	<b>1</b>	

Accessories			
<b>AP RSC-T</b>	<b>3059139</b>	<b>10</b>	
<b>APH-UTWE 6-2</b>	<b>3069057</b>	<b>10</b>	
<b>SF-SL 0,8X4,0-100</b>	<b>1212551</b>	<b>10</b>	
<b>UC-TM 8, UCT-TM 8, ZB 8 or TMT (EX9,5)R (see Catalog 5)</b>			





6 (10) mm<sup>2</sup>, 30 A, test terminal strip, for DIN rail mounting, VDE coded type D19



24 A, test plug, bridge assignment according to circuit diagram, VDE coded type D19



Blind plug, VDE coded type D19

Technical data			
I <sub>max</sub> [A]	U <sub>max</sub> [V]	max. Ø [mm <sup>2</sup> ]	AWG
30	400 <sup>2</sup> )	0.5 - 10	20 - 8
IEC 60947-7-1			
IEC	UL/CUL	CSA	IEC/EN 60079-7
400 <sup>2</sup> )	-	-	-
24 <sup>1</sup> )/6	-	-	-
6	-	-	-
20 - 8	-	-	-
solid	stranded	ferrule with/without plastic sleeve	
0.5 - 10	0.5 - 6	0.5 - 6	0.5 - 6 0.5 - 1.5
1 - 10	-	1 - 6	1 - 6
12	-	-	-
-	-	-	-
-	-	-	-
-	-	-	-
PA	-	-	-
V0	-	-	-

Technical data			
I <sub>max</sub> [A]	U <sub>max</sub> [V]	max. Ø [mm <sup>2</sup> ]	AWG
24	400 <sup>2</sup> )	0.5 - 2.5	20 - 14
IEC			
UL/CUL	CSA	IEC/EN 60079-7	
400 <sup>2</sup> )	-	-	-
24/2.5	-	-	-
6	-	-	-
20 - 14	-	-	-
solid	stranded	ferrule with/without plastic sleeve	
-	0.5 - 2.5	-	-
-	-	-	-
-	-	-	-
0.5 - 0.6	-	-	-
PA	-	-	-
V0	-	-	-

Technical data			
		max. Ø [mm <sup>2</sup> ]	AWG
		-	-
IEC			
UL/CUL	CSA	IEC/EN 60079-7	
-	-	-	-
-	-	-	-
-	-	-	-
-	-	-	-
solid	stranded	ferrule with/without plastic sleeve	
-	-	-	-
-	-	-	-
-	-	-	-
PA	-	-	-
V0	-	-	-

Ordering data		
Type	Order No.	Pcs. / Pkt.
PTRE 6-2/D19	3069457	1
FTP-2/D19	3069492	1
FTP-2/D19	3069479	1
FTP-2/1	3069469	1

Ordering data		
Type	Order No.	Pcs. / Pkt.
FBP-2/D19	3069671	1

Ordering data		
Type	Order No.	Pcs. / Pkt.
FBP-2/D19	3069671	1

Accessories			
AP-ME	METER	3034361	10
APH-ME		3034374	10
APT-ME		3034358	10
SF-SL	0,8X4,0-100	1212551	10

Accessories			
PSBJ-URTK 6 FARBLOS		3026450	10
PSBJ-URTK 6 RD		3026719	10
PSBJ-URTK 6 BU		3026434	10
PSBJ-URTK 6 YE		3026405	10
PSBJ-URTK 6 GN		3026418	10
PSBJ-URTK 6 VT		3026421	10
PSBJ-URTK 6 BK		3026447	10
PSBJ-URTK 6 GY		3026612	10
PSBJ-URTK 6 BN		3026971	10
C-FCI 1,5/M3		3240032	100
C-FCI 2,5/M3		3240037	100
C-RCI 1,5/M3		3240016	100
C-RCI 2,5/M3		3240021	100

Accessories			
UC-TM 8, UCT-TM 8, ZB 8 or TMT (EX9,5)R			

UC-TM 8, UCT-TM 8, ZB 8 or TMT (EX9,5)R (see Catalog 5)

UC-TM 8, UCT-TM 8, ZB 8 or TMT (EX9,5)R (see Catalog 5)

UC-TM 8, UCT-TM 8, ZB 8 or TMT (EX9,5)R (see Catalog 5)

## FAME plug-in test system

### Test terminal strip with PT ... push-in connection, VDE type F19, for wall and DIN rail mounting

The **VDE F19** version described here is suitable as a plug-in test system in electromechanical differential protection for transformers, generators, motors, and cables.

- The test plugs are assembled with jumpers and contact tab lengths according to the circuit diagram
- A transparent covering hood protects the jumpers. The covering hood can only be removed by dismantling the test plug
- All VDE-specified 7, 14, and 19-pos. versions are supplied with exclusive coding for the matching test plug and blind plug
- The components are supplied pre-marked according to the VDE Directive
- Test signals can be connected with touch-proof safety test leads (CAT III and IV/1000 V according to EN 61010-031)
- The test plugs are equipped with two gray test sockets per position, for further color versions, see the range of accessories
- Additional test leads, assembled with ring and fork-type cable lugs, can be attached with test sockets
- Other VDE versions available on request

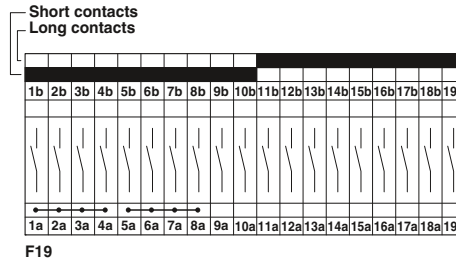

**6 (10) mm<sup>2</sup>, 30 A, test terminal strip, for wall mounting, VDE coded type F19**

Notes:
To create panel cutouts, see phoenixcontact.net/products.
<sup>1)</sup> Derating curve available on request.
<sup>2)</sup> Rated surge voltage of 5 kV.

Max. electrical data	
<b>Rated data</b>	
Rated voltage	[V] 400 <sup>2)</sup>
Nominal current / cross section	[A] / [mm <sup>2</sup> ] 24 <sup>1)</sup> /6
Rated cross section	[mm <sup>2</sup> ] 6
Cross section range	AWG 20 - 8
Connection capacity	
1 conductor	[mm <sup>2</sup> ] 0.5 - 10
2 stranded conductors with a TWIN ferrule	[mm <sup>2</sup> ] 0.5 - 6
Plug-in connection cross sections	[mm <sup>2</sup> ] 1 - 10
General data	
Stripping length	[mm] 12
Tightening torque for wall fastening	[Nm] 0.8 - 1
Panel thickness	[mm] 1 - 4
Tightening torque: test socket screw	[Nm] -
Insulating material	PA
Inflammability class according to UL 94	V0

Technical data			
$I_{max}$ [A]	$U_{max}$ [V]	max. $\varnothing$ [mm <sup>2</sup> ]	AWG
<b>30</b>	<b>400<sup>2)</sup></b>	<b>0.5 - 10</b>	<b>20 - 8</b>
IEC 60947-7-1	UL/CUL	CSA	IEC/EN 60079-7
Connection capacity		ferrule	
solid	stranded	with/without plastic sleeve	
0.5 - 10	0.5 - 6	0.5 - 6	0.5 - 6
1 - 10	-	1 - 6	1 - 6

Description	Color
<b>Test terminal strip</b> , for wall mounting	gray
<b>Test terminal strip</b> , for mounting on NS 35...	gray
<b>Test plug</b> , with twist grip	gray
With standard handle	gray
<b>Test plug</b> , 1-pos., with cover	gray
<b>Blind plug</b> , sealable	gray

Ordering data		
Type	Order No.	Pcs. / Pkt.
<b>PTWE 6-2/F19</b>	<b>3069445</b>	<b>1</b>

<b>Test socket</b> , insulated	transparent
	red
	blue
	yellow
	green
	violet
	black
	gray
	brown
<b>Cover profile</b> , supply length 1 m	transparent
<b>Cover profile holder</b> , can be snapped on and sealed	gray
<b>Cover profile</b> , supply length 1 m	transparent
<b>End brackets</b> , for AP-ME cover profile, sealable, with storage option for jumpers	gray
<b>Holder</b> , for AP-ME cover profile	gray
<b>Fork-type cable lug</b> , insulated according to UL	red
	blue
<b>Ring cable lug</b> , insulated according to UL	red
	blue
<b>Screwdriver</b>	SF-SL 0,8X4,0-100
<b>Lateral groove labeling</b>	UC-TM 8, UCT-TM 8, ZB 8 or TMT (EX9,5)R (see Catalog 5)

Accessories		
<b>AP RSC-T</b>	<b>3059139</b>	<b>10</b>
<b>APH-UTWE 6-2</b>	<b>3069057</b>	<b>10</b>
<b>SF-SL 0,8X4,0-100</b>	<b>1212551</b>	<b>10</b>
<b>UC-TM 8, UCT-TM 8, ZB 8 or TMT (EX9,5)R (see Catalog 5)</b>		

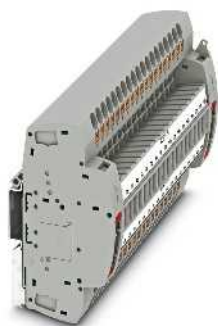

6 (10) mm<sup>2</sup>, 30 A, test terminal strip, for DIN rail mounting, VDE coded type F19



24 A, test plug, bridge assignment according to circuit diagram, VDE coded type F19



Blind plug, VDE coded type F19

Technical data			
I <sub>max</sub> [A]	U <sub>max</sub> [V]	max. Ø [mm <sup>2</sup> ]	AWG
30	400 <sup>2</sup> )	0.5 - 10	20 - 8
IEC 60947-7-1			
IEC	UL/CUL	CSA	IEC/EN 60079-7
400 <sup>2</sup> )	-	-	-
24 <sup>1</sup> )/6	-	-	-
6	-	-	-
20 - 8	-	-	-
solid	stranded	ferrule with/without plastic sleeve	
0.5 - 10	0.5 - 6	0.5 - 6	0.5 - 6 0.5 - 1.5
1 - 10	-	1 - 6	1 - 6
12	-	-	-
-	-	-	-
-	-	-	-
-	-	-	-
PA	-	-	-
V0	-	-	-

Technical data			
I <sub>max</sub> [A]	U <sub>max</sub> [V]	max. Ø [mm <sup>2</sup> ]	AWG
24	400 <sup>2</sup> )	0.5 - 2.5	20 - 14
IEC			
UL/CUL	CSA	IEC/EN 60079-7	
400 <sup>2</sup> )	-	-	-
24/2.5	-	-	-
6	-	-	-
20 - 14	-	-	-
solid	stranded	ferrule with/without plastic sleeve	
-	0.5 - 2.5	-	-
-	-	-	-
-	-	-	-
0.5 - 0.6	-	-	-
PA	-	-	-
V0	-	-	-

Technical data			
		max. Ø [mm <sup>2</sup> ]	AWG
		-	-
IEC			
UL/CUL	CSA	IEC/EN 60079-7	
-	-	-	-
-	-	-	-
-	-	-	-
-	-	-	-
solid	stranded	ferrule with/without plastic sleeve	
-	-	-	-
-	-	-	-
-	-	-	-
PA	-	-	-
V0	-	-	-

Ordering data		
Type	Order No.	Pcs. / Pkt.
PTRE 6-2/F19	3069458	1
FTPR-2/F19	3069493	1
FTP-2/F19	3069480	1
FTP-2/1	3069469	1
FBP-2/F19	3069675	1

Ordering data		
Type	Order No.	Pcs. / Pkt.
PTRE 6-2/F19	3069458	1
FTPR-2/F19	3069493	1
FTP-2/F19	3069480	1
FTP-2/1	3069469	1
FBP-2/F19	3069675	1

Ordering data		
Type	Order No.	Pcs. / Pkt.
PTRE 6-2/F19	3069458	1
FTPR-2/F19	3069493	1
FTP-2/F19	3069480	1
FTP-2/1	3069469	1
FBP-2/F19	3069675	1

Accessories			
AP-ME	METER	3034361	10
APH-ME		3034374	10
APT-ME		3034358	10
SF-SL	0,8X4,0-100	1212551	10

Accessories			
PSBJ-URTK 6 FARBLOS		3026450	10
PSBJ-URTK 6 RD		3026719	10
PSBJ-URTK 6 BU		3026434	10
PSBJ-URTK 6 YE		3026405	10
PSBJ-URTK 6 GN		3026418	10
PSBJ-URTK 6 VT		3026421	10
PSBJ-URTK 6 BK		3026447	10
PSBJ-URTK 6 GY		3026612	10
PSBJ-URTK 6 BN		3026971	10
C-FCI 1,5/M3		3240032	100
C-FCI 2,5/M3		3240037	100
C-RCI 1,5/M3		3240016	100
C-RCI 2,5/M3		3240021	100

Accessories			
UC-TM 8, UCT-TM 8, ZB 8 or TMT (EX9,5)R			

UC-TM 8, UCT-TM 8, ZB 8 or TMT (EX9,5)R (see Catalog 5)

UC-TM 8, UCT-TM 8, ZB 8 or TMT (EX9,5)R (see Catalog 5)

UC-TM 8, UCT-TM 8, ZB 8 or TMT (EX9,5)R (see Catalog 5)

## FAME plug-in test system

### Test terminal strip with PT ... push-in connection, VDE type G19, for wall and DIN rail mounting

The **VDE G19** version described here is suitable as a plug-in test system in digital differential protection for transformers.

- The test plugs are assembled with jumpers and contact tab lengths according to the circuit diagram
- A transparent covering hood protects the jumpers. The covering hood can only be removed by dismantling the test plug
- All VDE-specified 7, 14, and 19-pos. versions are supplied with exclusive coding for the matching test plug and blind plug
- The components are supplied pre-marked according to the VDE Directive
- Test signals can be connected with touch-proof safety test leads (CAT III and IV/1000 V according to EN 61010-031)
- The test plugs are equipped with two gray test sockets per position, for further color versions, see the range of accessories
- Additional test leads, assembled with ring and fork-type cable lugs, can be attached with test sockets
- Other VDE versions available on request

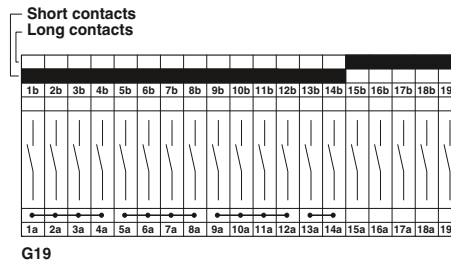

G19



6 (10) mm<sup>2</sup>, 30 A, test terminal strip, for wall mounting, VDE coded type G19

Notes:	
To create panel cutouts, see <a href="http://phoenixcontact.net/products">phoenixcontact.net/products</a> .	
1) Derating curve available on request.	
2) Rated surge voltage of 5 kV.	

Max. electrical data	
Rated voltage	[V] 400 <sup>2)</sup>
Nominal current / cross section	[A] / [mm <sup>2</sup> ] 24 <sup>1)</sup> /6
Rated cross section	[mm <sup>2</sup> ] 6
Cross section range	AWG 20 - 8
Connection capacity	
1 conductor	[mm <sup>2</sup> ] 0.5 - 10
2 stranded conductors with a TWIN ferrule	[mm <sup>2</sup> ] 0.5 - 6
Plug-in connection cross sections	[mm <sup>2</sup> ] 1 - 10
General data	
Stripping length	[mm] 12
Tightening torque for wall fastening	[Nm] 0.8 - 1
Panel thickness	[mm] 1 - 4
Tightening torque: test socket screw	[Nm] -
Insulating material	PA
Inflammability class according to UL 94	V0

Technical data			
I <sub>max</sub> [A]	U <sub>max</sub> [V]	max. Ø [mm <sup>2</sup> ]	AWG
30	400 <sup>2)</sup>	0.5 - 10	20 - 8
IEC 60947-7-1	UL/CUL	CSA	IEC/EN 60079-7
Connection capacity		ferrule	
solid	stranded	with/without plastic sleeve	
0.5 - 10	0.5 - 6	0.5 - 6	0.5 - 6
1 - 10	-	1 - 6	1 - 6

Description	Color
Test terminal strip, for wall mounting	gray
Test terminal strip, for mounting on NS 35...	gray
Test plug, with twist grip	gray
With standard handle	gray
Test plug, 1-pos., with cover	gray
Blind plug, sealable	gray

Ordering data		
Type	Order No.	Pcs. / Pkt.
PTWE 6-2/G19	3069446	1

Test socket, insulated	transparent
	red
	blue
	yellow
	green
	violet
	black
	gray
	brown
Cover profile, supply length 1 m	transparent
Cover profile holder, can be snapped on and sealed	gray
Cover profile, supply length 1 m	transparent
End brackets, for AP-ME cover profile, sealable, with storage option for jumpers	gray
Holder, for AP-ME cover profile	gray
Fork-type cable lug, insulated according to UL	red
	blue
Ring cable lug, insulated according to UL	red
	blue
Screwdriver	SF-SL 0,8X4,0-100
Lateral groove labeling	UC-TM 8, UCT-TM 8, ZB 8 or TMT (EX9,5)R (see Catalog 5)

Accessories		
AP RSC-T	3059139	10
APH-UTWE 6-2	3069057	10
SF-SL 0,8X4,0-100	1212551	10
UC-TM 8, UCT-TM 8, ZB 8 or TMT (EX9,5)R (see Catalog 5)		



6 (10) mm<sup>2</sup>, 30 A, test terminal strip, for DIN rail mounting, VDE coded type G19



24 A, test plug, bridge assignment according to circuit diagram, VDE coded type G19



Blind plug, VDE coded type G19

Technical data			
I <sub>max</sub> [A]	U <sub>max</sub> [V]	max. Ø [mm <sup>2</sup> ]	AWG
30	400 <sup>2</sup> )	0.5 - 10	20 - 8
IEC 60947-7-1			
IEC	UL/CUL	CSA	IEC/EN 60079-7
400 <sup>2</sup> )	-	-	-
24 <sup>1</sup> )/6	-	-	-
6	-	-	-
20 - 8	-	-	-
solid	stranded	ferrule with/without plastic sleeve	
0.5 - 10	0.5 - 6	0.5 - 6	0.5 - 6 0.5 - 1.5
1 - 10	-	1 - 6	1 - 6
12	-	-	-
-	-	-	-
-	-	-	-
PA	-	-	-
V0	-	-	-

Technical data			
I <sub>max</sub> [A]	U <sub>max</sub> [V]	max. Ø [mm <sup>2</sup> ]	AWG
24	400 <sup>2</sup> )	0.5 - 2.5	20 - 14
IEC			
UL/CUL	CSA	IEC/EN 60079-7	
400 <sup>2</sup> )	-	-	-
24/2.5	-	-	-
6	-	-	-
20 - 14	-	-	-
solid	stranded	ferrule with/without plastic sleeve	
-	0.5 - 2.5	-	-
-	-	-	-
0.5 - 0.6	-	-	-
PA	-	-	-
V0	-	-	-

Technical data			
		max. Ø [mm <sup>2</sup> ]	AWG
		-	-
IEC			
UL/CUL	CSA	IEC/EN 60079-7	
-	-	-	-
-	-	-	-
-	-	-	-
-	-	-	-
solid	stranded	ferrule with/without plastic sleeve	
-	-	-	-
-	-	-	-
PA	-	-	-
V0	-	-	-

Ordering data		
Type	Order No.	Pcs. / Pkt.
PTRE 6-2/G19	3069459	1
FTP-2/G19	3069494	1
FTP-2/G19	3069481	1
FTP-2/1	3069469	1
FBP-2/G19	3069676	1

Ordering data		
Type	Order No.	Pcs. / Pkt.
FTP-2/G19	3069494	1
FTP-2/G19	3069481	1
FTP-2/1	3069469	1
FBP-2/G19	3069676	1

Ordering data		
Type	Order No.	Pcs. / Pkt.
FBP-2/G19	3069676	1

Accessories			
AP-ME	METER	3034361	10
APH-ME		3034374	10
APT-ME		3034358	10
SF-SL 0,8X4,0-100		1212551	10

Accessories			
PSBJ-URTK 6 FARBLOS		3026450	10
PSBJ-URTK 6 RD		3026719	10
PSBJ-URTK 6 BU		3026434	10
PSBJ-URTK 6 YE		3026405	10
PSBJ-URTK 6 GN		3026418	10
PSBJ-URTK 6 VT		3026421	10
PSBJ-URTK 6 BK		3026447	10
PSBJ-URTK 6 GY		3026612	10
PSBJ-URTK 6 BN		3026971	10
C-FCI 1,5/M3		3240032	100
C-FCI 2,5/M3		3240037	100
C-RCI 1,5/M3		3240016	100
C-RCI 2,5/M3		3240021	100

Accessories			
UC-TM 8, UCT-TM 8, ZB 8 or TMT (EX9,5)R			

UC-TM 8, UCT-TM 8, ZB 8 or TMT (EX9,5)R (see Catalog 5)

UC-TM 8, UCT-TM 8, ZB 8 or TMT (EX9,5)R (see Catalog 5)

UC-TM 8, UCT-TM 8, ZB 8 or TMT (EX9,5)R (see Catalog 5)

## FAME plug-in test system

### Test terminal strip with PT ... push-in connection, VDE type H19, for wall and DIN rail mounting

The **VDE H19** version described here is suitable as a plug-in test system in overcurrent directional protection and distance protection as system protection.

- The test plugs are assembled with jumpers and contact tab lengths according to the circuit diagram
- A transparent covering hood protects the jumpers. The covering hood can only be removed by dismantling the test plug
- All VDE-specified 7, 14, and 19-pos. versions are supplied with exclusive coding for the matching test plug and blind plug
- The components are supplied pre-marked according to the VDE Directive
- Test signals can be connected with touch-proof safety test leads (CAT III and IV/1000 V according to EN 61010-031)
- The test plugs are equipped with two gray test sockets per position, for further color versions, see the range of accessories
- Additional test leads, assembled with ring and fork-type cable lugs, can be attached with test sockets
- Other VDE versions available on request

#### Notes:

To create panel cutouts, see [phoenixcontact.net/products](http://phoenixcontact.net/products).

<sup>1)</sup> Derating curve available on request.

<sup>2)</sup> Rated surge voltage of 5 kV.

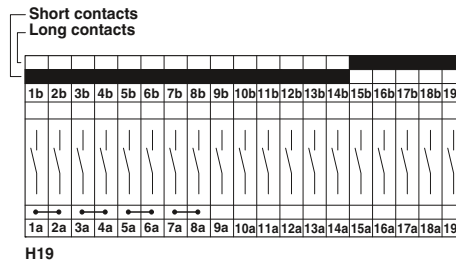

#### Max. electrical data

#### Rated data

Rated voltage	[V]	400 <sup>2)</sup>
Nominal current / cross section	[A] / [mm <sup>2</sup> ]	24 <sup>1)</sup> /6
Rated cross section	[mm <sup>2</sup> ]	6
Cross section range	AWG	20 - 8

#### Connection capacity

1 conductor	[mm <sup>2</sup> ]	0.5 - 10
2 stranded conductors with a TWIN ferrule	[mm <sup>2</sup> ]	0.5 - 6
Plug-in connection cross sections	[mm <sup>2</sup> ]	1 - 10

#### General data

Stripping length	[mm]	12
Tightening torque for wall fastening	[Nm]	0.8 - 1
Panel thickness	[mm]	1 - 4
Tightening torque: test socket screw	[Nm]	-
Insulating material		PA
Inflammability class according to UL 94		V0

Description	Color
<b>Test terminal strip</b> , for wall mounting	gray
<b>Test terminal strip</b> , for mounting on NS 35...	gray
<b>Test plug</b> , with twist grip	gray
With standard handle	gray
<b>Test plug</b> , 1-pos., with cover	gray
<b>Blind plug</b> , sealable	gray

<b>Test socket</b> , insulated	transparent red blue yellow green violet black gray brown
<b>Cover profile</b> , supply length 1 m	transparent
<b>Cover profile holder</b> , can be snapped on and sealed	gray
<b>Cover profile</b> , supply length 1 m	transparent
<b>End brackets</b> , for AP-ME cover profile, sealable, with storage option for jumpers	gray
<b>Holder</b> , for AP-ME cover profile	gray
<b>Fork-type cable lug</b> , insulated according to UL	red blue
<b>Ring cable lug</b> , insulated according to UL	red blue

#### Screwdriver

#### Lateral groove labeling



6 (10) mm<sup>2</sup>, 30 A, test terminal strip, for wall mounting, VDE coded type H19

#### Technical data

I <sub>max</sub> [A]	U <sub>max</sub> [V]	max. Ø [mm <sup>2</sup> ]	AWG
<b>30</b>	<b>400<sup>2)</sup></b>	<b>0.5 - 10</b>	<b>20 - 8</b>
IEC 60947-7-1			
IEC	UL/CUL	CSA	IEC/EN 60079-7
<b>Connection capacity</b>			
solid		stranded	
		ferrule	
		with/without plastic sleeve	
0.5 - 10	0.5 - 6	0.5 - 6	0.5 - 6
1 - 10	-	1 - 6	0.5 - 1.5
<b>General data</b>			
Stripping length		[mm]	
12			
Tightening torque for wall fastening		[Nm]	
0.8 - 1			
Panel thickness		[mm]	
1 - 4			
Tightening torque: test socket screw		[Nm]	
-			
Insulating material		PA	
Inflammability class according to UL 94		V0	

#### Ordering data

Type	Order No.	Pcs. / Pkt.
<b>PTWE 6-2/H19</b>	<b>3069447</b>	<b>1</b>

#### Accessories

<b>AP RSC-T</b>	<b>3059139</b>	<b>10</b>
<b>APH-UTWE 6-2</b>	<b>3069057</b>	<b>10</b>
<b>SF-SL 0,8X4,0-100</b>	<b>1212551</b>	<b>10</b>

UC-TM 8, UCT-TM 8, ZB 8 or TMT (EX9,5)R (see Catalog 5)



6 (10) mm<sup>2</sup>, 30 A, test terminal strip, for DIN rail mounting, VDE coded type H19



24 A, test plug, bridge assignment according to circuit diagram, VDE coded type H19



Blind plug, VDE coded type H19

Technical data			
I <sub>max</sub> [A]	U <sub>max</sub> [V]	max. Ø [mm <sup>2</sup> ]	AWG
30	400 <sup>2</sup> )	0.5 - 10	20 - 8
IEC 60947-7-1			
IEC			
UL/CUL	CSA	IEC/EN 60079-7	
400 <sup>2</sup> )	-	-	-
24 <sup>1</sup> )/6	-	-	-
6	-	-	-
20 - 8	-	-	-
solid	stranded	ferrule with/without plastic sleeve	
0.5 - 10	0.5 - 6	0.5 - 6	0.5 - 6 0.5 - 1.5
1 - 10	-	1 - 6	1 - 6
12	-	-	-
-	-	-	-
-	-	-	-
-	-	-	-
PA	-	-	-
V0	-	-	-

Technical data			
I <sub>max</sub> [A]	U <sub>max</sub> [V]	max. Ø [mm <sup>2</sup> ]	AWG
24	400 <sup>2</sup> )	0.5 - 2.5	20 - 14
IEC			
UL/CUL	CSA	IEC/EN 60079-7	
400 <sup>2</sup> )	-	-	-
24/2.5	-	-	-
6	-	-	-
20 - 14	-	-	-
solid	stranded	ferrule with/without plastic sleeve	
-	0.5 - 2.5	-	-
-	-	-	-
-	-	-	-
0.5 - 0.6	-	-	-
PA	-	-	-
V0	-	-	-

Technical data			
		max. Ø [mm <sup>2</sup> ]	AWG
		-	-
IEC			
UL/CUL	CSA	IEC/EN 60079-7	
-	-	-	-
-	-	-	-
-	-	-	-
-	-	-	-
solid	stranded	ferrule with/without plastic sleeve	
-	-	-	-
-	-	-	-
-	-	-	-
PA	-	-	-
V0	-	-	-

Ordering data		
Type	Order No.	Pcs. / Pkt.
PTRE 6-2/H19	3069460	1
FTP-2/H19	3069495	1
FTP-2/H19	3069482	1
FTP-2/1	3069469	1

Ordering data		
Type	Order No.	Pcs. / Pkt.
FBP-2/H19	3069677	1

Ordering data		
Type	Order No.	Pcs. / Pkt.
FBP-2/H19	3069677	1

Accessories			
AP-ME	METER	3034361	10
APH-ME		3034374	10
APT-ME		3034358	10
SF-SL 0,8X4,0-100		1212551	10

Accessories			
PSBJ-URTK 6 FARBLOS		3026450	10
PSBJ-URTK 6 RD		3026719	10
PSBJ-URTK 6 BU		3026434	10
PSBJ-URTK 6 YE		3026405	10
PSBJ-URTK 6 GN		3026418	10
PSBJ-URTK 6 VT		3026421	10
PSBJ-URTK 6 BK		3026447	10
PSBJ-URTK 6 GY		3026612	10
PSBJ-URTK 6 BN		3026971	10
C-FCI 1,5/M3		3240032	100
C-FCI 2,5/M3		3240037	100
C-RCI 1,5/M3		3240016	100
C-RCI 2,5/M3		3240021	100

Accessories			
UC-TM 8, UCT-TM 8, ZB 8 or TMT (EX9,5)R			

UC-TM 8, UCT-TM 8, ZB 8 or TMT (EX9,5)R (see Catalog 5)

UC-TM 8, UCT-TM 8, ZB 8 or TMT (EX9,5)R (see Catalog 5)

UC-TM 8, UCT-TM 8, ZB 8 or TMT (EX9,5)R (see Catalog 5)

## FAME plug-in test system

### Test terminal strip with PT ... push-in connection, VDE type I19, for wall and DIN rail mounting

The **VDE I19** version described here is suitable as a plug-in test system in medium voltage, outlet, and coupling protection, including selective ground fault detection.

- The test plugs are assembled with jumpers and contact tab lengths according to the circuit diagram
- A transparent covering hood protects the jumpers. The covering hood can only be removed by dismantling the test plug
- All VDE-specified 7, 14, and 19-pos. versions are supplied with exclusive coding for the matching test plug and blind plug
- The components are supplied pre-marked according to the VDE Directive
- Test signals can be connected with touch-proof safety test leads (CAT III and IV/1000 V according to EN 61010-031)
- The test plugs are equipped with two gray test sockets per position, for further color versions, see the range of accessories
- Additional test leads, assembled with ring and fork-type cable lugs, can be attached with test sockets
- Other VDE versions available on request

#### Notes:

To create panel cutouts, see [phoenixcontact.net/products](http://phoenixcontact.net/products).

<sup>1)</sup> Derating curve available on request.

<sup>2)</sup> Rated surge voltage of 5 kV.

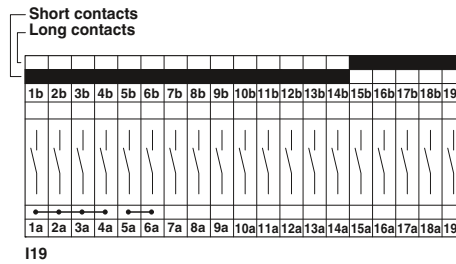

#### Max. electrical data

$I_{max}$  [A] **30**  $U_{max}$  [V] **400<sup>2)</sup>** max.  $\varnothing$  [mm<sup>2</sup>] **0.5 - 10** AWG **20 - 8**

#### Rated data

Rated voltage [V] 400<sup>2)</sup>  
Nominal current / cross section [A] / [mm<sup>2</sup>] 24<sup>1)</sup>/6  
Rated cross section [mm<sup>2</sup>] 6  
Cross section range AWG 20 - 8

#### Connection capacity

1 conductor [mm<sup>2</sup>] 0.5 - 10  
2 stranded conductors with a TWIN ferrule [mm<sup>2</sup>] 0.5 - 6  
Plug-in connection cross sections [mm<sup>2</sup>] 1 - 10

#### General data

Stripping length [mm] 12  
Tightening torque for wall fastening [Nm] 0.8 - 1  
Panel thickness [mm] 1 - 4  
Tightening torque: test socket screw [Nm] -  
Insulating material PA  
Inflammability class according to UL 94 V0

Description	Color
Test terminal strip, for wall mounting	gray
Test terminal strip, for mounting on NS 35...	gray
Test plug, with twist grip	gray
With standard handle	gray
Test plug, 1-pos., with cover	gray
Blind plug, sealable	gray

Test socket, insulated	transparent red blue yellow green violet black gray brown
Cover profile, supply length 1 m	transparent
Cover profile holder, can be snapped on and sealed	gray
Cover profile, supply length 1 m	transparent
End brackets, for AP-ME cover profile, sealable, with storage option for jumpers	gray
Holder, for AP-ME cover profile	gray
Fork-type cable lug, insulated according to UL	red blue
Ring cable lug, insulated according to UL	red blue

#### Screwdriver

#### Lateral groove labeling



6 (10) mm<sup>2</sup>, 30 A, test terminal strip, for wall mounting, VDE coded type I19

#### Technical data

$I_{max}$ [A]	$U_{max}$ [V]	max. $\varnothing$ [mm <sup>2</sup> ]	AWG
30	400 <sup>2)</sup>	0.5 - 10	20 - 8
IEC 60947-7-1			
IEC	UL/CUL	CSA	IEC/EN 60079-7
Rated data			
Rated voltage [V]	400 <sup>2)</sup>	-	-
Nominal current / cross section [A] / [mm <sup>2</sup> ]	24 <sup>1)</sup> /6	-	-
Rated cross section [mm <sup>2</sup> ]	6	-	-
Cross section range AWG	20 - 8	-	-
Connection capacity			
1 conductor [mm <sup>2</sup> ]	0.5 - 10	ferrule with/without plastic sleeve	
2 stranded conductors with a TWIN ferrule [mm <sup>2</sup> ]	0.5 - 6	0.5 - 6	0.5 - 6
Plug-in connection cross sections [mm <sup>2</sup> ]	1 - 10	-	0.5 - 1.5
General data			
Stripping length [mm]	12	1 - 6	1 - 6
Tightening torque for wall fastening [Nm]	0.8 - 1	-	-
Panel thickness [mm]	1 - 4	-	-
Tightening torque: test socket screw [Nm]	-	-	-
Insulating material	PA	-	-
Inflammability class according to UL 94	V0	-	-

#### Ordering data

Type	Order No.	Pcs. / Pkt.
PTWE 6-2/I19	3069448	1

#### Accessories

AP RSC-T	3059139	10
APH-UTWE 6-2	3069057	10
SF-SL 0,8X4,0-100	1212551	10

UC-TM 8, UCT-TM 8, ZB 8 or TMT (EX9,5)R (see Catalog 5)





6 (10) mm<sup>2</sup>, 30 A, test terminal strip, for DIN rail mounting, VDE coded type I19



24 A, test plug, bridge assignment according to circuit diagram, VDE coded type I19



Blind plug, VDE coded type I19

Technical data			
I <sub>max</sub> [A]	U <sub>max</sub> [V]	max. Ø [mm <sup>2</sup> ]	AWG
30	400 <sup>2)</sup>	0.5 - 10	20 - 8
IEC 60947-7-1			
IEC	UL/CUL	CSA	IEC/EN 60079-7
400 <sup>2)</sup>	-	-	-
24 <sup>1)</sup> /6	-	-	-
6	-	-	-
20 - 8	-	-	-
solid	stranded	ferrule with/without plastic sleeve	
0.5 - 10	0.5 - 6	0.5 - 6	0.5 - 6 0.5 - 1.5
1 - 10	-	1 - 6	1 - 6
12	-	-	-
-	-	-	-
-	-	-	-
-	-	-	-
PA	-	-	-
V0	-	-	-

Technical data			
I <sub>max</sub> [A]	U <sub>max</sub> [V]	max. Ø [mm <sup>2</sup> ]	AWG
24	400 <sup>2)</sup>	0.5 - 2.5	20 - 14
IEC			
UL/CUL	CSA	IEC/EN 60079-7	
400 <sup>2)</sup>	-	-	-
24/2.5	-	-	-
6	-	-	-
20 - 14	-	-	-
solid	stranded	ferrule with/without plastic sleeve	
-	0.5 - 2.5	-	-
-	-	-	-
-	-	-	-
0.5 - 0.6	-	-	-
PA	-	-	-
V0	-	-	-

Technical data			
		max. Ø [mm <sup>2</sup> ]	AWG
		-	-
IEC			
UL/CUL	CSA	IEC/EN 60079-7	
-	-	-	-
-	-	-	-
-	-	-	-
-	-	-	-
solid	stranded	ferrule with/without plastic sleeve	
-	-	-	-
-	-	-	-
-	-	-	-
PA	-	-	-
V0	-	-	-

Ordering data		
Type	Order No.	Pcs. / Pkt.
PTRE 6-2/I19	3069461	1
FTP-2/I19	3069496	1
FTP-2/1	3069483	1
FTP-2/1	3069469	1

Ordering data		
Type	Order No.	Pcs. / Pkt.
FTP-2/I19	3069496	1
FTP-2/1	3069483	1
FTP-2/1	3069469	1

Ordering data		
Type	Order No.	Pcs. / Pkt.
FBP-2/I19	3069678	1

Accessories			
AP-ME	METER	3034361	10
APH-ME		3034374	10
APT-ME		3034358	10
SF-SL 0,8X4,0-100		1212551	10

Accessories			
PSBJ-URTK 6 FARBLOS		3026450	10
PSBJ-URTK 6 RD		3026719	10
PSBJ-URTK 6 BU		3026434	10
PSBJ-URTK 6 YE		3026405	10
PSBJ-URTK 6 GN		3026418	10
PSBJ-URTK 6 VT		3026421	10
PSBJ-URTK 6 BK		3026447	10
PSBJ-URTK 6 GY		3026612	10
PSBJ-URTK 6 BN		3026971	10
C-FCI 1,5/M3		3240032	100
C-FCI 2,5/M3		3240037	100
C-RCI 1,5/M3		3240016	100
C-RCI 2,5/M3		3240021	100

Accessories			
UC-TM 8, UCT-TM 8, ZB 8 or TMT (EX9,5)R			

UC-TM 8, UCT-TM 8, ZB 8 or TMT (EX9,5)R (see Catalog 5)

UC-TM 8, UCT-TM 8, ZB 8 or TMT (EX9,5)R (see Catalog 5)

UC-TM 8, UCT-TM 8, ZB 8 or TMT (EX9,5)R (see Catalog 5)

## FAME plug-in test system

### Test terminal strip with UT ... screw connection, VDE type A7, for wall and DIN rail mounting

The **VDE A7** version described here is suitable as a plug-in test system in single-system current, voltage, and power relays, wattmetric and ground fault wiper relays, detuning level controllers or reverse power protection for generators.

- The test plugs are assembled with jumpers and contact tab lengths according to the circuit diagram
- A transparent covering hood protects the jumpers. The covering hood can only be removed by dismantling the test plug
- All VDE-specified 7, 14, and 19-pos. versions are supplied with exclusive coding for the matching test plug and blind plug
- The components are supplied pre-marked according to the VDE Directive
- Test signals can be connected with touch-proof safety test leads (CAT III and IV/1000 V according to EN 61010-031)
- The test plugs are equipped with two gray test sockets per position, for further color versions, see the range of accessories
- Additional test leads, assembled with ring and fork-type cable lugs, can be attached with test sockets
- Other VDE versions available on request

Notes:
To create panel cutouts, see <a href="http://phoenixcontact.net/products">phoenixcontact.net/products</a> .
1) Derating curve available on request.
2) Rated surge voltage of 5 kV.

Long contacts  
Short contacts

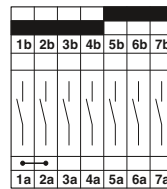

A7



6 (10) mm<sup>2</sup>, 30 A, test terminal strip, for wall mounting, VDE coded type A7

Max. electrical data	
<b>Rated data</b>	
Rated voltage	[V] 400 <sup>2)</sup>
Nominal current / cross section	[A] / [mm <sup>2</sup> ] 24 <sup>1)</sup> /6
Rated cross section	[mm <sup>2</sup> ] 6
Cross section range	AWG 24 - 8
Connection capacity	
1 conductor	[mm <sup>2</sup> ] 0.2 - 10
2 conductors (of the same type)	[mm <sup>2</sup> ] 0.2 - 2.5
2 stranded conductors with a TWIN ferrule	[mm <sup>2</sup> ] 0.25 - 1.5
General data	
Stripping length	[mm] 10
Screw thread	M4
Tightening torque	[Nm] 1.5 - 1.8
Tightening torque for wall fastening	[Nm] 0.8 - 1
Panel thickness	[mm] 1 - 4
Tightening torque: test socket screw	[Nm] -
Insulating material	PA
Inflammability class according to UL 94	V0

Technical data			
I <sub>max</sub> [A]	U <sub>max</sub> [V]	max. Ø [mm <sup>2</sup> ]	AWG
30	400 <sup>2)</sup>	0.2 - 10	24 - 8
IEC 60947-7-1	UL/CUL	CSA	IEC/EN 60079-7
Connection capacity		ferrule	
solid	stranded	with/without plastic sleeve	
0.2 - 10	0.2 - 10	0.25 - 6	0.25 - 6
0.2 - 2.5	0.2 - 2.5	0.25 - 1.5	-
			0.5 - 2.5

Description	Color
<b>Test terminal strip</b> , for wall mounting	gray
<b>Test terminal strip</b> , for mounting on NS 35...	gray
<b>Test plug</b> , with twist grip	gray
With standard handle	gray
<b>Test plug</b> , 1-pos., with cover	gray
<b>Blind plug</b> , sealable	gray

Ordering data		
Type	Order No.	Pcs. / Pkt.
<b>UTWE 6-2/A7</b>	<b>3069410</b>	1

<b>Test socket</b> , insulated	transparent red blue yellow green violet black gray brown
<b>Cover profile</b> , supply length 1 m	transparent
<b>Cover profile holder</b> , can be snapped on and sealed	gray
<b>Cover profile</b> , supply length 1 m	transparent
<b>End brackets</b> , for AP-ME cover profile, sealable, with storage option for jumpers	gray
<b>Holder</b> , for AP-ME cover profile	gray
<b>Fork-type cable lug</b> , insulated according to UL	red blue
<b>Ring cable lug</b> , insulated according to UL	red blue

Accessories		
<b>AP RSC-T</b>	<b>3059139</b>	10
<b>APH-UTWE 6-2</b>	<b>3069057</b>	10
<b>SF-SL 0,8X4,0-100</b>	<b>1212551</b>	10

<b>Screwdriver</b>	<b>UC-TM 8, UCT-TM 8, ZB 8 or TMT (EX9,5)R (see Catalog 5)</b>
<b>Lateral groove labeling</b>	



6 (10) mm<sup>2</sup>, 30 A, test terminal strip, for DIN rail mounting, VDE coded type A7



24 A, test plug, bridge assignment according to circuit diagram, VDE coded type A7



Blind plug, VDE coded type A7

Technical data			
I <sub>max</sub> [A]	U <sub>max</sub> [V]	max. Ø [mm <sup>2</sup> ]	AWG
30	400 <sup>2</sup> )	0.2 - 10	24 - 8
IEC 60947-7-1			
IEC	UL/CUL	CSA	IEC/EN 60079-7
400 <sup>2</sup> )	-	-	-
24 <sup>1</sup> )/6	-	-	-
6	-	-	-
24 - 8	-	-	-
solid	stranded	ferrule with/without plastic sleeve	
0.2 - 10	0.2 - 10	0.25 - 6	0.25 - 6
0.2 - 2.5	0.2 - 2.5	0.25 - 1.5	-
			0.5 - 2.5
10			
M4			
1.5 - 1.8			
-			
-			
-			
0.5 - 0.6			
PA			
V0			

Technical data			
I <sub>max</sub> [A]	U <sub>max</sub> [V]	max. Ø [mm <sup>2</sup> ]	AWG
24	400 <sup>2</sup> )	0.5 - 2.5	20 - 14
IEC			
UL/CUL	CSA	IEC/EN 60079-7	
400 <sup>2</sup> )	-	-	-
24/2.5	-	-	-
6	-	-	-
20 - 14	-	-	-
solid	stranded	ferrule with/without plastic sleeve	
-	0.5 - 2.5	-	-
-	-	-	-
-			
0.5 - 0.6			
PA			
V0			

Technical data			
		max. Ø [mm <sup>2</sup> ]	AWG
		-	-
IEC			
UL/CUL	CSA	IEC/EN 60079-7	
-	-	-	-
-	-	-	-
-	-	-	-
-	-	-	-
solid	stranded	ferrule with/without plastic sleeve	
-	-	-	-
-	-	-	-
-			
PA			
V0			

Ordering data		
Type	Order No.	Pcs. / Pkt.
UTRE 6-2/A7	3069423	1

Ordering data		
Type	Order No.	Pcs. / Pkt.
FTPR-2/A7	3069484	1
FTP-2/A7	3069470	1
FTP-2/1	3069469	1

Ordering data		
Type	Order No.	Pcs. / Pkt.
FBP-2/A7	3069497	1

Accessories			
AP-ME	METER	3034361	10
APH-ME		3034374	10
APT-ME		3034358	10
SF-SL	0,8X4,0-100	1212551	10

Accessories			
PSBJ-URTK 6 FARBLOS		3026450	10
PSBJ-URTK 6 RD		3026719	10
PSBJ-URTK 6 BU		3026434	10
PSBJ-URTK 6 YE		3026405	10
PSBJ-URTK 6 GN		3026418	10
PSBJ-URTK 6 VT		3026421	10
PSBJ-URTK 6 BK		3026447	10
PSBJ-URTK 6 GY		3026612	10
PSBJ-URTK 6 BN		3026971	10
C-FCI 1,5/M3		3240032	100
C-FCI 2,5/M3		3240037	100
C-RCI 1,5/M3		3240016	100
C-RCI 2,5/M3		3240021	100

Accessories			
-------------	--	--	--

UC-TM 8, UCT-TM 8, ZB 8 or TMT (EX9,5)R (see Catalog 5)

UC-TM 8, UCT-TM 8, ZB 8 or TMT (EX9,5)R (see Catalog 5)

UC-TM 8, UCT-TM 8, ZB 8 or TMT (EX9,5)R (see Catalog 5)

## FAME plug-in test system

### Test terminal strip with UT ... screw connection, VDE type B7, for wall and DIN rail mounting

The **VDE B7** version described here is suitable as a plug-in test system in digital differential protection as an addition to the F19 plug-in test system, see page 120.

- The test plugs are assembled with jumpers and contact tab lengths according to the circuit diagram
- A transparent covering hood protects the jumpers. The covering hood can only be removed by dismantling the test plug
- All VDE-specified 7, 14, and 19-pos. versions are supplied with exclusive coding for the matching test plug and blind plug
- The components are supplied pre-marked according to the VDE Directive
- Test signals can be connected with touch-proof safety test leads (CAT III and IV/1000 V according to EN 61010-031)
- The test plugs are equipped with two gray test sockets per position, for further color versions, see the range of accessories
- Additional test leads, assembled with ring and fork-type cable lugs, can be attached with test sockets
- Other VDE versions available on request

#### Notes:

To create panel cutouts, see [phoenixcontact.net/products](http://phoenixcontact.net/products).

<sup>1)</sup> Derating curve available on request.

<sup>2)</sup> Rated surge voltage of 5 kV.

Long contacts  
Short contacts

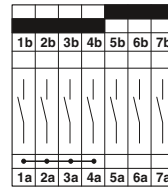

**6 (10) mm<sup>2</sup>, 30 A, test terminal strip, for wall mounting, VDE coded type B7**

Max. electrical data	
<b>Rated data</b>	
Rated voltage	[V] 400 <sup>2)</sup>
Nominal current / cross section	[A] / [mm <sup>2</sup> ] 24 <sup>1)</sup> /6
Rated cross section	[mm <sup>2</sup> ] 6
Cross section range	AWG 24 - 8
<b>Connection capacity</b>	
1 conductor	[mm <sup>2</sup> ] 0.2 - 10
2 conductors (of the same type)	[mm <sup>2</sup> ] 0.2 - 2.5
2 stranded conductors with a TWIN ferrule	[mm <sup>2</sup> ] 0.2 - 2.5
<b>General data</b>	
Stripping length	[mm] 10
Screw thread	M4
Tightening torque	[Nm] 1.5 - 1.8
Tightening torque for wall fastening	[Nm] 0.8 - 1
Panel thickness	[mm] 1 - 4
Tightening torque: test socket screw	[Nm] -
Insulating material	PA
Inflammability class according to UL 94	V0

Technical data			
$I_{max}$ [A]	$U_{max}$ [V]	max. $\varnothing$ [mm <sup>2</sup> ]	AWG
<b>30</b>	<b>400<sup>2)</sup></b>	<b>0.2 - 10</b>	<b>24 - 8</b>
IEC 60947-7-1	UL/CUL	CSA	IEC/EN 60079-7
<b>Connection capacity</b>		ferrule	
solid	stranded	with/without plastic sleeve	
0.2 - 10	0.2 - 10	0.25 - 6	0.25 - 6
0.2 - 2.5	0.2 - 2.5	0.25 - 1.5	-
			0.5 - 2.5

Description	Color
<b>Test terminal strip</b> , for wall mounting	gray
<b>Test terminal strip</b> , for mounting on NS 35...	gray
<b>Test plug</b> , with twist grip	gray
With standard handle	gray
<b>Test plug</b> , 1-pos., with cover	gray
<b>Blind plug</b> , sealable	gray

<b>Test socket</b> , insulated	transparent red blue yellow green violet black gray brown
<b>Cover profile</b> , supply length 1 m	transparent
<b>Cover profile holder</b> , can be snapped on and sealed	gray
<b>Cover profile</b> , supply length 1 m	transparent
<b>End brackets</b> , for AP-ME cover profile, sealable, with storage option for jumpers	gray
<b>Holder</b> , for AP-ME cover profile	gray
<b>Fork-type cable lug</b> , insulated according to UL	red blue
<b>Ring cable lug</b> , insulated according to UL	red blue

<b>Screwdriver</b>	SF-SL 0,8X4,0-100
<b>Lateral groove labeling</b>	UC-TM 8, UCT-TM 8, ZB 8 or TMT (EX9,5)R (see Catalog 5)

Ordering data		
Type	Order No.	Pcs. / Pkt.
<b>UTWE 6-2/B7</b>	<b>3069411</b>	<b>1</b>

Accessories		
<b>AP RSC-T</b>	<b>3059139</b>	<b>10</b>
<b>APH-UTWE 6-2</b>	<b>3069057</b>	<b>10</b>
<b>SF-SL 0,8X4,0-100</b>	<b>1212551</b>	<b>10</b>
<b>UC-TM 8, UCT-TM 8, ZB 8 or TMT (EX9,5)R (see Catalog 5)</b>		



6 (10) mm<sup>2</sup>, 30 A, test terminal strip, for DIN rail mounting, VDE coded type B7



24 A, test plug, bridge assignment according to circuit diagram, VDE coded type B7



Blind plug, VDE coded type B7

Technical data			
I <sub>max</sub> [A]	U <sub>max</sub> [V]	max. Ø [mm <sup>2</sup> ]	AWG
30	400 <sup>2</sup> )	0.2 - 10	24 - 8
IEC 60947-7-1			
IEC	UL/CUL	CSA	IEC/EN 60079-7
400 <sup>2</sup> )	-	-	-
24 <sup>1</sup> )/6	-	-	-
6	-	-	-
24 - 8	-	-	-
solid	stranded	ferrule	
		with/without plastic sleeve	
0.2 - 10	0.2 - 10	0.25 - 6	0.25 - 6
0.2 - 2.5	0.2 - 2.5	0.25 - 1.5	-
		0.5 - 2.5	
10	-	-	-
M4	-	-	-
1.5 - 1.8	-	-	-
-	-	-	-
-	-	-	-
-	-	-	-
PA	-	-	-
V0	-	-	-

Technical data			
I <sub>max</sub> [A]	U <sub>max</sub> [V]	max. Ø [mm <sup>2</sup> ]	AWG
24	400 <sup>2</sup> )	0.5 - 2.5	20 - 14
IEC			
UL/CUL	CSA	IEC/EN 60079-7	
400 <sup>2</sup> )	-	-	-
24/2.5	-	-	-
6	-	-	-
20 - 14	-	-	-
solid	stranded	ferrule	
		with/without plastic sleeve	
-	0.5 - 2.5	-	-
-	-	-	-
0.5 - 0.6	-	-	-
PA	-	-	-
V0	-	-	-

Technical data			
		max. Ø [mm <sup>2</sup> ]	AWG
		-	-
IEC			
UL/CUL	CSA	IEC/EN 60079-7	
-	-	-	-
-	-	-	-
-	-	-	-
-	-	-	-
solid	stranded	ferrule	
		with/without plastic sleeve	
-	-	-	-
-	-	-	-
PA	-	-	-
V0	-	-	-

Ordering data		
Type	Order No.	Pcs. / Pkt.
UTRE 6-2/B7	3069424	1

Ordering data		
Type	Order No.	Pcs. / Pkt.
FTPR-2/B7	3069485	1
FTP-2/B7	3069471	1
FTP-2/1	3069469	1

Ordering data		
Type	Order No.	Pcs. / Pkt.
FBP-2/B7	3069498	1

Accessories			
Type	Order No.	Pcs. / Pkt.	
AP-ME	METER	3034361	10
APH-ME		3034374	10
APT-ME		3034358	10
SF-SL	0,8X4,0-100	1212551	10

Accessories		
Type	Order No.	Pcs. / Pkt.
PSBJ-URTK 6 FARBLOS	3026450	10
PSBJ-URTK 6 RD	3026719	10
PSBJ-URTK 6 BU	3026434	10
PSBJ-URTK 6 YE	3026405	10
PSBJ-URTK 6 GN	3026418	10
PSBJ-URTK 6 VT	3026421	10
PSBJ-URTK 6 BK	3026447	10
PSBJ-URTK 6 GY	3026612	10
PSBJ-URTK 6 BN	3026971	10
C-FCI 1,5/M3	3240032	100
C-FCI 2,5/M3	3240037	100
C-RCI 1,5/M3	3240016	100
C-RCI 2,5/M3	3240021	100

Accessories		
Type	Order No.	Pcs. / Pkt.

UC-TM 8, UCT-TM 8, ZB 8 or TMT (EX9,5)R (see Catalog 5)

UC-TM 8, UCT-TM 8, ZB 8 or TMT (EX9,5)R (see Catalog 5)

UC-TM 8, UCT-TM 8, ZB 8 or TMT (EX9,5)R (see Catalog 5)

## FAME plug-in test system

### Test terminal strip with UT ... screw connection, VDE type E7, for wall and DIN rail mounting

The **VDE E7** version described here is suitable as a plug-in test system for single-stage automatic frequency load shedding (AFLS) and as rotor ground fault protection.

- The test plugs are assembled according to the circuit diagram
- A transparent covering hood protects the jumpers. The covering hood can only be removed by dismantling the test plug
- All VDE-specified 7, 14, and 19-pos. versions are supplied with exclusive coding for the matching test plug and blind plug
- The components are supplied pre-marked according to the VDE Directive
- Test signals can be connected with touch-proof safety test leads (CAT III and IV/1000 V according to EN 61010-031)
- The test plugs are equipped with two gray test sockets per position, for further color versions, see the range of accessories
- Additional test leads, assembled with ring and fork-type cable lugs, can be attached with test sockets
- Other VDE versions available on request

Notes:	
To create panel cutouts, see <a href="http://phoenixcontact.net/products">phoenixcontact.net/products</a> .	
1) Derating curve available on request.	
2) Rated surge voltage of 5 kV.	

Long contacts  
Short contacts

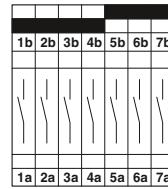

E7



6 (10) mm<sup>2</sup>, 30 A, test terminal strip, for wall mounting, VDE coded type E7

Max. electrical data	
<b>Rated data</b>	
Rated voltage	[V] 400 <sup>2)</sup>
Nominal current / cross section	[A] / [mm <sup>2</sup> ] 24 <sup>1)</sup> /6
Rated cross section	[mm <sup>2</sup> ] 6
Cross section range	AWG 24 - 8
Connection capacity	
1 conductor	[mm <sup>2</sup> ] 0.2 - 10
2 conductors (of the same type)	[mm <sup>2</sup> ] 0.2 - 2.5
2 stranded conductors with a TWIN ferrule	[mm <sup>2</sup> ] 0.25 - 1.5
General data	
Stripping length	[mm] 10
Screw thread	M4
Tightening torque	[Nm] 1.5 - 1.8
Tightening torque for wall fastening	[Nm] 0.8 - 1
Panel thickness	[mm] 1 - 4
Tightening torque: test socket screw	[Nm] -
Insulating material	PA
Inflammability class according to UL 94	V0

Technical data			
I <sub>max</sub> [A]	U <sub>max</sub> [V]	max. Ø [mm <sup>2</sup> ]	AWG
30	400 <sup>2)</sup>	0.2 - 10	24 - 8
IEC 60947-7-1			
IEC	UL/CUL	CSA	IEC/EN 60079-7
<b>Connection capacity</b>			
		ferrule	
		with/without plastic sleeve	
solid	stranded	0.25 - 6	0.25 - 6
		0.25 - 1.5	-
			0.5 - 2.5

Description	Color
<b>Test terminal strip</b> , for wall mounting	gray
<b>Test terminal strip</b> , for mounting on NS 35...	gray
<b>Test plug</b> , with twist grip	gray
With standard handle	gray
<b>Test plug</b> , 1-pos., with cover	gray
<b>Blind plug</b> , sealable	gray

Ordering data		
Type	Order No.	Pcs. / Pkt.
<b>UTWE 6-2/E7</b>	<b>3069412</b>	<b>1</b>

<b>Test socket</b> , insulated	transparent red blue yellow green violet black gray brown
<b>Cover profile</b> , supply length 1 m	transparent
<b>Cover profile holder</b> , can be snapped on and sealed	gray
<b>Cover profile</b> , supply length 1 m	transparent
<b>End brackets</b> , for AP-ME cover profile, sealable, with storage option for jumpers	gray
<b>Holder</b> , for AP-ME cover profile	gray
<b>Fork-type cable lug</b> , insulated according to UL	red blue
<b>Ring cable lug</b> , insulated according to UL	red blue

Accessories		
<b>AP RSC-T</b>	<b>3059139</b>	<b>10</b>
<b>APH-UTWE 6-2</b>	<b>3069057</b>	<b>10</b>
<b>SF-SL 0,8X4,0-100</b>	<b>1212551</b>	<b>10</b>

<b>Lateral groove labeling</b>	<b>UC-TM 8, UCT-TM 8, ZB 8 or TMT (EX9,5)R (see Catalog 5)</b>
--------------------------------	--



6 (10) mm<sup>2</sup>, 30 A, test terminal strip, for DIN rail mounting, VDE coded type E7



24 A, test plug, bridge assignment according to circuit diagram, VDE coded type E7



Blind plug, VDE coded type E7

Technical data			
I <sub>max</sub> [A]	U <sub>max</sub> [V]	max. Ø [mm <sup>2</sup> ]	AWG
30	400 <sup>2</sup> )	0.2 - 10	24 - 8
IEC 60947-7-1			
IEC	UL/CUL	CSA	IEC/EN 60079-7
400 <sup>2</sup> )	-	-	-
24 <sup>1</sup> )/6	-	-	-
6	-	-	-
24 - 8	-	-	-
solid	stranded	ferrule with/without plastic sleeve	
0.2 - 10	0.2 - 10	0.25 - 6	0.25 - 6
0.2 - 2.5	0.2 - 2.5	0.25 - 1.5	-
			0.5 - 2.5
10			
M4			
1.5 - 1.8			
-			
-			
-			
0.5 - 0.6			
PA			
V0			

Technical data			
I <sub>max</sub> [A]	U <sub>max</sub> [V]	max. Ø [mm <sup>2</sup> ]	AWG
24	400 <sup>2</sup> )	0.5 - 2.5	20 - 14
IEC			
UL/CUL	CSA	IEC/EN 60079-7	
400 <sup>2</sup> )	-	-	-
24/2.5	-	-	-
6	-	-	-
20 - 14	-	-	-
solid	stranded	ferrule with/without plastic sleeve	
-	0.5 - 2.5	-	-
-	-	-	-
-			
-			
0.5 - 0.6			
PA			
V0			

Technical data			
		max. Ø [mm <sup>2</sup> ]	AWG
		-	-
IEC			
UL/CUL	CSA	IEC/EN 60079-7	
-	-	-	-
-	-	-	-
-	-	-	-
-	-	-	-
solid	stranded	ferrule with/without plastic sleeve	
-	-	-	-
-	-	-	-
-			
-			
PA			
V0			

Ordering data		
Type	Order No.	Pcs. / Pkt.
UTRE 6-2/E7	3069425	1

Ordering data		
Type	Order No.	Pcs. / Pkt.
FTPR-2/E7	3069486	1
FTP-2/E7	3069472	1
FTP-2/1	3069469	1

Ordering data		
Type	Order No.	Pcs. / Pkt.
FBP-2/E7	3069499	1

Accessories			
AP-ME	METER	3034361	10
APH-ME		3034374	10
APT-ME		3034358	10
SF-SL	0,8X4,0-100	1212551	10

Accessories			
PSBJ-URTK 6 FARBLOS		3026450	10
PSBJ-URTK 6 RD		3026719	10
PSBJ-URTK 6 BU		3026434	10
PSBJ-URTK 6 YE		3026405	10
PSBJ-URTK 6 GN		3026418	10
PSBJ-URTK 6 VT		3026421	10
PSBJ-URTK 6 BK		3026447	10
PSBJ-URTK 6 GY		3026612	10
PSBJ-URTK 6 BN		3026971	10
C-FCI 1,5/M3		3240032	100
C-FCI 2,5/M3		3240037	100
C-RCI 1,5/M3		3240016	100
C-RCI 2,5/M3		3240021	100

Accessories			
-------------	--	--	--

UC-TM 8, UCT-TM 8, ZB 8 or TMT (EX9,5)R (see Catalog 5)

UC-TM 8, UCT-TM 8, ZB 8 or TMT (EX9,5)R (see Catalog 5)

UC-TM 8, UCT-TM 8, ZB 8 or TMT (EX9,5)R (see Catalog 5)

## FAME plug-in test system

### Test terminal strip with UT ... screw connection, VDE type A14, for wall and DIN rail mounting

The **VDE A14** version described here is suitable as a plug-in test system for three-stage automatic frequency load shedding (AFLS), as zero-power comparison protection, and as stator and rotor ground fault protection.

- The test plugs are assembled according to the circuit diagram
- A transparent covering hood protects the jumpers. The covering hood can only be removed by dismantling the test plug
- All VDE-specified 7, 14, and 19-pos. versions are supplied with exclusive coding for the matching test plug and blind plug
- The components are supplied pre-marked according to the VDE Directive
- Test signals can be connected with touch-proof safety test leads (CAT III and IV/1000 V according to EN 61010-031)
- The test plugs are equipped with two gray test sockets per position, for further color versions, see the range of accessories
- Additional test leads, assembled with ring and fork-type cable lugs, can be attached with test sockets
- Other VDE versions available on request

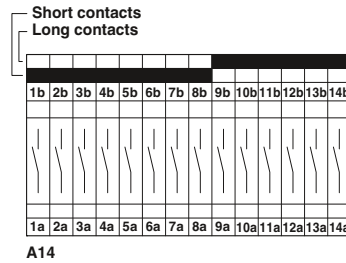

**6 (10) mm<sup>2</sup>, 30 A, test terminal strip, for wall mounting, VDE coded type A14**

Notes:	
To create panel cutouts, see phoenixcontact.net/products.	
1) Derating curve available on request.	
2) Rated surge voltage of 5 kV.	

Max. electrical data	
<b>Rated data</b>	
Rated voltage	[V] 400 <sup>2)</sup>
Nominal current / cross section	[A] / [mm <sup>2</sup> ] 24 <sup>1)</sup> /6
Rated cross section	[mm <sup>2</sup> ] 6
Cross section range	AWG 24 - 8
Connection capacity	
1 conductor	[mm <sup>2</sup> ] 0.2 - 10
2 conductors (of the same type)	[mm <sup>2</sup> ] 0.2 - 2.5
2 stranded conductors with a TWIN ferrule	[mm <sup>2</sup> ] 0.25 - 1.5
General data	
Stripping length	[mm] 10
Screw thread	M4
Tightening torque	[Nm] 1.5 - 1.8
Tightening torque for wall fastening	[Nm] 0.8 - 1
Panel thickness	[mm] 1 - 4
Tightening torque: test socket screw	[Nm] -
Insulating material	PA
Inflammability class according to UL 94	V0

Technical data			
$I_{max}$ [A]	$U_{max}$ [V]	max. $\varnothing$ [mm <sup>2</sup> ]	AWG
<b>30</b>	<b>400<sup>2)</sup></b>	<b>0.2 - 10</b>	<b>24 - 8</b>
IEC 60947-7-1			
IEC	UL/CUL	CSA	IEC/EN 60079-7
Connection capacity		ferrule	
solid	stranded	with/without plastic sleeve	
0.2 - 10	0.2 - 10	0.25 - 6	0.25 - 6
0.2 - 2.5	0.2 - 2.5	0.25 - 1.5	-
			0.5 - 2.5

Description	Color
<b>Test terminal strip</b> , for wall mounting	gray
<b>Test terminal strip</b> , for mounting on NS 35...	gray
<b>Test plug</b> , with twist grip	gray
With standard handle	gray
<b>Test plug</b> , 1-pos., with cover	gray
<b>Blind plug</b> , sealable	gray

<b>Test socket</b> , insulated	transparent red blue yellow green violet black gray brown
<b>Cover profile</b> , supply length 1 m	transparent
<b>Cover profile holder</b> , can be snapped on and sealed	gray
<b>Cover profile</b> , supply length 1 m	transparent
<b>End brackets</b> , for AP-ME cover profile, sealable, with storage option for jumpers	gray
<b>Holder</b> , for AP-ME cover profile	gray
<b>Fork-type cable lug</b> , insulated according to UL	red blue
<b>Ring cable lug</b> , insulated according to UL	red blue
<b>Screwdriver</b>	

<b>Lateral groove labeling</b>	
--------------------------------	--

Ordering data		
Type	Order No.	Pcs. / Pkt.
<b>UTWE 6-2/A14</b>	<b>3069413</b>	<b>1</b>

Accessories		
<b>AP RSC-T</b>	<b>3059139</b>	<b>10</b>
<b>APH-UTWE 6-2</b>	<b>3069057</b>	<b>10</b>
<b>SF-SL 0,8X4,0-100</b>	<b>1212551</b>	<b>10</b>
<b>UC-TM 8, UCT-TM 8, ZB 8 or TMT (EX9,5)R</b> (see Catalog 5)		





6 (10) mm<sup>2</sup>, 30 A, test terminal strip, for DIN rail mounting, VDE coded type A14



24 A, test plug, bridge assignment according to circuit diagram, VDE coded type A14



Blind plug, VDE coded type A14

Technical data			
I <sub>max</sub> [A]	U <sub>max</sub> [V]	max. Ø [mm <sup>2</sup> ]	AWG
30	400 <sup>2</sup> )	0.2 - 10	24 - 8
IEC 60947-7-1			
IEC	UL/CUL	CSA	IEC/EN 60079-7
400 <sup>2</sup> )	-	-	-
24 <sup>1</sup> )/6	-	-	-
6	-	-	-
24 - 8	-	-	-
solid	stranded	ferrule	
		with/without plastic sleeve	
0.2 - 10	0.2 - 10	0.25 - 6	0.25 - 6
0.2 - 2.5	0.2 - 2.5	0.25 - 1.5	-
		0.5 - 2.5	
10	-	-	-
M4	-	-	-
1.5 - 1.8	-	-	-
-	-	-	-
-	-	-	-
-	-	-	-
PA	-	-	-
V0	-	-	-

Technical data			
I <sub>max</sub> [A]	U <sub>max</sub> [V]	max. Ø [mm <sup>2</sup> ]	AWG
24	400 <sup>2</sup> )	0.5 - 2.5	20 - 14
IEC			
UL/CUL	CSA	IEC/EN 60079-7	
400 <sup>2</sup> )	-	-	-
24/2.5	-	-	-
6	-	-	-
20 - 14	-	-	-
solid	stranded	ferrule	
		with/without plastic sleeve	
-	0.5 - 2.5	-	-
-	-	-	-
0.5 - 0.6	-	-	-
PA	-	-	-
V0	-	-	-

Technical data			
		max. Ø [mm <sup>2</sup> ]	AWG
		-	-
IEC			
UL/CUL	CSA	IEC/EN 60079-7	
-	-	-	-
-	-	-	-
-	-	-	-
-	-	-	-
solid	stranded	ferrule	
		with/without plastic sleeve	
-	-	-	-
-	-	-	-
PA	-	-	-
V0	-	-	-

Ordering data		
Type	Order No.	Pcs. / Pkt.
UTRE 6-2/A14	3069426	1

Ordering data		
Type	Order No.	Pcs. / Pkt.
FTPR-2/A14	3069487	1
FTP-2/A14	3069474	1
FTP-2/1	3069469	1

Ordering data		
Type	Order No.	Pcs. / Pkt.
FBP-2/A14	3069500	1

Accessories			
AP-ME	METER	3034361	10
APH-ME		3034374	10
APT-ME		3034358	10
SF-SL	0,8X4,0-100	1212551	10

Accessories			
PSBJ-URTK 6 FARBLOS		3026450	10
PSBJ-URTK 6 RD		3026719	10
PSBJ-URTK 6 BU		3026434	10
PSBJ-URTK 6 YE		3026405	10
PSBJ-URTK 6 GN		3026418	10
PSBJ-URTK 6 VT		3026421	10
PSBJ-URTK 6 BK		3026447	10
PSBJ-URTK 6 GY		3026612	10
PSBJ-URTK 6 BN		3026971	10
C-FCI 1,5/M3		3240032	100
C-FCI 2,5/M3		3240037	100
C-RCI 1,5/M3		3240016	100
C-RCI 2,5/M3		3240021	100

Accessories			
-------------	--	--	--

UC-TM 8, UCT-TM 8, ZB 8 or TMT (EX9,5)R (see Catalog 5)

UC-TM 8, UCT-TM 8, ZB 8 or TMT (EX9,5)R (see Catalog 5)

UC-TM 8, UCT-TM 8, ZB 8 or TMT (EX9,5)R (see Catalog 5)

## FAME plug-in test system

### Test terminal strip with UT ... screw connection, VDE type B14, for wall and DIN rail mounting

The **VDE B14** version described here is suitable as a plug-in test system in overcurrent directional protection, distance protection for high and medium voltage, as well as voltage regulation.

- The test plugs are assembled with jumpers and contact tab lengths according to the circuit diagram
- A transparent covering hood protects the jumpers. The covering hood can only be removed by dismantling the test plug
- All VDE-specified 7, 14, and 19-pos. versions are supplied with exclusive coding for the matching test plug and blind plug
- The components are supplied pre-marked according to the VDE Directive
- Test signals can be connected with touch-proof safety test leads (CAT III and IV/1000 V according to EN 61010-031)
- The test plugs are equipped with two gray test sockets per position, for further color versions, see the range of accessories
- Additional test leads, assembled with ring and fork-type cable lugs, can be attached with test sockets
- Other VDE versions available on request

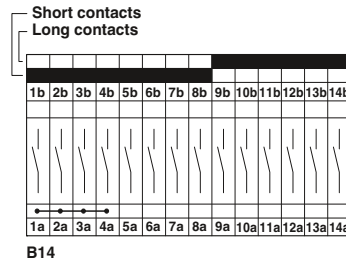

6 (10) mm<sup>2</sup>, 30 A, test terminal strip, for wall mounting, VDE coded type B14

Notes:
To create panel cutouts, see phoenixcontact.net/products.
1) Derating curve available on request.
2) Rated surge voltage of 5 kV.

Max. electrical data	
<b>Rated data</b>	
Rated voltage	[V] 400 <sup>2)</sup>
Nominal current / cross section	[A] / [mm <sup>2</sup> ] 24 <sup>1)</sup> /6
Rated cross section	[mm <sup>2</sup> ] 6
Cross section range	AWG 24 - 8
<b>Connection capacity</b>	
1 conductor	[mm <sup>2</sup> ] 0.2 - 10
2 conductors (of the same type)	[mm <sup>2</sup> ] 0.2 - 2.5
2 stranded conductors with a TWIN ferrule	[mm <sup>2</sup> ] 0.25 - 1.5
<b>General data</b>	
Stripping length	[mm] 10
Screw thread	M4
Tightening torque	[Nm] 1.5 - 1.8
Tightening torque for wall fastening	[Nm] 0.8 - 1
Panel thickness	[mm] 1 - 4
Tightening torque: test socket screw	[Nm] -
Insulating material	PA
Inflammability class according to UL 94	V0

Technical data			
I <sub>max</sub> [A]	U <sub>max</sub> [V]	max. Ø [mm <sup>2</sup> ]	AWG
30	400 <sup>2)</sup>	0.2 - 10	24 - 8
IEC 60947-7-1			
IEC	UL/CUL	CSA	IEC/EN 60079-7
<b>Connection capacity</b>			
solid		stranded	
		ferrule	
		with/without plastic sleeve	
0.2 - 10	0.2 - 10	0.25 - 6	0.25 - 6
0.2 - 2.5	0.2 - 2.5	0.25 - 1.5	-
			0.5 - 2.5

Description	Color
<b>Test terminal strip</b> , for wall mounting	gray
<b>Test terminal strip</b> , for mounting on NS 35...	gray
<b>Test plug</b> , with twist grip	gray
With standard handle	gray
<b>Test plug</b> , 1-pos., with cover	gray
<b>Blind plug</b> , sealable	gray

Ordering data		
Type	Order No.	Pcs. / Pkt.
<b>UTWE 6-2/B14</b>	<b>3069414</b>	1

<b>Test socket</b> , insulated	transparent red blue yellow green violet black gray brown
<b>Cover profile</b> , supply length 1 m	transparent
<b>Cover profile holder</b> , can be snapped on and sealed	gray
<b>Cover profile</b> , supply length 1 m	transparent
<b>End brackets</b> , for AP-ME cover profile, sealable, with storage option for jumpers	gray
<b>Holder</b> , for AP-ME cover profile	gray
<b>Fork-type cable lug</b> , insulated according to UL	red blue
<b>Ring cable lug</b> , insulated according to UL	red blue

Accessories		
Type	Order No.	Pcs. / Pkt.
<b>AP RSC-T</b>	<b>3059139</b>	10
<b>APH-UTWE 6-2</b>	<b>3069057</b>	10
<b>SF-SL 0,8X4,0-100</b>	<b>1212551</b>	10

Screwdriver
<b>Lateral groove labeling</b>

<b>UC-TM 8, UCT-TM 8, ZB 8 or TMT (EX9,5)R</b> (see Catalog 5)
---



6 (10) mm<sup>2</sup>, 30 A, test terminal strip, for DIN rail mounting, VDE coded type B14



24 A, test plug, bridge assignment according to circuit diagram, VDE coded type B14



Blind plug, VDE coded type B14

Technical data			
I <sub>max</sub> [A]	U <sub>max</sub> [V]	max. Ø [mm <sup>2</sup> ]	AWG
30	400 <sup>2</sup> )	0.2 - 10	24 - 8
IEC 60947-7-1			
IEC	UL/CUL	CSA	IEC/EN 60079-7
400 <sup>2</sup> )	-	-	-
24 <sup>1</sup> )/6	-	-	-
6	-	-	-
24 - 8	-	-	-
solid	stranded	ferrule with/without plastic sleeve	
0.2 - 10	0.2 - 10	0.25 - 6	0.25 - 6
0.2 - 2.5	0.2 - 2.5	0.25 - 1.5	-
			0.5 - 2.5
10			
M4			
1.5 - 1.8			
-			
-			
-			
PA			
V0			

Technical data			
I <sub>max</sub> [A]	U <sub>max</sub> [V]	max. Ø [mm <sup>2</sup> ]	AWG
24	400 <sup>2</sup> )	0.5 - 2.5	20 - 14
IEC			
UL/CUL	CSA	IEC/EN 60079-7	
400 <sup>2</sup> )	-	-	-
24/2.5	-	-	-
6	-	-	-
20 - 14	-	-	-
solid	stranded	ferrule with/without plastic sleeve	
-	0.5 - 2.5	-	-
-	-	-	-
0.5 - 0.6			
PA			
V0			

Technical data			
		max. Ø [mm <sup>2</sup> ]	AWG
		-	-
IEC			
UL/CUL	CSA	IEC/EN 60079-7	
-	-	-	-
-	-	-	-
-	-	-	-
-	-	-	-
solid	stranded	ferrule with/without plastic sleeve	
-	-	-	-
-	-	-	-
PA			
V0			

Ordering data		
Type	Order No.	Pcs. / Pkt.
UTRE 6-2/B14	3069427	1

Ordering data		
Type	Order No.	Pcs. / Pkt.
FTPR-2/B14	3069488	1
FTP-2/B14	3069475	1
FTP-2/1	3069469	1

Ordering data		
Type	Order No.	Pcs. / Pkt.
FBP-2/B14	3069501	1

Accessories			
AP-ME	METER	3034361	10
APH-ME		3034374	10
APT-ME		3034358	10
SF-SL	0,8X4,0-100	1212551	10

Accessories			
PSBJ-URTK 6 FARBLOS		3026450	10
PSBJ-URTK 6 RD		3026719	10
PSBJ-URTK 6 BU		3026434	10
PSBJ-URTK 6 YE		3026405	10
PSBJ-URTK 6 GN		3026418	10
PSBJ-URTK 6 VT		3026421	10
PSBJ-URTK 6 BK		3026447	10
PSBJ-URTK 6 GY		3026612	10
PSBJ-URTK 6 BN		3026971	10
C-FCI 1,5/M3		3240032	100
C-FCI 2,5/M3		3240037	100
C-RCI 1,5/M3		3240016	100
C-RCI 2,5/M3		3240021	100

Accessories			
-------------	--	--	--

UC-TM 8, UCT-TM 8, ZB 8 or TMT (EX9,5)R (see Catalog 5)

UC-TM 8, UCT-TM 8, ZB 8 or TMT (EX9,5)R (see Catalog 5)

UC-TM 8, UCT-TM 8, ZB 8 or TMT (EX9,5)R (see Catalog 5)

## FAME plug-in test system

### Test terminal strip with UT ... screw connection, VDE type C14, for wall and DIN rail mounting

The **VDE C14** version described here is suitable as a plug-in test system in overcurrent time protection, unbalanced load protection, and stator ground fault protection for busbar operation.

- The test plugs are assembled with jumpers and contact tab lengths according to the circuit diagram
- A transparent covering hood protects the jumpers. The covering hood can only be removed by dismantling the test plug
- All VDE-specified 7, 14, and 19-pos. versions are supplied with exclusive coding for the matching test plug and blind plug
- The components are supplied pre-marked according to the VDE Directive
- Test signals can be connected with touch-proof safety test leads (CAT III and IV/1000 V according to EN 61010-031)
- The test plugs are equipped with two gray test sockets per position, for further color versions, see the range of accessories
- Additional test leads, assembled with ring and fork-type cable lugs, can be attached with test sockets
- Other VDE versions available on request

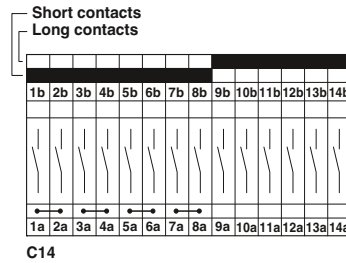

6 (10) mm<sup>2</sup>, 30 A, test terminal strip, for wall mounting, VDE coded type C14

Notes:	
To create panel cutouts, see <a href="http://phoenixcontact.net/products">phoenixcontact.net/products</a> .	
1) Derating curve available on request.	
2) Rated surge voltage of 5 kV.	

Max. electrical data	
<b>Rated data</b>	
Rated voltage	[V] 400 <sup>2)</sup>
Nominal current / cross section	[A] / [mm <sup>2</sup> ] 24 <sup>1)</sup> /6
Rated cross section	[mm <sup>2</sup> ] 6
Cross section range	AWG 24 - 8
Connection capacity	
1 conductor	[mm <sup>2</sup> ] 0.2 - 10
2 conductors (of the same type)	[mm <sup>2</sup> ] 0.2 - 2.5
2 stranded conductors with a TWIN ferrule	[mm <sup>2</sup> ] 0.25 - 1.5
General data	
Stripping length	[mm] 10
Screw thread	M4
Tightening torque	[Nm] 1.5 - 1.8
Tightening torque for wall fastening	[Nm] 0.8 - 1
Panel thickness	[mm] 1 - 4
Tightening torque: test socket screw	[Nm] -
Insulating material	PA
Inflammability class according to UL 94	V0

Technical data			
I <sub>max</sub> [A]	U <sub>max</sub> [V]	max. Ø [mm <sup>2</sup> ]	AWG
30	400 <sup>2)</sup>	0.2 - 10	24 - 8
IEC 60947-7-1			
IEC	UL/CUL	CSA	IEC/EN 60079-7
Connection capacity		ferrule	
solid	stranded	with/without plastic sleeve	
0.2 - 10	0.2 - 10	0.25 - 6	0.25 - 6
0.2 - 2.5	0.2 - 2.5	0.25 - 1.5	-
			0.5 - 2.5

Description	Color
<b>Test terminal strip</b> , for wall mounting	gray
<b>Test terminal strip</b> , for mounting on NS 35...	gray
<b>Test plug</b> , with twist grip	gray
With standard handle	gray
<b>Test plug</b> , 1-pos., with cover	gray
<b>Blind plug</b> , sealable	gray

<b>Test socket</b> , insulated	transparent
	red
	blue
	yellow
	green
	violet
	black
	gray
	brown
<b>Cover profile</b> , supply length 1 m	transparent
<b>Cover profile holder</b> , can be snapped on and sealed	gray
<b>Cover profile</b> , supply length 1 m	transparent
<b>End brackets</b> , for AP-ME cover profile, sealable, with storage option for jumpers	gray
<b>Holder</b> , for AP-ME cover profile	gray
<b>Fork-type cable lug</b> , insulated according to UL	red
	blue
<b>Ring cable lug</b> , insulated according to UL	red
	blue
<b>Screwdriver</b>	

<b>Lateral groove labeling</b>
--------------------------------

Ordering data		
Type	Order No.	Pcs. / Pkt.
<b>UTWE 6-2/C14</b>	<b>3069415</b>	<b>1</b>

Accessories		
<b>AP RSC-T</b>	<b>3059139</b>	<b>10</b>
<b>APH-UTWE 6-2</b>	<b>3069057</b>	<b>10</b>
<b>SF-SL 0,8X4,0-100</b>	<b>1212551</b>	<b>10</b>
<b>UC-TM 8, UCT-TM 8, ZB 8 or TMT (EX9,5)R</b> (see Catalog 5)		



6 (10) mm<sup>2</sup>, 30 A, test terminal strip, for DIN rail mounting, VDE coded type C14



24 A, test plug, bridge assignment according to circuit diagram, VDE coded type C14



Blind plug, VDE coded type C14

Technical data			
I <sub>max</sub> [A]	U <sub>max</sub> [V]	max. Ø [mm <sup>2</sup> ]	AWG
30	400 <sup>2</sup> )	0.2 - 10	24 - 8
IEC 60947-7-1			
IEC			
UL/CUL	CSA	IEC/EN 60079-7	
400 <sup>2</sup> )	-	-	-
24 <sup>1</sup> )/6	-	-	-
6	-	-	-
24 - 8	-	-	-
solid	stranded	ferrule	
with/without plastic sleeve			
0.2 - 10	0.2 - 10	0.25 - 6	0.25 - 6
0.2 - 2.5	0.2 - 2.5	0.25 - 1.5	-
0.5 - 2.5			
10	-	-	-
M4	-	-	-
1.5 - 1.8	-	-	-
-	-	-	-
-	-	-	-
-	-	-	-
PA	-	-	-
V0	-	-	-

Technical data			
I <sub>max</sub> [A]	U <sub>max</sub> [V]	max. Ø [mm <sup>2</sup> ]	AWG
24	400 <sup>2</sup> )	0.5 - 2.5	20 - 14
IEC			
UL/CUL	CSA	IEC/EN 60079-7	
400 <sup>2</sup> )	-	-	-
24/2.5	-	-	-
6	-	-	-
20 - 14	-	-	-
solid	stranded	ferrule	
with/without plastic sleeve			
-	0.5 - 2.5	-	-
-	-	-	-
0.5 - 0.6	-	-	-
PA	-	-	-
V0	-	-	-

Technical data			
		max. Ø [mm <sup>2</sup> ]	AWG
		-	-
IEC			
UL/CUL	CSA	IEC/EN 60079-7	
-	-	-	-
-	-	-	-
-	-	-	-
-	-	-	-
solid	stranded	ferrule	
with/without plastic sleeve			
-	-	-	-
-	-	-	-
PA	-	-	-
V0	-	-	-

Ordering data		
Type	Order No.	Pcs. / Pkt.
UTRE 6-2/C14	3069428	1

Ordering data		
Type	Order No.	Pcs. / Pkt.
FTPR-2/C14	3069489	1
FTP-2/C14	3069476	1
FTP-2/1	3069469	1

Ordering data		
Type	Order No.	Pcs. / Pkt.
FBP-2/C14	3069502	1

Accessories			
AP-ME	METER	3034361	10
APH-ME		3034374	10
APT-ME		3034358	10
SF-SL	0,8X4,0-100	1212551	10

Accessories			
PSBJ-URTK 6 FARBLOS		3026450	10
PSBJ-URTK 6 RD		3026719	10
PSBJ-URTK 6 BU		3026434	10
PSBJ-URTK 6 YE		3026405	10
PSBJ-URTK 6 GN		3026418	10
PSBJ-URTK 6 VT		3026421	10
PSBJ-URTK 6 BK		3026447	10
PSBJ-URTK 6 GY		3026612	10
PSBJ-URTK 6 BN		3026971	10
C-FCI 1,5/M3		3240032	100
C-FCI 2,5/M3		3240037	100
C-RCI 1,5/M3		3240016	100
C-RCI 2,5/M3		3240021	100

Accessories			
-------------	--	--	--

UC-TM 8, UCT-TM 8, ZB 8 or TMT (EX9,5)R (see Catalog 5)

UC-TM 8, UCT-TM 8, ZB 8 or TMT (EX9,5)R (see Catalog 5)

UC-TM 8, UCT-TM 8, ZB 8 or TMT (EX9,5)R (see Catalog 5)

# Modular terminal blocks

## FAME plug-in test system

### Test terminal strip with UT ... screw connection, VDE type B19, for wall and DIN rail mounting

The **VDE B19** version described here is suitable as a plug-in test system in distance protection for high voltage.

- The test plugs are assembled with jumpers and contact tab lengths according to the circuit diagram
- A transparent covering hood protects the jumpers. The covering hood can only be removed by dismantling the test plug
- All VDE-specified 7, 14, and 19-pos. versions are supplied with exclusive coding for the matching test plug and blind plug
- The components are supplied pre-marked according to the VDE Directive
- Test signals can be connected with touch-proof safety test leads (CAT III and IV/1000 V according to EN 61010-031)
- The test plugs are equipped with two gray test sockets per position, for further color versions, see the range of accessories
- Additional test leads, assembled with ring and fork-type cable lugs, can be attached with test sockets
- Other VDE versions available on request

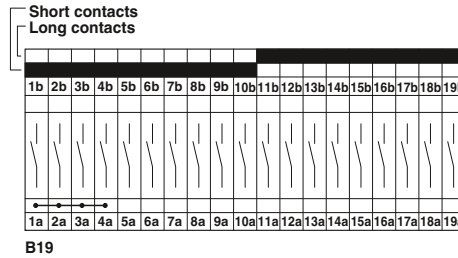

**6 (10) mm<sup>2</sup>, 30 A, test terminal strip, for wall mounting, VDE coded type B19**

Notes:	
To create panel cutouts, see <a href="http://phoenixcontact.net/products">phoenixcontact.net/products</a> .	
1) Derating curve available on request.	
2) Rated surge voltage of 5 kV.	

Max. electrical data	
<b>Rated data</b>	
Rated voltage	[V] 400 <sup>2)</sup>
Nominal current / cross section	[A] / [mm <sup>2</sup> ] 24 <sup>1)</sup> /6
Rated cross section	[mm <sup>2</sup> ] 6
Cross section range	AWG 24 - 8
Connection capacity	
1 conductor	[mm <sup>2</sup> ] 0.2 - 10
2 conductors (of the same type)	[mm <sup>2</sup> ] 0.2 - 2.5
2 stranded conductors with a TWIN ferrule	[mm <sup>2</sup> ] 0.25 - 6
General data	
Stripping length	[mm] 10
Screw thread	M4
Tightening torque	[Nm] 1.5 - 1.8
Tightening torque for wall fastening	[Nm] 0.8 - 1
Panel thickness	[mm] 1 - 4
Tightening torque: test socket screw	[Nm] -
Insulating material	PA
Inflammability class according to UL 94	V0

Technical data			
I <sub>max</sub> [A]	U <sub>max</sub> [V]	max. Ø [mm <sup>2</sup> ]	AWG
<b>30</b>	<b>400<sup>2)</sup></b>	<b>0.2 - 10</b>	<b>24 - 8</b>
IEC 60947-7-1	UL/CUL	CSA	IEC/EN 60079-7
Connection capacity		ferrule	
solid	stranded	with/without plastic sleeve	
0.2 - 10	0.2 - 10	0.25 - 6	0.25 - 6
0.2 - 2.5	0.2 - 2.5	0.25 - 1.5	-
			0.5 - 2.5

Description	Color
<b>Test terminal strip</b> , for wall mounting	gray
<b>Test terminal strip</b> , for mounting on NS 35...	gray
<b>Test plug</b> , with twist grip	gray
With standard handle	gray
<b>Test plug</b> , 1-pos., with cover	gray
<b>Blind plug</b> , sealable	gray

Ordering data		
Type	Order No.	Pcs. / Pkt.
<b>UTWE 6-2/B19</b>	<b>3069416</b>	<b>1</b>

<b>Test socket</b> , insulated	transparent red blue yellow green violet black gray brown
<b>Cover profile</b> , supply length 1 m	transparent
<b>Cover profile holder</b> , can be snapped on and sealed	gray
<b>Cover profile</b> , supply length 1 m	transparent
<b>End brackets</b> , for AP-ME cover profile, sealable, with storage option for jumpers	gray
<b>Holder</b> , for AP-ME cover profile	gray
<b>Fork-type cable lug</b> , insulated according to UL	red blue
<b>Ring cable lug</b> , insulated according to UL	red blue

Accessories		
<b>AP RSC-T</b>	<b>3059139</b>	<b>10</b>
<b>APH-UTWE 6-2</b>	<b>3069057</b>	<b>10</b>
<b>SF-SL 0,8X4,0-100</b>	<b>1212551</b>	<b>10</b>

Screwdriver
<b>Lateral groove labeling</b>

<b>UC-TM 8, UCT-TM 8, ZB 8 or TMT (EX9,5)R (see Catalog 5)</b>
--



6 (10) mm<sup>2</sup>, 30 A, test terminal strip, for DIN rail mounting, VDE coded type B19



24 A, test plug, bridge assignment according to circuit diagram, VDE coded type B19



Blind plug, VDE coded type B19

Technical data			
I <sub>max</sub> [A]	U <sub>max</sub> [V]	max. Ø [mm <sup>2</sup> ]	AWG
30	400 <sup>2</sup> )	0.2 - 10	24 - 8
IEC 60947-7-1			
IEC	UL/CUL	CSA	IEC/EN 60079-7
400 <sup>2</sup> )	-	-	-
24 <sup>1</sup> )/6	-	-	-
6	-	-	-
24 - 8	-	-	-
solid	stranded	ferrule	
		with/without plastic sleeve	
0.2 - 10	0.2 - 10	0.25 - 6	0.25 - 6
0.2 - 2.5	0.2 - 2.5	0.25 - 1.5	-
		0.5 - 2.5	
10	-	-	-
M4	-	-	-
1.5 - 1.8	-	-	-
-	-	-	-
-	-	-	-
-	-	-	-
PA	-	-	-
V0	-	-	-

Technical data			
I <sub>max</sub> [A]	U <sub>max</sub> [V]	max. Ø [mm <sup>2</sup> ]	AWG
24	400 <sup>2</sup> )	0.5 - 2.5	20 - 14
IEC			
UL/CUL	CSA	IEC/EN 60079-7	
400 <sup>2</sup> )	-	-	-
24/2.5	-	-	-
6	-	-	-
20 - 14	-	-	-
solid	stranded	ferrule	
		with/without plastic sleeve	
-	0.5 - 2.5	-	-
-	-	-	-
0.5 - 0.6	-	-	-
PA	-	-	-
V0	-	-	-

Technical data			
		max. Ø [mm <sup>2</sup> ]	AWG
		-	-
IEC			
UL/CUL	CSA	IEC/EN 60079-7	
-	-	-	-
-	-	-	-
-	-	-	-
-	-	-	-
solid	stranded	ferrule	
		with/without plastic sleeve	
-	-	-	-
-	-	-	-
PA	-	-	-
V0	-	-	-

Ordering data		
Type	Order No.	Pcs. / Pkt.
UTRE 6-2/B19	3069429	1

Ordering data		
Type	Order No.	Pcs. / Pkt.
FTPR-2/B19	3069490	1
FTP-2/B19	3069477	1
FTP-2/1	3069469	1

Ordering data		
Type	Order No.	Pcs. / Pkt.
FBP-2/B19	3069503	1

Accessories			
AP-ME	METER	3034361	10
APH-ME		3034374	10
APT-ME		3034358	10
SF-SL	0,8X4,0-100	1212551	10

Accessories			
PSBJ-URTK 6 FARBLOS		3026450	10
PSBJ-URTK 6 RD		3026719	10
PSBJ-URTK 6 BU		3026434	10
PSBJ-URTK 6 YE		3026405	10
PSBJ-URTK 6 GN		3026418	10
PSBJ-URTK 6 VT		3026421	10
PSBJ-URTK 6 BK		3026447	10
PSBJ-URTK 6 GY		3026612	10
PSBJ-URTK 6 BN		3026971	10
C-FCI 1,5/M3		3240032	100
C-FCI 2,5/M3		3240037	100
C-RCI 1,5/M3		3240016	100
C-RCI 2,5/M3		3240021	100

Accessories			
-------------	--	--	--

UC-TM 8, UCT-TM 8, ZB 8 or TMT (EX9,5)R (see Catalog 5)

UC-TM 8, UCT-TM 8, ZB 8 or TMT (EX9,5)R (see Catalog 5)

UC-TM 8, UCT-TM 8, ZB 8 or TMT (EX9,5)R (see Catalog 5)

## FAME plug-in test system

### Test terminal strip with UT ... screw connection, VDE type C19, for wall and DIN rail mounting

The **VDE C19** version described here is suitable as a plug-in test system in distance protection as system busbar protection, overcurrent directional protection, and current comparison protection for cables.

- The test plugs are assembled with jumpers and contact tab lengths according to the circuit diagram
- A transparent covering hood protects the jumpers. The covering hood can only be removed by dismantling the test plug
- All VDE-specified 7, 14, and 19-pos. versions are supplied with exclusive coding for the matching test plug and blind plug
- The components are supplied pre-marked according to the VDE Directive
- Test signals can be connected with touch-proof safety test leads (CAT III and IV/1000 V according to EN 61010-031)
- The test plugs are equipped with two gray test sockets per position, for further color versions, see the range of accessories
- Additional test leads, assembled with ring and fork-type cable lugs, can be attached with test sockets
- Other VDE versions available on request

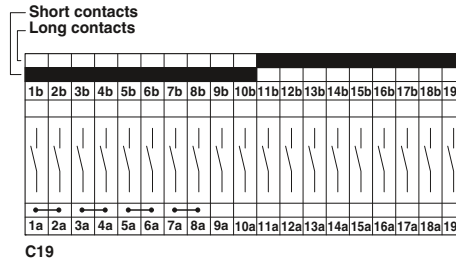

6 (10) mm<sup>2</sup>, 30 A, test terminal strip, for wall mounting, VDE coded type C19

Notes:	
To create panel cutouts, see phoenixcontact.net/products.	
1) Derating curve available on request.	
2) Rated surge voltage of 5 kV.	

Max. electrical data	
<b>Rated data</b>	
Rated voltage	[V] 400 <sup>2)</sup>
Nominal current / cross section	[A] / [mm <sup>2</sup> ] 24 <sup>1)</sup> /6
Rated cross section	[mm <sup>2</sup> ] 6
Cross section range	AWG 24 - 8
<b>Connection capacity</b>	
1 conductor	[mm <sup>2</sup> ] 0.2 - 10
2 conductors (of the same type)	[mm <sup>2</sup> ] 0.2 - 2.5
2 stranded conductors with a TWIN ferrule	[mm <sup>2</sup> ] 0.25 - 6
<b>General data</b>	
Stripping length	[mm] 10
Screw thread	M4
Tightening torque	[Nm] 1.5 - 1.8
Tightening torque for wall fastening	[Nm] 0.8 - 1
Panel thickness	[mm] 1 - 4
Tightening torque: test socket screw	[Nm] -
Insulating material	PA
Inflammability class according to UL 94	V0

Technical data			
I <sub>max</sub> [A]	U <sub>max</sub> [V]	max. Ø [mm <sup>2</sup> ]	AWG
30	400 <sup>2)</sup>	0.2 - 10	24 - 8
IEC 60947-7-1			
IEC	UL/CUL	CSA	IEC/EN 60079-7
<b>Connection capacity</b>			
solid	stranded	ferrule	
with/without plastic sleeve			
0.2 - 10	0.2 - 10	0.25 - 6	0.25 - 6
0.2 - 2.5	0.2 - 2.5	0.25 - 1.5	-
			0.5 - 2.5

Description	Color
<b>Test terminal strip</b> , for wall mounting	gray
<b>Test terminal strip</b> , for mounting on NS 35...	gray
<b>Test plug</b> , with twist grip	gray
With standard handle	gray
<b>Test plug</b> , 1-pos., with cover	gray
<b>Blind plug</b> , sealable	gray

Ordering data		
Type	Order No.	Pcs. / Pkt.
<b>UTWE 6-2/C19</b>	<b>3069417</b>	1

<b>Test socket</b> , insulated	transparent red blue yellow green violet black gray brown
<b>Cover profile</b> , supply length 1 m	transparent
<b>Cover profile holder</b> , can be snapped on and sealed	gray
<b>Cover profile</b> , supply length 1 m	transparent
<b>End brackets</b> , for AP-ME cover profile, sealable, with storage option for jumpers	gray
<b>Holder</b> , for AP-ME cover profile	gray
<b>Fork-type cable lug</b> , insulated according to UL	red blue
<b>Ring cable lug</b> , insulated according to UL	red blue

Accessories		
<b>AP RSC-T</b>	<b>3059139</b>	10
<b>APH-UTWE 6-2</b>	<b>3069057</b>	10
<b>SF-SL 0,8X4,0-100</b>	<b>1212551</b>	10

Screwdriver
<b>Lateral groove labeling</b>

<b>UC-TM 8, UCT-TM 8, ZB 8 or TMT (EX9,5)R</b> (see Catalog 5)
---





6 (10) mm<sup>2</sup>, 30 A, test terminal strip, for DIN rail mounting, VDE coded type C19



24 A, test plug, bridge assignment according to circuit diagram, VDE coded type C19



Blind plug, VDE coded type C19

Technical data			
I <sub>max</sub> [A]	U <sub>max</sub> [V]	max. Ø [mm <sup>2</sup> ]	AWG
30	400 <sup>2</sup> )	0.2 - 10	24 - 8
IEC 60947-7-1			
IEC	UL/CUL	CSA	IEC/EN 60079-7
400 <sup>2</sup> )	-	-	-
24 <sup>1</sup> )/6	-	-	-
6	-	-	-
24 - 8	-	-	-
solid	stranded	ferrule	
		with/without plastic sleeve	
0.2 - 10	0.2 - 10	0.25 - 6	0.25 - 6
0.2 - 2.5	0.2 - 2.5	0.25 - 1.5	-
		0.5 - 2.5	
10	-	-	-
M4	-	-	-
1.5 - 1.8	-	-	-
-	-	-	-
-	-	-	-
-	-	-	-
PA	-	-	-
V0	-	-	-

Technical data			
I <sub>max</sub> [A]	U <sub>max</sub> [V]	max. Ø [mm <sup>2</sup> ]	AWG
24	400 <sup>2</sup> )	0.5 - 2.5	20 - 14
IEC			
UL/CUL	CSA	IEC/EN 60079-7	
400 <sup>2</sup> )	-	-	-
24/2.5	-	-	-
6	-	-	-
20 - 14	-	-	-
solid	stranded	ferrule	
		with/without plastic sleeve	
-	0.5 - 2.5	-	-
-	-	-	-
0.5 - 0.6	-	-	-
PA	-	-	-
V0	-	-	-

Technical data			
		max. Ø [mm <sup>2</sup> ]	AWG
		-	-
IEC			
UL/CUL	CSA	IEC/EN 60079-7	
-	-	-	-
-	-	-	-
-	-	-	-
-	-	-	-
solid	stranded	ferrule	
		with/without plastic sleeve	
-	-	-	-
-	-	-	-
PA	-	-	-
V0	-	-	-

Ordering data		
Type	Order No.	Pcs. / Pkt.
UTRE 6-2/C19	3069430	1

Ordering data		
Type	Order No.	Pcs. / Pkt.
FTPR-2/C19	3069491	1
FTP-2/C19	3069478	1
FTP-2/1	3069469	1

Ordering data		
Type	Order No.	Pcs. / Pkt.
FBP-2/C19	3069504	1

Accessories			
AP-ME	METER	3034361	10
APH-ME		3034374	10
APT-ME		3034358	10
SF-SL	0,8X4,0-100	1212551	10

Accessories			
PSBJ-URTK 6 FARBLOS		3026450	10
PSBJ-URTK 6 RD		3026719	10
PSBJ-URTK 6 BU		3026434	10
PSBJ-URTK 6 YE		3026405	10
PSBJ-URTK 6 GN		3026418	10
PSBJ-URTK 6 VT		3026421	10
PSBJ-URTK 6 BK		3026447	10
PSBJ-URTK 6 GY		3026612	10
PSBJ-URTK 6 BN		3026971	10
C-FCI 1,5/M3		3240032	100
C-FCI 2,5/M3		3240037	100
C-RCI 1,5/M3		3240016	100
C-RCI 2,5/M3		3240021	100

Accessories			
-------------	--	--	--

UC-TM 8, UCT-TM 8, ZB 8 or TMT (EX9,5)R (see Catalog 5)

UC-TM 8, UCT-TM 8, ZB 8 or TMT (EX9,5)R (see Catalog 5)

UC-TM 8, UCT-TM 8, ZB 8 or TMT (EX9,5)R (see Catalog 5)

# Modular terminal blocks

## FAME plug-in test system

### Test terminal strip with UT ... screw connection, VDE type D19, for wall and DIN rail mounting

The **VDE D19** version described here is suitable as a plug-in test system for electromechanical differential protection for transformers.

- The test plugs are assembled with jumpers and contact tab lengths according to the circuit diagram
- A transparent covering hood protects the jumpers. The covering hood can only be removed by dismantling the test plug
- All VDE-specified 7, 14, and 19-pos. versions are supplied with exclusive coding for the matching test plug and blind plug
- The components are supplied pre-marked according to the VDE Directive
- Test signals can be connected with touch-proof safety test leads (CAT III and IV/1000 V according to EN 61010-031)
- The test plugs are equipped with two gray test sockets per position, for further color versions, see the range of accessories
- Additional test leads, assembled with ring and fork-type cable lugs, can be attached with test sockets
- Other VDE versions available on request

Notes:
To create panel cutouts, see <a href="http://phoenixcontact.net/products">phoenixcontact.net/products</a> .
<sup>1)</sup> Derating curve available on request.
<sup>2)</sup> Rated surge voltage of 5 kV.

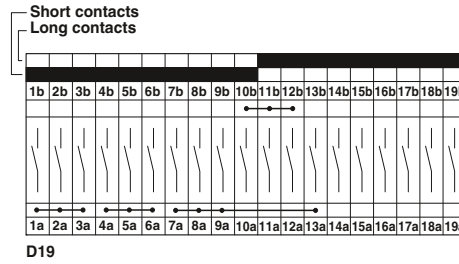

6 (10) mm<sup>2</sup>, 30 A, test terminal strip, for wall mounting, VDE coded type D19

Max. electrical data	
<b>Rated data</b>	
Rated voltage	[V] 400 <sup>2)</sup>
Nominal current / cross section	[A] / [mm <sup>2</sup> ] 24 <sup>1)</sup> /6
Rated cross section	[mm <sup>2</sup> ] 6
Cross section range	AWG 24 - 8
Connection capacity	
1 conductor	[mm <sup>2</sup> ] 0.2 - 10
2 conductors (of the same type)	[mm <sup>2</sup> ] 0.2 - 2.5
2 stranded conductors with a TWIN ferrule	[mm <sup>2</sup> ] 0.2 - 2.5
General data	
Stripping length	[mm] 10
Screw thread	M4
Tightening torque	[Nm] 1.5 - 1.8
Tightening torque for wall fastening	[Nm] 0.8 - 1
Panel thickness	[mm] 1 - 4
Tightening torque: test socket screw	[Nm] -
Insulating material	PA
Inflammability class according to UL 94	V0

Technical data			
I <sub>max</sub> [A]	U <sub>max</sub> [V]	max. Ø [mm <sup>2</sup> ]	AWG
30	400 <sup>2)</sup>	0.2 - 10	24 - 8
IEC 60947-7-1	UL/CUL	CSA	IEC/EN 60079-7
Connection capacity		ferrule	
solid	stranded	with/without plastic sleeve	
0.2 - 10	0.2 - 10	0.25 - 6	0.25 - 6
0.2 - 2.5	0.2 - 2.5	0.25 - 1.5	-
			0.5 - 2.5

Description	Color
<b>Test terminal strip</b> , for wall mounting	gray
<b>Test terminal strip</b> , for mounting on NS 35...	gray
<b>Test plug</b> , with twist grip	gray
With standard handle	gray
<b>Test plug</b> , 1-pos., with cover	gray
<b>Blind plug</b> , sealable	gray

<b>Test socket</b> , insulated	transparent red blue yellow green violet black gray brown
<b>Cover profile</b> , supply length 1 m	transparent
<b>Cover profile holder</b> , can be snapped on and sealed	gray
<b>Cover profile</b> , supply length 1 m	transparent
<b>End brackets</b> , for AP-ME cover profile, sealable, with storage option for jumpers	gray
<b>Holder</b> , for AP-ME cover profile	gray
<b>Fork-type cable lug</b> , insulated according to UL	red blue
<b>Ring cable lug</b> , insulated according to UL	red blue

<b>Screwdriver</b>	SF-SL 0,8X4,0-100
<b>Lateral groove labeling</b>	UC-TM 8, UCT-TM 8, ZB 8 or TMT (EX9,5)R (see Catalog 5)

Ordering data		
Type	Order No.	Pcs. / Pkt.
<b>UTWE 6-2/D19</b>	<b>3069418</b>	1

Accessories		
Type	Order No.	Pcs. / Pkt.
<b>AP RSC-T</b>	<b>3059139</b>	10
<b>APH-UTWE 6-2</b>	<b>3069057</b>	10
<b>SF-SL 0,8X4,0-100</b>	<b>1212551</b>	10
<b>UC-TM 8, UCT-TM 8, ZB 8 or TMT (EX9,5)R (see Catalog 5)</b>		



6 (10) mm<sup>2</sup>, 30 A, test terminal strip, for DIN rail mounting, VDE coded type D19



24 A, test plug, bridge assignment according to circuit diagram, VDE coded type D19



Blind plug, VDE coded type D19

Technical data			
I <sub>max</sub> [A]	U <sub>max</sub> [V]	max. Ø [mm <sup>2</sup> ]	AWG
30	400 <sup>2</sup> )	0.2 - 10	24 - 8
IEC 60947-7-1			
IEC	UL/CUL	CSA	IEC/EN 60079-7
400 <sup>2</sup> )	-	-	-
24 <sup>1</sup> )/6	-	-	-
6	-	-	-
24 - 8	-	-	-
solid	stranded	ferrule with/without plastic sleeve	
0.2 - 10	0.2 - 10	0.25 - 6	0.25 - 6
0.2 - 2.5	0.2 - 2.5	0.25 - 1.5	-
			0.5 - 2.5
10			
M4			
1.5 - 1.8			
-			
-			
-			
0.5 - 0.6			
PA			
V0			

Technical data			
I <sub>max</sub> [A]	U <sub>max</sub> [V]	max. Ø [mm <sup>2</sup> ]	AWG
24	400 <sup>2</sup> )	0.5 - 2.5	20 - 14
IEC			
UL/CUL	CSA	IEC/EN 60079-7	
400 <sup>2</sup> )	-	-	-
24/2.5	-	-	-
6	-	-	-
20 - 14	-	-	-
solid	stranded	ferrule with/without plastic sleeve	
-	0.5 - 2.5	-	-
-	-	-	-
-			
-			
-			
0.5 - 0.6			
PA			
V0			

Technical data			
		max. Ø [mm <sup>2</sup> ]	AWG
		-	-
IEC			
UL/CUL	CSA	IEC/EN 60079-7	
-	-	-	-
-	-	-	-
-	-	-	-
-	-	-	-
solid	stranded	ferrule with/without plastic sleeve	
-	-	-	-
-	-	-	-
-			
-			
PA			
V0			

Ordering data		
Type	Order No.	Pcs. / Pkt.
UTRE 6-2/D19	3069431	1

Ordering data		
Type	Order No.	Pcs. / Pkt.
FTPR-2/D19	3069492	1
FTP-2/D19	3069479	1
FTP-2/1	3069469	1

Ordering data		
Type	Order No.	Pcs. / Pkt.
FBP-2/D19	3069671	1

Accessories			
AP-ME	METER	3034361	10
APH-ME		3034374	10
APT-ME		3034358	10
SF-SL	0,8X4,0-100	1212551	10

Accessories			
PSBJ-URTK 6 FARBLOS		3026450	10
PSBJ-URTK 6 RD		3026719	10
PSBJ-URTK 6 BU		3026434	10
PSBJ-URTK 6 YE		3026405	10
PSBJ-URTK 6 GN		3026418	10
PSBJ-URTK 6 VT		3026421	10
PSBJ-URTK 6 BK		3026447	10
PSBJ-URTK 6 GY		3026612	10
PSBJ-URTK 6 BN		3026971	10
C-FCI 1,5/M3		3240032	100
C-FCI 2,5/M3		3240037	100
C-RCI 1,5/M3		3240016	100
C-RCI 2,5/M3		3240021	100

Accessories			
-------------	--	--	--

UC-TM 8, UCT-TM 8, ZB 8 or TMT (EX9,5)R (see Catalog 5)

UC-TM 8, UCT-TM 8, ZB 8 or TMT (EX9,5)R (see Catalog 5)

UC-TM 8, UCT-TM 8, ZB 8 or TMT (EX9,5)R (see Catalog 5)

## FAME plug-in test system

### Test terminal strip with UT ... screw connection, VDE type F19, for wall and DIN rail mounting

The **VDE F19** version described here is suitable as a plug-in test system in electromechanical differential protection for transformers, generators, motors, and cables.

- The test plugs are assembled with jumpers and contact tab lengths according to the circuit diagram
- A transparent covering hood protects the jumpers. The covering hood can only be removed by dismantling the test plug
- All VDE-specified 7, 14, and 19-pos. versions are supplied with exclusive coding for the matching test plug and blind plug
- The components are supplied pre-marked according to the VDE Directive
- Test signals can be connected with touch-proof safety test leads (CAT III and IV/1000 V according to EN 61010-031)
- The test plugs are equipped with two gray test sockets per position, for further color versions, see the range of accessories
- Additional test leads, assembled with ring and fork-type cable lugs, can be attached with test sockets
- Other VDE versions available on request

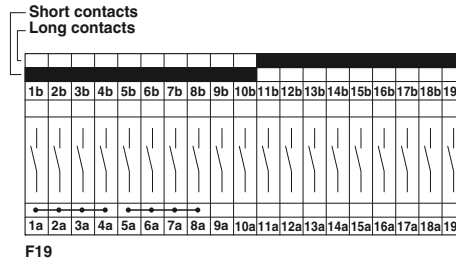

6 (10) mm<sup>2</sup>, 30 A, test terminal strip, for wall mounting, VDE coded type F19

Notes:
To create panel cutouts, see phoenixcontact.net/products.
1) Derating curve available on request.
2) Rated surge voltage of 5 kV.

Max. electrical data	
<b>Rated data</b>	
Rated voltage	[V] 400 <sup>2)</sup>
Nominal current / cross section	[A] / [mm <sup>2</sup> ] 24 <sup>1)</sup> /6
Rated cross section	[mm <sup>2</sup> ] 6
Cross section range	AWG 24 - 8
Connection capacity	
1 conductor	[mm <sup>2</sup> ] 0.2 - 10
2 conductors (of the same type)	[mm <sup>2</sup> ] 0.2 - 2.5
2 stranded conductors with a TWIN ferrule	[mm <sup>2</sup> ] 0.25 - 6
General data	
Stripping length	[mm] 10
Screw thread	M4
Tightening torque	[Nm] 1.5 - 1.8
Tightening torque for wall fastening	[Nm] 0.8 - 1
Panel thickness	[mm] 1 - 4
Tightening torque: test socket screw	[Nm] -
Insulating material	PA
Inflammability class according to UL 94	V0

Technical data			
I <sub>max</sub> [A]	U <sub>max</sub> [V]	max. Ø [mm <sup>2</sup> ]	AWG
30	400 <sup>2)</sup>	0.2 - 10	24 - 8
IEC 60947-7-1	UL/CUL	CSA	IEC/EN 60079-7
solid		stranded	
		ferrule	
		with/without plastic sleeve	
0.2 - 10	0.2 - 10	0.25 - 6	0.25 - 6
0.2 - 2.5	0.2 - 2.5	0.25 - 1.5	-
			0.5 - 2.5

Description	Color
<b>Test terminal strip</b> , for wall mounting	gray
<b>Test terminal strip</b> , for mounting on NS 35...	gray
<b>Test plug</b> , with twist grip	gray
With standard handle	gray
<b>Test plug</b> , 1-pos., with cover	gray
<b>Blind plug</b> , sealable	gray

Ordering data		
Type	Order No.	Pcs. / Pkt.
<b>UTWE 6-2/F19</b>	<b>3069419</b>	1

<b>Test socket</b> , insulated	transparent red blue yellow green violet black gray brown
<b>Cover profile</b> , supply length 1 m	transparent
<b>Cover profile holder</b> , can be snapped on and sealed	gray
<b>Cover profile</b> , supply length 1 m	transparent
<b>End brackets</b> , for AP-ME cover profile, sealable, with storage option for jumpers	gray
<b>Holder</b> , for AP-ME cover profile	gray
<b>Fork-type cable lug</b> , insulated according to UL	red blue
<b>Ring cable lug</b> , insulated according to UL	red blue

Accessories		
<b>AP RSC-T</b>	<b>3059139</b>	10
<b>APH-UTWE 6-2</b>	<b>3069057</b>	10
<b>SF-SL 0,8X4,0-100</b>	<b>1212551</b>	10

Screwdriver
<b>Lateral groove labeling</b>

<b>UC-TM 8, UCT-TM 8, ZB 8 or TMT (EX9,5)R</b> (see Catalog 5)
---



6 (10) mm<sup>2</sup>, 30 A, test terminal strip, for DIN rail mounting, VDE coded type F19



24 A, test plug, bridge assignment according to circuit diagram, VDE coded type F19



Blind plug, VDE coded type F19

Technical data			
I <sub>max</sub> [A]	U <sub>max</sub> [V]	max. Ø [mm <sup>2</sup> ]	AWG
30	400 <sup>2</sup> )	0.2 - 10	24 - 8
IEC 60947-7-1			
IEC	UL/CUL	CSA	IEC/EN 60079-7
400 <sup>2</sup> )	-	-	-
24 <sup>1</sup> )/6	-	-	-
6	-	-	-
24 - 8	-	-	-
solid	stranded	ferrule with/without plastic sleeve	
0.2 - 10	0.2 - 10	0.25 - 6	0.25 - 6
0.2 - 2.5	0.2 - 2.5	0.25 - 1.5	-
			0.5 - 2.5
10			
M4			
1.5 - 1.8			
-			
-			
-			
0.5 - 0.6			
PA			
V0			

Technical data			
I <sub>max</sub> [A]	U <sub>max</sub> [V]	max. Ø [mm <sup>2</sup> ]	AWG
24	400 <sup>2</sup> )	0.5 - 2.5	20 - 14
IEC			
UL/CUL	CSA	IEC/EN 60079-7	
400 <sup>2</sup> )	-	-	-
24/2.5	-	-	-
6	-	-	-
20 - 14	-	-	-
solid	stranded	ferrule with/without plastic sleeve	
-	0.5 - 2.5	-	-
-	-	-	-
-			
-			
0.5 - 0.6			
PA			
V0			

Technical data			
		max. Ø [mm <sup>2</sup> ]	AWG
		-	-
IEC			
UL/CUL	CSA	IEC/EN 60079-7	
-	-	-	-
-	-	-	-
-	-	-	-
-	-	-	-
solid	stranded	ferrule with/without plastic sleeve	
-	-	-	-
-	-	-	-
-			
-			
PA			
V0			

Ordering data		
Type	Order No.	Pcs. / Pkt.
UTRE 6-2/F19	3069432	1

Ordering data		
Type	Order No.	Pcs. / Pkt.
FTPR-2/F19	3069493	1
FTP-2/F19	3069480	1
FTP-2/1	3069469	1

Ordering data		
Type	Order No.	Pcs. / Pkt.
FBP-2/F19	3069675	1

Accessories			
AP-ME	METER	3034361	10
APH-ME		3034374	10
APT-ME		3034358	10
SF-SL	0,8X4,0-100	1212551	10

Accessories			
PSBJ-URTK 6 FARBLOS		3026450	10
PSBJ-URTK 6 RD		3026719	10
PSBJ-URTK 6 BU		3026434	10
PSBJ-URTK 6 YE		3026405	10
PSBJ-URTK 6 GN		3026418	10
PSBJ-URTK 6 VT		3026421	10
PSBJ-URTK 6 BK		3026447	10
PSBJ-URTK 6 GY		3026612	10
PSBJ-URTK 6 BN		3026971	10
C-FCI 1,5/M3		3240032	100
C-FCI 2,5/M3		3240037	100
C-RCI 1,5/M3		3240016	100
C-RCI 2,5/M3		3240021	100

Accessories			
-------------	--	--	--

UC-TM 8, UCT-TM 8, ZB 8 or TMT (EX9,5)R (see Catalog 5)

UC-TM 8, UCT-TM 8, ZB 8 or TMT (EX9,5)R (see Catalog 5)

UC-TM 8, UCT-TM 8, ZB 8 or TMT (EX9,5)R (see Catalog 5)

# Modular terminal blocks

## FAME plug-in test system

### Test terminal strip with UT ... screw connection, VDE type G19, for wall and DIN rail mounting

The **VDE G19** version described here is suitable as a plug-in test system in digital differential protection for transformers.

- The test plugs are assembled with jumpers and contact tab lengths according to the circuit diagram
- A transparent covering hood protects the jumpers. The covering hood can only be removed by dismantling the test plug
- All VDE-specified 7, 14, and 19-pos. versions are supplied with exclusive coding for the matching test plug and blind plug
- The components are supplied pre-marked according to the VDE Directive
- Test signals can be connected with touch-proof safety test leads (CAT III and IV/1000 V according to EN 61010-031)
- The test plugs are equipped with two gray test sockets per position, for further color versions, see the range of accessories
- Additional test leads, assembled with ring and fork-type cable lugs, can be attached with test sockets
- Other VDE versions available on request

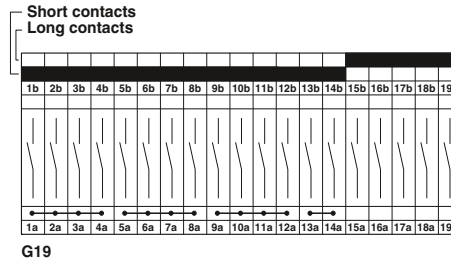

**6 (10) mm<sup>2</sup>, 30 A, test terminal strip, for wall mounting, VDE coded type G19**

Notes:	
To create panel cutouts, see <a href="http://phoenixcontact.net/products">phoenixcontact.net/products</a> .	
1) Derating curve available on request.	
2) Rated surge voltage of 5 kV.	

Max. electrical data	
<b>Rated data</b>	
Rated voltage	[V] 400 <sup>2)</sup>
Nominal current / cross section	[A] / [mm <sup>2</sup> ] 24 <sup>1)</sup> /6
Rated cross section	[mm <sup>2</sup> ] 6
Cross section range	AWG 24 - 8
Connection capacity	
1 conductor	[mm <sup>2</sup> ] 0.2 - 10
2 conductors (of the same type)	[mm <sup>2</sup> ] 0.2 - 2.5
2 stranded conductors with a TWIN ferrule	[mm <sup>2</sup> ] 0.25 - 1.5
General data	
Stripping length	[mm] 10
Screw thread	M4
Tightening torque	[Nm] 1.5 - 1.8
Tightening torque for wall fastening	[Nm] 0.8 - 1
Panel thickness	[mm] 1 - 4
Tightening torque: test socket screw	[Nm] -
Insulating material	PA
Inflammability class according to UL 94	V0

Technical data			
I <sub>max</sub> [A]	U <sub>max</sub> [V]	max. Ø [mm <sup>2</sup> ]	AWG
<b>30</b>	<b>400<sup>2)</sup></b>	<b>0.2 - 10</b>	<b>24 - 8</b>
IEC 60947-7-1	UL/CUL	CSA	IEC/EN 60079-7
solid		stranded	
		ferrule	
		with/without plastic sleeve	
0.2 - 10	0.2 - 10	0.25 - 6	0.25 - 6
0.2 - 2.5	0.2 - 2.5	0.25 - 1.5	-
			0.5 - 2.5

Description	Color
<b>Test terminal strip</b> , for wall mounting	gray
<b>Test terminal strip</b> , for mounting on NS 35...	gray
<b>Test plug</b> , with twist grip	gray
With standard handle	gray
<b>Test plug</b> , 1-pos., with cover	gray
<b>Blind plug</b> , sealable	gray

Ordering data		
Type	Order No.	Pcs. / Pkt.
<b>UTWE 6-2/G19</b>	<b>3069420</b>	<b>1</b>

<b>Test socket</b> , insulated	transparent red blue yellow green violet black gray brown
<b>Cover profile</b> , supply length 1 m	transparent
<b>Cover profile holder</b> , can be snapped on and sealed	gray
<b>Cover profile</b> , supply length 1 m	transparent
<b>End brackets</b> , for AP-ME cover profile, sealable, with storage option for jumpers	gray
<b>Holder</b> , for AP-ME cover profile	gray
<b>Fork-type cable lug</b> , insulated according to UL	red blue
<b>Ring cable lug</b> , insulated according to UL	red blue

Accessories		
Type	Order No.	Pcs. / Pkt.
<b>AP RSC-T</b>	<b>3059139</b>	<b>10</b>
<b>APH-UTWE 6-2</b>	<b>3069057</b>	<b>10</b>
<b>SF-SL 0,8X4,0-100</b>	<b>1212551</b>	<b>10</b>

Screwdriver
<b>Lateral groove labeling</b>

<b>UC-TM 8, UCT-TM 8, ZB 8 or TMT (EX9,5)R (see Catalog 5)</b>
--



6 (10) mm<sup>2</sup>, 30 A, test terminal strip, for DIN rail mounting, VDE coded type G19



24 A, test plug, bridge assignment according to circuit diagram, VDE coded type G19



Blind plug, VDE coded type G19

Technical data			
I <sub>max</sub> [A]	U <sub>max</sub> [V]	max. Ø [mm <sup>2</sup> ]	AWG
30	400 <sup>2</sup> )	0.2 - 10	24 - 8
IEC 60947-7-1			
IEC	UL/CUL	CSA	IEC/EN 60079-7
400 <sup>2</sup> )	-	-	-
24 <sup>1</sup> )/6	-	-	-
6	-	-	-
24 - 8	-	-	-
solid	stranded	ferrule with/without plastic sleeve	
0.2 - 10	0.2 - 10	0.25 - 6	0.25 - 6
0.2 - 2.5	0.2 - 2.5	0.25 - 1.5	-
			0.5 - 2.5
10			
M4			
1.5 - 1.8			
-			
-			
-			
PA			
V0			

Technical data			
I <sub>max</sub> [A]	U <sub>max</sub> [V]	max. Ø [mm <sup>2</sup> ]	AWG
24	400 <sup>2</sup> )	0.5 - 2.5	20 - 14
IEC			
UL/CUL	CSA	IEC/EN 60079-7	
400 <sup>2</sup> )	-	-	-
24/2.5	-	-	-
6	-	-	-
20 - 14	-	-	-
solid	stranded	ferrule with/without plastic sleeve	
-	0.5 - 2.5	-	-
-	-	-	-
0.5 - 0.6			
PA			
V0			

Technical data			
		max. Ø [mm <sup>2</sup> ]	AWG
		-	-
IEC			
UL/CUL	CSA	IEC/EN 60079-7	
-	-	-	-
-	-	-	-
-	-	-	-
-	-	-	-
solid	stranded	ferrule with/without plastic sleeve	
-	-	-	-
-	-	-	-
PA			
V0			

Ordering data		
Type	Order No.	Pcs. / Pkt.
UTRE 6-2/G19	3069433	1

Ordering data		
Type	Order No.	Pcs. / Pkt.
FTPR-2/G19	3069494	1
FTP-2/G19	3069481	1
FTP-2/1	3069469	1

Ordering data		
Type	Order No.	Pcs. / Pkt.
FBP-2/G19	3069676	1

Accessories			
AP-ME	METER	3034361	10
APH-ME		3034374	10
APT-ME		3034358	10
SF-SL	0,8X4,0-100	1212551	10

Accessories			
PSBJ-URTK 6 FARBLOS		3026450	10
PSBJ-URTK 6 RD		3026719	10
PSBJ-URTK 6 BU		3026434	10
PSBJ-URTK 6 YE		3026405	10
PSBJ-URTK 6 GN		3026418	10
PSBJ-URTK 6 VT		3026421	10
PSBJ-URTK 6 BK		3026447	10
PSBJ-URTK 6 GY		3026612	10
PSBJ-URTK 6 BN		3026971	10
C-FCI 1,5/M3		3240032	100
C-FCI 2,5/M3		3240037	100
C-RCI 1,5/M3		3240016	100
C-RCI 2,5/M3		3240021	100

Accessories			
-------------	--	--	--

UC-TM 8, UCT-TM 8, ZB 8 or TMT (EX9,5)R (see Catalog 5)

UC-TM 8, UCT-TM 8, ZB 8 or TMT (EX9,5)R (see Catalog 5)

UC-TM 8, UCT-TM 8, ZB 8 or TMT (EX9,5)R (see Catalog 5)

# Modular terminal blocks

## FAME plug-in test system

### Test terminal strip with UT ... screw connection, VDE type H19, for wall and DIN rail mounting

The **VDE H19** version described here is suitable as a plug-in test system in overcurrent directional protection and distance protection as system protection.

- The test plugs are assembled with jumpers and contact tab lengths according to the circuit diagram
- A transparent covering hood protects the jumpers. The covering hood can only be removed by dismantling the test plug
- All VDE-specified 7, 14, and 19-pos. versions are supplied with exclusive coding for the matching test plug and blind plug
- The components are supplied pre-marked according to the VDE Directive
- Test signals can be connected with touch-proof safety test leads (CAT III and IV/1000 V according to EN 61010-031)
- The test plugs are equipped with two gray test sockets per position, for further color versions, see the range of accessories
- Additional test leads, assembled with ring and fork-type cable lugs, can be attached with test sockets
- Other VDE versions available on request

Notes:
To create panel cutouts, see <a href="http://phoenixcontact.net/products">phoenixcontact.net/products</a> .
<sup>1)</sup> Derating curve available on request.
<sup>2)</sup> Rated surge voltage of 5 kV.

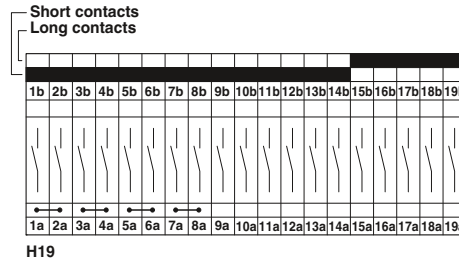

Max. electrical data	
<b>Rated data</b>	
Rated voltage	[V] 400 <sup>2)</sup>
Nominal current / cross section	[A] / [mm <sup>2</sup> ] 24 <sup>1)</sup> /6
Rated cross section	[mm <sup>2</sup> ] 6
Cross section range	AWG 24 - 8
Connection capacity	
1 conductor	[mm <sup>2</sup> ] 0.2 - 10
2 conductors (of the same type)	[mm <sup>2</sup> ] 0.2 - 2.5
2 stranded conductors with a TWIN ferrule	[mm <sup>2</sup> ] 0.2 - 2.5
General data	
Stripping length	[mm] 10
Screw thread	M4
Tightening torque	[Nm] 1.5 - 1.8
Tightening torque for wall fastening	[Nm] 0.8 - 1
Panel thickness	[mm] 1 - 4
Tightening torque: test socket screw	[Nm] -
Insulating material	PA
Inflammability class according to UL 94	V0

Description	Color
<b>Test terminal strip</b> , for wall mounting	gray
<b>Test terminal strip</b> , for mounting on NS 35...	gray
<b>Test plug</b> , with twist grip	gray
With standard handle	gray
<b>Test plug</b> , 1-pos., with cover	gray
<b>Blind plug</b> , sealable	gray

<b>Test socket</b> , insulated	transparent red blue yellow green violet black gray brown
<b>Cover profile</b> , supply length 1 m	transparent
<b>Cover profile holder</b> , can be snapped on and sealed	gray
<b>Cover profile</b> , supply length 1 m	transparent
<b>End brackets</b> , for AP-ME cover profile, sealable, with storage option for jumpers	gray
<b>Holder</b> , for AP-ME cover profile	gray
<b>Fork-type cable lug</b> , insulated according to UL	red blue
<b>Ring cable lug</b> , insulated according to UL	red blue
<b>Screwdriver</b>	

Lateral groove labeling
-------------------------



6 (10) mm<sup>2</sup>, 30 A, test terminal strip, for wall mounting, VDE coded type H19

Technical data			
I <sub>max</sub> [A]	U <sub>max</sub> [V]	max. Ø [mm <sup>2</sup> ]	AWG
<b>30</b>	<b>400<sup>2)</sup></b>	<b>0.2 - 10</b>	<b>24 - 8</b>
IEC 60947-7-1	UL/CUL	CSA	IEC/EN 60079-7
Connection capacity		ferrule	
solid	stranded	with/without plastic sleeve	
0.2 - 10	0.2 - 10	0.25 - 6	0.25 - 6
0.2 - 2.5	0.2 - 2.5	0.25 - 1.5	-
			0.5 - 2.5

Ordering data		
Type	Order No.	Pcs. / Pkt.
<b>UTWE 6-2/H19</b>	<b>3069421</b>	<b>1</b>

Accessories		
<b>AP RSC-T</b>	<b>3059139</b>	<b>10</b>
<b>APH-UTWE 6-2</b>	<b>3069057</b>	<b>10</b>
<b>SF-SL 0,8X4,0-100</b>	<b>1212551</b>	<b>10</b>
<b>UC-TM 8, UCT-TM 8, ZB 8 or TMT (EX9,5)R (see Catalog 5)</b>		





6 (10) mm<sup>2</sup>, 30 A, test terminal strip, for DIN rail mounting, VDE coded type H19



24 A, test plug, bridge assignment according to circuit diagram, VDE coded type H19



Blind plug, VDE coded type H19

Technical data			
I <sub>max</sub> [A]	U <sub>max</sub> [V]	max. Ø [mm <sup>2</sup> ]	AWG
30	400 <sup>2</sup> )	0.2 - 10	24 - 8
IEC 60947-7-1			
IEC	UL/CUL	CSA	IEC/EN 60079-7
400 <sup>2</sup> )	-	-	-
24 <sup>1</sup> )/6	-	-	-
6	-	-	-
24 - 8	-	-	-
solid	stranded	ferrule with/without plastic sleeve	
0.2 - 10	0.2 - 10	0.25 - 6	0.25 - 6
0.2 - 2.5	0.2 - 2.5	0.25 - 1.5	-
			0.5 - 2.5
10			
M4			
1.5 - 1.8			
-			
-			
-			
PA			
V0			

Technical data			
I <sub>max</sub> [A]	U <sub>max</sub> [V]	max. Ø [mm <sup>2</sup> ]	AWG
24	400 <sup>2</sup> )	0.5 - 2.5	20 - 14
IEC			
UL/CUL	CSA	IEC/EN 60079-7	
400 <sup>2</sup> )	-	-	-
24/2.5	-	-	-
6	-	-	-
20 - 14	-	-	-
solid	stranded	ferrule with/without plastic sleeve	
-	0.5 - 2.5	-	-
-	-	-	-
0.5 - 0.6			
PA			
V0			

Technical data			
		max. Ø [mm <sup>2</sup> ]	AWG
		-	-
IEC			
UL/CUL	CSA	IEC/EN 60079-7	
-	-	-	-
-	-	-	-
-	-	-	-
-	-	-	-
solid	stranded	ferrule with/without plastic sleeve	
-	-	-	-
-	-	-	-
PA			
V0			

Ordering data		
Type	Order No.	Pcs. / Pkt.
UTRE 6-2/H19	3069434	1

Ordering data		
Type	Order No.	Pcs. / Pkt.
FTPR-2/H19	3069495	1
FTP-2/H19	3069482	1
FTP-2/1	3069469	1

Ordering data		
Type	Order No.	Pcs. / Pkt.
FBP-2/H19	3069677	1

Accessories			
AP-ME	METER	3034361	10
APH-ME		3034374	10
APT-ME		3034358	10
SF-SL	0,8X4,0-100	1212551	10

Accessories			
PSBJ-URTK 6 FARBLOS		3026450	10
PSBJ-URTK 6 RD		3026719	10
PSBJ-URTK 6 BU		3026434	10
PSBJ-URTK 6 YE		3026405	10
PSBJ-URTK 6 GN		3026418	10
PSBJ-URTK 6 VT		3026421	10
PSBJ-URTK 6 BK		3026447	10
PSBJ-URTK 6 GY		3026612	10
PSBJ-URTK 6 BN		3026971	10
C-FCI 1,5/M3		3240032	100
C-FCI 2,5/M3		3240037	100
C-RCI 1,5/M3		3240016	100
C-RCI 2,5/M3		3240021	100

Accessories			
-------------	--	--	--

UC-TM 8, UCT-TM 8, ZB 8 or TMT (EX9,5)R (see Catalog 5)

UC-TM 8, UCT-TM 8, ZB 8 or TMT (EX9,5)R (see Catalog 5)

UC-TM 8, UCT-TM 8, ZB 8 or TMT (EX9,5)R (see Catalog 5)

# Modular terminal blocks

## FAME plug-in test system

### Test terminal strip with UT ... screw connection, VDE type I19, for wall and DIN rail mounting

The **VDE I19** version described here is suitable as a plug-in test system in medium voltage, outlet, and coupling protection, including selective ground fault detection.

- The test plugs are assembled with jumpers and contact tab lengths according to the circuit diagram
- A transparent covering hood protects the jumpers. The covering hood can only be removed by dismantling the test plug
- All VDE-specified 7, 14, and 19-pos. versions are supplied with exclusive coding for the matching test plug and blind plug
- The components are supplied pre-marked according to the VDE Directive
- Test signals can be connected with touch-proof safety test leads (CAT III and IV/1000 V according to EN 61010-031)
- The test plugs are equipped with two gray test sockets per position, for further color versions, see the range of accessories
- Additional test leads, assembled with ring and fork-type cable lugs, can be attached with test sockets
- Other VDE versions available on request

#### Notes:

To create panel cutouts, see [phoenixcontact.net/products](http://phoenixcontact.net/products).

<sup>1)</sup> Derating curve available on request.

<sup>2)</sup> Rated surge voltage of 5 kV.

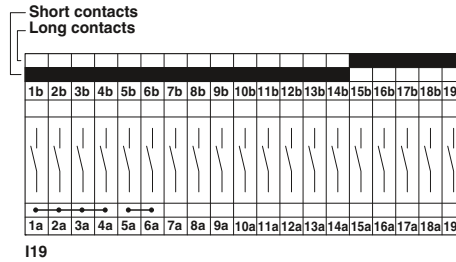

#### Max. electrical data

**I<sub>max</sub> [A]** **U<sub>max</sub> [V]** **max. Ø [mm<sup>2</sup>]** **AWG**

**30** **400<sup>2)</sup>** **0.2 - 10** **24 - 8**

IEC 60947-7-1

IEC UL/CUL CSA IEC/EN 60079-7

Rated voltage [V] 400<sup>2)</sup> - - -

Nominal current / cross section [A] / [mm<sup>2</sup>] 24<sup>1)</sup>/6 - - -

Rated cross section [mm<sup>2</sup>] 6 - - -

Cross section range AWG 24 - 8 - - -

#### Connection capacity

1 conductor [mm<sup>2</sup>] 0.2 - 10 0.2 - 10 ferrule with/without plastic sleeve

2 conductors (of the same type) [mm<sup>2</sup>] 0.2 - 2.5 0.2 - 2.5 0.25 - 6 0.25 - 6

2 stranded conductors with a TWIN ferrule [mm<sup>2</sup>] - - - 0.25 - 1.5 -

- - - 0.5 - 2.5

#### General data

Stripping length [mm] 10

Screw thread M4

Tightening torque [Nm] 1.5 - 1.8

Tightening torque for wall fastening [Nm] 0.8 - 1

Panel thickness [mm] 1 - 4

Tightening torque: test socket screw [Nm] -

Insulating material PA

Inflammability class according to UL 94 V0

Description	Color
<b>Test terminal strip</b> , for wall mounting	gray
<b>Test terminal strip</b> , for mounting on NS 35...	gray
<b>Test plug</b> , with twist grip	gray
With standard handle	gray
<b>Test plug</b> , 1-pos., with cover	gray
<b>Blind plug</b> , sealable	gray

<b>Test socket</b> , insulated	transparent
	red
	blue
	yellow
	green
	violet
	black
	gray
	brown
<b>Cover profile</b> , supply length 1 m	transparent
<b>Cover profile holder</b> , can be snapped on and sealed	gray
<b>Cover profile</b> , supply length 1 m	transparent
<b>End brackets</b> , for AP-ME cover profile, sealable, with storage option for jumpers	gray
<b>Holder</b> , for AP-ME cover profile	gray
<b>Fork-type cable lug</b> , insulated according to UL	red
	blue
<b>Ring cable lug</b> , insulated according to UL	red
	blue

#### Screwdriver

LF-SL 0,8X4,0-100

#### Lateral groove labeling

UC-TM 8, UCT-TM 8, ZB 8 or TMT (EX9,5)R (see Catalog 5)



**6 (10) mm<sup>2</sup>, 30 A, test terminal strip, for wall mounting, VDE coded type I19**

#### Technical data

**I<sub>max</sub> [A]** **U<sub>max</sub> [V]** **max. Ø [mm<sup>2</sup>]** **AWG**

**30** **400<sup>2)</sup>** **0.2 - 10** **24 - 8**

IEC 60947-7-1

IEC UL/CUL CSA IEC/EN 60079-7

Rated voltage [V] 400<sup>2)</sup> - - -

Nominal current / cross section [A] / [mm<sup>2</sup>] 24<sup>1)</sup>/6 - - -

Rated cross section [mm<sup>2</sup>] 6 - - -

Cross section range AWG 24 - 8 - - -

#### Connection capacity

1 conductor [mm<sup>2</sup>] 0.2 - 10 0.2 - 10 ferrule with/without plastic sleeve

2 conductors (of the same type) [mm<sup>2</sup>] 0.2 - 2.5 0.2 - 2.5 0.25 - 6 0.25 - 6

2 stranded conductors with a TWIN ferrule [mm<sup>2</sup>] - - - 0.25 - 1.5 -

- - - 0.5 - 2.5

#### General data

Stripping length [mm] 10

Screw thread M4

Tightening torque [Nm] 1.5 - 1.8

Tightening torque for wall fastening [Nm] 0.8 - 1

Panel thickness [mm] 1 - 4

Tightening torque: test socket screw [Nm] -

Insulating material PA

Inflammability class according to UL 94 V0

#### Ordering data

Type	Order No.	Pcs. / Pkt.
<b>UTWE 6-2/I19</b>	<b>3069422</b>	<b>1</b>

#### Accessories

<b>AP RSC-T</b>	<b>3059139</b>	<b>10</b>
<b>APH-UTWE 6-2</b>	<b>3069057</b>	<b>10</b>
<b>SF-SL 0,8X4,0-100</b>	<b>1212551</b>	<b>10</b>

#### Lateral groove labeling

UC-TM 8, UCT-TM 8, ZB 8 or TMT (EX9,5)R (see Catalog 5)



6 (10) mm<sup>2</sup>, 30 A, test terminal strip, for DIN rail mounting, VDE coded type I19



24 A, test plug, bridge assignment according to circuit diagram, VDE coded type I19



Blind plug, VDE coded type I19

Technical data			
I <sub>max</sub> [A]	U <sub>max</sub> [V]	max. Ø [mm <sup>2</sup> ]	AWG
30	400 <sup>2</sup> )	0.2 - 10	24 - 8
IEC 60947-7-1			
IEC	UL/CUL	CSA	IEC/EN 60079-7
400 <sup>2</sup> )	-	-	-
24 <sup>1</sup> )/6	-	-	-
6	-	-	-
24 - 8	-	-	-
solid	stranded	ferrule with/without plastic sleeve	
0.2 - 10	0.2 - 10	0.25 - 6	0.25 - 6
0.2 - 2.5	0.2 - 2.5	0.25 - 1.5	-
			0.5 - 2.5
10			
M4			
1.5 - 1.8			
-			
-			
-			
PA			
V0			

Technical data			
I <sub>max</sub> [A]	U <sub>max</sub> [V]	max. Ø [mm <sup>2</sup> ]	AWG
24	400 <sup>2</sup> )	0.5 - 2.5	20 - 14
IEC			
UL/CUL	CSA	IEC/EN 60079-7	
400 <sup>2</sup> )	-	-	-
24/2.5	-	-	-
6	-	-	-
20 - 14	-	-	-
solid	stranded	ferrule with/without plastic sleeve	
-	0.5 - 2.5	-	-
-	-	-	-
0.5 - 0.6			
PA			
V0			

Technical data			
		max. Ø [mm <sup>2</sup> ]	AWG
		-	-
IEC			
UL/CUL	CSA	IEC/EN 60079-7	
-	-	-	-
-	-	-	-
-	-	-	-
-	-	-	-
solid	stranded	ferrule with/without plastic sleeve	
-	-	-	-
-	-	-	-
PA			
V0			

Ordering data		
Type	Order No.	Pcs. / Pkt.
UTRE 6-2/I19	3069435	1

Ordering data		
Type	Order No.	Pcs. / Pkt.
FTPR-2/I19	3069496	1
FTP-2/I19	3069483	1
FTP-2/1	3069469	1

Ordering data		
Type	Order No.	Pcs. / Pkt.
FBP-2/I19	3069678	1

Accessories			
AP-ME	METER	3034361	10
APH-ME		3034374	10
APT-ME		3034358	10
SF-SL	0,8X4,0-100	1212551	10

Accessories			
PSBJ-URTK 6 FARBLOS		3026450	10
PSBJ-URTK 6 RD		3026719	10
PSBJ-URTK 6 BU		3026434	10
PSBJ-URTK 6 YE		3026405	10
PSBJ-URTK 6 GN		3026418	10
PSBJ-URTK 6 VT		3026421	10
PSBJ-URTK 6 BK		3026447	10
PSBJ-URTK 6 GY		3026612	10
PSBJ-URTK 6 BN		3026971	10
C-FCI 1,5/M3		3240032	100
C-FCI 2,5/M3		3240037	100
C-RCI 1,5/M3		3240016	100
C-RCI 2,5/M3		3240021	100

Accessories			
-------------	--	--	--

UC-TM 8, UCT-TM 8, ZB 8 or TMT (EX9,5)R (see Catalog 5)

UC-TM 8, UCT-TM 8, ZB 8 or TMT (EX9,5)R (see Catalog 5)

UC-TM 8, UCT-TM 8, ZB 8 or TMT (EX9,5)R (see Catalog 5)

# Modular terminal blocks

## Modular terminal blocks - CLIPLINE complete

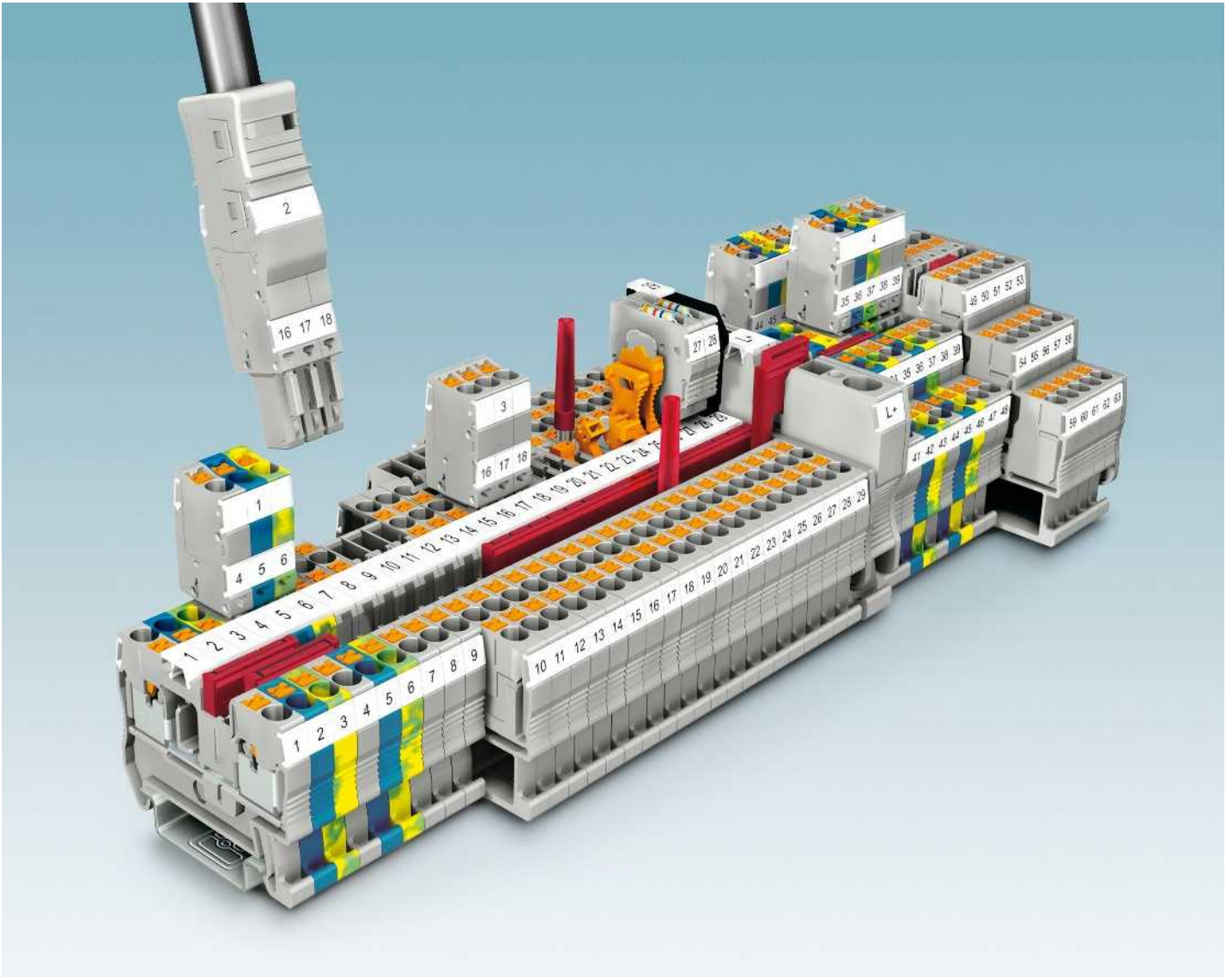

### Push-in connection technology

The PT series is characterized by the easy, direct conductor connection and makes consistent use of the benefits of the CLIPLINE complete system.



### Easy insertion

The up to 50 percent reduction in insertion force offered by push-in technology supports simple and direct insertion of solid and stranded conductors featuring ferrules with a cross section of 0.34 mm<sup>2</sup> or higher.



### Latch function

The integrated latch allows you to release connections with any type of tool – easily and without direct contact with live parts.

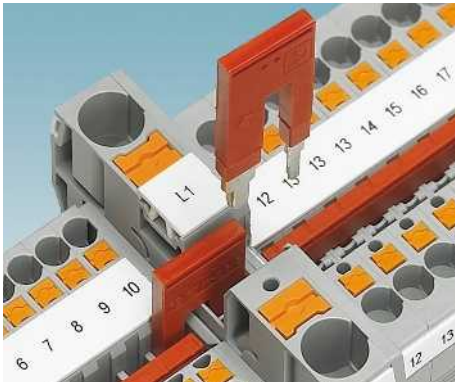

The reducing bridge allows terminal blocks with different nominal cross sections to be connected with ease, e.g., a PT 10 push-in terminal block to a PT 2.5. Power blocks can be created quickly using the reducing bridge.

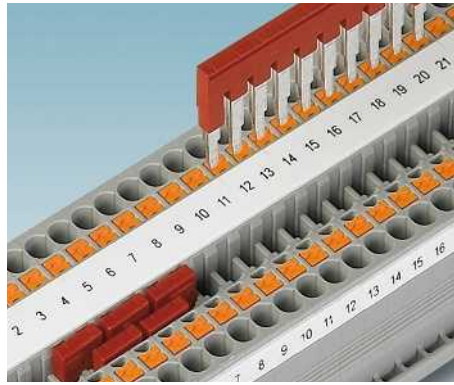

The double function shaft can be used to connect any number of terminal blocks with two-position bridges. The 2 to 50-pos. bridges allow up to 50 terminal blocks to be bridged in one step.

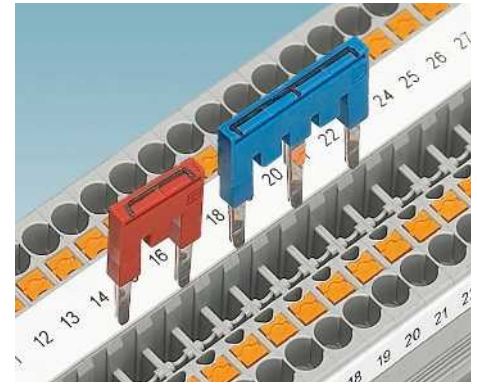

Bridging between non-adjacent terminal blocks is created by removing individual contact tabs from the standard bridge. Two potentials can then be routed in parallel through a terminal strip. The contact points can also be marked.

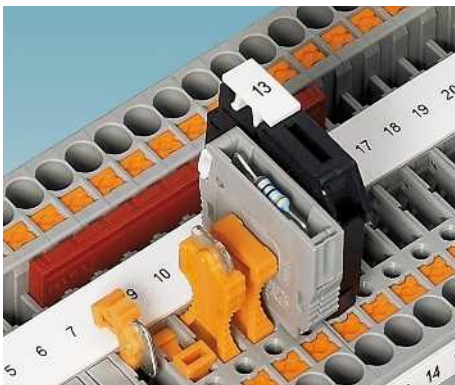

The isolated feed-through connector P-FIX, isolating plug P-DI, component plug P-CO, and the cartridge fuse plug P-FU can be used in the universal plug-in zone of the disconnect terminal block.

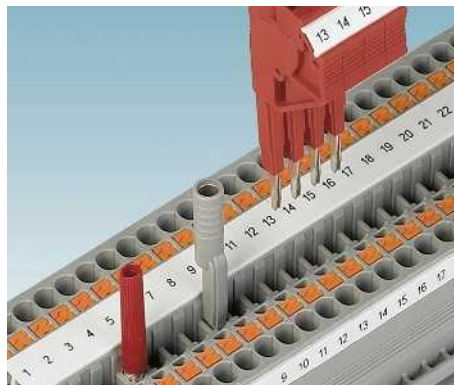

A test plug with a 2.3 mm diameter is available for measuring lines. All measurement and test work can be completed at speed using test adapters for 4 mm diameter test plugs and the modular test plugs.

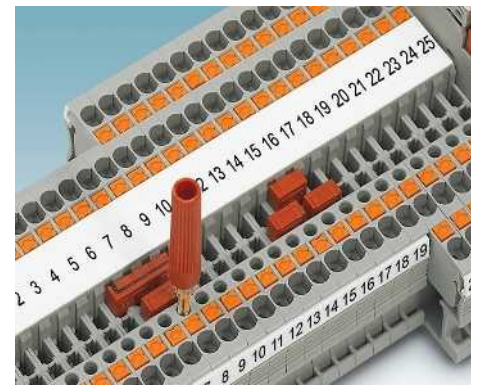

As well as offering a testing facility in the double function shaft, all push-in technology terminal blocks offer an additional test contact for test plugs with a 2.3 mm diameter.

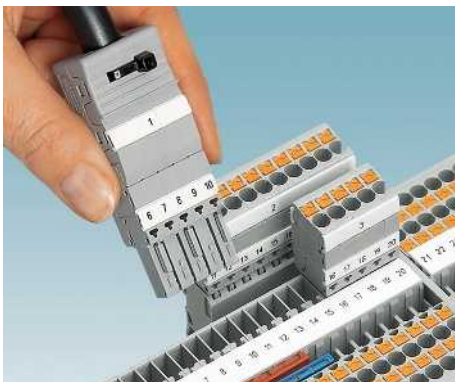

Push-in COMBI terminal blocks are available for the plug-in configuration of signal wiring. The system is touch-proof and offers plugs for self-assembly with extensive accessories.



Automatic flat-type fuse terminal blocks with a 4 mm<sup>2</sup> conductor connection are available in the same shape as the feed-through terminal blocks. All terminal blocks can be continuously bridged with one another with the double function shaft.



The compact lever-type fuse terminal blocks are of the same shape as the feed-through terminal blocks and can be labeled and bridged continuously. A time-saving potential distribution is easily created using bridging between non-adjacent terminal blocks.

# Modular terminal blocks

## Modular terminal blocks - CLIPLINE complete

### PT 1,5/S... and PTT 1,5/S... push-in knife disconnect terminal blocks

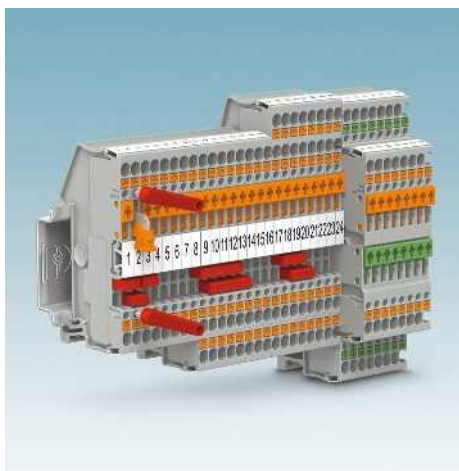

- Now available for the first time with a design width of just 3.5 mm
- Testing facility on both sides of the disconnect point
- Actuation cross on the disconnect knife enables the use of different sized screwdrivers, see image below
- Same shape feed-through versions
- Clear grouping of the terminal strips through orange cover with a design width of just 0.8 mm

#### Single-level PT 1,5/S...

- Three and four-conductor terminal blocks can be used for multi-conductor connections
- Seamless and can be double bridged for all tasks in time-saving potential supply and distribution

#### Double-level PTT 1,5/S-2MT

- Space-saving design for maximum wiring density
- Disconnect option on each level
- The assignment from the disconnect knife to the contact points is indicated by the colored levers and the height offset



Notes:
The nominal current for PT ...MTD... terminal blocks is 17.5 A.
1) The max. load current must not be exceeded by the total current of all connected conductors.
2) Refer to the reducing bridge table; see Catalog 3.

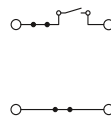

1.5 (1.5) mm<sup>2</sup>, 10 A, knife disconnect terminal block, two connections, bridgeable

Dimensions	
	[mm]
Max. electrical data	
Rated data	
Rated voltage	[V]
Nominal current / cross section	[A] / [mm <sup>2</sup> ]
Rated cross section	[mm <sup>2</sup> ]
Cross section range	AWG
Connection capacity	
1 conductor	[mm <sup>2</sup> ]
Two stranded conductors with a TWIN ferrule	[mm <sup>2</sup> ]
Connection cross sections directly plug-in	[mm <sup>2</sup> ]
General data	
Stripping length	[mm]
Insulating material	
Inflammability class according to UL 94	

Technical data			
Width	Length	Height NS 35/7,5	
3.5	58.9	32	
I <sub>max</sub> [A]	U <sub>max</sub> [V]	max. Ø [mm <sup>2</sup> ]	AWG
10	400	0.14 - 1.5	26 - 14
IEC 60947-7-1			
IEC	UL/CUL	CSA	IEC/EN 60079-7
400	-	-	-
10/1.5	-	-	-
1.5	-	-	-
26 - 14	-	-	-
solid	stranded	Ferrule with/without plastic sleeve	
0.14 - 1.5	0.14 - 1.5	0.14 - 1.5	0.14 - 1
0.25 - 1.5	-	0.34 - 1.5	0.34 - 1
General data			
8			
PA			
V0			

Description	No. of pos.	Color
Double-level knife disconnect terminal block, disconnection on both levels, for mounting on NS 35...		gray
Double-level knife disconnect terminal block, disconnection on the upper level, for mounting on NS 35...		blue
Knife disconnect terminal block, for mounting on NS 35...		gray
Feed-through terminal block, same shape, for mounting on NS 35...		blue

Ordering data		
Type	Order No.	Pcs. / Pkt.
PT 1,5/S-MT	3210301	50
PT 1,5/S-MT BU	3210302	50
PT 1,5/S-MTD	3210308	50
PT 1,5/S-MTD BU	3210309	50

Cover, 0.8 mm width		gray
		orange
Jumper		
	2	red
	3	red
	4	red
	5	red
	10	red
	20	red
Reducing bridge <sup>2)</sup>		
	2	red
	2	red
Partition plate, 2 mm width		gray
Test plug metal part, 2.3 mm Ø		silver
Insulating sleeve, for MPS metal part		red
Screwdriver		

Accessories		
D-PT 1,5/S-MT-0,8	3210303	50
D-PT 1,5/S-MT-0,8 OG	3210304	50
FBS 2-3,5	3213014	50
FBS 3-3,5	3213027	50
FBS 4-3,5	3213030	50
FBS 5-3,5	3213043	50
FBS 10-3,5	3213056	50
FBS 20-3,5	3213069	50
RB ST (2,5/4)-1,5/S	3214356	10
RB ST 6-1,5/S	3213250	10
ATP-ST-TWIN	3030789	50
MPS-MT	0201744	10
MPS-IH RD	0201676	10
SZF 0-0,4X2,5	1204504	10

Center groove labeling
Center and side groove labeling

UCT-TM 3,5 or ZB 3,5 (see Catalog 5)
UCT-TMF 3,5 or ZBF 3,5 (see Catalog 5)

## Modular terminal blocks - CLIPLINE complete

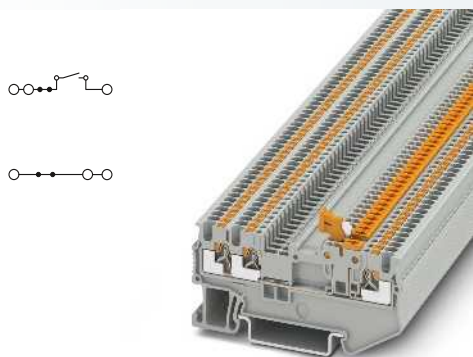

1.5 (1.5) mm<sup>2</sup>, 10 A, knife disconnect terminal block, three connections, bridgeable

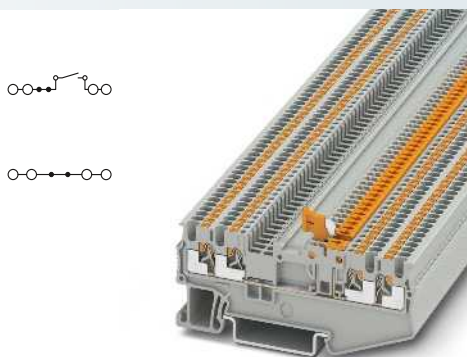

1.5 (1.5) mm<sup>2</sup>, 10 A, knife disconnect terminal block, four connections, bridgeable

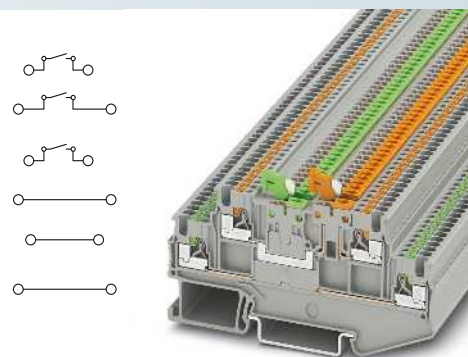

1.5 (1.5) mm<sup>2</sup>, 8 A, double-level knife disconnect terminal block, four connections, not bridgeable

Technical data			
Width	Length	Height NS 35/7,5	
3.5	67.8	32	
$I_{max}$ [A]	$U_{max}$ [V]	max. Ø [mm <sup>2</sup> ]	AWG
10 <sup>1)</sup>	400	0.14 - 1.5	26 - 14
IEC 60947-7-1			
IEC	UL/CUL	CSA	IEC/EN 60079-7
400	-	-	-
10 <sup>1)</sup> /1.5	-	-	-
1.5	-	-	-
26 - 14	-	-	-
solid	stranded	Ferrule with/without plastic sleeve	
0.14 - 1.5	0.14 - 1.5	0.14 - 1.5	0.14 - 1
0.25 - 1.5	-	0.34 - 1.5	0.34 - 1
8			
PA			
V0			

Technical data			
Width	Length	Height NS 35/7,5	
3.5	76.9	32	
$I_{max}$ [A]	$U_{max}$ [V]	max. Ø [mm <sup>2</sup> ]	AWG
10 <sup>1)</sup>	400	0.14 - 1.5	26 - 16
IEC 60947-7-1			
IEC	UL/CUL	CSA	IEC/EN 60079-7
400	-	-	-
10 <sup>1)</sup> /1.5	-	-	-
1.5	-	-	-
26 - 16	-	-	-
solid	stranded	Ferrule with/without plastic sleeve	
0.14 - 1.5	0.14 - 1.5	0.14 - 1.5	0.14 - 1
0.25 - 1.5	-	0.34 - 1.5	0.34 - 1
8			
PA			
V0			

Technical data			
Width	Length	Height NS 35/7,5	
3.5	86	42.6	
$I_{max}$ [A]	$U_{max}$ [V]	max. Ø [mm <sup>2</sup> ]	AWG
8	400	0.14 - 1.5	26 - 14
IEC 60947-7-1			
IEC	UL/CUL	CSA	IEC/EN 60079-7
400	-	-	-
8/1.5	-	-	-
1.5	-	-	-
26 - 14	-	-	-
solid	stranded	Ferrule with/without plastic sleeve	
0.14 - 1.5	0.14 - 1.5	0.14 - 1.5	0.14 - 1
0.25 - 1.5	-	0.34 - 1.5	0.34 - 1
8			
PA			
V0			

Ordering data		
Type	Order No.	Pcs. / Pkt.
PT 1,5/S-TWIN-MT	3210311	50
PT 1,5/S-TWIN-MT BU	3210312	50
PT 1,5/S-TWIN-MTD	3210317	50
PT 1,5/S-TWIN-MTD BU	3210319	50

Ordering data		
Type	Order No.	Pcs. / Pkt.
PT 1,5/S-QUATTRO-MT	3210321	50
PT 1,5/S-QUATTRO-MT BU	3210322	50
PT 1,5/S-QUATTRO-MTD	3210328	50
PT 1,5/S-QUATTRO-MTD BU	3210329	50

Ordering data		
Type	Order No.	Pcs. / Pkt.
PTT 1,5/S-2MT	3210351	50
PTT 1,5/S-2MT BU	3210352	50
PTT 1,5/S-L/MT	3210341	50
PTT 1,5/S-L/MT BU	3210342	50
PTT 1,5/S-2L	3210356	50
PTT 1,5/S-2L BU	3210357	50

Accessories		
D-PT 1,5/S-TWIN-MT-0,8	3210313	50
D-PT 1,5/S-TWIN-MT-0,8 OG	3210314	50
FBS 2-3,5	3213014	50
FBS 3-3,5	3213027	50
FBS 4-3,5	3213030	50
FBS 5-3,5	3213043	50
FBS 10-3,5	3213056	50
FBS 20-3,5	3213069	50
RB ST (2,5/4)-1,5/S	3214356	10
RB ST 6-1,5/S	3213250	10
ATP-ST-TWIN	3030789	50
MPS-MT	0201744	10
MPS-IH RD	0201676	10
SZF 0-0,4X2,5	1204504	10

Accessories		
D-PT 1,5/S-QUATTRO-MT-0,8	3210333	50
D-PT 1,5/S-QUATTRO-MT-0,8 OG	3210334	50
FBS 2-3,5	3213014	50
FBS 3-3,5	3213027	50
FBS 4-3,5	3213030	50
FBS 5-3,5	3213043	50
FBS 10-3,5	3213056	50
FBS 20-3,5	3213069	50
RB ST (2,5/4)-1,5/S	3214356	10
RB ST 6-1,5/S	3213250	10
ATP-ST QUATTRO	3030815	50
MPS-MT	0201744	10
MPS-IH RD	0201676	10
SZF 0-0,4X2,5	1204504	10

Accessories		
D-PTT 1,5/S-2MT-0,8	3210353	50
D-PTT 1,5/S-2MT-0,8 OG	3210354	50
ATP-STTB 4	3030747	50
MPS-MT	0201744	10
MPS-IH RD	0201676	10
SZF 0-0,4X2,5	1204504	10

UCT-TM 3,5 or ZB 3,5  
(see Catalog 5)  
UCT-TMF 3,5 or ZBF 3,5  
(see Catalog 5)

UCT-TM 3,5 or ZB 3,5  
(see Catalog 5)  
UCT-TMF 3,5 or ZBF 3,5  
(see Catalog 5)

UCT-TMF 3,5 or ZBF 3,5  
(see Catalog 5)

# Modular terminal blocks

## Modular terminal blocks - CLIPLINE complete

### PTT 2,5... push-in double-level disconnect and knife disconnect terminal blocks

- Design width of just 5.2 mm
- Testing facility on both sides of the disconnect point
- Space-saving design for maximum wiring density
- Clear grouping of the terminal strips through orange cover with a design width of just 0.8 mm
- Disconnection option on each level
- The assignment from the disconnect knife to the contact points is indicated by the colored levers and the height offset

Notes:
1) If the fuse is faulty, the downstream circuit is not disconnected.
2) Observe max. load current.
3) Observe max. load current, depending on the power dissipation of the components. Max. 0.5 W with single arrangement.
4) see Catalog 3.

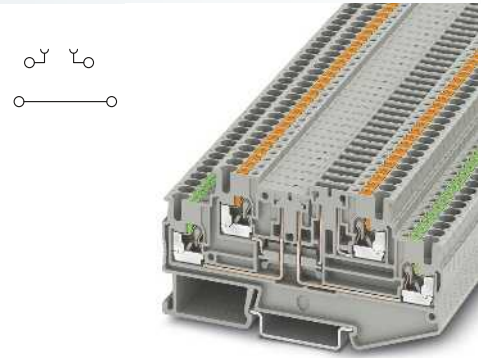

2.5 (4) mm<sup>2</sup>, 16 A, double-level terminal block, with one disconnect zone

Dimensions	
	[mm]
Max. electrical data	
Rated data	
Rated voltage	[V]
Nominal current / cross section	[A] / [mm <sup>2</sup> ]
Rated cross section	[mm <sup>2</sup> ]
Cross section range	AWG
Connection capacity	
1 conductor	[mm <sup>2</sup> ]
Two stranded conductors with a TWIN ferrule	[mm <sup>2</sup> ]
Connection cross sections directly plug-in	[mm <sup>2</sup> ]
General data	
Stripping length	[mm]
Insulating material	
Inflammability class according to UL 94	

Technical data				
Width	Length	Height NS 35/7,5		
5.2	92.4	47.4		
I <sub>max</sub> [A]	U <sub>max</sub> [V]	max. Ø [mm <sup>2</sup> ]	AWG	
16	400	0.14 - 4	26 - 12	
IEC 60947-7-1				
IEC	UL/CUL	CSA	IEC/EN 60079-7	
Rated voltage	400	-	-	-
Nominal current / cross section	16/2.5	-	-	-
Rated cross section	2.5	-	-	-
Cross section range	26 - 12	-	-	-
Connection capacity		solid	stranded	Ferrule with/without plastic sleeve
1 conductor	0.14 - 4	0.14 - 2.5	0.14 - 2.5	0.14 - 2.5
Two stranded conductors with a TWIN ferrule	0.34 - 4	-	0.34 - 2.5	0.5
Connection cross sections directly plug-in	0.34 - 4	-	0.34 - 2.5	0.34 - 2.5
General data		10	PA	V0
Stripping length				
Insulating material				
Inflammability class according to UL 94				

Description	Color
<b>Disconnect terminal block</b> , for mounting on NS 35...	gray
<b>Knife disconnect terminal block</b> , for mounting on NS 35...	blue
<b>Double-level knife disconnect terminal block</b> , disconnection on both levels, for mounting on NS 35...	gray
<b>Feed-through terminal block</b> , same shape, for mounting on NS 35...	blue
	gray
	blue

Ordering data		
Type	Order No.	Pcs. / Pkt.
PTT 2,5-L/TG	3210230	50
PTT 2,5-L/TG BU	3210270	50

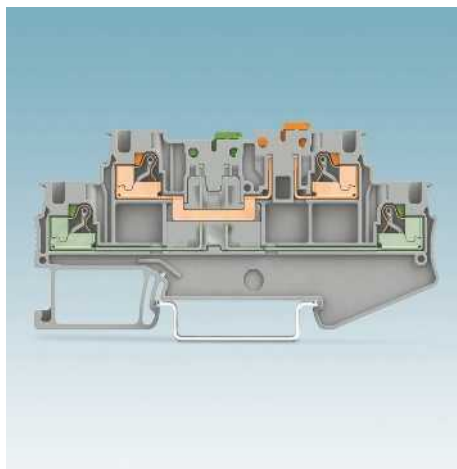

<b>Cover</b> , 0.8 mm width	gray
	orange
<b>Partition plate</b> , 2 mm width	gray
<b>Switching lock</b> , plug-in <sup>4)</sup>	white
<b>Isolating plug<sup>2)</sup></b>	orange
<b>Feed-through connector<sup>2)</sup></b>	gray
<b>Component plug</b> , labeled with ZBF 5 or UC-TMF 5 <sup>3)</sup>	gray
<b>Fuse plug</b> , width 5.2 mm <sup>1)</sup>	black
with LED for 12-30 V DC, 0.35-0.95 mA	black
for 30-60 V AC/DC, 0.36-0.95 mA	black
for 110-250 V AC/DC, 0.4-0.95 mA	black
<b>Test plug metal part</b> , 2.3 mm Ø	silver
<b>Insulating sleeve</b> , for MPS metal part	red
<b>Modular test plug housing</b> , for MPS metal part, can be marked with ZB 5	red
<b>Screwdriver</b>	
<b>Lateral groove labeling</b>	

Accessories		
Type	Order No.	Pcs. / Pkt.
D-PTT 2,5-2MT-0,8	3210300	50
D-PTT 2,5-2MT-0,8 OG	3210299	50
ATP-STTB 4	3030747	50
P-DI	3036783	50
P-FIX	3038956	50
P-CO	3036796	10
P-FU 5X20-5	3209235	10
P-FU 5X20 LED 24-5	3209248	10
P-FU 5X20 LED 60-5	3209251	10
P-FU 5X20 LED 250-5	3209264	10
MPS-MT	0201744	10
MPS-IH RD	0201676	10
PS-5/2,3MM RD	3038723	10
SZF 1-0,6X3,5	1204517	10
UC-TMF 5, UCT-TMF 5 or ZBF 5 (see Catalog 5)		



## Modular terminal blocks - CLIPLINE complete

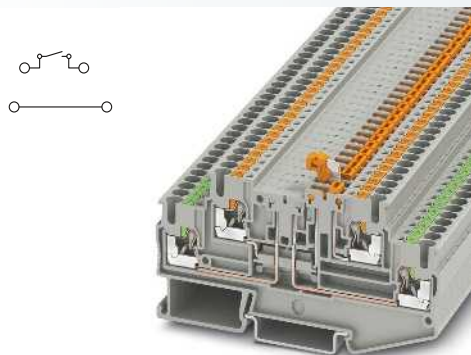

2.5 (4) mm<sup>2</sup>, 16 A, double-level terminal block with one knife disconnect zone

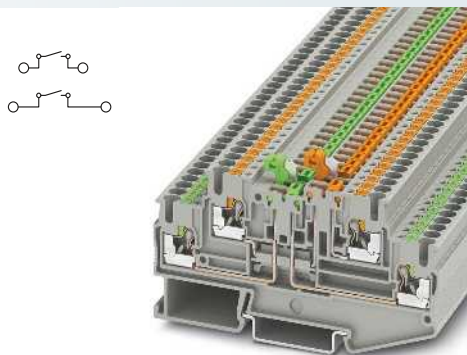

2.5 (4) mm<sup>2</sup>, 16 A, double-level terminal block with two knife disconnect zones

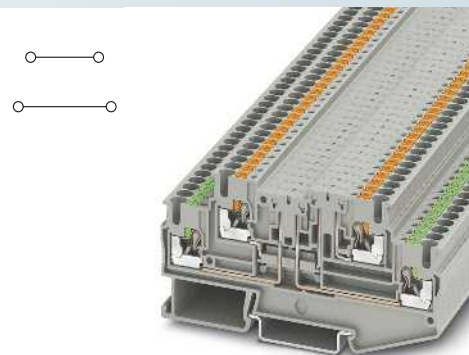

2.5 (4) mm<sup>2</sup>, 20 A, double-level terminal block, same shape

Technical data			
Width	Length	Height NS 35/7,5	
5.2	92.4	47.4	
$I_{max}$ [A]	$U_{max}$ [V]	max. Ø [mm <sup>2</sup> ]	AWG
16	400	0.14 - 4	26 - 12
IEC 60947-7-1			
IEC	UL/CUL	CSA	IEC/EN 60079-7
400	-	-	-
16/2.5	-	-	-
2.5	-	-	-
26 - 12	-	-	-
solid	stranded	Ferrule with/without plastic sleeve	
0.14 - 4	0.14 - 2.5	0.14 - 2.5	0.14 - 2.5 0.5
0.34 - 4	-	0.34 - 2.5	0.34 - 2.5
10	PA	V0	

Technical data			
Width	Length	Height NS 35/7,5	
5.2	92.4	47.4	
$I_{max}$ [A]	$U_{max}$ [V]	max. Ø [mm <sup>2</sup> ]	AWG
16	400	0.14 - 4	26 - 12
IEC 60947-7-1			
IEC	UL/CUL	CSA	IEC/EN 60079-7
400	-	-	-
16/2.5	-	-	-
2.5	-	-	-
26 - 12	-	-	-
solid	stranded	Ferrule with/without plastic sleeve	
0.14 - 4	0.14 - 2.5	0.14 - 2.5	0.14 - 2.5 0.5
0.34 - 4	-	0.34 - 2.5	0.34 - 2.5
10	PA	V0	

Technical data			
Width	Length	Height NS 35/7,5	
5.2	92.4	47.4	
$I_{max}$ [A]	$U_{max}$ [V]	max. Ø [mm <sup>2</sup> ]	AWG
20	400	0.14 - 4	26 - 12
IEC 60947-7-1			
IEC	UL/CUL	CSA	IEC/EN 60079-7
400	-	-	-
20/2.5	-	-	-
2.5	-	-	-
26 - 12	-	-	-
solid	stranded	Ferrule with/without plastic sleeve	
0.14 - 4	0.14 - 2.5	0.14 - 2.5	0.14 - 2.5 0.5
0.34 - 4	-	0.34 - 2.5	0.34 - 2.5
10	PA	V0	

Ordering data		
Type	Order No.	Pcs. / Pkt.
PTT 2,5-L/MT	3210251	50
PTT 2,5-L/MT BU	3210257	50

Ordering data		
Type	Order No.	Pcs. / Pkt.
PTT 2,5-2MT	3210258	50
PTT 2,5-2MT BU	3210265	50

Ordering data		
Type	Order No.	Pcs. / Pkt.
PTT 2,5-2L	3210267	50
PTT 2,5-2L BU	3210268	50

Accessories		
D-PTT 2,5-2MT-0,8	3210300	50
D-PTT 2,5-2MT-0,8 OG	3210299	50
ATP-STTB 4	3030747	50
S-MT	3247954	50
MPS-MT	0201744	10
MPS-IH RD	0201676	10
PS-5/2,3MM RD	3038723	10
SZF 1-0,6X3,5	1204517	10

Accessories		
D-PTT 2,5-2MT-0,8	3210300	50
D-PTT 2,5-2MT-0,8 OG	3210299	50
ATP-STTB 4	3030747	50
S-MT	3247954	50
MPS-MT	0201744	10
MPS-IH RD	0201676	10
PS-5/2,3MM RD	3038723	10
SZF 1-0,6X3,5	1204517	10

Accessories		
D-PTT 2,5-2MT-0,8	3210300	50
D-PTT 2,5-2MT-0,8 OG	3210299	50
ATP-STTB 4	3030747	50
MPS-MT	0201744	10
MPS-IH RD	0201676	10
PS-5/2,3MM RD	3038723	10
SZF 1-0,6X3,5	1204517	10

UC-TMF 5, UCT-TMF 5 or ZBF 5  
(see Catalog 5)

UC-TMF 5, UCT-TMF 5 or ZBF 5  
(see Catalog 5)

UC-TMF 5, UCT-TMF 5 or ZBF 5  
(see Catalog 5)

# Modular terminal blocks

## Modular terminal blocks - CLIPLINE complete

### PTTBS 2,5... push-in double-level disconnect and knife disconnect terminal blocks in desk design

The angled push-in terminal blocks in desk-design were developed for wiring systems where space is saved by means of underfloor wiring. They offer numerous advantages:

- Design width of just 5.2 mm
- Angled conductor entry for use in flat terminal boxes
- Disconnection option on each level
- The assignment from the disconnect knife to the contact points is indicated by the colored levers and the height offset
- Two function shafts before and after the disconnect point for flexible potential distribution
- Additional 2.3 mm test connections on the contact chamber lever
- Two large-surface, central marking options, marking assigned through a height offset
- Convenient potential bridging of the levels with the vertical FBS-PV potential bridge
- PTTBS 2,5-2TGB with universal disconnect zone, for accommodating isolating plugs, feed-through connectors, component and fuse plugs

CLIP PROJECT Planning enables the quick and convenient planning and configuration of fault-free terminal strips.

Notes:
1) If the fuse is faulty, the downstream circuit is not disconnected.
2) Observe max. load current.
3) Observe max. load current, depending on the power dissipation of the components. Max. 0.5 W with single arrangement.
4) see Catalog 3.

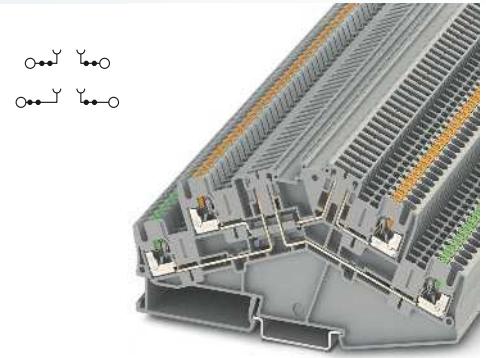

2.5 (4) mm<sup>2</sup>, 16 A, double-level terminal block with two disconnect zones

Dimensions	
	[mm]
Max. electrical data	
Rated data	
Rated voltage	[V]
Nominal current / cross section	[A] / [mm <sup>2</sup> ]
Rated cross section	[mm <sup>2</sup> ]
Cross section range	AWG
Connection capacity	
1 conductor	[mm <sup>2</sup> ]
Two stranded conductors with a TWIN ferrule	[mm <sup>2</sup> ]
Connection cross sections, plug-in	[mm <sup>2</sup> ]
General data	
Stripping length	[mm]
Insulating material	
Inflammability class according to UL 94	

Technical data				
Width	Length	Height NS 35/7,5		
5.2	124.8	64.3		
I <sub>max</sub> [A]	U <sub>max</sub> [V]	max. Ø [mm <sup>2</sup> ]	AWG	
16	400	0.14 - 4	26 - 12	
IEC 60947-7-1				
IEC	UL/CUL	CSA	IEC/EN 60079-7	
Rated voltage	400	-	-	-
Nominal current / cross section	16/2.5	-	-	-
Rated cross section	2.5	-	-	-
Cross section range	26 - 12	-	-	-
Connection capacity		solid	stranded	Ferrule with/without plastic sleeve
0.14 - 4	0.14 - 2.5	0.14 - 2.5	0.14 - 2.5	0.14 - 2.5
0.34 - 4	-	0.34 - 2.5	0.34 - 2.5	0.5
General data		10	PA	V0
Stripping length	[mm]			
Insulating material				
Inflammability class according to UL 94				

Description	No. of pos.	Color
Disconnect terminal block, for mounting on NS 35...		gray
Knife disconnect terminal block, for mounting on NS 35...		gray
		blue

Ordering data		
Type	Order No.	Pcs. / Pkt.
PTTBS 2,5-2TGB	3210402	50

Cover, 0.8 mm width		gray
Insulation stop sleeve, cross section range:		
0.08 - 0.2 mm <sup>2</sup>		white
0.25 - 0.5 mm <sup>2</sup>		gray
0.75 - 1 mm <sup>2</sup>		black
Jumper		
	2	red
	3	red
	4	red
	5	red
	10	red
	20	red
Vertical potential bridge, to connect the upper and lower level		black

Accessories		
D-PTTBS 2,5-2MTB	3210404	50
ISH 2,5/0,2	3002843	50
ISH 2,5/0,5	3002856	50
ISH 2,5/1,0	3002869	50
FBS 2-5	3030161	50
FBS 3-5	3030174	50
FBS 4-5	3030187	50
FBS 5-5	3030190	50
FBS 10-5	3030213	10
FBS 20-5	3030226	10
FBS-PV	3032185	50
PS-5	3030983	10
P-DI	3036783	50
P-FIX	3038956	50
P-CO	3036796	10
P-FU 5X20-5	3209235	10
P-FU 5X20 LED 24-5	3209248	10
P-FU 5X20 LED 60-5	3209251	10
P-FU 5X20 LED 250-5	3209264	10
SZF 1-0,6X3,5	1204517	10

Switching lock, plug-in <sup>4)</sup>		white
Modular test plug, for the individual assembly of test pin strips		red
Isolating plug <sup>2)</sup>		orange
Feed-through connector <sup>2)</sup>		gray
Component plug, labeled with ZBF 5 or UC-TMF 5 <sup>3)</sup>		gray
Fuse plug, width 5.2 mm <sup>1)</sup>		black
With LED for 12-30 V DC, 0.35-0.95 mA		black
for 30-60 V AC/DC, 0.36-0.95 mA		black
for 110-250 V AC/DC, 0.4-0.95 mA		black
Screwdriver		

Center groove labeling		
------------------------	--	--

UC-TM 5, UCT-TM 5 or ZB 5 (see Catalog 5)		
---	--	--

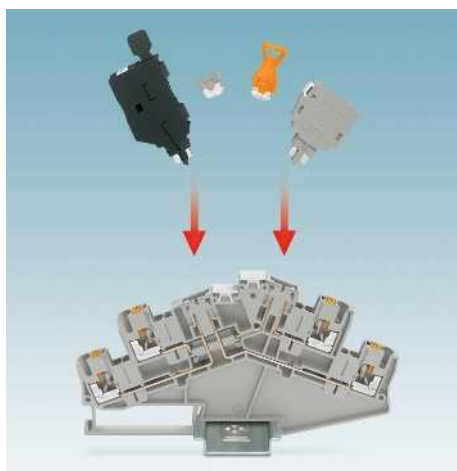

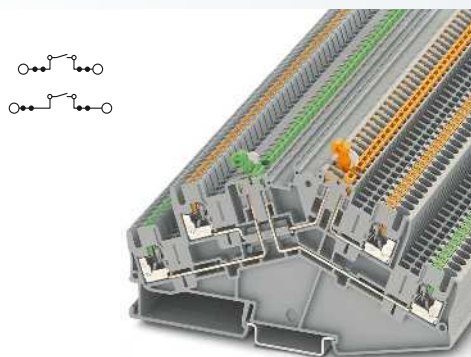
**2.5 (4) mm<sup>2</sup>, 16 A, double-level terminal block with two knife disconnect zones**
**Technical data**

Width	Length	Height NS 35/7,5	
<b>5.2</b>	<b>124.8</b>	<b>64.3</b>	
$I_{max}$ [A]	$U_{max}$ [V]	max. Ø [mm <sup>2</sup> ]	AWG
<b>16</b>	<b>400</b>	<b>0.14 - 4</b>	<b>26 - 12</b>
IEC 60947-7-1			
IEC	UL/CUL	CSA	IEC/EN 60079-7
400	-	-	-
16/2.5	-	-	-
2.5	-	-	-
26 - 12	-	-	-
solid	stranded	Ferrule with/without plastic sleeve	
0.14 - 4	0.14 - 2.5	0.14 - 2.5	0.14 - 2.5 0.5
0.34 - 4	-	0.34 - 2.5	0.34 - 2.5
10	PA	V0	

**Ordering data**

Type	Order No.	Pcs. / Pkt.
<b>PTTBS 2,5-2MTB</b>	<b>3210400</b>	50
<b>PTTBS 2,5-2MTB BU</b>	<b>3210401</b>	50

**Accessories**

<b>D-PTTBS 2,5-2MTB</b>	<b>3210404</b>	50
ISH 2,5/0,2	3002843	50
ISH 2,5/0,5	3002856	50
ISH 2,5/1,0	3002869	50
FBS 2-5	3030161	50
FBS 3-5	3030174	50
FBS 4-5	3030187	50
FBS 5-5	3030190	50
FBS 10-5	3030213	10
FBS 20-5	3030226	10
FBS-PV	3032185	50
S-MT	3247954	50
PS-5	3030983	10
<b>SZF 1-0,6X3,5</b>	<b>1204517</b>	10

 UC-TM 5, UCT-TM 5 or ZB 5  
(see Catalog 5)

# Modular terminal blocks

## Modular terminal blocks - CLIPLINE complete

### UT ...-TG screw connection, disconnect and knife disconnect terminal blocks with fuse plug



- Compact design and high current carrying capacity of up to 20 A
- Double bridge shaft enables individual potential distribution and supply
- The function terminals are suitable for use in potentially explosive areas (zone 2) according to standards established worldwide.

They meet the requirements of the following ignition protection concepts:

#### Marking

IECEX:

- Ex nA IIC Gc
- ATEX:
- II 3 G Ex nA IIC Gc
- Ex i

UL US

- AEx nA IIC Gc
- Class I zone 2
- Class I Division 2 Groups A B

#### S-MT switching lock

- The optional switching lock snaps in and effectively prevents accidental switching, see figure below



Notes:
Detailed information and data sheets regarding modular terminal blocks in the Ex area are available in the product area on our website at phoenixcontact.net/products and in IECEx Certificate of Conformity IECEx UL 13.0007U and in UL file E192998.
1) If the fuse is faulty, the downstream circuit is not disconnected.
2) Current and voltage are determined by the plug used.
3) see Catalog 3.



4 (6) mm<sup>2</sup>, 20 A, disconnect terminal block, with test socket screws

Ex:   
IECEX UL 13.0007U

#### Technical data

Width	Length	Height NS 35/7,5	
6.2	57.8	47.5	
$I_{max}$ [A]	$U_{max}$ [V]	max. Ø [mm <sup>2</sup> ]	AWG
20 <sup>2</sup> )	500 <sup>2</sup> )	0.14 - 6	26 - 10
IEC 60947-7-1			
IEC	UL/CUL	CSA	IEC/EN 60079-7
Rated voltage [V]	500 <sup>2</sup> )	-	250
Nominal current / cross section [A] / [mm <sup>2</sup> ]	20 <sup>2</sup> )/2.5	-	6.3
Rated cross section [mm <sup>2</sup> ]	4	-	0.14-4
Cross section range AWG	26 - 10	-	26 - 10
Connection capacity		Ferrule	
1 conductor [mm <sup>2</sup> ]	0.14 - 6	0.14 - 6	with/without plastic sleeve
Two conductors (of the same type) [mm <sup>2</sup> ]	0.14 - 1.5	0.14 - 1.5	0.14 - 4
Two stranded conductors with a TWIN ferrule [mm <sup>2</sup> ]			-
			0.5 - 2.5
General data			
Stripping length [mm]	9		
Insulating material	PA		
Inflammability class according to UL 94	V0		

#### Ordering data

Type	Order No.	Pcs. / Pkt.
UT 4-TG-EX	3046143	50
UT 4-TG-P/P-EX	3046169	50

#### Accessories

ATP-UT-TWIN	3047183	50
PAI-4-N GY	3032871	10
MPS-MT	0201744	10
MPS-IH RD	0201676	10
PS-6	3030996	10
P-FU 5X20-EX	3036807	10
SZS 0,6X3,5	1205053	10

Description	No. of pos.	Color
Disconnect terminal block, for mounting on NS 35... with test socket screws		gray
Knife disconnect terminal block, for mounting on NS 35...		gray
Fuse plug, width 6.2 mm <sup>1</sup> ) with LED for 12-30 V DC, 0.35-0.95 mA		black
for 30-60 V AC/DC, 0.36-0.95 mA		black
for 110-250 V AC/DC, 0.4-0.95 mA		black
Fuse plug, width 8.2 mm <sup>1</sup> ) with LED for 12-30 V DC, 0.35-0.95 mA		black
for 30-60 V AC/DC, 0.36-0.95 mA		black
for 110-250 V AC/DC, 0.4-0.95 mA		black

Switching lock, plug-in <sup>3</sup> )	white
Partition plate, 2.2 mm wide	gray
Test adapter, 4 mm test socket hole	gray
Test plug metal part, 2.3 mm Ø	silver
Insulating sleeve, for MPS metal part	red
Modular test plug, for the individual assembly of test pin strips	red
Fuse plug, width 6.2 mm <sup>1</sup> )	black
Width 8.2 mm	black

Center groove labeling
Lateral groove labeling

UC-TM 6, UCT-TM 6 or ZB 6 (see Catalog 5)

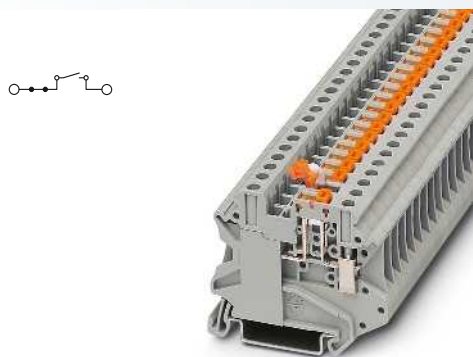

4 (6) mm<sup>2</sup>, 20 A, knife disconnect terminal block, with test socket screws

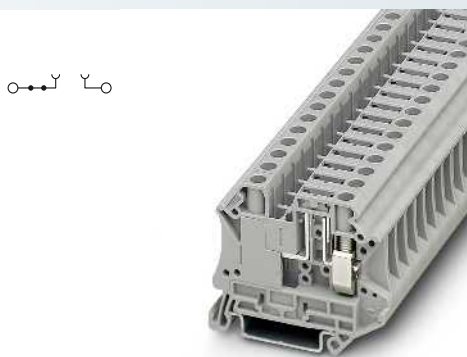

6 (10) mm<sup>2</sup>, 20 A, disconnect terminal block, with test socket screws



6.2 mm and 8.2 mm fuse plug, for 5 x 20 mm and 6.3 x 32 mm cartridge fuses

Ex: IECEx UL 13.0007U

Ex: IECEx UL 13.0007U

Ex: IECEx UL 13.0007U

Technical data			
Width	Length	Height NS 35/7,5	
6.2	57.8	49.1	
I <sub>max</sub> [A]	U <sub>max</sub> [V]	max. Ø [mm <sup>2</sup> ]	AWG
20	500	0.14 - 6	26 - 10
IEC 60947-7-1			
IEC	UL/CUL	CSA	IEC/EN 60079-7
500	-	-	500
20/2.5	-	-	16
4	-	-	0.14-4
26 - 10	-	-	26 - 10
solid	stranded	Ferrule with/without plastic sleeve	
0.14 - 6	0.14 - 6	0.14 - 4	0.14 - 4
0.14 - 1.5	0.14 - 1.5	0.14 - 1.5	-
0.5 - 2.5			
9			
PA			
V0			

Technical data			
Width	Length	Height NS 35/7,5	
8.2	57.8	47.5	
I <sub>max</sub> [A]	U <sub>max</sub> [V]	max. Ø [mm <sup>2</sup> ]	AWG
20 <sup>2)</sup>	500 <sup>2)</sup>	0.2 - 10	24 - 8
IEC 60947-7-1			
IEC	UL/CUL	CSA	IEC/EN 60079-7
500 <sup>2)</sup>	-	-	250
20 <sup>2)</sup> /2.5	-	-	6.3
6	-	-	0.2-6
24 - 8	-	-	24 - 8
solid	stranded	Ferrule with/without plastic sleeve	
0.2 - 10	0.2 - 10	0.25 - 6	0.25 - 6
0.2 - 2.5	0.2 - 2.5	0.25 - 1.5	-
0.5 - 4			
10			
PA			
V0			

Technical data			
Width	Length	Height NS 35/7,5	
-	-	-	
		max. Ø [mm <sup>2</sup> ]	AWG
		-	-
IEC	UL/CUL	CSA	IEC/EN 60079-7
-	-	-	-
-	-	-	-
-	-	-	-
-	-	-	-
solid	stranded	Ferrule with/without plastic sleeve	
-	-	-	-
-	-	-	-
-			
PA			
V0			

Ordering data		
Type	Order No.	Pcs. / Pkt.
UT 4-MT-EX	3046141	50
UT 4-MT-P/P-EX	3046173	50

Ordering data		
Type	Order No.	Pcs. / Pkt.
UT 6-TG-EX	3046486	50
UT 6-TG P/P-EX	3073870	50

Ordering data		
Type	Order No.	Pcs. / Pkt.
P-FU 5X20-EX	3036807	10
P-FU 5X20 LED 24-EX	3036821	10
P-FU 5X20 LED 60-EX	3036823	10
P-FU 5X20 LA 250-EX	3036836	10
P-FU 6,3X32-EX	3046499	10
P-FU 6,3X32 LED 24-EX	3046509	10
P-FU 6,3X32 LED 60-EX	3046512	10
P-FU 6,3X32 LA 250-EX	3046525	10

Accessories		
S-MT	3247954	50
ATP-UT-TWIN	3047183	50
PAI-4-N GY	3032871	10
MPS-MT	0201744	10
MPS-IH RD	0201676	10
PS-6	3030996	10
SZS 0,6X3,5	1205053	10

Accessories		
ATP-UT-TWIN	3047183	50
PAI-4-N GY	3032871	10
MPS-MT	0201744	10
MPS-IH RD	0201676	10
PS-6	3030996	10
P-FU 6,3X32-EX	3046499	10
SZS 1,0X4,0 VDE	1205066	10

Accessories		

UC-TM 6, UCT-TM 6 or ZB 6 (see Catalog 5)

UC-TM 8, UCT-TM 8 or ZB 8 (see Catalog 5)

UC-TMF 5, UCT-TMF 5 or ZBF 5 (see Catalog 5)

# Modular terminal blocks

## Modular terminal blocks - CLIPLINE complete

### UTTB ...-TG, UTT ...-2(MT) screw connection, double-level disconnect and knife disconnect terminal blocks

- Optimized for process technology through:
- Design width of just 5.2 mm
  - Space-saving design for maximum wiring density
  - Disconnection option on each level
  - Testing facility on both sides of the disconnect point
  - Clear assignment of the disconnect levels thanks to height offset and color disconnect knife, green at the bottom, orange at the top

#### Offset levels

- Offset levels provide:
- Unobstructed access to the lower connection level if fully wired
  - Better view of the lower marking labels and conductor entry funnel

Notes:
1) Observe max. load current.
2) Observe max. load current, depending on the power dissipation of the components. Max. 0.5 W with single arrangement.
3) Current and voltage are determined by the plug used.
4) see Catalog 3.
5) For maximum power dissipation, see Catalog 3.

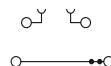

2.5 (4) mm<sup>2</sup>, 20 A, double-level terminal block with disconnect zone, test socket screw

Dimensions	[mm]
Width	5.2
Length	69.9
Height NS 35/7,5	64.8
Max. electrical data	
I <sub>max</sub> [A]	20
U <sub>max</sub> [V]	400
IEC 60947-7-1	
IEC	UL/CUL
CSA	IEC/EN 60079-7
Rated data lower level	
Rated voltage [V]	400
Nominal current / cross section [A] / [mm <sup>2</sup> ]	20/2.5
Rated cross section [mm <sup>2</sup> ]	2.5
Cross section range AWG	26 - 12
Rated data, upper level	
IEC	UL/CUL
CSA	IEC/EN 60079-7
Connection capacity	
Nominal current / cross section [A] / [mm <sup>2</sup> ]	16 <sup>3)</sup> /2.5
solid	stranded
	Ferrule with/without plastic sleeve
1 conductor [mm <sup>2</sup> ]	0.14 - 4
Two conductors (of the same type) [mm <sup>2</sup> ]	0.14 - 4
Two stranded conductors with a TWIN ferrule [mm <sup>2</sup> ]	0.14 - 1.5
	0.14 - 2.5
	0.14 - 1.5
	0.5 - 1.5
General data	
Stripping length [mm]	9
Screw thread	M3
Tightening torque [Nm]	0.5 - 0.6
Insulating material	PA
Inflammability class according to UL 94	V0

Technical data			
Width	Length	Height NS 35/7,5	
5.2	69.9	64.8	
I <sub>max</sub> [A]	U <sub>max</sub> [V]	max. Ø [mm <sup>2</sup> ]	AWG
20	400	0.14 - 4	26 - 12
IEC 60947-7-1			
IEC	UL/CUL	CSA	IEC/EN 60079-7
Rated voltage [V]	-	-	-
Nominal current / cross section [A] / [mm <sup>2</sup> ]	20/2.5	-	-
Rated cross section [mm <sup>2</sup> ]	2.5	-	-
Cross section range AWG	26 - 12	-	-
IEC	UL/CUL	CSA	IEC/EN 60079-7
Nominal current / cross section [A] / [mm <sup>2</sup> ]	16 <sup>3)</sup> /2.5	-	-
solid	stranded	Ferrule with/without plastic sleeve	
1 conductor [mm <sup>2</sup> ]	0.14 - 4	0.14 - 2.5	0.14 - 2.5
Two conductors (of the same type) [mm <sup>2</sup> ]	0.14 - 1.5	0.14 - 1.5	-
Two stranded conductors with a TWIN ferrule [mm <sup>2</sup> ]			0.5 - 1.5
Stripping length [mm]	9		
Screw thread	M3		
Tightening torque [Nm]	0.5 - 0.6		
Insulating material	PA		
Inflammability class according to UL 94	V0		

Description	No. of pos.	Color
Disconnect terminal block, for mounting on NS 35...		gray
Knife disconnect terminal block, for mounting on NS 35...		gray
		blue
Double-level knife disconnect terminal block, disconnection on both levels, for mounting on NS 35...		gray
		blue

Ordering data		
Type	Order No.	Pcs. / Pkt.
UTT 2,5-TG-P/P	3044644	50

Cover, width 2.2 mm	gray
Spacer plate, compensates for level offsets, width 2.5 mm	gray
Jumper	
	2 red
	3 red
	4 red
	5 red
	10 red
	20 red
Switching lock, plug-in <sup>4)</sup>	white
Isolating plug <sup>1)</sup>	orange
Feed-through connector <sup>1)</sup>	gray
Component plug, labeled with ZBF 5 or UC-TMF 5 <sup>2)</sup>	gray
Fuse plug, width 6.2 mm <sup>5)</sup>	black
Screwdriver	
Lateral groove labeling	

Accessories		
D-UTT 2,5/4	3044676	50
DP-UTT 2,5/4	3044677	50
FBS 2-5	3030161	50
FBS 3-5	3030174	50
FBS 4-5	3030187	50
FBS 5-5	3030190	50
FBS 10-5	3030213	10
FBS 20-5	3030226	10
P-DI	3036783	50
P-FIX	3038956	50
P-CO	3036796	10
P-FU 5X20	3036806	10
SZG 0,6X3,5 VDE	1205121	10
UC-TM 5, UCT-TM 5 or ZB 5 (see Catalog 5)		



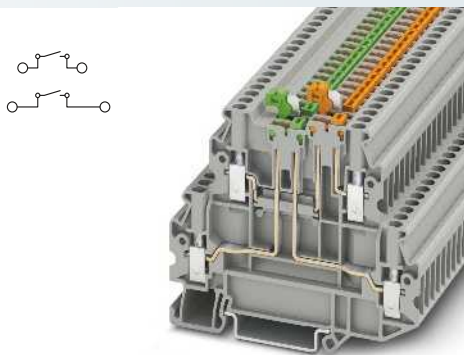
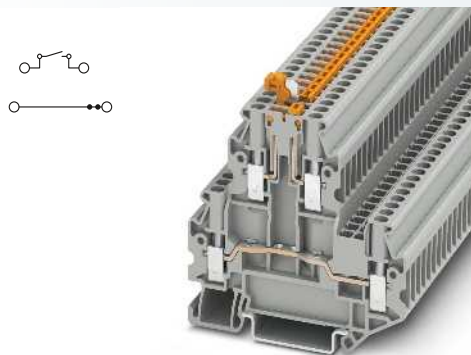

2.5 (4) mm<sup>2</sup>, 20 A, double-level terminal block with disconnect knife, test socket screw

2.5 (4) mm<sup>2</sup>, 16 A, double-level terminal block with a disconnect knife per level, test socket screw

Technical data			
Width	Length	Height NS 35/7,5	
5.2	69.9	64.8	
I <sub>max</sub> [A]	U <sub>max</sub> [V]	max. Ø [mm <sup>2</sup> ]	AWG
20	400	0.14 - 4	26 - 12
IEC 60947-7-1			
IEC	UL/CUL	CSA	IEC/EN 60079-7
400	-	-	-
20/2.5	-	-	-
2.5	-	-	-
26 - 12	-	-	-
IEC	UL/CUL	CSA	IEC/EN 60079-7
16/2.5	-	-	-
solid	stranded	Ferrule with/without plastic sleeve	
0.14 - 4	0.14 - 4	0.14 - 2.5	0.14 - 2.5
0.14 - 1.5	0.14 - 1.5	0.14 - 1.5	-
			0.5 - 1.5
9			
M3			
0.5 - 0.6			
PA			
V0			

Technical data			
Width	Length	Height NS 35/7,5	
5.2	80.1	58.1	
I <sub>max</sub> [A]	U <sub>max</sub> [V]	max. Ø [mm <sup>2</sup> ]	AWG
16	400	0.14 - 4	26 - 12
IEC 60947-7-1			
IEC	UL/CUL	CSA	IEC/EN 60079-7
400	-	-	-
16/2.5	-	-	-
2.5	-	-	-
26 - 12	-	-	-
IEC	UL/CUL	CSA	IEC/EN 60079-7
16/2.5	-	-	-
solid	stranded	Ferrule with/without plastic sleeve	
0.14 - 4	0.14 - 4	0.14 - 2.5	0.14 - 2.5
0.14 - 1.5	0.14 - 1.5	0.14 - 1.5	-
			0.5 - 1.5
9			
M3			
0.5 - 0.6			
PA			
V0			

Ordering data		
Type	Order No.	Pcs. / Pkt.
UTT 2,5-MT-P/P	3044640	50
UTT 2,5-MT-P/P BU	3044641	50

Ordering data		
Type	Order No.	Pcs. / Pkt.
UTT 2,5-2MT-P/P	3044670	50
UTT 2,5-2MT-P/P BU	3044671	50

Accessories		
D-UTT 2,5/4	3044676	50
DP-UTT 2,5/4	3044677	50
FBS 2-5	3030161	50
FBS 3-5	3030174	50
FBS 4-5	3030187	50
FBS 5-5	3030190	50
FBS 10-5	3030213	10
FBS 20-5	3030226	10
S-MT	3247954	50
SZG 0,6X3,5 VDE	1205121	10

Accessories		
D-UTT 2,5/4	3044676	50
DP-UTT 2,5/4	3044677	50
S-MT	3247954	50
SZG 0,6X3,5 VDE	1205121	10

UC-TM 5, UCT-TM 5 or ZB 5 (see Catalog 5)

UC-TM 5, UCT-TM 5 or ZB 5 (see Catalog 5)

# Modular terminal blocks

## Modular terminal blocks - CLIPLINE complete

### Screw connection, multi-level function and lever-type fuse terminal blocks with UT 4... PE foot

- Suitable for process technology thanks to applied for Ex nA approval
- For power and signal transmission in potentially explosive areas
- Same shape as UT 4-PE/L/HESI multi-level lever-type fuse terminal blocks on the following page

### Terminal strip service

We produce fully pre-assembled terminal strips for fitting straight into the control cabinet or switch system. This simplifies installation, saves time, and cuts costs.

Notes:
1) Observe max. load current.
2) Observe max. load current, depending on the power dissipation of the components. Max. 0.5 W with single arrangement.
3) Current and voltage are determined by the plug used.
4) see Catalog 3.
5) For maximum power dissipation, see Catalog 3.

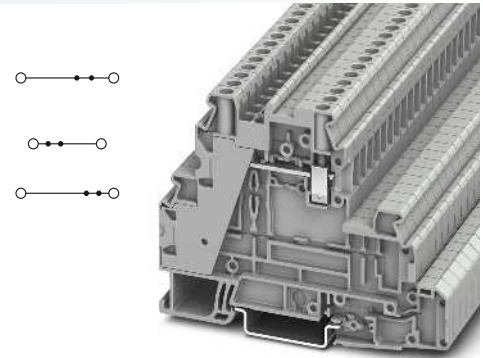

4 (6) mm<sup>2</sup>, 36 A, feed-through terminal block

Dimensions	
	[mm]
Max. electrical data	
Rated data lower level	
Rated voltage	[V]
Nominal current / cross section	[A] / [mm <sup>2</sup> ]
Rated cross section	[mm <sup>2</sup> ]
Cross section range	AWG
Rated data, upper level	
Nominal current / cross section	[A] / [mm <sup>2</sup> ]
Connection capacity	
1 conductor	[mm <sup>2</sup> ]
Two conductors (of the same type)	[mm <sup>2</sup> ]
Two stranded conductors with a TWIN ferrule	[mm <sup>2</sup> ]
General data	
Stripping length	[mm]
Screw thread	
Tightening torque	[Nm]
Insulating material	
Inflammability class according to UL 94	

Technical data			
Width	Length	Height NS 35/7,5	
6.2	92.7	61.7	
I <sub>max</sub> [A]	U <sub>max</sub> [V]	max. Ø [mm <sup>2</sup> ]	AWG
36	500	0.14 - 6	26 - 10
IEC 60947-7-1			
IEC	UL/CUL	CSA	IEC/EN 60079-7
Rated voltage			
500	-	-	-
Nominal current / cross section			
30/4	-	-	-
Rated cross section			
4	-	-	-
Cross section range			
26 - 10	-	-	-
Rated data, upper level			
IEC	UL/CUL	CSA	IEC/EN 60079-7
Nominal current / cross section			
32/4	-	-	-
Connection capacity			
solid	stranded	Ferrule with/without plastic sleeve	
0.14 - 6	0.14 - 6	0.14 - 4	0.14 - 4
0.14 - 1.5	0.14 - 1.5	0.14 - 1.5	-
			0.5 - 1.5
Stripping length	9		
Screw thread	M3		
Tightening torque	0.6 - 0.8		
Insulating material	PA		
Inflammability class according to UL 94	V0		

Description	No. of pos.	Color
Feed-through terminal block, only in the upper level, for mounting on NS 35...		gray
Multi-level terminal block, upper and middle level, for mounting on NS 35...		gray
Multi-level terminal block, 2 x feed-through, 1 x PE, for mounting on NS 35...		gray
Multi-level terminal block, 1 x feed-through, 1 x blue printed feed-through, 1 x PE, for mounting on NS 35...		gray
Disconnect terminal block, for mounting on NS 35...		gray
Knife disconnect terminal block, for mounting on NS 35...		gray

Ordering data			
Type	I <sub>max</sub>	Order No.	Pcs. / Pkt.
UT 4-L		3214363	50
UT 4-L/L		3214362	50

Jumper	No. of pos.	Color
	2	red
	3	red
	4	red
	5	red
	10	red
	20	red
Switching lock, plug-in <sup>4)</sup>		white
Isolating plug <sup>1)</sup>		orange
Feed-through connector <sup>1)</sup>		gray
Component plug, labeled with ZBF 5 or UC-TMF 5 <sup>2)</sup>		gray
Fuse plug, width 6.2 mm <sup>5)</sup>		black
Screwdriver		

Accessories			
		Order No.	Pcs. / Pkt.
FBS 2-6	28 A	3030336	50
FBS 3-6	28 A	3030242	50
FBS 4-6	28 A	3030255	50
FBS 5-6	28 A	3030349	50
FBS 10-6	28 A	3030271	10
FBS 20-6	28 A	3030365	10
SZS 0,6X3,5		1205053	10

Center and side groove labeling
Lateral groove labeling

UC-TM 6, UCT-TM 6 or ZB 6 (see Catalog 5)
---





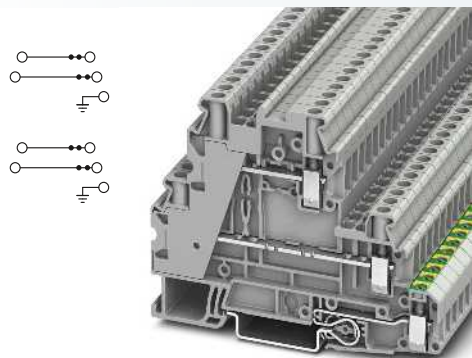

4 (6) mm<sup>2</sup>, 36 A, multi-level terminal block, PE foot

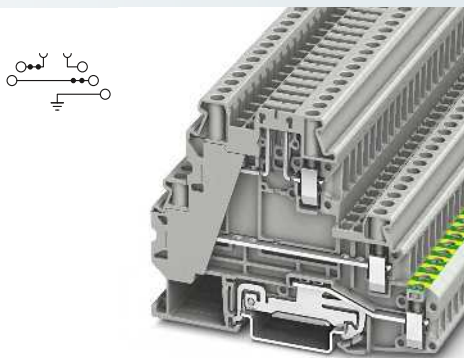

4 (6) mm<sup>2</sup>, 36 A, multi-level terminal block, disconnect zone, PE foot

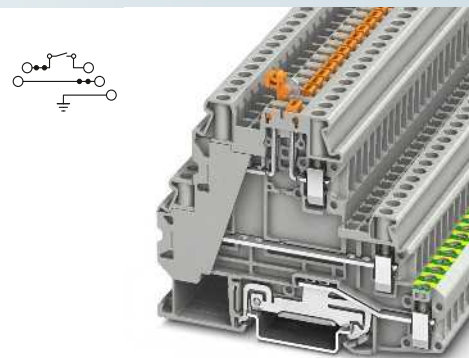

4 (6) mm<sup>2</sup>, 36 A, multi-level terminal block, disconnect knife, PE foot

Technical data			
Width	Length	Height NS 35/7,5	
6.2	92.7	61.7	
I <sub>max</sub> [A]	U <sub>max</sub> [V]	max. Ø [mm <sup>2</sup> ]	AWG
36	500	0.14 - 6	26 - 10
IEC 60947-7-1/IEC 60947-7-2			
IEC	UL/CUL	CSA	IEC/EN 60079-7
500	-	-	-
30/4	-	-	-
4	-	-	-
26 - 10	-	-	-
IEC	UL/CUL	CSA	IEC/EN 60079-7
32/4	-	-	-
solid	stranded	Ferrule with/without plastic sleeve	
0.14 - 6	0.14 - 6	0.14 - 4	0.14 - 4
0.14 - 1.5	0.14 - 1.5	0.14 - 1.5	-
			0.5 - 1.5
9			
M3			
0.6 - 0.8			
PA			
V0			

Technical data			
Width	Length	Height NS 35/7,5	
6.2	92.7	61.7	
I <sub>max</sub> [A]	U <sub>max</sub> [V]	max. Ø [mm <sup>2</sup> ]	AWG
36	500	0.14 - 6	26 - 10
IEC 60947-7-1/IEC 60947-7-2			
IEC	UL/CUL	CSA	IEC/EN 60079-7
500	-	-	-
30/4	-	-	-
4	-	-	-
26 - 10	-	-	-
IEC	UL/CUL	CSA	IEC/EN 60079-7
20 <sup>3</sup> /2.5	-	-	-
solid	stranded	Ferrule with/without plastic sleeve	
0.14 - 6	0.14 - 6	0.14 - 4	0.14 - 4
0.14 - 1.5	0.14 - 1.5	0.14 - 1.5	-
			0.5 - 1.5
9			
M3			
0.6 - 0.8			
PA			
V0			

Technical data			
Width	Length	Height NS 35/7,5	
6.2	92.7	61.7	
I <sub>max</sub> [A]	U <sub>max</sub> [V]	max. Ø [mm <sup>2</sup> ]	AWG
36	500	0.14 - 6	26 - 10
IEC 60947-7-1/IEC 60947-7-2			
IEC	UL/CUL	CSA	IEC/EN 60079-7
500	-	-	-
30/4	-	-	-
4	-	-	-
26 - 10	-	-	-
IEC	UL/CUL	CSA	IEC/EN 60079-7
20 <sup>3</sup> /2.5	-	-	-
solid	stranded	Ferrule with/without plastic sleeve	
0.14 - 6	0.14 - 6	0.14 - 4	0.14 - 4
0.14 - 1.5	0.14 - 1.5	0.14 - 1.5	-
			0.5 - 1.5
9			
M3			
0.6 - 0.8			
PA			
V0			

Ordering data			
Type	I <sub>max</sub>	Order No.	Pcs. / Pkt.
UT 4-PE/L/L		3214360	50
UT 4-PE/L/N		3214361	50
UT 4-PE/L/TG		3214365	50
UT 4-PE/L/MT		3214364	50

Ordering data			
Type	I <sub>max</sub>	Order No.	Pcs. / Pkt.
UT 4-PE/L/L		3214360	50
UT 4-PE/L/N		3214361	50
UT 4-PE/L/TG		3214365	50
UT 4-PE/L/MT		3214364	50

Ordering data			
Type	I <sub>max</sub>	Order No.	Pcs. / Pkt.
UT 4-PE/L/L		3214360	50
UT 4-PE/L/N		3214361	50
UT 4-PE/L/TG		3214365	50
UT 4-PE/L/MT		3214364	50

Accessories			
FBS 2-6	28 A	3030336	50
FBS 3-6	28 A	3030242	50
FBS 4-6	28 A	3030255	50
FBS 5-6	28 A	3030349	50
FBS 10-6	28 A	3030271	10
FBS 20-6	28 A	3030365	10
SZS 0,6X3,5		1205053	10

Accessories			
FBS 2-6	28 A	3030336	50
FBS 3-6	28 A	3030242	50
FBS 4-6	28 A	3030255	50
FBS 5-6	28 A	3030349	50
FBS 10-6	28 A	3030271	10
FBS 20-6	28 A	3030365	10
P-DI		3036783	50
P-FIX		3038956	50
P-CO		3036796	10
P-FU 5X20		3036806	10
SZS 0,6X3,5		1205053	10

Accessories			
FBS 2-6	28 A	3030336	50
FBS 3-6	28 A	3030242	50
FBS 4-6	28 A	3030255	50
FBS 5-6	28 A	3030349	50
FBS 10-6	28 A	3030271	10
FBS 20-6	28 A	3030365	10
S-MT		3247954	50
SZS 0,6X3,5		1205053	10

UC-TM 6, UCT-TM 6 or ZB 6 (see Catalog 5)

UC-TM 6, UCT-TM 6 or ZB 6 (see Catalog 5)

UC-TM 6, UCT-TM 6 or ZB 6 (see Catalog 5)

# Modular terminal blocks

## Modular terminal blocks - CLIPLINE complete

### Screw connection, multi-level lever-type fuse terminal blocks with UT 4... PE foot

- Suitable for process technology thanks to applied for Ex nA approval
- For power and signal transmission in potentially explosive areas
- Compact design for maximum space saving
- Two function shafts mean that all potential distribution tasks can be undertaken at speed
- Test connection on both sides in safety lever
- Same shape as the UT 4-PE/L... feed-through and disconnect terminal blocks

CLIP PROJECT Planning enables the quick and convenient planning and configuration of fault-free terminal strips.

Notes:
1) If the fuse is faulty, the downstream circuit is not disconnected.
2) The current is determined by the fuse used.
3) The current is determined by the fuse used, the voltage by the light indicator.
4) For maximum power dissipation, see Catalog 3.

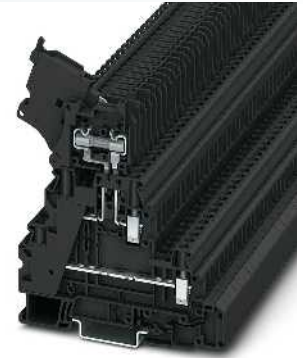
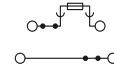

4 (6) mm<sup>2</sup>, 36 A, multi-level terminal block, safety lever

Dimensions		[mm]
<b>Max. electrical data</b>		
<b>Rated data lower level</b>		
Rated voltage	[V]	500 <sup>4)</sup>
Nominal current / cross section	[A] / [mm <sup>2</sup> ]	30/4
Rated cross section	[mm <sup>2</sup> ]	4
Cross section range	AWG	26 - 10
<b>Rated data, upper level</b>		
Nominal current / cross section	[A] / [mm <sup>2</sup> ]	6.3 <sup>2)</sup> /1
<b>Connection capacity</b>		
1 conductor	[mm <sup>2</sup> ]	0.14 - 6
Two conductors (of the same type)	[mm <sup>2</sup> ]	0.14 - 1.5
Two stranded conductors with a TWIN ferrule	[mm <sup>2</sup> ]	0.14 - 1.5
<b>General data</b>		
Stripping length	[mm]	9
Screw thread		M3
Tightening torque	[Nm]	0.6 - 0.8
Insulating material		PA
Inflammability class according to UL 94		V0

Technical data				
Width	Length	Height NS 35/7,5		
6.2	92.7	88.9		
I <sub>max</sub> [A]	U <sub>max</sub> [V]	max. Ø [mm <sup>2</sup> ]	AWG	
36 <sup>3)</sup>	500 <sup>4)</sup>	0.14 - 6	26 - 10	
IEC 60947-7-3				
IEC	UL/CUL	CSA	IEC/EN 60079-7	
Rated voltage				
500 <sup>4)</sup>	-	-	-	
Nominal current / cross section				
30/4	-	-	-	
Rated cross section				
4	-	-	-	
Cross section range				
26 - 10	-	-	-	
<b>Rated data, upper level</b>				
IEC	UL/CUL	CSA	IEC/EN 60079-7	
Nominal current / cross section				
6.3 <sup>2)</sup> /1	-/-	-	-	
<b>Connection capacity</b>				
solid		stranded		Ferrule
with/without plastic sleeve				
0.14 - 6	0.14 - 6	0.14 - 4	0.14 - 4	
0.14 - 1.5	0.14 - 1.5	0.14 - 1.5	-	
			0.5 - 1.5	

Description	No. of pos.	Color
<b>Fuse terminal block</b> , for mounting on NS 35..., for cartridge fuse inserts 5 x 20 mm		black
<b>Fuse terminal block</b> , for mounting on NS 35..., for 5 x 20 cartridge fuse inserts		black
with LED for 12-30 V DC, 0.31-0.95 mA <sup>1)</sup>		black
for 30-60 V AC/DC, 0.40-0.86 mA <sup>1)</sup>		black
for 110-250 V AC/DC, 0.41-0.96 mA <sup>1)</sup>		black
<b>Disconnect terminal block</b> , for mounting on NS 35...		black

Ordering data			
Type	I <sub>max</sub>	Order No.	Pcs. / Pkt.
UT 4-L/HESI (5X20)		3214325	50

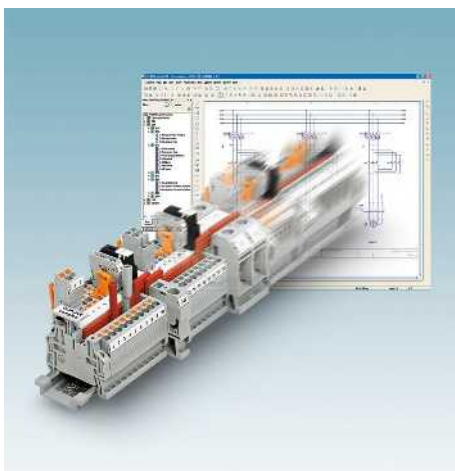

Feed-through metal, in the shape of a 5 x 20 mm glass tube fuse insert			
<b>Jumper</b>			
	2	red	
	3	red	
	4	red	
	5	red	
	10	red	
	20	red	
<b>Screwdriver</b>			

Accessories			
DMET 5X20		Order No.	Pcs. / Pkt.
		3032075	50
FBS 2-6	28 A	3030336	50
FBS 3-6	28 A	3030242	50
FBS 4-6	28 A	3030255	50
FBS 5-6	28 A	3030349	50
FBS 10-6	28 A	3030271	10
FBS 20-6	28 A	3030365	10
SZS 0,6X3,5		1205053	10

<b>Lever labeling</b>	UC-TM 5, UCT-TM 5 or ZB 5 (see Catalog 5)
<b>Lateral groove labeling</b>	UC-TM 6, UCT-TM 6 or ZB 6 (see Catalog 5)

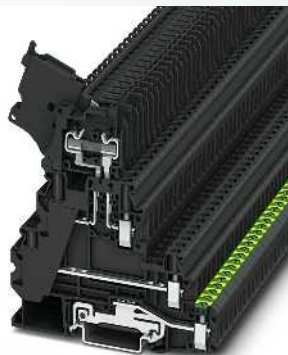
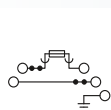

4 (6) mm<sup>2</sup>, 36 A, multi-level terminal block, safety lever, PE foot

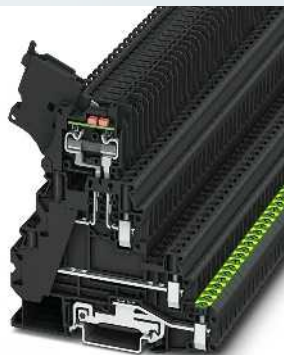
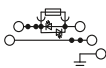

4 (6) mm<sup>2</sup>, 36 A, multi-level terminal block, safety lever with LED, PE foot

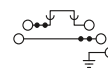

4 (6) mm<sup>2</sup>, 36 A, multi-level terminal block, disconnect lever, PE foot

Technical data			
Width	Length	Height NS 35/7,5	
6.2	92.7	88.9	
$I_{max}$ [A]	$U_{max}$ [V]	max. $\varnothing$ [mm <sup>2</sup> ]	AWG
36*)	500*)	0.14 - 6	26 - 10
IEC 60947-7-2/IEC 60947-7-3			
IEC	UL/CUL	CSA	IEC/EN 60079-7
500*)	-	-	-
30/4	-	-	-
4	-	-	-
26 - 10	-	-	-
IEC	UL/CUL	CSA	IEC/EN 60079-7
6.3*)/1	-/-	-	-
solid	stranded	Ferrule with/without plastic sleeve	
0.14 - 6	0.14 - 6	0.14 - 4	0.14 - 4
0.14 - 1.5	0.14 - 1.5	0.14 - 1.5	-
			0.5 - 1.5
9			
M3			
0.6 - 0.8			
PA			
V0			

Technical data			
Width	Length	Height NS 35/7,5	
6.2	92.7	88.9	
$I_{max}$ [A]	$U_{max}$ [V]	max. $\varnothing$ [mm <sup>2</sup> ]	AWG
36*)	500*)	0.14 - 6	26 - 10
IEC 60947-7-2/IEC 60947-7-3			
IEC	UL/CUL	CSA	IEC/EN 60079-7
500*)	-	-	-
30/4	-	-	-
4	-	-	-
26 - 10	-	-	-
IEC	UL/CUL	CSA	IEC/EN 60079-7
6.3*)/1	-/-	-	-
solid	stranded	Ferrule with/without plastic sleeve	
0.14 - 6	0.14 - 6	0.14 - 4	0.14 - 4
0.14 - 1.5	0.14 - 1.5	0.14 - 1.5	-
			0.5 - 1.5
9			
M3			
0.6 - 0.8			
PA			
V0			

Technical data			
Width	Length	Height NS 35/7,5	
6.2	92.7	88.9	
$I_{max}$ [A]	$U_{max}$ [V]	max. $\varnothing$ [mm <sup>2</sup> ]	AWG
36*)	500*)	0.14 - 6	26 - 10
IEC 60947-7-1/IEC 60947-7-2			
IEC	UL/CUL	CSA	IEC/EN 60079-7
500*)	-	-	-
30/4	-	-	-
4	-	-	-
26 - 10	-	-	-
IEC	UL/CUL	CSA	IEC/EN 60079-7
20/1	-/-	-	-
solid	stranded	Ferrule with/without plastic sleeve	
0.14 - 6	0.14 - 6	0.14 - 4	0.14 - 4
0.14 - 1.5	0.14 - 1.5	0.14 - 1.5	-
			0.5 - 1.5
9			
M3			
0.6 - 0.8			
PA			
V0			

Ordering data			
Type	$I_{max}$	Order No.	Pcs. / Pkt.
UT 4-PE/L/HESI (5X20)		3214320	50

Ordering data			
Type	$I_{max}$	Order No.	Pcs. / Pkt.
UT 4-PE/L/HESILED 24 (5X20)		3214321	50
UT 4-PE/L/HESILED 60 (5X20)		3214322	50
UT 4-PE/L/HESILED 250 (5X20)		3214323	50

Ordering data			
Type	$I_{max}$	Order No.	Pcs. / Pkt.
UT 4-PE/L/HEDI		3214324	50

Accessories			
DMET 5X20		3032075	50
FBS 2-6	28 A	3030336	50
FBS 3-6	28 A	3030242	50
FBS 4-6	28 A	3030255	50
FBS 5-6	28 A	3030349	50
FBS 10-6	28 A	3030271	10
FBS 20-6	28 A	3030365	10
SZS 0,6X3,5		1205053	10

Accessories			
DMET 5X20		3032075	50
FBS 2-6	28 A	3030336	50
FBS 3-6	28 A	3030242	50
FBS 4-6	28 A	3030255	50
FBS 5-6	28 A	3030349	50
FBS 10-6	28 A	3030271	10
FBS 20-6	28 A	3030365	10
SZS 0,6X3,5		1205053	10

Accessories			
FBS 2-6	28 A	3030336	50
FBS 3-6	28 A	3030242	50
FBS 4-6	28 A	3030255	50
FBS 5-6	28 A	3030349	50
FBS 10-6	28 A	3030271	10
FBS 20-6	28 A	3030365	10
SZS 0,6X3,5		1205053	10

UC-TM 5, UCT-TM 5 or ZB 5 (see Catalog 5)  
UC-TM 6, UCT-TM 6 or ZB 6 (see Catalog 5)

UC-TM 5, UCT-TM 5 or ZB 5 (see Catalog 5)  
UC-TM 6, UCT-TM 6 or ZB 6 (see Catalog 5)

UC-TM 5, UCT-TM 5 or ZB 5 (see Catalog 5)  
UC-TM 6, UCT-TM 6 or ZB 6 (see Catalog 5)

# Modular terminal blocks

## Modular terminal blocks - CLIPLINE complete

### Screw connection test disconnect terminal block with UK 4-SD test isolating plug

This disconnect terminal block offers numerous advantages especially for testing in measuring and signal circuits:

- Simultaneous interruption of individual or multiple neighboring disconnect terminal blocks by using the PS 6-DI-SD isolating plug
- Safe, uninterruptible looping in of measuring devices in the circuit with the aid of the PS 6-CT-SD test isolating plug
- Safe contacting of the potentials after opening the disconnect point through use of the PS 6-VT-SD test isolating plug
- Terminal points in the test isolating plugs allow individual test applications to be wired.
- Easy potential distribution in the terminal strip with insertion bridges

CLIP PROJECT Planning enables the quick and convenient planning and configuration of fault-free terminal strips.

### Circuit examples

- Normal operation: no plug inserted
- Measurement checking: looping in a measuring device with the PS 6-CT-SD test isolating plug
- Current transformer short circuit: measurement split between two positions

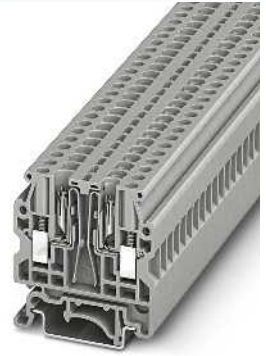

4 (6) mm<sup>2</sup>, test disconnect terminal block

Dimensions	
	[mm]
Dimensions	
	[mm]
Max. electrical data	
Rated data	
Rated voltage	[V]
Nominal current / cross section	[A] / [mm <sup>2</sup> ]
Rated cross section	[mm <sup>2</sup> ]
Cross section range	AWG
Connection capacity	
1 conductor	[mm <sup>2</sup> ]
Two conductors (of the same type)	[mm <sup>2</sup> ]
Two stranded conductors with a TWIN ferrule	[mm <sup>2</sup> ]
General data	
Stripping length	[mm]
Screw thread	
Tightening torque	[Nm]
Insulating material	
Inflammability class according to UL 94	

Technical data			
Width	Length	Height NS 35/7,5	
6.2	45.5	47.3	
Width	Length	Height NS 32	
6.2	45.5	52.2	
I <sub>max</sub> [A]	U <sub>max</sub> [V]	max. Ø [mm <sup>2</sup> ]	AWG
10	500	0.2 - 6	20 - 10
IEC 60947-7-1			
IEC	UL/CUL	CSA	IEC/EN 60079-7
500	-	-	-
10/4	-	-	-
4	-	-	-
20 - 10	-	-	-
Connection capacity		Ferrule	
		with/without plastic sleeve	
solid	stranded		
1 conductor	Two conductors (of the same type)	0.5 - 4	0.5 - 4
0.5 - 6	0.2 - 4	0.5 - 4	0.5 - 4
Two conductors (of the same type)	0.5 - 1.5	0.5 - 1.5	-
Two stranded conductors with a TWIN ferrule	0.5 - 1.5	0.5 - 1.5	0.5 - 1.5
General data			
Stripping length	Screw thread	Tightening torque	Insulating material
9	M3	0.5 - 0.6	PA
			V0

Description	No. of pos.	Color
Test disconnect terminal block, for mounting on NS 35		gray
Isolating plug		gray
Test isolating plug		green
Test isolating plug		red

Cover, width 2.2 mm		gray
Insertion bridge, insulated		
	2	gray
	3	gray
	10	gray
Partition plate, 1.5 mm wide		gray
Screwdriver		

Lateral groove labeling	
-------------------------	--

Ordering data			
Type	I <sub>max</sub>	Order No.	Pcs. / Pkt.
UK 4-SD		3246861	50

Accessories			
D-UK 4-SD		3246862	50
EB 2-6	11 A	0201155	100
EB 3-6	11 A	0201142	100
EB 10-6	11 A	0201139	10
ATP-UK		3003224	50
SF-SL 0,6X3,5-100 S-VDE		1212587	10

UC-TM 6, UCT-TM 6 or ZB 6 (see Catalog 5)
---

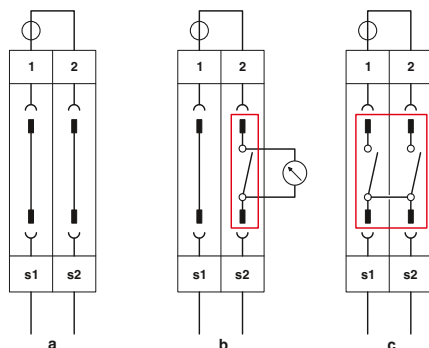



Isolating plug, disconnect function only



1.5 (2.5) mm<sup>2</sup> test isolating plug, contacts before the signal isolation

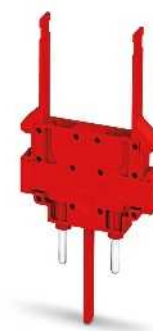

1.5 (2.5) mm<sup>2</sup> test isolating plug, contacts after the signal isolation

Technical data			
Width	Length	Height NS 35/7,5	
6.2	39.3	-	
Width	Length	Height NS 32	
6.2	39.3	-	
		max. Ø [mm <sup>2</sup> ]	AWG
		-	-
IEC	UL/CUL	CSA	IEC/EN 60079-7
-	-	-	-
-	-	-	-
-	-	-	-
-	-	-	-
solid	stranded	Ferrule with/without plastic sleeve	
-	-	-	-
-	-	-	-
PA	V0		

Technical data			
Width	Length	Height NS 35/7,5	
6.2	39.3	-	
Width	Length	Height NS 32	
6.2	39.3	-	
		max. Ø [mm <sup>2</sup> ]	AWG
I <sub>max.</sub> [A]	U <sub>max.</sub> [V]	0.5 - 2.5	20 - 14
8	250		
IEC 60947-7-1	IEC 60079-7		
IEC	UL/CUL	CSA	IEC/EN 60079-7
250	-	-	-
6	-	-	-
2.5	-	-	-
20 - 14	-	-	-
solid	stranded	Ferrule with/without plastic sleeve	
0.5 - 2.5	0.5 - 2.5	0.5 - 1.5	0.5 - 1.5
-	-	-	-
7	M3		
0.3 - 0.5	PA		
V0	V0		

Technical data			
Width	Length	Height NS 35/7,5	
6.2	39.3	-	
Width	Length	Height NS 32	
6.2	39.3	-	
		max. Ø [mm <sup>2</sup> ]	AWG
I <sub>max.</sub> [A]	U <sub>max.</sub> [V]	0.5 - 2.5	20 - 14
8	250		
IEC 60947-7-1	IEC 60079-7		
IEC	UL/CUL	CSA	IEC/EN 60079-7
250	-	-	-
6	-	-	-
2.5	-	-	-
20 - 14	-	-	-
solid	stranded	Ferrule with/without plastic sleeve	
0.5 - 2.5	0.5 - 2.5	0.5 - 1.5	0.5 - 1.5
-	-	-	-
7	M3		
0.3 - 0.5	PA		
V0	V0		

Ordering data		
Type	Order No.	Pcs. / Pkt.
PS 6-DI-SD	3246856	50

Ordering data		
Type	Order No.	Pcs. / Pkt.
PS 6-CT-SD	3246857	50

Ordering data		
Type	Order No.	Pcs. / Pkt.
PS 6-VT-SD	3246858	50

Accessories		

Accessories		
SZF 1-0,6X3,5	1204517	10

Accessories		
SZF 1-0,6X3,5	1204517	10

UC-TM 6, UCT-TM 6 or ZB 6 (see Catalog 5)

UC-TM 6, UCT-TM 6 or ZB 6 (see Catalog 5)

UC-TM 6, UCT-TM 6 or ZB 6 (see Catalog 5)

# Modular terminal blocks

## Modular terminal blocks - CLIPLINE complete

### Fast connection

#### QTCU 2,5-TWIN-MT hybrid knife disconnect terminal block

The advantages of the different

connection methods are as follows:

- The TWIN fast connection is used inside the control cabinet and the universal screw connection is used on the end customer side
- Compact design and high current carrying capacity of 20 A
- Testing facility on both sides of the disconnect point

### S-MT switching lock

- The optional switching lock snaps in and effectively prevents accidental switching

A test plug with a 2.3 mm diameter is available for measuring lines. All measurement and test work can be completed at speed using test adapters for 4 mm diameter test plugs and the modular test plugs.

Notes:
1) The max. load current must not be exceeded by the total current of all connected conductors.
2) see Catalog 3.

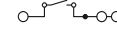

2.5 (2.5) mm<sup>2</sup>, 20 A, knife disconnect terminal block, three connections

Dimensions		[mm]	
<b>Max. electrical data</b>			
Rated voltage	[V]	400	-
Nominal current / cross section	[A] / [mm <sup>2</sup> ]	20/2.5	-
Rated cross section	[mm <sup>2</sup> ]	2.5	-
Cross section range	AWG	20 - 14	-
<b>Connection cross section in acc. with DIN VDE 0295</b>			
H05V(Z) / H07V(Z)	[mm <sup>2</sup> ]	0.5 - 2.5	-
[Litz wires Ø ≥ 0.19 mm]	AWG	20 - 14	-
Frequency of connections with the same cross section		100	-
<b>Rated data, screw connection</b>			
Rated voltage	[V]	400	-
Nominal current / cross section	[A] / [mm <sup>2</sup> ]	20/2.5	-
Rated cross section	[mm <sup>2</sup> ]	2.5	-
Cross section range	AWG	26 - 10	-
<b>Connection capacity screw connection</b>			
1 conductor	[mm <sup>2</sup> ]	0.14 - 6	0.14 - 4
Two conductors (of the same type)	[mm <sup>2</sup> ]	0.14 - 1.5	0.14 - 1.5
Two conductors with a TWIN ferrule	[mm <sup>2</sup> ]		0.5 - 2.5
<b>General data</b>			
Stripping length	[mm]	9	
Screw thread		M3	
Tightening torque	[Nm]	0.6 - 0.8	
Insulating material		PA	
Inflammability class according to UL 94		V0	

Technical data				
Width	Length	Height NS 35/7.5		
6.2	79.3	42.8		
I <sub>max</sub> [A]	U <sub>max</sub> [V]	max. Ø [mm <sup>2</sup> ]	AWG	
20 <sup>1)</sup>	400	0.14 - 6	26 - 10	
IEC 60947-7-1				
IEC	UL/CUL	CSA	IEC/EN 60079-7	
IEC 60947-7-1				
IEC	UL/CUL	CSA	IEC/EN 60079-7	
<b>Connection capacity screw connection</b>				
	solid	stranded	Ferrule with/without plastic sleeve	
1 conductor	0.14 - 6	0.14 - 4	0.14 - 4	0.14 - 4
Two conductors (of the same type)	0.14 - 1.5	0.14 - 1.5	0.14 - 1.5	-
Two conductors with a TWIN ferrule				0.5 - 2.5
<b>General data</b>				
Stripping length	[mm]	9		
Screw thread		M3		
Tightening torque	[Nm]	0.6 - 0.8		
Insulating material		PA		
Inflammability class according to UL 94		V0		

Description	No. of pos.	Color
<b>Terminal block</b> , for mounting on NS 35...		gray
		blue

Ordering data			
Type	I <sub>max</sub>	Order No.	Pcs. / Pkt.
QTCU 2,5-TWIN-MT		3050304	50
QTCU 2,5-TWIN-MT BU		3050317	50

<b>Cover</b> , width 2.2 mm		gray
<b>Jumper</b>		
	2	red
	3	red
	4	red
	5	red
	10	red
	20	red
<b>Partition plate</b> , 2 mm width		gray
<b>Switching lock</b> , plug-in <sup>2)</sup>		white
<b>Test adapter</b> , 4-mm test socket hole		gray
<b>Test plug metal part</b> , 2.3 mm Ø		silver
<b>Insulating sleeve</b> , for MPS metal part		red
<b>Modular test plug</b> , for the individual assembly of test pin strips		red
<b>Screwdriver</b>		
<b>Lateral groove labeling</b>		

Accessories			
D-QTCU 2,5-TWIN-MT		Order No.	Pcs. / Pkt.
D-QTCU 2,5-TWIN-MT		3050511	50
FBS 2-6	20 A	3030336	50
FBS 3-6	20 A	3030242	50
FBS 4-6	20 A	3030255	50
FBS 5-6	20 A	3030349	50
FBS 10-6	20 A	3030271	10
FBS 20-6	20 A	3030365	10
ATP-QTC TWIN		3206212	50
S-MT		3247954	50
PAI-4-N GY		3032871	10
MPS-MT		0201744	10
MPS-IH RD		0201676	10
PS-6		3030996	10
SZF 1-0,6X3,5		1204517	10
UC-TMF 6, UCT-TMF 6 or ZBF 6 (see Catalog 5)			

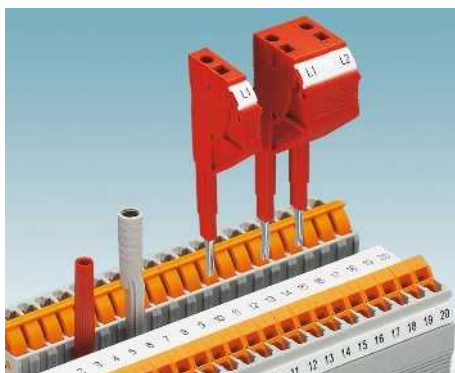

**QTC 2,5-QUATTRO... fast connection feed-through and ground terminal blocks**

- The fastest conductor connection for signal and low-spectrum power wiring
- Large packing density with a maximum conductor cross section of 2.5 mm<sup>2</sup>
- Compact design

**Notes:**  
 1) The max. load current must not be exceeded by the total current of all connected conductors.

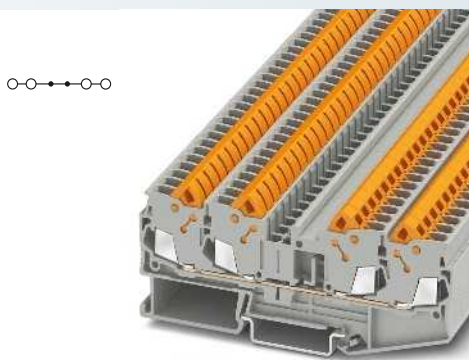

2.5 (2.5) mm<sup>2</sup>, 24 A, feed-through terminal block, four connections

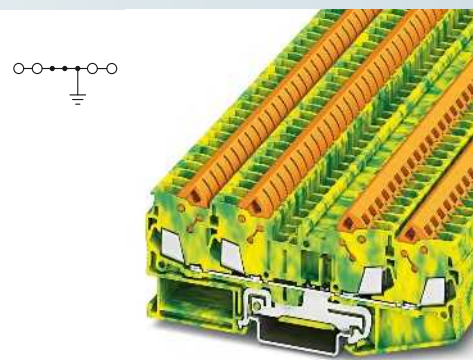

2.5 (2.5) mm<sup>2</sup>, ground terminal block, four connections

Technical data				
Width	Length	Height NS 35/7,5		
6.2	102.4	39.3		
I <sub>max</sub> [A]	U <sub>max</sub> [V]	max. Ø [mm <sup>2</sup> ]	AWG	
24 <sup>1)</sup>	800	0.5 - 2.5	20 - 14	
IEC 60947-7-1				
IEC	UL/CUL	CSA	IEC/EN 60079-7	
Rated voltage	[V]	800	-	-
Nominal current / cross section	[A] / [mm <sup>2</sup> ]	24/2.5	-	-
Rated cross section	[mm <sup>2</sup> ]	2.5	-	-
Cross section range	AWG	20 - 14	-	-
Connection cross section in acc. with DIN VDE 0295				
H05V(Z) / H07V(Z)	[mm <sup>2</sup> ]	0.5 - 2.5	-	-
[Litz wires Ø ≥ 0.19 mm]	AWG	20 - 14	-	-
Frequency of connections with the same cross section		100	-	-
General data				
Insulating material	PA			
Inflammability class according to UL 94	V0			

Technical data				
Width	Length	Height NS 35/7,5		
6.2	102.4	39.3		
I <sub>max</sub> [A]	U <sub>max</sub> [V]	max. Ø [mm <sup>2</sup> ]	AWG	
24 <sup>1)</sup>	800	0.5 - 2.5	20 - 14	
IEC 60947-7-2				
IEC	UL/CUL	CSA	IEC/EN 60079-7	
Rated voltage	[V]	-	-	-
Nominal current / cross section	[A] / [mm <sup>2</sup> ]	-	-	-
Rated cross section	[mm <sup>2</sup> ]	2.5	-	-
Cross section range	AWG	20 - 14	-	-
Connection cross section in acc. with DIN VDE 0295				
H05V(Z) / H07V(Z)	[mm <sup>2</sup> ]	0.5 - 2.5	-	-
[Litz wires Ø ≥ 0.19 mm]	AWG	20 - 14	-	-
Frequency of connections with the same cross section		100	-	-
General data				
Insulating material	PA			
Inflammability class according to UL 94	V0			

Ordering data			
Type	I <sub>max</sub>	Order No.	Pcs. / Pkt.
QTC 2,5-QUATTRO		3206446	50
QTC 2,5-QUATTRO BU		3206447	50

Ordering data			
Type	Order No.	Pcs. / Pkt.	
QTC 2,5-QUATTRO-PE	3206448	50	

Accessories				
D-QTC 2,5-QUATTRO		3206449	50	
DS-QTC 2,5		3206607	50	
FBS 2-6	24 A	3030336	50	
FBS 3-6	24 A	3030242	50	
FBS 4-6	24 A	3030255	50	
FBS 5-6	24 A	3030349	50	
FBS 10-6	24 A	3030271	10	
FBS 20-6	24 A	3030365	10	
ATP-QTC QUATTRO		3206225	50	
PAI-4-N GY		3032871	10	
MPS-MT		0201744	10	
MPS-IH RD		0201676	10	
PS-6		3030996	10	
STP 5-2-ZB		3037643	100	
SZF 1-0,6X3,5		1204517	10	

Accessories				
D-QTC 2,5-QUATTRO		3206449	50	
DS-QTC 2,5		3206607	50	
FBS 2-6		3030336	50	
FBS 3-6		3030242	50	
FBS 4-6		3030255	50	
FBS 5-6		3030349	50	
FBS 10-6		3030271	10	
FBS 20-6		3030365	10	
ATP-QTC QUATTRO		3206225	50	
PAI-4-N GY		3032871	10	
MPS-MT		0201744	10	
MPS-IH RD		0201676	10	
PS-6		3030996	10	
STP 5-2-ZB		3037643	100	
SZF 1-0,6X3,5		1204517	10	

Center groove labeling	UC-TM 6, UCT-TM 6 or ZB 6 (see Catalog 5)
Center and side groove labeling	UC-TMF 6, UCT-TMF 6 or ZBF 6 (see Catalog 5)

Center groove labeling	UC-TM 6, UCT-TM 6 or ZB 6 (see Catalog 5)
Center and side groove labeling	UC-TMF 6, UCT-TMF 6 or ZBF 6 (see Catalog 5)



Valve connector with energy-reducing function

Page 177



Valve connector for outdoor applications

Page 180



Valve connector superseal connector

Page 181



Valve connector Deutsch connector

Page 182



M12 power cable

Page 184



M12 connector with crimp connection

Page 185



M12 Y-distributor for power connectors

Page 186



M12 assembled cables, for outdoor applications

Page 187



H and T-distributors, 6.0 mm<sup>2</sup>  
Cable connectors, 6.0 mm<sup>2</sup>

Page 188



Panel feed-throughs, 2.5 mm<sup>2</sup> and 6.0 mm<sup>2</sup>  
Assembled cables, 2.5 mm<sup>2</sup>

Page 191



HEAVYCON EVO housing  
Type D15 and D25

Page 196



HEAVYCON contact inserts  
Type B, BB series and HS series

Page 198





HEAVYCON EVO housing  
Type B, for EMC applications

Page 202



HEAVYCON HPR housing  
Type B, for railway applications

Page 214



CES cable entry system  
Sealing frames with cone-shaped  
cable sleeves

Page 222



Plastic, brass, EMC, and  
Ex cable glands

Page 224

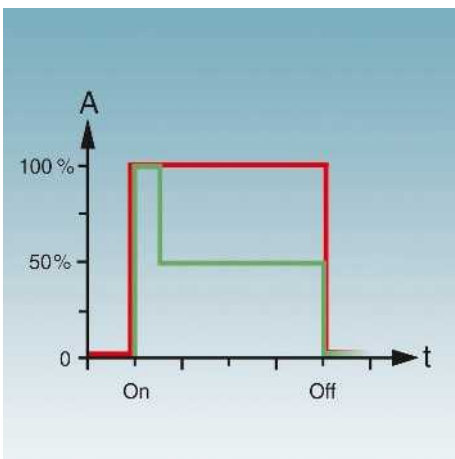
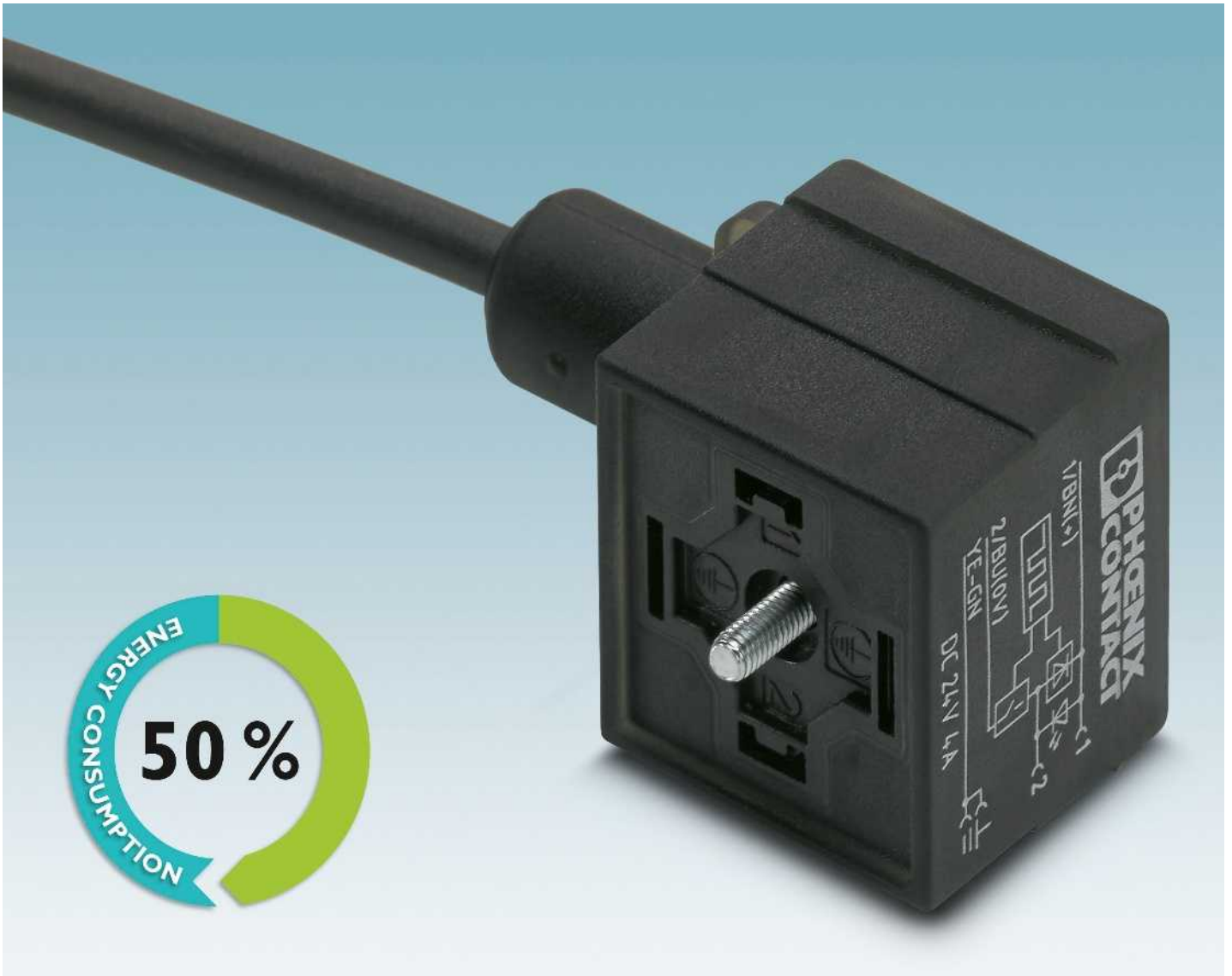

### Save energy

The new valve connectors with energy-reducing function are characterized by up to 50% reduced current consumption compared to conventional versions.

### Save costs

After controlling the valve, the holding current is reduced to 50% by the energy-reducing function. This means that power supply units with smaller dimensions can be used.

### Compatible with the standard

The functionality and compatibility of valve connectors corresponds to the familiar standard. Integration in existing systems can be easily accomplished.

**Valve connector with energy-reducing function**

- Energy-reducing function by means of holding current limiting device



Valve connector with freewheeling diode, type A, 3-pos.



Valve connector with freewheeling diode, type B, 3-pos.

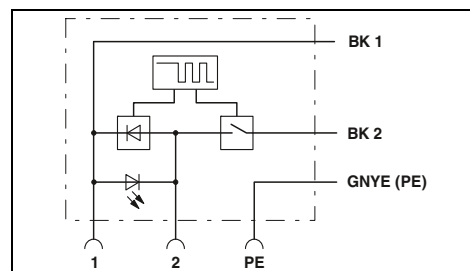
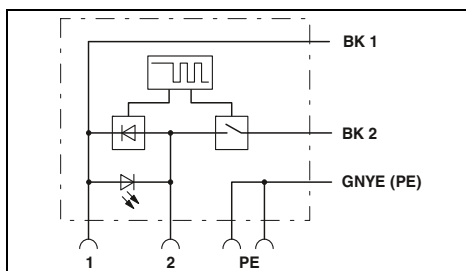

**Technical data**

**Technical data**

General data	
Valve connector according to:	EN 175301-803
Degree of protection	IP67
Electrical data	
Rated voltage	24 V DC
Rated current	4 A
Contact resistance	≤ 5 mΩ
Material data	
Material contact valve connector	CuSn
Material contact surface valve connector	Ag
Material housing valve connector	TPU
Mechanical data	
No. of pos.	3
Temperature data	
Valve connectors	[-25 ... 80 °C]

General data	
Valve connector according to:	EN 175301-803
Degree of protection	IP67
Electrical data	
Rated voltage	24 V DC
Rated current	1 A
Contact resistance	≤ 5 mΩ
Material data	
Material contact valve connector	CuSn
Material contact surface valve connector	Ag
Material housing valve connector	TPU
Mechanical data	
No. of pos.	3
Temperature data	
Valve connectors	[-25 ... 80 °C]

**Ordering data**

**Ordering data**

Description	Cable length
<b>Assembled cable, with valve connector, and free conductor end</b>	1.5 m
	3 m
	5 m
	10 m

Type	Order No.	Pcs. / Pkt.
SAC-3P- 1,5-PUR/A-1L-R-ES 4A	1400827	1
SAC-3P- 3,0-PUR/A-1L-R-ES 4A	1401131	1
SAC-3P- 5,0-PUR/A-1L-R-ES 4A	1401136	1
SAC-3P-10,0-PUR/A-1L-R-ES 4A	1401168	1

Type	Order No.	Pcs. / Pkt.
SAC-3P- 1,5-PUR/B-1L-R-ES	1401294	1
SAC-3P- 3,0-PUR/B-1L-R-ES	1401295	1
SAC-3P- 5,0-PUR/B-1L-R-ES	1401338	1
SAC-3P-10,0-PUR/B-1L-R-ES	1401339	1

## Sensor/actuator cabling - assembled cables

### Valve connector with energy-reducing function

– Energy-reducing function by means of holding current limiting device



Valve connector with freewheeling diode, type BI, 3-pos.



Valve connector with freewheeling diode, type C, 3-pos.

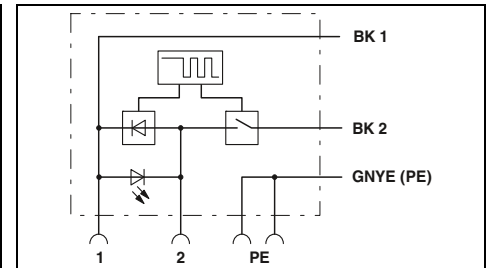
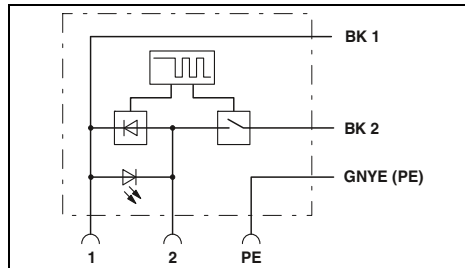

		Technical data			Technical data		
General data							
Valve connector according to:		-			EN 175301-803		
Degree of protection		IP67			IP67		
Electrical data							
Rated voltage		24 V DC			24 V DC		
Rated current		1 A			1 A		
Contact resistance		≤ 5 mΩ			≤ 5 mΩ		
Material data							
Material contact valve connector		CuSn			CuSn		
Material contact surface valve connector		Ag			Ag		
Material housing valve connector		TPU			TPU		
Mechanical data							
No. of pos.		3			3		
Temperature data							
Valve connectors		[-25 ... 80] °C			[-25 ... 80] °C		
		Ordering data			Ordering data		
Description	Cable length	Type	Order No.	Pcs. / Pkt.	Type	Order No.	Pcs. / Pkt.
<b>Assembled cable, with valve connector, and free conductor end</b>	1.5 m	SAC-3P- 1,5-PUR/BI-1L-R-ES	1401340	1	SAC-3P- 1,5-PUR/C-1L-R-ES	1401434	1
	3 m	SAC-3P- 3,0-PUR/BI-1L-R-ES	1401350	1	SAC-3P- 3,0-PUR/C-1L-R-ES	1401435	1
	5 m	SAC-3P- 5,0-PUR/BI-1L-R-ES	1401358	1	SAC-3P- 5,0-PUR/C-1L-R-ES	1401448	1
	10 m	SAC-3P-10,0-PUR/BI-1L-R-ES	1401359	1	SAC-3P-10,0-PUR/C-1L-R-ES	1401465	1



Valve connector with freewheeling diode,  
type CI, 3-pos.

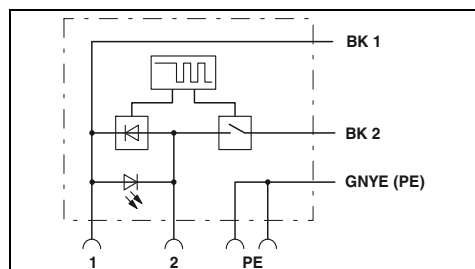

**Technical data**

-  
IP67  
24 V DC  
1 A  
≤ 5 mΩ

CuSn  
Ag  
TPU

3

-25 ... 80

**Ordering data**

Type	Order No.	Pcs. / Pkt.
SAC-3P- 1,5-PUR/CI-1L-R-ES	1401466	1
SAC-3P- 3,0-PUR/CI-1L-R-ES	1401542	1
SAC-3P- 5,0-PUR/CI-1L-R-ES	1401544	1
SAC-3P-10,0-PUR/CI-1L-R-ES	1401617	1

# Sensor/actuator cabling and industrial connectors

## Sensor/actuator cabling - assembled cables

### Valve connector for outdoor applications

- Stainless steel central screw
- Additional silicone seal ensures IP66K protection



Valve connector with Zener diode, type A, 3-pos.



Valve connector with 2 LEDs, type AD pressure switch, 5-pos.

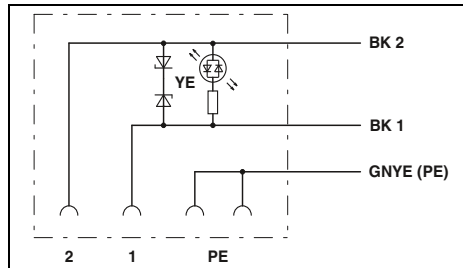

#### Technical data

General data	
Valve connector according to:	EN 175301-803
Degree of protection	IP65/IP66K/IP67/IP68
Electrical data	
Rated voltage	24 V
Rated current	4 A
Contact resistance	≤ 5 mΩ
Material data	
Material contact valve connector	CuSn
Material contact surface valve connector	Sn
Material housing valve connector	TPU
Mechanical data	
No. of pos.	3
Temperature data	
Valve connectors	[°C] -40 ... 85

General data	
Valve connector according to:	EN 175301-803
Degree of protection	IP65/IP66K/IP67/IP68
Electrical data	
Rated voltage	24 V
Rated current	4 A
Contact resistance	≤ 5 mΩ
Material data	
Material contact valve connector	CuSn
Material contact surface valve connector	Sn
Material housing valve connector	TPU
Mechanical data	
No. of pos.	5
Temperature data	
Valve connectors	[°C] -40 ... 85

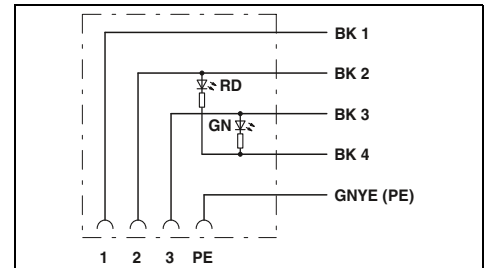

#### Technical data

General data	
Valve connector according to:	EN 175301-803
Degree of protection	IP65/IP66K/IP67/IP68
Electrical data	
Rated voltage	24 V
Rated current	4 A
Contact resistance	≤ 5 mΩ
Material data	
Material contact valve connector	CuSn
Material contact surface valve connector	Sn
Material housing valve connector	TPU
Mechanical data	
No. of pos.	5
Temperature data	
Valve connectors	[°C] -40 ... 85

#### Ordering data

Description	Cable length
<b>Assembled cable, with valve connector, and free conductor end</b>	1.5 m
	3 m
	5 m
	10 m

Type	Order No.	Pcs. / Pkt.
SAC-3P- 1,5-PUO/A-1L-Z OD	1407287	1
SAC-3P- 3,0-PUO/A-1L-Z OD	1407288	1
SAC-3P- 5,0-PUO/A-1L-Z OD	1407289	1
SAC-3P-10,0-PUO/A-1L-Z OD	1407290	1

#### Ordering data

Type	Order No.	Pcs. / Pkt.
SAC-5P- 1,5-PUO/AD-2L OD	1407291	1
SAC-5P- 3,0-PUO/AD-2L OD	1407292	1
SAC-5P- 5,0-PUO/AD-2L OD	1407293	1
SAC-5P-10,0-PUO/AD-2L OD	1407294	1

**Valve connector,  
superseal connector**

– For mobile hydraulic applications



Superseal,  
2-pos.



Superseal,  
2-pos.

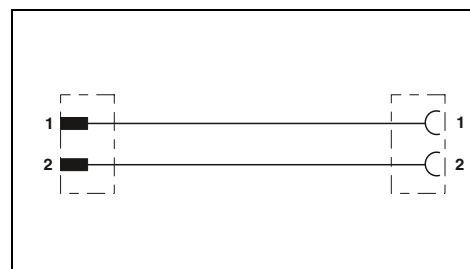
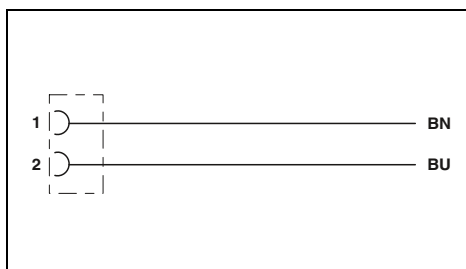

	Technical data	Technical data
General data		
Degree of protection	IP67	IP67
Electrical data		
Rated voltage	24 V	24 V
Rated current	8 A	8 A
Contact resistance	≤ 5 mΩ	≤ 5 mΩ
Material data		
Contact material	PhCuSn	CuZn (pin)/PhCuSn (socket)
Material of grip body	PA	PA
Mechanical data		
No. of pos.	2	2
Temperature data		
Plug/socket	-20 ... 85 [°C]	-20 ... 85

		Ordering data			Ordering data		
Description	Cable length	Type	Order No.	Pcs. / Pkt.	Type	Order No.	Pcs. / Pkt.
<b>Assembled cable, with straight socket and free cable end</b>	1.5 m	SAC-2P- 1,5-PUR/SUSFS	1410748	1			
	3 m	SAC-2P- 3,0-PUR/SUSFS	1410749	1			
	5 m	SAC-2P- 5,0-PUR/SUSFS	1410750	1			
	10 m	SAC-2P-10,0-PUR/SUSFS	1410751	1			
<b>Assembled cable, with straight plug and free cable end</b>	1.5 m	SAC-2P-SUSMS/ 1,5-PUR	1410752	1			
	3 m	SAC-2P-SUSMS/ 3,0-PUR	1410753	1			
	5 m	SAC-2P-SUSMS/ 5,0-PUR	1410755	1			
	10 m	SAC-2P-SUSMS/10,0-PUR	1410756	1			
<b>Assembled cable, with straight plug and straight socket</b>	0.3 m				SAC-2P-SUSMS/ 0,3-PUR/SUSFS	1410757	1
	0.6 m				SAC-2P-SUSMS/ 0,6-PUR/SUSFS	1410759	1
	1.5 m				SAC-2P-SUSMS/ 1,5-PUR/SUSFS	1410760	1
	3 m				SAC-2P-SUSMS/ 3,0-PUR/SUSFS	1410761	1

# Sensor/actuator cabling and industrial connectors

## Sensor/actuator cabling - assembled cables

### Valve connector, Deutsch DT06-2S connector

– For mobile hydraulic applications



Valve connector, Deutsch DT06-2S,  
2-pos.



Valve connector, Deutsch DT06-2S,  
with 1 LED, 2-pos.

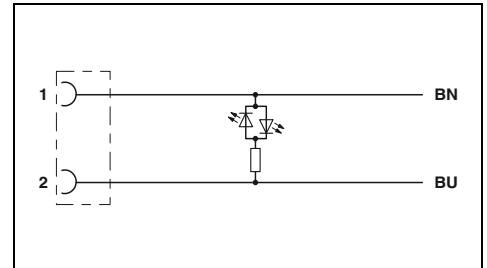
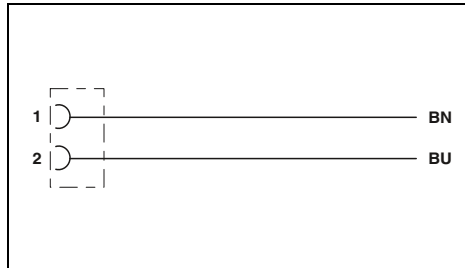

#### Technical data

General data	
Degree of protection	IP67
Electrical data	
Rated voltage	48 V
Rated current	8 A
Contact resistance	≤ 8 mΩ
Material data	
Contact material	Cu alloy
Contact surface material	Nickel-plated
Material of grip body	PA
Mechanical data	
No. of pos.	2
Temperature data	
Plug/socket	[°C] -20 ... 85

General data	
Degree of protection	IP67
Electrical data	
Rated voltage	24 V
Rated current	8 A
Contact resistance	≤ 8 mΩ
Material data	
Contact material	Cu alloy
Contact surface material	Nickel-plated
Material of grip body	PA
Mechanical data	
No. of pos.	2
Temperature data	
Plug/socket	[°C] -20 ... 85

#### Technical data

General data	
Degree of protection	IP67
Electrical data	
Rated voltage	24 V
Rated current	8 A
Contact resistance	≤ 8 mΩ
Material data	
Contact material	Cu alloy
Contact surface material	Nickel-plated
Material of grip body	PA
Mechanical data	
No. of pos.	2
Temperature data	
Plug/socket	[°C] -20 ... 85

#### Ordering data

Description	Cable length
<b>Assembled cable, with straight socket and free cable end</b>	1.5 m
	3 m
	5 m
	10 m

Type	Order No.	Pcs. / Pkt.
SAC-2P- 1,5-PUR/DTFS	1410723	1
SAC-2P- 3,0-PUR/DTFS	1410724	1
SAC-2P- 5,0-PUR/DTFS	1410726	1
SAC-2P-10,0-PUR/DTFS	1410727	1

#### Ordering data

Type	Order No.	Pcs. / Pkt.
SAC-2P- 1,5-PUR/DTFS-1L	1410728	1
SAC-2P- 3,0-PUR/DTFS-1L	1410729	1
SAC-2P- 5,0-PUR/DTFS-1L	1410730	1
SAC-2P-10,0-PUR/DTFS-1L	1410731	1





Valve connector, Deutsch DT06-2S, with suppressor diode, 2-pos.

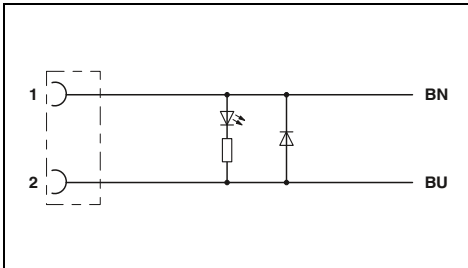

Technical data

IP67

24 V

3 A

≤ 8 mΩ

Cu alloy

Nickel-plated

PA

2

-20 ... 85

Ordering data

Type	Order No.	Pcs. / Pkt.
SAC-2P- 1,5-PUR/DTFS-1L-S	1410732	1
SAC-2P- 3,0-PUR/DTFS-1L-S	1410733	1
SAC-2P- 5,0-PUR/DTFS-1L-S	1410734	1
SAC-2P-10,0-PUR/DTFS-1L-S	1410735	1

# Sensor/actuator cabling and industrial connectors

## Sensor/actuator cabling - assembled cables

### M12-SPEEDCON power cable, 2-pos.+PE, unshielded

Free end



M12 plug, SPEEDCON



Ordering data

Ordering data

Ordering data

Free end	Order No.	Order No.	Order No.
	1 m	1411636	1 m 1411640
	2 m	1411637	2 m 1411641
	5 m	1411638	5 m 1411642
	10 m	1411639	10 m 1411643
	1 m	1411644	
	2 m	1411645	
	5 m	1411646	
	10 m	1411647	
	1 m	1411648	
	2 m	1411649	
	5 m	1411650	
	10 m	1411651	

Cable description	Cable type	Color coding	Pin assignment
PVC - black	PVC	BK1 <span style="background-color: black; color: white; padding: 2px;">1</span> BK2 <span style="background-color: black; color: white; padding: 2px;">2</span> GNYE <span style="background-color: green; padding: 2px;"> </span> <span style="background-color: yellow; padding: 2px;"> </span>	1 3 PE

#### Technical data

		M12
Rated voltage	[V]	230
Rated current	[A]	16
Contact resistance		≤ 3 mΩ
Inflammability class in acc. with UL 94		V0
Material contact M12		CuZn
Material contact surface M12		Au
Material handle M12		TPU, hardly inflammable, self-extinguishing
Material, knurls		Zinc die-cast, nickel-plated
Degree of protection		IP67
Temperature data		
Plug/socket	[°C]	-25 ... 105

**M12 connector with crimp connection**

**Notes:**  
Order crimp contacts separately

Ethernet



SERCOS  
the automation bus



M12 Plug, straight, 4-pos.

Ethernet



SERCOS  
the automation bus



M12 Plug, angled, 4-pos.

General data	
M12 circular connector according to:	IEC 61076-2-101
Pollution degree	3
Degree of protection	IP67
Connection method	Crimp connection
Cable Diameter	5 mm ... 8 mm
Electrical data	
Rated voltage	60 V
Rated current	4 A
Insulation resistance	≥ 10 GΩ
Material data	
Contact carrier material	PA
Inflammability class according to UL 94	HB
Temperature data	
Plug/socket	-25 ... 85 [°C]

Technical data		
IEC 61076-2-101		
3		
IP67		
Crimp connection		
5 mm ... 8 mm		
Electrical data		
60 V		
4 A		
≥ 10 GΩ		
Material data		
PA		
HB		
Temperature data		
-25 ... 85		

Technical data		
IEC 61076-2-101		
3		
IP67		
Crimp connection		
5 mm ... 8 mm		
Electrical data		
60 V		
4 A		
≥ 10 GΩ		
Material data		
PA		
HB		
Temperature data		
-25 ... 85		

Ordering data	
Description	Coding
<b>Bus system plug, PROFINET, 4-pos., shielded with Pg9 screw connection</b>	D - data

Ordering data		
Type	Order No.	Pcs. / Pkt.
SACC-M12MSD-4CT SH PN	1411046	1

Ordering data		
Type	Order No.	Pcs. / Pkt.
SACC-M12MRD-4CT SH PN	1411047	1

Accessories	
<b>Crimp contacts</b> , for conductor cross section: 0.34 mm <sup>2</sup> ... 0.5 mm <sup>2</sup>	
<b>Crimping pliers</b> - For turned contacts; 0.14 ... 4 mm <sup>2</sup>	

Accessories		
SACC-CC1,0-T-0,50-M AU PU100	1412351	100
CRIMPFOX-1,6/2,5-ED-4,0	1687419	1

Accessories		
SACC-CC1,0-T-0,50-M AU PU100	1412351	100
CRIMPFOX-1,6/2,5-ED-4,0	1687419	1

### M12 Y-distributor for power connectors



Y-distributor, T-coded,  
4-pos.

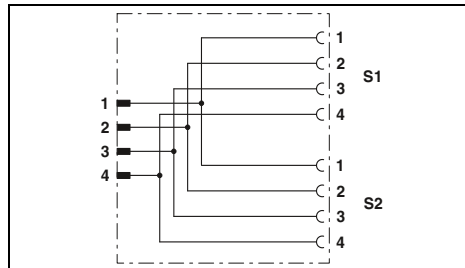

General data	
Pollution degree	3
Degree of protection	IP65/IP67
Electrical data	
Rated voltage	60 V
Rated current	12 A (at 40°C)
Material data	
Contact material	CuZn
Contact surface material	Ni/Au
Inflammability class according to UL 94	HB
Temperature data	
Plug/socket	[°C] -25 ... 80

#### Technical data

Description		Ordering data		
Description	Center distance	Type	Order No.	Pcs. / Pkt.
Y-distributor, M12-SPEEDCON, unshielded, M12 plug (T-coded) to 2 x M12 socket (T-coded)	21 mm	SAC-4PY-MT/2XFT VP	1410632	5

**M12 assembled cables for outdoor applications**

- For DeviceNet™
- For CANopen®



**Bus system cable, 5-pos.**



**Bus system cable, 5-pos.**

	Technical data		Technical data	
Electrical data				
Rated voltage	60 V		60 V	
Rated current	4 A		4 A	
Contact resistance	≤ 5 mΩ		≤ 5 mΩ	
Material data				
Contact material	CuSn		CuSn	
Contact surface material	Ni/Au		Ni/Au	
Contact carrier material	PP		PP	
Inflammability class according to UL 94	V0		V0	
Mechanical data				
No. of pos.	5		5	
Pollution degree	3		3	
Degree of protection	IP65/IP67/IP68/IP69K		IP65/IP67/IP68/IP69K	
Temperature data				
Plug/socket	[°C] -40 ... 105		-40 ... 105	
Cable, fixed installation	[°C] -40 ... 105		-40 ... 105	

		Ordering data			Ordering data		
Description	Cable length	Type	Order No.	Pcs. / Pkt.	Type	Order No.	Pcs. / Pkt.
<b>Bus system cable, 5-pos., A-coded, FRNC, halogen-free, black, shielded, straight M12 socket to free cable ends</b>	2 m	SAC-5P- 2,0-92X/M12FS SH OD	1410474	1			
	5 m	SAC-5P- 5,0-92X/M12FS SH OD	1410494	1			
	10 m	SAC-5P-10,0-92X/M12FS SH OD	1410496	1			
<b>Bus system cable, 5-pos., A-coded, FRNC, halogen-free, black, shielded, straight M12 plug to free cable ends</b>	2 m	SAC-5P-M12MS/ 2,0-92X SH OD	1410471	1			
	5 m	SAC-5P-M12MS/ 5,0-92X SH OD	1410472	1			
	10 m	SAC-5P-M12MS/10,0-92X SH OD	1410473	1			
<b>Bus system cable, 5-pos., A-coded, FRNC, halogen-free, black, shielded, straight M12 plug to straight M12 socket</b>	2 m				SAC-5P-M12MS/2,0-92X/M12FSSHOD	1410467	1
	5 m				SAC-5P-M12MS/5,0-92X/M12FSSHOD	1410470	1

## Installation system - QPD installation system

### H-distributor, 6.0 mm<sup>2</sup>

- Can be used as a H-distributor with continuous master cable
- Can be used as a star distributor
- Can be used as a Y-distributor with a test connection
- Touch-proof in accordance with DIN EN 50274



With four QUICKON nuts,  
4+PE-pos.



Without QUICKON nut,  
4+PE-pos.

	Technical data		Technical data	
	Black	Gray	Black	Gray
General data				
Degree of protection	IP68/IP69K	IP68/IP69K	IP68/IP69K	IP68/IP69K
Electrical data				
Rated voltage (III/3)	690 V	690 V	690 V	690 V
Rated surge voltage	6 kV	6 kV	6 kV	6 kV
Rated current	40 A	40 A	40 A	40 A
Surge voltage category/pollution degree	III/3	III/3	III/3	III/3
Material data				
Housing material	PA	PA	PA	PA
Contact material	Cu	Cu	Cu	Cu
Inflammability class according to UL 94	V0	V0	V0	V0
Mechanical data				
Impact category	IK07	IK07	IK07	IK07
Color	Black	Gray	Black	Gray
Connector data QUICKON connection				
Core insulation	PVC/PE/TPE/rubber	PVC/PE/TPE/rubber	PVC/PE/TPE/rubber	PVC/PE/TPE/rubber
Structure of individual litz wire/ smallest wire diameter	VDE 0295 class 1 to 6/ min. 0.15 mm	VDE 0295 class 1 to 6/ min. 0.15 mm	VDE 0295 class 1 to 6/ min. 0.15 mm	VDE 0295 class 1 to 6/ min. 0.15 mm
Connection frequency	max. 10	max. 10	max. 10	max. 10
Conductor cross section [mm <sup>2</sup> ] solid/stranded	2.5 mm <sup>2</sup> ... 6 mm <sup>2</sup> / 2.5 mm <sup>2</sup> ... 6 mm <sup>2</sup>	2.5 mm <sup>2</sup> ... 6 mm <sup>2</sup> / 2.5 mm <sup>2</sup> ... 6 mm <sup>2</sup>	2.5 mm <sup>2</sup> ... 6 mm <sup>2</sup> / 2.5 mm <sup>2</sup> ... 6 mm <sup>2</sup>	2.5 mm <sup>2</sup> ... 6 mm <sup>2</sup> / 2.5 mm <sup>2</sup> ... 6 mm <sup>2</sup>
Conductor cross section [AWG]	14 ... 10	14 ... 10	14 ... 10	14 ... 10
Temperature data				
Ambient temperature (operation)	-40°C ... 80°C	-40°C ... 80°C	-40°C ... 80°C	-40°C ... 80°C
Temperature when conductor connected	-5°C ... 50°C	-5°C ... 50°C	-5°C ... 50°C	-5°C ... 50°C
	Ordering data			
Description	Order No.	Pcs. / Pkt.	Order No.	Pcs. / Pkt.
	Black		Gray	
<b>H-distributor, with four QUICKON nuts and one sealing bolt, for cable diameters:</b>				
9 mm ... 14 mm	1411422	1	1411428	1
12 mm ... 20 mm	1411425	1	1411429	1
<b>H-distributor, without QUICKON nuts</b>				
			1411426	1
<b>QUICKON nut, for connections up to 6.0 mm<sup>2</sup>, for cable diameter:</b>				
9 mm ... 14 mm			1410409	1
12 mm ... 20 mm			1410406	1
			1411427	1
			1410407	1
			1410405	1

**T-distributor, 6.0 mm<sup>2</sup>**

- Can be used as a T-distributor with continuous master cable
- Touch-proof in accordance with DIN EN 50274



With three QUICKON nuts,  
4+PE-pos.



With two QUICKON nuts,  
4+PE-pos.

	Technical data		Technical data	
	Black	Gray	Black	Gray
General data				
Degree of protection	IP68/IP69K	IP68/IP69K	IP68/IP69K	IP68/IP69K
Electrical data				
Rated voltage (III/3)	690 V	690 V	690 V	690 V
Rated surge voltage	6 kV	6 kV	6 kV	6 kV
Rated current	40 A	40 A	40 A	40 A
Surge voltage category/pollution degree	III/3	III/3	III/3	III/3
Material data				
Housing material	PA	PA	PA	PA
Contact material	Cu	Cu	Cu	Cu
Inflammability class according to UL 94	V0	V0	V0	V0
Mechanical data				
Impact category	IK07	IK07	IK07	IK07
Color	Black	Gray	Black	Gray
Connector data QUICKON connection				
Core insulation	PVC/PE/TPE/rubber	PVC/PE/TPE/rubber	PVC/PE/TPE/rubber	PVC/PE/TPE/rubber
Structure of individual litz wire/ smallest wire diameter	VDE 0295 class 1 to 6/ min. 0.15 mm	VDE 0295 class 1 to 6/ min. 0.15 mm	VDE 0295 class 1 to 6/ min. 0.15 mm	VDE 0295 class 1 to 6/ min. 0.15 mm
Connection frequency	max. 10	max. 10	max. 10	max. 10
Conductor cross section [mm <sup>2</sup> ] solid/stranded	2.5 mm <sup>2</sup> ... 6 mm <sup>2</sup> / 2.5 mm <sup>2</sup> ... 6 mm <sup>2</sup>	2.5 mm <sup>2</sup> ... 6 mm <sup>2</sup> / 2.5 mm <sup>2</sup> ... 6 mm <sup>2</sup>	2.5 mm <sup>2</sup> ... 6 mm <sup>2</sup> / 2.5 mm <sup>2</sup> ... 6 mm <sup>2</sup>	2.5 mm <sup>2</sup> ... 6 mm <sup>2</sup> / 2.5 mm <sup>2</sup> ... 6 mm <sup>2</sup>
Conductor cross section [AWG]	14 ... 10	14 ... 10	14 ... 10	14 ... 10
Temperature data				
Ambient temperature (operation)	-40°C ... 80°C	-40°C ... 80°C	-40°C ... 80°C	-40°C ... 80°C
Temperature when conductor connected	-5°C ... 50°C	-5°C ... 50°C	-5°C ... 50°C	-5°C ... 50°C

Description	Ordering data				Ordering data			
	Order No.	Pcs. / Pkt.	Order No.	Pcs. / Pkt.	Order No.	Pcs. / Pkt.	Order No.	Pcs. / Pkt.
	Black		Gray		Black		Gray	
<b>T-distributor, with three QUICKON nuts,</b> for cable diameter: 9 mm ... 14 mm 12 mm ... 20 mm	1411414	1	1411418	1				
	1411415	1	1411419	1				
<b>T-distributor, with two QUICKON nuts,</b> for cable diameter: 9 mm ... 14 mm 12 mm ... 20 mm					1411416	1	1411420	1
					1411417	1	1411421	1
<b>QUICKON nut, for connections up to 6.0 mm<sup>2</sup>,</b> for cable diameter: 9 mm ... 14 mm 12 mm ... 20 mm					1410409	1	1410407	1
					1410406	1	1410405	1

### Cable connectors, 6.0 mm<sup>2</sup>

- The QUICKON connections at opposite ends feature different position markings and mechanical coding
- Touch-proof in accordance with DIN EN 50274



With two QUICKON nuts,  
4+PE-pos.



With one QUICKON nut,  
4+PE-pos.

	Technical data		Technical data	
	Black	Gray	Black	Gray
General data				
Degree of protection	IP68/IP69K	IP68/IP69K	IP68/IP69K	IP68/IP69K
Electrical data				
Rated voltage (III/3)	690 V	690 V	690 V	690 V
Rated surge voltage	6 kV	6 kV	6 kV	6 kV
Rated current	40 A	40 A	40 A	40 A
Surge voltage category/pollution degree	III/3	III/3	III/3	III/3
Material data				
Housing material	PA	PA	PA	PA
Contact material	Cu	Cu	Cu	Cu
Inflammability class according to UL 94	V0	V0	V0	V0
Mechanical data				
Impact category	IK07	IK07	IK07	IK07
Color	Black	Gray	Black	Gray
Connector data QUICKON connection				
Core insulation	PVC/PE/TPE/rubber	PVC/PE/TPE/rubber	PVC/PE/TPE/rubber	PVC/PE/TPE/rubber
Structure of individual litz wire/ smallest wire diameter	VDE 0295 class 1 to 6/ min. 0.15 mm	VDE 0295 class 1 to 6 / min. 0.15 mm	VDE 0295 class 1 to 6/ min. 0.15 mm	VDE 0295 class 1 to 6/ min. 0.15 mm
Connection frequency	max. 10	max. 10	max. 10	max. 10
Conductor cross section [mm <sup>2</sup> ] solid/stranded	2.5 mm <sup>2</sup> ... 6 mm <sup>2</sup> / 2.5 mm <sup>2</sup> ... 6 mm <sup>2</sup>	2.5 mm <sup>2</sup> ... 6 mm <sup>2</sup> / 2.5 mm <sup>2</sup> ... 6 mm <sup>2</sup>	2.5 mm <sup>2</sup> ... 6 mm <sup>2</sup> / 2.5 mm <sup>2</sup> ... 6 mm <sup>2</sup>	2.5 mm <sup>2</sup> ... 6 mm <sup>2</sup> / 2.5 mm <sup>2</sup> ... 6 mm <sup>2</sup>
Conductor cross section [AWG]	10 ... 14	10 ... 14	10 ... 14	10 ... 14
Temperature data				
Ambient temperature (operation)	-40°C ... 80°C	-40°C ... 80°C	-40°C ... 80°C	-40°C ... 80°C
Temperature when conductor connected	-5°C ... 50°C	-5°C ... 50°C	-5°C ... 50°C	-5°C ... 50°C
	Ordering data			
Description	Order No.	Pcs. / Pkt.	Order No.	Pcs. / Pkt.
	Black		Gray	
<b>Cable connector, with two QUICKON nuts,</b> for cable diameters: 9 mm ... 14 mm 12 mm ... 20 mm	<b>1410410</b>	1	<b>1410413</b>	1
	<b>1410412</b>	1	<b>1410414</b>	1
<b>Cable connector, with one QUICKON nut,</b> for cable diameters: 9 mm ... 14 mm 12 mm ... 20 mm				
<b>QUICKON nut, for connections up to 6.0 mm<sup>2</sup>,</b> for cable diameter: 9 mm ... 14 mm 12 mm ... 20 mm				
			<b>1410415</b>	1
			<b>1410416</b>	1
			<b>1410417</b>	1
			<b>1410418</b>	1
			<b>1410409</b>	1
			<b>1410406</b>	1
			<b>1410407</b>	1
			<b>1410405</b>	1



**Panel feed-throughs, 2.5 mm<sup>2</sup> with push-in connection**

- Devices no longer need to be opened in order to connect the cables
- User-friendly connection, even on devices that are difficult to access
- For internal push-in connection, solid conductors are simply stripped and inserted in the connection
- Touch-proof in accordance with DIN EN 50274



With one QUICKON nut, 4+PE-pos.

Technical data		
	Black	Gray
General data		
Degree of protection	IP68/IP69K	IP68/IP69K
Electrical data		
Rated voltage (III/3)	690 V	690 V
Rated surge voltage	6 kV	6 kV
Rated current	20 A	20 A
Surge voltage category/pollution degree	III/3	III/3
Material data		
Housing material	PA	PA
Contact material	Cu	Cu
Inflammability class according to UL 94	V0	V0
Mechanical data		
Impact category	IK07	IK07
Color	Black	Black
Connector data QUICKON connection		
Core insulation	PVC/PE/Rubber/TPE	PVC/PE/Rubber/TPE
Structure of individual litz wire/ smallest wire diameter	VDE 0295 class 1 to 6/ min. 0.15 mm	VDE 0295 class 1 to 6/ min. 0.15 mm
Connection frequency	max. 10	max. 10
Conductor cross section [mm <sup>2</sup> ] solid/stranded	1 mm <sup>2</sup> ... 2.5 mm <sup>2</sup> / 1 mm <sup>2</sup> ... 2.5 mm <sup>2</sup>	1 mm <sup>2</sup> ... 2.5 mm <sup>2</sup> / 1 mm <sup>2</sup> ... 2.5 mm <sup>2</sup>
Conductor cross section [AWG]	16 ... 14	16 ... 14
Temperature data		
Ambient temperature (operation)	-40°C ... 80°C	-40°C ... 80°C
Temperature when conductor connected	-5°C ... 50°C	-5°C ... 50°C

Ordering data				
Description	Order No.	Pcs. / Pkt.	Order No.	Pcs. / Pkt.
	Black		Gray	
<b>Panel feed-through</b> , with M25 x 1.5 mounting flange, with QUICKON nut, for cable diameters:				
6 mm ... 11 mm	1411432	1	1411434	1
9 mm ... 16 mm	1411433	1	1411435	1

# Sensor/actuator cabling and industrial connectors

## Installation system - QPD installation system

### Panel feed-throughs, 2.5 mm<sup>2</sup> for intrinsically safe circuits

- Devices no longer need to be opened in order to connect the cables
- User-friendly connection, even on devices that are difficult to access
- Touch-proof in accordance with DIN EN 50274

**Notes:**  
Intended for applications in intrinsically safe circuits according to EN 60079-11 and EN 60079-14.



With litz wires,  
4+PE-pos.



With manual solder/spade connection,  
4+PE-pos.

		Technical data			Technical data		
General data							
Degree of protection		IP68/IP69K			IP68/IP69K		
Electrical data							
Rated voltage		60 V			60 V		
Rated surge voltage		6 kV			6 kV		
Surge voltage category/pollution degree		III/3			III/3		
Material data							
Housing material		PA			PA		
Contact material		Cu			Cu		
Inflammability class according to UL 94		V0			V0		
Mechanical data							
Impact category		IK07			IK07		
Color		Black			Black		
Connector data QUICKON connection							
Core insulation		PVC/PE/TPE/rubber			PVC/PE/TPE/rubber		
Structure of individual litz wire/ smallest wire diameter		VDE 0295 class 1 to 6/min. 0.15 mm			VDE 0295 class 1 to 6/min. 0.15 mm		
Connection frequency		max. 10			max. 10		
Conductor cross section [mm <sup>2</sup> ] solid/stranded		1 mm <sup>2</sup> ... 2.5 mm <sup>2</sup> /1 mm <sup>2</sup> ... 2.5 mm <sup>2</sup>			1 mm <sup>2</sup> ... 2.5 mm <sup>2</sup> /1 mm <sup>2</sup> ... 2.5 mm <sup>2</sup>		
Conductor cross section [AWG]		16 ... 14			16 ... 14		
Temperature data							
Ambient temperature (operation)		-40°C ... 80°C			-40°C ... 80°C		
Temperature when conductor connected		-5°C ... 50°C			-5°C ... 50°C		
		Ordering data			Ordering data		
Description	Cable length	Type	Order No.	Pcs. / Pkt.	Type	Order No.	Pcs. / Pkt.
<b>Panel feed-through, with M20 x 1.5 mounting flange, with QUICKON nut, for cable diameter:</b>							
6 mm ... 11 mm	0.5 m	QPD W 4PE2,5 6-11 M20 0,5 EX	1411393	1			
6 mm ... 11 mm	1 m	QPD W 4PE2,5 6-11 M20 1,0 EX	1411394	1			
6 mm ... 11 mm					QPD W 4PE2,5 6-11 M20 FC EX	1411395	1
9 mm ... 16 mm	0.5 m	QPD W 4PE2,5 9-16 M20 0,5 EX	1411397	1			
9 mm ... 16 mm	1 m	QPD W 4PE2,5 9-16 M20 1,0 EX	1411398	1			
9 mm ... 16 mm					QPD W 4PE2,5 9-16 M20 FC EX	1411399	1
<b>Panel feed-through, with M25 x 1.5 mounting flange, with QUICKON nut, for cable diameters:</b>							
6 mm ... 11 mm	0.5 m	QPD W 4PE2,5 6-11 M25 0,5 EX	1411387	1			
6 mm ... 11 mm	1 m	QPD W 4PE2,5 6-11 M25 1,0 EX	1411388	1			
6 mm ... 11 mm					QPD W 4PE2,5 6-11 M25 FC EX	1411389	1
9 mm ... 16 mm	0.5 m	QPD W 4PE2,5 9-16 M25 0,5 EX	1411390	1			
9 mm ... 16 mm	1 m	QPD W 4PE2,5 9-16 M25 1,0 EX	1411391	1			
9 mm ... 16 mm					QPD W 4PE2,5 9-16 M25 FC EX	1411392	1

**Panel feed-throughs, 6.0 mm<sup>2</sup>**

- Devices no longer need to be opened in order to connect the cables
- User-friendly connection, even on devices that are difficult to access
- Touch-proof in accordance with DIN EN 50274



With one QUICKON nut,  
4+PE-pos.



Without QUICKON nut,  
4+PE-pos.

	Technical data		Technical data		
	Black	Gray	Black	Gray	
General data					
Degree of protection	IP68/IP69K	IP68/IP69K	IP68/IP69K	IP68/IP69K	
Electrical data					
Rated voltage (III/3)	690 V	690 V	690 V	690 V	
Rated surge voltage	6 kV	6 kV	6 kV	6 kV	
Rated current	40 A	40 A	40 A	40 A	
Surge voltage category/pollution degree	III/3	III/3	III/3	III/3	
Material data					
Housing material	PA	PA	PA	PA	
Contact material	Cu	Cu	Cu	Cu	
Inflammability class according to UL 94	V0	V0	V0	V0	
Mechanical data					
Impact category	IK07	IK07	IK07	IK07	
Color	Black	Gray	Black	Gray	
Connector data QUICKON connection					
Core insulation	PVC/PE/TPE/rubber	PVC/PE/TPE/rubber	PVC/PE/TPE/rubber	PVC/PE/TPE/rubber	
Structure of individual litz wire/ smallest wire diameter	VDE 0295 class 1 to 6/ min. 0.15 mm	VDE 0295 class 1 to 6/ min. 0.15 mm	VDE 0295 class 1 to 6/ min. 0.15 mm	VDE 0295 class 1 to 6/ min. 0.15 mm	
Connection frequency	max. 10	max. 10	max. 10	max. 10	
Conductor cross section [mm <sup>2</sup> ] solid/stranded	2.5 mm <sup>2</sup> ... 6 mm <sup>2</sup> / 2.5 mm <sup>2</sup> ... 6 mm <sup>2</sup>	2.5 mm <sup>2</sup> ... 6 mm <sup>2</sup> / 2.5 mm <sup>2</sup> ... 6 mm <sup>2</sup>	2.5 mm <sup>2</sup> ... 6 mm <sup>2</sup> / 2.5 mm <sup>2</sup> ... 6 mm <sup>2</sup>	2.5 mm <sup>2</sup> ... 6 mm <sup>2</sup> / 2.5 mm <sup>2</sup> ... 6 mm <sup>2</sup>	
Conductor cross section [AWG]	14 ... 10	14 ... 10	14 ... 10	14 ... 10	
Temperature data					
Ambient temperature (operation)	-40°C ... 80°C	-40°C ... 80°C	-40°C ... 80°C	-40°C ... 80°C	
Temperature when conductor connected	-5°C ... 50°C	-5°C ... 50°C	-5°C ... 50°C	-5°C ... 50°C	
	Ordering data		Ordering data		
Description	Cable length	Order No.	Pcs. / Pkt.	Order No.	Pcs. / Pkt.
		Black		Gray	
<b>Panel feed-through, with M25 x 1.5 mounting flange, with one QUICKON nut, for cable diameter:</b>					
9 mm ... 14 mm	0.5 m	1410392	1	1410399	1
9 mm ... 14 mm	1 m	1410393	1	1410400	1
12 mm ... 20 mm	0.5 m	1410394	1	1410401	1
12 mm ... 20 mm	1 m	1410395	1	1410402	1
<b>Panel feed-through, with M25 x 1.5 mounting flange, without QUICKON nut</b>					
	0.5 m			1410396	1
	1 m			1410397	1
<b>QUICKON nut, for connections up to 6.0 mm<sup>2</sup>, for cable diameter:</b>					
9 mm ... 14 mm				1410409	1
12 mm ... 20 mm				1410406	1
				1410403	1
				1410404	1
				1410407	1
				1410405	1

## Installation system - QPD installation system

### Assembled cables, 2.5 mm<sup>2</sup>

- Connecting cable between two QUICKON connections
- User-friendly connection, even on devices that are difficult to access
- Touch-proof in accordance with DIN EN 50274
- Other versions available on request



4+PE-pos.

Technical data	
General data	
Degree of protection	IP68/IP69K
Electrical data	
Rated voltage (III/3)	690 V
Rated surge voltage	6 kV
Rated current	20 A
Surge voltage category/pollution degree	III/3
Material data	
Housing material	PA
Contact material	Cu
Inflammability class according to UL 94	V0
Mechanical data	
Impact category	IK07
Color	Black
Connector data QUICKON connection	
Core insulation	PVC/PE/TPE/rubber
Structure of individual litz wire/ smallest wire diameter	VDE 0295 class 1 to 6/min. 0.15 mm
Connection frequency	max. 10
Conductor cross section [mm <sup>2</sup> ] solid/stranded	1 mm <sup>2</sup> ... 2.5 mm <sup>2</sup> /1 mm <sup>2</sup> ... 2.5 mm <sup>2</sup>
Conductor cross section [AWG]	16 ... 14
Temperature data	
Ambient temperature (operation)	-40°C ... 80°C
Temperature when conductor connected	-5°C ... 50°C

Ordering data				
Description	Cable length	Type	Order No.	Pcs. / Pkt.
<b>Assembled cable</b>	1 m	QPD 5P/ 1,0-PVC/5P 5X2,5 BK	1408720	1
	3 m	QPD 5P/ 3,0-PVC/5P 5X2,5 BK	1408721	1
	5 m	QPD 5P/ 5,0-PVC/5P 5X2,5 BK	1408722	1
	10 m	QPD 5P/10,0-PVC/5P 5X2,5 BK	1408723	1

Accessories



- Mounting clip ① for easily fixing the H-distributor in place without the need for tools
- DIN rail mounting can be achieved using two DIN-rail adapters ②
- Plastic labels ③ can be stuck to the middle of the H-distributor
- Red sealing plugs ④ can be easily stuck into the QUICKON nuts and create a seal when screwed tight
- Protective caps with retaining cords ⑤ for closing open QUICKON domes which are going to have a connector (for example) fitted at a later date
- Locking nuts ⑥ for fixing the panel feed-throughs to thin panels that are unable to accommodate a proprietary thread
- Insulating sleeve ⑦ for 4.8 mm slip-on connections
- Transparent protective caps ⑧ for attaching to the open QUICKON dome
- Transparent protective caps ⑨ at front for attaching to the connector
- Slotted socket wrenches ⑩ enable you to tighten the QUICKON nuts easily and securely
- Red coding profiles ⑪ for preventing QPD connector mix-ups. Simply insert them into the QUICKON dome and connector on the front side. They are marked with an arrow and their symmetrical form enables them to be mounted in four different positions
- AS-Interface seals ⑫ for connecting 1 or 2 AS-Interface cables
- Aluminum shielding tape ⑬ prevents the splicing of the braided shield and enables a clean shield connection









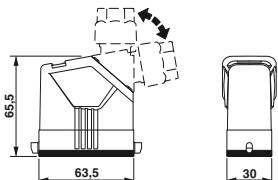

Description		Ordering data		
		Type	Order No.	Pcs. / Pkt.
	<b>Mounting clip</b> , for the 4-pos. H-distributor, color: black ①	QPD CLIP 2,5 BK	1582235	10
	<b>DIN rail adapter</b> For M5 screws ②	USA 10/4,6	1202713	10
	<b>Plastic label</b> For plotting and engraving Can be printed using thermal transfer printer ③	GPE 13X 9 WH EMLP (13X9)R	0806932 0819453	10 1
	<b>Closing cap</b> , for closing unused bore holes in multiple seals and cable glands ④			
	Ø 10 mm	SEALING PLUG 10X16 RD	1400284	10
	Ø 14 mm	SEALING PLUG 14X22 RD	1400270	10
	<b>Protective cap</b> , captive, IP68 ⑤			
	Color: green	QPD QSK 2,5 FS	1582488	1
	Color: black	QPD QSK BK 2,5 FS	1582645	1
	Color: gray	QPD QSK GY 5X2,5 FS	1404526	1
	Color: black	QPD QSK BK 5X2,5 FS	1404525	1
	<b>Counter nut</b> , (plastic), to lock the contact carrier from the inside of the device ⑥			
	M16 / SW22 / color: green	Q-MU M16	1640692	25
	M20 / SW26 / color: green	Q-MU M20	1640702	25
	M25 / SW32 / color: black	Q-MU M25	1640715	25
	Pg21 / SW36 / color: black	Q-MU PG 21 BK	1582655	50
	<b>Insulating sleeve</b> , as shock protection for 4.8 mm slip-on sleeves; first slide over the conductor ⑦			
	For 4.8 mm slip-on sleeves	PT/FS 4,8	1670497	25
	<b>Protective cap</b> , transparent plastic, for QUICKON connection, IP54 ⑧			
		QPD QSK 2,5	1582150	10
		QPD QSK 5X2,5	1404528	10
		QPD QSK 5X6,0	1411403	10
	<b>Protective cap</b> , transparent plastic, for QUICKON connection, IP50 ⑨			
		QPD PSK 2,5	1582151	10
		QPD PSK 5X2,5	1404529	10
		QPD PSK 5X6,0	1411404	10
	<b>Slotted socket wrench</b> for QUICKON nuts and panel feed-throughs, for wrench size: ⑩			
	15 mm	QSS 15	1641992	1
	19 mm	QSS 19	1670895	1
	22 mm	QSS 22	1670206	1
	24 mm	QSS 24	1670219	1
	27 mm	QSS 27	1670646	1
	<b>Coding profile</b> , for insertion into the connector and QUICKON dome ⑪			
		CP-QPD	1582459	10
		CP-QPD 5X2,5	1404530	10
	<b>Seal for 4-pos. versions</b> , NBR, black, for IP65/IP67 protection ⑫			
	One AS-i cable	KV-DI-PG16-1XASI	1582462	10
	Two AS-i cables	KV-DI-PG16-2XASI	1582464	10
	<b>Shielding tape</b> , aluminum, for the shielded QPD versions ⑬			
		ALU-SB	1404531	100

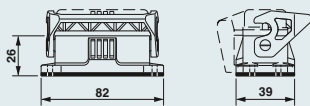
## Heavy-duty connectors - HEAVYCON type D

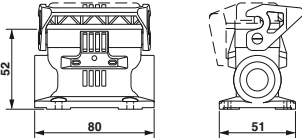
### EVO housing, type D15, plastic, single locking latch

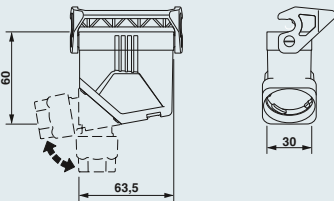

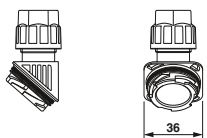
General data		Technical data	
Housing material		Polyamide	
Locking latch material		Polyamide	
Sealing material		NBR	
Ambient temperature (operation)		-40°C ... 100°C	
Type of protection (when plugged in)		IP66	

Description		Thread	Type	Order No.	Pcs. / Pkt.	Dimensions
<b>Sleeve housing</b> Height: 65.5 mm 			HC-EVO-D15-HHFS-PL-BK	1411340	1	
<b>Panel mounting base</b> Height: 26 mm 			Without cover HC-EVO-D15-BWS-PLR-BK With cover HC-EVO-D15-BWSC-PLR-BK	1411336 1411337	1 1	
<b>Box mounting base</b> Height: 52 mm 		2x M25 2x M25	Without cover HC-EVO-D15-SLWS-2SSM25-PLR-BK With cover HC-EVO-D15-SLWSC-2SSM25-PLR-BK	1411341 1411343	1 1	
<b>Coupling housing</b> Height: 60 mm 			HC-EVO-D15-CHWS-PL-BK	1411338	1	
<b>Cable gland</b> 		1x M20 1x M25	HC-D-G-M20-PLRBK HC-D-G-M25-PLRBK	1411350 1411351	1 1	
<b>Connector set</b> 			Without cover, screw connection HC-EVO-A10UT-BWS-HH-M20-PLRBK With cover, screw connection HC-EVO-A10UT-BWSC-HH-M20-PLRBK	1411356 1411357	1 1	

### Accessories



Thread adapter  
From page 219









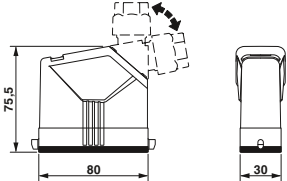

**EVO housing, type D25,  
plastic, single locking latch**

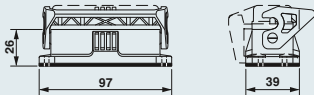

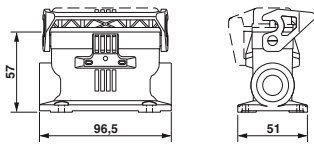
**Technical data**

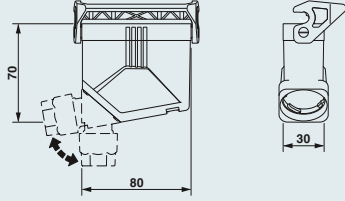
General data	
Housing material	Polyamide
Locking latch material	Polyamide
Sealing material	NBR
Ambient temperature (operation)	-40°C ... 100°C
Type of protection (when plugged in)	IP66

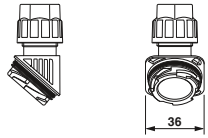
**Ordering data**

Description	Thread	Type	Order No.	Pcs. / Pkt.	Dimensions
<b>Sleeve housing</b> Height: 75.5 mm 		HC-EVO-D25-HHFS-PL-BK	1411347	1	
<b>Panel mounting base</b> Height: 26 mm 		Without cover HC-EVO-D25-BWS-PLR-BK	1411344	1	
		With cover HC-EVO-D25-BWSC-PLR-BK	1411345	1	
<b>Box mounting base</b> Height: 57 mm 	2x M25	Without cover HC-EVO-D25-SLWS-2SSM25-PLR-BK	1411348	1	
	2x M25	With cover HC-EVO-D25-SLWSC-2SSM25-PLR-BK	1411349	1	
<b>Coupling housing</b> Height: 70 mm 		HC-EVO-D25-CHWS-PLR-BK	1411346	1	
<b>Cable gland</b> 	1x M20	HC-D-G-M20-PLRBK	1411350	1	
	1x M25	HC-D-G-M25-PLRBK	1411351	1	
<b>Connector set</b> 		Without cover, screw connection HC-EVO-A16UT-BWS-HH-M25-PLRBK	1411358	1	
		With cover, screw connection HC-EVO-A16UT-BWSC-HH-M25-PLRBK	1411359	1	

**Accessories**



**Thread adapter**  
From page 219

## Heavy-duty connectors - HEAVYCON type B

### Contact inserts BB series

500 V, 16 A

Connection technology:

- Crimp connection

With groove for accommodating coding profiles for easy and inexpensive coding of identical plug-in connections

- Can be coded in seconds, thanks to the coding profile

Notes:
For accessories, see Catalog 4 from page 552
Order crimp contacts separately
Connectors may only be operated when under no load
Observe notes on the connection technology

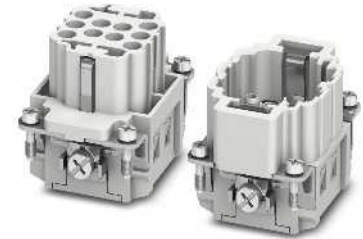





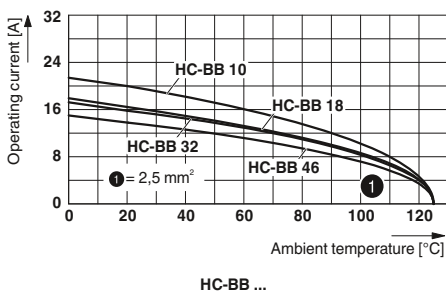

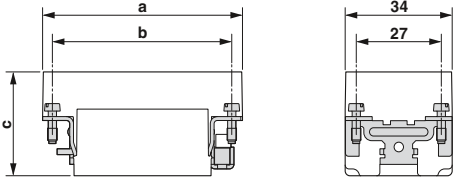

Type	Technical data			
	HC-BB 10-I-CT-...	HC-BB 18-I-CT-...	HC-BB 32-I-CT-...	HC-BB 46-I-CT-...
Approvals	-	-	-	-
IEC data				
Rated current, contacts (at 40°C)	A	16	16	16
Surge voltage category		III	III	III
Pollution degree		3	3	3
Rated voltage (III/3) contacts	V	500	500	500
Rated surge voltage, contacts	kV	6	6	6
Connection cross section	mm <sup>2</sup>	0.5 ... 4	0.5 ... 4	0.5 ... 4
UL data				
Rated voltage	V	-	-	-
Rated current	A	-	-	-
AWG		-	-	-
CSA data				
Rated voltage	V	-	-	-
Rated current	A	-	-	-
AWG		-	-	-
Material data				
Contact carrier material		PC	PC	PC
Inflammability class in acc. with UL 94		V0	V0	V0
Contact material		Copper alloy	Copper alloy	Copper alloy
Contact surface material		Ag (alternatively Au)	Ag (alternatively Au)	Ag (alternatively Au)
Temperature data				
Ambient temperature range	°C	-40 ... 125	-40 ... 125	-40 ... 125
General data				
Connection method		Crimp connection	Crimp connection	Crimp connection
No. of pos.		10	18	32
Contact numbering		1 - 10	1 - 18	1 - 32
Insertion/withdrawal cycles		≥ 500	≥ 500	≥ 500

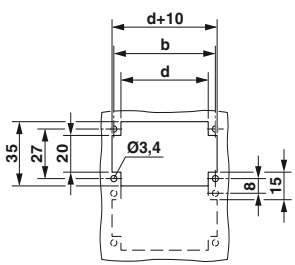
### Derating curves





Description	Pos.	Number	Housing	Ordering data			Pcs. / Pkt.	Dimensions (in mm)																																																																	
				Type	Order No. Socket	Order No. Plug																																																																			
<b>Crimp connection</b> 	10	1 - 10	B6	① HC-BB 10-I-CT-...	1584703	1584774	1																																																																		
<b>Crimp connection</b> 	18	1 - 18	B10	② HC-BB 18-I-CT-...	1584729	1584716	1																																																																		
<b>Crimp connection</b> 	32	1 - 32	B16 / B32	③ HC-BB 32-I-CT-...	1584745	1584732	1	 <p>Dimensional drawing</p> <p>Panel cutout</p>																																																																	
<b>Crimp connection</b> 	32	33 - 64	B16 / B32	④ HC-BB 32-I-CT-... 33-64	1406543	1406544	1																																																																		
<b>Crimp connection</b> 	46	1 - 46	B24 / B48	⑤ HC-BB 46-I-CT-...	1584758	1584761	1	<table border="1"> <thead> <tr> <th></th> <th>a</th> <th>b</th> <th>c</th> <th>d</th> </tr> </thead> <tbody> <tr> <td>① Socket</td> <td>51</td> <td>44</td> <td>32.5</td> <td></td> </tr> <tr> <td>① Plug</td> <td></td> <td></td> <td>33.2</td> <td>35</td> </tr> <tr> <td>② Socket</td> <td>64</td> <td>57</td> <td>32.5</td> <td></td> </tr> <tr> <td>② Plug</td> <td></td> <td></td> <td>33.2</td> <td>48</td> </tr> <tr> <td>③ Socket</td> <td>84.5</td> <td>77.5</td> <td>32.5</td> <td></td> </tr> <tr> <td>③ Plug</td> <td></td> <td></td> <td>33.2</td> <td>68.5</td> </tr> <tr> <td>④ Socket</td> <td>84.5</td> <td>77.5</td> <td>32.5</td> <td></td> </tr> <tr> <td>④ Plug</td> <td></td> <td></td> <td>33.2</td> <td>68.5</td> </tr> <tr> <td>⑤ Socket</td> <td>111</td> <td>104</td> <td>32.5</td> <td></td> </tr> <tr> <td>⑤ Plug</td> <td></td> <td></td> <td>33.2</td> <td>95</td> </tr> <tr> <td>⑥ Socket</td> <td>111</td> <td>104</td> <td>32.5</td> <td></td> </tr> <tr> <td>⑥ Plug</td> <td></td> <td></td> <td>33.2</td> <td>95</td> </tr> </tbody> </table>		a	b	c	d	① Socket	51	44	32.5		① Plug			33.2	35	② Socket	64	57	32.5		② Plug			33.2	48	③ Socket	84.5	77.5	32.5		③ Plug			33.2	68.5	④ Socket	84.5	77.5	32.5		④ Plug			33.2	68.5	⑤ Socket	111	104	32.5		⑤ Plug			33.2	95	⑥ Socket	111	104	32.5		⑥ Plug			33.2	95
	a	b	c	d																																																																					
① Socket	51	44	32.5																																																																						
① Plug			33.2	35																																																																					
② Socket	64	57	32.5																																																																						
② Plug			33.2	48																																																																					
③ Socket	84.5	77.5	32.5																																																																						
③ Plug			33.2	68.5																																																																					
④ Socket	84.5	77.5	32.5																																																																						
④ Plug			33.2	68.5																																																																					
⑤ Socket	111	104	32.5																																																																						
⑤ Plug			33.2	95																																																																					
⑥ Socket	111	104	32.5																																																																						
⑥ Plug			33.2	95																																																																					
<b>Crimp connection</b> 	46	47 - 92	B24 / B48	⑥ HC-BB 46-I-CT-... 47-92	1406545	1406546	1																																																																		
<b>Turned crimp contacts CK 2,5 Silver-plated</b> 																																																																									
			<b>Cross section mm<sup>2</sup> / AWG</b>																																																																						
			0.5 / 20	CK2,5-ED-0,50... AG	1663640	1663572	100																																																																		
			0.75 / 18	CK2,5-ED-0,75... AG	1663653	1663585	100																																																																		
			0.75 - 1 / 18	CK2,5-ED-1,00... AG	1663666	1663598	100																																																																		
			1.5 / 16	CK2,5-ED-1,50... AG	1663679	1663608	100																																																																		
			2.5 / 14	CK2,5-ED-2,50... AG	1663682	1663611	100																																																																		
			4 / 12	CK2,5-ED-4,00... AG	1663705	1663637	100																																																																		
<b>Turned crimp contacts CK 2,5 Gold-plated</b> 																																																																									
			<b>Cross section mm<sup>2</sup> / AWG</b>																																																																						
			0.5 / 20	CK2,5-ED-0,50... AU	1674859	1674804	100																																																																		
			0.75 - 1 / 18	CK2,5-ED-1,00... AU	1674833	1674781	100																																																																		
			1.5 / 16	CK2,5-ED-1,50... AU	1674820	1674778	100																																																																		
			2.5 / 14	CK2,5-ED-2,50... AU	1674862	1674817	100																																																																		
			4 / 12	CK2,5-ED-4,00... AU	1674846	1674794	100																																																																		

### Accessories



Coding profiles  
From page 221



PE screws  
Catalog 4 from page 580



Crimping tools  
Catalog 4 from page 562

## Heavy-duty connectors - HEAVYCON type B

### Contact inserts

#### HS series, high-current applications

500 V, 35 A

Connection technology:

– Screw connection

With groove for accommodating coding profiles for easy and inexpensive coding of identical plug-in connections

– Can be coded in seconds, thanks to the coding profile

Notes:
For accessories, see Catalog 4 from page 552
Connectors may only be operated when under no load
Observe notes on the connection technology



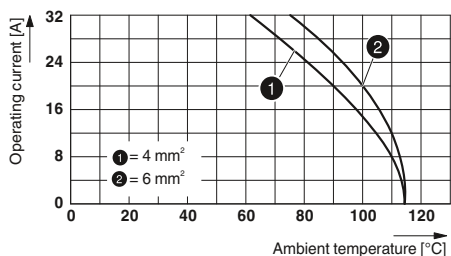

Type	Technical data		
	HC-HS06-I-UT-...	HC-HS06-I-UT-... 7-12	
Approvals	-	-	
IEC data			
Rated current, contacts (at 40°C)	A	35	35
Surge voltage category		III	III
Pollution degree		3	3
Rated voltage (III/3) contacts	V	400/690	400/690
Rated surge voltage, contacts	kV	6	6
Connection cross section	mm <sup>2</sup>	0.5 ... 6	0.5 ... 6
UL data			
Rated voltage	V	-	-
Rated current	A	-	-
AWG		-	-
CSA data			
Rated voltage	V	-	-
Rated current	A	-	-
AWG		-	-
Material data			
Contact carrier material		PC	PC
Inflammability class in acc. with UL 94		V0	V0
Contact material		Copper alloy	Copper alloy
Contact surface material		Ag	Ag
Temperature data			
Ambient temperature range	°C	-40 ... 125	-40 ... 125
General data			
Connection method		Screw connection	Screw connection
No. of pos.		6	6
Contact numbering		1 - 6	7 - 12
Insertion/withdrawal cycles		≥ 500	≥ 500

## Derating curves

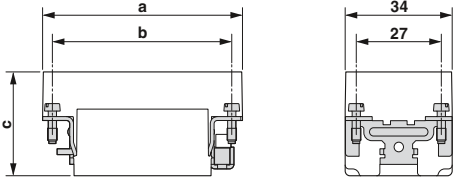

HC-HS06-I-UT-...

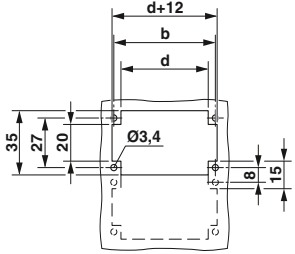
Description	Pos.	Number	Housing	Ordering data			Pcs. / Pkt.	Dimensions (in mm)																									
				Type	Order No. Socket	Order No. Plug																											
Screw connection 	6	1 - 6	B16 / B32	① HC-HS06-I-UT-...	1406530	1406531	1																										
Screw connection 	6	7 - 12	B16 / B32	② HC-HS06-I-UT-... 7-12	1406533	1406534	1	Dimensional drawing 																									
								<table border="1"> <thead> <tr> <th></th> <th>a</th> <th>b</th> <th>c</th> <th>d</th> </tr> </thead> <tbody> <tr> <td>① Socket</td> <td>84.5</td> <td>77.5</td> <td>34</td> <td>72</td> </tr> <tr> <td>① Plug</td> <td>84.5</td> <td>77.5</td> <td>34</td> <td>72</td> </tr> <tr> <td>② Socket</td> <td>84.5</td> <td>77.5</td> <td>34</td> <td>72</td> </tr> <tr> <td>② Plug</td> <td>84.5</td> <td>77.5</td> <td>34</td> <td>72</td> </tr> </tbody> </table>		a	b	c	d	① Socket	84.5	77.5	34	72	① Plug	84.5	77.5	34	72	② Socket	84.5	77.5	34	72	② Plug	84.5	77.5	34	72
	a	b	c	d																													
① Socket	84.5	77.5	34	72																													
① Plug	84.5	77.5	34	72																													
② Socket	84.5	77.5	34	72																													
② Plug	84.5	77.5	34	72																													

### Accessories



Coding profiles  
Catalog 4 from page 581



PE screws  
Catalog 4 from page 580



### EMC protection

The new EMC series of HEAVYCON EVO heavy-duty connectors has been specifically developed for applications with increased requirements. Furthermore, the housing surfaces and all seals are constructed so as to be electrically conductive.

### Flexible, thanks to reduced number of versions

Thanks to the unique HEAVYCON EVO bayonet locking, only the swivel cable glands have to be replaced in order to cover the M20, M25, M32, and M40 clamping areas with straight and lateral outlet.

### Fully compatible

The HEAVYCON EVO housing is plug-compatible with standard aluminum housing. It fits the standard panel cutouts of heavy-duty connectors.



### Easy closing operation

The bayonet locking designed specially for EVO applications ensures easy on-site assembly without tools. For removal, a standard screwdriver is used to push down on the locking spring.

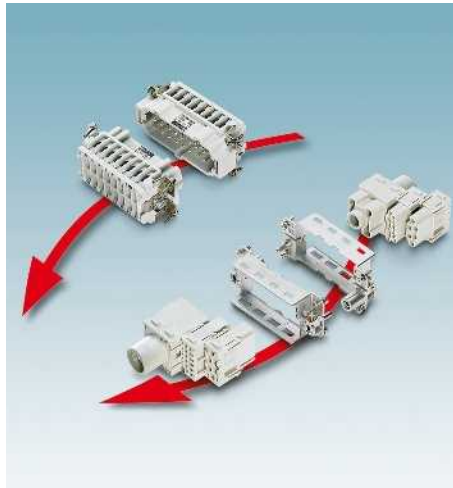

### Suitable for all inserts

All fixed and modular contact inserts in B series format fit in HEAVYCON EVO housing.



### Electrical connection

A solid electrical connection is required between the housing and the cable gland for EMC and safety reasons. The locking spring ensures a safe mechanical and electrical connection.



### Complete panel feed-through

The new EMC housings combine the advantages of EVO plastic housing with those of standard metal housing. A complete panel feed-through system is therefore available for EMC applications.



### Easy cable assembly

On the HEAVYCON EVO housing, the angled cable inlet is particularly large. This simplifies cable assembly if the cable gland is only mounted at the end of the process.



### For harsh conditions

The metal housings are made from salt-water-resistant aluminum. They meet the requirements of IP66 protection and NEMA 4/4x/12.

## Heavy-duty connectors - HEAVYCON type B

### EVO housing, type B6, metal, for EMC applications, single locking latch









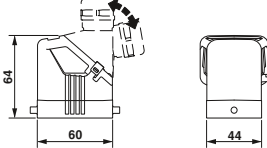

#### General data

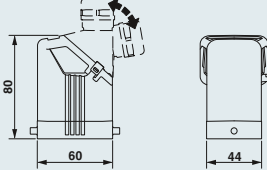
Housing material  
Surface material  
Locking latch material  
Sealing material  
Ambient temperature (operation)  
Type of protection (when plugged in)

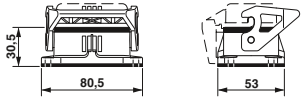
Technical data	
Housing material	Die-cast aluminum, salt water resistant
Surface material	Uncoated
Locking latch material	Polyamide
Sealing material	NBR, conductive
Ambient temperature (operation)	-40°C ... 125°C
Type of protection (when plugged in)	IP66

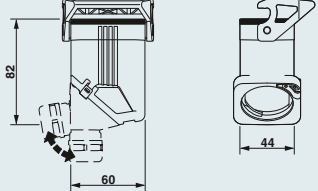
#### Ordering data

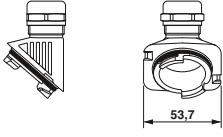
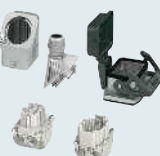
Description	Thread	Type	Order No.	Pcs. / Pkt.	Dimensions
<b>Sleeve housing</b> Height: 64 mm 		HC-EVO-B06-HLFS-EL-AL	1411448	1	
<b>Sleeve housing</b> Height: 80 mm 		HC-EVO-B06-HHFS-EL-AL	1411447	1	
<b>Panel mounting base</b> Height: 30.5 mm 		Without cover HC-STA-B06-BWS-ELC-AL With cover HC-STA-B06-BWSC-ELC-AL	1411318 1411319	1 1	
<b>Coupling housing</b> Height: 82 mm 		HC-EVO-B06-CHWS-ELC-AL	1411450	1	
<b>Cable gland</b> 	1x M20 1x M25 1x M32 1x M40	HC-B-G-M20-EC-AL HC-B-G-M25-EC-AL HC-B-G-M32-EC-AL HC-B-G-M40-EC-AL	1411439 1411446 1411440 1411441	1 1 1 1	
<b>Connector set</b> 		Push-in connection HC-EVO-B06PT-BWSC-HL-M20ELC-AL	1411487	1	

#### Accessories



Replacement seals  
From page 220









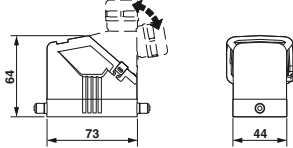

**EVO housing, type B10, metal, for EMC applications, single locking latch**

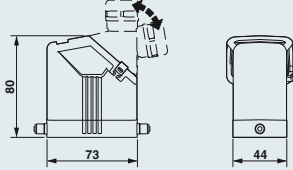

**Technical data**

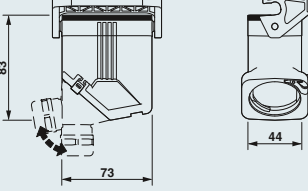
General data	
Housing material	Die-cast aluminum, salt water resistant
Surface material	Uncoated
Locking latch material	Polyamide
Sealing material	NBR, conductive
Ambient temperature (operation)	-40°C ... 125°C
Type of protection (when plugged in)	IP66

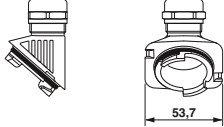
**Ordering data**

Description	Thread	Type	Order No.	Pcs. / Pkt.	Dimensions
<b>Sleeve housing</b> Height: 64 mm 		HC-EVO-B10-HLFS-EL-AL	1411456	1	
<b>Sleeve housing</b> Height: 80 mm 		HC-EVO-B10-HHFS-EL-AL	1411453	1	
<b>Panel mounting base</b> Height: 30.5 mm 		Without cover HC-STA-B10-BWS-ELC-AL With cover HC-STA-B10-BWSC-ELC-AL	1411320 1411321	1 1	
<b>Coupling housing</b> Height: 83 mm 		HC-EVO-B10-CHWS-ELC-AL	1411459	1	
<b>Cable gland</b> 	1x M20 1x M25 1x M32 1x M40	HC-B-G-M20-EC-AL HC-B-G-M25-EC-AL HC-B-G-M32-EC-AL HC-B-G-M40-EC-AL	1411439 1411446 1411440 1411441	1 1 1 1	
<b>Connector set</b> 		Push-in connection HC-EVO-B10PT-BWSC-HL-M25ELC-AL	1411491	1	

**Accessories**



Replacement seals  
From page 220

## Heavy-duty connectors - HEAVYCON type B

**EVO housing, type B10, metal, for EMC applications, double locking latch**









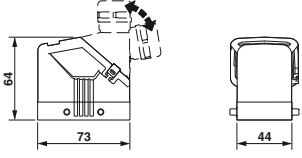

### General data

Housing material  
Surface material  
Locking latch material  
Sealing material  
Ambient temperature (operation)  
Type of protection (when plugged in)

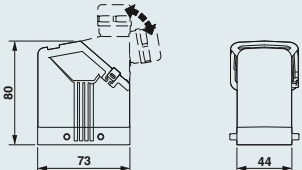
### Technical data

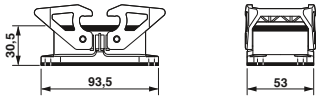
Die-cast aluminum, salt water resistant  
Uncoated  
Polyamide  
NBR, conductive  
-40°C ... 125°C  
IP66

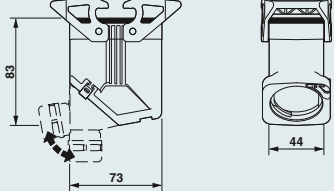
### Ordering data

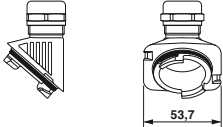
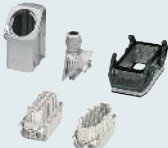
Description	Thread	Type	Order No.	Pcs. / Pkt.	Dimensions
<b>Sleeve housing</b> Height: 64 mm 		HC-EVO-B10-HLFD-EL-AL	1411455	1	
<b>Sleeve housing</b> Height: 80 mm 		HC-EVO-B10-HHFD-EL-AL	1411451	1	
<b>Panel mounting base</b> Height: 30.5 mm 		Without cover HC-STA-B10-BWD-ELC-AL	1411322	1	
<b>Coupling housing</b> Height: 83 mm 		HC-EVO-B10-CHWD-ELC-AL	1411458	1	
<b>Cable gland</b> 	1x M20 1x M25 1x M32 1x M40	HC-B-G-M20-EC-AL HC-B-G-M25-EC-AL HC-B-G-M32-EC-AL HC-B-G-M40-EC-AL	1411439 1411446 1411440 1411441	1 1 1 1	
<b>Connector set</b> 		Push-in connection HC-EVO-B10PT-BWD-HL-M25ELC-AL	1411488	1	

### Accessories



Replacement seals  
From page 220



**EVO housing, type B10, metal, for EMC applications, double locking latch**









**Technical data**

General data

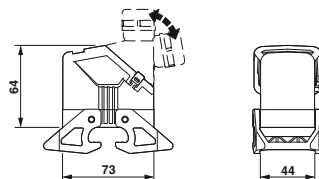
Housing material  
Surface material  
Locking latch material  
Sealing material  
Ambient temperature (operation)  
Type of protection (when plugged in)

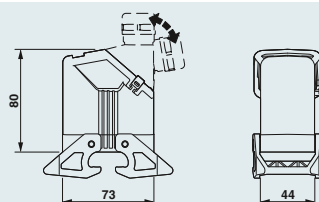
Die-cast aluminum, salt water resistant  
Uncoated  
Polyamide  
NBR, conductive  
-40°C ... 125°C  
IP66

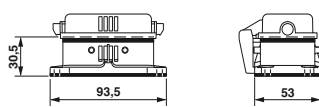
**Ordering data**

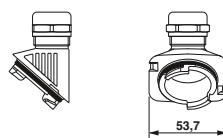
Description	Thread	Type	Order No.	Pcs. / Pkt.	Dimensions
<b>Sleeve housing</b> Height: 64 mm 		HC-EVO-B10-HLWD-EL-AL	1411457	1	
<b>Sleeve housing</b> Height: 80 mm 		HC-EVO-B10-HHWD-EL-AL	1411454	1	
<b>Panel mounting base</b> Height: 30.5 mm 		With cover HC-STA-B10-BFDC-ELC-AL	1411323	1	
<b>Cable gland</b> 	1x M20 1x M25 1x M32 1x M40	HC-B-G-M20-EC-AL HC-B-G-M25-EC-AL HC-B-G-M32-EC-AL HC-B-G-M40-EC-AL	1411439 1411446 1411440 1411441	1 1 1 1	

**Accessories**



Replacement seals  
From page 220

## Heavy-duty connectors - HEAVYCON type B

### EVO housing, type B16, metal, for EMC applications, single locking latch







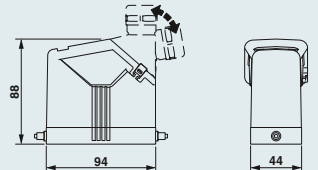

#### Technical data

##### General data

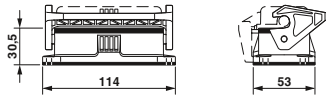
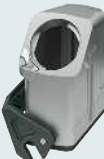
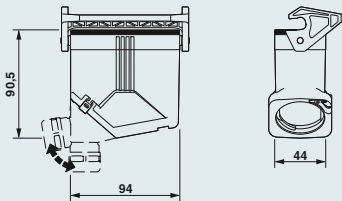
Housing material	Die-cast aluminum, salt water resistant
Surface material	Uncoated
Locking latch material	Polyamide
Sealing material	NBR, conductive
Ambient temperature (operation)	-40°C ... 125°C
Type of protection (when plugged in)	IP66

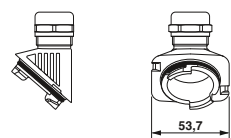
#### Ordering data

Description	Thread	Type	Order No.	Pcs. / Pkt.	Dimensions
<b>Sleeve housing</b> Height: 88 mm 		HC-EVO-B16-HHFS-EL-AL	1411461	1	
<b>Panel mounting base</b> Height: 30.5 mm 		Without cover HC-STA-B16-BWS-ELC-AL With cover HC-STA-B16-BWSC-ELC-AL	1411324 1411325	1 1	
<b>Coupling housing</b> Height: 90.5 mm 		HC-EVO-B16-CHWS-ELC-AL	1411464	1	
<b>Cable gland</b> 	1x M20 1x M25 1x M32 1x M40	HC-B-G-M20-EC-AL HC-B-G-M25-EC-AL HC-B-G-M32-EC-AL HC-B-G-M40-EC-AL	1411439 1411446 1411440 1411441	1 1 1 1	
<b>Connector set</b> 		Push-in connection HC-EVO-B16PT-BWSC-HH-M25ELC-AL	1411492	1	

#### Accessories



Replacement seals  
From page 220

**EVO housing, type B16, metal, for EMC applications, double locking latch**









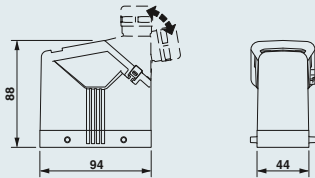

**Technical data**

General data

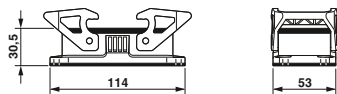
Housing material  
Surface material  
Locking latch material  
Sealing material  
Ambient temperature (operation)  
Type of protection (when plugged in)

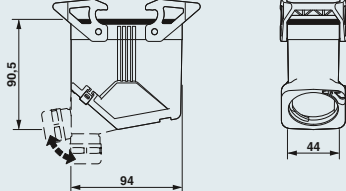
Die-cast aluminum, salt water resistant  
Uncoated  
Polyamide  
NBR, conductive  
-40°C ... 125°C  
IP66

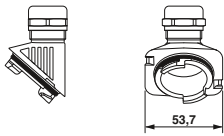
**Ordering data**

Description	Thread	Type	Order No.	Pcs. / Pkt.	Dimensions
<p>Sleeve housing Height: 88 mm</p> 		HC-EVO-B16-HHFD-EL-AL	1411460	1	
<p>Panel mounting base Height: 30.5 mm</p> 		Without cover HC-STA-B16-BWD-ELC-AL	1411327	1	
<p>Coupling housing Height: 90.5 mm</p> 		HC-EVO-B16-CHWD-ELC-AL	1411463	1	
<p>Cable gland</p> 	1x M20 1x M25 1x M32 1x M40	HC-B-G-M20-EC-AL HC-B-G-M25-EC-AL HC-B-G-M32-EC-AL HC-B-G-M40-EC-AL	1411439 1411446 1411440 1411441	1 1 1 1	
<p>Connector set</p> 		Push-in connection HC-EVO-B16PT-BWD-HH-M25ELC-AL	1411489	1	

**Accessories**



Replacement seals  
From page 220

## Heavy-duty connectors - HEAVYCON type B

### EVO housing, type B16, metal, for EMC applications, double locking latch







#### General data

Housing material  
Surface material  
Locking latch material  
Sealing material  
Ambient temperature (operation)  
Type of protection (when plugged in)

#### Technical data

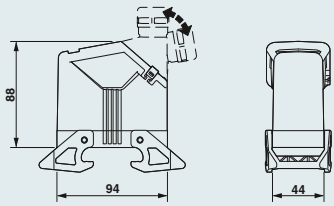
Die-cast aluminum, salt water resistant  
Uncoated  
Polyamide  
NBR, conductive  
-40°C ... 125°C  
IP66

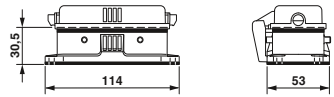
#### Ordering data

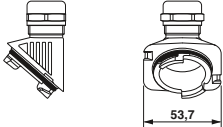
Description	Thread	Type	Order No.	Pcs. / Pkt.	Dimensions
<b>Sleeve housing</b> Height: 88 mm 		HC-EVO-B16-HHWD-EL-AL	1411462	1	
<b>Panel mounting base</b> Height: 30.5 mm 		With cover HC-STA-B16-BFDC-ELC-AL	1411328	1	
<b>Cable gland</b> 	1x M20 1x M25 1x M32 1x M40	HC-B-G-M20-EC-AL HC-B-G-M25-EC-AL HC-B-G-M32-EC-AL HC-B-G-M40-EC-AL	1411439 1411446 1411440 1411441	1 1 1 1	

#### Accessories



Replacement seals  
From page 220

**EVO housing, type B24, metal, for EMC applications, single locking latch**









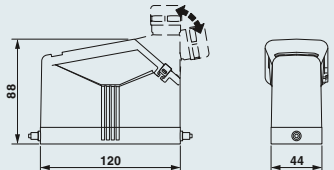

**Technical data**

General data

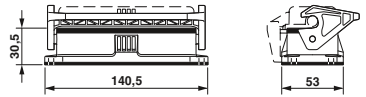
Housing material  
Surface material  
Locking latch material  
Sealing material  
Ambient temperature (operation)  
Type of protection (when plugged in)

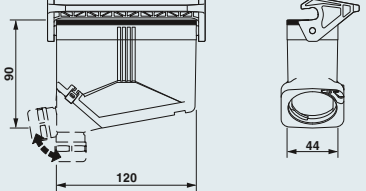
Die-cast aluminum, salt water resistant  
Uncoated  
Polyamide  
NBR, conductive  
-40°C ... 125°C  
IP66

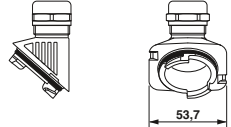
**Ordering data**

Description	Thread	Type	Order No.	Pcs. / Pkt.	Dimensions
<p><b>Sleeve housing</b> Height: 88 mm</p> 		HC-EVO-B24-HHFS-EL-AL	1411473	1	
<p><b>Panel mounting base</b> Height: 30.5 mm</p> 		Without cover HC-STA-B24-BWS-ELC-AL With cover HC-STA-B24-BWSC-ELC-AL	1411329 1411330	1 1	
<p><b>Coupling housing</b> Height: 90 mm</p> 		HC-EVO-B24-CHWS-ELC-AL	1411476	1	
<p><b>Cable gland</b></p> 	1x M20 1x M25 1x M32 1x M40	HC-B-G-M20-EC-AL HC-B-G-M25-EC-AL HC-B-G-M32-EC-AL HC-B-G-M40-EC-AL	1411439 1411446 1411440 1411441	1 1 1 1	
<p><b>Connector set</b></p> 		Push-in connection HC-EVO-B24PT-BWSC-HH-M32ELC-AL	1411493	1	

**Accessories**



Replacement seals  
From page 220

## Heavy-duty connectors - HEAVYCON type B

### EVO housing, type B24, metal, for EMC applications, double locking latch









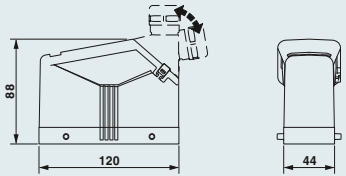

#### General data

Housing material  
Surface material  
Locking latch material  
Sealing material  
Ambient temperature (operation)  
Type of protection (when plugged in)

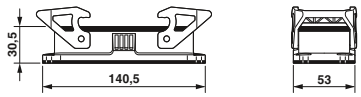
#### Technical data

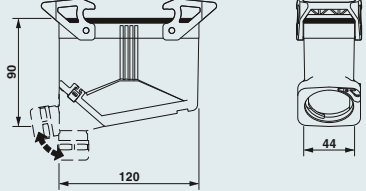
Die-cast aluminum, salt water resistant  
Uncoated  
Polyamide  
NBR, conductive  
-40°C ... 125°C  
IP66

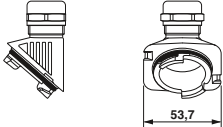
#### Ordering data

Description	Thread	Type	Order No.	Pcs. / Pkt.	Dimensions
<b>Sleeve housing</b> Height: 88 mm 		HC-EVO-B24-HHFD-EL-AL	1411472	1	
<b>Panel mounting base</b> Height: 30.5 mm 		Without cover HC-STA-B24-BWD-ELC-AL	1411331	1	
<b>Coupling housing</b> Height: 90 mm 		HC-EVO-B24-CHWD-ELC-AL	1411475	1	
<b>Cable gland</b> 	1x M20 1x M25 1x M32 1x M40	HC-B-G-M20-EC-AL HC-B-G-M25-EC-AL HC-B-G-M32-EC-AL HC-B-G-M40-EC-AL	1411439 1411446 1411440 1411441	1 1 1 1	
<b>Connector set</b> 		Push-in connection HC-EVO-B24PT-BWD-HH-M32ELC-AL	1411490	1	

#### Accessories



Replacement seals  
From page 220

**EVO housing, type B24,  
metal, for EMC applications,  
double locking latch**







**Technical data**

General data

Housing material  
Surface material  
Locking latch material  
Sealing material  
Ambient temperature (operation)  
Type of protection (when plugged in)

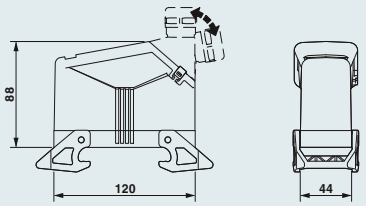
Die-cast aluminum, salt water resistant  
Uncoated  
Polyamide  
NBR, conductive  
-40°C ... 125°C  
IP66

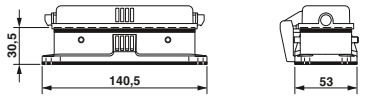
**Ordering data**

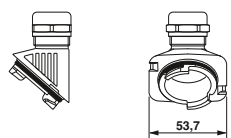
Description	Thread	Type	Order No.	Pcs. / Pkt.	Dimensions
<p>Sleeve housing Height: 88 mm</p> 		HC-EVO-B24-HHWD-EL-AL	1411474	1	
<p>Panel mounting base Height: 30.5 mm</p> 		With cover HC-STA-B24-BFDC-ELC-AL	1411332	1	
<p>Cable gland</p> 	<p>1x M20 1x M25 1x M32 1x M40</p>	<p>HC-B-G-M20-EC-AL HC-B-G-M25-EC-AL HC-B-G-M32-EC-AL HC-B-G-M40-EC-AL</p>	<p>1411439 1411446 1411440 1411441</p>	<p>1 1 1 1</p>	

**Accessories**



Replacement seals  
From page 220

## Heavy-duty connectors - HEAVYCON type B

### HPR housing, type B6, metal, for railway applications, screw locking









#### General data

Housing material  
Surface material  
Lock material  
Sealing material  
Ambient temperature (operation)  
Type of protection (when plugged in)

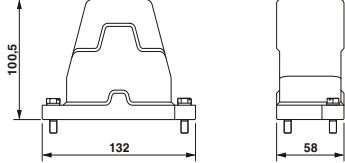
#### Technical data

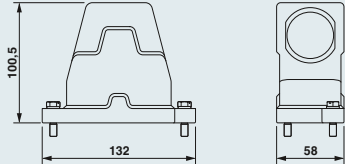
Aluminum die-cast  
Powder-coated, black  
High-grade steel  
Silicon  
-40°C ... 125°C  
IP68/IP69K

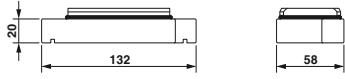
#### Ordering data

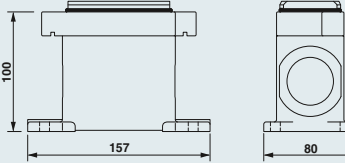
Description	Thread	Type	Order No.	Pcs. / Pkt.	Dimensions
<b>Sleeve housing</b> Height: 100.5 mm 	1x M20 1x M25	Cable entry: top	1411879	1	
		HC-HPR-B06-HHWH-1TTM20-EM-BK HC-HPR-B06-HHWH-1TTM25-EM-BK	1411106	1	
<b>Sleeve housing</b> Height: 100.5 mm 	1x M20 1x M25	Cable entry: lateral	1411878	1	
		HC-HPR-B06-HHWH-1STM20-EM-BK HC-HPR-B06-HHWH-1STM25-EM-BK	1411119	1	
<b>Panel mounting base</b> Height: 20 mm 		Without cover HC-HPR-B06-BFH-EMR-BK	1411122	1	
<b>Box mounting base</b> Height: 100 mm 	2x M20 2x M25	Without cover	1411880	1	
		HC-HPR-B06-SHFH-2SSM20-EMR-BK HC-HPR-B06-SHFH-2SSM25-EMR-BK	1411135	1	

#### Accessories



Cable gland  
From page 229



**HPR housing, type B10, metal, for railway applications, screw locking**







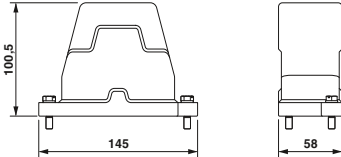

General data

Housing material  
Surface material  
Lock material  
Sealing material  
Ambient temperature (operation)  
Type of protection (when plugged in)

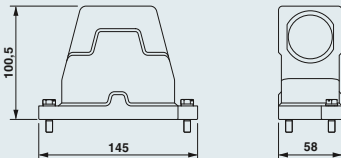
Technical data	
Housing material	Aluminum die-cast
Surface material	Powder-coated, black
Lock material	High-grade steel
Sealing material	Silicon
Ambient temperature (operation)	-40°C ... 125°C
Type of protection (when plugged in)	IP68/IP69K

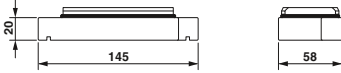
Ordering data

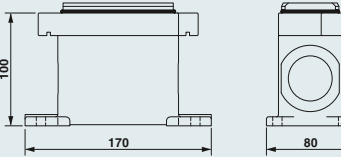
Description	Thread	Type	Order No.	Pcs. / Pkt.	Dimensions
<b>Sleeve housing</b> Height: 100.5 mm 	1x M25 1x M32	Cable entry: top <b>HC-HPR-B10-HHWH-1TTM25-EM-BK</b>	1411882	1	
		Cable entry: top <b>HC-HPR-B10-HHWH-1TTM32-EM-BK</b>	1411067	1	
<b>Sleeve housing</b> Height: 100.5 mm 	1x M25 1x M32	Cable entry: lateral <b>HC-HPR-B10-HHWH-1STM25EM-BK</b>	1411881	1	
		Cable entry: lateral <b>HC-HPR-B10-HHWH-1STM32-EM-BK</b>	1411070	1	
<b>Panel mounting base</b> Height: 20 mm 		Without cover <b>HC-HPR-B10-BFH-EMR-BK</b>	1411083	1	
<b>Box mounting base</b> Height: 100 mm 	2x M25 2x M32	Without cover <b>HC-HPR-B10-SHFH-2SSM25-EMR-BK</b>	1411883	1	
		Without cover <b>HC-HPR-B10-SHFH-2SSM32-EMR-BK</b>	1411096	1	

Accessories



Cable gland  
From page 229

## Heavy-duty connectors - HEAVYCON type B

### HPR housing, type B16, metal, for railway applications, screw locking









#### General data

Housing material  
Surface material  
Lock material  
Sealing material  
Ambient temperature (operation)  
Type of protection (when plugged in)

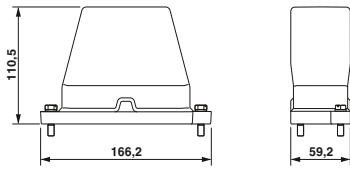
#### Technical data

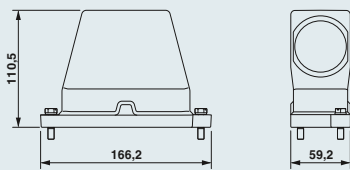
Aluminum die-cast  
Powder-coated, black  
High-grade steel  
Silicon  
-40°C ... 125°C  
IP68/IP69K

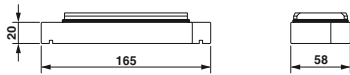
#### Ordering data

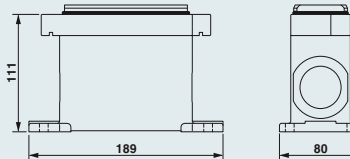
Description	Thread	Type	Order No.	Pcs. / Pkt.	Dimensions
<b>Sleeve housing</b> Height: 110.5 mm 	1x M32 1x M40	Cable entry: top	1411059	1	
		HC-HPR-B16-HHWH-1TTM32-EM-BK HC-HPR-B16-HHWH-1TTM40-EM-BK	1411885	1	
<b>Sleeve housing</b> Height: 110.5 mm 	1x M32 1x M40	Cable entry: lateral	1411058	1	
		HC-HPR-B16-HHWH-1STM32-EM-BK HC-HPR-B16-HHWH-1STM40-EM-BK	1411884	1	
<b>Panel mounting base</b> Height: 20 mm 		Without cover HC-HPR-B16-BFH-EMR-BK	1411060	1	
<b>Box mounting base</b> Height: 111 mm 	2x M32 2x M40	Without cover	1411054	1	
		HC-HPR-B16-SHFH-2SSM32-EMR-BK HC-HPR-B16-SHFH-2SSM40-EMR-BK	1411886	1	

#### Accessories



Cable gland  
From page 229

**HPR housing, type B24, metal, for railway applications, screw locking**









**Technical data**

General data

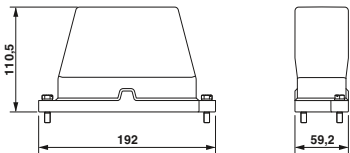
Housing material  
Surface material  
Lock material  
Sealing material  
Ambient temperature (operation)  
Type of protection (when plugged in)

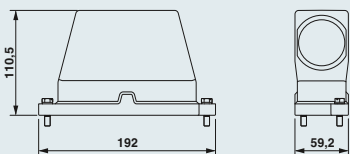
Aluminum die-cast  
Powder-coated, black  
High-grade steel  
Silicon  
-40°C ... 125°C  
IP68/IP69K

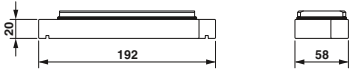
**Ordering data**

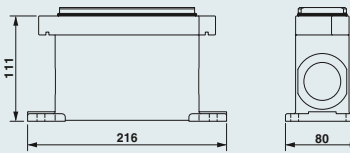
Description	Thread	Type	Order No.	Pcs. / Pkt.	Dimensions
<b>Sleeve housing</b> Height: 110.5 mm 	1x M32 1x M40	Cable entry: top <b>HC-HPR-B24-HHWH-1TTM32-EM-BK</b>	1411888	1	
		<b>HC-HPR-B24-HHWH-1TTM40-EM-BK</b>	1411062	1	
<b>Sleeve housing</b> Height: 110.5 mm 	1x M32 1x M40	Cable entry: lateral <b>HC-HPR-B24-HHWH-1STM32-EM-BK</b>	1411887	1	
		<b>HC-HPR-B24-HHWH-1STM40-EM-BK</b>	1411061	1	
<b>Panel mounting base</b> Height: 20 mm 		Without cover <b>HC-HPR-B24-BFH-EMR-BK</b>	1411055	1	
<b>Box mounting base</b> Height: 111 mm 	2x M32 2x M40	Without cover <b>HC-HPR-B24-SHFH-2SSM32-EMR-BK</b>	1411889	1	
		<b>HC-HPR-B24-SHFH-2SSM40-EMR-BK</b>	1411063	1	

**Accessories**



Cable gland  
From page 229

### Cable glands

Metal HEAVYCON EVO standard cable gland for higher strain relief with bayonet locking.

Black plastic cable glands with extended clamping area.

<b>Notes:</b>
Not for EMC applications



EVO standard cable gland, metal, with NBR seal



Cable gland, plastic

		Technical data			Technical data		
<b>Material data</b>							
Material		Aluminum, die-cast			-		
Material, pressure screw		Nickel-plated brass			Polyamide		
Cable seal material		CR/NBR			-		
Degree of protection		IP66			IP68, to 5 bar		
<b>Temperature data</b>							
Ambient temperature (operation)		-40°C ... 125°C			-20°C ... 100°C		
		Ordering data			Ordering data		
Description	Thread type	Type	Order No.	Pcs. / Pkt.	Type	Order No.	Pcs. / Pkt.
<b>Metal standard cable gland</b> , for HEAVYCON EVO metal housing, for cable diameter [mm]:							
7 mm ... 13 mm	M20	HC-B-G-M20-ER-AL	1411442	1			
11 mm ... 16 mm	M25	HC-B-G-M25-ER-AL	1411443	1			
14 mm ... 21 mm	M32	HC-B-G-M32-ER-AL	1411444	1			
19 mm ... 27 mm	M40	HC-B-G-M40-ER-AL	1411445	1			
<b>Plastic cable gland</b> , with extended clamping area, for cable diameter [mm]:							
5 mm ... 13 mm	M20				HC-K-KV-M20(5-13)BK	1411261	10
8 mm ... 17 mm	M25				HC-K-KV-M25(8-17)BK	1411258	10
12 mm ... 21 mm	M32				HC-K-KV-M32(12-21)BK	1407673	10
16 mm ... 28 mm	M40				HC-K-KV-M40(16-28)BK	1407674	10

**Thread adapters, filler plugs**

These thread adapters enable the use of special cable glands and corrugated pipe connections with HEAVYCON EVO type D housings.

Filler plugs for sealing unused thread openings on box mounting bases.



EVO D thread adapter, plastic



Filler plug, plastic

		Technical data			Technical data		
Material data							
Material		Polyamide fiberglass reinforced			Polyamide fiberglass reinforced		
Material, pressure screw		-			-		
Cable seal material		-			-		
Degree of protection		IP66			IP65		
Temperature data							
Ambient temperature (operation)		-40°C ... 125°C			-20°C ... 80°C		
		Ordering data			Ordering data		
Description	Thread type	Type	Order No.	Pcs. / Pkt.	Type	Order No.	Pcs. / Pkt.
<b>Plastic thread adapter</b> , for HEAVYCON EVO type D plastic housing	M25	HC-D-TA-M25-PLRBK	1411352	1			
	Pg16	HC-D-TA-PG16-PLR-BK	1411353	1			
	NPT3/4"	HC-D-TA-NPT-3/4-PLR-BK	1411354	1			
<b>Plastic filler plug</b> , for HEAVYCON base profiles	M25				HC-K-BS-M25 BK	1411245	10
	M32				HC-K-BS-M32-BK	1410754	10
	M40				HC-K-BS-M40-BK	1410767	10

## Heavy-duty connectors - HEAVYCON accessories

### Replacement flat gaskets, profile gaskets for type B

– For EMC housing

**Notes:**  
Bond the replacement profile gaskets to the housing.



Replacement EMC flat gasket, for EVO B panel mounting base



Replacement EMC profile gasket, for EVO B supporting base element

	Technical data			Technical data		
Material data						
Material	NBR, conductive			NBR, conductive		
Temperature data						
Ambient temperature (operation)	-40°C ... 125°C			-40°C ... 125°C		
	Ordering data			Ordering data		
Description	Type	Order No.	Pcs. / Pkt.	Type	Order No.	Pcs. / Pkt.
<b>Replacement flat seal</b> , for HEAVYCON panel mounting base type:						
B6	HC-B06-SG-CBK	1411483	10			
B10	HC-B10-SG-CBK	1411484	10			
B16	HC-B16-SG-CBK	1411485	10			
B24	HC-B24-SG-CBK	1411486	10			
<b>Replacement profile gasket</b> , for HEAVYCON EVO supporting base element type:						
B6				HC-B06-SP-CBK	1411477	10
B10				HC-B10-SP-CBK	1411479	10
B16				HC-B16-SP-CBK	1411480	10
B24				HC-B24-SP-CBK	1411482	10

**Special flat gaskets, coding profiles**

Special flat gaskets for type B panel mounting bases for uneven mounting surfaces.

Coding profile for new BB series contact inserts.

- For easy and inexpensive coding of identical plug-in connections
- Can be coded in seconds, thanks to the coding profile



**Special flat gasket, for standard B panel mounting base**



**Coding profile**

	Technical data			Technical data		
Material data						
Material	EPDM/CR			PA		
Temperature data						
Ambient temperature (operation)	-40°C ... 125°C			-40°C ... 125°C		
	Ordering data			Ordering data		
Description	Type	Order No.	Pcs. / Pkt.	Type	Order No.	Pcs. / Pkt.
<b>Special flat gasket</b> , made from foam rubber for HEAVYCON panel mounting base type:						
B6	HC-B 6-FL-MDI	1410929	10			
B10	HC-B 10-FL-MDI	1410932	10			
B16	HC-B 16-FL-MDI	1410945	10			
B24	HC-B 24-FL-MDI	1410958	10			
<b>Coding profile</b> , for new BB series contact inserts						
				CP-HC-S	1410916	10

## Installation and mounting material - CES cable entry system

### Sealing frames with cone-shaped cable sleeves

- Pre-assembled sealing frames with 8 (B16) or 10 (B24) cone-shaped cable sleeves. Particularly suitable for cables that are assembled or wired in the control cabinet. Cables up to 11 mm in diameter can be fed through by cutting off the sleeves.
- IP65 when using cable binders and vertical mounting
  - Resistant to oil, fuels, and grease
  - Halogen-free



Sealing frames with cone-shaped cable sleeves and screw locking

#### General data

Material of frames  
Material of cable sleeves  
Degree of protection

#### Technical data

Polyamide  
NBR  
IP54 (DIN IEC 60529)/IP65 (when directly mounted on the housing panel (perpendicular mounting or underwall mounting) and using a 3.6 mm wide cable binder (e.g., Order No. 3240744))

Temperature range [°C] -40 ... 120

#### Ordering data

Description

**Pre-assembled sealing frames with cone-shaped cable sleeves**, for cables with a diameter of:

2 - 11 mm  
2 - 11 mm

Type

Order No.

Pcs. / Pkt.

CES-B16-8XSRC-BK  
CES-B24-10XSRC-BK

1411073  
1411074

1  
1

#### Accessories

**Electrician's scissors**, high cutting performance, thanks to micro-serrated cutting area, suitable for copper, aluminum, Kevlar fibers, and plastic, two-component non-slip soft-grip handles, ergonomic design, adjustable screw joint

**M4 replacement locking screw**, with 3 mm Allen screw head, for sealing frame with screw locking

**Bit screwdriver**, with 1/4" quick-action chuck, suitable for bits according to DIN 3126-C 6.3 and E 6.3/ISO 1173, magnetic

**Screw bit**, hexagonal, E6.3-1/4" drive, hardened, suitable for holder according to DIN 3126-F 6.3/ISO 1173, size: hex 3 x 50 mm

Size: hex 3 x 50 mm

CUTFOX-ES

1212621

1

CES-SFFS-H

0801728

10

SF-M BH

1212070

1

SF-BIT-HEX 3-50

1212647

5

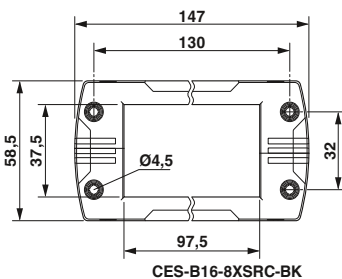

CES-B16-8XSRC-BK

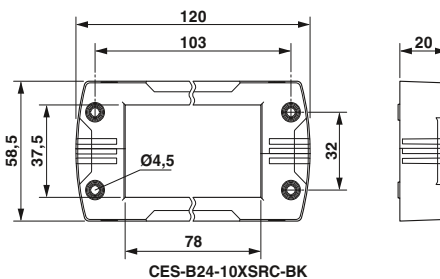

CES-B24-10XSRC-BK





## Installation and mounting material - cable glands

### Plastic cable gland, metric, EN 60423

- Material: polyamide 6
- Color: silver-gray (RAL 7001)
- Seal: neoprene
- Ambient temperature: -30°C ... +80°C (+150°C briefly)
- Degree of protection: IP68, 5 bar
- Strain relief: integrated according to EN 50262

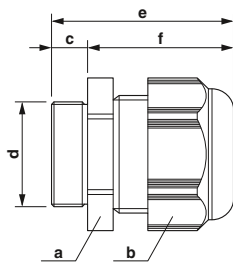

Plastic cable gland



243143 / QCRV2.E320158 / 40024418

Thread type	Clamping area [mm]	Dimensions [mm]						
		a	b	c	d	e	f	g
M12	3.00 - 6.50	15.00	15.00	8.00	12.00	32.10	24.10	-
M16	5.00 - 10.00	22.00	22.00	10.00	16.00	39.70	29.70	-
M20	6.00 - 12.00	24.00	24.00	10.00	20.00	42.30	32.30	-
M25	11.00 - 17.00	29.00	29.00	8.00	25.00	42.50	34.50	-
M32	15.00 - 21.00	36.00	36.00	10.00	32.00	50.80	40.80	-
M40	19.00 - 28.00	46.00	46.00	10.00	40.00	55.10	45.10	-
M50	30.00 - 38.00	60.00	60.00	18.00	50.00	71.70	53.70	-
M63	34.00 - 44.00	65.00	65.00	18.00	63.00	75.40	57.40	-

### Ordering data

Type	Order No.	Pcs. / Pkt.
G-INS-M12-S68N-PNES-GY	1411123	10
G-INS-M16-S68N-PNES-GY	1411124	10
G-INS-M20-S68N-PNES-GY	1411125	5
G-INS-M25-M68N-PNES-GY	1411126	5
G-INS-M32-M68N-PNES-GY	1411127	5
G-INS-M40-M68N-PNES-GY	1411128	5
G-INS-M50-L68L-PNES-GY	1411129	1
G-INS-M63-L68L-PNES-GY	1411130	1

### Plastic counter nut, metric, EN 60423

- Material: polyamide 6
- Color: silver-gray (RAL 7001)
- Ambient temperature: -20°C ... +80°C

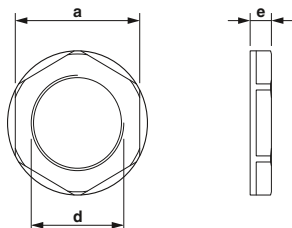

Plastic counter nut

Thread type	Clamping area [mm]	Dimensions [mm]						
		a	b	c	d	e	f	g
M12	-	18.00	-	-	12.00	5.00	-	-
M16	-	22.00	-	-	16.00	5.00	-	-
M20	-	26.00	-	-	20.00	6.00	-	-
M25	-	32.00	-	-	25.00	6.00	-	-
M32	-	41.00	-	-	32.00	7.00	-	-
M40	-	50.00	-	-	40.00	7.00	-	-
M50	-	60.00	-	-	50.00	8.00	-	-
M63	-	75.00	-	-	63.00	8.00	-	-

### Ordering data

Type	Order No.	Pcs. / Pkt.
A-INL-M12-P-GY	1411205	10
A-INL-M16-P-GY	1411206	10
A-INL-M20-P-GY	1411207	5
A-INL-M25-P-GY	1411208	5
A-INL-M32-P-GY	1411209	5
A-INL-M40-P-GY	1411210	5
A-INL-M50-P-GY	1411211	5
A-INL-M63-P-GY	1411212	5

**Plastic cable gland,  
metric, EN 60423**

- Material: polyamide 6
- Color: deep black (RAL 9005)
- Seal: neoprene
- Ambient temperature:  
-30°C ... +80°C (+150°C briefly)
- Degree of protection: IP68, 5 bar
- Strain relief: integrated according to EN 50262

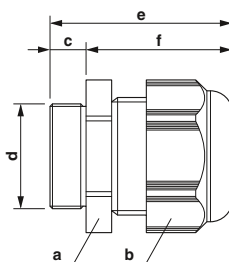

Plastic cable gland



243143 / QCRV.E320158 / 40024418

**Ordering data**

Thread type	Clamping area [mm]	Dimensions [mm]						
		a	b	c	d	e	f	g
M12	3.00 - 6.50	15.00	15.00	8.00	12.00	32.10	24.10	-
M16	5.00 - 10.00	22.00	22.00	10.00	16.00	39.70	29.70	-
M20	6.00 - 12.00	24.00	24.00	10.00	20.00	42.30	32.30	-
M25	11.00 - 17.00	29.00	29.00	8.00	25.00	42.50	34.50	-
M32	15.00 - 21.00	36.00	36.00	10.00	32.00	50.80	40.80	-
M40	19.00 - 28.00	46.00	46.00	10.00	40.00	55.10	45.10	-
M50	30.00 - 38.00	60.00	60.00	18.00	50.00	71.70	53.70	-
M63	34.00 - 44.00	65.00	65.00	18.00	63.00	75.40	57.40	-

Type	Order No.	Pcs. / Pkt.
G-INS-M12-S68N-PNES-BK	1411131	10
G-INS-M16-S68N-PNES-BK	1411132	10
G-INS-M20-S68N-PNES-BK	1411133	5
G-INS-M25-M68N-PNES-BK	1411134	5
G-INS-M32-M68N-PNES-BK	1411136	5
G-INS-M40-M68N-PNES-BK	1411137	5
G-INS-M50-L68L-PNES-BK	1411138	1
G-INS-M63-L68L-PNES-BK	1411139	1

**Plastic counter nut,  
metric, EN 60423**

- Material: polyamide 6
- Color: deep black (RAL 9005)
- Ambient temperature:  
-20°C ... +80°C

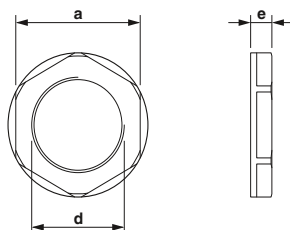

Plastic counter nut

**Ordering data**

Thread type	Clamping area [mm]	Dimensions [mm]						
		a	b	c	d	e	f	g
M12	-	18.00	-	-	12.00	5.00	-	-
M16	-	22.00	-	-	16.00	5.00	-	-
M20	-	26.00	-	-	20.00	6.00	-	-
M25	-	32.00	-	-	25.00	6.00	-	-
M32	-	41.00	-	-	32.00	7.00	-	-
M40	-	50.00	-	-	40.00	7.00	-	-
M50	-	60.00	-	-	50.00	8.00	-	-
M63	-	75.00	-	-	63.00	8.00	-	-

Type	Order No.	Pcs. / Pkt.
A-INL-M12-P-BK	1411213	10
A-INL-M16-P-BK	1411214	10
A-INL-M20-P-BK	1411215	5
A-INL-M25-P-BK	1411216	5
A-INL-M32-P-BK	1411217	5
A-INL-M40-P-BK	1411218	5
A-INL-M50-P-BK	1411219	5
A-INL-M63-P-BK	1411220	5

## Installation and mounting material - cable glands

### Plastic cable gland, Pg, EN 40430

- Material: polyamide 6
- Color: silver-gray (RAL 7001)
- Seal: neoprene
- Ambient temperature: -30°C ... +80°C (+150°C briefly)
- Degree of protection: IP68, 5 bar
- Strain relief: integrated according to EN 50262

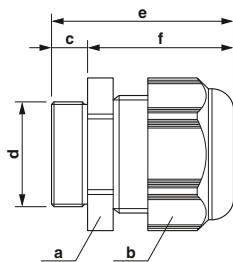

Plastic cable gland



243143 / QCRV2.E320158

#### Ordering data

Thread type	Clamping area [mm]	Dimensions [mm]						
		a	b	c	d	e	f	g
Pg7	3.00 - 6.50	15.00	15.00	8.00	12.50	32.70	24.70	-
Pg9	4.00 - 8.00	19.00	19.00	8.00	15.20	36.20	28.20	-
Pg11	5.00 - 10.00	22.00	22.00	8.00	18.60	38.10	30.10	-
Pg13.5	6.00 - 12.00	24.00	24.00	9.00	20.40	40.00	31.00	-
Pg16	10.00 - 14.00	27.00	27.00	10.00	22.50	44.20	34.20	-
Pg21	13.00 - 18.00	33.00	33.00	11.00	28.30	49.30	38.30	-
Pg29	18.00 - 25.00	42.00	42.00	11.00	37.00	53.90	42.90	-
Pg36	22.00 - 32.00	53.00	53.00	13.00	47.00	65.40	52.40	-
Pg42	30.00 - 38.00	60.00	60.00	13.00	54.00	65.90	52.90	-
Pg48	34.00 - 44.00	65.00	65.00	14.00	59.30	68.80	54.80	-

Type	Order No.	Pcs. / Pkt.
G-INS-PG7-S68N-PNES-GY	1411140	10
G-INS-PG9-S68N-PNES-GY	1411141	10
G-INS-PG11-S68N-PNES-GY	1411142	5
G-INS-PG13,5-S68N-PNES-GY	1411143	5
G-INS-PG16-S68N-PNES-GY	1411144	5
G-INS-PG21-M68N-PNES-GY	1411145	5
G-INS-PG29-M68N-PNES-GY	1411146	5
G-INS-PG36-L68N-PNES-GY	1411147	5
G-INS-PG42-L68N-PNES-GY	1411149	1
G-INS-PG48-L68N-PNES-GY	1411150	1

### Plastic counter nut, Pg, EN 40430

- Material: polyamide 6
- Color: silver-gray (RAL 7001)
- Ambient temperature: -20°C ... +80°C

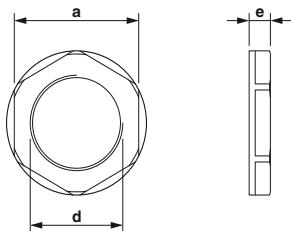

Plastic counter nut

#### Ordering data

Thread type	Clamping area [mm]	Dimensions [mm]						
		a	b	c	d	e	f	g
Pg7	-	19.00	-	-	12.50	5.00	-	-
Pg9	-	22.00	-	-	15.20	5.00	-	-
Pg11	-	24.00	-	-	18.60	5.00	-	-
Pg13.5	-	27.00	-	-	20.40	6.00	-	-
Pg16	-	30.00	-	-	22.50	6.00	-	-
Pg21	-	36.00	-	-	28.30	7.00	-	-
Pg29	-	46.00	-	-	37.00	7.00	-	-
Pg36	-	60.00	-	-	47.00	8.00	-	-
Pg42	-	65.00	-	-	54.00	8.00	-	-
Pg48	-	70.00	-	-	59.30	8.00	-	-

Type	Order No.	Pcs. / Pkt.
A-INL-PG7-P-GY	1411221	10
A-INL-PG9-P-GY	1411222	10
A-INL-PG11-P-GY	1411223	5
A-INL-PG13,5-P-GY	1411224	5
A-INL-PG16-P-GY	1411225	5
A-INL-PG21-P-GY	1411226	5
A-INL-PG29-P-GY	1411227	5
A-INL-PG36-P-GY	1411228	5
A-INL-PG42-P-GY	1411229	5
A-INL-PG48-P-GY	1411230	5

**Plastic cable gland,  
NPT, ANSI B1.20.1**

- Material: polyamide 6
- Color: silver-gray (RAL 7001)
- Seal: neoprene
- Ambient temperature:  
-30°C ... +80°C (+150°C briefly)
- Degree of protection: IP68, 5 bar
- Strain relief: integrated according to EN 50262

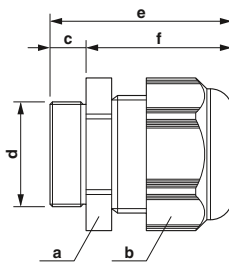

Plastic cable gland



243143 / QCRV.E320158

**Ordering data**

Thread type	Clamping area [mm]	Dimensions [mm]						
		a	b	c	d	e	f	g
NPT3/8"	5.00 - 10.00	22.00	22.00	15.00	16.60	44.50	29.50	-
NPT1/2"	10.00 - 14.00	27.00	27.00	15.00	20.60	47.10	32.10	-
NPT3/4"	13.00 - 18.00	33.00	33.00	15.00	25.90	47.50	35.50	-
NPT1"	18.00 - 25.00	42.00	42.00	18.00	32.40	58.50	40.50	-

Type	Order No.	Pcs. / Pkt.
G-INS-N3/8-S68L-PNES-GY	1411152	10
G-INS-N1/2-S68L-PNES-GY	1411153	10
G-INS-N3/4-M68L-PNES-GY	1411154	5
G-INS-N1-M68L-PNES-GY	1411155	5

**Plastic counter nut,  
NPT, ANSI B1.20.1**

- Material: polyamide 6
- Color: silver-gray (RAL 7001)
- Ambient temperature:  
-20°C ... +80°C

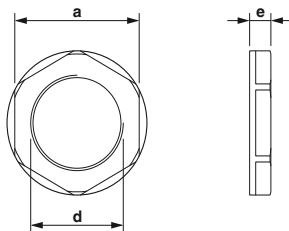

Plastic counter nut

**Ordering data**

Thread type	Clamping area [mm]	Dimensions [mm]						
		a	b	c	d	e	f	g
NPT3/8"	-	22.00	-	-	16.60	5.00	-	-
NPT1/2"	-	27.00	-	-	20.60	5.00	-	-
NPT3/4"	-	33.00	-	-	25.90	5.00	-	-
NPT1"	-	47.00	-	-	32.40	6.00	-	-

Type	Order No.	Pcs. / Pkt.
A-INL-NPT3/8-P-GY	1411231	10
A-INL-NPT1/2-P-GY	1411233	10
A-INL-NPT3/4-P-GY	1411234	5
A-INL-NPT1-P-GY	1411235	5

## Installation and mounting material - cable glands

### Plastic cable gland, NPT, ANSI B1.20.1

- Material: polyamide 6
- Color: deep black (RAL 9005)
- Seal: neoprene
- Ambient temperature:  
-30°C ... +80°C (+150°C briefly)
- Degree of protection: IP68, 5 bar
- Strain relief: integrated according to EN 50262

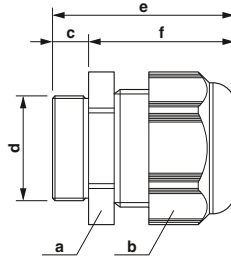

Plastic cable gland



243143 / QCRV.E320158

#### Ordering data

Thread type	Clamping area [mm]	Dimensions [mm]						
		a	b	c	d	e	f	g
NPT3/8"	5.00 - 10.00	22.00	22.00	15.00	16.60	44.50	29.50	-
NPT1/2"	10.00 - 14.00	27.00	27.00	15.00	20.60	47.10	32.10	-
NPT3/4"	13.00 - 18.00	33.00	33.00	12.00	25.90	47.50	35.50	-
NPT1"	18.00 - 25.00	42.00	42.00	18.00	32.40	58.50	40.50	-

Type	Order No.	Pcs. / Pkt.
G-INS-N3/8-S68L-PNES-BK	1411156	10
G-INS-N1/2-S68L-PNES-BK	1411157	10
G-INS-N3/4-M68L-PNES-BK	1411158	5
G-INS-N1-M68L-PNES-BK	1411159	5

### Plastic counter nut, NPT, ANSI B1.20.1

- Material: polyamide 6
- Color: deep black (RAL 9005)
- Ambient temperature:  
-20°C ... +80°C

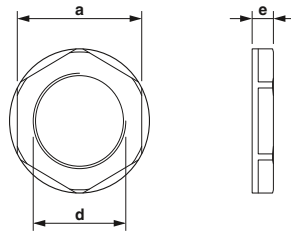

Plastic counter nut

Thread type	Clamping area [mm]	Dimensions [mm]						
		a	b	c	d	e	f	g
NPT3/8"	-	22.00	-	-	16.60	5.00	-	-
NPT1/2"	-	27.00	-	-	20.60	5.00	-	-
NPT3/4"	-	33.00	-	-	25.90	5.00	-	-
NPT1"	-	47.00	-	-	32.40	6.00	-	-

#### Ordering data

Type	Order No.	Pcs. / Pkt.
A-INL-NPT3/8-P-BK	1411236	10
A-INL-NPT1/2-P-BK	1411237	10
A-INL-NPT3/4-P-BK	1411238	5
A-INL-NPT1-P-BK	1411239	5

**Brass cable gland, metric, EN 60423**

- Material: brass, nickel-plated
- Seal: neoprene
- Clamping insert: polyamide 6
- O-ring: NBR
- Ambient temperature: -40°C ... +100°C
- Degree of protection: IP69K
- Strain relief: integrated according to EN 50262

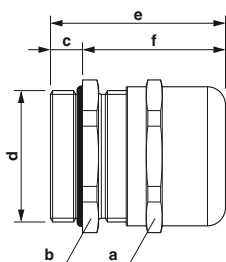

Brass cable gland

QCRV.E320158

**Ordering data**

Thread type	Clamping area [mm]	Dimensions [mm]						
		a	b	c	d	e	f	g
M12	3.00 - 6.50	14.00	14.00	6.00	12.00	27.80	21.80	-
M16	5.00 - 10.00	20.00	20.00	7.00	16.00	34.50	27.50	-
M20	6.00 - 12.00	22.00	22.00	8.00	20.00	37.50	29.50	-
M25	11.00 - 17.00	27.00	27.00	8.00	25.00	40.00	32.00	-
M32	15.00 - 21.00	34.00	34.00	8.00	32.00	43.00	35.00	-
M40	19.00 - 28.00	43.00	43.00	9.00	40.00	53.70	44.70	-
M50	27.00 - 38.00	58.00	58.00	9.00	50.00	61.00	52.00	-
M63	34.00 - 44.00	64.00	68.00	14.00	63.00	65.20	51.20	-

Type	Order No.	Pcs. / Pkt.
G-INS-M12-S68N-NNES-S	1411160	10
G-INS-M16-S68N-NNES-S	1411162	10
G-INS-M20-S68N-NNES-S	1411163	5
G-INS-M25-M68N-NNES-S	1411165	5
G-INS-M32-M68N-NNES-S	1411166	5
G-INS-M40-M68N-NNES-S	1411167	5
G-INS-M50-L68N-NNES-S	1411168	1
G-INS-M63-L68N-NNES-S	1411169	1

**Brass counter nut, metric, EN 60423**

- Material: brass, nickel-plated
- Ambient temperature: -70°C ... +220°C

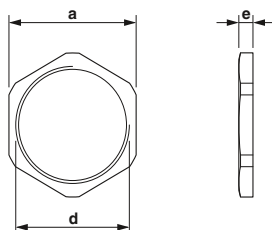

Brass counter nut

**Ordering data**

Thread type	Clamping area [mm]	Dimensions [mm]						
		a	b	c	d	e	f	g
M12	-	15.00	-	-	12.00	2.80	-	-
M16	-	19.00	-	-	16.00	2.80	-	-
M20	-	24.00	-	-	20.00	3.00	-	-
M25	-	30.00	-	-	25.00	3.50	-	-
M32	-	36.00	-	-	32.00	4.00	-	-
M40	-	46.00	-	-	40.00	5.00	-	-
M50	-	57.00	-	-	50.00	5.00	-	-
M63	-	70.00	-	-	63.00	6.00	-	-

Type	Order No.	Pcs. / Pkt.
A-INL-M12-N-S	1411240	100
A-INL-M16-N-S	1411241	100
A-INL-M20-N-S	1411242	100
A-INL-M25-N-S	1411243	100
A-INL-M32-N-S	1411244	100
A-INL-M40-N-S	1411246	50
A-INL-M50-N-S	1411247	25
A-INL-M63-N-S	1411248	25

## Installation and mounting material - cable glands

### Brass cable gland, Pg, EN 40430

- Material: brass, nickel-plated
- Seal: neoprene
- Clamping insert: polyamide 6
- O-ring: NBR
- Ambient temperature:  
-40°C ... +100°C
- Degree of protection: IP68/IP69K
- Strain relief: integrated according to EN 50262

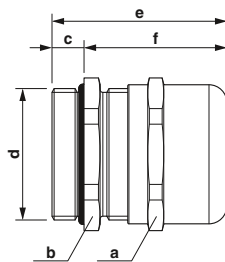

Brass cable gland

QCRV.E320158

Thread type	Clamping area [mm]	Dimensions [mm]						
		a	b	c	d	e	f	g
Pg7	3.00 - 6.50	14.00	14.00	6.00	12.50	27.80	21.80	-
Pg9	4.00 - 8.00	17.00	17.00	6.00	15.20	28.20	22.20	-
Pg11	5.00 - 10.00	20.00	20.00	6.00	18.60	21.00	15.00	-
Pg13.5	6.00 - 12.00	22.00	22.00	6.50	20.40	30.50	24.00	-
Pg16	10.00 - 14.00	24.00	24.00	6.50	22.50	33.90	27.40	-
Pg21	13.00 - 18.00	30.00	30.00	7.20	28.30	38.50	31.30	-
Pg29	18.00 - 25.00	40.00	40.00	8.00	37.00	46.90	38.90	-
Pg36	22.00 - 32.00	50.00	50.00	9.00	47.00	57.20	48.20	-
Pg42	30.00 - 38.00	58.00	58.00	12.00	54.00	60.00	48.00	-
Pg48	34.00 - 44.00	64.00	64.00	14.00	59.30	63.40	49.40	-

### Ordering data

Type	Order No.	Pcs. / Pkt.
G-INS-PG7-S68N-NNES-S	1411170	10
G-INS-PG9-S68N-NNES-S	1411171	10
G-INS-PG11-S68N-NNES-S	1411172	5
G-INS-PG13,5-S68N-NNES-S	1411173	5
G-INS-PG16-S68N-NNES-S	1411174	5
G-INS-PG21-M68N-NNES-S	1411175	5
G-INS-PG29-M68N-NNES-S	1411176	5
G-INS-PG36-L68N-NNES-S	1411178	5
G-INS-PG42-L68N-NNES-S	1411179	1
G-INS-PG48-L68N-NNES-S	1411181	1

### Brass counter nut, Pg, EN 40430

- Material: brass, nickel-plated
- Ambient temperature:  
-70°C ... +220°C

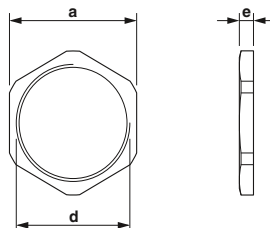

Brass counter nut

Thread type	Clamping area [mm]	Dimensions [mm]						
		a	b	c	d	e	f	g
Pg7	-	15.00	-	-	12.50	2.80	-	-
Pg9	-	18.00	-	-	15.20	2.80	-	-
Pg11	-	21.00	-	-	18.60	3.00	-	-
Pg13.5	-	23.00	-	-	20.40	3.00	-	-
Pg16	-	26.00	-	-	22.50	3.00	-	-
Pg21	-	32.00	-	-	28.30	3.50	-	-
Pg29	-	41.00	-	-	37.00	4.00	-	-
Pg36	-	51.00	-	-	47.00	5.00	-	-
Pg42	-	60.00	-	-	54.00	5.00	-	-
Pg48	-	64.00	-	-	59.30	5.50	-	-

### Ordering data

Type	Order No.	Pcs. / Pkt.
A-INL-PG7-N-S	1411255	100
A-INL-PG9-N-S	1411256	100
A-INL-PG11-N-S	1411257	100
A-INL-PG13,5-N-S	1411259	100
A-INL-PG16-N-S	1411260	100
A-INL-PG21-N-S	1411262	100
A-INL-PG29-N-S	1411263	50
A-INL-PG36-N-S	1411264	50
A-INL-PG42-N-S	1411265	25
A-INL-PG48-N-S	1411266	25



**Brass cable gland,  
NPT, ANSI B1.20.1**

- Material: brass, nickel-plated
- Seal: neoprene
- Clamping insert: polyamide 6
- O-ring: NBR
- Ambient temperature:  
-40°C ... +100°C
- Degree of protection: IP68, 5 bar
- Strain relief: integrated according to  
EN 50262

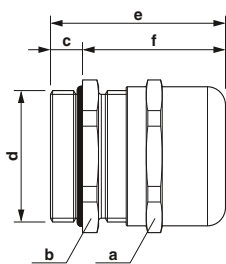

**Brass cable gland**

**UL**  
QCRV2.E320158

**Ordering data**

Thread type	Clamping area [mm]	Dimensions [mm]						
		a	b	c	d	e	f	g
NPT3/8"	5.00 - 10.00	17.00	19.00	11.50	16.00	34.50	23.00	-
NPT1/2"	10.00 - 14.00	22.00	22.00	13.00	21.00	39.00	26.00	-
NPT3/4"	13.00 - 18.00	30.00	30.00	13.00	29.00	48.50	35.50	-
NPT1"	18.00 - 25.00	40.00	43.00	13.00	32.00	56.00	43.00	-

Type	Order No.	Pcs. / Pkt.
G-INS-NPT3/8-S68L-NNES-S	1411182	10
G-INS-NPT1/2-S68L-NNES-S	1411183	10
G-INS-NPT3/4-M68L-NNES-S	1411184	5
G-INS-NPT1-M68L-NNES-S	1411185	5

## Installation and mounting material - cable glands

### Brass EMC cable gland, metric, EN 60423

- Material: brass, nickel-plated
- Seal: CR/NBR
- Clamping insert: polyamide 6
- Contact spring: stainless steel
- O-ring: NBR
- Ambient temperature (operation): -20°C ... +100°C
- Degree of protection: IP68
- Strain relief: integrated according to EN 50262

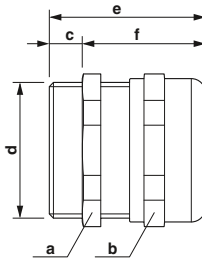

Brass cable gland



QCRV.E140310 / QCRV2.E140310

Thread type	Clamping area [mm]	Dimensions [mm]						
		a	b	c	d	e	f	g
M12	3.00 - 6.50	14.00	14.00	6.00	12.00	28.00	22.00	-
M16	5.00 - 9.00	17.00	17.00	5.00	16.00	30.00	25.00	-
M20	9.00 - 13.00	22.00	22.00	6.00	20.00	33.50	27.50	-
M25	11.00 - 16.00	27.00	27.00	7.00	25.00	36.50	29.50	-
M32	14.00 - 21.00	34.00	34.00	8.00	32.00	38.00	30.00	-
M40	19.00 - 27.00	43.00	43.00	8.00	40.00	41.00	33.00	-
M50	24.00 - 35.00	55.00	55.00	9.00	50.00	49.50	40.50	-
M63	32.00 - 42.00	65.00	65.00	10.00	63.00	52.50	42.50	-

### Ordering data

Type	Order No.	Pcs. / Pkt.
G-INSEC-M12-S68N-NCRS-S	1411187	10
G-INSEC-M16-S68N-NCRS-S	1411188	10
G-INSEC-M20-S68N-NCRS-S	1411189	5
G-INSEC-M25-S68N-NCRS-S	1411190	5
G-INSEC-M32-M68N-NCRS-S	1411191	5
G-INSEC-M40-M68N-NCRS-S	1411192	5
G-INSEC-M50-L68N-NCRS-S	1411193	1
G-INSEC-M63-L68N-NCRS-S	1411194	1

### Brass counter nut, metric, EN 60423, ribbed

- Material: brass, nickel-plated
- Ambient temperature: -70°C ... +220°C
- Version: ribbed

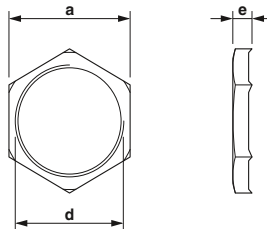

Brass counter nut

Thread type	Clamping area [mm]	Dimensions [mm]						
		a	b	c	d	e	f	g
M12	-	15.00	-	-	12.00	4.70	-	-
M16	-	19.00	-	-	16.00	4.70	-	-
M20	-	24.00	-	-	20.00	4.70	-	-
M25	-	30.00	-	-	25.00	5.20	-	-
M32	-	36.00	-	-	32.00	5.70	-	-
M40	-	46.00	-	-	40.00	6.50	-	-
M50	-	57.00	-	-	50.00	6.50	-	-
M63	-	70.00	-	-	63.00	7.00	-	-

### Ordering data

Type	Order No.	Pcs. / Pkt.
A-INLE-M12-N-S	1411267	100
A-INLE-M16-N-S	1411268	100
A-INLE-M20-N-S	1411269	100
A-INLE-M25-N-S	1411270	50
A-INLE-M32-N-S	1411271	50
A-INLE-M40-N-S	1411272	50
A-INLE-M50-N-S	1411273	10
A-INLE-M63-N-S	1411274	10

**Brass EMC cable gland,  
Pg, EN 40430**

- Material: brass, nickel-plated
- Seal: neoprene
- Clamping insert: polyamide 6
- Contact spring: copper beryllium
- O-ring: NBR
- Ambient temperature:  
-40°C ... +100°C
- Degree of protection: IP68
- Strain relief: integrated according to EN 50262

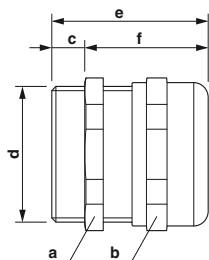

Brass cable gland

**UL**  
QCRV2.E320158

Thread type	Clamping area [mm]	Dimensions [mm]						
		a	b	c	d	e	f	g
Pg7	3.00 - 6.50	14.00	14.00	6.00	12.50	27.00	21.00	-
Pg9	4.00 - 8.00	17.00	17.00	6.00	15.20	29.00	23.00	-
Pg11	5.00 - 10.00	20.00	20.00	6.00	18.60	30.00	24.00	-
Pg13.5	6.00 - 12.00	22.00	22.00	6.50	20.40	30.00	23.50	-
Pg16	10.00 - 14.00	24.00	24.00	6.50	22.50	33.90	27.40	-
Pg21	13.00 - 18.00	30.00	30.00	7.20	28.30	38.50	31.30	-
Pg29	18.00 - 25.00	40.00	40.00	8.00	37.00	47.00	39.00	-
Pg36	22.00 - 32.00	50.00	50.00	9.00	47.00	57.00	48.00	-
Pg42	30.00 - 38.00	58.00	58.00	12.00	54.00	60.00	48.00	-
Pg48	34.00 - 44.00	64.00	64.00	14.00	59.30	65.00	51.00	-

Ordering data		
Type	Order No.	Pcs. / Pkt.
G-INSEC-PG7-S68N-NNES-S	1411195	10
G-INSEC-PG9-S68N-NNES-S	1411196	10
G-INSEC-PG11-S68N-NNES-S	1411197	5
G-INSEC-PG13,5-S68N-NNES-S	1411198	5
G-INSEC-PG16-S68N-NNES-S	1411199	5
G-INSEC-PG21-M68N-NNES-S	1411200	5
G-INSEC-PG29-M68N-NNES-S	1411201	5
G-INSEC-PG36-L68N-NNES-S	1411202	5
G-INSEC-PG42-L68N-NNES-S	1411203	1
G-INSEC-PG48-L68N-NNES-S	1411204	1

**Brass counter nut,  
Pg, EN 40430, ribbed**

- Material: brass, nickel-plated
- Ambient temperature:  
-70°C ... +220°C
- Version: ribbed

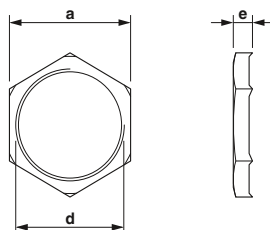

Brass counter nut

Thread type	Clamping area [mm]	Dimensions [mm]						
		a	b	c	d	e	f	g
Pg7	-	15.00	-	-	12.50	4.70	-	-
Pg9	-	18.00	-	-	15.20	4.70	-	-
Pg11	-	21.00	-	-	18.60	4.70	-	-
Pg13.5	-	23.00	-	-	20.40	4.70	-	-
Pg16	-	26.00	-	-	22.50	4.70	-	-
Pg21	-	32.00	-	-	28.30	5.20	-	-
Pg29	-	41.00	-	-	37.00	5.70	-	-
Pg36	-	51.00	-	-	47.00	6.50	-	-

Ordering data		
Type	Order No.	Pcs. / Pkt.
A-INLE-PG7-N-S	1411275	100
A-INLE-PG9-N-S	1411276	100
A-INLE-PG11-N-S	1411277	100
A-INLE-PG13,5-N-S	1411278	100
A-INLE-PG16-N-S	1411279	100
A-INLE-PG21-N-S	1411280	50
A-INLE-PG29-N-S	1411281	50
A-INLE-PG36-N-S	1411282	50

## Installation and mounting material - cable glands

### Brass cable gland, metric, Ex protection

Cable glands for unarmored and braided cables provide flameproof (type "d"), increased safety (type "e"), and restricted breathing (type "nR") hazardous area protection to IP66, IP67, and IP68.

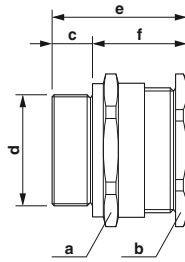

Brass cable gland

Ex: SIRI13ATEX1068X / IECEx SIR13.0023X

#### General data

Cable gland material  
Seal material  
O-ring material  
Ambient temperature (operation)

#### Technical data

Nickel-plated brass  
Thermoplastic elastomers  
Viton  
-60°C ... 130°C

Thread type	Clamping area [mm]	Dimensions [mm]						
		a	b	c	d	e	f	g
M20	6.50 - 14.00	27.00	27.00	15.00	20.00	39.00	24.00	-
M25	11.10 - 20.00	36.00	36.00	15.00	25.00	41.00	26.00	-
M32	17.00 - 26.30	41.00	41.00	15.00	32.00	42.00	27.00	-
M40	23.50 - 32.20	50.00	50.00	15.00	40.00	43.00	28.00	-
M50	35.60 - 44.10	60.00	60.00	15.00	50.00	45.00	30.00	-
M63	47.20 - 56.00	75.00	75.00	15.00	63.00	45.00	30.00	-

#### Ordering data

Type	Order No.	Pcs. / Pkt.
G-ESS-M20-S66L-NTES-S	1411075	20
G-ESS-M25-M66L-NTES-S	1411077	20
G-ESS-M32-M66L-NTES-S	1411079	10
G-ESS-M40-L66L-NTES-S	1411081	2
G-ESS-M50-L66L-NTES-S	1411084	2
G-ESS-M63-L66L-NTES-S	1411086	2

### Stainless steel cable gland, metric, Ex protection

Cable glands for unarmored and braided cables provide flameproof (type "d"), increased safety (type "e"), and restricted breathing (type "nR") hazardous area protection to IP66, IP67, and IP68.

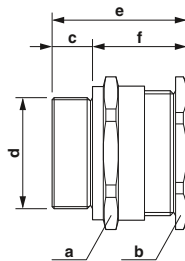

Stainless steel cable gland

Ex: SIRI13ATEX1068X / IECEx SIR13.0023X

#### General data

Cable gland material  
Seal material  
O-ring material  
Ambient temperature (operation)

#### Technical data

High-grade steel  
Thermoplastic elastomers  
Viton  
-60°C ... 130°C

Thread type	Clamping area [mm]	Dimensions [mm]						
		a	b	c	d	e	f	g
M20	6.50 - 14.00	27.00	27.00	15.00	20.00	39.00	24.00	-
M25	11.10 - 20.00	36.00	36.00	15.00	25.00	41.00	26.00	-
M32	17.00 - 26.30	41.00	41.00	15.00	32.00	42.00	27.00	-
M40	23.50 - 32.20	50.00	50.00	15.00	40.00	43.00	28.00	-
M50	35.60 - 44.10	60.00	60.00	15.00	50.00	45.00	30.00	-
M63	47.20 - 56.00	75.00	75.00	15.00	63.00	45.00	30.00	-

#### Ordering data

Type	Order No.	Pcs. / Pkt.
G-ESS-M20-S66L-STES-S	1411076	20
G-ESS-M25-M66L-STES-S	1411078	20
G-ESS-M32-M66L-STES-S	1411080	10
G-ESS-M40-L66L-STES-S	1411082	2
G-ESS-M50-L66L-STES-S	1411085	2
G-ESS-M63-L66L-STES-S	1411087	2

**Brass cable gland, metric, Ex protection**

Cable glands for armored cables provide increased safety (type "e") hazardous area protection to IP66, IP67, and IP68.

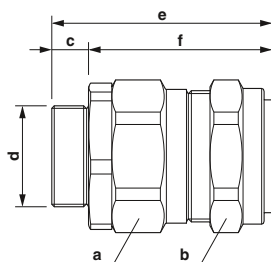

Brass cable gland

Ex: SIR13ATEX1070X / IECEx SIR13.0025X

**General data**

Cable gland material  
Seal material  
O-ring material  
Ambient temperature (operation)

**Technical data**

Nickel-plated brass  
Thermoplastic elastomers  
Viton  
-60°C ... 130°C

Thread type	Clamping area [mm]	Dimensions [mm]						
		a	b	c	d	e	f	g
M20	9.50 - 15.90	24.00	24.00	15.00	20.00	73.50	58.50	-
M20	12.50 - 20.90	30.50	30.50	15.00	20.00	75.50	60.50	-
M25	18.20 - 26.20	37.50	37.50	15.00	25.00	82.50	67.50	-
M32	23.70 - 33.90	46.00	46.00	15.00	32.00	84.50	69.50	-
M40	27.90 - 40.40	55.00	55.00	15.00	40.00	93.00	78.00	-
M50	40.40 - 53.10	70.00	70.00	15.00	50.00	95.50	80.50	-
M63	54.60 - 65.90	80.00	80.00	15.00	63.00	107.00	92.00	-

**Ordering data**

Type	Order No.	Pcs. / Pkt.
G-ESSWU-M20S-S66L-NTES-S	1411088	10
G-ESSWU-M20-M66L-NTES-S	1411090	10
G-ESSWU-M25-M66L-NTES-S	1411092	10
G-ESSWU-M32-L66L-NTES-S	1411094	5
G-ESSWU-M40-L66L-NTES-S	1411097	1
G-ESSWU-M50-L66L-NTES-S	1411100	1
G-ESSWU-M63-L66L-NTES-S	1411102	1

**Stainless steel cable gland, metric, Ex protection**

Cable glands for armored cables provide flameproof (type "d"), increased safety (type "e"), and restricted breathing (type "nR") hazardous area protection to IP66, IP67, and IP68.

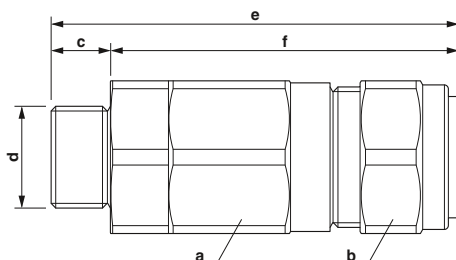

Stainless steel cable gland

Ex: SIR13ATEX1073X / IECEx SIR13.0028X

**General data**

Cable gland material  
Seal material  
O-ring material  
Ambient temperature (operation)

**Technical data**

High-grade steel  
Thermoplastic elastomers  
Viton  
-60°C ... 130°C

Thread type	Clamping area [mm]	Dimensions [mm]						
		a	b	c	d	e	f	g
M20	9.50 - 15.90	24.00	24.00	15.00	20.00	73.50	58.50	-
M20	12.50 - 20.90	30.50	30.50	15.00	20.00	75.50	60.50	-
M25	18.20 - 26.20	37.50	37.50	15.00	25.00	82.50	67.50	-
M32	23.70 - 33.90	46.00	46.00	15.00	32.00	84.50	69.50	-
M40	27.90 - 40.40	55.00	55.00	15.00	40.00	93.00	78.00	-
M50	40.40 - 53.10	70.00	70.00	15.00	50.00	95.50	80.50	-
M63	54.60 - 65.90	80.00	80.00	15.00	63.00	107.00	92.00	-

**Ordering data**

Type	Order No.	Pcs. / Pkt.
G-EDSWU-M20S-S66L-STES-S	1411089	10
G-EDSWU-M20-M66L-STES-S	1411091	10
G-EDSWU-M25-M66L-STES-S	1411093	10
G-EDSWU-M32-L66L-STES-S	1411095	5
G-EDSWU-M40-L66L-STES-S	1411099	1
G-EDSWU-M50-L66L-STES-S	1411101	1
G-EDSWU-M63-L66L-STES-S	1411103	1

## Installation and mounting material - cable glands

### Brass screw plug, metric, Ex protection

Screw plugs provide IP66 and IP68 protection when installed with an entry thread ring, sealing unused cable entries in flameproof (type "d") and increased safety (type "e") installations.

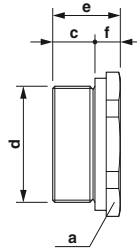

Brass screw plug

Ex:   
SIRA01ATEX1284U / IECEx SIR07.0083X

#### General data

Material  
Ambient temperature (operation)

#### Technical data

Nickel-plated brass  
-60°C ... 200°C

Thread type	Clamping area [mm]	Dimensions [mm]						
		a	b	c	d	e	f	g
M20	-	24.00	-	15.00	20.00	24.00	9.00	-
M25	-	30.00	-	15.00	25.00	24.00	9.00	-
M32	-	36.00	-	15.00	32.00	24.00	9.00	-
M40	-	46.00	-	15.00	40.00	24.00	9.00	-
M50	-	55.00	-	15.00	50.00	24.00	9.00	-
M63	-	65.00	-	15.00	63.00	24.00	9.00	-

#### Ordering data

Type	Order No.	Pcs. / Pkt.
A-EXSH-M20-68L-N-S	1411104	20
A-EXSH-M25-68L-N-S	1411107	20
A-EXSH-M32-68L-N-S	1411109	10
A-EXSH-M40-68L-N-S	1411111	5
A-EXSH-M50-68L-N-S	1411113	2
A-EXSH-M63-68L-N-S	1411115	1

### Stainless steel screw plug, metric, Ex protection

Screw plugs provide IP66 and IP68 protection when installed with an entry thread ring, sealing unused cable entries in flameproof (type "d") and increased safety (type "e") installations.

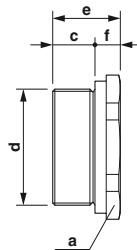

Stainless steel screw plug

Ex:   
SIRA01ATEX1284U / IECEx SIR07.0083X

#### General data

Material  
Ambient temperature (operation)

#### Technical data

High-grade steel  
-60°C ... 200°C

Thread type	Clamping area [mm]	Dimensions [mm]						
		a	b	c	d	e	f	g
M20	-	24.00	-	15.00	20.00	24.00	9.00	-
M25	-	30.00	-	15.00	25.00	24.00	9.00	-
M32	-	36.00	-	15.00	32.00	24.00	9.00	-
M40	-	46.00	-	15.00	40.00	24.00	9.00	-
M50	-	55.00	-	15.00	50.00	24.00	9.00	-
M63	-	65.00	-	15.00	63.00	24.00	9.00	-

#### Ordering data

Type	Order No.	Pcs. / Pkt.
A-EXSH-M20-68L-S-S	1411105	20
A-EXSH-M25-68L-S-S	1411108	20
A-EXSH-M32-68L-S-S	1411110	10
A-EXSH-M40-68L-S-S	1411112	5
A-EXSH-M50-68L-S-S	1411114	2
A-EXSH-M63-68L-S-S	1411116	1

**Brass pressure compensation, metric, Ex protection**

Breather/drain plugs for increased safety (type "e") provide superior ventilation for devices. They are designed to act as a pressure compensation element preventing moisture build-up to IP66.

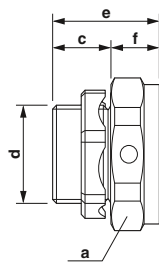

**Brass pressure compensation**

Ex: SIRI0A10ATEX1307U / IECEx SIR10.0149U

General data	
Material	
Ambient temperature (operation)	

**Technical data**

Nickel-plated brass  
-20°C ... 130°C

Thread type	Clamping area [mm]	Dimensions [mm]						
		a	b	c	d	e	f	g
M20	-	30.00	-	15.00	20.00	28.00	13.00	-
M25	-	36.00	-	15.00	25.00	28.00	13.00	-

**Ordering data**

Type	Order No.	Pcs. / Pkt.
A-EXB-20-66L-N-S	1411117	5
A-EXB-25-66L-N-S	1411120	5

**Stainless steel pressure compensation, metric, Ex protection**

Breather/drain plugs for increased safety (type "e") provide superior ventilation for devices. They are designed to act as a pressure compensation element preventing moisture build-up to IP66.

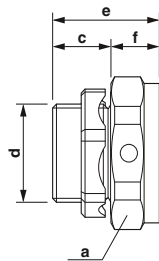

**Stainless steel pressure compensation**

Ex: SIRI0A10ATEX1307U / IECEx SIR10.0149U

General data	
Material	
Ambient temperature (operation)	

**Technical data**

High-grade steel  
-20°C ... 130°C

Thread type	Clamping area [mm]	Dimensions [mm]						
		a	b	c	d	e	f	g
M20	-	30.00	-	15.00	20.00	28.00	13.00	-
M25	-	36.00	-	15.00	25.00	28.00	13.00	-

**Ordering data**

Type	Order No.	Pcs. / Pkt.
A-EXB-20-66L-S-S	1411118	5
A-EXB-25-66L-S-S	1411121	5

## Installation and mounting material - cable glands

### Stainless steel counter nut, metric

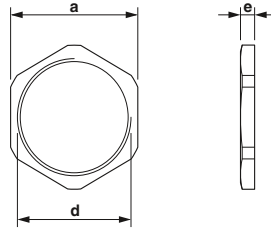

Stainless steel counter nut

#### General data

Material  
Ambient temperature (operation)

High-grade steel  
-70°C ... 220°C

#### Technical data

#### Ordering data

Thread type	Clamping area [mm]	Dimensions [mm]						
		a	b	c	d	e	f	g
M20	-	24.00	-	-	20.00	3.00	-	-
M25	-	30.00	-	-	25.00	3.50	-	-
M32	-	36.00	-	-	32.00	4.00	-	-
M40	-	46.00	-	-	40.00	5.00	-	-
M50	-	55.00	-	-	50.00	5.00	-	-
M63	-	70.00	-	-	63.00	6.00	-	-

Type	Order No.	Pcs. / Pkt.
A-INL-M20-S-S	1411249	10
A-INL-M25-S-S	1411250	10
A-INL-M32-S-S	1411251	5
A-INL-M40-S-S	1411252	5
A-INL-M50-S-S	1411253	2
A-INL-M63-S-S	1411254	1

### Sealing washer, metric

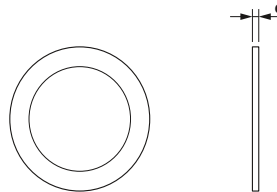

Sealing washer

#### General data

Material  
Ambient temperature (operation)

Nylon  
-70°C ... 100°C

#### Technical data

#### Ordering data

Thread type	Clamping area [mm]	Dimensions [mm]						
		a	b	c	d	e	f	g
M20	-	-	-	-	-	2.00	-	-
M25	-	-	-	-	-	2.00	-	-
M32	-	-	-	-	-	2.00	-	-
M40	-	-	-	-	-	2.00	-	-
M50	-	-	-	-	-	2.00	-	-
M63	-	-	-	-	-	2.00	-	-

Type	Order No.	Pcs. / Pkt.
A-SEW-20-P-W	1411283	20
A-SEW-25-P-W	1411284	20
A-SEW-32-P-W	1411285	20
A-SEW-40-P-W	1411286	20
A-SEW-50-P-W	1411287	10
A-SEW-63-P-W	1411288	10





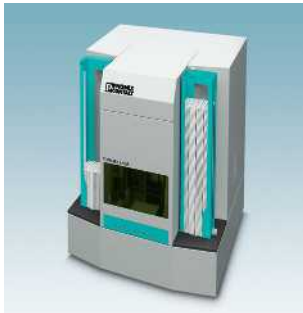

Desktop laser marker

**TOPMARK LASER**

Page 244



Stainless steel or aluminum laser cable marking

**LS-WMTB ...**

Page 246



Stainless steel or aluminum laser device marking

**LS-EMSP ...**  
**LS-EMLP ...**  
**LS-EMP ...**

Page 250  
Page 252  
Page 254



Plastic laser device marking

**LS-EMLP ...**

Page 256



Laser device marking, laser foil

**LS-EML ...**

Page 262



Terminal marking for terminal blocks from other manufacturers

**UM1-TM ..., UM1U-TM ...,**  
**UM1-TMF ...**

Page 264



Terminal marking, marker strips

**TMT ...**

Page 266



UniCard conductor and cable marking

**UCT-WMCO ...**  
**UCT-WMTBA ...**

Page 268  
Page 270



Plastic cable markers

**KMK HP ...**  
**KMK UV ...**

Page 272  
Page 274



UniCard device marking, for applications in process technology and process engineering

**UC-EMLP ... EX**  
**EML ... EX**

Page 276  
Page 277



UniSheet device marking, with very high adhesive strength

**US-EMLP-HA ...**

Page 278



System marking, RFID system

Handheld  
**RFMARK HF / UHF**  
Marking  
**UCT-PMLP ...**  
**UCT-PMP ...**

Page 280  
Page 282  
Page 284



Wireless exchange of printing data

**MARKING system app and  
MINI FD BLUETOOTH**

Page 288



Marking solutions with  
planning and marking software

**Customer-specific printing service  
CLIP PROJECT ...**

Page 290



Crimping tool, portable hand-held device

**CRIMPHANDY 1.0 mm**

Page 292



Customized tool sets and  
personalized tools

**TOOL ... CUS  
CRIMPFIX ... CUS  
WIREFOX ... CUS**

Page 296

Page 298

Page 301

# Marking systems, tools, and mounting material

Optimize all of the processes involved in the setup, installation, and maintenance of your control cabinets and switchgear. We offer optimally coordinated products from our marking, tool, and mounting material ranges.



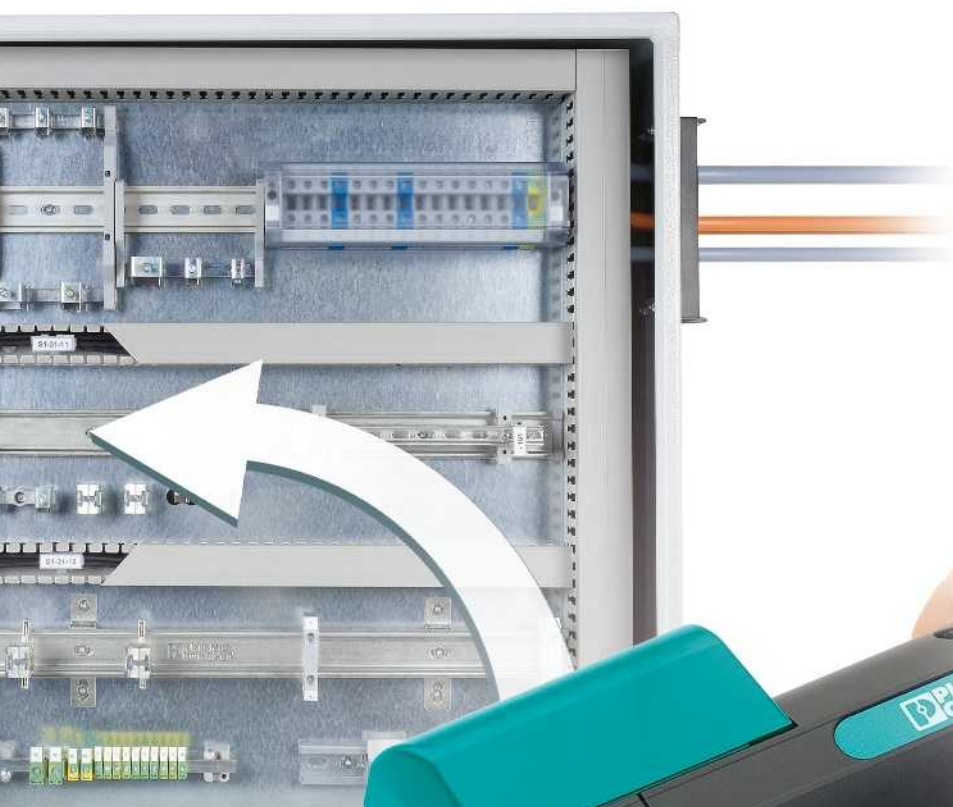

### MARKING system

MARKING system provides the perfect solutions for terminal, conductor, cable, device, and system marking. It places at your disposal the CLIP PROJECT planning and marking software, various printing systems, and a wide variety of marking materials.

### TOOL fox

TOOL fox is the complete range of professional processing and measuring tools. Designed for use in all processes in electrical engineering, the tools and automatic devices impress with their optimum handling and quality.



### CABINET add-on

CABINET add-on stands for modern control cabinet technology. DIN rails and end brackets ensure the secure attachment of terminal blocks and modules, while shield connection clamps guarantee EMC-compliant wiring and cable ducts bring order to the control cabinet.

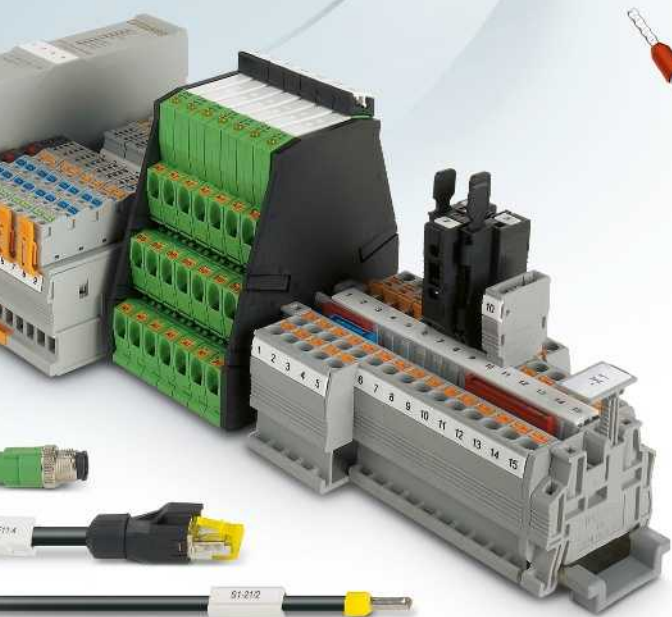

### Service

Choose the complete range. Working to your specifications, we will manufacture and label terminal strips and complete terminal boxes or modules for direct installation in your application.

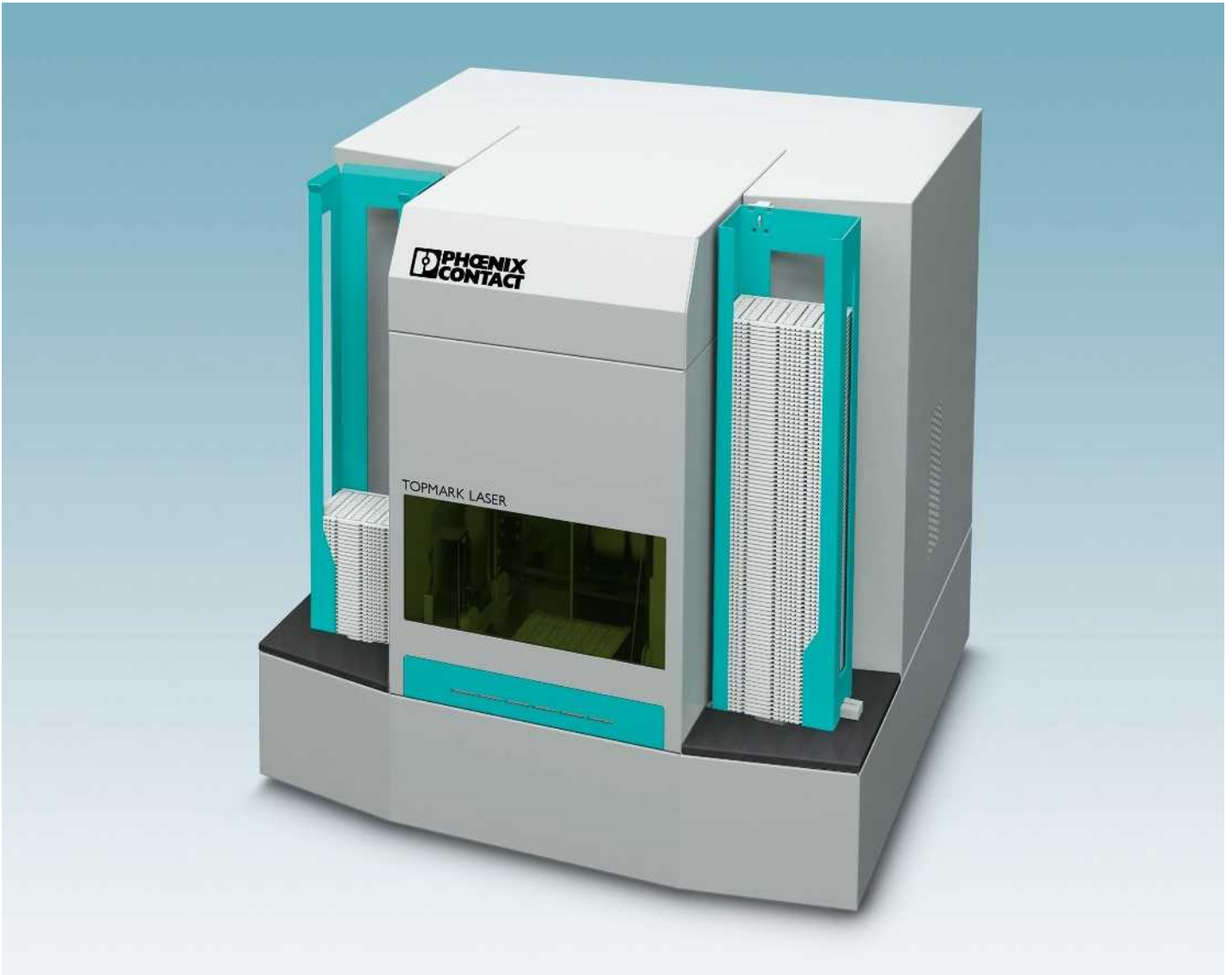

The TOPMARK LASER marking system provides you with the flexibility to implement the requirements of challenging industrial identification. With a comprehensive product range of over 400 markers for your terminal, conductor, cable, and device marking, you will find the ideal solution for your application.



The stainless steel material can be marked in two ways: through material removal (engraving) or annealing marking. The latter involves changing the color of the material while the material surface remains level.



You can easily mark all materials in the UCT product range with the automated material handling of the TOPMARK LASER. The laser marker automatically detects the material sheets fed in. This means that you can carry out marking quickly and effectively - without time-consuming parameter settings.

**TOPMARK LASER,  
desktop laser marker  
for card material and material sheets**



Direct laser marking

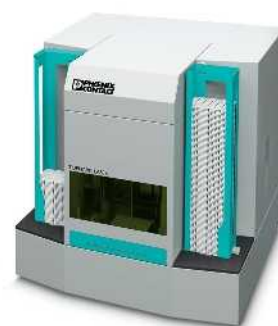

Integration in the CLIP PROJECT planning and marking software makes the TOPMARK LASER the fastest desktop laser marker in its class - and the easiest to use. You can now mark all materials without special knowledge of laser technology.

- Wide range of materials comprising stainless steel, aluminum, ABS, polyacrylics, and polycarbonate
- Preset optimized laser parameters are available for all material types
- Automatic material detection enables fast and effective marking
- The material sheet can be easily reused by creating a project code

Dimensions	
	[mm]
General data	
Temperature range	[°C]
Marking method	Direct laser marking
Laser system	Ytterbium fiber laser, pulsed, 1064 nm
Laser class	Laser class 1 according to EN 60825-1 classification
Interfaces	10/100 Mbps Ethernet
Power supply	[V]
Weight	[kg]
Operating systems	MS Windows XP SP3, MS Windows Vista, MS Windows 7 (32/64-bit), MS Windows 8 (32/64-bit)
Power consumption	[W]
CW laser power (continuous wave)	[W]

Technical data		
Width	Length	Height
664	630	682

Description	Color
<b>Laser marker and MARKING NOTEBOOK</b> , incl. CLIP PROJECT professional software and installed drivers, user manual, sheet hopper, card hopper and 230 V extraction unit	
With German operating system and German keyboard	

Ordering data		
Type	Order No.	Pcs. / Pkt.
TOPMARK LASER	0831831	1

<b>Carriage</b> , for accommodating TOPMARK LASER, extraction unit, and MARKING NOTEBOOK
<b>Sheet hopper</b> , for TOPMARK LASER
<b>Card hopper</b> , for TOPMARK LASER

Accessories		
Type	Order No.	Pcs. / Pkt.
TOPMARK LASER STATION	0831835	1
TOPMARK LASER-MAG SHEET	0831836	1
TOPMARK LASER-MAG CARD	0831837	1

## Marking material for TOPMARK LASER - MARKING system

### Stainless steel and aluminum cable marking for assembly with cable binders



- The LS-WMTB ... product range is available in stainless steel (V4A) or aluminum and includes markers that can be quickly and easily fitted with cable binders
- The LS-WMTB-V4A ... group is particularly characterized by its high resistance to salt water, chloride, and solvents and it is therefore also suitable for the most demanding industrial requirements



- Automatic material detection enables fast and effective marking without time-consuming parameter settings
- The material sheet can be easily reused by creating a project code
- **Designation example:**  
**LS-WMTB-V4A (29x8)**  
Lettering field size: 29 x 8 mm



- The use of modern laser technology creates highly resistant and permanent marking, which can only be removed by destroying the material
- The LS-WMTB-V4A ... product group can be marked in two ways: by engraving or annealing
- Labeling service: Phoenix Contact can custom-label all markers according to your requirements

Can be marked using:



Direct laser marking

#### General data

Can be marked with  
Material  
Wipe resistance  
Components

#### Description

**Stainless steel label**, for assembly with cable binders, conductor diameter  
36-section, > 2.9 mm Ø  
16-section, > 4.6 mm Ø  
16-section, > 4.6 mm Ø  
8-section, > 4.6 mm Ø

**Aluminum label**, for assembly with cable binders, conductor diameter  
36-section, > 2.9 mm Ø  
16-section, > 4.6 mm Ø  
16-section, > 4.6 mm Ø  
8-section, > 4.6 mm Ø

**Stainless steel label**, for assembly with cable binders, conductor diameter, **marked according to customer specifications<sup>1)</sup>**  
36-section, > 2.9 mm Ø  
16-section, > 4.6 mm Ø  
16-section, > 4.6 mm Ø  
8-section, > 4.6 mm Ø

**Aluminum label**, for assembly with cable binders, conductor diameter, **marked according to customer specifications<sup>1)</sup>**  
36-section, > 2.9 mm Ø  
16-section, > 4.6 mm Ø  
16-section, > 4.6 mm Ø  
8-section, > 4.6 mm Ø

Sheet hopper, for TOPMARK LASER

#### Notes:

For matching stainless steel cable binders, see page 580 in main catalog 5 or the product area on our website at [phoenixcontact.net/products](http://phoenixcontact.net/products).

<sup>1)</sup> For an ordering example, see page 358 in main catalog 5.





Stainless steel, material thickness: 0.5 mm



Aluminum, material thickness: 0.8 mm



Aluminum, black, material thickness: 0.8 mm

Technical data		
TOPMARK LASER V4A DIN EN 61010-1 (VDE 0411-1) Free from silicone, halogen, and cadmium		
Ordering data		
Type	Order No.	Pcs. / Pkt.
LS-WMTB-V4A (29X8)	0831516	5
LS-WMTB-V4A (40X15)	0831517	5
LS-WMTB-V4A (60X15)	0831518	5
LS-WMTB-V4A (100X15)	0831519	5
LS-WMTB-V4A (29X8) CUS	0831802	1
LS-WMTB-V4A (40X15) CUS	0831803	1
LS-WMTB-V4A (60X15) CUS	0831804	1
LS-WMTB-V4A (100X15) CUS	0831805	1
Accessories		
TOPMARK LASER-MAG SHEET	0831836	1

Technical data		
TOPMARK LASER Aluminum DIN EN 61010-1 (VDE 0411-1) Free from silicone, halogen, and cadmium		
Ordering data		
Type	Order No.	Pcs. / Pkt.
LS-WMTB-AL (29X8)	0831500	5
LS-WMTB-AL (40X15)	0831501	5
LS-WMTB-AL (60X15)	0831502	5
LS-WMTB-AL (100X15)	0831503	5
LS-WMTB-AL (29X8) CUS	0831786	1
LS-WMTB-AL (40X15) CUS	0831787	1
LS-WMTB-AL (60X15) CUS	0831788	1
LS-WMTB-AL (100X15) CUS	0831789	1
Accessories		
TOPMARK LASER-MAG SHEET	0831836	1

Technical data		
TOPMARK LASER Aluminum DIN EN 61010-1 (VDE 0411-1) Free from silicone, halogen, and cadmium		
Ordering data		
Type	Order No.	Pcs. / Pkt.
LS-WMTB-AL (29X8) BK	0831508	5
LS-WMTB-AL (40X15) BK	0831509	5
LS-WMTB-AL (60X15) BK	0831510	5
LS-WMTB-AL (100X15) BK	0831511	5
LS-WMTB-AL (29X8) BK CUS	0831794	1
LS-WMTB-AL (40X15) BK CUS	0831795	1
LS-WMTB-AL (60X15) BK CUS	0831796	1
LS-WMTB-AL (100X15) BK CUS	0831797	1
Accessories		
TOPMARK LASER-MAG SHEET	0831836	1

### Stainless steel and aluminum cable marking for assembly with cable binders



- The LS-WMTB ... product range in circular format is available in stainless steel (V4A) or aluminum and includes markers that can be quickly and easily fitted with cable binders
- The LS-WMTB-V4A ... group is particularly characterized by its high resistance to saltwater, chloride, and solvents and it is therefore also suitable for the most demanding industrial requirements



- Automatic material detection enables fast and effective marking without time-consuming parameter settings
- The material sheet can be easily reused by creating a project code
- **Designation example:**  
**LS-WMTB-V4A (D25)**  
Diameter: 25 mm



- The use of modern laser technology creates highly resistant and permanent marking, which can only be removed by destroying the material
- The LS-WMTB-V4A ... product group can be marked in two ways: by engraving or annealing
- Labeling service: Phoenix Contact can custom-label all markers according to your requirements

Can be marked using:



Direct laser marking

#### General data

Can be marked with  
Material  
Wipe resistance  
Components

#### Description

**Stainless steel label**, round, for assembly with cable binders

30-section, diameter: 25 mm

20-section, diameter: 30 mm

**Aluminum label**, round, for assembly with cable binders

30-section, diameter: 25 mm

20-section, diameter: 30 mm

**Stainless steel label**, round, for assembly with cable binders, labeled according to customer specifications<sup>1)</sup>

30-section, diameter: 25 mm

20-section, diameter: 30 mm

**Aluminum label**, round, for assembly with cable binders, labeled according to customer specifications<sup>1)</sup>

30-section, diameter: 25 mm

20-section, diameter: 30 mm

**Sheet hopper**, for TOPMARK LASER

#### Notes:

For matching stainless steel cable binders, see page 580 in main catalog 5 or the product area on our website at [phoenixcontact.net/products](http://phoenixcontact.net/products).

<sup>1)</sup> For an ordering example, see page 358 in main catalog 5.



Stainless steel, material thickness: 0.5 mm



Aluminum, material thickness: 0.8 mm



Aluminum, black, material thickness: 0.8 mm

Technical data
TOPMARK LASER V4A DIN EN 61010-1 (VDE 0411-1) Free from silicone, halogen, and cadmium

Ordering data		
Type	Order No.	Pcs. / Pkt.
LS-WMTB-V4A (D25) LS-WMTB-V4A (D30)	0831520 0831521	5 5
LS-WMTB-V4A (D25) CUS LS-WMTB-V4A (D30) CUS	0831806 0831807	1 1

Accessories		
TOPMARK LASER-MAG SHEET	0831836	1

Technical data
TOPMARK LASER Aluminum DIN EN 61010-1 (VDE 0411-1) Free from silicone, halogen, and cadmium

Ordering data		
Type	Order No.	Pcs. / Pkt.
LS-WMTB-AL (D25) LS-WMTB-AL (D30)	0831504 0831505	5 5
LS-WMTB-AL (D25) CUS LS-WMTB-AL (D30) CUS	0831790 0831791	1 1

Accessories		
TOPMARK LASER-MAG SHEET	0831836	1

Technical data
TOPMARK LASER Aluminum DIN EN 61010-1 (VDE 0411-1) Free from silicone, halogen, and cadmium

Ordering data		
Type	Order No.	Pcs. / Pkt.
LS-WMTB-AL (D25) BK LS-WMTB-AL (D30) BK	0831512 0831513	5 5
LS-WMTB-AL (D25) BK CUS LS-WMTB-AL (D30) BK CUS	0831798 0831799	1 1

Accessories		
TOPMARK LASER-MAG SHEET	0831836	1

### Stainless steel and aluminum device marking for screwing or riveting



- The LS-EMSP ... product range is available in stainless steel (V4A) or aluminum and includes markers that can be quickly and easily fitted with screws or rivets
- The LS-EMSP-V4A ... group is particularly characterized by its high resistance to saltwater, chloride, and solvents and is therefore also suitable for the most demanding industrial requirements
- The LS-EMSP-V4A ... product group can be permanently marked in two ways: by engraving or annealing
- **Designation example: LS-EMSP-V4A (39x15)**  
Lettering field size: 39 x 15 mm
- Labeling service: Phoenix Contact can custom-label all markers according to your requirements

#### Notes:

For matching rivets for securing the LS-EMSP-V4A ... and LS-EMSP-AL ..., see page 370 in main catalog 5 or the product area on our website at [phoenixcontact.net/products](http://phoenixcontact.net/products).

For drilling diagrams, visit [phoenixcontact.net/products](http://phoenixcontact.net/products).

1) For an ordering example, see page 358 in main catalog 5.

2) From lettering field size 110 x 80 to 170 x 180 mm, the material thickness is 1.5 mm.



Can be marked using:



Direct laser marking

PRINTED  
FOR YOU



Stainless steel,  
material thickness: 0.5 mm

#### General data

Can be marked with  
Material  
Wipe resistance  
Components

#### Technical data

TOPMARK LASER  
V4A  
DIN EN 61010-1 (VDE 0411-1)  
Free from silicone, halogen, and cadmium

#### Description

**Marking label**, with mounting holes 3.2 mm in diameter

24-section  
16-section  
10-section  
6-section  
2-section  
2-section  
2-section  
1-section  
1-section

**Marking label**, with mounting holes 3.2 mm in diameter

10-section, red  
10-section, orange  
10-section, blue  
10-section, green  
6-section, red  
6-section, orange  
6-section, blue  
6-section, green

**Marking label**, with mounting holes 3.2 mm in diameter,  
**marked according to customer specifications<sup>1)</sup>**

24-section  
16-section  
10-section  
6-section  
2-section  
2-section  
2-section  
1-section  
1-section

**Marking label**, with mounting holes 3.2 mm in diameter,  
**marked according to customer specifications<sup>1)</sup>**

10-section, red  
10-section, orange  
10-section, blue  
10-section, green  
6-section, red  
6-section, orange  
6-section, blue  
6-section, green

#### Ordering data

Type	Order No.	Pcs. / Pkt.
LS-EMSP-V4A (39X15)	0831653	5
LS-EMSP-V4A (50X15)	0831654	5
LS-EMSP-V4A (50X30)	0831655	5
LS-EMSP-V4A (75,6X54)	0831656	5
LS-EMSP-V4A (90X60)	0831657	5
LS-EMSP-V4A (39X15) CUS	0831939	1
LS-EMSP-V4A (50X15) CUS	0831940	1
LS-EMSP-V4A (50X30) CUS	0831941	1
LS-EMSP-V4A (75,6X54) CUS	0831942	1
LS-EMSP-V4A (90X60) CUS	0831943	1

#### Sheet hopper, for TOPMARK LASER

#### Accessories

TOPMARK LASER-MAG SHEET	0831836	1
-------------------------	---------	---



**Aluminum,**  
material thickness: 0.8 mm<sup>2</sup>)



**Aluminum, black,**  
material thickness: 0.8 mm<sup>2</sup>)



**Aluminum, colored,**  
material thickness: 0.8 mm

Technical data		
TOPMARK LASER Aluminum DIN EN 61010-1 (VDE 0411-1) Free from silicone, halogen, and cadmium		
Ordering data		
Type	Order No.	Pcs. / Pkt.
LS-EMSP-AL (39X15)	0831615	5
LS-EMSP-AL (50X15)	0831616	5
LS-EMSP-AL (50X30)	0831617	5
LS-EMSP-AL (75,6X54)	0831618	5
LS-EMSP-AL (90X60)	0831619	5
LS-EMSP-AL (110X80)	0831620	5
LS-EMSP-AL (150X80)	0831621	5
LS-EMSP-AL (150X120)	0831622	5
LS-EMSP-AL (170X180)	0831623	5
LS-EMSP-AL (39X15) CUS	0831901	1
LS-EMSP-AL (50X15) CUS	0831902	1
LS-EMSP-AL (50X30) CUS	0831903	1
LS-EMSP-AL (75,6X54) CUS	0831904	1
LS-EMSP-AL (90X60) CUS	0831905	1
LS-EMSP-AL (110X80) CUS	0831906	1
LS-EMSP-AL (150X80) CUS	0831907	1
LS-EMSP-AL (150X120) CUS	0831908	1
LS-EMSP-AL (170X180) CUS	0831909	1
Accessories		
TOPMARK LASER-MAG SHEET	0831836	1

Technical data		
TOPMARK LASER Aluminum DIN EN 61010-1 (VDE 0411-1) Free from silicone, halogen, and cadmium		
Ordering data		
Type	Order No.	Pcs. / Pkt.
LS-EMSP-AL (39X15) BK	0831626	5
LS-EMSP-AL (50X15) BK	0831627	5
LS-EMSP-AL (50X30) BK	0831628	5
LS-EMSP-AL (75,6X54) BK	0831629	5
LS-EMSP-AL (90X60) BK	0831630	5
LS-EMSP-AL (110X80) BK	0831631	5
LS-EMSP-AL (150X80) BK	0831632	5
LS-EMSP-AL (150X120) BK	0831633	5
LS-EMSP-AL (170X180) BK	0831634	5
LS-EMSP-AL (39X15) BK CUS	0831912	1
LS-EMSP-AL (50X15) BK CUS	0831913	1
LS-EMSP-AL (50X30) BK CUS	0831914	1
LS-EMSP-AL (75,6X54) BK CUS	0831915	1
LS-EMSP-AL (90X60) BK CUS	0831916	1
LS-EMSP-AL (110X80) BK CUS	0831917	1
LS-EMSP-AL (150X80) BK CUS	0831918	1
LS-EMSP-AL (150X120) BK CUS	0831919	1
LS-EMSP-AL (170X180) BK CUS	0831920	1
Accessories		
TOPMARK LASER-MAG SHEET	0831836	1

Technical data		
TOPMARK LASER Aluminum DIN EN 61010-1 (VDE 0411-1) Free from silicone, halogen, and cadmium		
Ordering data		
Type	Order No.	Pcs. / Pkt.
LS-EMSP-AL (50X30) RD	0831637	5
LS-EMSP-AL (50X30) OG	0831641	5
LS-EMSP-AL (50X30) BU	0831645	5
LS-EMSP-AL (50X30) GN	0831649	5
LS-EMSP-AL (75,6X54) RD	0831638	5
LS-EMSP-AL (75,6X54) OG	0831642	5
LS-EMSP-AL (75,6X54) BU	0831646	5
LS-EMSP-AL (75,6X54) GN	0831650	5
LS-EMSP-AL (50X30) RD CUS	0831923	1
LS-EMSP-AL (50X30) OG CUS	0831927	1
LS-EMSP-AL (50X30) BU CUS	0831931	1
LS-EMSP-AL (50X30) GN CUS	0831935	1
LS-EMSP-AL (75,6X54) RD CUS	0831924	1
LS-EMSP-AL (75,6X54) OG CUS	0831928	1
LS-EMSP-AL (75,6X54) BU CUS	0831932	1
LS-EMSP-AL (75,6X54) GN CUS	0831936	1
Accessories		
TOPMARK LASER-MAG SHEET	0831836	1

### Adhesive aluminum device marking

Can be marked using:



Direct laser marking



Aluminum,  
material thickness: 0.8 mm

- The aluminum LS-EMLP-AL ... product range includes self-adhesive device markers with a high adhesive strength
- The use of modern laser technology creates highly resistant and permanent marking, which can only be removed by destroying the material
- Automatic material detection enables fast and effective marking without time-consuming parameter settings
- The material sheet can be easily reused by creating a project code
- **Designation example:**  
**LS-EMLP-AL (27x15)**  
Lettering field size: 27 x 15 mm
- Labeling service: Phoenix Contact can custom-label all markers according to your requirements

**Notes:**

1) For an ordering example, see page 358 in main catalog 5.

**General data**

Can be marked with  
Material  
Wipe resistance  
Components

**Technical data**

TOPMARK LASER  
Aluminum  
DIN EN 61010-1 (VDE 0411-1)  
Free from silicone, halogen, and cadmium

**Description**

**Marking label, aluminum, self-adhesive**

- 40-section
- 35-section
- 24-section
- 16-section
- 10-section
- 6-section
- 2-section

**Marking label, aluminum, self-adhesive**

- 10-section, red
- 10-section, orange
- 10-section, blue
- 10-section, green
- 6-section, red
- 6-section, orange
- 6-section, blue
- 6-section, green

**Marking label, aluminum, self-adhesive, marked according to customer specifications<sup>1)</sup>**

- 40-section
- 35-section
- 24-section
- 16-section
- 10-section
- 6-section
- 2-section

**Marking label, aluminum, self-adhesive, marked according to customer specifications<sup>1)</sup>**

- 10-section, red
- 10-section, orange
- 10-section, blue
- 10-section, green
- 6-section, red
- 6-section, orange
- 6-section, blue
- 6-section, green

**Ordering data**

Type	Order No.	Pcs. / Pkt.
LS-EMLP-AL (27X15)	0831580	5
LS-EMLP-AL (27X18)	0831581	5
LS-EMLP-AL (49X15)	0831582	5
LS-EMLP-AL (60X15)	0831583	5
LS-EMLP-AL (60X30)	0831584	5
LS-EMLP-AL (85,6X54)	0831585	5
LS-EMLP-AL (100X60)	0831586	5
LS-EMLP-AL (27X15) CUS	0831866	1
LS-EMLP-AL (27X18) CUS	0831867	1
LS-EMLP-AL (49X15) CUS	0831868	1
LS-EMLP-AL (60X15) CUS	0831869	1
LS-EMLP-AL (60X30) CUS	0831870	1
LS-EMLP-AL (85,6X54) CUS	0831871	1
LS-EMLP-AL (100X60) CUS	0831872	1



**Sheet hopper, for TOPMARK LASER**

**Accessories**

TOPMARK LASER-MAG SHEET	0831836	1
-------------------------	---------	---



Aluminum, black,  
material thickness: 0.8 mm



Aluminum, colored,  
material thickness: 0.8 mm

Technical data		
TOPMARK LASER		
Aluminum		
DIN EN 61010-1 (VDE 0411-1)		
Free from silicone, halogen, and cadmium		
Ordering data		
Type	Order No.	Pcs. / Pkt.
LS-EMLP-AL (27X15) BK	0831589	5
LS-EMLP-AL (27X18) BK	0831590	5
LS-EMLP-AL (49X15) BK	0831591	5
LS-EMLP-AL (60X15) BK	0831592	5
LS-EMLP-AL (60X30) BK	0831593	5
LS-EMLP-AL (85,6X54) BK	0831594	5
LS-EMLP-AL (100X60) BK	0831595	5
LS-EMLP-AL (27X15) BK CUS	0831875	1
LS-EMLP-AL (27X18) BK CUS	0831876	1
LS-EMLP-AL (49X15) BK CUS	0831877	1
LS-EMLP-AL (60X15) BK CUS	0831878	1
LS-EMLP-AL (60X30) BK CUS	0831879	1
LS-EMLP-AL (85,6X54) BK CUS	0831880	1
LS-EMLP-AL (100X60) BK CUS	0831881	1

Technical data		
TOPMARK LASER		
Aluminum		
DIN EN 61010-1 (VDE 0411-1)		
Free from silicone, halogen, and cadmium		
Ordering data		
Type	Order No.	Pcs. / Pkt.
LS-EMLP-AL (60X30) RD	0831598	5
LS-EMLP-AL (60X30) OG	0831602	5
LS-EMLP-AL (60X30) BU	0831606	5
LS-EMLP-AL (60X30) GN	0831610	5
LS-EMLP-AL (85,6X54) RD	0831599	5
LS-EMLP-AL (85,6X54) OG	0831603	5
LS-EMLP-AL (85,6X54) BU	0831607	5
LS-EMLP-AL (85,6X54) GN	0831611	5
LS-EMLP-AL (60X30) RD CUS	0831884	1
LS-EMLP-AL (60X30) OG CUS	0831888	1
LS-EMLP-AL (60X30) BU CUS	0831892	1
LS-EMLP-AL (60X30) GN CUS	0831896	1
LS-EMLP-AL (85,6X54) RD CUS	0831885	1
LS-EMLP-AL (85,6X54) OG CUS	0831889	1
LS-EMLP-AL (85,6X54) BU CUS	0831893	1
LS-EMLP-AL (85,6X54) GN CUS	0831897	1

Accessories		
TOPMARK LASER-MAG SHEET	0831836	1

Accessories		
TOPMARK LASER-MAG SHEET	0831836	1

### Aluminum device marking for snapping into marker carriers

Can be marked using:



Direct laser marking



Aluminum, material thickness: 0.8 mm

- The aluminum LS-EMP-AL ... product range includes markers that can be quickly and easily fitted into existing CARRIER-EMP ... label frames
- The use of modern laser technology creates highly resistant and permanent marking, which can only be removed by destroying the material
- Automatic material detection enables fast and effective marking without time-consuming parameter settings
- The material sheet can be easily reused by creating a project code
- **Designation example:**  
**LS-EMP-AL (27x15)**  
Lettering field size: 27 x 15 mm
- Labeling service: Phoenix Contact can custom-label all markers according to your requirements

**Notes:**

1) For an ordering example, see page 358 in main catalog 5.

**General data**

Can be marked with  
Material  
Wipe resistance  
Components

**Technical data**

TOPMARK LASER  
Aluminum  
DIN EN 61010-1 (VDE 0411-1)  
Free from silicone, halogen, and cadmium

**Description**

**Marking label**, aluminum, can be snapped into marker carriers

40-section  
35-section  
24-section  
16-section  
10-section  
6-section  
2-section

**Marking label**, aluminum, can be snapped into marker carriers, marked according to customer specifications<sup>1)</sup>

40-section  
35-section  
24-section  
16-section  
10-section  
6-section  
2-section

**Ordering data**

Type	Order No.	Pcs. / Pkt.
LS-EMP-AL (27X15)	0831661	5
LS-EMP-AL (27X18)	0831662	5
LS-EMP-AL (49X15)	0831663	5
LS-EMP-AL (60X15)	0831664	5
LS-EMP-AL (60X30)	0831665	5
LS-EMP-AL (85,6X54)	0831666	5
LS-EMP-AL (100X60)	0831667	5
LS-EMP-AL (27X15) CUS	0831947	1
LS-EMP-AL (27X18) CUS	0831948	1
LS-EMP-AL (49X15) CUS	0831949	1
LS-EMP-AL (60X15) CUS	0831950	1
LS-EMP-AL (60X30) CUS	0831951	1
LS-EMP-AL (85,6X54) CUS	0831952	1
LS-EMP-AL (100X60) CUS	0831953	1

**Sheet hopper**, for TOPMARK LASER

**Marker carriers**, for snap-in labels

Marker size: 27 x 15 mm  
Marker size: 49 x 15 mm  
Marker size: 60 x 15 mm  
Marker size: 60 x 30 mm  
Marker size: 85 x 54 mm

**Marker carriers**, for snap-in labels, for buttons and switches 22 mm in diameter

Marker size: 27 x 15 mm  
Marker size: 27 x 18 mm

**Accessories**

TOPMARK LASER-MAG SHEET	0831836	1
CARRIER-EMP (27X15)	0827451	80
CARRIER-EMP (49X15)	0827452	40
CARRIER-EMP (60X15)	0827453	40
CARRIER-EMP (60X30)	0827454	30
CARRIER-EMP (85,6X54)	0829365	10
CARRIER-EMP 22 (27X15)	0827447	50
CARRIER-EMP 22 (27X18)	0827448	50





PRINTED  
 FOR YOU



Aluminum, black, material thickness: 0.8 mm

#### Technical data

TOPMARK LASER  
 Aluminum  
 DIN EN 61010-1 (VDE 0411-1)  
 Free from silicone, halogen, and cadmium

#### Ordering data

Type	Order No.	Pcs. / Pkt.
LS-EMP-AL (27X15) BK	0831669	5
LS-EMP-AL (27X18) BK	0831670	5
LS-EMP-AL (49X15) BK	0831671	5
LS-EMP-AL (60X15) BK	0831672	5
LS-EMP-AL (60X30) BK	0831673	5
LS-EMP-AL (85,6X54) BK	0831674	5
LS-EMP-AL (100X60) BK	0831675	5
LS-EMP-AL (27X15) BK CUS	0831955	1
LS-EMP-AL (27X18) BK CUS	0831956	1
LS-EMP-AL (49X15) BK CUS	0831957	1
LS-EMP-AL (60X15) BK CUS	0831958	1
LS-EMP-AL (60X30) BK CUS	0831959	1
LS-EMP-AL (85,6X54) BK CUS	0831960	1
LS-EMP-AL (100X60) BK CUS	0831961	1

#### Accessories

TOPMARK LASER-MAG SHEET	0831836	1
CARRIER-EMP (27X15)	0827451	80
CARRIER-EMP (49X15)	0827452	40
CARRIER-EMP (60X15)	0827453	40
CARRIER-EMP (60X30)	0827454	30
CARRIER-EMP (85,6X54)	0829365	10
CARRIER-EMP 22 (27X15)	0827447	50
CARRIER-EMP 22 (27X18)	0827448	50

### Plastic adhesive device marking

Can be marked using:



Direct laser marking

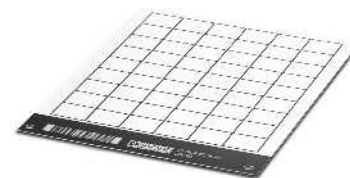

White, material thickness: 0.8 mm

- The LS-EMLP ... product range includes self-adhesive double-layer plastic device markers
- A wide range of different marker sizes is available for custom designs
- Automatic material detection enables fast and effective marking without time-consuming parameter settings
- The material sheet can be easily reused by creating a project code
- **Designation example:**  
**LS-EMLP (11x9) SR**  
Lettering field size: 11 x 9 mm, silver material with black marking

General data	
Can be marked with	TOPMARK LASER
Material	TRANSPLY-ABS
Temperature range	-20 ... 85 [°C]
Wipe resistance	DIN EN 61010-1 (VDE 0411-1)
Components	Free from silicone and halogen

Technical data	
TOPMARK LASER	
TRANSPLY-ABS	
-20 ... 85 [°C]	
DIN EN 61010-1 (VDE 0411-1)	
Free from silicone and halogen	

Ordering data	
Description	Type
<b>Plastic label sheet</b> , self-adhesive, double-layer plastic labels	
1 sheet = 255 labels	LS-EMLP (11X9) WH
1 sheet = 221 labels	LS-EMLP (13X9) WH
1 sheet = 220 labels	LS-EMLP (17X7) WH
1 sheet = 170 labels	LS-EMLP (17X9) WH
1 sheet = 130 labels	LS-EMLP (17,5X12) WH
1 sheet = 100 labels	LS-EMLP (17,5X15) WH
1 sheet = 176 labels	LS-EMLP (20X7) WH
1 sheet = 160 labels	LS-EMLP (20X8) WH
1 sheet = 104 labels	LS-EMLP (22X12) WH
1 sheet = 56 labels	LS-EMLP (22X22) WH
1 sheet = 120 labels	LS-EMLP (27X8) WH
1 sheet = 78 labels	LS-EMLP (27X12,5) WH
1 sheet = 60 labels	LS-EMLP (27X15) WH
1 sheet = 54 labels	LS-EMLP (27X18) WH
1 sheet = 36 labels	LS-EMLP (27X27) WH
1 sheet = 33 labels	LS-EMLP (45X14) WH
1 sheet = 30 labels	LS-EMLP (45X15) WH
1 sheet = 30 labels	LS-EMLP (49X15) WH
1 sheet = 20 labels	LS-EMLP (60X15) WH
1 sheet = 10 labels	LS-EMLP (60X30) WH
1 sheet = 6 labels	LS-EMLP (85,6X54) WH
1 sheet = 2 labels	LS-EMLP (100X60) WH

Ordering data		
Type	Order No.	Pcs. / Pkt.
LS-EMLP (11X9) WH	0831678	10
LS-EMLP (13X9) WH	0831679	10
LS-EMLP (17X7) WH	0831680	10
LS-EMLP (17X9) WH	0831681	10
LS-EMLP (17,5X12) WH	0831682	10
LS-EMLP (17,5X15) WH	0831683	10
LS-EMLP (20X7) WH	0831684	10
LS-EMLP (20X8) WH	0831685	10
LS-EMLP (22X12) WH	0831686	10
LS-EMLP (22X22) WH	0831687	10
LS-EMLP (27X8) WH	0831688	10
LS-EMLP (27X12,5) WH	0831689	10
LS-EMLP (27X15) WH	0831690	10
LS-EMLP (27X18) WH	0831691	10
LS-EMLP (27X27) WH	0831692	10
LS-EMLP (45X14) WH	0831693	10
LS-EMLP (45X15) WH	0831694	10
LS-EMLP (49X15) WH	0831695	10
LS-EMLP (60X15) WH	0831696	10
LS-EMLP (60X30) WH	0831697	10
LS-EMLP (85,6X54) WH	0831698	10
LS-EMLP (100X60) WH	0831699	10

Accessories	
<b>Sheet hopper</b> , for TOPMARK LASER	

Accessories		
TOPMARK LASER-MAG SHEET	0831836	1

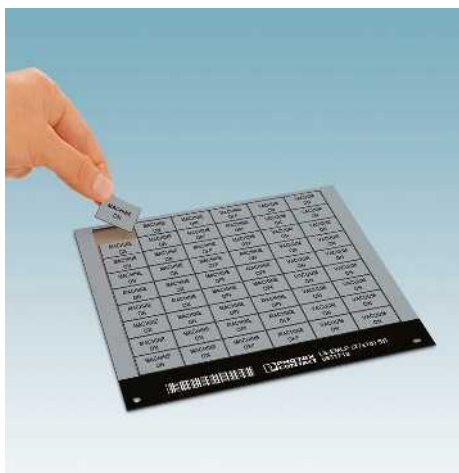



**Yellow, material thickness: 0.8 mm**



**Silver, material thickness: 0.8 mm**

Technical data
TOPMARK LASER
TRANSPLY-ABS
-20 ... 85
DIN EN 61010-1 (VDE 0411-1)
Free from silicone and halogen

Technical data
TOPMARK LASER
TRANSPLY-ABS
-20 ... 85
DIN EN 61010-1 (VDE 0411-1)
Free from silicone and halogen

Ordering data		
Type	Order No.	Pcs. / Pkt.
LS-EMLP (11X9) YE	0831732	10
LS-EMLP (13X9) YE	0831733	10
LS-EMLP (17X7) YE	0831734	10
LS-EMLP (17X9) YE	0831735	10
LS-EMLP (17,5X12) YE	0831736	10
LS-EMLP (17,5X15) YE	0831737	10
LS-EMLP (20X7) YE	0831738	10
LS-EMLP (20X8) YE	0831739	10
LS-EMLP (22X12) YE	0831740	10
LS-EMLP (22X22) YE	0831741	10
LS-EMLP (27X8) YE	0831742	10
LS-EMLP (27X12,5) YE	0831743	10
LS-EMLP (27X15) YE	0831744	10
LS-EMLP (27X18) YE	0831745	10
LS-EMLP (27X27) YE	0831746	10
LS-EMLP (45X14) YE	0831747	10
LS-EMLP (45X15) YE	0831748	10
LS-EMLP (49X15) YE	0831749	10
LS-EMLP (60X15) YE	0831750	10
LS-EMLP (60X30) YE	0831751	10
LS-EMLP (85,6X54) YE	0831752	10
LS-EMLP (100X60) YE	0831753	10

Ordering data		
Type	Order No.	Pcs. / Pkt.
LS-EMLP (11X9) SR	0831705	10
LS-EMLP (13X9) SR	0831706	10
LS-EMLP (17X7) SR	0831707	10
LS-EMLP (17X9) SR	0831708	10
LS-EMLP (17,5X12) SR	0831709	10
LS-EMLP (17,5X15) SR	0831710	10
LS-EMLP (20X7) SR	0831711	10
LS-EMLP (20X8) SR	0831712	10
LS-EMLP (22X12) SR	0831713	10
LS-EMLP (22X22) SR	0831714	10
LS-EMLP (27X8) SR	0831715	10
LS-EMLP (27X12,5) SR	0831716	10
LS-EMLP (27X15) SR	0831717	10
LS-EMLP (27X18) SR	0831718	10
LS-EMLP (27X27) SR	0831719	10
LS-EMLP (45X14) SR	0831720	10
LS-EMLP (45X15) SR	0831721	10
LS-EMLP (49X15) SR	0831722	10
LS-EMLP (60X15) SR	0831723	10
LS-EMLP (60X30) SR	0831724	10
LS-EMLP (85,6X54) SR	0831725	10
LS-EMLP (100X60) SR	0831726	10

Accessories		
Type	Order No.	Pcs. / Pkt.
TOPMARK LASER-MAG SHEET	0831836	1

Accessories		
Type	Order No.	Pcs. / Pkt.
TOPMARK LASER-MAG SHEET	0831836	1

### Plastic adhesive device marking, marked according to customer specifications



- The LS-EMLP ... product range includes self-adhesive double-layer plastic device markers
- A wide range of different marker sizes is available for custom designs
- Automatic material detection enables fast and effective marking without time-consuming parameter settings
- The material sheet can be easily reused by creating a project code
- **Designation example:**  
**LS-EMLP (11x9) SR CUS**  
Lettering field size: 11 x 9 mm, silver material with black marking
- Labeling service: Phoenix Contact can custom-label all markers according to your requirements

**Notes:**

1) For an ordering example, see page 358 in main catalog 5.

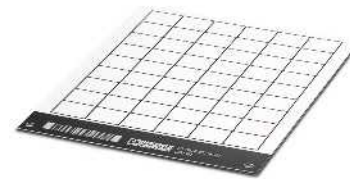

White, material thickness: 0.8 mm

General data	
Material	
Temperature range	[°C]
Wipe resistance	
Components	

Technical data	
Material	TRANSPLY-ABS
Temperature range	-20 ... 85
Wipe resistance	DIN EN 61010-1 (VDE 0411-1)
Components	Free from silicone and halogen

Description
<b>Plastic label sheet,</b> self-adhesive double-layer plastic labels, <b>marked according to customer specifications<sup>1)</sup></b>
1 sheet = 255 labels
1 sheet = 221 labels
1 sheet = 220 labels
1 sheet = 170 labels
1 sheet = 130 labels
1 sheet = 100 labels
1 sheet = 176 labels
1 sheet = 160 labels
1 sheet = 104 labels
1 sheet = 56 labels
1 sheet = 120 labels
1 sheet = 78 labels
1 sheet = 60 labels
1 sheet = 54 labels
1 sheet = 36 labels
1 sheet = 33 labels
1 sheet = 30 labels
1 sheet = 30 labels
1 sheet = 20 labels
1 sheet = 10 labels
1 sheet = 6 labels
1 sheet = 2 labels

Ordering data		
Type	Order No.	Pcs. / Pkt.
LS-EMLP (11X9) WH CUS	0831964	1
LS-EMLP (13X9) WH CUS	0831965	1
LS-EMLP (17X7) WH CUS	0831966	1
LS-EMLP (17X9) WH CUS	0831967	1
LS-EMLP (17,5X12) WH CUS	0831968	1
LS-EMLP (17,5X15) WH CUS	0831969	1
LS-EMLP (20X7) WH CUS	0831970	1
LS-EMLP (20X8) WH CUS	0831971	1
LS-EMLP (22X12) WH CUS	0831972	1
LS-EMLP (22X22) WH CUS	0831973	1
LS-EMLP (27X8) WH CUS	0831974	1
LS-EMLP (27X12,5) WH CUS	0831975	1
LS-EMLP (27X15) WH CUS	0831976	1
LS-EMLP (27X18) WH CUS	0831977	1
LS-EMLP (27X27) WH CUS	0831978	1
LS-EMLP (45X14) WH CUS	0831979	1
LS-EMLP (45X15) WH CUS	0831980	1
LS-EMLP (49X15) WH CUS	0831981	1
LS-EMLP (60X15) WH CUS	0831982	1
LS-EMLP (60X30) WH CUS	0831983	1
LS-EMLP (85,6X54) WH CUS	0831984	1
LS-EMLP (100X60) WH CUS	0831985	1

Sheet hopper, for TOPMARK LASER	
TOPMARK LASER-MAG SHEET	0831836

Accessories		
TOPMARK LASER-MAG SHEET	0831836	1

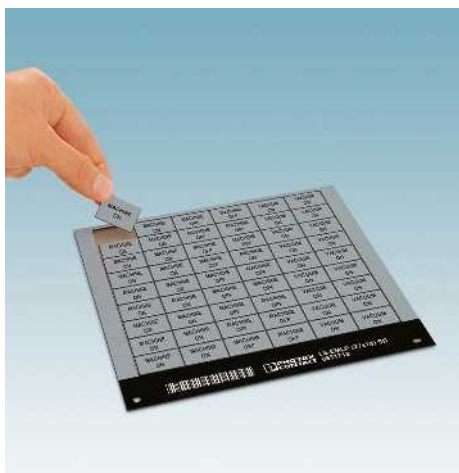

PRINTED  
FOR YOU



Yellow, material thickness: 0.8 mm

PRINTED  
FOR YOU



Silver, material thickness: 0.8 mm

Technical data
TRANSPLY-ABS
-20 ... 85
DIN EN 61010-1 (VDE 0411-1)
Free from silicone and halogen

Ordering data		
Type	Order No.	Pcs. / Pkt.
LS-EMLP (11X9) YE CUS	0832018	1
LS-EMLP (13X9) YE CUS	0832019	1
LS-EMLP (17X7) YE CUS	0832020	1
LS-EMLP (17X9) YE CUS	0832021	1
LS-EMLP (17,5X12) YE CUS	0832022	1
LS-EMLP (17,5X15) YE CUS	0832023	1
LS-EMLP (20X7) YE CUS	0832024	1
LS-EMLP (20X8) YE CUS	0832025	1
LS-EMLP (22X12) YE CUS	0832026	1
LS-EMLP (22X22) YE CUS	0832027	1
LS-EMLP (27X8) YE CUS	0832028	1
LS-EMLP (27X12,5) YE CUS	0832029	1
LS-EMLP (27X15) YE CUS	0832030	1
LS-EMLP (27X18) YE CUS	0832031	1
LS-EMLP (27X27) YE CUS	0832032	1
LS-EMLP (45X14) YE CUS	0832033	1
LS-EMLP (45X15) YE CUS	0832034	1
LS-EMLP (49X15) YE CUS	0832035	1
LS-EMLP (60X15) YE CUS	0832036	1
LS-EMLP (60X30) YE CUS	0832037	1
LS-EMLP (85,6X54) YE CUS	0832038	1
LS-EMLP (100X60) YE CUS	0832039	1

Accessories		
TOPMARK LASER-MAG SHEET	0831836	1

Technical data
TRANSPLY-ABS
-20 ... 85
DIN EN 61010-1 (VDE 0411-1)
Free from silicone and halogen

Ordering data		
Type	Order No.	Pcs. / Pkt.
LS-EMLP (11X9) SR CUS	0831991	1
LS-EMLP (13X9) SR CUS	0831992	1
LS-EMLP (17X7) SR CUS	0831993	1
LS-EMLP (17X9) SR CUS	0831994	1
LS-EMLP (17,5X12) SR CUS	0831995	1
LS-EMLP (17,5X15) SR CUS	0831996	1
LS-EMLP (20X7) SR CUS	0831997	1
LS-EMLP (20X8) SR CUS	0831998	1
LS-EMLP (22X12) SR CUS	0831999	1
LS-EMLP (22X22) SR CUS	0832000	1
LS-EMLP (27X8) SR CUS	0832001	1
LS-EMLP (27X12,5) SR CUS	0832002	1
LS-EMLP (27X15) SR CUS	0832003	1
LS-EMLP (27X18) SR CUS	0832004	1
LS-EMLP (27X27) SR CUS	0832005	1
LS-EMLP (45X14) SR CUS	0832006	1
LS-EMLP (45X15) SR CUS	0832007	1
LS-EMLP (49X15) SR CUS	0832008	1
LS-EMLP (60X15) SR CUS	0832009	1
LS-EMLP (60X30) SR CUS	0832010	1
LS-EMLP (85,6X54) SR CUS	0832011	1
LS-EMLP (100X60) SR CUS	0832012	1

Accessories		
TOPMARK LASER-MAG SHEET	0831836	1

### Plastic adhesive device marking, with hole for switch

Can be marked using:



Direct laser marking



Diameter: 24 mm, material thickness: 0.8 mm

- The LS-EMLP 24/ 30/ 32 ... product range includes self-adhesive double-layer plastic device markers with a hole for the switch
- A wide range of different marker sizes is available for custom designs
- Automatic material detection enables fast and effective marking without time-consuming parameter settings
- The material sheet can be easily reused by creating a project code
- **Designation example:**  
**LS-EMLP 24 (30x12) WH**  
Lettering field size: 30 x 12 mm  
Hole diameter for switch: 24 mm, white material with black marking
- Labeling service: Phoenix Contact can custom-label all markers according to your requirements

**Notes:**

1) For an ordering example, see page 358 in main catalog 5.



General data	
Can be marked with	TOPMARK LASER
Material	TRANSPLY-ABS
Temperature range	-20 ... 85
Wipe resistance	DIN EN 61010-1 (VDE 0411-1)
Components	Free from silicone and halogen

**Technical data**

Can be marked with	TOPMARK LASER
Material	TRANSPLY-ABS
Temperature range	-20 ... 85
Wipe resistance	DIN EN 61010-1 (VDE 0411-1)
Components	Free from silicone and halogen

Description	Color
-------------	-------

**Plastic label sheet**, with hole for switch, diameter 24 mm, self-adhesive double-layer plastic labels

1 sheet = 20 labels	white
1 sheet = 20 labels	yellow
1 sheet = 20 labels	silver

**Plastic label sheet**, with hole for switch, diameter 30 mm, self-adhesive double-layer plastic labels

1 sheet = 9 labels	white
1 sheet = 9 labels	yellow
1 sheet = 9 labels	silver

**Plastic label sheet**, with hole for switch, diameter 32 mm, self-adhesive double-layer plastic labels

1 sheet = 12 labels	white
1 sheet = 12 labels	yellow
1 sheet = 12 labels	silver

**Plastic label sheet**, with hole for switch, diameter 24 mm, self-adhesive double-layer plastic labels, **marked according to customer specifications<sup>1)</sup>**

1 sheet = 20 labels	white
1 sheet = 20 labels	yellow
1 sheet = 20 labels	silver

**Plastic label sheet**, with hole for switch, diameter 30 mm, self-adhesive double-layer plastic labels, **marked according to customer specifications<sup>1)</sup>**

1 sheet = 9 labels	white
1 sheet = 9 labels	yellow
1 sheet = 9 labels	silver

**Plastic label sheet**, with hole for switch, diameter 32 mm, self-adhesive double-layer plastic labels, **marked according to customer specifications<sup>1)</sup>**

1 sheet = 12 labels	white
1 sheet = 12 labels	yellow
1 sheet = 12 labels	silver

**Ordering data**

Type	Order No.	Pcs. / Pkt.
LS-EMLP 24 (30X12) WH	0831700	10
LS-EMLP 24 (30X12) YE	0831754	10
LS-EMLP 24 (30X12) SR	0831727	10
LS-EMLP 24 (30X12) WH CUS	0831986	1
LS-EMLP 24 (30X12) YE CUS	0832040	1
LS-EMLP 24 (30X12) SR CUS	0832013	1

**Accessories**

Sheet hopper, for TOPMARK LASER	TOPMARK LASER-MAG SHEET	0831836	1
---------------------------------	-------------------------	---------	---

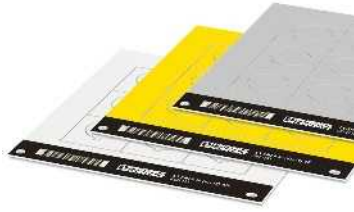

Diameter: 30 mm,  
 material thickness: 0.8 mm



Diameter: 32 mm,  
 material thickness: 0.8 mm

Technical data
TOPMARK LASER TRANSPLY-ABS -20 ... 85 DIN EN 61010-1 (VDE 0411-1) Free from silicone and halogen

Technical data
TOPMARK LASER TRANSPLY-ABS -20 ... 85 DIN EN 61010-1 (VDE 0411-1) Free from silicone and halogen

Ordering data
---------------

Ordering data
---------------

Type	Order No.	Pcs. / Pkt.
LS-EMLP 30 (45X10) WH	0831701	10
LS-EMLP 30 (45X10) YE	0831755	10
LS-EMLP 30 (45X10) SR	0831728	10
LS-EMLP 30 (45X10) WH CUS	0831987	1
LS-EMLP 30 (45X10) YE CUS	0832041	1
LS-EMLP 30 (45X10) SR CUS	0832014	1

Type	Order No.	Pcs. / Pkt.
LS-EMLP 32 (38X14) WH	0831702	10
LS-EMLP 32 (38X14) YE	0831756	10
LS-EMLP 32 (38X14) SR	0831729	10
LS-EMLP 32 (38X14) WH CUS	0831988	1
LS-EMLP 32 (38X14) YE CUS	0832042	1
LS-EMLP 32 (38X14) SR CUS	0832015	1

Accessories
-------------

Accessories
-------------

TOPMARK LASER-MAG SHEET	0831836	1
-------------------------	---------	---

TOPMARK LASER-MAG SHEET	0831836	1
-------------------------	---------	---

### Laser foil adhesive device marking

Can be marked using:



Direct laser marking

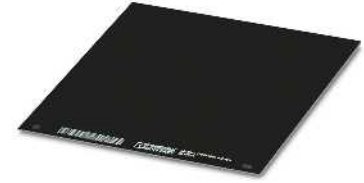

Black-white

- The LS-EML ... product range includes self-adhesive, double-layer plastic foil labels that can be custom designed
- The laser foil is characterized by its high heat resistance and particularly strong adhesive properties
- Automatic material detection enables fast and effective marking without time-consuming parameter settings
- The material sheet can be easily reused by creating a project code
- **Designation example:**  
**LS-EML (180x180) BK-WH**  
Lettering field size: 180 x 180 mm, can be custom designed, black material with white marking
- Labeling service: Phoenix Contact can custom-label all markers according to your requirements

#### Notes:

1) For an ordering example, see page 358 in main catalog 5.

#### General data

Can be marked with	
Material	
Temperature range	[-40 ... 300] [°C]
Wipe resistance	
Components	

#### Description

**Laser foil**, double-layer plastic foil, for custom label design

Lettering field size: 180 x 180 mm

**Laser foil**, double-layer plastic foil, for custom label design, marked according to customer specifications<sup>1)</sup>

Lettering field size: 180 x 180 mm

#### Sheet hopper, for TOPMARK LASER

#### Technical data

TOPMARK LASER
Polyacrylate
-40 ... 300
DIN EN 61010-1 (VDE 0411-1)
Free from silicone and halogen

#### Ordering data

Type	Order No.	Pcs. / Pkt.
LS-EML (180X180) BK-WH	0831784	10
LS-EML (180X180) BK-WH CUS	0832070	1

#### Accessories

Accessories	Order No.	Pcs. / Pkt.
TOPMARK LASER-MAG SHEET	0831836	1







## Terminal marking - MARKING system

### UM marking for terminals from other manufacturers, strips

Can be marked using:



Thermal transfer for sheets and cards



UV LED technology



Plotter



For a tall marker groove

- The universal UM1-TM ... material marking range includes markers for Weidmüller, Conta-Clip, Klemsan, Wago, and ABB (Entrelec) terminal blocks
- The markers, which are supplied in double strips, can be quickly and easily marked with BLUEMARK ..., THERMOMARK CARD ..., and the CMS-P1-PLOTTER
- The markers support multiline labeling
- The marking strips are easy to fit and can be easily separated if required
- The marking strips are snapped into the magazine in a twist-proof manner by means of a coding pin and fed to the output devices
- The format automatically ensures printing with a high level of positional accuracy

#### General data

Can be marked with

Material

Inflammability class according to UL 94

Temperature range

[°C]

Wipe resistance

Components

#### Technical data

THERMOMARK CARD PLUS • THERMOMARK CARD •

BLUEMARK CLED • CMS-P1-PLOTTER

PC

V2

-40 ... 120

DIN EN 61010-1 (VDE 0411-1)

Free from silicone, halogen, and cadmium

#### Ordering data

Description	Color
<b>UM1-TM ...</b> , for marking terminal blocks from other manufacturers, Weidmüller, Conta-Clip, Klemsan	
34-section, lettering field size: 3.5 x 12 mm, pitch: 3.5 mm	white
24-section, lettering field size: 5 x 10 mm, pitch: 5 mm	white
24-section, lettering field size: 5 x 12 mm, pitch: 5 mm	white
20-section, lettering field size: 6 x 10 mm, pitch: 6 mm	white
20-section, lettering field size: 6 x 12 mm, pitch: 6 mm	white
14-section, lettering field size: 8 x 10 mm, pitch: 8 mm	white
14-section, lettering field size: 8 x 12 mm, pitch: 8 mm	white
10-section, lettering field size: 12 x 10 mm, pitch: 12 mm	white
<b>UM1U-TM ...</b> , for marking terminal blocks from other manufacturers, Weidmüller, Conta-Clip, Klemsan, with an offset foot	
24-section, lettering field size: 5 x 10 mm, pitch: 5 mm	white
20-section, lettering field size: 6 x 10 mm, pitch: 6 mm	white
<b>UM1-TMF ...</b> , for marking terminal blocks from other manufacturers, Weidmüller, Conta-Clip, Klemsan, Wago, ABB (Entrelec)	
34-section, lettering field size: 3.5 x 5 mm, pitch: 3.5 mm	white
24-section, lettering field size: 5 x 5 mm, pitch: 5 mm	white
20-section, lettering field size: 6 x 5 mm, pitch: 6 mm	white
14-section, lettering field size: 8 x 5 mm, pitch: 8 mm	white

Type	Order No.	Pcs. / Pkt.
<b>UM1-TM (3,5X12)</b>	<b>0830925</b>	10
<b>UM1-TM (5X10)</b>	<b>0830905</b>	10
<b>UM1-TM (5X12)</b>	<b>0830912</b>	10
<b>UM1-TM (6X10)</b>	<b>0830903</b>	10
<b>UM1-TM (6X12)</b>	<b>0830909</b>	10
<b>UM1-TM (8X10)</b>	<b>0830906</b>	10
<b>UM1-TM (8X12)</b>	<b>0830920</b>	10
<b>UM1-TM (12X10)</b>	<b>0830916</b>	10

#### Magazine, for THERMOMARK CARD ...

for accommodating UM1-TM ...

for accommodating UM1U-TM ...

for accommodating UM1-TMF ...

#### Accessories

<b>THERMOMARK CARD-UM-MAG1</b>	<b>0831200</b>	1
--------------------------------	----------------	---



For a tall marker groove, with an offset foot



For a flat marker groove

**Technical data**

THERMOMARK CARD PLUS • THERMOMARK CARD •  
 BLUEMARK CLED • CMS-P1-PLOTTER  
 PC  
 V2  
 -40 ... 120  
 DIN EN 61010-1 (VDE 0411-1)  
 Free from silicone, halogen, and cadmium

**Technical data**

THERMOMARK CARD PLUS • THERMOMARK CARD •  
 BLUEMARK CLED • CMS-P1-PLOTTER  
 PC  
 V2  
 -40 ... 120  
 DIN EN 61010-1 (VDE 0411-1)  
 Free from silicone, halogen, and cadmium

**Ordering data**

Type	Order No.	Pcs. / Pkt.
UM1U-TM (5X10)	0830910	10
UM1U-TM (6X10)	0830907	10

**Ordering data**

Type	Order No.	Pcs. / Pkt.
UM1-TMF (3,5X5)	0830935	10
UM1-TMF (5X5)	0830902	10
UM1-TMF (6X5)	0830904	10
UM1-TMF (8X5)	0830924	10

**Accessories**

THERMOMARK CARD-UM-MAG4	0831203	1
-------------------------	---------	---

**Accessories**

THERMOMARK CARD-UM-MAG3	0831202	1
-------------------------	---------	---

## Terminal marking - MARKING system

### Terminal marking, marker strips for tall and flat marker grooves



Can be marked using:



Thermal transfer for rolls

PRINTED  
FOR YOU



Unlabeled or labeled according to customer specifications

- The TMT labeling range includes markers for all products with tall and flat marker grooves
- Labeling service: Phoenix Contact can custom-label all TMT markers in accordance with your requirements

**Notes:**  
 1) For an ordering example, see page 358 in main catalog 5.  
 2) The TMT TOOL snap-in tool can only be used for terminal blocks from Phoenix Contact.

General data	
Can be marked with	
Material	
Material strength	
Inflammability class according to UL 94	
Temperature range	[°C]
Wipe resistance	
Components	

Technical data	
THERMOMARK ROLL • THERMOMARK ROLL X1 • THERMOMARK X1.1 • THERMOMARK X1.2 • THERMOMARK S1.1	
PVC	
0.50 mm	
V0	
-30 ... 80	
DIN EN 61010-1 (VDE 0411-1)	
Free from silicone and cadmium	

Description	Color
<b>Insert strips, unprinted, 1 roll = 50 m, continuous</b>	
Strip height: 5.5 mm	white
Strip height: 6.2 mm	white
Strip height: 6.5 mm	white
Strip height: 7.5 mm	white
Strip height: 8 mm	white
Strip height: 8.5 mm	white
Strip height: 9.5 mm	white
Strip height: 10 mm	white
Strip height: 10.5 mm	white
Strip height: 11 mm	white
Strip height: 12 mm	white
<b>Insert strips, marked according to customer specifications<sup>1)</sup></b>	
Strip height: 5.5 mm	white
Strip height: 6.2 mm	white
Strip height: 6.5 mm	white
Strip height: 7.5 mm	white
Strip height: 8 mm	white
Strip height: 8.5 mm	white
Strip height: 9.5 mm	white
Strip height: 10 mm	white
Strip height: 10.5 mm	white
Strip height: 11 mm	white
Strip height: 12 mm	white

Ordering data		
Type	Order No.	Pcs. / Pkt.
TMT (EX5,5)R	0803062	1
TMT (EX6,2)R	0803063	1
TMT (EX6,5)R	0803064	1
TMT (EX7,5)R	0803065	1
TMT (EX8)R	0803066	1
TMT (EX8,5)R	0803067	1
TMT (EX9,5)R	0828295	1
TMT (EX10)R	0803068	1
TMT (EX10,5)R	0803070	1
TMT2 (EX11)R	0802683	1
TMT (EX12)R	0803071	1
TMT (EX5,5)R CUS	0803072	1
TMT (EX6,2)R CUS	0803073	1
TMT (EX6,5)R CUS	0803075	1
TMT (EX7,5)R CUS	0803076	1
TMT (EX8)R CUS	0803077	1
TMT (EX8,5)R CUS	0803078	1
TMT (EX9,5)R CUS	0803079	1
TMT (EX10)R CUS	0803080	1
TMT (EX10,5)R CUS	0803081	1
TMT2 (EX11)R CUS	0830811	1
TMT (EX12)R CUS	0803082	1

Locking tool to snap into the TMT... materials <sup>2)</sup>	
	orange

Accessories		
TMT TOOL	0816650	1

TMT ... terminal marking for terminal blocks from Phoenix Contact and other manufacturers



	TMT (EX5,5)R	TMT (EX6,2)R	TMT (EX6,5)R	TMT (EX7,5)R	TMT (EX8)R	TMT (EX8,5)R	TMT (EX9,5)R	TMT (EX10)R	TMT (EX10,5)R	TMT2 (EX11)R	TMT (EX12)R
<b>TMT- markers, roll</b>	0803062	0803063	0803064	0803065	0803066	0803067	0828295	0803068	0803070	0802683	0803071
Strip height	5.5	6.2	6.5	7.5	8	8.5	9.5	10	10.5	10.8	12
<b>Terminal manufacturer</b>											
Phoenix Contact		■					■				
Fuji Electronics Industry					■			■			
IDEC	■			■			■	■			
KASUGA	■		■				■				
TOGI						■		■			■
WAGO (2001 ...- 2016 ...)										■	
Yoshida Electronics	■		■	■		■		■	■		■

# Marking systems, tools, and mounting material

## Conductor and cable marking - MARKING system

### Clip-on UniCard conductor marking

Can be marked using:



Thermal transfer for sheets and cards



UV LED technology



Direct laser marking

PRINTED  
FOR YOU



32 markers  
for conductor diameters of 2 to 2.9 mm

- The UCT-WMCO ... UniCard marking range includes markers for the subsequent marking of conductors by clipping on
- Secure tight fit even in the event of vibrations
- The markers, which are supplied in uniform sheets, can be marked quickly and easily with the TOPMARK LASER, THERMOMARK CARD PLUS, and the BLUEMARK... printers
- The format automatically ensures printing with a high level of positional accuracy
- Large-surface labeling in a space-saving design
- The sheets provide space for including function texts
- Labeling service: Phoenix Contact can custom-label all UniCard markers in accordance with your requirements

#### General data

Can be marked with	
Number of individual labels	
Number of individual labels per strip	
Material	
Inflammability class according to UL 94	
Temperature range	[°C]
Wipe resistance	
Components	
Conductor diameter range	[mm]
Conductor cross section range	[mm <sup>2</sup> ]

#### Technical data

THERMOMARK CARD PLUS • THERMOMARK CARD • BLUEMARK CLED • BLUEMARK LED • TOPMARK LASER
32
8
PC
V0
-40 ... 120
DIN EN 61010-1 (VDE 0411-1)
Free from silicone, halogen, and cadmium
2 ... 2.9
0.5 ... 1.5

Description	Color
UniCard, for subsequent labeling of conductors	
Lettering field size: 12 x 4 mm	white
Lettering field size: 18 x 4 mm	white
UniCard, for subsequent labeling of conductors, labeled acc. to customer specifications <sup>1)</sup>	
Lettering field size: 12 x 4 mm	white
Lettering field size: 18 x 4 mm	white

#### Ordering data

Type	Order No.	Pcs. / Pkt.
UCT-WMCO 2,9 (12X4)	0830780	9
UCT-WMCO 2,9 (18X4)	0830781	9
UCT-WMCO 2,9 (12X4) CUS	0830788	1
UCT-WMCO 2,9 (18X4) CUS	0830789	1

Magazine, for THERMOMARK CARD ..., for accommodating: UCT-WMCO ...

#### Accessories

THERMOMARK CARD-UCT-MAG25	0802935	1
---------------------------	---------	---

#### Notes:

<sup>1)</sup> For an ordering example, see page 358 in main catalog 5.





**32 markers**  
for conductor diameters of 2.9 to 3.5 mm



**32 markers**  
for conductor diameters of 3.5 to 4.1 mm



**32 markers**  
for conductor diameters of 4.1 to 4.7 mm

Technical data
THERMOMARK CARD PLUS • THERMOMARK CARD • BLUEMARK CLED • BLUEMARK LED • TOPMARK LASER
32
8
PC
V0
-40 ... 120
DIN EN 61010-1 (VDE 0411-1)
Free from silicone, halogen, and cadmium
2.9 ... 3.5
1.5 ... 2.5

Technical data
THERMOMARK CARD PLUS • THERMOMARK CARD • BLUEMARK CLED • BLUEMARK LED • TOPMARK LASER
32
8
PC
V0
-40 ... 120
DIN EN 61010-1 (VDE 0411-1)
Free from silicone, halogen, and cadmium
3.5 ... 4.1
2.5 ... 4

Technical data
THERMOMARK CARD PLUS • THERMOMARK CARD • BLUEMARK CLED • BLUEMARK LED • TOPMARK LASER
32
8
PC
V0
-40 ... 120
DIN EN 61010-1 (VDE 0411-1)
Free from silicone, halogen, and cadmium
4.1 ... 4.7
2.5 ... 6

Ordering data		
Type	Order No.	Pcs. / Pkt.
UCT-WMCO 3,5 (12X4)	0830782	7
UCT-WMCO 3,5 (18X4)	0830783	7
UCT-WMCO 3,5 (12X4) CUS	0830790	1
UCT-WMCO 3,5 (18X4) CUS	0830791	1

Ordering data		
Type	Order No.	Pcs. / Pkt.
UCT-WMCO 4,1 (12X4)	0830784	7
UCT-WMCO 4,1 (18X4)	0830785	7
UCT-WMCO 4,1 (12X4) CUS	0830792	1
UCT-WMCO 4,1 (18X4) CUS	0830793	1

Ordering data		
Type	Order No.	Pcs. / Pkt.
UCT-WMCO 4,7 (12X4)	0830786	6
UCT-WMCO 4,7 (18X4)	0830787	6
UCT-WMCO 4,7 (12X4) CUS	0830794	1
UCT-WMCO 4,7 (18X4) CUS	0830795	1

Accessories		
THERMOMARK CARD-UCT-MAG25	0802935	1

Accessories		
THERMOMARK CARD-UCT-MAG25	0802935	1

Accessories		
THERMOMARK CARD-UCT-MAG25	0802935	1

## Conductor and cable marking - MARKING system

### UniCard cable marking for assembly with cable binders



- The UCT-WMTBA ... UniCard marking range includes markers that can be secured using standard cable binders
- The markers, which are supplied in uniform sheets, can be marked quickly, easily, and accurately with the TOPMARK LASER, THERMOMARK CARD, THERMOMARK CARD PLUS, and BLUEMARK CLED
- The format automatically ensures printing with a high level of positional accuracy
- For large-surface marking of conductors and cables > 5 mm in diameter
- The sheets provide space for including function texts
- Thanks to their angular shape the markers fit perfectly onto cables
- Labeling service: Phoenix Contact can custom-label all UniCard markers in accordance with your requirements

Can be marked using:



Thermal transfer for sheets and cards



UV LED technology



Direct laser marking

PRINTED  
FOR YOU



15 markers for conductor diameter > 5 mm

#### General data

Can be marked with	
Number of individual labels	
Number of individual labels per strip	
Material	
Inflammability class according to UL 94	
Temperature range	[°C]
Components	
Cable diameter range	[mm]

#### Technical data

THERMOMARK CARD PLUS • THERMOMARK CARD • BLUEMARK CLED • BLUEMARK LED • TOPMARK LASER
15
5
PC
V0
-40 ... 120
Free from silicone, halogen, and cadmium
> 5

Description	Color
<b>UniCard</b> , for assembly with cable binders	
Lettering field size: 24 x 4 mm	white
	yellow
Lettering field size: 29 x 6 mm	white
	yellow
Lettering field size: 40 x 17 mm	white
	yellow
<b>UniCard</b> , for assembly with cable binders, labeled acc. to customer specifications <sup>1)</sup>	
Lettering field size: 24 x 4 mm	white
	yellow
Lettering field size: 29 x 6 mm	white
	yellow
Lettering field size: 40 x 17 mm	white
	yellow

#### Ordering data

Type	Order No.	Pcs. / Pkt.
UCT-WMTBA (24X4)	1014082	10
UCT-WMTBA (24X4) YE	1014083	10
UCT-WMTBA (24X4) CUS	1014088	1
UCT-WMTBA (24X4) YE CUS	1014089	1

#### Notes:

For cable binders up to 5 mm wide.

For matching cable binders, see page 574 onwards in main catalog 5 or the product area on our website at phoenixcontact.net/products.

<sup>1)</sup> For an ordering example, see page 358 in main catalog 5.

**Magazine**, for THERMOMARK CARD ... for accommodating: UCT-WMTBA ...

#### Accessories

Accessories	Order No.	Pcs. / Pkt.
THERMOMARK CARD-UCT-MAG27	0802989	1



PRINTED  
FOR YOU



**12 markers**  
for conductor diameter > 6 mm

PRINTED  
FOR YOU



**3 markers**  
for conductor diameter > 6 mm

Technical data
THERMOMARK CARD PLUS • THERMOMARK CARD • BLUEMARK CLED • BLUEMARK LED • TOPMARK LASER
12
4
PC
V0
-40 ... 120
Free from silicone, halogen, and cadmium
> 6

Technical data
THERMOMARK CARD PLUS • THERMOMARK CARD • BLUEMARK CLED • BLUEMARK LED • TOPMARK LASER
3
1
PC
V0
-40 ... 120
Free from silicone, halogen, and cadmium
> 6

Ordering data		
Type	Order No.	Pcs. / Pkt.
UCT-WMTBA (29X6)	1014084	10
UCT-WMTBA (29X6) YE	1014085	10
UCT-WMTBA (29X6) CUS	1014090	1
UCT-WMTBA (29X6) YE CUS	1014091	1

Ordering data		
Type	Order No.	Pcs. / Pkt.
UCT-WMTBA (40X17)	1014086	10
UCT-WMTBA (40X17) YE	1014087	10
UCT-WMTBA (40X17) CUS	1014092	1
UCT-WMTBA (40X17) YE CUS	1014093	1

Accessories		
THERMOMARK CARD-UCT-MAG27	0802989	1

Accessories		
THERMOMARK CARD-UCT-MAG27	0802989	1

## Conductor and cable marking - MARKING system

### Plastic cable markers for insert labels, for assembly with cable binders



- KMK HP ... plastic cable markers for marking and bundling conductors and cables indoors
- Inflammability class V0 acc. to UL 94
- The KMK HP... cable markers are particularly suitable for use in the railway industry, traffic technology, and building technology thanks to their outstanding material properties
- The KMK... versions have eyelets and are attached with cable binders
- The printed insert label is protected from dirt by the sealing cap
- Labeling service: Phoenix Contact can custom-label all insert labels for plastic cable markers in accordance with your requirements



#### Notes:

For matching cable binders, see page 574 onwards in main catalog 5 or the product area on our website at phoenixcontact.net/products.



Lettering field size: 25 x 6 mm, for cable diameter > 6 mm

#### General data

Material	PC
Inflammability class according to UL 94	V0
Temperature range	-40 ... 125 [°C]
Components	Halogen-free

Description	Color
<b>Cable marker carrier</b> for cable binder assembly	transparent

**UniCard**, insert strip for KMK... cable marker carriers, can be marked with THERMOMARK CARD... and BLUEMARK CLED

Lettering field size: 25 x 6 mm, 15-section  
 Lettering field size: 29 x 8 mm, 15-section  
 Lettering field size: 60 x 15 mm, 3-section  
 Lettering field size: 40 x 17 mm, 3-section

**UniCard**, insert strips for KMK... cable marker carriers, **marked according to customer specifications**

Lettering field size: 25 x 6 mm, 15-section  
 Lettering field size: 29 x 8 mm, 15-section  
 Lettering field size: 40 x 17 mm, 3-section  
 Lettering field size: 60 x 15 mm, 3-section

**UniSheet**, 0.5 mm thick, inflammability class V0 according to UL 94  
 84-section, lettering field size: 25 x 6 mm  
 48-section, lettering field size: 29 x 8 mm  
 9-section, lettering field size: 60 x 15 mm  
 16-section, lettering field size: 40 x 17 mm

**Insert labels for thermal transfer printer**, halogen-free

Lettering field size: 25 x 6 mm, 5000 labels per roll

Lettering field size: 29 x 8 mm, 5400 labels per roll

Lettering field size: 60 x 15 mm, 2500 labels per roll

Lettering field size: 40 x 17 mm, 2300 labels per roll

**Cable binder**, inflammability class according to UL 94: V0, halogen-free, temperature range: -40°C ... 85 °C, maximum bundle Ø [mm]/minimum tensile strength [N]

35 / 130

50 / 220

79 / 220

**Magazine**, for THERMOMARK CARD ..., for accommodating UCT-EMP ...

#### Technical data

PC  
 V0  
 -40 ... 125  
 Halogen-free

#### Ordering data

Type	Order No.	Pcs. / Pkt.
KMK HP (25X6)	0830720	100

#### Accessories

UCT-EMP (25X6)	1014117	10
UCT-EMP (25X6) CUS	1014121	1
US-EMP (25X6)-1	0802754	10
EMT (25X6)R	0817264	1
WT-HP HF 3,6X140	0830982	100
WT-HP HF 4,8X200	0830983	100
WT-HP HF 4,5X290	0830984	100
THERMOMARK CARD-UCT-MAG26	0802988	1



Lettering field size: 29 x 8 mm,  
for cable diameter > 6 mm



Lettering field size: 60 x 15 mm,  
for cable diameter > 9 mm



Lettering field size: 40 x 17 mm,  
for cable diameter > 9 mm

Technical data			Technical data			Technical data		
PC V0 -40 ... 125 Halogen-free			PC V0 -40 ... 125 Halogen-free			PC V0 -40 ... 125 Halogen-free		
Ordering data			Ordering data			Ordering data		
Type	Order No.	Pcs. / Pkt.	Type	Order No.	Pcs. / Pkt.	Type	Order No.	Pcs. / Pkt.
KMK HP (29X8)	0830721	100	KMK HP (60X15)	0830722	50	KMK HP (40X17)	0830723	50
Accessories			Accessories			Accessories		
UCT-EMP (29X8)	1014118	10	UCT-EMP (60X15)	1014119	10	UCT-EMP (40X17)	1014120	10
UCT-EMP (29X8) CUS	1014122	1	UCT-EMP (40X17) CUS	1014124	1	UCT-EMP (60X15) CUS	1014123	1
US-EMP (29X8)	0829436	10	US-EMP (60X15)	0828781	10	US-EMP (40X17)	0829437	10
EMT (29X8)R	0817277	1	EMT (60X15)R	0801846	10	EMT (40X17)R	0817293	1
WT-HP HF 3,6X140 WT-HP HF 4,8X200 WT-HP HF 4,5X290	0830982 0830983 0830984	100 100 100	WT-HP HF 3,6X140 WT-HP HF 4,8X200 WT-HP HF 4,5X290	0830982 0830983 0830984	100 100 100	WT-HP HF 3,6X140 WT-HP HF 4,8X200 WT-HP HF 4,5X290	0830982 0830983 0830984	100 100 100
THERMOMARK CARD-UCT-MAG26	0802988	1	THERMOMARK CARD-UCT-MAG26	0802988	1	THERMOMARK CARD-UCT-MAG26	0802988	1

## Conductor and cable marking - MARKING system

### Plastic cable markers for insert labels, for assembly with cable binders



- KMK UV ... plastic cable markers for marking and bundling conductors and cables outdoors
- The KMK UV... cable markers are ultra-transparent, impact resistant, and have excellent weathering resistance. At the same time, they also possess outstanding chemical resistance
- The KMK... versions have eyelets and are attached with cable binders
- The printed insert label is protected from dirt by the sealing cap
- Labeling service: Phoenix Contact can custom-label all insert labels for plastic cable markers in accordance with your requirements



Notes:
For matching cable binders, see page 574 onwards in main catalog 5 or the product area on our website at phoenixcontact.net/products.
<sup>1)</sup> WT-UV HF...BK cable binders are weatherproof and UV resistant according to ISO 4892 (after QUV-B 600 hours) for up to 10 years.



Lettering field size: 25 x 6 mm, for cable diameter > 6 mm

General data	
Material	PA
Inflammability class according to UL 94	HB
Temperature range	-40 ... 100 [°C]
Components	Halogen-free

Technical data		
PA		
HB		
-40 ... 100		
Halogen-free		

Description	Color
<b>Cable marker carrier</b> for cable binder assembly	transparent

Ordering data		
Type	Order No.	Pcs. / Pkt.
KMK UV (25X6)	1014106	100

**UniCard**, insert strip for KMK... cable marker carriers, can be marked with THERMOMARK CARD... and BLUEMARK CLED

### Accessories

Lettering field size: 25 x 6 mm, 15-section  
 Lettering field size: 29 x 8 mm, 15-section  
 Lettering field size: 60 x 15 mm, 3-section  
 Lettering field size: 40 x 17 mm, 3-section

UCT-EMP (25X6)	1014117	10
----------------	---------	----

**UniCard**, insert strips for KMK... cable marker carriers, marked according to customer specifications

UCT-EMP (25X6) CUS	1014121	1
--------------------	---------	---

Lettering field size: 25 x 6 mm, 15-section  
 Lettering field size: 29 x 8 mm, 15-section  
 Lettering field size: 40 x 17 mm, 3-section  
 Lettering field size: 60 x 15 mm, 3-section

US-EMP (25X6)-1	0802754	10
-----------------	---------	----

**UniSheet**, 0.5 mm thick, inflammability class V0 according to UL 94  
 84-section, lettering field size: 25 x 6 mm  
 48-section, lettering field size: 29 x 8 mm  
 9-section, lettering field size: 60 x 15 mm  
 16-section, lettering field size: 40 x 17 mm

EMT (25X6)R	0817264	1
-------------	---------	---

**Insert labels for thermal transfer printer**, halogen-free

Lettering field size: 25 x 6 mm, 5000 labels per roll

Lettering field size: 29 x 8 mm, 5400 labels per roll

Lettering field size: 60 x 15 mm, 2500 labels per roll

Lettering field size: 40 x 17 mm, 2300 labels per roll

WT-UV HF 3,6X140 BK	3240832	100
WT-UV HF 4,5X200 BK	3240834	100
WT-UV HF 4,5X290 BK	3240835	100

**Cable binder**, halogen-free, inflammability class according to UL 94: V2, maximum bundle Ø [mm] / min. tensile strength [N]!

35 / 130

50 / 220

79 / 220

**Magazine**, for THERMOMARK CARD ..., for accommodating UCT-EMP ...

THERMOMARK CARD-UCT-MAG26	0802988	1
---------------------------	---------	---



Lettering field size: 29 x 8 mm,  
for cable diameter > 6 mm



Lettering field size: 60 x 15 mm,  
for cable diameter > 9 mm



Lettering field size: 40 x 17 mm,  
for cable diameter > 9 mm

Technical data		
PA		
HB		
-40 ... 100		
Halogen-free		

Ordering data		
Type	Order No.	Pcs. / Pkt.
KMK UV (29X8)	1014107	100

Accessories		
UCT-EMP (29X8)	1014118	10
UCT-EMP (29X8) CUS	1014122	1
US-EMP (29X8)	0829436	10
EMT (29X8)R	0817277	1
WT-UV HF 3,6X140 BK	3240832	100
WT-UV HF 4,5X200 BK	3240834	100
WT-UV HF 4,5X290 BK	3240835	100
THERMOMARK CARD-UCT-MAG26	0802988	1

Technical data		
PA		
HB		
-40 ... 100		
Halogen-free		

Ordering data		
Type	Order No.	Pcs. / Pkt.
KMK UV (60X15)	1014108	50

Accessories		
UCT-EMP (60X15)	1014119	10
UCT-EMP (60X15) CUS	1014124	1
US-EMP (60X15)	0828781	10
EMT (60X15)R	0801846	10
WT-UV HF 3,6X140 BK	3240832	100
WT-UV HF 4,5X200 BK	3240834	100
WT-UV HF 4,5X290 BK	3240835	100
THERMOMARK CARD-UCT-MAG26	0802988	1

Technical data		
PA		
HB		
-40 ... 100		
Halogen-free		

Ordering data		
Type	Order No.	Pcs. / Pkt.
KMK UV (40X17)	1014109	50

Accessories		
UCT-EMP (40X17)	1014120	10
UCT-EMP (60X15) CUS	1014123	1
US-EMP (40X17)	0829437	10
EMT (40X17)R	0817293	1
WT-UV HF 3,6X140 BK	3240832	100
WT-UV HF 4,5X200 BK	3240834	100
WT-UV HF 4,5X290 BK	3240835	100
THERMOMARK CARD-UCT-MAG26	0802988	1

## Device marking - MARKING system

### Adhesive UniCard device marking for applications in process engineering

Can be marked using:



UV LED technology



Unlabeled or labeled according to customer specifications

- The UC-EMLP...-EX UniCard labeling range includes self-adhesive device markers with good adhesive properties
- The marking requirements in terms of legibility, adhesion, and wipe resistance in potentially explosive areas (ATEX), according to IEC/EN 60079-0, can also be ensured following storage in typical gas atmospheres. Phoenix Contact developed these sheets especially for process engineering which is where these requirements typically arise. These sheets meet the requirements for wipe resistance according to DIN EN 61010-1 against aggressive media such as acetone, ethanol, and MEK
- Thanks to the special adhesive, the marker meets the demanding requirements of process engineering
- The markers can be marked quickly, easily, and inexpensively with the BLUEMARK CLED and LED
- By using modern UV LED printing technology, a highly resistant and optimum printing quality can be achieved, which is resistant to solvents and suitable for use even under harsh industrial conditions
- Labeling service: Phoenix Contact can custom-label all markers according to your requirements

General data	
Can be marked with	
Material	
Inflammability class according to UL 94	
Temperature range	[°C]
Wipe resistance	
Components	

Technical data	
BLUEMARK CLED • BLUEMARK LED	
PA	
V2	
-40 ... 120	
DIN EN 61010-1 (VDE 0411-1)	
Free from silicone and halogen	

Description	Color
<b>UniCard, with self-adhesive plastic labels</b>	
6-section, lettering field size: 22 x 22 mm	white
8-section, lettering field size: 27 x 18 mm	white
6-section, lettering field size: 27 x 27 mm	white
4-section, lettering field size: 49 x 15 mm	white
3-section, lettering field size: 60 x 30 mm	white
<b>UniCard, with self-adhesive plastic labels, labeled according to customer specifications<sup>1)</sup></b>	
6-section, lettering field size: 22 x 22 mm	white
8-section, lettering field size: 27 x 18 mm	white
6-section, lettering field size: 27 x 27 mm	white
4-section, lettering field size: 49 x 15 mm	white
3-section, lettering field size: 60 x 30 mm	white

Ordering data			
Type	Order No.	Pcs. / Pkt.	
UC-EMLP (22X22)-EX	0803224	10	
UC-EMLP (27X18)-EX	0803225	10	
UC-EMLP (27X27)-EX	0803226	10	
UC-EMLP (49X15)-EX	0803227	10	
UC-EMLP (60X30)-EX	0803228	10	
UC-EMLP (22X22)-EX CUS	0803229	1	
UC-EMLP (27X18)-EX CUS	0803230	1	
UC-EMLP (27X27)-EX CUS	0803231	1	
UC-EMLP (49X15)-EX CUS	0803232	1	
UC-EMLP (60X30)-EX CUS	0803233	1	

**Notes:**  
<sup>1)</sup> For an ordering example, see page 358 in main catalog 5.

**Adhesive device marking for applications in process engineering**



Can be marked using:



Thermal transfer for rolls



Unlabeled or labeled according to customer specifications

- The EML...-EX self-adhesive device markers have been specifically developed for marking various types of equipment in the Ex area
- The marking requirements in terms of legibility, adhesion, and wipe resistance in potentially explosive areas (ATEX), according to IEC/EN 60079-0, can also be ensured following storage in typical gas atmospheres. Phoenix Contact developed these labels especially for process engineering, which is where these requirements typically arise. These labels meet the requirements for wipe resistance according to DIN EN 61010-1 against aggressive media such as acetone, ethanol, and MEK
- They are only suitable in conjunction with the TM- RIBBON110-EX
- Thanks to the special surface and adhesive, the marker meets the demanding requirements of process engineering
- If high-quality ink ribbons are used, the labeling is resistant to solvents, making it suitable for use even under harsh industrial conditions
- A wide range of marker sizes and colors are available for custom designs
- The special packaging protects rolls that have already been started from the dirt found in industrial environments
- **Designation example: EML (10x4)R-EX**  
Lettering field size: 10 x 4 mm  
Type of packaging: roll
- Marking service: Phoenix Contact can custom-mark all EML markers according to your requirements

General data	
Can be marked with	
Material	
Temperature range	[°C]
Wipe resistance	
Components	

Technical data	
THERMOMARK ROLL • THERMOMARK ROLL X1 • THERMOMARK X1.1 • THERMOMARK X1.2 • THERMOMARK S1.1	
Polyester	
-40 ... 150	
DIN EN 61010-1 (VDE 0411-1)	
Free from silicone and halogen	

Description	Color
<b>Labels</b>	
10,000 labels per roll	white
2500 labels per roll	white
2500 labels per roll	white
2500 labels per roll	white
1000 labels per roll	white
400 labels per roll	white
300 labels per roll	white
300 labels per roll	white
250 labels per roll	white
<b>Labels, labeled according to customer requirements<sup>1)</sup></b>	
8 labels per strip	white
5 labels per strip	white
4 labels per strip	white
3 labels per strip	white
2 labels per strip	white
1 label per strip	white
1 label per strip	white
1 label per strip	white
1 label per strip	white

Ordering data		
Type	Order No.	Pcs. / Pkt.
EML (10X4)R-EX	0803251	1
EML (15X9)R-EX	0803253	1
EML (20X8)R-EX	0803254	1
EML (30X20)R-EX	0803255	1
EML (40X25)R-EX	0803256	1
EML (70X50)R-EX	0803257	1
EML (100X40)R-EX	0803258	1
EML (100X73)R-EX	0803259	1
EML (100X90)R-EX	0803260	1
EML (10X4)R-EX CUS	0803261	1
EML (15X9)R-EX CUS	0803262	1
EML (20X8)R-EX CUS	0803263	1
EML (30X20)R-EX CUS	0803264	1
EML (40X25)R-EX CUS	0803266	1
EML (70X50)R-EX CUS	0803267	1
EML (100X40)R-EX CUS	0803268	1
EML (100X73)R-EX CUS	0803269	1
EML (100X90)R-EX CUS	0803270	1

<b>Ink ribbon</b> , length: 300 m, width: 110 mm, color: black
--

Accessories		
Accessories	Order No.	Pcs. / Pkt.
TM-RIBBON 110-EX	0803211	1

**Notes:**  
<sup>1)</sup> For an ordering example, see page 358 in main catalog 5.

## Device marking - MARKING system

### UniSheet device marking for sticking onto rough or textured surfaces

Can be marked using:

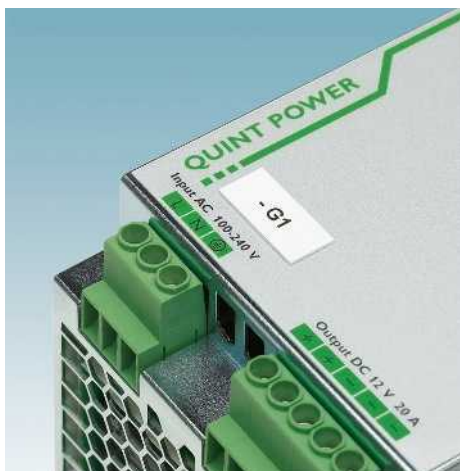

Thermal transfer for sheets and cards



Unlabeled or labeled according to customer specifications

- The US-EMLP-HA ... UniSheet marking range has excellent adhesive properties on rough, textured, and low-energy surfaces, thanks to the special adhesive
- The markers, which are supplied in uniform sheets, can be marked quickly, easily, and cost-effectively using THERMOMARK CARD and THERMOMARK CARD PLUS
- The perforated markers are easy to separate and can be easily fitted
- The sheets provide space for including function texts
- Marking service: Phoenix Contact can custom-mark all US-EMLP-HA ... markers according to your requirements

#### General data

Can be marked with	
Material	
Inflammability class according to UL 94	
Temperature range	[°C]
Wipe resistance	
Components	

#### Technical data

THERMOMARK CARD PLUS • THERMOMARK CARD
PVC
V0
-30 ... 80
DIN EN 61010-1 (VDE 0411-1)
Silicone-free

Description	Color
<b>UniSheet</b> , with self-adhesive plastic labels, 0.5 mm thick	
108-section, lettering field size: 17 x 7 mm	white
70-section, lettering field size: 20 x 9 mm	white
4-section, lettering field size: 60 x 30 mm	white
4-section, lettering field size: 60 x 30 mm	silver
2-section, lettering field size: 85.6 x 54 mm	white
2-section, lettering field size: 85.6 x 54 mm	silver
<b>UniSheet</b> , with self-adhesive plastic labels, 0.5 mm thick, <b>labeled acc. to customer specifications</b>	
108-section, lettering field size: 17 x 7 mm	white
70-section, lettering field size: 20 x 9 mm	white
4-section, lettering field size: 60 x 30 mm	white
4-section, lettering field size: 60 x 30 mm	silver
2-section, lettering field size: 85.6 x 54 mm	white
2-section, lettering field size: 85.6 x 54 mm	silver

#### Ordering data

Type	Order No.	Pcs. / Pkt.
<b>US-EMLP-HA (17X7)</b>	<b>0830988</b>	10
<b>US-EMLP-HA (20X9)</b>	<b>0830989</b>	10
<b>US-EMLP-HA (60X30)</b>	<b>0830990</b>	10
<b>US-EMLP-HA (60X30) SR</b>	<b>0830991</b>	10
<b>US-EMLP-HA (85,6X54)</b>	<b>0830992</b>	10
<b>US-EMLP-HA (85,6X54) SR</b>	<b>0830993</b>	10
<b>US-EMLP-HA (17X7) CUS</b>	<b>0830994</b>	1
<b>US-EMLP-HA (20X9) CUS</b>	<b>0830995</b>	1
<b>US-EMLP-HA (60X30) CUS</b>	<b>0830996</b>	1
<b>US-EMLP-HA (60X30) SR CUS</b>	<b>0830997</b>	1
<b>US-EMLP-HA (85,6X54) CUS</b>	<b>0830998</b>	1
<b>US-EMLP-HA (85,6X54) SR CUS</b>	<b>0830999</b>	1

**Magazine**, for THERMOMARK CARD..., for accommodating all US materials

#### Accessories

THERMOMARK CARD-US-MAG1	5146451	1
-------------------------	---------	---





### RFMARK RFID system



#### RFMARK high-frequency handheld

RFMARK HF is a powerful handheld device for contact-free reading and writing of HF transponders. The RFMARK HF can identify and locate HF transponders. Data can be received, transmitted, and scanned on a contact-free basis and without visual contact.



#### RFMARK ultra-high frequency handheld

The RFMARK UHF is a powerful handheld device which is equipped with a crossed dipole antenna. This allows UHF transponders to be written and read regardless of their position. Bulk detection of 150 transponders per second is also possible.

#### Dimensions

General data	[mm]
Degree of protection	
Temperature range	[°C]
Weight	[kg]
Frequency	[MHz]
Read/write format	[m]
Memory	
Display	

#### Description

##### Handheld, high-frequency range

Range up to 0.1 m, depending on the environment

##### Handheld, ultra-high frequency range

Range up to 2.0 m, depending on the environment



#### Advantages and accessories

Advantages of the RFMARK readers:

- Easy operation via touch screen
- Low power consumption and long battery life
- 1D laser scanner and 2D imager

#### Matching accessories

You can make optimum use of the RFMARK readers and ensure they are as user-friendly as possible with our reader accessories.



#### Radio-frequency identification, RFID

Used for contact-free identification, data exchange, and localization of transponders/tags without visual contact. With the aid of an RFID handheld device, which acts as a transmitter and receiver, data is transmitted to and received from a transponder/tag by electromagnetic waves (UHF) or a magnetic field (HF).

**Charging and data exchange station**, with replacement battery, connection for USB 2.0 and Ethernet, charger

for RFMARK HF, with power supply unit and power cable (EU/UK)

for RFMARK UHF, with power supply unit and power cable (EU/UK/US/CN)

#### Replacement battery

for RFMARK HF, Li-ion 7.4 V, 2.6 Ah

for RFMARK UHF, Li-ion 3.7 V, 2.26 Ah

**Protective bag**, with strap, protection against splash water, touch screen operation not possible

for RFMARK HF

for RFMARK UHF

**Belt pouch**, touch screen can be operated

for RFMARK HF

for RFMARK UHF

**Read and write USB stick**,

Crossed dipole antenna, range: 1 m



Handheld, high-frequency (HF)



Handheld, ultra-high frequency (UHF)

Technical data		
Width	Length	Height
90	250	45
IP54		
-20 ... 55		
0.55		
13.56		
Max. 0.1		
256 MB DDR RAM		
3.5" color touch screen		

Technical data		
Width	Length	Height
60	147	39
IP54		
-20 ... 55		
0.235		
868		
Max. 2		
256 MB DDR RAM		
2.2" color touch screen		

Ordering data		
Type	Order No.	Pcs. / Pkt.
RFMARK HF	5148010	1

Ordering data		
Type	Order No.	Pcs. / Pkt.
RFMARK UHF	5148011	1

Accessories		
Type	Order No.	Pcs. / Pkt.
RFMARK HF POWER LINK STATION	5148013	1
RFMARK HF/ACCU	5148015	1
RFMARK HF PROTECTION CASE	5148017	1
RFMARK HF/BELTPOUCH	5148018	1

Accessories		
Type	Order No.	Pcs. / Pkt.
RFMARK UHF POWER LINK STATION	5148014	1
RFMARK UHF/ACCU	5148016	1
RFMARK UHF PROTECTION CASE	5148020	1
RFMARK UHF/BELTPOUCH	5148021	1
RFMARK UHF FD	5148012	1

## System marking - MARKING system

### Adhesive system marking with RFID transponder

Can be marked using:



UV LED technology



Unlabeled

### Markers

- The UCT-PMLP-RFID ... UniCard labeling range includes self-adhesive markers for system marking, with good adhesive properties
- The markers are integrated in a uniform matrix and can be printed quickly and easily with the BLUEMARK CLED
- The format automatically ensures printing with a high level of positional accuracy
- The wide temperature range means that the labels can be used both indoors and outdoors

### Inlays

- The HF transponder inlays comply with ISO 15693 and ISO 18000-3 mode 1
- The UHF transponder inlays comply with EPC Class 1 Gen 2 and ISO 18000-6C

General data	
Can be marked with	BLUEMARK CLED
Material	PVC/PC
Temperature range	-25 ... 80 [°C]
Wipe resistance	DIN EN 61010-1 (VDE 0411-1)
Components	Free from silicone and cadmium

### Technical data

BLUEMARK CLED		
PVC/PC		
-25 ... 80		
DIN EN 61010-1 (VDE 0411-1)		
Free from silicone and cadmium		

Description	Color
UniCard, self-adhesive plastic label, with integrated HF transponder 1-section, lettering field size: 90 x 38 mm, reading performance: max. 0.1 m, depending on the environment	white
UniCard, self-adhesive plastic label, with integrated UHF transponder 1-section, lettering field size: 90 x 38 mm, reading performance: max. 2.0 m, depending on the environment	white

### Ordering data

Type	Order No.	Pcs. / Pkt.
UCT-PMLP-RFID/HF (90X38)	0830956	10





Unlabeled

**Technical data**

BLUEMARK CLED  
 PVC/PC  
 -25 ... 80  
 DIN EN 61010-1 (VDE 0411-1)  
 Free from silicone and cadmium

**Ordering data**

Type	Order No.	Pcs. / Pkt.
UCT-PMLP-RFID/UHF (90X38)	0830957	10

## System marking - MARKING system

### System marking for inserting into marker carriers, with RFID transponder



Can be marked using:



UV LED technology



Unlabeled

### Markers

- The UniCard UCT-PMP-RFID ... marking range includes markers for system marking, specially designed to fit into existing CARRIER-PMP (108x38) marker carriers
- The markers are integrated in a uniform matrix and can be printed quickly and easily with the BLUEMARK CLED
- The format automatically ensures printing with a high level of positional accuracy
- The wide temperature range means that the labels can be used both indoors and outdoors
- The CARRIER-PMP ... marker carriers can be equipped with colored PMST markers according to DIN 2403

### Inlays

- The HF transponder inlays comply with ISO 15693 and ISO 18000-3 mode 1
- The UHF transponder inlays comply with EPC Class 1 Gen 2 and ISO 18000-6C

### Notes:

1) RVT-PA...BK rivet for fixing PMST ... marker strips to the CARRIER-PMP ...



### General data

Can be marked with	
Material	
Inflammability class according to UL 94	
Temperature range	[°C]
Wipe resistance	
Components	

### Technical data

BLUEMARK CLED
PVC/PC
V0
-25 ... 80
DIN EN 61010-1 (VDE 0411-1)
Free from silicone and cadmium

### Description

Description	Color
UniCard, plastic label with integrated HF transponder	
1-section, lettering field size: 90 x 38 mm	white
UniCard, plastic label with integrated UHF transponder	
1-section, lettering field size: 90 x 38 mm	white
1-section, lettering field size: 90 x 38 mm	orange
Marking label for conveyed fluids, for equipping CARRIER-PMP ... according to DIN 2403	
	white
	yellow
	orange
	red
	violet
	green
	gray
	brown
	blue
	black
Marker carriers, for UCT-PMP ... labels that can be inserted	
Carrier size: 108 x 38 mm	black

### Ordering data

Type	Order No.	Pcs. / Pkt.
UCT-PMP-RFID/HF (90X38)	0830954	10

### Accessories

Mounting strip, can be screwed, for CARRIER-PMP ...

Plastic body-bound rivet, 3.5 mm diameter<sup>1)</sup>



Unlabeled



For securing with rivets on CARRIER-PMP ...



For mounting with screws, screw clamps, or cable binders

### Technical data

BLUEMARK CLED  
PVC/PC  
V2  
-25 ... 80  
DIN EN 61010-1 (VDE 0411-1)  
Free from silicone and cadmium

### Technical data

-  
PVC  
V0  
-30 ... 80  
DIN EN 61010-1 (VDE 0411-1)  
Silicone-free

### Technical data

-  
PA  
V2  
-40 ... 105  
-  
Free from silicone and halogen

### Ordering data

Type	Order No.	Pcs. / Pkt.
UCT-PMP-RFID/UHF (90X38)	0830955	10
UCT-PMP-RFID/UHF (90X38) OG	0803048	10

### Ordering data

Type	Order No.	Pcs. / Pkt.
PMST (9X38)	0830960	100
PMST (9X38) YE	0830964	100
PMST (9X38) OG	0830966	100
PMST (9X38) RD	0830962	100
PMST (9X38) VT	0830967	100
PMST (9X38) GN	0830961	100
PMST (9X38) GY	0830963	100
PMST (9X38) BN	0830968	100
PMST (9X38) BU	0830969	100
PMST (9X38) BK	0830965	100

### Ordering data

Type	Order No.	Pcs. / Pkt.
CARRIER-PMP (108X38)	0830958	10

### Accessories

Type	Order No.	Pcs. / Pkt.
------	-----------	-------------

### Accessories

Type	Order No.	Pcs. / Pkt.
------	-----------	-------------

### Accessories

Type	Order No.	Pcs. / Pkt.
SCRT 9X16-27	0830970	50
SCRT 9X25-40	0830971	50
SCRT 9X40-60	0830972	25
SCRT 9X60-80	0830973	25
SCRT 9X80-100	0830974	25
SCRT 9X100-120	0830975	25
SCRT 9X140-160	0830976	25
SCRT 9X160-180	0830977	25
SCRT 9X180-200	0830978	25
RVT-PA 3,5 BK	0830959	100

## System marking - MARKING system

### System marking for sticking on or inserting into marker carriers



- The UCT-PMLP ... UniCard marking range includes self-adhesive markers for system marking, with good adhesive properties
- The UniCard UCT-PMP ... marking range includes markers for system marking, specially designed to fit into existing CARRIER-PMP (108x38) marker carriers
- The format automatically ensures printing with a high level of positional accuracy
- The wide temperature range means that the labels can be used both indoors and outdoors
- Labeling service: Phoenix Contact can custom-label all UniCard markers in accordance with your requirements
- The CARRIER-PMP ... marker carriers can be equipped with colored PMST markers according to DIN 2403

Notes:
1) For an ordering example, see page 358 in main catalog 5.
2) RVT-PA...BK rivet for fixing PMST ... marker strips to the CARRIER-PMP ...

Can be marked using:



UV LED technology



For self-adhesion

Dimensions	
<b>General data</b>	
Can be marked with	
Material	
Inflammability class according to UL 94	
Temperature range	[°C]
Wipe resistance	
Components	

Technical data		
Width	Length	Height

BLUEMARK CLED		
PC		
V0		
-40 ... 120		
DIN EN 61010-1 (VDE 0411-1)		
Free from silicone and halogen		

Description	Color
<b>UniCard</b> , plastic label, for gluing	
1-section, lettering field size: 90 x 38 mm	white
<b>UniCard</b> , plastic label, for gluing, marked according to customer specifications <sup>1)</sup>	
1-section, lettering field size: 90 x 38 mm	white
<b>UniCard</b> , plastic label	
1-section, lettering field size: 90 x 38 mm	white
1-section, lettering field size: 90 x 38 mm	blue
1-section, lettering field size: 90 x 38 mm	violet
1-section, lettering field size: 90 x 38 mm	yellow
<b>UniCard</b> , plastic label, marked according to customer specifications <sup>1)</sup>	
1-section, lettering field size: 90 x 38 mm	white
1-section, lettering field size: 90 x 38 mm	blue
1-section, lettering field size: 90 x 38 mm	violet
1-section, lettering field size: 90 x 38 mm	yellow

### Ordering data

Type	Order No.	Pcs. / Pkt.
<b>UCT-PMLP (90X38)</b>	0803041	10
<b>UCT-PMLP (90X38) CUS</b>	0803042	1

Marking label for conveyed fluids, for equipping CARRIER-PMP ... according to DIN 2403	Color
	white
	yellow
	orange
	red
	violet
	green
	gray
	brown
	blue
	black
<b>Marker carriers, for UCT-PMP ... labels that can be inserted</b>	
Carrier size: 108 x 38 mm	black

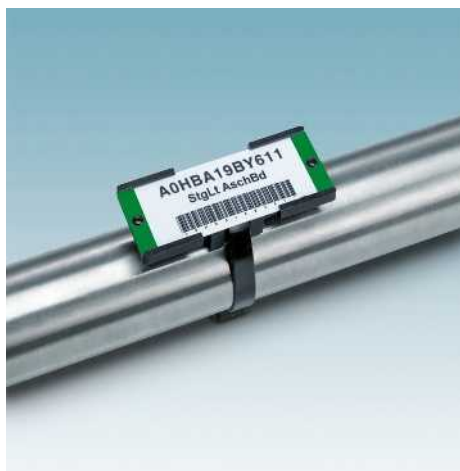

Mounting strip, can be screwed, for CARRIER-PMP ...
<b>Plastic body-bound rivet, 3.5 mm diameter<sup>2)</sup></b>

### Accessories

--	--	--



PRINTED  
FOR YOU



For inserting into a marker carrier



For securing with rivets on CARRIER-PMP ...



For mounting with screws, screw clamps, or cable binders

Technical data		
Width	Length	Height

BLUEMARK CLED  
PC  
V0  
-40 ... 120  
DIN EN 61010-1 (VDE 0411-1)  
Free from silicone and halogen

Technical data		
Width	Length	Height

-  
PVC  
V0  
-30 ... 80  
DIN EN 61010-1 (VDE 0411-1)  
Silicone-free

Technical data		
Width	Length	Height

-  
PA  
V2  
-40 ... 105  
-  
Free from silicone and halogen

Ordering data		
---------------	--	--

Type	Order No.	Pcs. / Pkt.
UCT-PMP (90X38)	0803039	10
UCT-PMP (90X38) BU	0803047	10
UCT-PMP (90X38) VT	0803132	10
UCT-PMP (90X38) YE	0803133	10
UCT-PMP (90X38) CUS	0803040	1
UCT-PMP (90X38) BU CUS	8190566	1
UCT-PMP (90X38) VT CUS	8190707	1
UCT-PMP (90X38) YE CUS	8190708	1

Ordering data		
---------------	--	--

Type	Order No.	Pcs. / Pkt.
PMST (9X38)	0830960	100
PMST (9X38) YE	0830964	100
PMST (9X38) OG	0830966	100
PMST (9X38) RD	0830962	100
PMST (9X38) VT	0830967	100
PMST (9X38) GN	0830961	100
PMST (9X38) GY	0830963	100
PMST (9X38) BN	0830968	100
PMST (9X38) BU	0830969	100
PMST (9X38) BK	0830965	100

Ordering data		
---------------	--	--

Type	Order No.	Pcs. / Pkt.
CARRIER-PMP (108X38)	0830958	10

Accessories		
-------------	--	--

--	--	--

Accessories		
-------------	--	--

--	--	--

Accessories		
-------------	--	--

SCRT 9X16-27	0830970	50
SCRT 9X25-40	0830971	50
SCRT 9X40-60	0830972	25
SCRT 9X60-80	0830973	25
SCRT 9X80-100	0830974	25
SCRT 9X100-120	0830975	25
SCRT 9X140-160	0830976	25
SCRT 9X160-180	0830977	25
SCRT 9X180-200	0830978	25
RVT-PA 3,5 BK	0830959	100



### Material editor

The material editor allows you to create the required markings directly in the application environment via tablet PC or smartphone.



### Product scanner

The product scanner allows you to quickly and easily call up technical data for the marking material or directly mark it via the material editor.

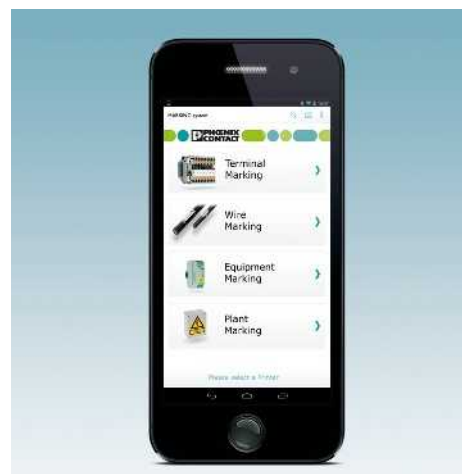

### Search assistant

With the search assistant, you can carry out a structured, targeted search for suitable marking materials, even without knowledge of this field.

**MARKING system app**



**Notes:**  
For additional information on the THERMOMARK LINE printers, please refer to the product area on our website at [phoenixcontact.net/products](http://phoenixcontact.net/products) or main catalog 5.

You can retrofit your THERMOMARK LINE printer with MINI FD BLUETOOTH. MINI FD BLUETOOTH enables reliable, wireless data exchange between THERMOMARK LINE printers and mobile, Bluetooth-capable devices, such as smartphones and tablet PCs. This means that print orders can be conveniently sent to the printer using the MARKING system app.



General data	
Application	USB/Bluetooth
Transmission speed	3 [Mbps]

Description
<b>Bluetooth USB adapter</b>

**Thermal transfer printer for cards**, incl. European power cable, US power cable, USB cable, DVD with CLIP PROJECT ADVANCED, CD with multilingual user manual/driver/firmware, DIN A5 printed English/German user manual, magazine for UCT-TM materials, magazine for US materials, one unit pack UCT-TM 6, one unit pack US-EMLP (85.6 x 54), one ink ribbon (50-meter sample roll)

**Thermal transfer printer for material off the roll**, including European power cable, US power cable, USB cable, DVD with CLIP PROJECT ADVANCED, CD with multilingual user manual/driver/firmware, A5 printed English/German user manual, one roll of EML (20x8) labels containing 1000 labels, one ink ribbon (50 meters)

**Thermal transfer printer**, incl. connecting cable, Windows® printer driver and operating instructions, software

Technical data		
USB/Bluetooth		
3		

Ordering data		
Type	Order No.	Pcs. / Pkt.
MINI FD BLUETOOTH	0830986	1

Accessories		
THERMOMARK CARD	5146464	1
THERMOMARK CARD PLUS	5146481	1
THERMOMARK ROLL	5146477	1
THERMOMARK ROLL X1	5146723	1
THERMOMARK X1.2	5146231	1

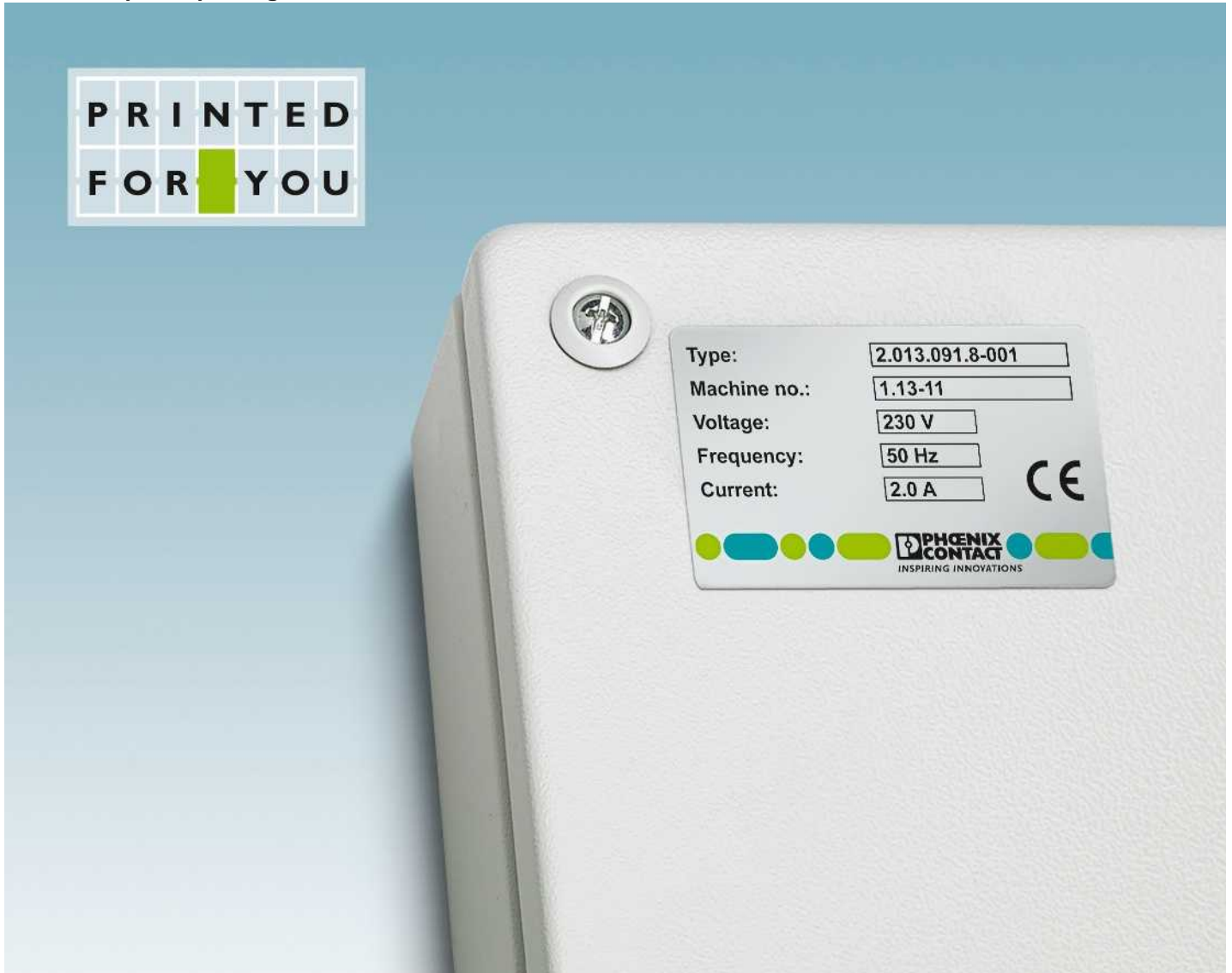

#### Easy ordering process via CLIP PROJECT and e-mail

You can create customer-specific marking quickly and easily via CLIP PROJECT and order via e-mail.



#### New: color-printed marking solutions

You can use marking materials in UniCard and UniSheet format as well as metal labels for color printing.



#### We mark marking materials according to your requirements

All materials which can be marked according to customer requirements are indicated with this symbol.

**CLIP PROJECT**  
advanced and professional

**CLIP PROJECT advanced**

The CLIP PROJECT advanced program enables the quick planning and configuration of terminal strips for the control cabinet and field as well as custom-marking of terminal blocks, cables, and lines, plus devices and systems:

- The automatic correction function performs a logical test of the terminal strips and automatically adds the necessary accessories such as covers and end brackets
- The terminal strip configurator enables the distributed arrangement of individual terminal strips on different DIN rails
- 3D preview and complete documentation of the assembled DIN rails, such as order and mounting lists
- Numerous sorting and filter functions for efficient management of your print jobs
- One software for all output devices: CLIP PROJECT controls all marking technologies from Phoenix Contact, from the BLUEMARK CLED high-speed printer, the THERMOMARK LINE thermal transfer printer, and the plotter to the TOPMARK LASER desktop laser marker
- Continual extension of the output devices and marking materials via updates
- Automatic Internet update
- Intuitive Windows® user interface
- CLIP PROJECT supports all marking materials from Phoenix Contact, from V4A stainless steel and aluminum to plastics such as polyamide or polycarbonate or foils made of PVC or polyester. These are stored with preset parameters

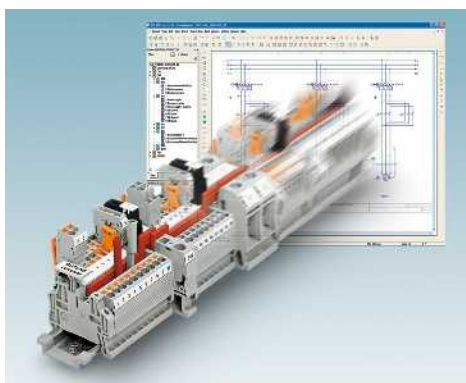

**General data**

Software interface

**System requirements**

Operating systems

**Description**

**CLIP PROJECT advanced, planning and marking software,**  
German/English/French/Dutch/Italian/Spanish/Russian/Polish/Hungarian/Czech/Turkish/Portuguese/Chinese and Japanese

**CLIP PROJECT professional, planning and marking software, with template designer,**  
German/English/French/Dutch/Italian/Spanish/Russian/Polish/Hungarian/Czech/Turkish/Portuguese/Chinese and Japanese

**Technical data**

EPLAN 5.7  
EPLAN Electric P8  
AUCOTEC ELCAD  
AUCOTEC Engineering Base  
AUCOTEC RUPLAN  
ZUKEN E³  
Bentley Promis-e  
WSCAD  
IGE XAO  
PC-Schematic AUTOMATION  
SDProjet SPAC

MS Windows XP SP3, MS Windows Vista,  
MS Windows 7 (32/64-bit), MS Windows 8 (32/64-bit)

**Ordering data**

Type	Order No.	Pcs. / Pkt.
CLIP-PROJECT ADVANCED	5146040	1
CLIP-PROJECT PROFESSIONAL	5146053	1

**CLIP PROJECT professional**

- The professional version also includes an efficient template designer, which can be used to design signs of your choice and to adapt existing material descriptions
- Graphics, various barcode types, and geometric elements such as squares, circles, and lines can be accessed for design work
- Data can also be imported into the templates from various data sources

**CRIMPHANDY** - portable hand-held machine. Stripping and crimping in just one step.



Simply insert the conductor, ...



... stripping and crimping is carried out automatically, ...



... and you're done.



Easy operation thanks to the automatic stripping and crimping function. One tool for both work steps, resulting in time savings of approx. 75%. The device signals the operating states clearly by means of colored LEDs.

Automatic cross-section monitoring prevents faulty crimping as a result of incorrect cross sections. The device displays a corresponding message.

The efficiency is particularly evident when used in combination with the push-in connection terminal block PT: conductors are processed and contacted in no time at all.



Integrated magazine for ferrules in strip form. The automatic feed enables conductors to be crimped one after another.

Easy to remove collecting chamber for discarded insulation. This guarantees a clean working environment. At around just 430 grams, the device can also easily be used inside the control cabinet.

Integrated lithium-ion polymer rechargeable battery for up to 2000 crimps. The fast charger provided charges the battery, which is easy to replace, in just 60 minutes.

## Tools - TOOL fox

### CRIMPHANDY, portable hand-held machine, for a 1.0 to 1.5 mm<sup>2</sup> conductor cross section



The product innovation for switchgear manufacturing – the CRIMPHANDY. With this portable hand-held machine, you can strip and crimp your conductors in under two seconds – 75% less time than before.

- The matching reel ferrules are suitable for use on all modular terminal blocks, particularly those from the CLIPLINE complete system:
- UT screw connection terminal blocks
- ST spring-cage connection terminal blocks
- PT push-in connection terminal blocks
- COMBI plug-in connection solutions

#### Notes:

An application video can be found in the download area for the relevant product on our website at [phoenixcontact.net/products](http://phoenixcontact.net/products).



1.0 mm<sup>2</sup> conductor cross section

Dimensions	
	[mm]
General data	
Weight	[kg]
Conductor	[mm <sup>2</sup> ]
Working cycle	[s]
Compression	

Technical data		
Width	Length	Height
43	205	70
0.43	- 1	< 2
Square crimp		

Description
<b>Portable hand-held machine, battery-powered</b> , for ferrules, 1.0 mm <sup>2</sup> , incl. battery and charger, 100 - 240 V, in a robust case for standard PVC conductors
<b>Portable hand-held machine, battery-powered</b> , for ferrules, 1.5 mm <sup>2</sup> , incl. battery and charger, 100 - 240 V, in a robust case for standard PVC conductors

Ordering data		
Type	Order No.	Pcs. / Pkt.
CF CRIMPHANDY 1,0	1212465	1

<b>Reel ferrules</b> , 1.0 mm <sup>2</sup> , 8 mm, with plastic sleeve, according to DIN 46228-4, 50 pieces per strip, 20 strips per unit pack Red, according to DIN 46228-4 Yellow, special color
<b>Reel ferrules</b> , 1.5 mm <sup>2</sup> , 8 mm, with plastic sleeve, according to DIN 46228-4, 50 pieces per strip, 20 strips per unit pack Black, according to DIN 46228-4 Red, special color
<b>Replacement battery</b> , for CF CRIMPHANDY..., Li-ion 7.4 V, 0.76 Ah
<b>Replacement charger</b> , for CF CRIMPHANDY..., 100 - 240 V AC

Accessories		
Type	Order No.	Pcs. / Pkt.
AI 1,0-8 RD-S	1212523	1000
AI 1,0-8 YE-S	1212782	1000
CF CRIMPHANDY/ACCU	1212518	1
CF CRIMPHANDY/CHARGER	1212519	1







1.5 mm<sup>2</sup> conductor cross section

**Technical data**

Width	Length	Height
43	205	70

0.43  
- 1.5  
< 2  
Square crimp

**Ordering data**

Type	Order No.	Pcs. / Pkt.
CF CRIMPHANDY 1,5	1212466	1

**Accessories**

AI 1,5-8 BK-S	1212524	1000
AI 1,5-8 RD-S	1212781	1000
CF CRIMPHANDY/ACCU	1212518	1
CF CRIMPHANDY/CHARGER	1212519	1

## Tools - TOOL fox

### CUS tool sets, equipped with tools according to customer requirements



You can put together your own CUS tool set according to your individual requirements

- Six different bags are available, designed for typical applications
- Easily select your tools at [phoenixcontact.net/products](http://phoenixcontact.net/products)

**Notes:**

The CUS tool sets can be put together according to your requirements in the product area on our website at [phoenixcontact.net/products](http://phoenixcontact.net/products).

**TOOLS FOR YOU**



**Tool case, lockable, with straps**

**Description**

**Toolbox**, lockable, with adjustable strap, equipped with: cable cutter, diagonal cutter, micro cutter, stripping and sheath stripping tools, crimping tool set, combination, needle-nose, and water pump pliers, VDE bladed and Phillips screwdrivers, control cabinet key, voltage tester, ferrule box, blades, tape measure, continuity tester, marking tool, ring, open-end, and adjustable wrench set, T-handle hexagonal wrench, safety glasses, hammer, 41-piece ratchet socket wrench set, 1/4"

**Toolbox**, lockable, with adjustable strap, equipped with tools according to customer requirements

**Ordering data**

Type	Order No.	Pcs. / Pkt.
TOOL-CASE	1212629	1
TOOL-CASE CUS	1200072	1

### CUS tool sets, equipped with tools according to customer requirements

**Notes:**

The CUS tool sets can be put together according to your requirements in the product area on our website at [phoenixcontact.net/products](http://phoenixcontact.net/products).

**TOOLS FOR YOU**



**Tool bag, with document and laptop compartments**

**TOOLS FOR YOU**



**Tool bag, with strap**

**Ordering data**

Type	Order No.	Pcs. / Pkt.
TOOL-BAG CUS	1200081	1

**Description**

**Tool bag**, with adjustable straps, with document and laptop compartments, equipped with tools according to customer requirements

**Tool bag**, with strap, very comfortable to carry thanks to ergonomic shape, equipped with tools according to customer requirements

**Ordering data**

Type	Order No.	Pcs. / Pkt.
TOOL-CARRIER CUS	1200082	1

**CUS tool sets, equipped with tools according to customer requirements**



**Notes:**  
The CUS tool sets can be put together according to your requirements in the product area on our website at [phoenixcontact.net/products](http://phoenixcontact.net/products).

**TOOLS FOR YOU**



**Tool belt pouch**

**Description**  
**Tool belt pouch, with two robust internal pockets, equipped with tools according to customer requirements**

Ordering data		
Type	Order No.	Pcs. / Pkt.
TOOL-BELTPOUCH CUS	1200084	1

- Individual tool sets, with cutting, stripping, crimping, installation, and testing tools from the TOOL fox tool range
- Rugged and heavy-duty tool bags
- Select from six types of bag and equip these with the required tools at [phoenixcontact.net/products](http://phoenixcontact.net/products)

**CUS tool sets, equipped with tools according to customer requirements**

**Notes:**  
The CUS tool sets can be put together according to your requirements in the product area on our website at [phoenixcontact.net/products](http://phoenixcontact.net/products).

**TOOLS FOR YOU**



**Tool case**

**TOOLS FOR YOU**



**Wrap-up tool bag**

Ordering data		
Type	Order No.	Pcs. / Pkt.
TOOL-KIT CUS	1200085	1

**Description**  
**Tool case, with elastic straps to hold the tools in place, equipped with tools according to customer requirements**

**Wrap-up tool bag, with slide-in compartments and robust elastic straps to hold the tools in place, equipped with tools according to customer requirements**

Ordering data		
Type	Order No.	Pcs. / Pkt.
TOOL-WRAP CUS	1200083	1

## Tools - TOOL fox

### CRIMPFOX pliers, laser marked according to customer specifications



- Customize your crimping tool!
- You can now use robust laser engraving to mark CRIMPFOX pliers
- Individual laser marking prevents your tools from being mixed up

#### Notes:

Matching accessories can be found in main catalog 5 or the product area on our website at [phoenixcontact.net/products](http://phoenixcontact.net/products).

<sup>1)</sup> Tools with customer-specific laser marking can be ordered quickly and easily in the product area on our website at [phoenixcontact.net/products](http://phoenixcontact.net/products).

- The advantages of our CRIMPFOX tools:
- Consistently high crimping quality
  - Unlockable pressure lock
  - Marked die stations for precise processing of the relevant cross sections
  - Easy work thanks to improved force transfer
  - Ergonomically designed, non-slip handles
  - CRIMPFOX 6S-F CUS: the self-adjusting die automatically adapts to the connector size

#### Description

**Crimping pliers**, for ferrules, according to DIN 46228-1 and -4, five marked die stations, **laser marked according to customer specifications<sup>1)</sup>**

Lateral insertion, 0.25 - 6.0 mm<sup>2</sup>, unlockable pressure lock, trapezoidal crimp

Front insertion, 0.5 - 6 mm<sup>2</sup>, square crimp

**Crimping pliers**, unlockable pressure lock, lateral insertion, oval crimp, **laser marked according to customer specifications<sup>1)</sup>**

For insulated cable lugs (light green, red), 0.14 - 1 mm<sup>2</sup>, three marked die stations

For insulated cable lugs (red, blue), 0.75 - 2.5 mm<sup>2</sup>, two marked die stations

**Crimping pliers**, for uninsulated cable lugs, three marked die stations, 0.34 - 2.5 mm<sup>2</sup>, unlockable pressure lock, lateral insertion, indent crimp, **laser marked according to customer specifications<sup>1)</sup>**

**Crimping pliers**, for uninsulated slip-on sleeves 2.8/4.8/6.3 mm, three marked die stations, B-crimp, 0.1 - 1.5 mm<sup>2</sup>, unlockable pressure lock, lateral insertion, **laser marked according to customer specifications<sup>1)</sup>**

**Crimping pliers**, for ferrules according to DIN 46228-1 and -4, self-adjusting die, trapezoidal crimp, 0.5 - 6 mm<sup>2</sup>, unlockable pressure lock, **laser marked according to customer specifications<sup>1)</sup>**

Front insertion  
Lateral insertion

**Crimping pliers**, three marked die stations, 0.75 - 6 mm<sup>2</sup>, oval crimp, unlockable pressure lock, lateral insertion, **laser marked according to customer specifications<sup>1)</sup>**

For insulated cable lugs, symmetrical (red, blue, yellow)  
For insulated cable lugs, asymmetrical (red, blue, yellow)

**Crimping pliers**, for ferrules according to DIN 46228-1 and -4, WM crimp, unlockable pressure lock, lateral insertion, **laser marked according to customer specifications<sup>1)</sup>**

Three marked die stations, 10 - 25 mm<sup>2</sup>

Two marked die stations, 35 - 50 mm<sup>2</sup>

TOOLS FOR YOU



TOOLS FOR YOU



TOOLS FOR YOU



Ordering data			Ordering data			Ordering data		
Type	Order No.	Pcs. / Pkt.	Type	Order No.	Pcs. / Pkt.	Type	Order No.	Pcs. / Pkt.
CRIMPFOX 6 CUS	1212767	1						
CRIMPFOX 6S-F CUS	1212769	1						
CRIMPFOX-RC1 1 CUS	1212772	1						
CRIMPFOX-RC1 2,5 CUS	1212773	1						
CRIMPFOX-RC 2,5 CUS	1212777	1						
CRIMPFOX-SC 1,5 CUS	1212779	1						
			CRIMPFOX 6T-F CUS	1212771	1			
			CRIMPFOX 6T CUS	1212770	1			
						CRIMPFOX-RC1 6 CUS	1212774	1
						CRIMPFOX-RC1 6-1 CUS	1212775	1
						CRIMPFOX 25R CUS	1212765	1
						CRIMPFOX 50R CUS	1212766	1

## Tools - TOOL fox

### CRIMPFOX and WIREFOX pliers, laser marked according to customer specifications



- Customize your crimping and stripping tool!
- You can now use robust laser engraving to mark CRIMPFOX and WIREFOX pliers
- Individual laser marking prevents your tools from being mixed up

#### Notes:

Matching accessories can be found in main catalog 5 or the product area on our website at [phoenixcontact.net/products](http://phoenixcontact.net/products).

<sup>1)</sup> Tools with customer-specific laser marking can be ordered quickly and easily in the product area on our website at [phoenixcontact.net/products](http://phoenixcontact.net/products).

- The advantages of our WIREFOX tools:
- The special spring mechanism helps you to work precisely and safely
  - Ergonomically designed, non-slip handles
  - The WIREFOX pliers automatically adjust to different insulations and conductor diameters
  - Highly adjustable limit stop for the stripping length
  - Practical integrated wire cutter
  - Easily replaceable blade cassettes for different cross sections and insulation

#### Description

**Crimping pliers**, for uninsulated cable lugs, three marked die stations, indent crimp, unlockable pressure lock, lateral insertion, **laser marked according to customer specifications<sup>1)</sup>**

4 - 10 mm<sup>2</sup>  
10 - 25 mm<sup>2</sup>

**Crimping pliers**, for uninsulated slip-on sleeves 2.8/4.8/6.3 mm, three marked die stations, 0.5 - 6 mm<sup>2</sup>, B-crimp, unlockable pressure lock, lateral insertion, **laser marked according to customer specifications<sup>1)</sup>**

**Crimping pliers**, for ferrules according to DIN 46228, unlockable pressure lock, lateral insertion, **laser marked according to customer specifications<sup>1)</sup>**

Square crimp, 0.14 - 10 mm<sup>2</sup>

HEX crimp, 0.14 - 6 mm<sup>2</sup>

**Stripping tool**, self-adjusting, easily replaceable blade cassettes, stripping length of up to 18 mm, cutting capacity: up to 1.5 mm<sup>2</sup> solid, up to 10 mm<sup>2</sup> stranded, **laser marked according to customer specifications<sup>1)</sup>**

For cables and conductors from 0.1 - 4 mm<sup>2</sup>, specifically also intended for rubber and other kinds of special insulation

For cables and conductors from 1.5 - 6 mm<sup>2</sup>, specifically for short-circuit-proof cables and rubber insulation

For standard cables and conductors from 0.02 - 10 mm<sup>2</sup>

For standard cables and conductors from 4 - 16 mm<sup>2</sup>

TOOLS  
FOR YOU



TOOLS  
FOR YOU



TOOLS  
FOR YOU



Ordering data			Ordering data			Ordering data		
Type	Order No.	Pcs. / Pkt.	Type	Order No.	Pcs. / Pkt.	Type	Order No.	Pcs. / Pkt.
CRIMPFOX-RC 10 CUS	1212776	1						
CRIMPFOX-RC 25 CUS	1212778	1						
CRIMPFOX-SC 6 CUS	1212780	1						
			CRIMPFOX 10S CUS	1212764	1			
			CRIMPFOX 6H CUS	1212768	1			
						WIREFOX 4 CUS	1212762	1
						WIREFOX 6SC CUS	1212763	1
						WIREFOX 10 CUS	1212760	1
						WIREFOX 16 CUS	1212761	1



Surge protection for special applications  
**VAL-MS-AR...** Page 306



Surge protection for special applications  
**VAL-MS-T1/T2...** Page 307



Surge protection for NEMA  
**VAL-SQ NP...** Page 309



Surge protection for measurement and control technology  
**PT-IQ-2X2...** Page 310



Surge protection for measurement and control technology  
**PT-IQ-4X1...** Page 310



Surge protection for intrinsically safe circuits  
**PT-IQ...EX** Page 312



Surge protection for information technology  
**PT-IQ...** Page 313



Surge protection for telecommunications interfaces  
**DT-TELE-SHDSL** Page 314



Power supplies  
**QUINT POWER** Page 315



Power supplies  
**UNO POWER** Page 316





Mounting set  
BATTERY MOUNTING CASE Page 320



Soldering base element  
CB S-BE Page 321



Bridge plug  
CB RC BRIDGE Page 321

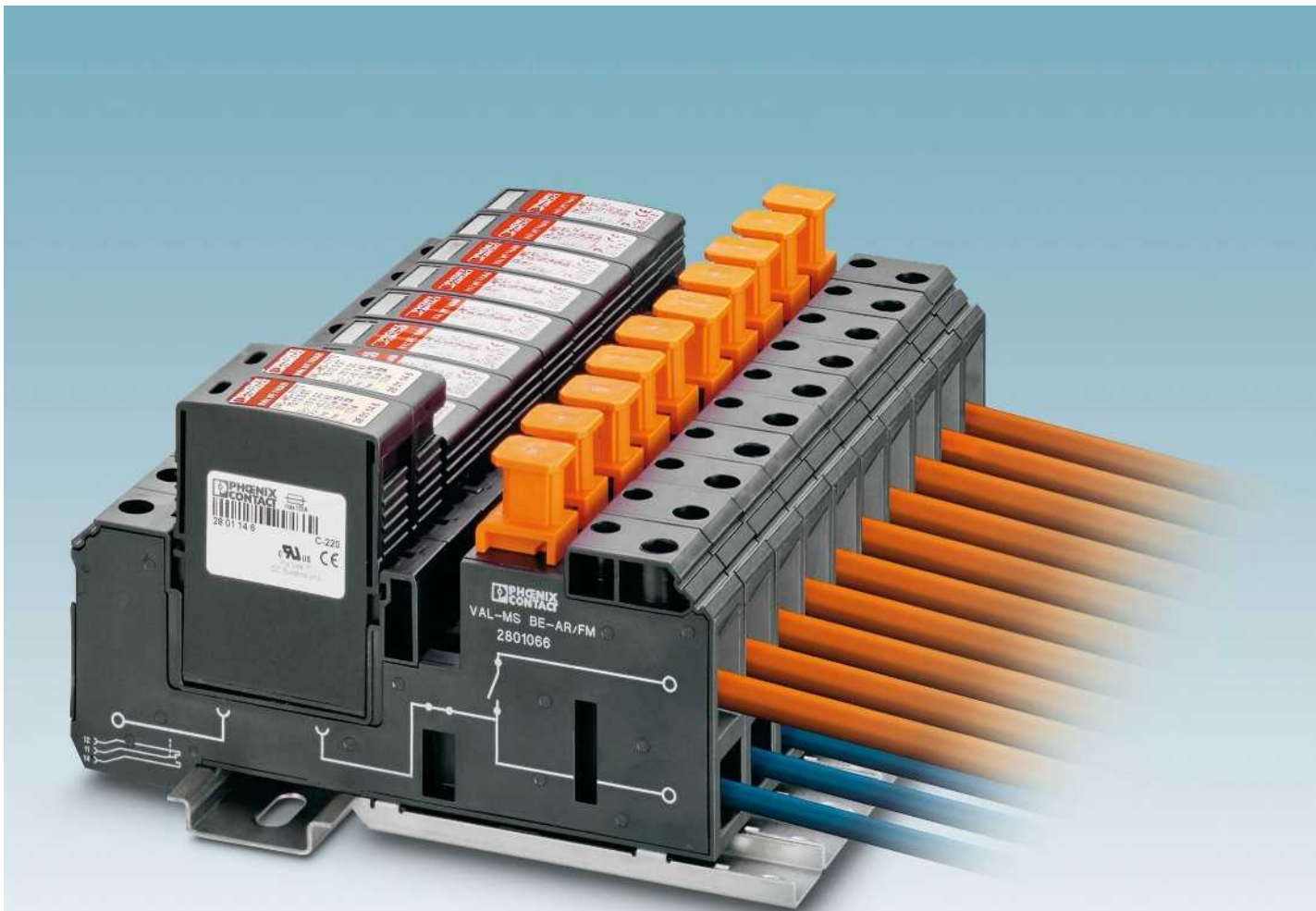

### VAL-MS-AR – surge protection for the American railway industry

The VAL-MS-AR surge protective devices offer reliable, touch-proof protection while also providing a connection block for railway and signaling systems.

The VAL-MS BE-AR... base element has been designed so that the field input and house output connections are on the same side. The ground connection is on the opposite side. The integrated isolator allows you to easily carry out field diagnostics and insulation measurements.

VAL-MS-AR... complies with the practices recommended by AREMA C&S. In contrast to conventional installation with bolts and nuts, the alternative connection technology with base elements and plugs considerably reduces the effort required for installation, tests, and repair measures.

In addition to the standard products, VAL-MS-AR... /FM feature a remote monitoring function. This means that immediate failure or the removal of a protective plug can be signaled via floating contacts.

### Features:

- Easy to replace, plug-in surge protection
- Protects systems against direct lightning strikes and coupled surge voltages
- Mechanical status indicator on each protective plug
- Optional remote signaling via floating PDTs
- Integrated isolator for insulation measurements and field diagnostics
- Screw terminal blocks for copper wire up to 4 AWG (25 mm<sup>2</sup>), solid, stranded, stripped or with sleeves
- Convenient marking options



### Field and house connection

Independent terminal points for field and house connection enable wiring from the field side and signal lines with one conductor each. The terminal points are designed for typical wire gauges for railway applications:

House: 20 - 6 AWG (0.5 – 15 mm<sup>2</sup>),

Field: 18 - 4 AWG (1.5 - 25 mm<sup>2</sup>).



### Disconnect and test point

Integrated isolator for carrying out diagnostics and insulation measurements without tampering with the installation. The disconnect knife remains connected to the field side for testing.



### Function monitoring

Each plug has an optical, mechanical status indicator. In the event of a fault, the status is changed via the thermal disconnect device. In the VAL-MS-AR.../FM versions, a floating PDT is thereby switched, so that the status can be remotely indicated.



### Protective plug, free of leakage current

VAL-MS...VF... plugs have a series connection consisting of a varistor and a spark gap. The advantage of this component combination is that no leakage currents flow in the passive state and therefore signals are not impaired.



### Lightning current plugs with latching

The "T1/T2" plugs are robust enough to cope with direct lightning current. They are heavier than standard plugs and are equipped with latching to keep them in place in the event of vibrations, shocks, and magnetic influences.



### Ground and bridging options

The base elements can be easily bridged together with low impedance using pre-assembled MPB bridges. The terminal points for the ground connection accommodate conductors up to 2 AWG (35 mm<sup>2</sup>).

# Surge protection and power supplies

## Surge protection and interference filters

### VAL-MS-AR surge protection with multifunctional base element

- Base element with isolator for easy field diagnostics and carrying out insulation measurements
- Independent inputs and outputs on one side of the base element, ground connection on the opposite side
- Optical, mechanical status indication for the individual arresters
- Disconnect device on each individual plug
- With or without floating remote indication contact
- Terminal block cases capable of bearing high-current, for solid or stranded conductors that are stripped or with sleeves

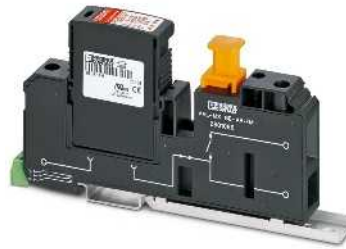

Type 1/2 lightning arrester SPD



Type 2 hybrid SPD

Total width 17.7 mm

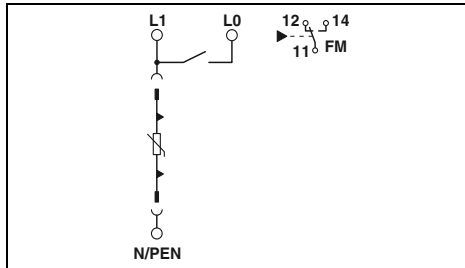

#### Technical data

Electrical data	... 75
IEC test classification/EN type	I/II/T1/T2
Nominal voltage $U_N$	60 V DC
Maximum continuous operating voltage $U_C$	-75 V DC
Impulse discharge curr. $I_{imp}$ (10/350) $\mu$ s	Peak value 12.5 kA
	Charge 6.25 As
	Specific energy 39.00 kJ/ $\Omega$
Nominal discharge current $I_n$ (8/20) $\mu$ s	12.5 kA
Max. discharge current $I_{max}$ (8/20) $\mu$ s	50 kA
Residual voltage Without reference direction	$\leq 0.6$ kV (at 5 kA)
Voltage protection level $U_p$ Without reference direction	$\leq 0.7$ kV
General data	
Dimensions W/H/D	17.7 mm/160 mm/77.5 mm
Connection data, Ground solid / stranded / AWG	1.5 ... 35 mm <sup>2</sup> /1.5 ... 35 mm <sup>2</sup> /15 - 2
Connection data, Field solid/stranded/AWG	1.5 ... 25 mm <sup>2</sup> /1.5 ... 25 mm <sup>2</sup> /12 - 4
Connection data, House solid/stranded/AWG	0.5 ... 15 mm <sup>2</sup> /0.5 ... 15 mm <sup>2</sup> /20 - 6
Temperature range	-40°C ... 80°C
Inflammability class in acc. with UL 94	V0
Remote indication contact	PDT, 1-pos.
Connection data solid / stranded / AWG	0.14 ... 1.5 mm <sup>2</sup> /0.14 ... 1.5 mm <sup>2</sup> /28 - 16
Max. operating voltage	250 V AC
Max. operating current	1.5 A AC (250 V AC)/1.5 A DC (30 V DC)

Total width 17.7 mm

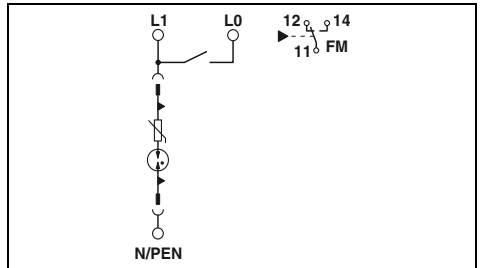

#### Technical data

... 75	... 350
II/T2	II/T2
60 V DC (5 V...48 V AC)	230 V AC
75 V AC/100 V DC	350 V AC/-
3 kA	3 kA
-	-
-	-
10 kA	10 kA
20 kA	20 kA
$\leq 350$ V (at 5 kA)	$\leq 1$ kV (at 5 kA)
$\leq 1.4$ kV	$\leq 1.2$ kV
	17.7 mm/160 mm/75 mm
	1.5 ... 35 mm <sup>2</sup> /1.5 ... 35 mm <sup>2</sup> /15 - 2
	1.5 ... 25 mm <sup>2</sup> /1.5 ... 25 mm <sup>2</sup> /12 - 4
	0.5 ... 15 mm <sup>2</sup> /0.5 ... 15 mm <sup>2</sup> /20 - 6
	-40°C ... 80°C
	V0
	PDT, 1-pos.
	0.14 ... 1.5 mm <sup>2</sup> /0.14 ... 1.5 mm <sup>2</sup> /28 - 16
	250 V AC
	1.5 A AC (250 V AC)/1.5 A DC (30 V DC)

#### Ordering data

Description	Type	Order No.	Pcs. / Pkt.
VAL-MS-AR, high-capacity lightning arrester			
without remote indication contact	VAL-MS-AR-T1/T2 75	2801491	10
with remote indication contact	VAL-MS-AR-T1/T2 75/FM	2801492	10
VAL-MS-AR, hybrid SPD			
without remote indication contact			
with remote indication contact			
without remote indication contact			
with remote indication contact			

#### Ordering data

Type	Order No.	Pcs. / Pkt.
VAL-MS-AR 75 VF	2801487	10
VAL-MS-AR 75 VF/FM	2801488	10
VAL-MS-AR 350 VF	2801489	10
VAL-MS-AR 350 VF/FM	2801490	10

#### Accessories

Protective plug, for inserting in base element	Type	Order No.	Pcs. / Pkt.
L-N / L-PEN 1L-N/PE	VAL-MS-T1/T2 75/12.5 ST	2801146	10
Base element, for individual assembly with protective connectors			
with remote indication contact	VAL-MS BE-AR/FM	2801066	10
without remote indication contact	VAL-MS BE-AR	2801065	10
Plug-in bridge			
2-pos.	FBS 2-18	2801068	10
MPB wiring bridge,			
57-pos.	MPB 18/1-57	2809238	1

#### Accessories

Type	Order No.	Pcs. / Pkt.
VAL-MS 75 VF ST	2805318	10
VAL-MS 350 VF ST	2856595	10
VAL-MS BE-AR/FM	2801066	10
VAL-MS BE-AR	2801065	10
FBS 2-18	2801068	10
MPB 18/1-57	2809238	1

### Lightning and surge arresters for 48 V DC applications

- Suitable for the protection of remote radio heads in telecommunications systems
- Extremely low voltage protection level  $U_p$  of < 400 V
- Consistent plug-in arresters, type 1/2
- Secure hold of plugs in the event of high lightning current loads and strong vibrations thanks to latching
- Thermal disconnect device for each individual plug
- Optical, mechanical status indication for the individual arresters
- Mechanical coding of all slots
- With or without floating remote indication contact
- Plugs can be checked with CHECKMASTER



Type 1/2 arrester for 48 V DC applications

Total width 35.6 mm

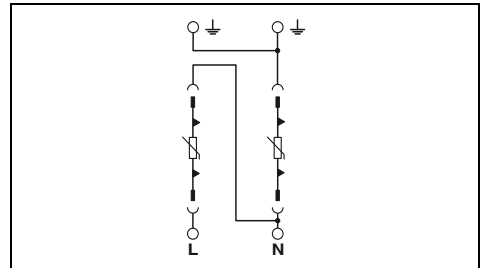

#### Technical data

Electrical data	... 48
IEC test classification/EN type	I/II/T1/T2
Nominal voltage $U_N$	60 V AC
Maximum continuous operating voltage $U_C$	75 V AC
Impulse discharge curr. $I_{imp}$ (10/350) $\mu$ s	Peak value 12.5 kA
	Charge 6.25 As
	Specific energy 39.00 kJ/ $\Omega$
Nominal discharge current $I_n$ (8/20) $\mu$ s	12.5 kA
Max. discharge current $I_{max}$ (8/20) $\mu$ s	30 kA
Voltage protection level $U_p$	$\leq 0.4$ kV
Backup fuse max. in acc. with IEC	160 A (gL/gG)
General data	
Dimensions W/H/D	35.6 mm/97 mm/77.5 mm
Connection data solid / stranded / AWG	1.5 ... 35 mm <sup>2</sup> /1.5 ... 25 mm <sup>2</sup> /15 - 2
Temperature range	-40°C ... 80°C
Inflammability class in acc. with UL 94	V0
Test standards	IEC 61643-11/EN 61643-11/UL 1449 ed. 3
Remote indication contact	PDT, 1-pos.
Connection data solid / stranded / AWG	0.14 ... 1.5 mm <sup>2</sup> /0.14 ... 1.5 mm <sup>2</sup> /28 - 16
Max. operating voltage	250 V AC
Max. operating current	1.5 A AC (250 V AC)/1.5 A DC (30 V DC)

#### Ordering data

Description	$U_C$	Type	Order No.	Pcs. / Pkt.
VALVETRAB-MS, varistor-based lightning arrester				
	75 V AC	VAL-MS-T1/T2 48/12.5/1+1V	2801532	1
	75 V AC	VAL-MS-T1/T2 48/12.5/1+1V-FM	2801533	1

#### Accessories

Replacement plug	L-N / L-PEN	VAL-MS-T1/T2 48/12.5 ST	2801242	10
Marking material		ZBN 18..., see Catalog 6, page 63		



VAL-SQ NP... provides modular surge protection for an entire house or a small company. The surge protective device consists of a base element and plug. It has the same base area as two standard 1 inch wide circuit breakers to enable installation in the corresponding distributor boxes. Initial installation must be performed by an electrically skilled person. If necessary, the surge protection plug can be replaced by the house owner.

The status indicator on the plug indicates the state of the surge protection. If the protection fails, the VAL-SQ NP... ST protective plug can be replaced quickly and easily. Up to now, components in all other products of this type had to be replaced by an electrically skilled person in the event of a fault.

The high-performance protective circuit features a discharge capacity of 32 kA per phase. The individual protective paths are protected thermally as well as against overcurrent.

The VAL-SQ NP... is suitable for single-phase 120/240 V applications with common neutral conductor and ground.

### Distributor box compatibility

VAL-SQ NP can be used in all distribution boxes for single-phase 120/240 AC SN systems with 1 inch pitch.

VAL-SQ NP... devices are compatible with the following distributor boxes:

#### Eaton

- BR series (prefix 1BR or B) distributor boxes

#### Siemens Industry, Inc.

- PL series (prefix P, PW or G)
- ES series (prefix S, SW or G)
- EQ series (prefix E or W)

#### General Electric Co.

- Powermark Gold series (prefix TL, TM or TP)

#### Schneider Electric USA Inc./ Square D Co.

- Homeline series (prefix HOM)

### Surge protection for distributor boxes in houses and small businesses

- Installs in NEMA-style distributor boxes with 1-inch pitch
- Uses the same footprint as two standard 1-inch pitch circuit breakers
- Suitable for single-phase 120/240 V AC systems
- 32 kA surge current capacity per phase
- 10 kA (UL) nominal surge discharge current ( $I_N$ )
- LEDs provide continuous feedback on the status of each phase
- UL 1449 3<sup>rd</sup> edition

#### Notes:

The products are offered exclusively for export outside the European Economic Area (EEA).



SPD for distributor boxes with 1-inch pitch

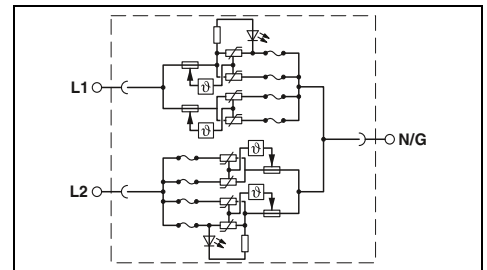

#### Technical data

Electrical data		
MCOV	L-L / L-N	350 V/175 V
Nominal voltage $U_N$		120 V AC
Maximum continuous operating voltage $U_C$		120 V AC
Voltage Protection Rating (VPR)		
	L-N / L-PE N-PE / L-L	800 V/ -/1200 V
Short-circuit current rating (SCCR)		10 kA
Nominal discharge current $I_N$		10 kA
General data		
UL Type		type 1
Degree of protection		IP20/NEMA 1
Error/status indicator		LEDs
Temperature range		-55°C ... 70°C
Test standards		UL 1449 3 <sup>rd</sup> edition

#### Ordering data

Description	Type	Order No.	Pcs. / Pkt.
<b>Plug and base assembly, 120/240 V AC single phase</b>			
for distributor boxes with 1-inch pitch	VAL-SQ NP 120-2-A 32	2800371	1

#### Accessories

Replacement plug	Type	Order No.	Pcs. / Pkt.
<b>Base element</b>			
	VAL-SQ NP 120-2-A 32 ST	2800369	1
	VAL-SQ NP 120-2-A BE	2800749	1

### PLUGTRAB PT-IQ

#### Notes:

For approvals and dimensional drawing, visit [phoenixcontact.net/products](http://phoenixcontact.net/products)

- Surge protection system
- Multi-level state monitoring
- Collective message about supply and remote module
- Multi-level, floating remote signaling
- System supplied via DIN rail bus
- Up to 28 protection modules per supply module
- Maximum ease of maintenance, thanks to the two-piece design
- Plugs are coded
- Impedance-neutral disconnection of plug for maintenance purposes
- Base element remains an integral part of the installation



**2 double conductors (loops), floating, 9/10 connection grounded directly**

Total width 17.7 mm

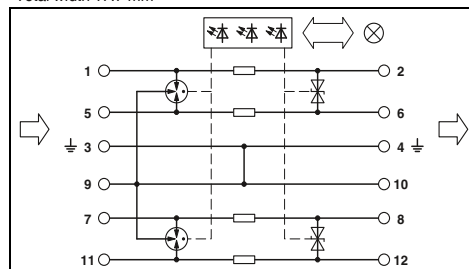

#### Technical data

Electrical data	... 5DC	... 48DC
IEC test classification/EN type	C1/C2/C3/D1	C1/C2/C3/D1
Maximum continuous operating voltage $U_c$	6 V DC/4 V AC	53 V DC/37 V AC
Impulse discharge curr. $I_{imp}$ (10/350) $\mu$ s	2.5 kA	2.5 kA
Nominal current $I_N$	700 mA (up to 50°C)	300 mA
Nominal discharge current $I_n$ (8/20) $\mu$ s		
Total surge current (8/20) $\mu$ s	10 kA/10 kA	10 kA/10 kA
Voltage protection level $U_p$	20 kA	20 kA
Resistance per path		
Core-core	$\leq 25 \text{ V}$ (C3 - 25 A)	$\leq 90 \text{ V}$ (C3 - 25 A)
Core-ground	$\leq 600 \text{ V}$ (C1 - 1 kV/500 A)	$\leq 600 \text{ V}$ (C1 - 1 kV/500 A)
	1.2 $\Omega$	1.2 $\Omega$
General data		
PT-IQ...PT dimensions W/H/D		17.7 mm/109.3 mm/77.5 mm
PT-IQ...UT dimensions W/H/D		17.7 mm/91.1 mm/77.5 mm
Connection data, push-in solid/stranded with ferrule/AWG		0.2 ... 4 mm <sup>2</sup> /0.2 ... 2.5 mm <sup>2</sup> /24 - 12
Connection data solid/stranded with ferrule/AWG		0.2 ... 4 mm <sup>2</sup> /0.2 ... 2.5 mm <sup>2</sup> /24 - 12
Temperature range		-40°C ... 70°C
Degree of protection in acc. with IEC 60529/EN 60529		IP20
Inflammability class in acc. with UL 94		V0
Connection method		Screw connection/push-in connection
Test standards		EN 61643-21/A1/IEC 61643-21/A1/EN 61000-6-2/ EN 61000-6-2/A1/EN 61000-6-3
Remote indication contact		Via TBUS

#### Ordering data

Description	Voltage $U_N$	Type	Order No.	Pcs. / Pkt.
<b>MCR-PLUGTRAB</b> , consisting of a plug, base element, and DIN rail bus, with screw connection technology	5 V DC	<b>PT-IQ-2X2-5DC-UT</b>	<b>2800807</b>	1
	48 V DC	<b>PT-IQ-2X2-48DC-UT</b>	<b>2800986</b>	1
<b>MCR-PLUGTRAB</b> , consisting of a plug, base element, and DIN rail bus, with push-in connection technology	5 V DC	<b>PT-IQ-2X2-5DC-PT</b>	<b>2801259</b>	1
	48 V DC	<b>PT-IQ-2X2-48DC-PT</b>	<b>2801265</b>	1

#### Accessories

Replacement plug	Type	Order No.	Pcs. / Pkt.
5 V DC	<b>PT-IQ-2X2-5DC-P</b>	<b>2800802</b>	1
48 V DC	<b>PT-IQ-2X2-48DC-P</b>	<b>2800810</b>	1

#### Marking material

ZB 6, see Catalog 6, page 111





**2 double conductors (loops), floating,  
9/10 connection grounded  
via gas-filled surge**



**4-wire with common reference potential,  
9/10 connection grounded directly**



**4-wire with common reference potential,  
9/10 connection grounded  
via gas-filled surge**

Total width 17.7 mm

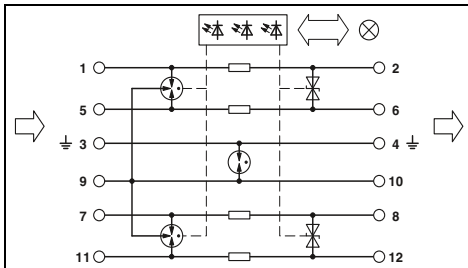

### Technical data

... 5DC	... 48DC
C1/C2/C3/D1	C1/C2/C3/D1
6 V DC/4 V AC	53 V DC/37 V AC
2.5 kA	2.5 kA
700 mA (up to 50°C)	300 mA
10 kA/10 kA	10 kA/10 kA
20 kA	20 kA
≤ 25 V (C3 - 25 A)	≤ 90 V (C3 - 25 A)
≤ 900 V (C1 - 1 kV/500 A)	≤ 900 V (C1 - 1 kV/500 A)
1.2 Ω	1.2 Ω

17.7 mm/109.3 mm/77.5 mm  
17.7 mm/91.1 mm/77.5 mm  
0.2 ... 4 mm<sup>2</sup>/0.2 ... 2.5 mm<sup>2</sup>/24 - 12  
0.2 ... 4 mm<sup>2</sup>/0.2 ... 2.5 mm<sup>2</sup>/24 - 12

-40°C ... 70°C  
IP20  
V0

Screw connection/push-in connection

EN 61643-21/A1/IEC 61643-21/A1/EN 61000-6-2/  
EN 61000-6-2/A1/EN 61000-6-3  
Via TBUS

### Ordering data

Type	Order No.	Pcs. / Pkt.
PT-IQ-2X2+F-5DC-UT	2800809	1
PT-IQ-2X2+F-48DC-UT	2800987	1
PT-IQ-2X2+F-5DC-PT	2801260	1
PT-IQ-2X2+F-48DC-PT	2801266	1

### Accessories

PT-IQ-2X2-5DC-P	2800802	1
PT-IQ-2X2-48DC-P	2800810	1

ZB 6, see Catalog 6, page 111

Total width 17.7 mm

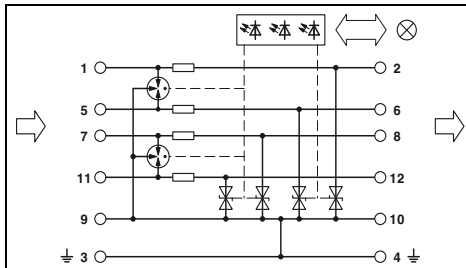

### Technical data

... 5DC	... 48DC
C1/C2/C3/D1	C1/C2/C3/D1
6 V DC/4 V AC	53 V DC/37 V AC
2.5 kA	2.5 kA
700 mA (up to 50°C)	300 mA
-10 kA	20 kA
20 kA	
-	
≤ 25 V (C3 - 25 A)	
1.2 Ω	

17.7 mm/109.3 mm/77.5 mm  
17.7 mm/91.1 mm/77.5 mm  
0.2 ... 4 mm<sup>2</sup>/0.2 ... 2.5 mm<sup>2</sup>/24 - 12  
0.2 ... 4 mm<sup>2</sup>/0.2 ... 2.5 mm<sup>2</sup>/24 - 12

-40°C ... 70°C  
IP20  
V0

Screw connection/push-in connection

EN 61643-21/A1/IEC 61643-21/A1/EN 61000-6-2/  
EN 61000-6-2/A1/EN 61000-6-3  
Via TBUS

### Ordering data

Type	Order No.	Pcs. / Pkt.
PT-IQ-4X1-5DC-UT	2801215	1
PT-IQ-4X1-5DC-PT	2801267	1

### Accessories

PT-IQ-4X1-5DC-P	2800811	1
-----------------	---------	---

ZB 6, see Catalog 6, page 111

Total width 17.7 mm

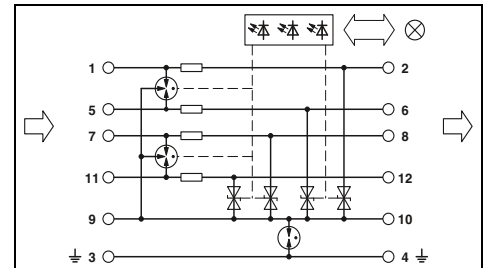

### Technical data

... 5DC	... 48DC
C1/C2/C3/D1	C1/C2/C3/D1
6 V DC/4 V AC	53 V DC/37 V AC
2.5 kA	2.5 kA
700 mA (up to 50°C)	300 mA
-10 kA	20 kA
20 kA	
-	
≤ 720 V (C1 - 1 kV/500 A)	
1.2 Ω	

17.7 mm/109.3 mm/77.5 mm  
17.7 mm/91.1 mm/77.5 mm  
0.2 ... 4 mm<sup>2</sup>/0.2 ... 2.5 mm<sup>2</sup>/24 - 12  
0.2 ... 4 mm<sup>2</sup>/0.2 ... 2.5 mm<sup>2</sup>/24 - 12

-40°C ... 70°C  
IP20  
V0

Screw connection/push-in connection

EN 61643-21/A1/IEC 61643-21/A1/EN 61000-6-2/  
EN 61000-6-2/A1/EN 61000-6-3  
Via TBUS

### Ordering data

Type	Order No.	Pcs. / Pkt.
PT-IQ-4X1+F-5DC-UT	2801216	1
PT-IQ-4X1+F-5DC-PT	2801268	1

### Accessories

PT-IQ-4X1-5DC-P	2800811	1
-----------------	---------	---

ZB 6, see Catalog 6, page 111

# Surge protection and power supplies

## Surge protection and interference filters

### PLUGTRAB PT-IQ EX With screw connection

- Tailored to the special requirements of intrinsically safe circuits
- Surge protection system
- Multi-level state monitoring
- Collective message about supply and remote module
- Multi-level, floating remote signaling
- System supplied via DIN rail bus
- Up to 10 protection modules per supply module
- Maximum ease of maintenance, thanks to the two-piece design
- Plugs are coded
- Impedance-neutral disconnection of plug for maintenance purposes
- Base element remains an integral part of the installation



Double conductor (loop), floating, 9/10 connection grounded directly



2 double conductors (loops), floating, 9/10 connection grounded directly

Total width 17.7 mm

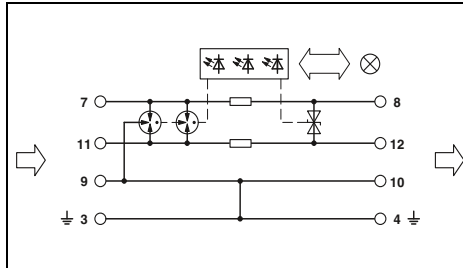

#### Technical data

Electrical data	... 24DC
IEC test classification/EN type	C1/C2/C3/D1
Maximum continuous operating voltage $U_C$	30 V DC/21 V AC
Impulse discharge curr. $I_{imp}$ (10/350) $\mu$ s	2 kA
Nominal current $I_N$	350 mA
Nominal discharge current $I_n$ (8/20) $\mu$ s	10 kA/10 kA
	20 kA
Total surge current (8/20) $\mu$ s	
Voltage protection level $U_p$	
	Core-core
	Core-ground
	Core-core
	Core-ground
Core-ground	$\leq 50$ V (C3 - 25 A)
	$\leq 1.3$ kV (C3 - 100 A)
Cut-off frequency $f_g$ (3 dB)	typ. 1.1 MHz
	1.2 $\Omega$
Resistance per path	
Symmetrical in the 150 $\Omega$ system	
General data	
Dimensions W/H/D	17.7 mm/91.1 mm/77.5 mm
Connection data solid/stranded with ferrule/AWG	0.2 ... 4 mm <sup>2</sup> /0.2 ... 2.5 mm <sup>2</sup> /24 - 12
Temperature range	-40°C ... 70°C
Degree of protection in acc. with IEC 60529/EN 60529	IP20
Inflammability class in acc. with UL 94	V0
Test standards	EN 61643-21/A1/IEC 61643-21/A1/EN 61000-6-2/ EN 61000-6-2/A1/EN 61000-6-3
Remote indication contact	Via TBUS

Total width 17.7 mm

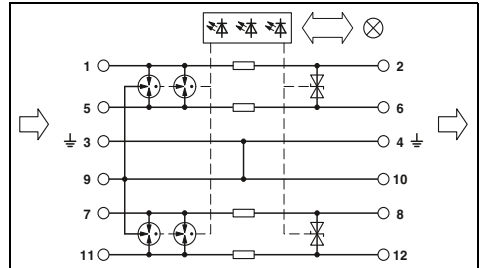

#### Technical data

Description	Voltage $U_N$
MCR-PLUGTRAB, consisting of a plug, base element, and DIN rail bus, with screw connection technology	24 V DC
Replacement plug	24 V DC
Separating plate for DIN rail NS35/7.5	
for DIN rail NS35/15	
Marking material	

#### Ordering data

Type	Order No.	Pcs. / Pkt.
PT-IQ-1X2-EX-24DC-UT	2801512	1

#### Accessories

PT-IQ-1X2-EX-24DC-P	2801514	1
PT-IQ-EX-L-PP	2905023	1
PT-IQ-EX-H-PP	2905024	1

ZB 6, see Catalog 6, page 111

#### Ordering data

Type	Order No.	Pcs. / Pkt.
PT-IQ-2X2-EX-24DC-UT	2801513	1

#### Accessories

PT-IQ-2X2-EX-24DC-P	2801515	1
PT-IQ-EX-L-PP	2905023	1
PT-IQ-EX-H-PP	2905024	1

ZB 6, see Catalog 6, page 111

**PLUGTRAB PT-IQ**

- Surge protection system
- Multi-level state monitoring
- Collective message about supply and remote module
- Multi-level, floating remote signaling
- System supplied via DIN rail bus
- Up to 28 protection modules per supply module
- Maximum ease of maintenance thanks to the two-piece design
- Plugs are coded
- Impedance-neutral disconnection of plug for maintenance purposes
- Base element remains an integral part of the installation

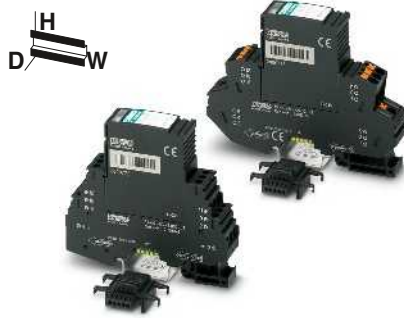

**3-wire with common reference potential, 9/10 connection grounded directly**

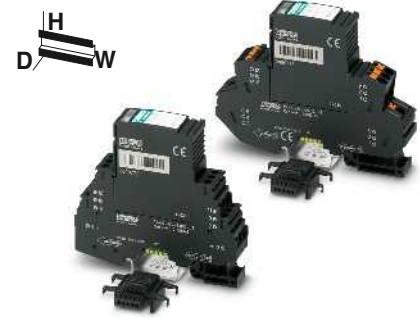

**3-wire with common reference potential, 9/10 connection grounded via gas-filled surge**

Total width 17.7 mm

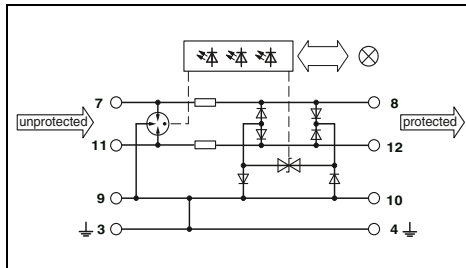

Total width 17.7 mm

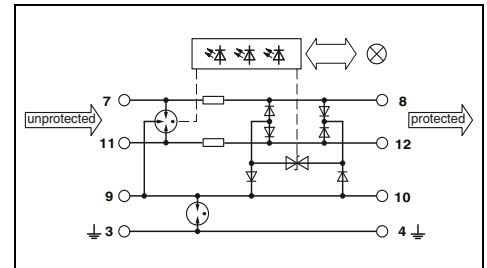

**Notes:**  
For approvals and dimensional drawing, visit [phoenixcontact.net/products](http://phoenixcontact.net/products)  
Attenuation characteristics at [phoenixcontact.net/products](http://phoenixcontact.net/products)

Electrical data		Per path	Core-core/core-ground	Core-core	Core-ground	Symmetrical in the 150 Ω system
IEC test classification/EN type	... 5DC		10 kA/10 kA	≤ 30 V (C3 - 25 A)		> 60 MHz
Maximum continuous operating voltage U <sub>C</sub>	C1/C2/C3/D1		20 kA	≤ 30 V (C3 - 25 A)		
Impulse discharge curr. I <sub>imp</sub> (10/350)µs	6 V DC/4 V AC	2.5 kA				
Nominal current I <sub>N</sub>	15 V DC/10 V AC	600 mA (up to 40°C)				
Nominal discharge current I <sub>n</sub> (8/20) µs	2.5 kA					
Total surge current (8/20)µs	600 mA (up to 40°C)					
Voltage protection level U <sub>p</sub>						
Cut-off frequency f <sub>g</sub> (3 dB)						
General data						
PT-IQ...PT dimensions W/H/D	... 12DC					
PT-IQ...UT dimensions W/H/D	C1/C2/C3/D1					
Connection data, push-in solid/stranded with ferrule/AWG	6 V DC/4 V AC	2.5 kA				
Connection data solid/stranded with ferrule/AWG	15 V DC/10 V AC	600 mA (up to 40°C)				
Temperature range	2.5 kA					
Degree of protection in acc. with IEC 60529/EN 60529	600 mA (up to 40°C)					
Inflammability class in acc. with UL 94						
Connection method						
Test standards						

Technical data		Per path	Core-core/core-ground	Core-core	Core-ground	Symmetrical in the 150 Ω system
IEC test classification/EN type	... 5DC		10 kA/10 kA	≤ 30 V (C3 - 25 A)		> 60 MHz
Maximum continuous operating voltage U <sub>C</sub>	C1/C2/C3/D1		20 kA	≤ 30 V (C3 - 25 A)		
Impulse discharge curr. I <sub>imp</sub> (10/350)µs	6 V DC/4 V AC	2.5 kA				
Nominal current I <sub>N</sub>	15 V DC/10 V AC	600 mA (up to 40°C)				
Nominal discharge current I <sub>n</sub> (8/20) µs	2.5 kA					
Total surge current (8/20)µs	600 mA (up to 40°C)					
Voltage protection level U <sub>p</sub>						
Cut-off frequency f <sub>g</sub> (3 dB)						
General data						
PT-IQ...PT dimensions W/H/D	... 12DC					
PT-IQ...UT dimensions W/H/D	C1/C2/C3/D1					
Connection data, push-in solid/stranded with ferrule/AWG	6 V DC/4 V AC	2.5 kA				
Connection data solid/stranded with ferrule/AWG	15 V DC/10 V AC	600 mA (up to 40°C)				
Temperature range	2.5 kA					
Degree of protection in acc. with IEC 60529/EN 60529	600 mA (up to 40°C)					
Inflammability class in acc. with UL 94						
Connection method						
Test standards						

Technical data		Per path	Core-core/core-ground	Core-core	Core-ground	Symmetrical in the 150 Ω system
IEC test classification/EN type	... 5DC		10 kA/10 kA	≤ 30 V (C3 - 25 A)		> 60 MHz
Maximum continuous operating voltage U <sub>C</sub>	C1/C2/C3/D1		20 kA	≤ 30 V (C3 - 25 A)		
Impulse discharge curr. I <sub>imp</sub> (10/350)µs	6 V DC/4 V AC	2.5 kA				
Nominal current I <sub>N</sub>	15 V DC/10 V AC	600 mA (up to 40°C)				
Nominal discharge current I <sub>n</sub> (8/20) µs	2.5 kA					
Total surge current (8/20)µs	600 mA (up to 40°C)					
Voltage protection level U <sub>p</sub>						
Cut-off frequency f <sub>g</sub> (3 dB)						
General data						
PT-IQ...PT dimensions W/H/D	... 12DC					
PT-IQ...UT dimensions W/H/D	C1/C2/C3/D1					
Connection data, push-in solid/stranded with ferrule/AWG	6 V DC/4 V AC	2.5 kA				
Connection data solid/stranded with ferrule/AWG	15 V DC/10 V AC	600 mA (up to 40°C)				
Temperature range	2.5 kA					
Degree of protection in acc. with IEC 60529/EN 60529	600 mA (up to 40°C)					
Inflammability class in acc. with UL 94						
Connection method						
Test standards						

Ordering data		Type	Order No.	Pcs. / Pkt.
Description	Voltage U <sub>N</sub>	PT-IQ-3-PB-UT	2800785	1
		PT-IQ-3-HF-12DC-UT	2800786	1
MCR-PLUGTRAB, consisting of a plug, base element, and DIN rail bus, with screw connection technology	5 V DC	PT-IQ-3-PB-PT	2801286	1
	12 V DC	PT-IQ-3-HF-12DC-PT	2801288	1
MCR-PLUGTRAB, consisting of a plug, base element, and DIN rail bus, with push-in connection technology	5 V DC	PT-IQ-3-PB-P	2800783	1
	12 V DC	PT-IQ-3-HF-12DC-P	2800784	1
<b>Accessories</b>				
ZB 6, see Catalog 6, page 111				

Ordering data		Type	Order No.	Pcs. / Pkt.
Description	Voltage U <sub>N</sub>	PT-IQ-3-PB+F-UT	2800994	1
		PT-IQ-3-HF+F-12DC-UT	2800995	1
MCR-PLUGTRAB, consisting of a plug, base element, and DIN rail bus, with screw connection technology	5 V DC	PT-IQ-3-PB+F-PT	2801287	1
	12 V DC	PT-IQ-3-HF+F-12DC-PT	2801289	1
MCR-PLUGTRAB, consisting of a plug, base element, and DIN rail bus, with push-in connection technology	5 V DC	PT-IQ-3-PB-P	2800783	1
	12 V DC	PT-IQ-3-HF-12DC-P	2800784	1
<b>Accessories</b>				
ZB 6, see Catalog 6, page 111				

Ordering data		Type	Order No.	Pcs. / Pkt.
Description	Voltage U <sub>N</sub>	PT-IQ-3-PB+F-UT	2800994	1
		PT-IQ-3-HF+F-12DC-UT	2800995	1
MCR-PLUGTRAB, consisting of a plug, base element, and DIN rail bus, with screw connection technology	5 V DC	PT-IQ-3-PB+F-PT	2801287	1
	12 V DC	PT-IQ-3-HF+F-12DC-PT	2801289	1
MCR-PLUGTRAB, consisting of a plug, base element, and DIN rail bus, with push-in connection technology	5 V DC	PT-IQ-3-PB-P	2800783	1
	12 V DC	PT-IQ-3-HF-12DC-P	2800784	1
<b>Accessories</b>				
ZB 6, see Catalog 6, page 111				

# Surge protection and power supplies

## Surge protection and interference filters

### Surge protection for SHDSL telecommunications interfaces

- Protection for two SHDSL ports
- Connection: RJ45 (RJ12/RJ11) and plug-in screw terminal block (COMBICON)
- Alternatively, can be snapped onto a DIN rail
- Protective circuit:  
Course/fine protection combination between all cables of signal wire pairs, as well as common mode voltage coarse protection between all signal wires and ground
- Separate ground connection line
- The adapter included enables conversion from RJ45 to RJ11 and RJ12 (for contacting, see circuit diagram)



Attachment plug for two SHDSL interfaces (ports)

Total width 25 mm

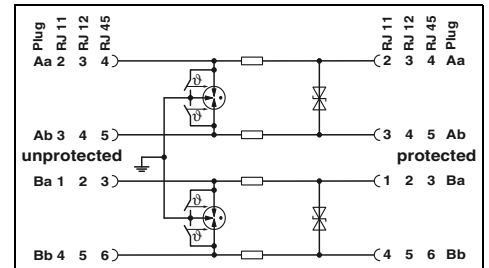

#### Technical data

Electrical data		
IEC test classification/EN type		B2/C1/C2/C3/D1
Maximum continuous operating voltage $U_c$		185 V DC
Nominal current $I_N$		≤ 380 mA (25°C)
Nominal discharge current $I_n$ (8/20) $\mu$ s	Core-core/core-ground	≤ 5 kA/≤ 5 kA
Total surge current (8/20) $\mu$ s		10 kA
Voltage protection level $U_p$	Core-core/core-ground	≤ 250 V (C1 - 500 A)/≤ 580 V (C1 - 500 A)
Cut-off frequency fg (3 dB)	Core-core	25 MHz
In a 100 $\Omega$ system		
General data		
Dimensions W/H/D		25 mm/103 mm/63 mm
Connection data solid / stranded / AWG		0.14 ... 1.5 mm <sup>2</sup> /0.14 ... 1.5 mm <sup>2</sup> /28 - 16
Temperature range		-40°C ... 85°C
Degree of protection in acc. with IEC 60529/EN 60529		IP20
Connection method		RJ45/Combicon
Test standards		IEC 61643-21

#### Ordering data

Description	Type	Order No.	Pcs. / Pkt.
<b>DATATRAB adapter</b> , protective adapter with RJ45 and screw connection for two SHDSL telecommunications interfaces	<b>DT-TELE-SHDSL</b>	<b>2801593</b>	<b>1</b>

## QUINT POWER power supplies - with maximum functionality

- AC and DC input in a single device
- Specially designed for connection to two outer conductors of a three-phase system and to a DC intermediate circuit voltage of an inverter; typical applications include injection molding machines.
- Starts up with two-phase AC voltage or DC voltage. In the event of a mains failure connected 24 V loads continue to be supplied using the kinetic energy of the motor. In this way, the motor acts as a generator and supplies energy to the intermediate circuits as long as it is moving.
- Fast tripping of standard circuit breakers with dynamic power reserve SFB (selective fuse breaking) technology with up to 6 times the nominal current for 20 ms
- Reliably start difficult loads with the static POWER BOOST power reserve
- Preventive function monitoring warns against critical operating states before errors occur.



Power supply with two separate input circuits for frequency inverters  
2 AC, 1 DC/24 V DC, 20 A

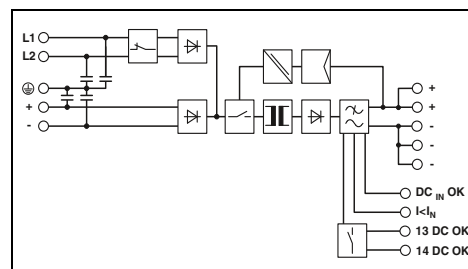

### Technical data

Input data of AC	
Nominal input voltage range	2x 400 V AC ... 500 V AC
Input voltage range AC	2x 360 V AC ... 575 V AC
Frequency range	45 Hz ... 65 Hz
Current consumption (nominal load)	2.5 A (400 V AC)/2.1 A (500 V AC)
Inrush current limitation at 25°C (typ.) / I <sup>2</sup> t	< 85 A/ <sup>2</sup> 1.5 A <sup>2</sup> s
Mains buffering (I <sub>N</sub> , typ.)	> 20 ms (400 V AC)
Input data of DC	
Nominal input voltage range	600 V DC
Input voltage range DC	450 V DC ... 840 V DC
Max. current consumption	approx. 0.9 A (600 V DC)
Output data	
Nominal output voltage	24 V DC ±1%
Setting range of the output voltage	18 V DC ... 29.5 V DC (U <sub>IN</sub> ≥ 360 V AC/480 V DC) 18 V DC ... 26 V DC (< 480 V DC)
Output current/POWER BOOST/SFB (20 ms)	20 A/26 A/120 A
Magnetic fuse tripping	-
Can be connected in parallel/series	Yes/Yes
Max. power dissipation (no load/nominal load)	11 W/51 W
Efficiency (typ.)	> 92% (600 V DC)
Residual ripple	< 50 mV <sub>PP</sub>
Signaling	
Signaling DC OK	LED, relay contact
Boost signaling	LED, active switching output
General data	
Weight/dimensions W x H x D	2 kg/120 x 130 x 125 mm
Spacing when mounting	Alignable: 5 mm horizontally, 15 mm next to active components, 50 mm vertically
Connection method	Screw connection
Input connection data (solid/stranded/AWG)	0.2 - 6 mm <sup>2</sup> /0.2 - 4 mm <sup>2</sup> /24 - 10
Output connection data (solid/stranded/AWG)	0.2 - 6 mm <sup>2</sup> /0.2 - 4 mm <sup>2</sup> /12 - 10
Signal connection data (solid/stranded/AWG)	0.2 - 6 mm <sup>2</sup> /0.2 - 4 mm <sup>2</sup> /24 - 10
Degree of protection/protection class	IP20/I
MTBF (EN 29500, 40°C)	> 500000 h
Ambient temperature (operation)	-25°C ... 70°C (> 60°C derating)
Standards/regulations	
Insulation voltage input/output	2 kV AC (routine test)/1.5 kV AC (type test)
Electromagnetic compatibility	
Electrical safety	Conformance with EMC Directive 2004/108/EC
Electronic equipm. for electrical power installations	EN 60950-1/VDE 0805 (SELV)
Safe isolation	EN 50178/VDE 0160 (PELV)
UL approvals	DIN VDE 0100-410 UL applied for

### Ordering data

Description	Type	Order No.	Pcs. / Pkt.
DC-DC converter, primary switched mode	QUINT-PS/2AC/1DC/24DC/20	2320830	1

# Surge protection and power supplies

## Power supplies and UPS

### UNO POWER power supplies - with basic functionality

- Save energy, thanks to particularly low idling losses and a high degree of efficiency
- Save space in the control cabinet through compact housing with high power density
- Robust and reliable at temperatures from -25 to 70°C

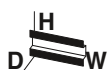

Power supply,  
1 AC, 5 DC, 25 W



Power supply,  
1 AC, 5 DC, 40 W

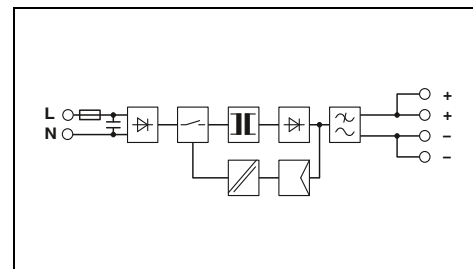
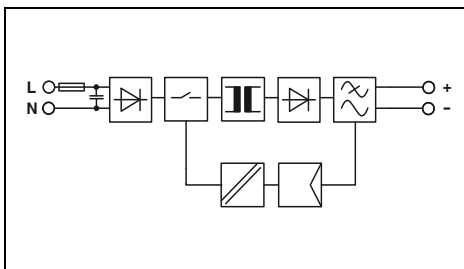

#### Technical data

#### Technical data

Input data	
Nominal input voltage range	100 V AC ... 240 V AC
Input voltage range AC/DC	85 V AC ... 264 V AC
Frequency range	45 Hz ... 65 Hz
Current consumption (nominal load)	0.5 A (120 V AC)/0.3 A (230 V AC)
Inrush current limitation at 25°C (typ.) / I <sup>2</sup> t	< 30 A/< 0.5 A <sup>2</sup> s
Mains buffering (I <sub>N</sub> , typ.)	> 35 ms (120 V AC)/> 135 ms (230 V AC)
Output data	
Nominal output voltage	5 V DC ±1%
Output current	5 A
Can be connected in parallel/series	Yes, with redundancy module/Yes
Max. power dissipation (no load/nominal load)	< 0.3 W/< 4.5 W
Efficiency (typ.)	> 84%
Residual ripple	< 40 mV <sub>pp</sub>
Signaling	
Signaling DC OK	LED
General data	
Weight/dimensions W x H x D	0.15 kg/22.5 x 90 x 84 mm
Spacing when mounting	Alignable: 0 mm horizontally, 30 mm vertically
Connection method	Screw connection
Connection data solid / stranded / AWG	0.2 - 2.5 mm <sup>2</sup> /0.2 - 2.5 mm <sup>2</sup> /24 - 14
Degree of protection / Protection class	IP20/II
MTBF (EN 29500, 40°C)	> 500000 h
Ambient temperature (operation)	-25°C ... 70°C (> 55° C derating)
Standards/regulations	
Insulation voltage input/output	3 kV AC (routine test)/4 kV AC (type test)
Electromagnetic compatibility	Conformance with EMC Directive 2004/108/EC
Electrical safety	IEC 60950-1/VDE 0805 (SELV)
Electronic equipm. for electrical power installations	EN 50178/VDE 0160 (PELV)
Safe isolation	DIN VDE 0100-410
UL approvals	UL/C-UL listed UL 508, UL/C-UL Recognized UL 60950
Limitation of harmonic line currents	
	EN 61000-3-2

Technical data	
Nominal input voltage range	100 V AC ... 240 V AC
Input voltage range AC/DC	85 V AC ... 264 V AC
Frequency range	45 Hz ... 65 Hz
Current consumption (nominal load)	0.7 A (120 V AC)/0.5 A (230 V AC)
Inrush current limitation at 25°C (typ.) / I <sup>2</sup> t	< 30 A/< 0.5 A <sup>2</sup> s
Mains buffering (I <sub>N</sub> , typ.)	> 30 ms (120 V AC)/> 120 ms (230 V AC)
Output data	
Nominal output voltage	5 V DC ±1%
Output current	8 A
Can be connected in parallel/series	Yes, with redundancy module/Yes
Max. power dissipation (no load/nominal load)	< 0.3 W/< 7.5 W
Efficiency (typ.)	> 85% (for 230 V AC and nominal values)
Residual ripple	< 100 mV <sub>pp</sub>
Signaling	
Signaling DC OK	LED
General data	
Weight/dimensions W x H x D	0.21 kg/35 x 90 x 84 mm
Spacing when mounting	Alignable: 0 mm horizontally, 30 mm vertically
Connection method	Screw connection
Connection data solid / stranded / AWG	0.2 - 2.5 mm <sup>2</sup> /0.2 - 2.5 mm <sup>2</sup> /24 - 14
Degree of protection / Protection class	IP20/II
MTBF (EN 29500, 40°C)	> 500000 h
Ambient temperature (operation)	-25°C ... 70°C (> 55° C derating)
Standards/regulations	
Insulation voltage input/output	3 kV AC (routine test)/4 kV AC (type test)
Electromagnetic compatibility	Conformance with EMC Directive 2004/108/EC
Electrical safety	IEC 60950-1/VDE 0805 (SELV)
Electronic equipm. for electrical power installations	EN 50178/VDE 0160 (PELV)
Safe isolation	DIN VDE 0100-410
UL approvals	UL/C-UL listed UL 508, UL/C-UL Recognized UL 60950
Limitation of harmonic line currents	
	EN 61000-3-2

Technical data	
Nominal input voltage range	100 V AC ... 240 V AC
Input voltage range AC/DC	85 V AC ... 264 V AC
Frequency range	45 Hz ... 65 Hz
Current consumption (nominal load)	0.7 A (120 V AC)/0.5 A (230 V AC)
Inrush current limitation at 25°C (typ.) / I <sup>2</sup> t	< 30 A/< 0.5 A <sup>2</sup> s
Mains buffering (I <sub>N</sub> , typ.)	> 30 ms (120 V AC)/> 120 ms (230 V AC)
Output data	
Nominal output voltage	5 V DC ±1%
Output current	8 A
Can be connected in parallel/series	Yes, with redundancy module/Yes
Max. power dissipation (no load/nominal load)	< 0.3 W/< 7.5 W
Efficiency (typ.)	> 85% (for 230 V AC and nominal values)
Residual ripple	< 100 mV <sub>pp</sub>
Signaling	
Signaling DC OK	LED
General data	
Weight/dimensions W x H x D	0.21 kg/35 x 90 x 84 mm
Spacing when mounting	Alignable: 0 mm horizontally, 30 mm vertically
Connection method	Screw connection
Connection data solid / stranded / AWG	0.2 - 2.5 mm <sup>2</sup> /0.2 - 2.5 mm <sup>2</sup> /24 - 14
Degree of protection / Protection class	IP20/II
MTBF (EN 29500, 40°C)	> 500000 h
Ambient temperature (operation)	-25°C ... 70°C (> 55° C derating)
Standards/regulations	
Insulation voltage input/output	3 kV AC (routine test)/4 kV AC (type test)
Electromagnetic compatibility	Conformance with EMC Directive 2004/108/EC
Electrical safety	IEC 60950-1/VDE 0805 (SELV)
Electronic equipm. for electrical power installations	EN 50178/VDE 0160 (PELV)
Safe isolation	DIN VDE 0100-410
UL approvals	UL/C-UL listed UL 508, UL/C-UL Recognized UL 60950
Limitation of harmonic line currents	
	EN 61000-3-2

#### Ordering data

#### Ordering data

Description	Type	Order No.	Pcs. / Pkt.
Power supply, primary-switched, 1-phase	UNO-PS/1AC/ 5DC/ 25W	2904374	1

Description	Type	Order No.	Pcs. / Pkt.
Power supply, primary-switched, 1-phase	UNO-PS/1AC/ 5DC/ 40W	2904375	1



Power supply,  
1 AC, 12 DC, 100 W



Power supply,  
1 AC, 15 DC, 30 W



Power supply,  
1 AC, 15 DC, 55 W

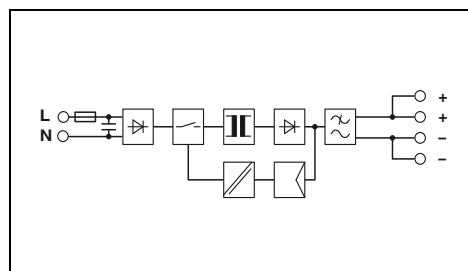
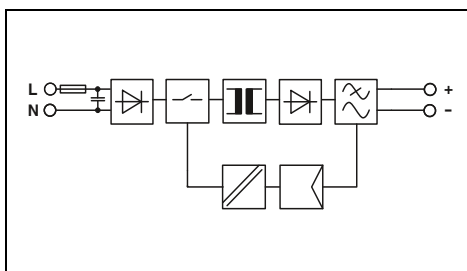
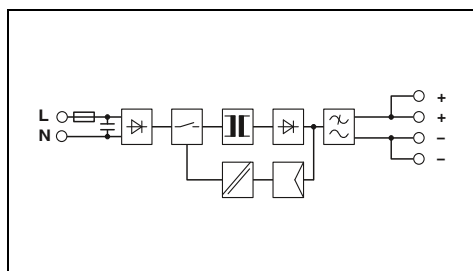

Technical data

100 V AC ... 240 V AC  
85 V AC ... 264 V AC  
45 Hz ... 65 Hz  
1.7 A (120 V AC)/1 A (230 V AC)  
< 30 A/< 1.5 A<sup>2</sup>s  
> 20 ms (120 V AC)/> 85 ms (230 V AC)

12 V DC ±1%  
8.3 A  
Yes, with redundancy module/Yes  
< 0.4 W/< 12 W  
> 89.5%  
< 75 mV<sub>pp</sub>

LED

0.34 kg/55 x 90 x 84 mm  
Alignable: 0 mm horizontally, 30 mm vertically  
Screw connection  
0.2 - 2.5 mm<sup>2</sup>/0.2 - 2.5 mm<sup>2</sup>/24 - 14  
IP20/II  
> 500000 h  
-25°C ... 70°C (> 55° C derating)

3 kV AC (routine test)/4 kV AC (type test)  
Conformance with EMC Directive 2004/108/EC  
IEC 60950-1/VDE 0805 (SELV)  
EN 50178/VDE 0160 (PELV)  
DIN VDE 0100-410  
UL/C-UL listed UL 508, UL/C-UL Recognized UL 60950

EN 61000-3-2

Technical data

100 V AC ... 240 V AC  
85 V AC ... 264 V AC  
45 Hz ... 65 Hz  
0.6 A (120 V AC)/0.4 A (230 V AC)  
< 30 A/< 0.3 A<sup>2</sup>s  
> 20 ms (120 V AC)/> 115 ms (230 V AC)

15 V DC ±1%  
2 A  
Yes, with redundancy module/Yes  
< 0.3 W/< 4.6 W  
> 87% (for 230 V AC and nominal values)  
< 40 mV<sub>pp</sub>

LED

0.15 kg/22.5 x 90 x 84 mm  
Alignable: 0 mm horizontally, 30 mm vertically  
Screw connection  
0.2 - 2.5 mm<sup>2</sup>/0.2 - 2.5 mm<sup>2</sup>/24 - 14  
IP20/II  
> 500000 h  
-25°C ... 70°C (> 55° C derating)

3 kV AC (routine test)/4 kV AC (type test)  
Conformance with EMC Directive 2004/108/EC  
IEC 60950-1/VDE 0805 (SELV)  
EN 50178/VDE 0160 (PELV)  
DIN VDE 0100-410  
UL/C-UL listed UL 508, UL/C-UL Recognized UL 60950

EN 61000-3-2

Technical data

100 V AC ... 240 V AC  
85 V AC ... 264 V AC  
45 Hz ... 65 Hz  
1 A (120 V AC)/0.6 A (230 V AC)  
< 25 A/< 0.5 A<sup>2</sup>s  
> 25 ms (120 V AC)/> 90 ms (230 V AC)

15 V DC ±1%  
3.7 A  
Yes, with redundancy module/Yes  
< 0.3 W/< 7 W  
> 88.5% (for 230 V AC and nominal values)  
< 50 mV<sub>pp</sub>

LED

0.21 kg/35 x 90 x 84 mm  
Alignable: 0 mm horizontally, 30 mm vertically  
Screw connection  
0.2 - 2.5 mm<sup>2</sup>/0.2 - 2.5 mm<sup>2</sup>/24 - 14  
IP20/II  
> 500000 h  
-25°C ... 70°C (> 55° C derating)

3 kV AC (routine test)/4 kV AC (type test)  
Conformance with EMC Directive 2004/108/EC  
IEC 60950-1/VDE 0805 (SELV)  
EN 50178/VDE 0160 (PELV)  
DIN VDE 0100-410  
UL/C-UL listed UL 508, UL/C-UL Recognized UL 60950

EN 61000-3-2

Ordering data

Type	Order No.	Pcs. / Pkt.
UNO-PS/1AC/12DC/100W	2902997	1

Ordering data

Type	Order No.	Pcs. / Pkt.
UNO-PS/1AC/15DC/30W	2903000	1

Ordering data

Type	Order No.	Pcs. / Pkt.
UNO-PS/1AC/15DC/55W	2903001	1

# Surge protection and power supplies

## Power supplies and UPS

### UNO POWER power supplies - with basic functionality

- Save energy, thanks to particularly low idling losses and a high degree of efficiency
- Save space in the control cabinet through compact housing with high power density
- Robust and reliable at temperatures from -25 to 70°C



Power supply,  
1 AC, 15 DC, 100 W



Power supply,  
1 AC, 24 DC, 90 W  
NEC Class 2

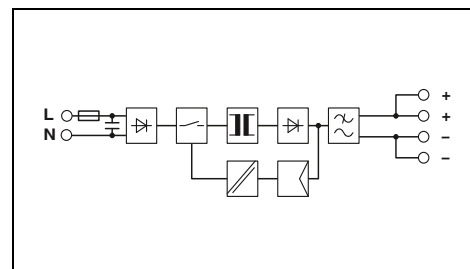
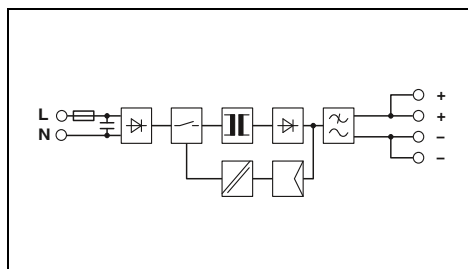

#### Technical data

Input data	
Nominal input voltage range	100 V AC ... 240 V AC
Input voltage range AC/DC	85 V AC ... 264 V AC
Frequency range	45 Hz ... 65 Hz
Current consumption (nominal load)	1.7 A (120 V AC)/1 A (230 V AC)
Inrush current limitation at 25°C (typ.) / I <sup>2</sup> t	< 30 A/< 1.5 A <sup>2</sup> s
Mains buffering (I <sub>N</sub> , typ.)	> 20 ms (120 V AC)/> 85 ms (230 V AC)
Output data	
Nominal output voltage	15 V DC ±1%
Output current	6.67 A
Can be connected in parallel/series	Yes, with redundancy module/Yes
Max. power dissipation (no load/nominal load)	< 0.4 W/< 12 W
Efficiency (typ.)	> 89% (for 230 V AC and nominal values)
Residual ripple	< 75 mV <sub>pp</sub>
Signaling	
Signaling DC OK	LED
General data	
Weight/dimensions W x H x D	0.34 kg/55 x 90 x 84 mm
Spacing when mounting	Alignable: 0 mm horizontally, 30 mm vertically
Connection method	Screw connection
Connection data solid / stranded / AWG	0.2 - 2.5 mm <sup>2</sup> /0.2 - 2.5 mm <sup>2</sup> /24 - 12
Degree of protection / Protection class	IP20/II
MTBF (EN 29500, 40°C)	> 500000 h
Ambient temperature (operation)	-25°C ... 70°C (> 55°C derating)
Standards/regulations	
Insulation voltage input/output	3 kV AC (routine test)/4 kV AC (type test)
Electromagnetic compatibility	Conformance with EMC Directive 2004/108/EC
Electrical safety	IEC 60950-1/VDE 0805 (SELV)
Electronic equipm. for electrical power installations	EN 50178/VDE 0160 (PELV)
Safe isolation	DIN VDE 0100-410
UL approvals	UL/C-UL listed UL 508, UL/C-UL Recognized UL 60950
Limitation of harmonic line currents	
EN 61000-3-2	

Technical data	
100 V AC ... 240 V AC	
85 V AC ... 264 V AC	
45 Hz ... 65 Hz	
1.5 A (120 V AC)/1 A (230 V AC)	
< 40 A/< 1.5 A <sup>2</sup> s	
> 25 ms (120 V AC)/> 100 ms (230 V AC)	
24 V DC ±1%	
3.75 A	
Yes, with redundancy module/Yes	
< 0.5 W/< 12 W	
> 88.5% (for 230 V AC and nominal values)	
< 45 mV <sub>pp</sub>	
LED	
0.34 kg/55 x 90 x 84 mm	
Alignable: 0 mm horizontally, 30 mm vertically	
Screw connection	
0.2 - 2.5 mm <sup>2</sup> /0.2 - 2.5 mm <sup>2</sup> /24 - 14	
IP20/II	
> 500000 h	
-25°C ... 70°C (> 55°C derating)	
3 kV AC (routine test)/4 kV AC (type test)	
Conformance with EMC Directive 2004/108/EC	
IEC 60950-1/VDE 0805 (SELV)	
EN 50178/VDE 0160 (PELV)	
DIN VDE 0100-410	
UL/C-UL listed UL 508, UL/C-UL Recognized UL 60950, NEC Class 2 as per UL 1310	
EN 61000-3-2	

#### Ordering data

Description	Type	Order No.	Pcs. / Pkt.
Power supply, primary-switched, 1-phase	UNO-PS/1AC/15DC/100W	2903002	1

#### Ordering data

Description	Type	Order No.	Pcs. / Pkt.
Power supply, primary-switched, 1-phase	UNO-PS/1AC/24DC/90W/C2LPS	2902994	1





Power supply,  
1 AC, 48 DC, 60 W



Power supply,  
1 AC, 48 DC, 100 W



Power supply,  
2 AC, 24 DC, 90 W  
NEC Class 2

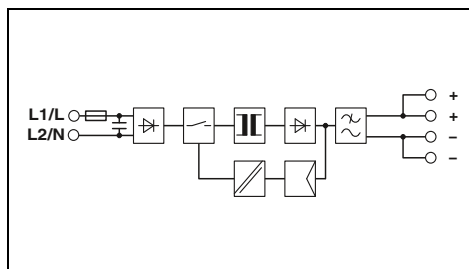
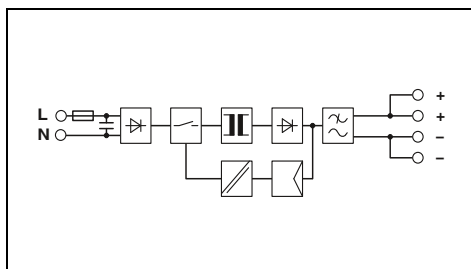
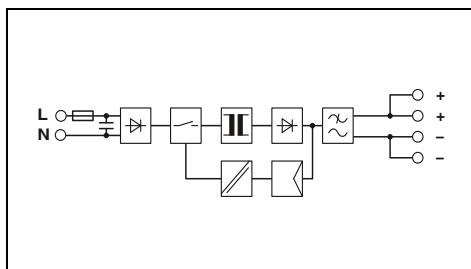

**Technical data**

100 V AC ... 240 V AC  
85 V AC ... 264 V AC  
45 Hz ... 65 Hz  
1 A (120 V AC)/0.6 A (230 V AC)  
< 30 A/< 0.5 A<sup>2</sup>s  
> 20 ms (120 V AC)/> 90 ms (230 V AC)

48 V DC ±1%  
1.25 A  
Yes, with redundancy module/Yes  
< 0.4 W/< 7 W  
> 90% (for 230 V AC and nominal values)  
< 35 mV<sub>pp</sub>

**LED**

0.21 kg/35 x 90 x 84 mm  
Alignable: 0 mm horizontally, 30 mm vertically  
Screw connection  
0.2 - 2.5 mm<sup>2</sup>/0.2 - 2.5 mm<sup>2</sup>/24 - 14  
IP20/II  
> 500000 h  
-25°C ... 70°C (> 55° C derating)

3 kV AC (routine test)/4 kV AC (type test)  
Conformance with EMC Directive 2004/108/EC  
IEC 60950-1/VDE 0805 (SELV)  
EN 50178/VDE 0160 (PELV)  
DIN VDE 0100-410  
UL/C-UL listed UL 508, UL/C-UL Recognized UL 60950

EN 61000-3-2

**Technical data**

100 V AC ... 240 V AC  
85 V AC ... 264 V AC  
45 Hz ... 65 Hz  
1.7 A (120 V AC)/1 A (230 V AC)  
< 40 A/< 1.4 A<sup>2</sup>s  
> 25 ms (120 V AC)/> 90 ms (230 V AC)

48 V DC ±1%  
2.08 A  
Yes, with redundancy module/Yes  
< 0.4 W/< 11 W  
> 90% (for 230 V AC and nominal values)  
< 40 mV<sub>pp</sub>

**LED**

0.34 kg/55 x 90 x 84 mm  
Alignable: 0 mm horizontally, 30 mm vertically  
Screw connection  
0.2 - 2.5 mm<sup>2</sup>/0.2 - 2.5 mm<sup>2</sup>/24 - 14  
IP20/II  
> 500000 h  
-25°C ... 70°C (> 55° C derating)

3 kV AC (routine test)/4 kV AC (type test)  
Conformance with EMC Directive 2004/108/EC  
IEC 60950-1/VDE 0805 (SELV)  
EN 50178/VDE 0160 (PELV)  
DIN VDE 0100-410  
UL/C-UL listed UL 508, UL/C-UL Recognized UL 60950

EN 61000-3-2

**Technical data**

2x 400 V AC ... 500 V AC  
264 V AC ... 575 V AC  
45 Hz ... 65 Hz  
0.6 A (400 V AC)/0.5 A (500 V AC)  
< 30 A/< 0.5 A<sup>2</sup>s  
> 65 ms (400 V AC)/> 100 ms (500 V AC)

24 V DC ±1%  
3.75 A/3.38 A  
Yes, with redundancy module/Yes  
< 0.7 W/< 12 W  
> 89.5%  
< 50 mV<sub>pp</sub>

**LED**

0.32 kg/55 x 90 x 84 mm  
Alignable: 0 mm horizontally, 30 mm vertically  
Screw connection  
0.2 - 2.5 mm<sup>2</sup>/0.2 - 2.5 mm<sup>2</sup>/24 - 14  
IP20/II  
> 500000 h  
-25°C ... 70°C (> 55° C derating)

3 kV AC (routine test)/4 kV AC (type test)  
Conformance with EMC Directive 2004/108/EC  
IEC 60950-1/VDE 0805 (SELV)  
EN 50178/VDE 0160 (PELV)  
DIN VDE 0100-410  
UL/C-UL listed UL 508, UL/C-UL Recognized UL 60950,  
NEC Class 2 as per UL 1310  
EN 61000-3-2

**Ordering data**

Type	Order No.	Pcs. / Pkt.
UNO-PS/1AC/48DC/ 60W	2902995	1

**Ordering data**

Type	Order No.	Pcs. / Pkt.
UNO-PS/1AC/48DC/100W	2902996	1

**Ordering data**

Type	Order No.	Pcs. / Pkt.
UNO-PS/2AC/24DC/90W/C2LPS	2904371	1

### Mounting set

- Used for mounting power storage devices that cannot be mounted on DIN rails
- Suitable for wall and surface mounting



®

Ordering data			
Description	Type	Order No.	Pcs. / Pkt.
Mounting set	BATTERY MOUNTING CASE	2320458	1

**Accessories for device circuit breakers**

**Base element**

- For accommodating CB TM.../CB E... device circuit breakers
- PCB module
- Codable

**Bridge plug**

- Signal contact bridging
- For equipping reserve spaces



Base element for the PCB



Plug for bridging contacts 11 to 14

Total width 12.3 mm

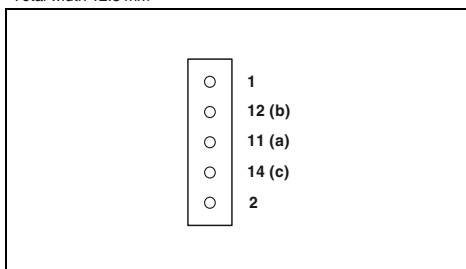

Total width 12.3 mm

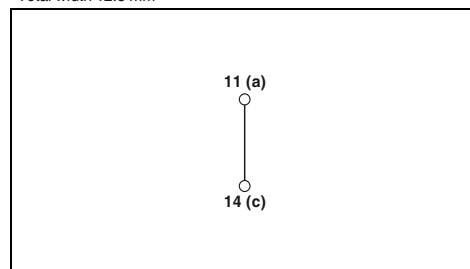

		Technical data		Technical data	
Electrical data - bridge plug					
Auxiliary contacts					
		Operating voltage $U_{max}$	-	277 V AC/80 V DC	
		Operating current $I_{max}$	-	1 A	
Electrical data - base element					
Rated surge voltage		2.5 kV		-	
Rated insulation voltage $U_i$		80 V DC		-	
Main circuit					
		Rated voltage	80 V DC/277 V AC	-	
		Rated current $I_n$	16 A	-	
Remote indication circuit					
		Rated voltage	80 V DC/277 V AC	-	
		Rated current $I_n$	1 A	-	
General data					
Dimensions W/H/D		12.3 mm/34.8 mm/36.4 mm		12.3 mm/45 mm/52 mm	
Ambient temperature (operation)		-30°C ... 60°C		-30°C ... 60°C	
Degree of protection in acc. with IEC 60529/EN 60529		IP30 (plug-in area with plugged-in device)/IP00 (connection area)		IP30 (actuation area)/IP00 (connection area)	
Inflammability class in acc. with UL 94		V0		V0	
Connection method		Solder connection		Spade connection	
Test standards		DIN EN 50155/IEC 60068-2		IEC 60068-2	

		Ordering data			Ordering data		
Description		Type	Order No.	Pcs. / Pkt.	Type	Order No.	Pcs. / Pkt.
<b>Soldering base element</b> , for accommodating device circuit breakers		CB S-BE	2905067	30			
<b>Bridge plug</b> , for bridging contacts 11 to 14 for CB base elements					CB RC BRIDGE	2801616	1



Highly compact signal conditioners - MINI Analog Pro  
- 3-way signal conditioners  
Page 326



Highly compact signal conditioners - MINI Analog Pro  
- Temperature transducers for resistance thermometers and thermocouples  
Page 330



Highly compact signal conditioners - MINI Analog Pro  
- Potipotentiometers  
Page 334



Highly compact signal conditioners - MINI Analog Pro  
- Supply components, fault monitoring module, marking material  
Page 336



Signal conditioners with PL d and SIL functional safety - MACX Safety  
- Repeater power supply  
Page 342  
- Temperature transducers  
Page 343



Signal conditioners with PL d and SIL functional safety - MACX Safety  
- Repeater power supplies, Ex i  
Page 344  
- Temperature transducers, Ex i  
Page 346



Energy and power measuring technology  
- Software for usage data acquisition  
Page 348  
- Software for data logging  
Page 349



Energy and power measuring technology  
- Pressure sensor with IO-Link  
Page 350



Current and voltage measuring technology  
- PACT RCP... current transformers for retrofitting  
Page 353



Programmable logic relay system - PLC logic  
- Logic modules  
Page 356  
- Accessories  
Page 358



Relay modules - RIFLINE complete  
- Fully mounted RIF-0 relay modules with solid-state relay and push-in connection  
Page 362



Relay modules - RIFLINE complete  
- Fully mounted RIF-1 relay modules with relay with detectable manual operation, status LED, and push-in connection  
Page 364

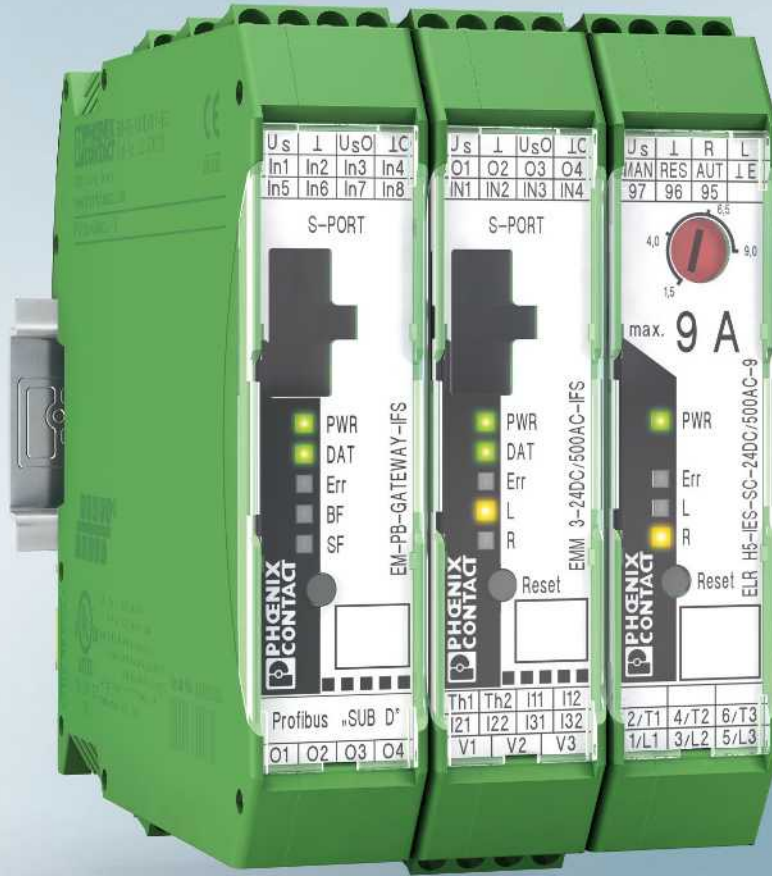

Relay modules - PLC series  
- With integrated solid-state relay

Page 366



VARIOFACE system cabling  
- VIP power cabling  
Universal front adapters for  
SIMATIC® S7-300

Page 368



VARIOFACE system cabling  
- VIP I/O modules

Page 370  
- VIP interface module for Emerson DeltaV  
Page 372



VARIOFACE wiring interface  
- VIP potential distributor with fuses

Page 373



### Easier than ever but slim as before

The new highly compact MINI Analog Pro signal conditioners offer the easiest installation and startup in a confined space.

Easily accessible terminal points, current measurement during operation, and the unique FASTCON Pro plug-in connection technology make your work considerably easier.

### Choose the right MINI Analog signal conditioner for your application:

#### Analog IN/OUT

- Universal and standard 3-way signal conditioners
- 3-way repeater power supplies

#### Temperature

- Universal measuring transducers for resistance thermometers and thermocouples

#### Universal potiposition transducer

- Potiposition transducers with automatic potentiometer detection

#### Accessories

- Supply components
- Fault monitoring module
- Marking material
- Surge protection, see Catalog 6

### Easy installation in a confined space

- Thanks to the front orientation, all terminal points are easily visible and accessible at all times – this not only saves time, but also space above and below devices
- All conductors can be fed individually and in any order, regardless of whether you start wiring from the input or output side
- The FASTCON Pro connection terminal blocks can be inserted and removed in any order

### Measure current signals during operation

You can conveniently measure signals for startup and servicing during operation, thanks to integrated test disconnect terminal blocks:

- The circuit does not have to be separated in order to integrate the measuring device in the signal circuit
- By setting the plug to the disconnect position, signal circuits can be easily interrupted during servicing and startup

### Numerous parameterization options

#### Easy DIP switch configuration

Many of the MINI Analog modules can be configured: the basic functions can be easily set using DIP switches – without the need for any software.

#### PC configuration for extended function and monitoring

For extended functionality, you can configure the modules conveniently with the S port interface on your PC using one of the free software solutions.

#### Smart configuration without accessories

Place your smartphone on the device and establish a wireless connection via near field communication (NFC). Depending on the device type, the free MINI Analog Pro app offers different functions.

#### App functions via NFC communication



**Access to information**  
– Access module information



**DIP switch setting help**  
– Access module information  
– Display DIP switch setting help on the smartphone



**Configuration via NFC**  
– Access module information  
– Display DIP switch setting help  
– Wireless configuration via smartphone

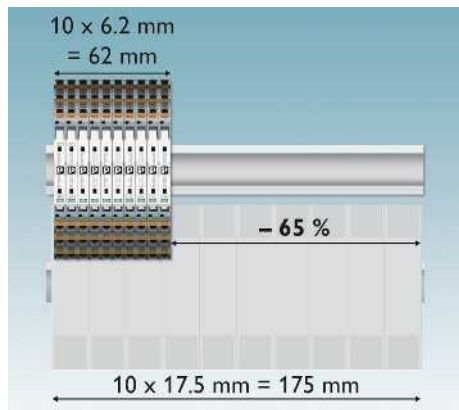

**Space savings of up to 65%**

- Compared to other signal conditioners on the market with design widths up to 17.5 mm.



**Easy installation**

- Easily visible and accessible terminal points and FASTCON Pro plug-in connection terminal blocks.



**Power bridging and fault monitoring**

- The DIN rail connector simplifies supply and enables group error monitoring via remote diagnostics.



**Easy to start up and control**

- Measure current signals during operation, without disconnecting current loops, plus optional disconnect function.



**Numerous parameterization options**

- Easy configuration via DIP switches as well as extended configuration via software or smartphone app without additional accessories.

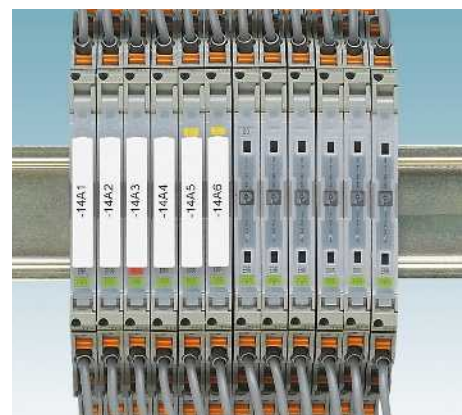

**Easy maintenance**

- Large-surface marking areas for complete loop identification using standard marking material as well as constantly visible status LEDs in every module.



**Choice of connection technology**

- Wiring with screw connection or fast and tool-free push-in technology.



**Optimum signal quality**

- The latest transmission technology and safe electrical isolation between input, output, and supply with 3 kV test voltage.

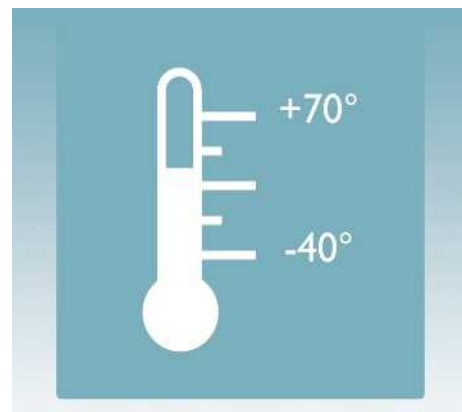

**Suitable for any application**

- Extended supply voltage and temperature range as well as multifunctional device types.

### Analog IN / Analog OUT 3-way signal conditioner

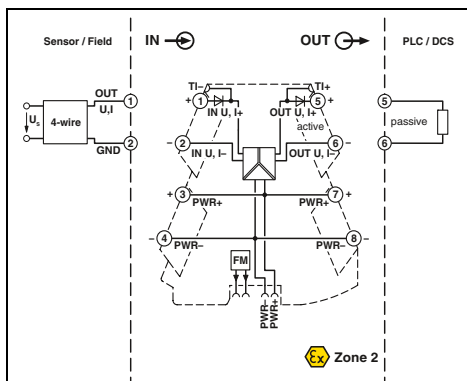
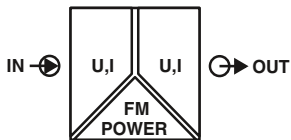

Ex n



**Configurable,  
Up to 144 signal combinations**

Ex: Ex

Housing width 6.2 mm

#### Technical data

- Configurable, ultra-compact signal conditioner for electrical isolation, conversion, amplification, and filtering of standard analog signals
- Plug-in connection system
- Safe 3-way isolation
- Standard signal combinations configurable via DIP switches
- Power supply and fault monitoring possible via DIN rail connector
- Status LED

Input data	U input	I input
Input signal	0 V ... 5 V 1 V ... 5 V -5 V ... 5 V 0 V ... 10 V 2 V ... 10 V -10 V ... 10 V 0 V ... 20 V 4 V ... 20 V -20 V ... 20 V 0 V ... 24 V 4.8 V ... 24 V -24 V ... 24 V 0 V ... 30 V 6 V ... 30 V -30 V ... 30 V > 1000 kΩ	0 mA ... 20 mA 4 mA ... 20 mA -20 mA ... 20 mA
Input resistance		approx. 63 Ω
Output data	U output	I output
Output signal	0 V ... 5 V 1 V ... 5 V -5 V ... 5 V 0 V ... 10 V 2 V ... 10 V -10 V ... 10 V	0 mA ... 20 mA 4 mA ... 20 mA
Maximum output signal		22 mA
No-load voltage		< 17 V
Short-circuit current	< 32 mA	
Load R <sub>B</sub>	≥ 10 kΩ	≤ 600 Ω (at 20 mA)
Ripple	< 20 mV <sub>pp</sub> (at 600 Ω)	< 20 mV <sub>pp</sub> (at 600 Ω)
General data	U output	I output
Supply voltage U <sub>B</sub>	9.6 V DC ... 30 V DC	
Nominal supply voltage	24 V DC	
Current consumption	25 mA (current output, at 24 V DC incl. load)	54 mA (current output, at 12 V DC incl. load) ≤ 800 mW (at I <sub>OUT</sub> = 20 mA, 9.6 V DC, 600 Ω load)
Power consumption		
Maximum transmission error	≤ 0.1% (of final value)	
Temperature coefficient	0.01%/K	
Limit frequency (3 dB)	30 Hz (via DIP switch)	
Step response (10-90%)	< 8.5 ms (with 30 Hz filter)	
Electrical isolation	Reinforced insulation in accordance with IEC 61010-1	
Test voltage, input/output/supply	3 kV (50 Hz, 1 min.)	
Degree of protection	IP20	
Ambient temperature (operation)	-40°C ... 70°C	
Mounting	Any	
Housing material	PBT	
Dimensions W/H/D	6.2/110.5/120.5 mm	
Push-in connection solid/stranded/AWG	0.2 ... 2.5 mm <sup>2</sup> /0.2 ... 2.5 mm <sup>2</sup> /26 - 12	
Screw connection solid/stranded/AWG	0.2 ... 1.5 mm <sup>2</sup> /0.2 ... 1.5 mm <sup>2</sup> /26 - 16	
EMC note	Class A product, see page 443	
Conformance / approvals	CE-compliant	
Conformance	II 3 G Ex nA IIC T4 Gc X	
ATEX	508 listing applied for Class I, Div. 2, Groups A, B, C, D T5 applied for	
UL, USA / Canada	GL applied for	
GL		

#### Ordering data

Description	Type	Order No.	Pcs. / Pkt.	
<b>3-way signal conditioner</b> , for electrical isolation of analog signals				
Standard configuration	Push-in connection	<b>MINI MCR-2-UI-UI-PT</b>	2902040	1
Standard configuration	Screw connection	<b>MINI MCR-2-UI-UI</b>	2902037	1
Order configuration	Push-in connection	<b>MINI MCR-2-UI-UI-PT-C</b>	2902039	1
Order configuration	Screw connection	<b>MINI MCR-2-UI-UI-C</b>	2902036	1





Analog IN / Analog OUT  
3-way signal conditioner

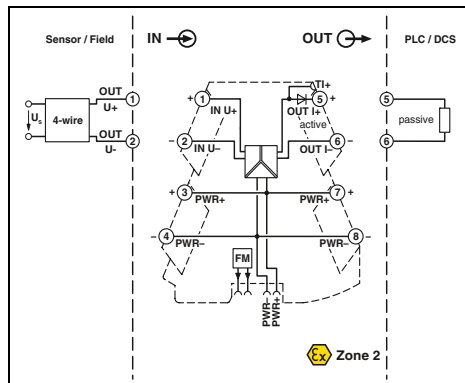
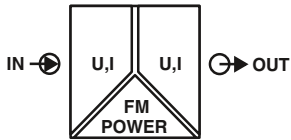

Ex n



With fixed signal combinations

- Highly compact signal conditioner for electrical isolation, conversion, amplification, and filtering of standard analog signals
- Fixed signal combinations
- Plug-in connection system
- Safe 3-way isolation
- Power supply and fault monitoring possible via DIN rail connector
- Status LED

<b>Input data</b>	U input	I input
Input resistance	approx. 100 kΩ	approx. 63 Ω
<b>Output data</b>	U output	I output
Maximum output signal	11 V	22 mA
No-load voltage		< 17 V
Short-circuit current	< 15 mA	
Load R <sub>B</sub>	≥ 10 kΩ	≤ 600 Ω (at 20 mA)
Ripple	< 20 mV <sub>pp</sub> (at 10 kΩ)	< 20 mV <sub>pp</sub> (at 600 Ω)
<b>General data</b>	9.6 V DC ... 30 V DC	
Supply voltage U <sub>B</sub>	24 V DC	
Nominal supply voltage	25 mA (at 24 V DC)	
Typ. current consumption	0.1% (of final value)	
Maximum transmission error	0.01%/K	
Temperature coefficient	approx. 30 Hz	
Limit frequency (3 dB)	approx. 10 ms	
Step response (10-90%)	IP20	
Degree of protection	Reinforced insulation in accordance with IEC 61010-1	
Electrical isolation	3 kV (50 Hz, 1 min.)	
Test voltage, input/output/supply	-40°C ... 70°C	
Ambient temperature (operation)	PBT	
Housing material	6.2/110.5/120.5 mm	
Dimensions W/H/D	0.2 ... 2.5 mm <sup>2</sup> /0.2 ... 2.5 mm <sup>2</sup> /26 - 12	
Push-in connection solid/stranded/AWG	0.2 ... 1.5 mm <sup>2</sup> /0.2 ... 1.5 mm <sup>2</sup> /26 - 16	
Screw connection solid/stranded/AWG	Class A product, see page 443	
EMC note	CE-compliant	
<b>Conformance / approvals</b>	Ex II 3 G Ex nA IIC T4 Gc X	
Conformance	508 listing applied for	
ATEX	Class I, Div. 2, Groups A, B, C, D T5 applied for	
UL, USA / Canada	GL applied for	
GL		

Technical data		
U input	I input	
approx. 100 kΩ	approx. 63 Ω	
U output	I output	
11 V	22 mA	
	< 17 V	
< 15 mA		
≥ 10 kΩ	≤ 600 Ω (at 20 mA)	
< 20 mV <sub>pp</sub> (at 10 kΩ)	< 20 mV <sub>pp</sub> (at 600 Ω)	
9.6 V DC ... 30 V DC		
24 V DC		
25 mA (at 24 V DC)		
0.1% (of final value)		
0.01%/K		
approx. 30 Hz		
approx. 10 ms		
IP20		
Reinforced insulation in accordance with IEC 61010-1		
3 kV (50 Hz, 1 min.)		
-40°C ... 70°C		
PBT		
6.2/110.5/120.5 mm		
0.2 ... 2.5 mm <sup>2</sup> /0.2 ... 2.5 mm <sup>2</sup> /26 - 12		
0.2 ... 1.5 mm <sup>2</sup> /0.2 ... 1.5 mm <sup>2</sup> /26 - 16		
Class A product, see page 443		
CE-compliant		
Ex II 3 G Ex nA IIC T4 Gc X		
508 listing applied for		
Class I, Div. 2, Groups A, B, C, D T5 applied for		
GL applied for		

Description	Input signal	Output signal
<b>3-way signal conditioner</b> , for electrical isolation of analog signals		
Push-in connection	0 ... 10 V	0 ... 20 mA
Screw connection	0 ... 10 V	0 ... 20 mA
Push-in connection	0 ... 10 V	4 ... 20 mA
Screw connection	0 ... 10 V	4 ... 20 mA
Push-in connection	0 ... 20 mA	0 ... 10 V
Screw connection	0 ... 20 mA	0 ... 10 V
Push-in connection	4 ... 20 mA	0 ... 10 V
Screw connection	4 ... 20 mA	0 ... 10 V
Push-in connection	0 ... 20 mA, 4 ... 20 mA	0 ... 20 mA, 4 ... 20 mA
Screw connection	0 ... 20 mA, 4 ... 20 mA	0 ... 20 mA, 4 ... 20 mA
Push-in connection	0 ... 10 V, -10 ... 10 V	0 ... 10 V, -10 ... 10 V
Screw connection	0 ... 10 V, -10 ... 10 V	0 ... 10 V, -10 ... 10 V

Ordering data		
Type	Order No.	Pcs. / Pkt.
MINI MCR-2-U-I0-PT	2902023	1
MINI MCR-2-U-I0	2902022	1
MINI MCR-2-U-I4-PT	2902030	1
MINI MCR-2-U-I4	2902029	1
MINI MCR-2-I0-U-PT	2902001	1
MINI MCR-2-I0-U	2902000	1
MINI MCR-2-I4-U-PT	2902003	1
MINI MCR-2-I4-U	2902002	1
MINI MCR-2-I-I-PT	2901999	1
MINI MCR-2-I-I	2901998	1
MINI MCR-2-U-U-PT	2902043	1
MINI MCR-2-U-U	2902042	1

Analog IN / Analog OUT  
repeater power supplies

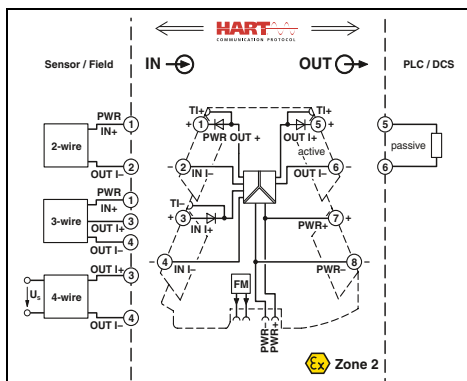
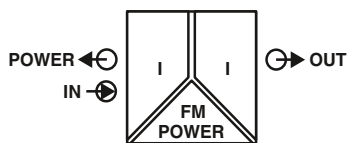

Repeater power supply with HART transmission

- Highly-compact repeater power supply for electrical isolation, conversion, amplification, and filtering of standard analog signals
- Supply of 2-wire and passive 3-wire sensors
- Can also be used as an isolator without supply
- Plug-in connection system
- Safe 3-way isolation
- Bidirectional HART transmission as an option
- Power supply and fault monitoring possible via DIN rail connector
- Status LED

Input data

Input signal  
Input resistance  
Transmitter supply voltage

Output data

Output signal  
Maximum output signal  
No-load voltage  
Load  $R_B$   
Ripple

General data

Supply voltage  $U_B$   
Nominal supply voltage  
Current consumption  
Power consumption

Maximum transmission error  
Temperature coefficient  
Limit frequency (3 dB)  
Communication

Step response (10-90%)

Electrical isolation

Test voltage, input/output/supply

Degree of protection

Ambient temperature (operation)

Mounting

Housing material

Dimensions W/H/D

Push-in connection solid/stranded/AWG

Screw connection solid/stranded/AWG

EMC note

Conformance / approvals

Conformance

ATEX

UL, USA / Canada

GL

Housing width 6.2 mm

Technical data

0 ... 20 mA, isolator operation/4 ... 20 mA  
approx. 68  $\Omega$   
> 19.5 V

0 ... 20 mA/4 ... 20 mA

< 20 V  
 $\leq 600 \Omega$  (at 20 mA)  
< 20 mV<sub>PP</sub> (at 600  $\Omega$ )

9.6 V DC ... 30 V DC  
24 V DC  
25 mA (at 24 V DC and in isolator operation)  
 $\leq 1400$  mW (at  $I_{OUT} = 20$  mA, 9.6 V DC, 600  $\Omega$  load)

0.1% (of final value)  
0.01%/K,  
> 1.75 kHz (typ.)

HART specification in both operating modes  
(RPSS isolator/RPSS repeater power supply)  
< 200  $\mu$ s (typ.)

Reinforced insulation in accordance with IEC 61010-1

IP20  
-40°C ... 70°C

Any

PBT

6.2/110.5/120.5 mm

0.2 ... 2.5 mm<sup>2</sup>/0.2 ... 2.5 mm<sup>2</sup>/26 - 12

0.2 ... 1.5 mm<sup>2</sup>/0.2 ... 1.5 mm<sup>2</sup>/26 - 16

Class A product, see page 443

CE-compliant

II 3 G Ex nA IIC T4 Gc X

508 listing applied for

Class I, Div. 2, Groups A, B, C, D T5 applied for

GL applied for

Ordering data

Description

Repeater power supply with HART transmission

Push-in connection

Screw connection

Type

MINI MCR-2-RPSS-I-I-PT

MINI MCR-2-RPSS-I-I

Order No.

2902015

2902014

Pcs. / Pkt.

1

1

### Temperature

### Temperature transducers for resistance thermometers

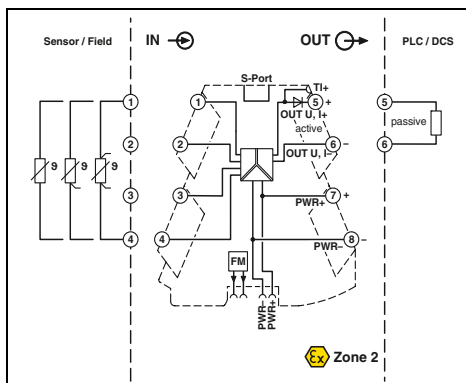
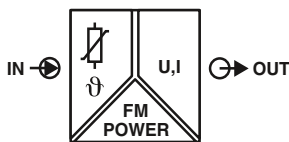

Ex n



**Universal measuring transducer for resistance thermometers**

Ex: Ex

Housing width 6.2 mm

- Universally configurable, highly compact temperature transducer for electrical isolation, conversion, amplification, and filtering of resistance thermometer and remote resistance-type sensor signals
- For 2, 3 or 4-wire sensors according to IEC 751, JIS, GOST

- Plug-in connection system
- Safe 3-way isolation
- Standard signal combinations configurable via DIP switches
- Freely configurable via software or smartphone app
- Power supply and fault monitoring possible via DIN rail connector
- Status and error indicator LEDs

#### Input data

Input signal (can be configured using DIP switches)  
Temperature range

Measuring range span  
Linear resistance measuring range

#### Output data

Output signal

Maximum output signal  
Load  $R_B$   
Ripple

#### General data

Supply voltage  $U_B$   
Current consumption  
Power consumption

Transmission error

Temperature coefficient  
Step response (0–99%)

#### Electrical isolation

Test voltage, input/output/supply  
Ambient temperature (operation)  
Housing material  
Dimensions W/H/D  
Push-in connection solid/stranded/AWG  
Screw connection solid/stranded/AWG  
EMC note

#### Conformance / approvals

Conformance  
ATEX  
UL, USA / Canada

GL

#### Technical data

Pt, Ni, Cu sensors : 2, 3, 4-wire  
-200°C ... 850°C (range depending on the sensor type)

$\geq 20$  K  
0  $\Omega$  ... 4000  $\Omega$   
(Minimum measuring span: 10% of the selected measuring range)

U output	I output
0 ... 5 V/10 ... 5 V	0 ... 20 mA/4 ... 20 mA
0 ... 10 V/10 ... 0 V	20 ... 0 mA/20 ... 4 mA
approx. 12.3 V	24.6 mA
$\geq 10$ k $\Omega$	$\leq 600$ $\Omega$ (at 20 mA)
< 20 mV <sub>pp</sub>	< 20 mV <sub>pp</sub> (at 600 $\Omega$ )

9.6 V DC ... 30 V DC  
32 mA (at 24 V DC)  
 $\leq 850$  mW (at  $I_{OUT} = 20$  mA, 9.6 V DC, 600  $\Omega$  load)

0.1% \* 350 K/set measuring range; 0.1% > 350 K (Pt/Ni)  
0.3% \* 200 K/set measuring range; 0.3% > 200 K (Cu)

0.01%/K

Typ. 200 ms (2-wire)  
Typ. 500 ms (3-wire)  
Typ. 500 ms (4-wire)

Reinforced insulation in accordance with IEC 61010-1

3 kV (50 Hz, 1 min.)

-40°C ... 70°C

PBT

6.2/110.5/120.5 mm

0.2 ... 2.5 mm<sup>2</sup>/0.2 ... 2.5 mm<sup>2</sup>/26 - 12

0.2 ... 1.5 mm<sup>2</sup>/0.2 ... 1.5 mm<sup>2</sup>/26 - 16

Class A product, see page 443

CE-compliant

Ex II 3 G Ex nA IIC T4 Gc X

508 listing applied for

Class I, Div. 2, Groups A, B, C, D T5 applied for

GL applied for

#### Ordering data

#### Description

#### Temperature transducers for resistance thermometers

Standard configuration	Push-in connection
Standard configuration	Screw connection
Order configuration	Push-in connection
Order configuration	Screw connection

**Programming adapter** for configuring modules with S-PORT interface

#### Type

#### Order No.

Pcs. / Pkt.

<b>MINI MCR-2-RTD-UI-PT</b>	<b>2902052</b>	1
<b>MINI MCR-2-RTD-UI</b>	<b>2902049</b>	1
<b>MINI MCR-2-RTD-UI-PT-C</b>	<b>2902051</b>	1
<b>MINI MCR-2-RTD-UI-C</b>	<b>2902048</b>	1

#### Accessories

<b>IFS-USB-PROG-ADAPTER</b>	<b>2811271</b>	1
-----------------------------	----------------	---

Measurement and control technology - MINI Analog Pro highly compact signal conditioners

Order key for MINI-MCR-2-RTD-UI...C temperature transducer (standard configuration entered as an example)

Order No.	Sensor type	Connection technology	Measuring range		Measuring unit	Output		
			Start	End		Output signal	Start	End
2902048	PT100	3	-50	150	C	I	4.0	20.0
2902048 ≙ MINI-MCR-2-RTD-UI-C	PT100 ≙ Pt 100 IEC 751 PT200 ≙ Pt 200 IEC 751 PT500 ≙ Pt 500 IEC 751 PT1000 ≙ Pt 1000 IEC 751 PT100G ≙ Pt 100 GOST 6651-2009 (α = 0.00394) PT1000G ≙ Pt 1000 GOST 6651-2009 (α = 0.00394) PT100J ≙ Pt 100 JIS C1604/1997 PT1000J ≙ Pt 1000 JIS C1604/1997 Ni100 ≙ Ni 100 DIN 43760 Ni1000 ≙ Ni 1000 DIN 43760 Cu50 ≙ Cu 50 GOST 6651-2009 (α = 0.00428) Cu100 ≙ Cu 100 GOST 6651-2009 (α = 0.00428) Cu53 ≙ Cu 53 GOST 6651-2009 (α = 0.00426)	2 ≙ 2-wire 3 ≙ 3-wire 4 ≙ 4-wire	freely selectable between -200°C...850°C (measuring range limits depend on sensor type)	freely selectable between -200°C...850°C (measuring range limits depend on sensor type)	C ≙ °C F ≙ °F	I ≙ I U ≙ U	0.0 ≙ 0 mA I: freely selectable between 0.0...21 mA U: freely selectable between 0.0...10.5 V	20.0 ≙ 20 mA I: freely selectable between 0.0...21 mA U: freely selectable between 0.0...10.5 V

Failure information

Behavior in the event of an error

Open circuit

Short circuit

Overrange

Underrange

...	NE43DO	0.0	0.0	0.0	0.0
FD ≙ Freely definable	0.0 ≙ 0 mA I: freely selectable between 0.0...21.5 mA U: freely selectable between 0.0...11 V (signal type corresponds to selected output signal)	0.0 ≙ 0 mA I: freely selectable between 0.0...21.5 mA U: freely selectable between 0.0...11 V (signal type corresponds to selected output signal)	0.0 ≙ 0 mA I: freely selectable between 0.0...21.5 mA U: freely selectable between 0.0...11 V (signal type corresponds to selected output signal)	0.0 ≙ 0 mA I: freely selectable between 0.0...21.5 mA U: freely selectable between 0.0...11 V (signal type corresponds to selected output signal)	0.0 ≙ 0 mA I: freely selectable between 0.0...21.5 mA U: freely selectable between 0.0...11 V (signal type corresponds to selected output signal)
<b>Note: failure information according to NE 43 can only be selected for 4...20 mA output</b>					
NE43UP ≙ NE 43 upscale NE43DO ≙ NE 43 downscale NE430 ≙ NE 43 0 mA NE43UD ≙ NE 43 upscale/downscale	21.5 mA 3.5 mA 0 mA 3.5 mA	21.5 mA 3.5 mA 0 mA 3.5 mA	21.5 mA 3.5 mA 0 mA 3.5 mA	21.5 mA 3.5 mA 0 mA 21.5 mA	21.5 mA 3.5 mA 0 mA 21.5 mA

Sensor types and measuring ranges for MINI-MCR-2-RTD-UI... temperature transducers

Sensor type	Standard	Measuring range	Smallest measuring span	Adjustable using:
Pt100	IEC 751 = GOST 6651-2009 (α = 0.00385)	-200°C ... +850°C	20 K	DIP switch
Pt200	IEC 751 = GOST 6651-2009 (α = 0.00385)	-200°C ... +850°C	20 K	DIP switch
Pt500	IEC 751 = GOST 6651-2009 (α = 0.00385)	-200°C ... +850°C	20 K	Software or smartphone app
Pt1000	IEC 751 = GOST 6651-2009 (α = 0.00385)	-200°C ... +850°C	20 K	Software or smartphone app
Pt100	GOST 6651-2009 (α = 0.00391)	-200°C ... +850°C	20 K	Software or smartphone app
Pt1000	GOST 6651-2009 (α = 0.00391)	-200°C ... +850°C	20 K	Software or smartphone app
Pt100	JIS C1604-1997	-200°C ... +850°C	20 K	Software or smartphone app
Pt1000	JIS C1604-1997	-200°C ... +850°C	20 K	Software or smartphone app
Ni100	DIN 43760	-60°C ... +250°C	20 K	Software or smartphone app
Ni1000	DIN 43760	-60°C ... +250°C	20 K	Software or smartphone app
Cu50	GOST 6651-2009 (α = 0.0428)	-180°C ... +200°C	20 K	Software or smartphone app
Cu100	GOST 6651-2009 (α = 0.0428)	-180°C ... +200°C	20 K	Software or smartphone app
Cu53	GOST 6651-2009 (α = 0.0426)	-50°C ... +180°C	20 K	Software or smartphone app
Customer-specific characteristic curves		-200°C ... +850°C	20 K	Software or smartphone app

### Temperature

### Temperature transducers for thermocouples

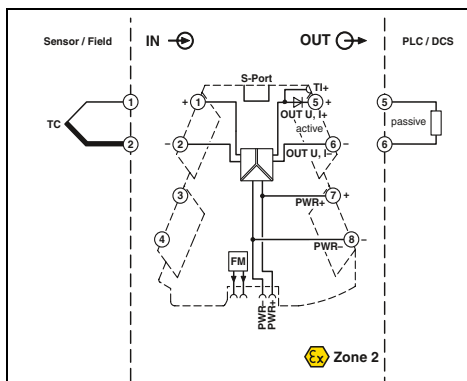
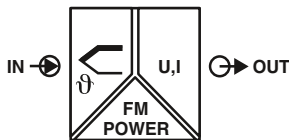

Universal measuring transducer for thermocouples

Ex: Ex

Housing width 6.2 mm

- Universally configurable, highly compact temperature transducer for electrical isolation, conversion, amplification, and filtering of thermocouple signals
- For thermocouples according to IEC 584 and GOST
- Internal cold junction compensation
- Plug-in connection system
- Safe 3-way isolation
- Standard signal combinations configurable via DIP switches
- Freely configurable via software or smartphone app
- Power supply and fault monitoring possible via DIN rail connector
- Status and error indicator LEDs

#### Input data

Input signal (can be configured using DIP switches)  
Temperature range

#### Measuring range span

#### Output data

Output signal (configurable using the DIP switch)

#### Maximum output signal

No-load voltage  
Short-circuit current  
Load  $R_B$   
Ripple

#### General data

Supply voltage  $U_B$   
Current consumption  
Power consumption

#### Transmission error

#### Cold junction errors

Temperature coefficient  
Step response (0-99%)  
Electrical isolation  
Test voltage, input/output/supply  
Ambient temperature (operation)  
Housing material  
Dimensions W/H/D  
Push-in connection solid/stranded/AWG  
Screw connection solid/stranded/AWG  
EMC note

#### Conformance / approvals

Conformance  
ATEX  
UL, USA / Canada

GL

#### Technical data

B, E, J, K, N, R, S, T, L, U, A-1, A-2, A-3, M, L  
-250°C ... 2500°C (range depending on the sensor type)

min. 50 K

#### U output

0 ... 5 V/1 ... 5 V  
0 ... 10 V/10 ... 0 V  
approx. 12.3 V

#### I output

0 ... 20 mA/4 ... 20 mA  
20 ... 0 mA/20 ... 4 mA  
24.6 mA  
< 17.5 V

< 31.5 mA  
≥ 10 kΩ  
< 20 mV<sub>PP</sub>

≤ 600 Ω (at 20 mA)  
< 20 mV<sub>PP</sub> (at 600 Ω)

9.6 V DC ... 30 V DC

32 mA (at 24 V DC)

≤ 850 mW (at  $I_{OUT} = 20$  mA, 9.6 V DC, 600 Ω load)

0.1% \* 600 K/set measuring range; 0.1% > 600 K  
(E, J, K, N, T, L, U, M Gost, L Gost)  
0.2% \* 600 K/set measuring range; 0.2% > 600 K  
(B, R, S, A1, A2, A3)  
(0.2 K \* ΔT) (typ. < 2 K)

≤ 0.01%/K

Typ. 400 ms

Reinforced insulation in accordance with IEC 61010-1

3 kV (50 Hz, 1 min.)

-40°C ... 70°C

PBT

6.2/110.5/120.5 mm

0.2 ... 2.5 mm<sup>2</sup>/0.2 ... 2.5 mm<sup>2</sup>/26 - 12

0.2 ... 1.5 mm<sup>2</sup>/0.2 ... 1.5 mm<sup>2</sup>/26 - 16

Class A product, see page 443

CE-compliant

Ex II 3 G Ex nA IIC T4 Gc X

508 listing applied for

Class I, Div. 2, Groups A, B, C, D T5 applied for

GL applied for

#### Ordering data

Type	Order No.	Pcs. / Pkt.
MINI MCR-2-TC-UI-PT	2905249	1
MINI MCR-2-TC-UI	2902055	1
MINI MCR-2-TC-UI-PT-C	2905248	1
MINI MCR-2-TC-UI-C	2902053	1

#### Accessories

IFS-USB-PROG-ADAPTER	2811271	1
----------------------	---------	---

#### Description

#### Temperature transducers for thermocouples

Standard configuration	Push-in connection
Standard configuration	Screw connection
Order configuration	Push-in connection
Order configuration	Screw connection

Programming adapter for configuring modules with S-PORT interface

Measurement and control technology - MINI Analog Pro highly compact signal conditioners

Order key for MINI-MCR-2-TC-UI...C temperature transducer (standard configuration entered as an example)

Order No.	Sensor type	Cold junction compensation	Measuring range Start	End	Measuring unit	Output Output signal	Start	End	...
2902048	J	1	-200	1200	C	I	4.0	20.0	...
2902253 ≙ MINI-MCR-2-TC-UI-C	B ≙ B IEC 584-1 (Pt130Rh-Pt6Rh) E ≙ E IEC 584-1 (NiCr-CuNi) J ≙ J IEC 584-1 (Fe-CuNi) K ≙ K IEC 584-1 (NiCr-Ni) N ≙ N IEC 584-1 (NiCrSi-NiSi) R ≙ R IEC 584-1 (Pt13Rh-Pt) S ≙ S IEC 584-1 (Pt10Rh-Pt) T ≙ T IEC 584-1 (Cu-CuNi) L ≙ L DIN 43760 (Fe-CuNi) U ≙ U DIN 43760 (Cu-CuNi) A1G ≙ A-1 GOST 8.585-2001 A2G ≙ A-2 GOST 8.585-2001 A3G ≙ A-3 GOST 8.585-2001 MG ≙ M GOST 8.585-2001 LG ≙ L GOST 8.585-2001	0 ≙ OFF 1 ≙ ON	freely selectable between -250°C...2500°C (measuring range limits depend on sensor type)	freely selectable between -250°C...2500°C (measuring range limits depend on sensor type)	C ≙ °C F ≙ °F	I ≙ I U ≙ U	0.0 ≙ 0 mA I: freely selectable between 0.0...21 mA U: freely selectable between 0.0...10.5 V	20.0 ≙ 20 mA I: freely selectable between 0.0...21 mA U: freely selectable between 0.0...10.5 V	...

Failure information

Behavior in the event of an error

Open circuit

Overrange

Underrange

...	NE43DO	0.0	0.0	0.0
FD ≙ Freely definable	0.0 ≙ 0 mA I: freely selectable between 0.0...21.5 mA U: freely selectable between 0.0...11 V (signal type corresponds to selected output signal)	0.0 ≙ 0 mA I: freely selectable between 0.0...21.5 mA U: freely selectable between 0.0...11 V (signal type corresponds to selected output signal)	0.0 ≙ 0 mA I: freely selectable between 0.0...21.5 mA U: freely selectable between 0.0...11 V (signal type corresponds to selected output signal)	0.0 ≙ 0 mA I: freely selectable between 0.0...21.5 mA U: freely selectable between 0.0...11 V (signal type corresponds to selected output signal)
<b>Note: failure information according to NE 43 can only be selected for 4...20 mA output</b>				
NE43UP ≙ NE 43 upscale	21.5 mA	21.5 mA	21.5 mA	21.5 mA
NE43DO ≙ NE 43 downscale	3.5 mA	3.5 mA	3.5 mA	3.5 mA
NE430 ≙ NE 43 0 mA	0 mA	0 mA	0 mA	0 mA
NE43UD ≙ NE 43 upscale/downscale	3.5 mA	21.5 mA	21.5 mA	21.5 mA

Sensor types and measuring ranges for MINI-MCR-2-TC-UI... temperature transducers

Sensor type	Standard	Measuring range	Smallest measuring span	Adjustable using:
B	IEC 584-1	+500°C ... +1820°C	50 K	Software or smartphone app
E	IEC 584-1	-230°C ... +1000°C	50 K	Software or smartphone app
J	IEC 584-1	-210°C ... +1200°C	50 K	DIP switch
K	IEC 584-1	-250°C ... +1372°C	50 K	DIP switch
N	IEC 584-1	-200°C ... +1300°C	50 K	Software or smartphone app
R	IEC 584-1	-50°C ... +1768°C	50 K	Software or smartphone app
S	IEC 584-1	-50°C ... +1768°C	50 K	Software or smartphone app
T	IEC 584-1	-200°C ... +400°C	50 K	Software or smartphone app
L	DIN 43710	-200°C ... +900°C	50 K	Software or smartphone app
U	DIN 43710	-200°C ... +600°C	50 K	Software or smartphone app
A-1	GOST 8.585	0°C ... +2500°C	50 K	Software or smartphone app
A-2	GOST 8.585	0°C ... +1800°C	50 K	Software or smartphone app
A-3	GOST 8.585	0°C ... +1800°C	50 K	Software or smartphone app
M	GOST 8.585	-200°C ... +100°C	50 K	Software or smartphone app
L	GOST 8.585	-200°C ... +800°C	50 K	Software or smartphone app
Customer-specific characteristic curves		-250°C ... +2500°C	50 K	Software or smartphone app

### Potentiometers, potiposition transducers

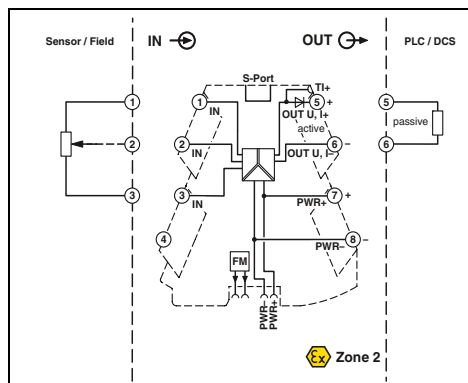
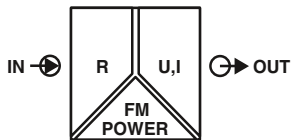

Configurable, automatic potentiometer detection

Ex: Ex

Housing width 6.2 mm

- Universally configurable, highly compact potiposition transducer for electrical isolation, conversion, amplification, and filtering of potentiometer signals
- For potentiometers from 100 Ω to 100 kΩ
- Automatic potentiometer detection without manual adjustment
- Plug-in connection system
- Safe 3-way isolation
- Standard signal combinations configurable via DIP switches
- Freely configurable via software or smartphone app
- Power supply and fault monitoring possible via DIN rail connector
- Status and error indicator LEDs

<b>Input data</b>	Potentiometer Reference voltage source
<b>Output data</b>	Output signal
Maximum output signal	No-load voltage Short-circuit current Load $R_B$ Ripple Behavior in the event of a sensor error
<b>General data</b>	Supply voltage $U_B$ Nominal supply voltage Current consumption Power consumption
Maximum transmission error	Temperature coefficient Step response (0–99%) Electrical isolation Test voltage, input/output/supply Degree of protection Ambient temperature (operation) Mounting Housing material Dimensions W/H/D Push-in connection solid/stranded/AWG Screw connection solid/stranded/AWG EMC note
<b>Conformance / approvals</b>	Conformance ATEX UL, USA / Canada GL

### Technical data

100 Ω ... 100 kΩ	-
<b>U output</b>	<b>I output</b>
1 ... 5 V/10 ... 0 V	0 ... 20 mA/4 ... 20 mA
0 ... 5 V/0 ... 10 V	20 ... 0 mA/20 ... 4 mA
approx. 12.3 V	24.6 mA
< 31.5 mA	< 17.5 V
$\geq 10$ kΩ	$\leq 600$ Ω (at 20 mA)
< 20 mV <sub>PP</sub> (at 10 kΩ)	< 20 mV <sub>PP</sub>
(configurable)	
9.6 V DC ... 30 V DC	24 V DC
33 mA (at 24 V DC)	$\leq 850$ mW (at $I_{OUT} = 20$ mA, 9.6 V DC, 600 Ω load)
< 0.1% ( $R < 240$ Ω = < 0.2%)	0.01%/K
-	-
Reinforced insulation in accordance with IEC 61010-1	3 kV (50 Hz, 1 min.)
IP20	-40°C ... 70°C
Any	PBT
6.2/110.5/120.5 mm	0.2 ... 2.5 mm <sup>2</sup> /0.2 ... 2.5 mm <sup>2</sup> /26 - 12
0.2 ... 1.5 mm <sup>2</sup> /0.2 ... 1.5 mm <sup>2</sup> /26 - 18	Class A product, see page 443
CE-compliant	Ex II 3 G Ex nA IIC T4 Gc X
508 listing applied for Class I, Div. 2, Groups A, B, C, D T5 applied for	GL applied for

### Ordering data

<b>Description</b>	
<b>Potiposition transducer</b>	
Standard configuration	Push-in connection
Standard configuration	Screw connection
Order configuration	Push-in connection
Order configuration	Screw connection

Type	Order No.	Pcs. / Pkt.
<b>MINI MCR-2-POT-UI-PT</b>	2902017	1
<b>MINI MCR-2-POT-UI</b>	2902016	1
<b>MINI MCR-2-POT-UI-PT-C</b>	2905006	1
<b>MINI MCR-2-POT-UI-C</b>	2905005	1

### Accessories

<b>Programming adapter</b> for configuring modules with S-PORT interface	
--	--

<b>IFS-USB-PROG-ADAPTER</b>	2811271	1
-----------------------------	---------	---



Measurement and control technology - MINI Analog Pro highly compact signal conditioners

Order key for MINI-MCR-2-POT-UI...C 3-way signal conditioner (standard configuration entered as an example)

Order No.	Automatic potentiometer detection	Output			Filter	Open circuit detect	...
		Output signal	Start	End			
<b>2905005</b>	<b>AUTO</b>	<b>I</b>	<b>4.0</b>	<b>20.0</b>	<b>1</b>	<b>ON</b>	
2905005 ≙ MINI-MCR-2- POT-UI-C	AUTO ≙ ON OFF ≙ OFF	I ≙ I U ≙ U	0.0 ≙ 0 mA I: freely selectable between 0.0...21 mA U: freely selectable between 0.0...10.5 V	20.0 ≙ 20 mA I: freely selectable between 0.0...21 mA U: freely selectable between 0.0...10.5 V	1 2 3 4 5 6 7 8 9 10	ON ≙ ON OFF ≙ OFF	
2905006 ≙ MINI-MCR-2- POT-UI-PT-C							

Failure information

Behavior in the event of an error

Open circuit slider

Input open (no potentiometer connected)

Overrange

Underrange

...	<b>NE43DO</b>	<b>0.0</b>	<b>0.0</b>	<b>0.0</b>	<b>0.0</b>
FD ≙ Freely definable	0.0 ≙ 0 mA I: freely selectable between 0.0...21.5 mA U: freely selectable between 0.0...11 V (only if open circuit detection is on) (signal type corresponds to selected output signal)	0.0 ≙ 0 mA I: freely selectable between 0.0...21.5 mA U: freely selectable between 0.0...11 V (signal type corresponds to selected output signal)	0.0 ≙ 0 mA I: freely selectable between 0.0...21.5 mA U: freely selectable between 0.0...11 V (signal type corresponds to selected output signal)	0.0 ≙ 0 mA I: freely selectable between 0.0...21.5 mA U: freely selectable between 0.0...11 V (signal type corresponds to selected output signal)	0.0 ≙ 0 mA I: freely selectable between 0.0...21.5 mA U: freely selectable between 0.0...11 V (signal type corresponds to selected output signal)
<b>Note: failure information according to NE 43 can only be selected for 4...20 mA output</b>					
NE43UP ≙ NE 43 upscale NE43DO ≙ NE 43 downscale NE430 ≙ NE 43 0 mA NE43UD ≙ NE 43 upscale/downscale	21.5 mA 3.5 mA 0 mA 3.5 mA	21.5 mA 3.5 mA 0 mA 3.5 mA	21.5 mA 3.5 mA 0 mA 3.5 mA	21.5 mA 3.5 mA 0 mA 21.5 mA	21.5 mA 3.5 mA 0 mA 21.5 mA

### Accessories

#### ME 6,2 TBUS... DIN rail connector

- For bridging the supply voltage
- Reduces wiring costs
- Module replacement without interrupting the supply to the remaining modules (hot swappable)
- One DIN rail connector for two MINI Analog modules
- Only distinguished by color coding



For bridging the supply voltage



For bridging the supply voltage

Description
<b>DIN rail connector (TBUS)</b> , for bridging the supply voltage, can be snapped onto 35 mm DIN rails as per EN 60715, with UL approval
Color: green Color: gray

Ordering data		
Type	Order No.	Pcs. / Pkt.
ME 6,2 TBUS-2 1,5/5-ST-3,81 GN	2869728	10

Ordering data		
Type	Order No.	Pcs. / Pkt.
ME 6,2 TBUS-2 1,5/5-ST-3,81 GY	2695439	10

### Accessories

#### Power terminal blocks

- Power terminal block for supplying the supply voltage to the DIN rail connector
- Plug-in connection system
- Increased output current of 3.2 A
- Monitoring of supplies in combination with the fault monitoring module
- Flexible redundant supply from one or both module sides
- Status and error indicator LEDs

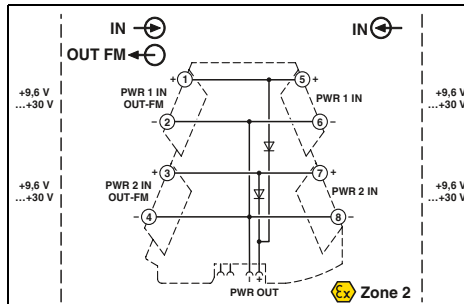

Redundant supply for existing 24 V

Input data/output data
Input voltage range
Output voltage
Output current
General data
Ambient temperature (operation)
Housing material
EMC note
Conformance / approvals
Conformance
ATEX
UL, USA / Canada
GL

Technical data
9.9 V DC ... 30 V DC (Input voltage - 0.3 V) ≤ 3.2 A
-40°C ... 70°C
PBT
Class A product, see page 443
CE-compliant
Ex II 3 G Ex nA IIC T4 Gc X
508 listing applied for
Class I, Div. 2, Groups A, B, C, D T5 applied for
GL applied for

Description
<b>MINI Analog Pro power terminal block</b>
Push-in connection
Screw connection

Ordering data		
Type	Order No.	Pcs. / Pkt.
MINI MCR-2-PTB-PT	2902067	1
MINI MCR-2-PTB	2902066	1

**Accessories**

**ME 17,5 TBUS-... DIN rail connector**

- For bridging the supply voltage when using a MINI POWER system power supply

**Notes:**

If the system power supply is used, two ME 17,5 TBUS DIN rail connectors are required. This allows you to establish the connection to the ME 6,2 TBUS DIN rail connector of the MINI Analog system and provide an effective power supply.



For system power supply

Description
<b>DIN rail connector</b> , for bridging the supply voltage, can be snapped onto 35 mm DIN rails as per EN 60715, with UL approval, two pieces are required per system power supply

Ordering data		
Type	Order No.	Pcs. / Pkt.
ME 17,5 TBUS 1,5/ 5-ST-3,81 GN	2709561	10

**Accessories**

**System power supply**

- For supplying the supply voltage via the DIN rail connector where AC voltages are available
- 100 ... 240 V AC nominal input voltage range
- 24 V DC output voltage
- For up to 60 MINI Analog modules
- For up to 1.5 A, secondary
- Status and error signaling via diagnostic LEDs



For applications with local voltages of over 100 V

Description
<b>System power supply</b> , primary-switched, with zone 2 approval. Further information can be found in Catalog 6, Surge protection and power supplies.
<b>System power supply</b> , primary-switched (not for zone 2!) Further information can be found in Catalog 6, Surge protection and power supplies.

Ordering data		
Type	Order No.	Pcs. / Pkt.
MINI-PS-100-240AC/24DC/1.5/EX	2866653	1
MINI-SYS-PS-100-240AC/24DC/1.5	2866983	1

### Accessories

#### Feed-through terminal blocks

- Feed-through terminal block for 1:1 forwarding of signals that are already electrically isolated in the MINI Analog Pro group
- Plug-in connection system

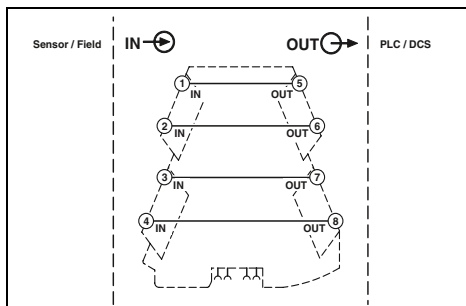

1:1 connection

General data	
Degree of protection	IP20
Ambient temperature (operation)	-40°C ... 70°C
Mounting	Any
Housing material	PBT
Dimensions W/H/D	6.2/110.5/120.5 mm
Screw connection solid/stranded/AWG	0.2 ... 1.5 mm <sup>2</sup> /0.2 ... 1.5 mm <sup>2</sup> /26 - 16
Conformance / approvals	
Conformance	CE-compliant
ATEX	Ex II 3 G Ex nA IIC T4 Gc X
GL	GL applied for

#### Technical data

Degree of protection	IP20
Ambient temperature (operation)	-40°C ... 70°C
Mounting	Any
Housing material	PBT
Dimensions W/H/D	6.2/110.5/120.5 mm
Screw connection solid/stranded/AWG	0.2 ... 1.5 mm <sup>2</sup> /0.2 ... 1.5 mm <sup>2</sup> /26 - 16
Conformance / approvals	
Conformance	CE-compliant
ATEX	Ex II 3 G Ex nA IIC T4 Gc X
GL	GL applied for

Description	
<b>MINI Analog Pro feed-through terminal block</b>	
	Screw connection

#### Ordering data

Type	Order No.	Pcs. / Pkt.
<b>MINI MCR-2-TB</b>	<b>2902068</b>	1

### Accessories

#### Error message modules

- Fault monitoring module for evaluating and reporting group errors from the fault monitoring system
- Monitoring of up to 115 connected MINI Analog Pro modules
- Plug-in connection system
- Monitoring of supply voltages of MINI MCR-2-PTB-(PT) power terminal blocks
- Drawing off the supply is possible
- Fault signaling via an N/C contact
- Status and error indicator LEDs

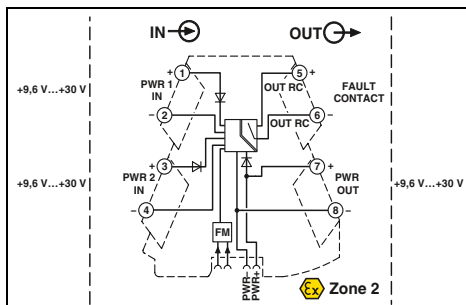

Group error message and supply monitoring

Input data/output data	
Input signal	9.9 V DC ... 30 V DC
Output signal	9.6 V DC ... 29.7 V DC
Switching output	
Max. switching voltage	30 V DC
Max. switching current	50 mA
General data	
Test voltage input/output	1.5 kV AC (50 Hz, 1 min.)
EMC note	Class A product, see page 443
Conformance / approvals	
Conformance	CE-compliant
ATEX	Ex II 3 G Ex nA IIC T4 Gc X
UL, USA / Canada	508 listing applied for Class I, Div. 2, Groups A, B, C, D T5 applied for
GL	GL applied for

#### Technical data

Input signal	9.9 V DC ... 30 V DC
Output signal	9.6 V DC ... 29.7 V DC
Switching output	
Max. switching voltage	30 V DC
Max. switching current	50 mA
General data	
Test voltage input/output	1.5 kV AC (50 Hz, 1 min.)
EMC note	Class A product, see page 443
Conformance / approvals	
Conformance	CE-compliant
ATEX	Ex II 3 G Ex nA IIC T4 Gc X
UL, USA / Canada	508 listing applied for Class I, Div. 2, Groups A, B, C, D T5 applied for
GL	GL applied for

Description	
<b>MINI Analog Pro error signaling module</b>	
	Push-in connection
	Screw connection

#### Ordering data

Type	Order No.	Pcs. / Pkt.
<b>MINI MCR-2-FM-RC-PT</b>	<b>2904508</b>	1
<b>MINI MCR-2-FM-RC</b>	<b>2904504</b>	1

Accessories

Programming adapter

IFS-USB-PROG-ADAPTER programming adapter for configuring Phoenix Contact INTERFACE modules with S-PORT interface.

The adapter is used with FDT/DTM software or ANALOG-CONF software. For programming MACX Analog and MINI Analog.



General data		Technical data		
EMC note		Class A product, see page 443		
Description		Ordering data		
Programming adapter for configuring modules with S-PORT interface		Type	Order No.	Pcs. / Pkt.
		IFS-USB-PROG-ADAPTER	2811271	1

Accessories

Marking label for transparent cover

- Snap-in labels and adhesive labels with large-area for marking
- For snapping into or sticking onto MINI Analog Pro covers, without overlapping the status and error LEDs
- The sheets can be marked quickly and easily using the BLUEMARK CLED and the THERMOMARK CARD..
- They can also be custom printed according to customer requirements



Description		Ordering data			Ordering data		
Description	Color	Type	Order No.	Pcs. / Pkt.	Type	Order No.	Pcs. / Pkt.
UniCard, can be labeled with THERMOMARK CARD and BLUEMARK							
Lettering field size: 30 x 5 mm	white	UCT-EM (30X5)	0801505	10			
Lettering field size: 30 x 5 mm	white	UCT-EM (30X5) CUS	0801589	1			
10-section, lettering field size: 15 x 5 mm	white	UC-EMLP (15X5)	0819301	10			
10-section, lettering field size: 15 x 5 mm	white	UC-EMLP (15X5) CUS	0824550	1			
Self-adhesive marker strips, unprinted, continuous, material off the roll, for marking with thermal transfer printer, can be separated using cutter, pitch as desired, strip length of up to 1000 mm, 10 strips, strip height of 5.0 mm, 1 roll = 90 m							
	white				SK 5,0 WH:REEL	0805221	1



### Integrate analog signals safely

Integrate analog signals easily into your safety application according to the Machinery Directive. The MACX Safety analog signal conditioners are certified according to EN ISO 13849-1 with performance level PL d.

### Ex i signals

MACX Safety Ex enables the easy and safe processing of intrinsically safe analog signals according to the Machinery Directive.

### Cost savings

- Direct safe shutdown without an additional safety controller or in conjunction with a small-scale controller from Phoenix Contact offers a clear cost advantage
- Further cost savings can be made thanks to easy configuration and easy integration in the safety chain
- Versions with push-in technology save installation time

### Choose the right MACX Safety signal conditioner for your application:

#### Analog IN

- 4...20 mA repeater power supplies and input signal conditioners with 2 electrically isolated outputs

#### Temperature

- Universal temperature transducers for resistance thermometers, resistance-type sensors, potentiometers, thermocouples, and mV sources – with safe limit value relay

### Functional safety – from the initial idea to the finished product

Phoenix Contact meets the requirements of functional safety according to IEC 61508 in a standardized development process. Here, all fault avoidance and fault control measures are taken into consideration, from the very development and production of a device right up to device operation. The devices are examined by an independent test center.



#### DIN rail connector-compatible

The DIN rail connector enables the modular bridging of the 24 V supply voltage.



#### Wide range supply

The modules featuring a wide range supply (...-UP) can be used in all power supply networks the world over without the need for additional power supply units.

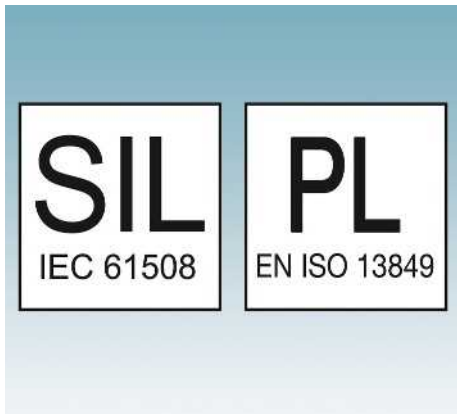

**Safe and reliable functions**

– Consistent PL and SIL certification. This ensures the highest level of reliability and safety for your systems.

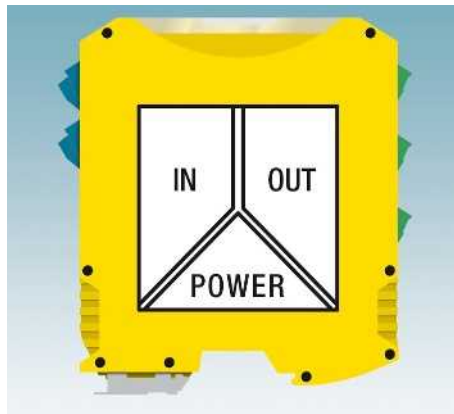

**Precise transmission and high operational reliability**

– Thanks to patented transmission concept  
– Safe electrical isolation.

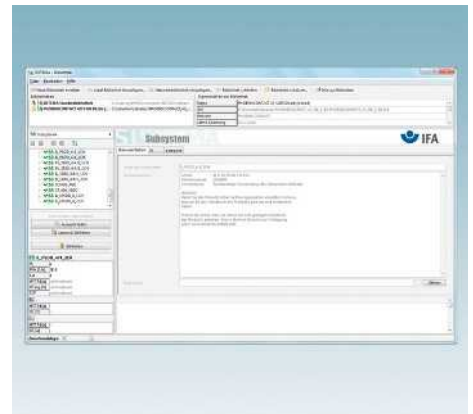

**Easy integration with Sistema**

– Easy integration into the safety chain via Sistema. The required data is already stored in Sistema.

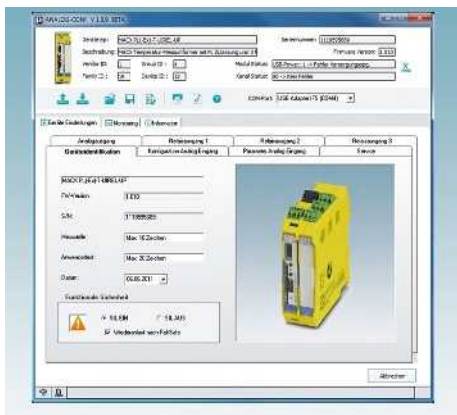

**Easy configuration and monitoring**

– Easy configuration and monitoring with the ANALOG-CONF stand-alone software with integrated monitoring function or with FDT/DTM.



**Easy to combine**

– Analog signals, whether passive or active, can be easily combined with other safety modules.



**Easy-maintenance connection technology**

– Plug-in connection terminal blocks with screw connection or fast push-in technology – coded, with integrated sockets.

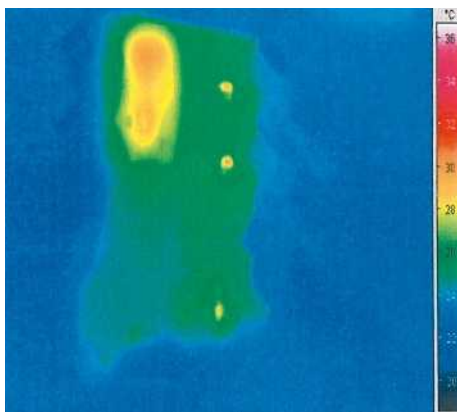

**Precise transmission, long service life**

– Patented circuit concepts ensure precise signal transmission and minimal self-heating.



**Even for the Ex area**

– Maximum explosion protection for all Ex zones with the MACX Safety Ex range as associated intrinsically safe equipment and for installation in zone 2.



**Direct safety shutdown**

– Simple and direct shutdown for small applications is possible without an expensive safety controller or in conjunction with a small-scale controller.

Analog IN

Repeater power supplies

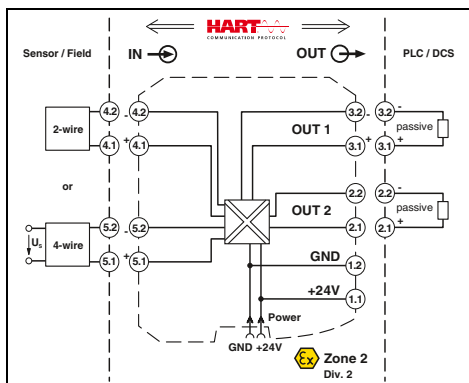
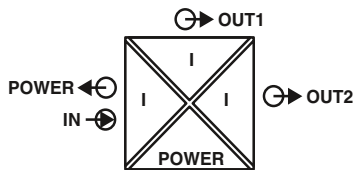

Ex n



EN ISO 13849



Repeater power supply and input signal conditioner, with two electrically isolated outputs

Housing width 12.5 mm

Technical data

- 4...20 mA input, powered and not powered
- Two electrically isolated 4...20 mA (active) outputs
- PL d according to EN ISO 13849-1
- Up to SIL 2 according to EN 61508
- Installation in zone 2 possible
- Plug-in screw and push-in connection technology
- 4-way electrical isolation
- Bidirectional HART communication possible
- Power supply via DIN rail connector possible

Input data	
Input signal	4 mA ... 20 mA/4 mA ... 20 mA
Transmitter supply voltage	> 21.5 V (at 20 mA)
Voltage drop	< 3.9 V (in input signal conditioner operation)
Output data	
Output signal (per output)	4 mA ... 20 mA (active)
Load	< 450 Ω (at 20 mA)
Output ripple	< 20 mV <sub>rms</sub>
General data	
Supply voltage range	19.2 V DC ... 30 V DC (24 V DC (-20% ... +25%))
Current consumption	< 75 mA (at 24 V DC)
Power dissipation	< 1.45 W (at 24 V DC/20 mA)
Temperature coefficient	< 0.01%/K
Step response (10-90%)	< 1.3 ms (for 4 mA ... 20 mA step)
Transmission error, typical	< 0.05% (of final value)
Maximum transmission error	< 0.1% (of final value)
Under-/overload range	According to NE 43
Electrical isolation	
Input/output/power supply	300 V <sub>rms</sub> (rated insulation voltage (surge voltage category II; pollution degree 2, safe isolation as per EN 61010-1)) 2.5 kV (50 Hz, 1 min., test voltage)
Output 1/output 2	1.5 kV AC (50 Hz, 1 min., test voltage) -20°C ... 60°C (any mounting position) Green LED (PWR supply voltage) Yes HART PA 66-FR 12.5/99/114.5 mm 0.2 ... 2.5 mm <sup>2</sup> /0.2 ... 2.5 mm <sup>2</sup> /24 - 14 0.2 ... 1.5 mm <sup>2</sup> /0.2 ... 1.5 mm <sup>2</sup> /24 - 16 Class A product, see page 443
Ambient temperature range	
Status indication	
SMART communication (per output)	
Protocols supported	
Housing material	
Dimensions W/H/D	
Screw connection solid/stranded/AWG	
Spring-cage connection (solid/stranded/AWG)	
EMC note	
Conformance / approvals	
Conformance	CE-compliant, additionally EN 61326
ATEX	Ex II 3 G Ex nA IIC T4 Gc X
SIL in accordance with IEC 61508	2
Performance level according to ISO 13849	PLd

Ordering data

Description	Type	Order No.	Pcs. / Pkt.	
Repeater power supplies and input signal conditioners, signal duplicator, with performance level	Screw connection	MACX PL-RPSSI-2I	2904961	1
	Spring-cage connection	MACX PL-RPSSI-2I-SP	2904962	1



Temperature, temperature transducer

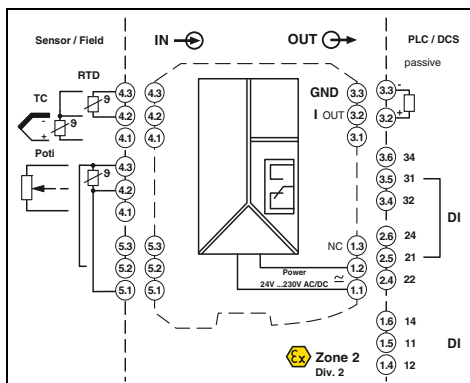
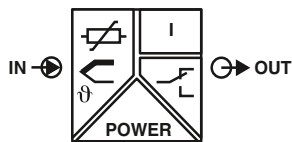

Universal, with limit value relays, wide range power supply

Ex: Ex

Housing width 35 mm

Technical data

<b>Input data</b>	Resistance thermometers Thermocouple sensors	Pt, Ni, Cu sensors: 2, 3, 4-wire B, E, J, K, N, R, S, T, L, U, CA, DA, A1G, A2G, A3G, MG, LG
Resistor Potentiometer Voltage	0 Ω ... 50 kΩ 0 Ω ... 50 kΩ -1000 mV ... 1000 mV	
<b>Output data</b>	Output signal Maximum output signal Load R <sub>B</sub> Behavior in the event of a sensor error	4 mA ... 20 mA 22 mA ≤ 600 Ω (at 20 mA) According to NE 43 or freely configurable
<b>Switching output</b>	Contact type Contact material Max. switching voltage Max. switching current	Relay output 2 PDT AgSnO <sub>2</sub> , hard gold-plated 250 V AC (250 V DC) 2 A (250 V AC)/2 A (28 V DC)
<b>General data</b>	Supply voltage range Power consumption Temperature coefficient Maximum transmission error Electrical isolation	24 V ... 230 V AC/DC (-20%/+10%, 50/60 Hz) < 2.4 W 0.01%/K 0.1% (e.g. for Pt 100, 300 K span, 4 ... 20 mA)
	Input/output/power supply	300 V <sub>ins</sub> (rated insulation voltage (surge voltage category II); pollution degree 2, safe isolation as per EN 61010-1) 2.5 kV (50 Hz, 1 min., test voltage)
	Input/output Input/power supply Input/switching output	375 V (peak value in accordance with EN 60079-11) 375 V (peak value in accordance with EN 60079-11) 375 V (peak value in accordance with EN 60079-11) -20°C ... 65°C Typ. 5% ... 95% (non-condensing) PA 66-FR V0 35/99/114.5 mm 0.2 ... 2.5 mm <sup>2</sup> /0.2 ... 2.5 mm <sup>2</sup> /24 - 14 0.2 ... 1.5 mm <sup>2</sup> /0.2 ... 1.5 mm <sup>2</sup> /24 - 16 Class A product, see page 443
<b>Conformance / approvals</b>	Ambient temperature range Humidity Housing material Inflammability class in acc. with UL 94 Dimensions W/H/D Screw connection solid/stranded/AWG Spring-cage connection (solid/stranded/AWG) EMC note	CE-compliant Ex II 3 G Ex nA nC ic IIC T4 Gc X Ex nA nC ic IIC T4 Gc X 2 PLd
	Conformance ATEX IECEX SIL in accordance with IEC 61508 Performance level according to ISO 13849	

- Input for resistance thermometers, thermocouples, resistance-type sensors, potentiometers, mV sources
- A safety-related limit value relay, by bridging two relays
- Differential measurement possible with Pt 100
- An additional limit value relay for non-safety-related function
- PL d according to EN ISO 13849-1
- Up to SIL 2 according to EN 61508
- Configuration via software (ANALOG-CONF or FDT/DTM)
- Cold junction compensation with separate plug
- Wide range power supply 19.2 ... 253 V AC/DC
- Status indicators for supply voltage, cable, sensor, and module errors
- Installation in zone 2 possible
- Plug-in screw and push-in connection technology

<b>Description</b>	<b>Temperature transducer and threshold value switch with performance level</b>
	Screw connection Spring-cage connection

<b>Programming adapter</b> for configuring modules with S-PORT interface	IFS-USB-PROG-ADAPTER	2811271	1
<b>Plug with 50 Ω resistor</b> , for current signals between +20 mA and -20 mA	MACX MCR-I20	2905680	1

Ordering data

Type	Order No.	Pcs. / Pkt.
MACX PL-T-UIREL-UP	2904901	1
MACX PL-T-UIREL-UP-SP	2904903	1

Accessories

IFS-USB-PROG-ADAPTER	2811271	1
MACX MCR-I20	2905680	1

### Analog IN

#### Repeater power supply, Ex i

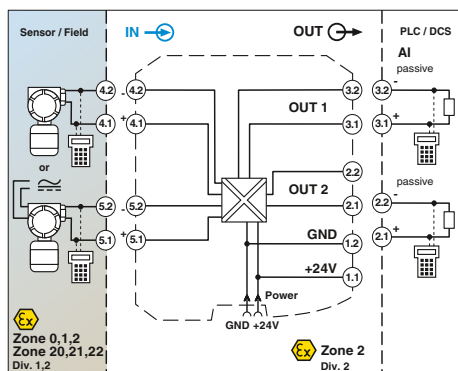
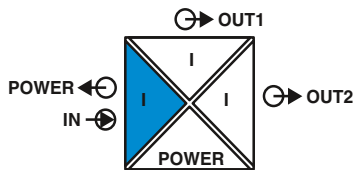

Repeater power supply and input signal conditioner, with two electrically isolated outputs

Housing width 12.5 mm

#### Technical data

- 4...20 mA input, [Ex ia], powered and not powered
- Two electrically isolated 4...20 mA (active) outputs
- PL d according to EN ISO 13849-1
- Up to SIL 2 according to EN 61508
- Installation in zone 2 possible
- Plug-in screw and push-in connection technology
- 4-way electrical isolation
- Bidirectional HART communication possible
- Power supply via DIN rail connector possible

#### Input data

Input signal  
Transmitter supply voltage  
Voltage drop

#### Output data

Output signal (per output)  
Load  
Output ripple

#### General data

Supply voltage range  
Current consumption  
Power dissipation  
Temperature coefficient  
Step response (10-90%)  
Transmission error, typical  
Maximum transmission error  
Under-/overload range  
Electrical isolation

#### Input/output/power supply

Input/output  
Input/power supply  
Output 1/output 2

#### Ambient temperature range

Status indication  
SMART communication (per output)  
Protocols supported  
Housing material  
Dimensions W/H/D  
Screw connection solid/stranded/AWG  
Spring-cage connection (solid/stranded/AWG)  
EMC note

#### Safety data as per ATEX

Max. output voltage  $U_o$   
Max. output current  $I_o$   
Max. output power  $P_o$   
Maximum voltage  $U_m$

#### Conformance / approvals

Conformance  
ATEX  
  
IECEX  
SIL in accordance with IEC 61508  
Performance level according to ISO 13849

4 mA ... 20 mA/4 mA ... 20 mA  
> 16 V (at 20 mA)  
< 3.9 V (in input signal conditioner operation)

4 mA ... 20 mA (active)  
< 450  $\Omega$  (at 20 mA)  
< 20 mV<sub>rms</sub>

19.2 V DC ... 30 V DC (24 V DC (-20% ... +25%))  
< 75 mA (24 V DC/ 20 mA)  
< 1.45 W (24 V DC/ 20 mA)  
< 0.01%/K  
< 1.3 ms (for 4 mA ... 20 mA step)  
< 0.05% (of final value)  
< 0.1% (of final value)  
According to NE 43

300 V<sub>rms</sub> (rated insulation voltage (surge voltage category II; pollution degree 2, safe isolation as per EN 61010-1))  
2.5 kV (50 Hz, 1 min., test voltage)

375 V (peak value in accordance with EN 60079-11)  
375 V (peak value in accordance with EN 60079-11)  
1.5 kV AC (50 Hz, 1 min., test voltage)  
-20°C ... 60°C (any mounting position)  
Green LED (PWR supply voltage)  
Yes  
HART  
PA 66-FR  
12.5/99/114.5 mm  
0.2 ... 2.5 mm<sup>2</sup>/0.2 ... 2.5 mm<sup>2</sup>/24 - 14  
0.2 ... 1.5 mm<sup>2</sup>/0.2 ... 1.5 mm<sup>2</sup>/24 - 16  
Class A product, see page 443

25.2 V  
93 mA  
587 mW  
253 V AC (125 V DC)

CE-compliant, additionally EN 61326  
Ex II (1) G [Ex ia Ga] IIC/IIB  
Ex II (1) D [Ex ia Da] IIIC  
Ex II 3 (1) G Ex nA [ia Ga] IIC/IIB T4 Gc  
[Ex ia Ga] IIC/IIB, [Ex ia Da], Ex nA [ia Ga] IIC/IIB T4 Gc  
2  
PLd

#### Ordering data

#### Description

Repeater power supplies and input signal conditioners, signal duplicator, with performance level, intrinsically safe input

Screw connection  
Spring-cage connection

Type	Order No.	Pcs. / Pkt.
MACX PL-EX-RPSSI-2I	2904959	1
MACX PL-EX-RPSSI-2I-SP	2904960	1

Analog IN

Repeater power supply, Ex i

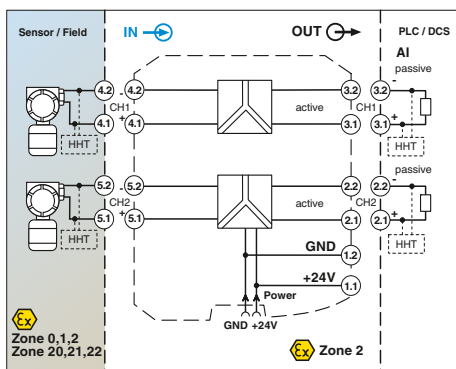
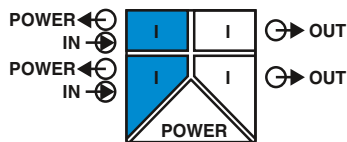

2-channel repeater power supply

- 2-channel
- 4...20 mA input, [Ex ia], powered
- 4 ... 20 mA output (active)
- PL d according to EN ISO 13849-1
- Up to SIL 3 according to IEC 61508
- Installation in zone 2 possible
- Plug-in screw and push-in connection technology
- 3-way electrical isolation, per channel
- Bidirectional HART communication possible
- Power supply via DIN rail connector possible

<b>Input data</b>	
Input signal	
Transmitter supply voltage	
Underload/overload signal range	
<b>Output data</b>	
Output signal	
Load	
Underload/overload signal range	
<b>General data</b>	
Supply voltage range	
Current consumption	
Power dissipation	
Temperature coefficient	
Step response (10-90%)	
Transmission error, typical	
Maximum transmission error	
Electrical isolation	
Input/output, power supply	
Input/output	
Input/power supply	
Output 1/output 2/ power supply	
Ambient temperature range	
Status indication	
SMART communication	
Signal bandwidth	
Protocols supported	
Housing material	
Dimensions W/H/D	
Screw connection solid/stranded/AWG	
Spring-cage connection (solid/stranded/AWG)	
EMC note	
<b>Safety data as per ATEX</b>	
Max. output voltage $U_o$	
Max. output current $I_o$	
Max. output power $P_o$	
Maximum voltage $U_m$	
<b>Conformance / approvals</b>	
Conformance	
ATEX	
IECEx	
SIL in accordance with IEC 61508	
Performance level according to ISO 13849	

Ex: Ex

Housing width 12.5 mm

Technical data

per channel	
4 mA ... 20 mA	
> 16 V (at 20 mA)	
0 mA ... 24 mA	
per channel	
4 mA ... 20 mA (active)	
≤ 450 Ω (20 mA)	
0 mA ... 24 mA	
19.2 V DC ... 30 V DC (24 V DC (-20% ... +25%))	
< 100 mA (24 V/20 mA)	
< 1.4 W (at 24 V DC/20 mA)	
< 0.01%/K	
< 1.3 ms (for 4 mA ... 20 mA step)	
< 0.05% (of final value)	
< 0.1% (of final value)	
300 V <sub>rms</sub> (rated insulation voltage (surge voltage category II; pollution degree 2, safe isolation as per EN 61010-1))	
2.5 kV (50 Hz, 1 min., test voltage)	
375 V (peak value in accordance with EN 60079-11)	
375 V (peak value in accordance with EN 60079-11)	
1.5 kV (50 Hz, 1 min., test voltage)	
-20°C ... 60°C (any mounting position)	
Green LED (supply voltage)	
Yes	
as per HART specifications	
HART	
PA 66-FR	
12.5/99/114.5 mm	
0.2 ... 2.5 mm <sup>2</sup> /0.2 ... 2.5 mm <sup>2</sup> /24 - 14	
0.2 ... 1.5 mm <sup>2</sup> /0.2 ... 1.5 mm <sup>2</sup> /24 - 16	
Class A product, see page 443	
25.2 V	
93 mA	
587 mW	
253 V AC (125 V DC)	
CE-compliant, additionally EN 61326	
Ex II (1) G [Ex ia Ga] IIC/IIB	
Ex II (1) D [Ex ia Da] IIIC	
Ex II 3(1) G Ex nA [ia Ga] IIC T4 Gc	
[Ex ia Ga] IIC/IIB, [Ex ia Da] IIIC, Ex nA [ia Ga] IIC T4 Gc	
3	
PLd	

Ordering data

Description	Type	Order No.	Pcs. / Pkt.
Repeater power supply, two-channel, with performance level, intrinsically safe input			
Screw connection	MACX PL-EX-RPSS-2I-2I	2904963	1
Spring-cage connection	MACX PL-EX-RPSS-2I-2I-SP	2904964	1

### Temperature

#### Temperature transducer, Ex i

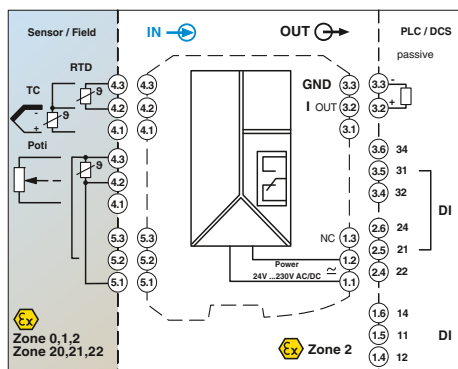
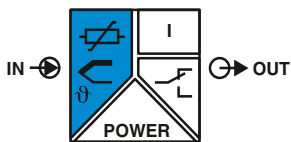

Universal, with limit value relays,  
wide range power supply

Housing width 35 mm

#### Technical data

- Input for resistance thermometers, thermocouples, resistance-type sensors, potentiometers, mV sources, [Ex ia]
- Differential measurement possible with Pt 100
- A safety-related limit value relay, by bridging two relays
- An additional limit value relay for non-safety-related function
- PL d according to EN ISO 13849-1
- Up to SIL 2 according to EN 61508
- Configuration via software (ANALOG-CONF or FDT/DTM)
- Cold junction compensation with separate plug
- Wide range power supply 19.2 ... 253 V AC/DC
- Status indicators for supply voltage, cable, sensor, and module errors
- Installation in zone 2 possible
- Plug-in screw and push-in connection technology

#### Input data

Resistance thermometers  
Thermocouple sensors

Resistor  
Potentiometer  
Voltage

#### Output data

Output signal  
Maximum output signal  
Load  $R_B$   
Behavior in the event of a sensor error

#### Switching output

Contact type  
Contact material  
Max. switching voltage  
Max. switching current

#### General data

Supply voltage range  
Power consumption  
Temperature coefficient  
Maximum transmission error  
Electrical isolation

#### Input/output/power supply

Input/output 2.5 kV (50 Hz, 1 min., test voltage)  
Input/output 375 V (peak value in accordance with EN 60079-11)  
Input/power supply 375 V (peak value in accordance with EN 60079-11)  
Input/switching output 375 V (peak value in accordance with EN 60079-11)  
Output/supply 300 V<sub>rms</sub> (rated insulation voltage (surge voltage category II; pollution degree 2, safe isolation as per EN 61010-1))

#### Ambient temperature range

Humidity  
Housing material  
Inflammability class in acc. with UL 94  
Dimensions W/H/D  
Screw connection solid/stranded/AWG  
Spring-cage connection (solid/stranded/AWG)  
EMC note

#### Safety data as per ATEX

Max. output voltage  $U_o$   
Max. output current  $I_o$   
Max. output power  $P_o$

#### Conformance / approvals

Conformance  
ATEX

#### IECEX

SIL in accordance with IEC 61508  
Performance level according to ISO 13849

Pt, Ni, Cu sensors: 2, 3, 4-wire  
B, E, J, K, N, R, S, T, L, U, CA, DA, A1G, A2G, A3G, MG, LG

0  $\Omega$  ... 50 k $\Omega$   
0  $\Omega$  ... 50 k $\Omega$   
-1000 mV ... 1000 mV

4 mA ... 20 mA  
22 mA  
 $\leq 600 \Omega$  (20 mA)  
According to NE 43 or freely configurable

Relay output  
2 PDT  
AgSnO<sub>2</sub>, hard gold-plated  
250 V AC (250 V DC)  
2 A (250 V AC)/2 A (28 V DC)

24 V ... 230 V AC/DC (-20%/+10%, 50/60 Hz)  
< 2.4 W  
0.01%/K  
0.1% (e.g. for Pt 100, 300 K span, 4 ... 20 mA)

-20°C ... 65°C  
Typ. 5% ... 95% (non-condensing)

PA 66-FR  
V0  
35/99/114.5 mm  
0.2 ... 2.5 mm<sup>2</sup>/0.2 ... 2.5 mm<sup>2</sup>/24 - 14  
0.2 ... 1.5 mm<sup>2</sup>/0.2 ... 1.5 mm<sup>2</sup>/24 - 16  
Class A product, see page 443

6 V  
7.4 mA  
11 mW

#### CE-compliant

Ex II (1) G [Ex ia Ga] IIC  
Ex II (1) D [Ex ia Da] IIIC  
Ex II 3 G Ex nA nC ic IIC T4 Gc X  
[Ex ia Ga] IIC, [Ex ia Da] IIIC, Ex nA nC ic IIC T4 Gc X  
2  
PLd

#### Ordering data

Type	Order No.	Pcs. / Pkt.
MACX PL-EX-T-UIREL-UP	2904910	1
MACX PL-EX-T-UIREL-UP-SP	2904912	1

#### Accessories

IFS-USB-PROG-ADAPTER	2811271	1
MACX MCR-EX-I20	2905679	1

#### Description

Temperature transducer with threshold value switch, with performance level, intrinsically safe input

Screw connection  
Spring-cage connection

Programming adapter for configuring modules with S-PORT interface

Plug with 50  $\Omega$  resistor, for current signals between +20 mA and -20 mA

## Configuration software ANALOG-CONF and FDT/DTM

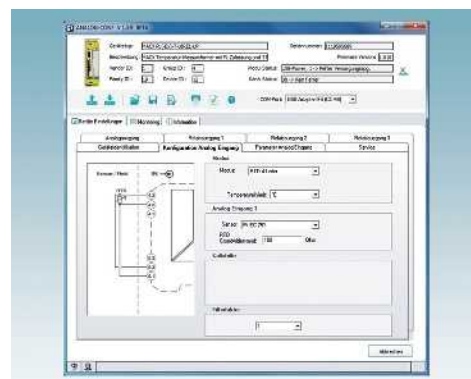
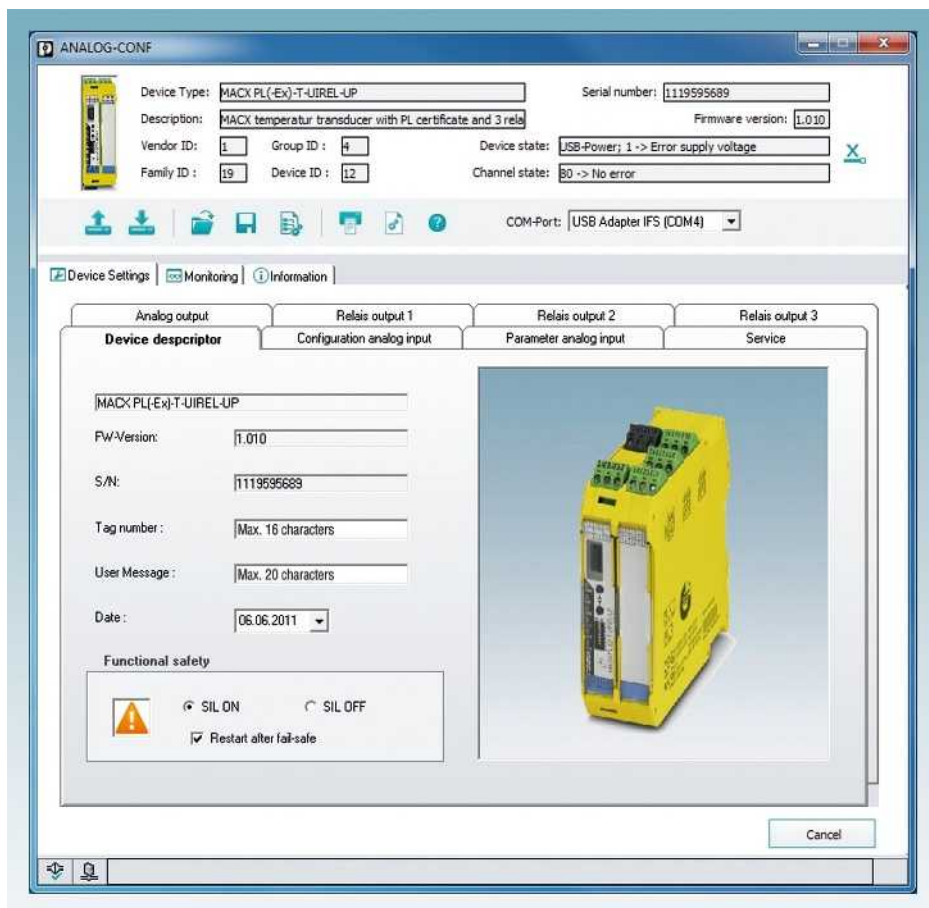

Input configuration with indication of the pin assignment

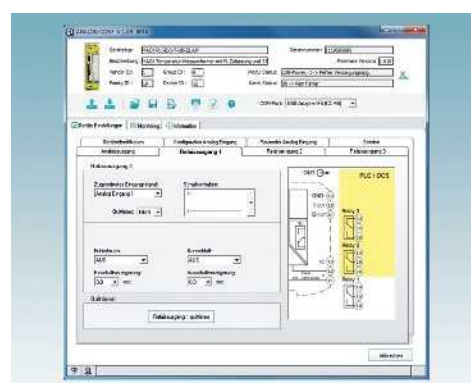

Relay configuration

### ANALOG-CONF

The user-friendly ANALOG-CONF software allows you to quickly and clearly configure the temperature modules. The pin assignment for the input and output is directly displayed. You have access to the complete range of configurable parameters. You have the option to pre-configure parameters and then import them into any number of temperature transducers or read the data from the device and directly display the settings and measured values.

### FDT/DTM

Configuration is also possible via the FDT/DTM universal configuration tool. The DTM files can simply be downloaded in the download area for the item.

### The following parameters can be configured:

- Restart following failsafe

#### Input:

- Resistance thermometer
- Thermocouples
- Potentiometer
- Remote resistance-type sensor
- Voltage signals  $\pm 1$  V
- User characteristic curve
- Additional analog signals
- Filter
- Cold junction

#### Analog output:

- Type of fault signaling

#### Switching outputs:

- Acknowledgement, switching behavior
- Switch-on/off delay

#### Monitoring:

- Representation in diagram or value list, recording possible

#### Service:

- Reset, password protection, display DIP switch position
- and much more

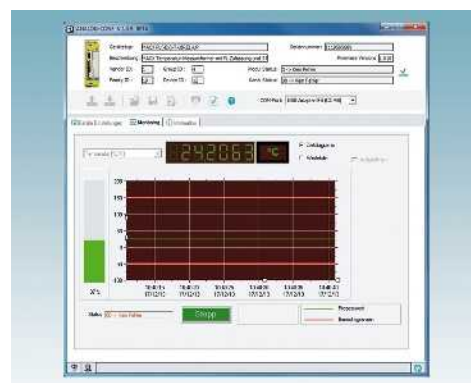

Monitoring function

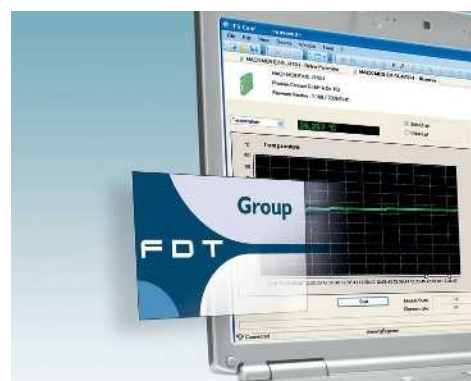

Configuration with FDT/DTM

### Software for acquisition of usage data

The EMwise software from Phoenix Contact is the efficient solution for acquiring energy data regarding heat, cold, air or electricity in conjunction with a small-scale controller.

Integrate up to 24 digital inputs, 8 analog channels, 50 EMpro energy meters, 30 M-bus counters, and 4 IO-Link measuring sensors.

A web-based interface is available for system parameterization. Each device/channel can be configured individually, without any programming knowledge. The configuration is saved to a file and can be reused for identical systems.

Your advantages:

- Startup without programming knowledge
- Direct parameterization of predefined sensors

Three software versions, suitable for every application:

- EMWISE IMPULS: for up to 16 digital signals
- EMWISE IMP ANALOG: for up to 16 digital and 6 analog signals
- EMWISE EXTENDED: for up to 24 digital and 8 analog signals, EMpro energy meters, M-bus counters, M-bus level converters, IO-Link sensors



#### Technical data

See [phoenixcontact.net/products](http://phoenixcontact.net/products)

#### Ordering data

Description
<b>Program and configuration memory</b> , plug-in, 2 GB with license key and application program for reading from measuring devices via pulses
<b>Program and configuration memory</b> , plug-in, 2 GB with license key and application program for reading from measuring devices via pulses and analog values
<b>Program and configuration memory</b> , plug-in, 2 GB with license key and application program for reading from measuring devices via pulses, analog values, M-bus, Modbus RTU, and IO-Link

Type	Order No.	Pcs. / Pkt.
SD FLASH 2GB EMWISE IMPULS	2701745	1
SD FLASH 2GB EMWISE IMP ANALOG	2701746	1
SD FLASH 2GB EMWISE EXTENDED	2701747	1

## Software for data logging

Turn your controller into a data logger. The SD FLASH 512MB ILDLC FLEX memory card from Phoenix Contact provides all the software needed to extend your PLC for use as a data logger. The software contains the familiar application from the FLEX data logger kit.

In conjunction with the ILC 151 GSM/GPRS small-scale controller, 3 digital and 4 analog input or output terminal blocks can be mounted. The mounted terminals are automatically detected and started up by the controller. Different PCP channels can also be selected during parameterization.

Your advantages:

- Send digital and analog status information via SMS or e-mail or write it to an SQL database
- Startup without programming knowledge



### Technical data

See [phoenixcontact.net/products](http://phoenixcontact.net/products)

### Ordering data

Description
SD FLASH card with data logger FLEX application

Type	Order No.	Pcs. / Pkt.
SD FLASH 512MB ILDLC FLEX	2701873	1

#### Pressure sensor with IO-Link

Pressure sensors from Phoenix Contact detect the operating pressure of gas media in a range from -1 to 10 bar. The overload-proof ceramic measuring cell is designed for in excess of 100 million cycles and enables a high switching point accuracy. The pressure switch offers the option of using the set switching points via two switching outputs or reading all process data via the IO-Link interface.

Your advantages:

- IO-Link communication
- Parameterization, diagnostics, and process value monitoring via IO-Link
- Programmable function
- 4-character alphanumeric display

 IO-Link



Pressure monitoring
Measuring range
Pressure resistance
Process connection
Supply for module electronics
Connection method
No. of pos.
Supply voltage range
Current draw
Digital outputs
Number of outputs
Connection method
Delay time
IO-Link
Specification
Transmission speed
General data
Weight
Width
Height
Depth
Degree of protection
Protection class
Ambient temperature (operation)
Ambient temperature (storage/transport)
Vibration resistance in acc. with EN 60068-2-6/IEC 60068-2-6

#### Technical data

-1 bar ... 10 bar (minimum burst pressure 150 bar)
75 bar
G1/4 I
M12 connector
4
18 V DC ... 36 V DC
< 35 mA
2 (OUT1 = switching output, OUT2 = switching output or diagnostic output)
M12 connectors, assigned four times
0.3 s (operational readiness)
V1.1
(38.4 kbaud)
263 g
34 mm
91.5 mm
48 mm
IP65
III
-25°C ... 80°C
-40°C ... 100°C
20g (10 Hz ... 2000 Hz)

Description
<b>Pressure switch with indicator,</b> G1/4 I process connection, IO-Link communication

#### Ordering data

Type	Order No.	Pcs. / Pkt.
PSK APS7004IOL	2700710	1





### Current transformers for retrofitting PACT RCP

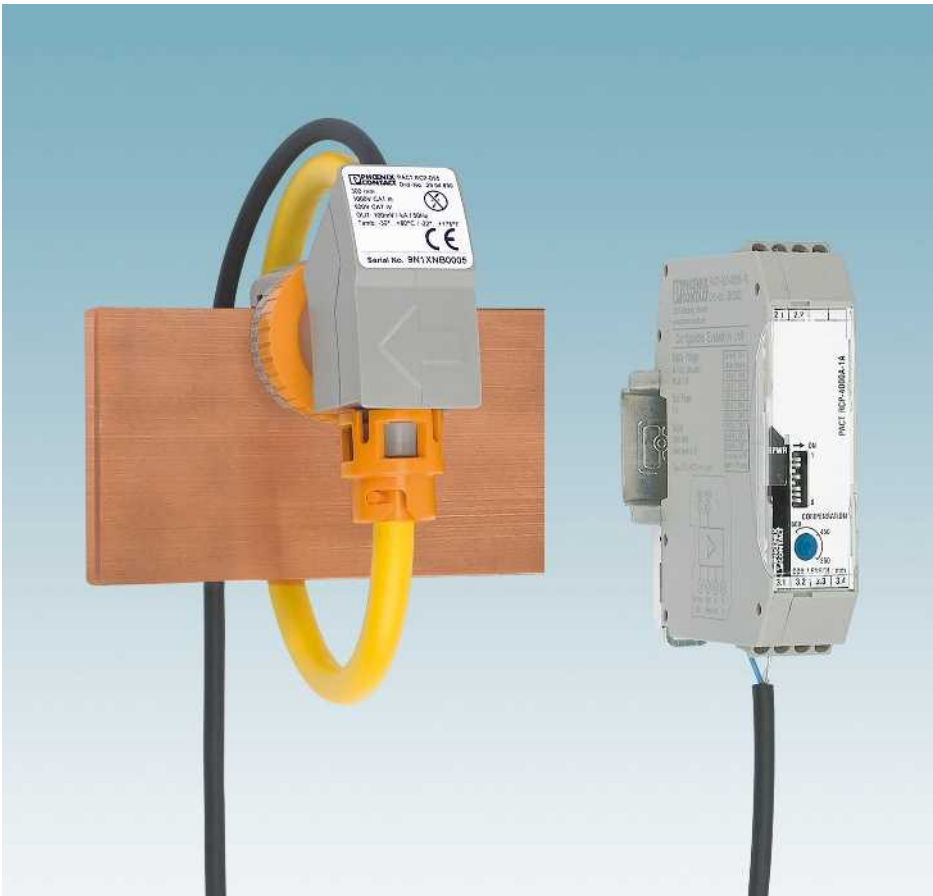

Fast installation without removing system parts



Eight different current measuring ranges from 100 to 4000 A

#### Fast installation in a confined space

PACT current transformers for retrofitting can be conveniently mounted where there is not enough space for split core current transformers. System downtimes are reduced as system parts do not have to be removed for installation.

Simply place the handy Rogowski coil quickly around power rails and circular conductors. The measuring transducer connected downstream supplies the same typical secondary currents as a standard current transformer.

#### Your advantages:

- High system availability due to reduced downtimes: fast installation without removing system parts
- Transform alternating currents up to 4000 A using a single measuring system
- Space saving and handy, as the current strength does not affect the size and weight of the coil
- Safe installation and operation: no dangerous open circuit voltages
- Harmonics and transients detected with phase accuracy with a large frequency spectrum from 10 to 5000 Hz
- Rogowski coil secured on power rails and circular conductors thanks to professional holding device



Detect harmonics and transients with a large frequency spectrum from 10 to 5000 Hz



Professional holding device for power rails

### Current transformers for retrofitting PACT RCP

- Practical handling due to the flexible measuring coil for opening
- Universal application possibilities through 8 different current measuring ranges in one device: (0 ... 100/ ... / ... /4,000 A)
- The large bandwidth (10 ... 5,000 Hz) enables harmonics and transients to be detected
- It is not possible for dangerous open circuit voltages to occur
- The bracket ensures optimum alignment of the measuring coil to the power rail
- Low space requirement in the control cabinet



Current transformer for subsequent installation in the field

Technical data	
Measuring coil input data	
Frequency range	10 Hz ... 5000 Hz
Input signal	Sine
Position error	< 1% (the measuring coil is at right angles to the live connector.)
Measuring coil signal output	
Output signal (at 50 Hz)	100 mV (no load, at 1,000 A)
General data, measuring coil	
Length of signal cable	3000 mm
Rated insulation voltage	1000 V AC (rms CAT III) 600 V AC (rms CAT IV) 10.45 kV (DC/1 min.)
Test voltage	
Ambient temperature (operation)	-30°C ... 80°C (measuring coil)
Ambient temperature (storage/transport)	-40°C ... 90°C (measuring coil)
Measuring transducer input data	
Measuring ranges (current) via DIP switch	100 A 250 A 400 A 630 A 1000 A 1500 A 2000 A 4000 A
Phase angle	< 1°
Measuring transducer signal input	
Input signal (at 50 Hz)	100 mV (1000 A)
Measuring transducer signal output	
Current output signal	1 A AC (effective at sine)
Miscellaneous data for measuring transducer	
Nominal supply voltage	24 V DC -20 % ... +25 %
Nominal supply voltage range	19.2 V DC ... 30 V DC
Transmission error, maximum	≤ 0.5% (from the range end value)
Linearity error	< 0.5% (from the range end value)
Frequency range	45 Hz ... 65 Hz
Degree of protection	IP20
Test voltage	1.5 kV AC (supply/input and output)
Dimensions W/H/D	22.5/70.4/85 mm
Ambient temperature (operation)	-20°C ... 70°C (measuring transducer)
Ambient temperature (storage/transport)	-25°C ... 85°C (measuring transducer)
General data for the set	
Altitude	< 2000 m
Permissible humidity (operation)	5% ... 95% (non-condensing)
Approvals / conformities	
Standards/specifications	IEC 61010-1 IEC 61010-031 IEC 61010-2-031 IEC 61010-2-032

Description
<b>Current transformer for retrofitting</b> , set consisting of Rogowski coil and measuring transducer, output signal: 1 A AC (effective for sine)
Length of measuring coil 300 mm
Length of measuring coil 450 mm
Length of measuring coil 600 mm

Holding device for power rail
PACT RCP-CLAMP

Ordering data		
Type	Order No.	Pcs. / Pkt.
PACT RCP-4000A-1A-D95	2904921	1
PACT RCP-4000A-1A-D140	2904922	1
PACT RCP-4000A-1A-D190	2904923	1

Accessories		
Type	Order No.	Pcs. / Pkt.
PACT RCP-CLAMP	2904895	1

#### Recommendations for the use of coil lengths and power rail dimensions

Power rail	Dia-meter/coil length	1 power rail per phase	2 power rails per phase	3 power rails per phase
[mm x mm]	[mm]			
30 x 10	95/300	X	X	
40 x 10	95/300	X	X	
40 x 10	140/450			X
50 x 10	95/300	X		
50 x 10	140/450		X	X
60 x 10	95/300	X		
60 x 10	140/450		X	X
60 x 10	140/450	X	X	X
100 x 10	140/450	X	X	
100 x 10	190/600			X
120 x 10	140/450	X		
120 x 10	190/600		X	X
160 x 10	190/600	X	X	X

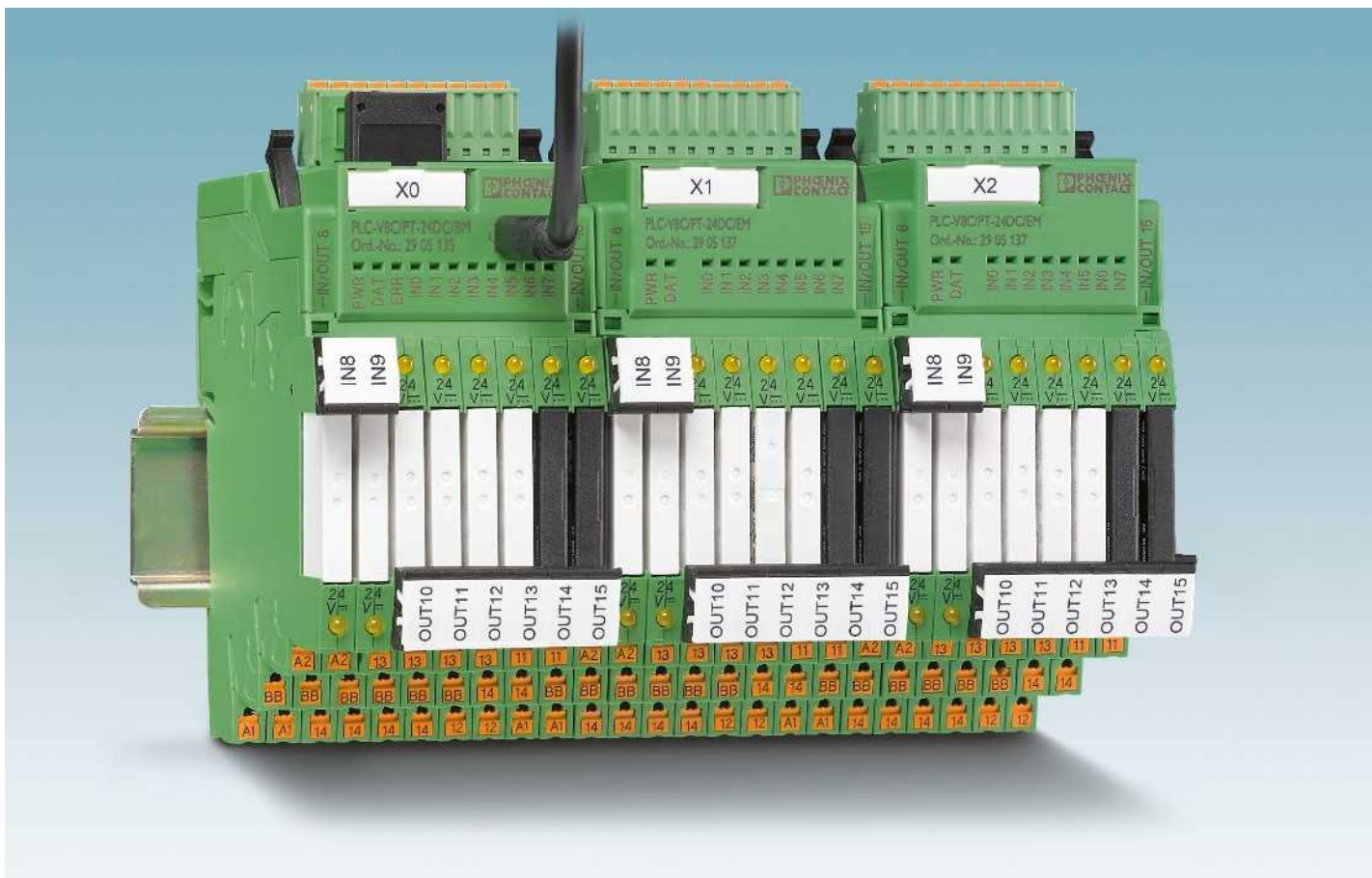

### Extremely compact control

The PLC logic programmable logic relay system is the extremely compact way to carry out small automation tasks easily and flexibly. It consists of the PLC-V8C logic modules, the PLC-INTERFACE relay system, and the LOGIC+ software. The logic modules are simply plugged into a row of eight PLC-INTERFACE terminal blocks and combine the logic and interface level in one unit. Depending on the switching requirements, plug-in electromechanical and solid-state relays can be combined in order to flexibly switch and control the I/O signals.

PLC logic processes digital and analog input signals as well as logic functions and timer modules - and replaces conventional switching and control devices. Up to 16 I/O signals can be processed using the stand-alone logic modules - that's with a design width of just 50 mm. If more I/O signals are required, a maximum of 48 I/O signals can be linked using the basic and extension modules.

### Switching and controlling with plug-in relays

- PLC logic brings together the standard combination of logic module and separate plug-in relay and eliminates the wiring effort and additional switching elements
- Convenient connections with screw or push-in connection technology, which also accommodate return conductors, remove the need for separate potential terminal blocks
- Each relay channel can be freely configured as an input or output. PLC logic therefore perfectly adapts to fit the application at hand

### Intuitive programming

Programming is quick and easy with the intuitive LOGIC+ programming software. Ladder (LD) and function block diagrams (FBD) can be created by selecting the relevant functions and their connection using drag & drop. The graphical representation of PLC logic in the hardware editor supports intuitive operation. The programs created can be simulated offline on the PC and tested online during operation. Basic functions, such as AND, OR, NOT, etc. are complemented by special functions, such as counters, seven-day timers, timer modules, and mathematical functions, to name a few.



### Logic module with plug-in relays

PLC logic combines a logic module and plug-in relay and eliminates the wiring effort and additional switching elements. Each relay channel can be flexibly equipped with an electromechanical or a solid-state relay. PLC logic processes 16 I/O signals with just one logic module and boasts an extremely compact design width of just 50 mm.



### Intuitive programming with LOGIC+

- Function block diagram or ladder diagram
- Numerous integrated function blocks
- Specific function blocks are available to download
- Hardware view in the program
- Download free of charge at [www.phoenixcontact.com](http://www.phoenixcontact.com).



### Standard programming cable

PLC logic is connected to a PC via a standard micro USB cable. The drivers for PLC logic are automatically installed on connection by means of plug and play.



### Easily connect extension modules

The basic module and the extension module are connected via integrated connectors - no tools required. A maximum of two extension modules can be connected to a basic module. This means that PLC logic can work with up to 48 I/Os.



### Saving and copying data

PLC logic programs are saved by the memory block or can be easily copied to other devices.

If settings such as time or date are required on the new device, these values can be configured via the integrated web server. The new device does not need access to the LOGIC+ software for this.

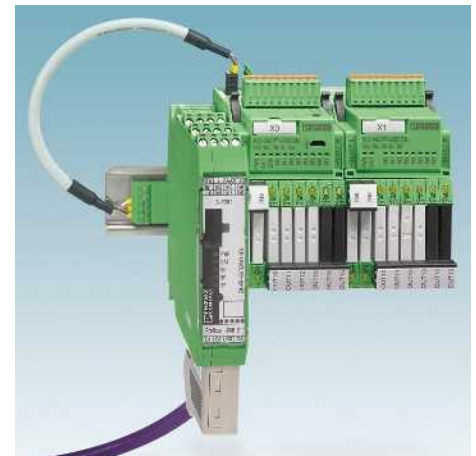

### Integration into PROFIBUS DP

Adaptable fieldbus gateways, available as an option, can be used to integrate PLC logic into a PROFIBUS DP network. This enables communication with a higher-level controller for remote control, diagnostics, and visualization purposes.

DTM device drivers and GSD files for configuring the gateway can be downloaded free of charge at [www.phoenixcontact.com](http://www.phoenixcontact.com).

### Logic modules

PLC-V8C are the plug-in logic modules which form the PLC logic relay system in conjunction with the narrow 6.2 mm PLC-INTERFACE terminal blocks. Eight freely selectable PLC-INTERFACE terminal blocks must be separately ordered for each logic module. You can find an overview of matching PLC-INTERFACE terminal blocks on page 360.

All logic modules feature these properties:

- 8 integrated digital inputs (of which two inputs are configurable as analog inputs), connection via connector with screw or push-in connection technology
- A further 8 channels can be configured with matching PLC-INTERFACE terminal blocks as digital inputs or outputs
- Programming with the LOGIC+ software

#### PLC-V8C.../SAM

- Stand-alone logic module with 16 I/Os, not extendable
- Connection to PC via micro USB socket
- Integrated realtime clock (RTC)
- Accommodates external IFS-CONFSTICK memory block

#### PLC-V8C.../BM

- Basic logic module with 16 I/Os, can be extended with a maximum of two extension modules (PLC-V8C.../EM) to 48 I/Os
- Connection to PC via micro USB socket
- Integrated realtime clock (RTC)
- Accommodates external IFS-CONFSTICK memory block
- Optional connection to PROFIBUS-GATEWAY-IFS

#### PLC-V8C.../EM

- Extension logic module with 16 I/Os, for extending the basic module



Stand-alone module

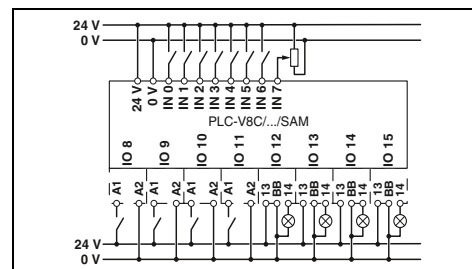

#### Technical data

Supply	
Supply voltage	24 V DC
Supply voltage range	19.2 V DC ... 26.4 V DC
Max. input current at $U_N$	120 mA
Input data (digital)	
Number of inputs	8 (2 configurable as analog)
Input voltage	24 V DC
Description of the input	EN 61131-2, type 3
Input current 0-signal	< 1 mA
Input current 1-signal	Typ. 2.5 mA
Input data (analog)	
Number of inputs	2 (IN6 and IN7 are configurable as analog)
Input voltage range	0 V ... 10 V
Input resistance	> 4 kΩ
Input data (PLC-INTERFACE)	
Number of inputs	≤ 8
Output data (for controlling PLC-INTERFACE)	
Number of outputs	≤ 8
Nominal voltage	24 V DC
Nominal current	9 mA
Realtime clock (basic module only)	
Buffer time (capacitor)	24 h (capacitor)
Realtime clock accuracy	±2 s/d
General data	
Ambient temperature (operation)	-20°C ... 45°C
Ambient temperature (storage/transport)	-20°C ... 70°C
Permissible humidity (operation)	90%
Air and creepage distances between the power circuits	DIN EN 50178
Rated insulation voltage	50 V
Rated surge voltage	0.8 kV
Insulation	Basic insulation
Mounting type	Can be plugged onto 8 x PLC-INTERFACE
Degree of protection	IP20
Screw connection solid/stranded/AWG	0.14 - 1.5 mm <sup>2</sup> /0.14 - 1.5 mm <sup>2</sup> /28 - 16
Push-in connection solid/stranded/AWG	0.14 - 1.5 mm <sup>2</sup> /0.14 - 1.5 mm <sup>2</sup> /26 - 16

#### Ordering data

Description	Type	Order No.	Pcs. / Pkt.
<b>PLC-V8C plug-in logic modules</b>			
With screw connection	PLC-V8C/SC-24DC/SAM	2905082	1
With push-in connection	PLC-V8C/PT-24DC/SAM	2905136	1



Basic module



Extension module

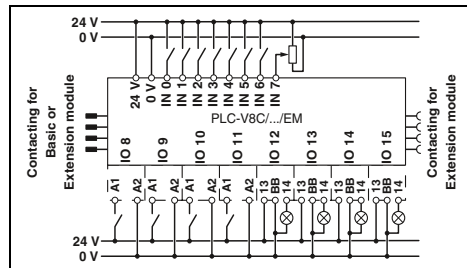
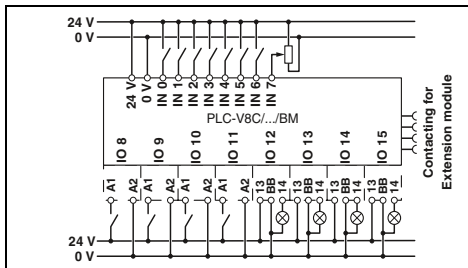

Technical data

24 V DC  
19.2 V DC ... 26.4 V DC  
120 mA

8 (2 configurable as analog)  
24 V DC  
EN 61131-2, type 3  
< 1 mA  
Typ. 2.5 mA

2 (IN6 and IN7 are configurable as analog)

0 V ... 10 V  
> 4 kΩ

≤ 8

≤ 8  
24 V DC  
9 mA

24 h (capacitor)  
±2 s/d

-20°C ... 45°C  
-20°C ... 70°C  
90%  
DIN EN 50178

50 V  
0.8 kV  
Basic insulation  
Can be plugged onto 8 x PLC-INTERFACE  
IP20  
0.14 - 1.5 mm<sup>2</sup>/0.14 - 1.5 mm<sup>2</sup>/28 - 16  
0.14 - 1.5 mm<sup>2</sup>/0.14 - 1.5 mm<sup>2</sup>/26 - 16

Technical data

24 V DC  
19.2 V DC ... 26.4 V DC  
65 mA

8 (2 configurable as analog)  
24 V DC  
EN 61131-2, type 3  
< 1 mA  
Typ. 2.5 mA

2 (IN6 and IN7 are configurable as analog)

0 V ... 10 V  
> 4 kΩ

≤ 8

≤ 8  
24 V DC  
9 mA

-

-20°C ... 45°C  
-20°C ... 70°C  
90%  
DIN EN 50178

50 V  
0.8 kV  
Basic insulation  
Can be plugged onto 8 x PLC-INTERFACE  
IP20  
0.14 - 1.5 mm<sup>2</sup>/0.14 - 1.5 mm<sup>2</sup>/28 - 16  
0.14 - 1.5 mm<sup>2</sup>/0.14 - 1.5 mm<sup>2</sup>/26 - 16

Ordering data

Type	Order No.	Pcs. / Pkt.
PLC-V8C/SC-24DC/BM	2903094	1
PLC-V8C/PT-24DC/BM	2905135	1

Ordering data

Type	Order No.	Pcs. / Pkt.
PLC-V8C/SC-24DC/EM	2903095	1
PLC-V8C/PT-24DC/EM	2905137	1

## Relay modules - PLC logic programmable logic relay system

### Accessories

#### Programming cable and memory block

- The programming cable (MICRO USB B to USB A) is used to connect PLC logic to a PC, length: 2 m
- PLC logic programs are saved by the memory block or can be easily copied to other devices



General data	
EMC note	
Description	Color
Programming cable	
Multi-functional memory block for the INTERFACE system	
- Flat design	

Technical data		
Class A product, see page 443		
Ordering data		
Type	Order No.	Pcs. / Pkt.
CAB-USB A/MICRO USB B/2,0M	2701626	1

Technical data		
Class A product, see page 443		
Ordering data		
Type	Order No.	Pcs. / Pkt.
IFS-CONFSTICK	2986122	1

### Accessories

#### Gateway to PROFIBUS DP

The gateways are connected to the PLC-V8C.../BM PLC logic basic modules via the ME 22,5 TBUS... DIN rail connector and the PLC-V8C/CAB... connecting cable.

The gateways are connected to a PC and configured via the integrated S-PORT interface and the IFS-USB-DATACABLE.

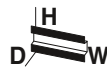

General data	
EMC note	
Description	Color
IFS gateway for PROFIBUS DP	green
Programming adapter for configuring modules with S-PORT interface	
Cable length: 3 m	
DIN rail connector	green
Connecting cable for connecting PLC logic with the ME 22,5 TBUS DIN rail connector, cable length: 0.3 m	

Technical data		
Class A product, see page 443		
Ordering data		
Type	Order No.	Pcs. / Pkt.
EM-PB-GATEWAY-IFS	2297620	1
IFS-USB-DATACABLE	2320500	1
ME 22,5 TBUS 1,5/ 5-ST-3,81 GN	2707437	50

Technical data		
Class A product, see page 443		
Ordering data		
Type	Order No.	Pcs. / Pkt.
PLC-V8C/CAB/TBUS/0,3M	2905263	1



**Accessories**

**PLC logic starter kit**

The PLC logic starter kit contains all the components needed to get started quickly and easily with PLC logic with push-in connection technology and 8 inputs and 8 outputs.

- PLC-V8C-PT/24DC/BM plug-in logic module
- PLC-RPT-24DC/1/ACT eight relay output terminal blocks
- Micro USB programming cable
- Software LOGIC+
- "PLC logic quick start guide" poster



		Ordering data		
Description	Color	Type	Order No.	Pcs. / Pkt.
<b>PLC logic starter kit 1</b> , 8 integrated inputs (24 V DC) and 8 outputs via PLC-INTERFACE (switching capacity 250 V AC/DC, max. 6 A)		<b>PLC-LOGIC-STARTERKIT1</b>	<b>2905504</b>	<b>1</b>

**Dimensional drawing**

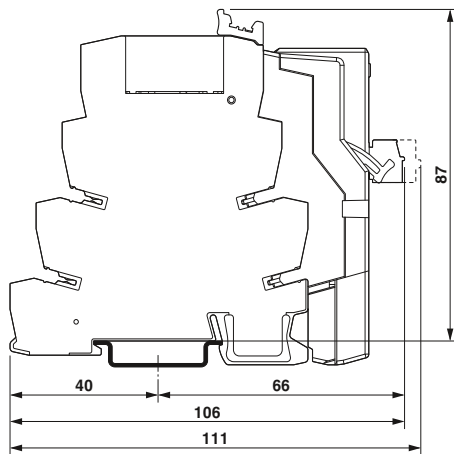

### Selection table for PLC-INTERFACE

Relay output	Push-in connection		Screw connection	
	Type	Order No.	Type	Order No.
1 PDT, output data 6 A, 250 V AC/DC	PLC-RPT-24DC/21	2900299	PLC-RSC-24DC/21	2966171
1 PDT, output data 50 mA, 36 V DC, gold contact	PLC-RPT-24DC/21AU	2900306	PLC-RSC-24DC/21AU	2966265
1 N/O contact, output data 6 A, 250 V AC/DC, actuator type	PLC-RPT-24DC/1/ACT	2900312	PLC-RSC-24DC/1/ACT	2966210
1 N/O contact with switch, output data 6 A, 250 V AC/DC	PLC-RPT-24UC/1/S/H	2900328	PLC-RSC-24UC/1/S/H	2982236
<b>Solid-state relay output</b>				
Output data 100 mA, 3 V DC - 48 V DC	PLC-OPT-24DC/48DC/100	2900352	PLC-OSC-24DC/48DC/100	2966728
Output data 3 A, 3 V DC - 33 V DC	PLC-OPT-24DC/24DC/2	2900364	PLC-OSC-24DC/24DC/2	2966634
Output data 750 mA, 24 V AC - 253 V AC	PLC-OPT-24DC/230AC/1	2900369	PLC-OSC-24DC/230AC/1	2967840
Output data 3 A, 3 V DC - 33 V DC, actuator type	PLC-OPT-24DC/24DC/2/ACT	2900376	PLC-OSC-24DC/24DC/2/ACT	2966676
Output data 750 mA, 24 V AC - 253 V AC, actuator type			PLC-OSC-24DC/230AC/1/ACT	2967947
Output data 1 A, 12 V DC - 300 V DC	PLC-OPT-24DC/300DC/1	2900383	PLC-OSC-24DC/300DC/1	2980678
Output data 10 A, 3 V DC - 33 V DC	PLC-OPT-24DC/24 DC/10/R	2900398	PLC-OSC-24DC/24DC/10/R	2982702
Output data 500 mA, 3 V DC - 48 V DC, electronic PDT	PLC-OPT-24DC/48DC/500/W	2900378	PLC-OSC-24DC/48DC/500/W	2980636
Output data, TTL, 50 mA, 5 V DC	PLC-OPT-24DC/TTL	2900363	PLC-OSC-24DC/TTL	2982728
<b>Relay input</b>				
Input voltage 24 V DC	PLC-RPT-24DC/1AU/SEN	2900313	PLC-RSC-24DC/1AU/SEN	2966317
Input voltage 120 V AC/DC	PLC-RPT-120UC/1AU/SEN	2900314	PLC-RSC-120UC/1AU/SEN	2966320
Input voltage 230 V AC/DC	PLC-RPT-230UC/1AU/SEN	2900315	PLC-RSC-230UC/1AU/SEN	2966333
Input voltage 5 V DC (basic terminal block without relay)			PLC-BSC- 5DC/ 1/SEN	2980267
Relay for 5 V DC basic terminal block			REL-MR-4,5DC/21AU	2961370
<b>Solid-state relay input</b>				
Input voltage 24 V DC	PLC-OPT-24DC/48DC/100/V8C/SEN	2904693	PLC-OSC-24DC/48DC/100/V8C/SEN	2904690
Input voltage 120 V AC/DC	PLC-OPT-120UC/48DC/100/V8C/SEN	2904694	PLC-OSC-120UC/48DC/100/V8C/SEN	2904691
Input voltage 230 V AC/DC	PLC-OPT-230UC/48DC/100/V8C/SEN	2904695	PLC-OSC-230UC/48DC/100/V8C/SEN	2904692
<b>Dummy or reserve</b>				
Basic terminal block output	PLC-BPT-24DC/21	2900445	PLC-BSC-24DC/21	2966016
Basic terminal block input	PLC-BPT-24DC/1/SEN	2900262	PLC-BSC-24DC/1/SEN	2966061

## LOGIC+ programming software



### Integrated web server

PLC logic basic settings are easily configured via the integrated web server. The LOGIC+ software does not need to be installed in order to do so.

- Time and date
- Password and access control
- Firmware update
- Status indicators for inputs and outputs
- General device information



### LOGIC+ user interface

- Clear separation in program editor, toolbox, hardware view, and signaling window
- All elements can be easily placed using drag & drop
- Notes and errors are highlighted in color in the program editor



### Hardware configurator

- Each relay channel can be configured as an input or output with an electromechanical or a solid-state relay
- Clear assignment of the inputs and outputs thanks to the graphical representation of the hardware connections

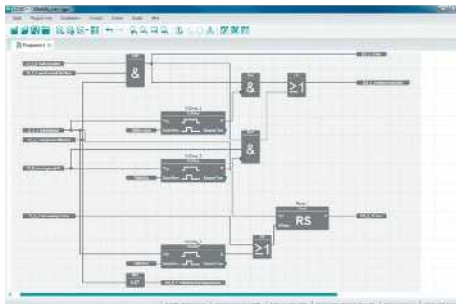

### Function blocks

- Basic functions: AND, OR, NOT, XOR
- Mathematical functions: add, divide, multiply, subtract, generate absolute value
- Positive and negative edge detection
- RS and SR flip-flops
- Switch-on and switch-off delay, pulse encoder, pulse stretching, weekly clock timer
- Up and down counter
- Analog and digital comparators
- Special functions, e.g., solar altitude calculations are available for download

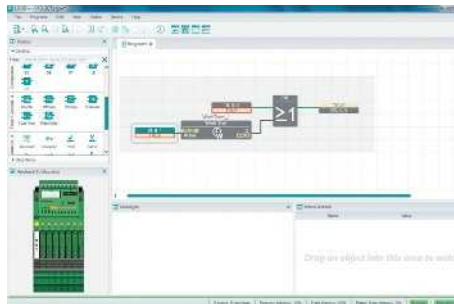

### Simulation and online values

- Offline simulation:
  - Simulation of the created program directly in LOGIC+
  - Virtualization of the values in the program editor, hardware view, and in the observation window
- Online values:
  - Representation of the program running on the hardware in LOGIC+ with online values
  - Overwriting of values from LOGIC+

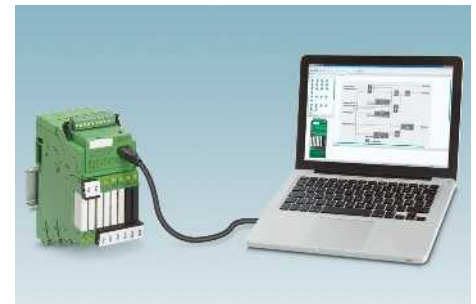

### Example programs

Numerous application examples make it easy to get started with LOGIC+. These include:

- Underground garage ventilation
- Conveyor belt
- Pumping plant
- Two-way control
- Tips for creating shift registers or surge relays

### Fully mounted RIF-0 relay modules

Fully mounted RIF-0 relay modules, consisting of:

- Relay base with push-in connection
- Solid-state relays
- Relay ejector lever on the housing

The advantages:

- Status LED integrated into the base
- RTIII sealed solid-state relay
- Zero voltage switch at AC output
- Professional bridging of adjacent modules saves wiring time

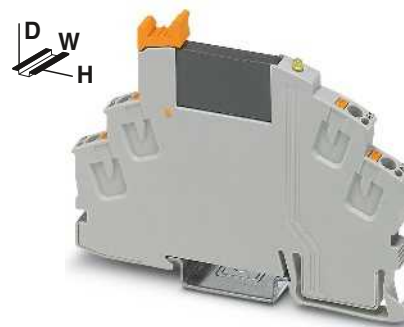

Max. DC voltage output of 3 A

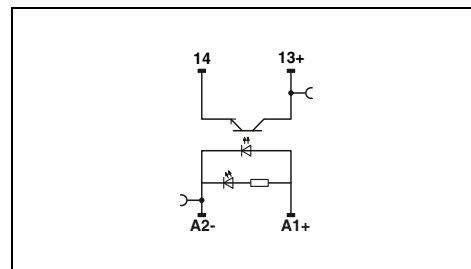

#### Technical data

Input data		①
Rated actuating voltage range with reference to $U_C$		0.8 - 1.2
Switching level (with reference to $U_C$ )	1 signal ("H")	> 0.8
	0 signal ("L")	< 0.4
Rated actuating current $I_C$	[mA]	8.5
Typ. switch-on time at $U_N$	[ms]	0.02
Typ. switch-off time at $U_N$	[ms]	0.3
Transmission frequency $f_{limit}$	[Hz]	300
Input circuit DC		Yellow LED, free-wheeling diode
Output data		
Max. switching voltage		33 V DC
Min. switching voltage		3 V DC
Max. inrush current		15 A (10 ms)
Min./max. switching current		-/3 A (see derating curve)
Output protection		Protection against polarity reversal, surge protection
Voltage drop at max. limiting continuous current		< 200 mV
Leakage current in off state		-
Phase angle (cos $\phi$ )		-
Max. load value		-
General data		
Test voltage input/output		2.5 kV <sub>rms</sub> (50 Hz, 1 min.)
Ambient temperature (operation)		-25°C ... 60°C
Standards/regulations		DIN EN 50178
Pollution degree/surge voltage category		2/III
Connection data solid/stranded/AWG		0.14 - 1.5 mm <sup>2</sup> /0.14 - 1.5 mm <sup>2</sup> /26 - 16
Dimensions	W / H / D	6.2 mm/93 mm/66 mm
EMC note		Class A product, see page 443

#### Ordering data

Description	Rated actuating voltage $U_C$	Type	Order No.	Pcs. / Pkt.
<b>Coupling relay modules</b> with solid-state relay and push-in connection	① 24 V DC	<b>RIF-0-OPT-24DC/24DC/2</b>	<b>2905293</b>	10

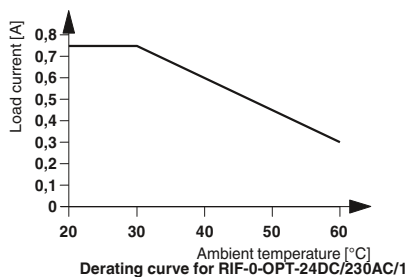
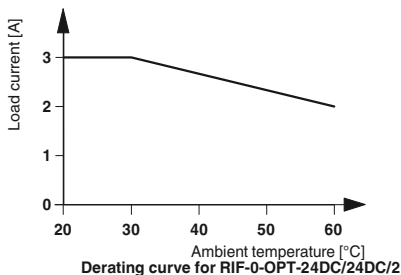

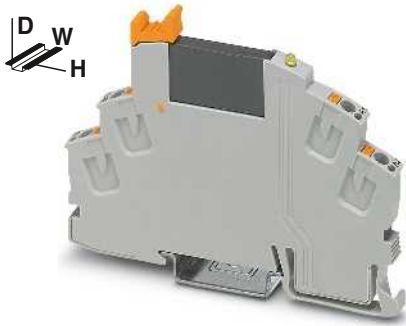

Max. DC voltage output of 100 mA



Max. AC voltage output of 750 mA

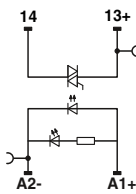
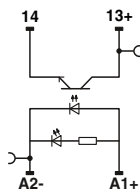

Technical data

①  
 0.8 -  
 1.2  
 > 0.8  
 < 0.4  
 8.5  
 0.02  
 0.3  
 300  
 Yellow LED, free-wheeling diode

48 V DC  
 3 V DC  
 -  
 -/100 mA  
 Protection against polarity reversal, surge protection  
 < 1 V  
 -  
 -  
 -

2.5 kV<sub>rms</sub> (50 Hz, 1 min.)  
 -25°C ... 60°C  
 DIN EN 50178  
 2/III  
 0.14 - 1.5 mm<sup>2</sup>/0.14 - 1.5 mm<sup>2</sup>/26 - 16  
 6.2 mm/93 mm/66 mm  
 Class A product, see page 443

Technical data

①  
 0.8 -  
 1.2  
 > 0.8  
 < 0.4  
 8  
 10  
 10  
 10  
 10  
 Yellow LED, free-wheeling diode

253 V AC  
 24 V AC  
 30 A (10 ms)  
 10 mA/0.75 A (see derating curve)  
 RCV circuit  
 < 1 V  
 1 mA (in off state)  
 0.5  
 4.5 A<sup>2</sup>s (tp = 10 ms, at 25°C)

2.5 kV<sub>rms</sub> (50 Hz, 1 min.)  
 -25°C ... 60°C  
 DIN EN 50178  
 2/III  
 0.14 - 1.5 mm<sup>2</sup>/0.14 - 1.5 mm<sup>2</sup>/26 - 16  
 6.2 mm/93 mm/66 mm  
 Class A product, see page 443

Ordering data

Type	Order No.	Pcs. / Pkt.
RIF-0-OPT-24DC/48DC/100	2905294	10

Ordering data

Type	Order No.	Pcs. / Pkt.
RIF-0-OPT-24DC/230AC/1	2905295	10

## Relay modules - RIFLINE complete

### Fully mounted RIF-1 relay modules

Fully mounted RIF-1 relay modules, consisting of:

- Relay base with push-in connection
- 1 or 2 PDT relays with detectable manual operation
- Relay retaining bracket
- Input module/interference suppr. module (AC types only)

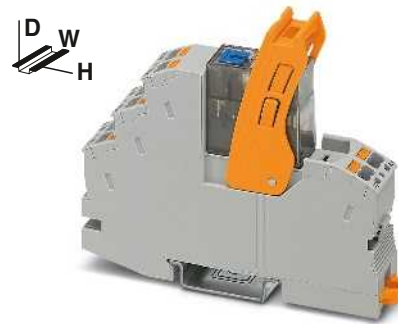

RIF-1 relay module with 1 PDT relay

The advantages:

- Relay with lockable manual operation and status LED
- With DC types, free-wheeling diode is integrated into relay
- Mechanical switch position indicator
- Professional bridging of adjacent modules saves wiring time

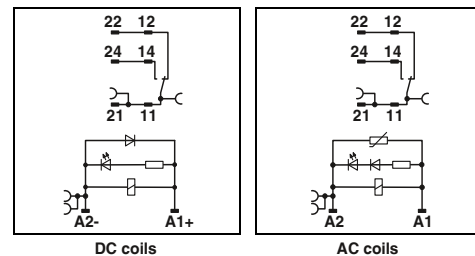

DC coils

AC coils

#### Technical data

Input data	①	②
Permissible range (with reference to $U_N$ )	see diagram	
Typ. input current at $U_N$	[mA]	18 4.5
Typ. response time at $U_N$	[ms]	9 4 - 12
Typ. release time at $U_N$	[ms]	10 4 - 20
Input circuit AC	Yellow LED, varistor	
Input circuit DC	Yellow LED, damping diode	
Output data		
Contact type	1 PDT	
Contact material	AgNi	
Max. switching voltage	250 V AC/DC	
Min. switching voltage	12 V (at 10 mA)	
Limiting continuous current	(see diagram)	
Max. inrush current	32 A (20 ms, N/O contact)	
Min. switching current	10 mA (at 12 V)	
General data		
Test voltage (winding / contact)	4 kV <sub>rms</sub> (50 Hz, 1 min.)	
Ambient temperature (operation), AC	-40°C ... 50°C	
Ambient temperature (operation), DC	-40°C ... 70°C	
Nominal operating mode	100% operating factor	
Mechanical service life	Approx. 5 x 10 <sup>6</sup> cycles	
Standards/regulations	DIN EN 50178, IEC 62103	
Pollution degree/surge voltage category	2/III	
Mounting position/mounting	Any/in rows with zero spacing	
Connection data solid/stranded/AWG	0.14 - 1.5 mm <sup>2</sup> /0.14 - 1.5 mm <sup>2</sup> /26 - 16	
Dimensions	W / H / D 16 mm/93 mm/75 mm	
EMC note	Class A product, see page 443	

#### Ordering data

Description	Input voltage $U_N$	Type	Order No.	Pcs. / Pkt.
<b>Coupling relay modules</b> with power contact relay with manual operation and push-in connection	① 24 V DC	RIF-1-RPT-LDP-24DC/1X21MS	2905289	10
	② 230 V AC	RIF-1-RPT-LV-230AC/1X21MS	2905290	10



RIF-1 relay module with 2 PDT relay

### RIF-1-RPT.../1X21... (1 PDT)

Operating voltage range

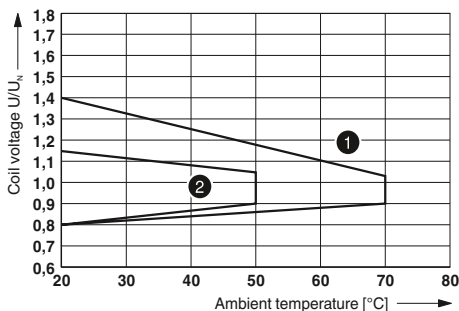

- ① DC coils
- ② AC coils

Interrupting rating

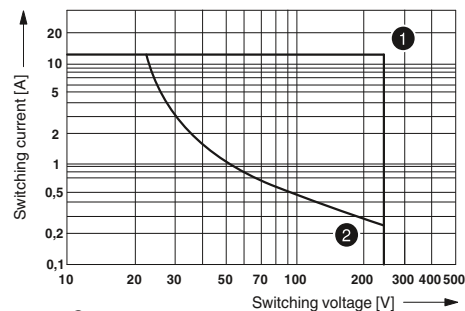

- ① = AC, ohmic load
- ② = DC, ohmic load

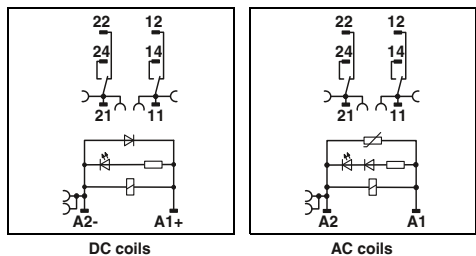

Contact derating

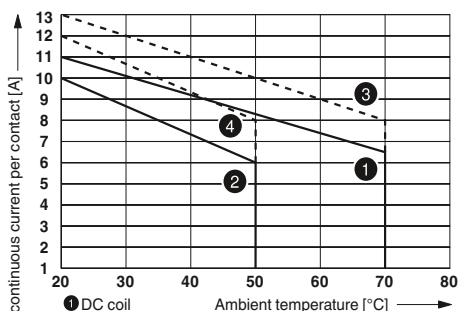

- ① DC coil
- ② AC coil
- ③ DC coil, jumper between 11 and 21
- ④ AC coil, jumper between 11 and 21

Electrical service life

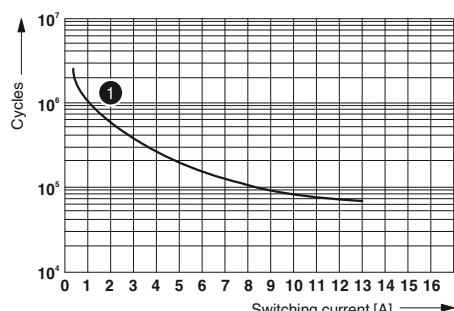

- ① = 250 V AC, ohmic load

#### Technical data

① ②  
 see diagram  
 18 4.5  
 9 4 - 12  
 10 4 - 20  
 Yellow LED, varistor  
 Yellow LED, damping diode

2 PDT  
 AgNi  
 250 V AC/DC  
 12 V (at 10 mA)  
 (see diagram)  
 16 A (20 ms, N/O contact)  
 10 mA (at 12 V)

4 kV<sub>ms</sub> (50 Hz, 1 min.)  
 -40°C ... 50°C  
 -40°C ... 70°C  
 100% operating factor  
 Approx. 5 x 10<sup>6</sup> cycles  
 DIN EN 50178, IEC 62103  
 2/III  
 Any/in rows with zero spacing  
 0.14 - 1.5 mm<sup>2</sup>/0.14 - 1.5 mm<sup>2</sup>/26 - 16  
 16 mm/93 mm/75 mm  
 Class A product, see page 443

#### Ordering data

Type	Order No.	Pcs. / Pkt.
RIF-1-RPT-LDP-24DC/2X21MS	2905291	10
RIF-1-RPT-LV-230AC/2X21MS	2905292	10

### RIF-1-RPT.../2X21... (2 PDTs)

Operating voltage range

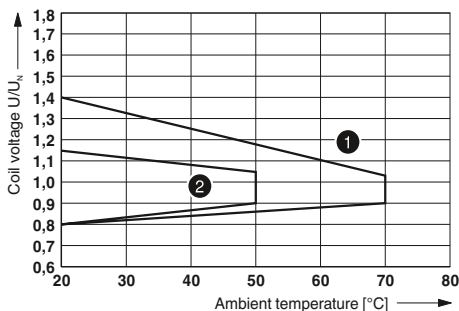

- ① DC coils
- ② AC coils

Interrupting rating

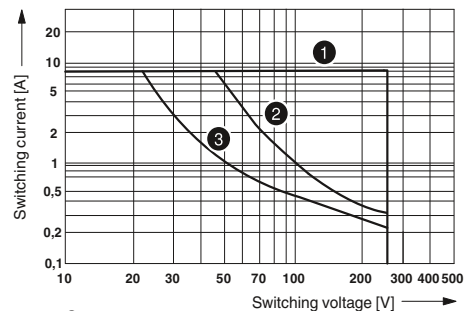

- ① AC, ohmic load
- ② DC, ohmic load, contacts in series
- ③ DC, ohmic load

Contact derating

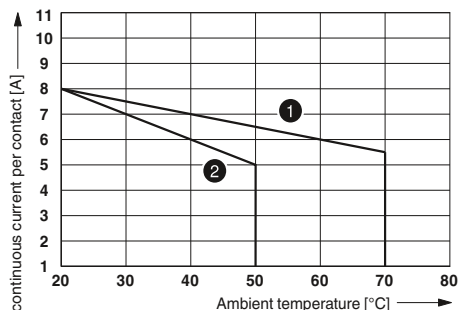

- ① DC coil
- ② AC coil

Electrical service life

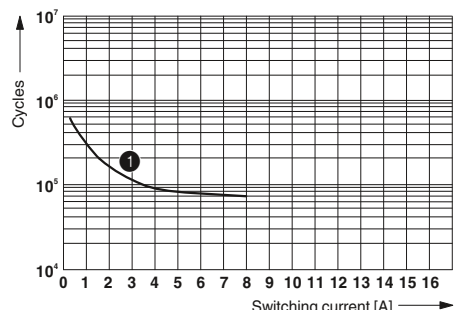

- ① 250 V AC, ohmic load

## Relay modules - PLC series

### PLC RELAY with an integrated solid-state relay

6.2 mm narrow solid-state relay for switching AC loads

- Status display
- Protection circuits in input and output
- Wear-free
- Switching capacity up to 230 V AC/2.4 A
- Screw and push-in connection technology



Solid-state power relay with AC voltage output of 2.4 A, max.

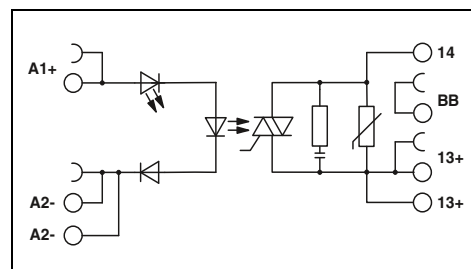

#### Technical data

Input data		①
Rated actuating voltage range with reference to $U_C$		0.8 - 1.2
Switching level (with reference to $U_C$ )	1 signal ("H")	> 0.8
	0 signal ("L")	< 0.4
Rated actuating current $I_C$	[mA]	8
Typ. switch-on time at $U_N$	[ms]	10
Typ. switch-off time at $U_N$	[ms]	10
Transmission frequency $f_{limit}$	[Hz]	10
Input circuit DC		Yellow LED, protection against polarity reversal, surge protection
Output data		
Max. switching voltage		253 V AC
Min. switching voltage		24 V AC
Max. inrush current		250 A (20 ms)
Min./max. switching current		10 mA/2.4 A (see derating)
Output protection		RCV circuit
Voltage drop at max. limiting continuous current		< 1 V
Leakage current in off state		< 1 mA
Phase angle (cos $\phi$ )		-
Max. load value		340 A <sup>2</sup> s (tp = 10 ms, at 25°C)
General data		
Rated insulation voltage		260 V AC
Rated surge voltage		4 kV
Insulation		Basic insulation
Ambient temperature (operation)		-25°C ... 60°C
Standards/regulations		DIN EN 50178
Pollution degree/surge voltage category		2/III
Connection data solid/stranded/AWG		0.14 - 2.5 mm <sup>2</sup> /0.14 - 2.5 mm <sup>2</sup> /26 - 14
Dimensions	W / H / D	6.2 mm/80 mm/86 mm
EMC note		Class A product, see page 443

#### Ordering data

Description	Rated actuating voltage $U_C$	Type	Order No.	Pcs. / Pkt.
PLC INTERFACE, with screw connection	① 24 V DC	PLC-OSC- 24DC/230AC/2.4/ACT	2904631	10
PLC-INTERFACE, with push-in connection	① 24 V DC	PLC-OPT- 24DC/230AC/2.4/ACT	2904632	10

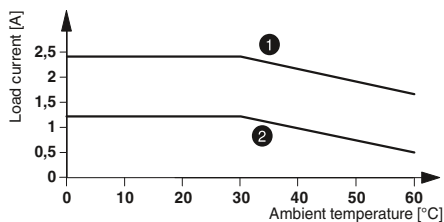

① = aligned with > 20 mm spacing  
② = aligned without spacing

Load current as a function of the ambient temperature  
Operating time: 100% operating factor





## System cabling for controllers - VARIOFACE system cabling

### VIP - power cabling

#### Universal front adapters for SIMATIC® S7-300

##### Four connection options are available:

- Connection of 40-pos. modules via four cables, each with a 10-pos. COMBI connector
- Connection of 20-pos. modules via two cables, each with a 10-pos. COMBI connector
- Connection of 40-pos. modules via 40 individual wires in rope structure (not assembled)
- Connection of 20-pos. modules via 20 individual wires in rope structure (not assembled)

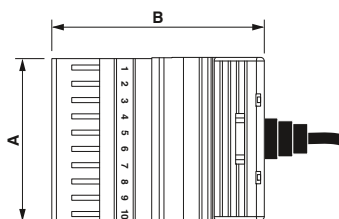

	A	B
...4X10COMBI...	52	70
...2X10COMBI...		
...4X10 PT...	35	62
...2X10 PT...		



Front adapter with punched-on connectors for 40 plug-in modular terminal blocks

##### The front adapters have the following features:

- Can be screwed on/snapped in with the I/O module
- Suitable for all common S7-300 modules, up to max. 250 V AC/DC, 6 A
- Universal 1:1 connection
- Numerically marked wires/connectors

##### Combination example:

A front adapter with punched-on 10-pos. COMBI connectors can be combined with the following modular terminal blocks for field connection:

- 3045017 UT 2,5/1P
- 3210033 PT 2,5/1P
- 3040012 ST 2,5/1P
- 3040766 ST 2,5-TWIN-MT/1P

You can find further versions, accessories, and combination options in Catalog 3 “Modular terminal blocks” in the “Plug-in COMBI connection solutions” section, or online at [phoenixcontact.net/products](http://phoenixcontact.net/products).

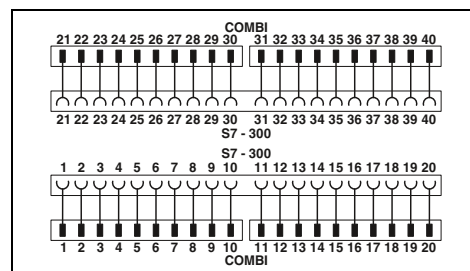

##### Technical data

Max. perm. operating voltage	≤ 250 V AC/DC
Max. perm. current carrying capacity per path	6 A (per single wire at 40°C) 4 A (per single wire at 60°C)
Max. perm. total current	20 A (per cable at 40°C) 16 A (per cable at 60°C)
Rated surge voltage	4 kV
Insulation	Basic insulation
Max. conductor resistance	39 Ω/km
Conductor cross section	AWG 21/0,5 mm <sup>2</sup>
Conductor structure: stranded wires / material	16/Cu uninsulated
Outside diameter	9 mm
Ambient temperature range	-20°C ... 60°C
Standards/regulations	DIN EN 50178,
Connection method	Can be plugged onto 40-pin I/O modules

COMBI	21 22 23 24 25 26 27 28 29 30 31 32 33 34 35 36 37 38 39 40
S7 - 300	21 22 23 24 25 26 27 28 29 30 31 32 33 34 35 36 37 38 39 40
S7 - 300	1 2 3 4 5 6 7 8 9 10 11 12 13 14 15 16 17 18 19 20
COMBI	1 2 3 4 5 6 7 8 9 10 11 12 13 14 15 16 17 18 19 20

##### Ordering data

Description	Cable length	Type	Order No.	Pcs. / Pkt.
VIP - power adapter, for universal connection of the SIMATIC S7-300	0.5 m	VIP-PA-PWR/4X10COMBI/ 0,5M/S7	2904702	1
	1 m	VIP-PA-PWR/4X10COMBI/ 1,0M/S7	2904703	1
	1.5 m	VIP-PA-PWR/4X10COMBI/ 1,5M/S7	2904704	1
	2 m	VIP-PA-PWR/4X10COMBI/ 2,0M/S7	2904705	1
	2.5 m	VIP-PA-PWR/4X10COMBI/ 2,5M/S7	2904706	1
	3 m	VIP-PA-PWR/4X10COMBI/ 3,0M/S7	2904707	1
	4 m	VIP-PA-PWR/4X10COMBI/ 4,0M/S7	2904708	1
	5 m	VIP-PA-PWR/4X10COMBI/ 5,0M/S7	2904709	1
	6 m	VIP-PA-PWR/4X10COMBI/ 6,0M/S7	2904710	1
	8 m	VIP-PA-PWR/4X10COMBI/ 8,0M/S7	2904711	1
	10 m	VIP-PA-PWR/4X10COMBI/10,0M/S7	2904712	1



Front adapter with punched-on connectors for 20 plug-in modular terminal blocks



Front adapter with 40 open cable ends



Front adapter with 20 open cable ends

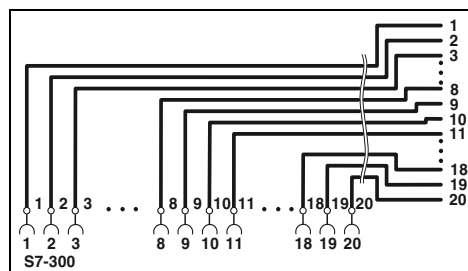
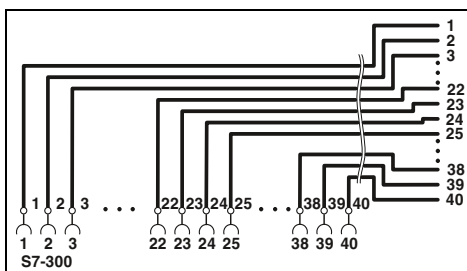
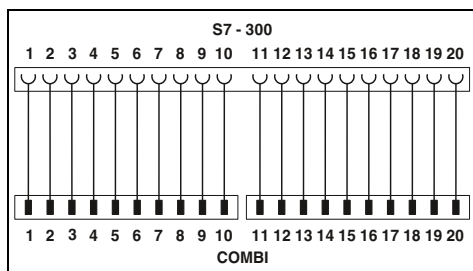

Technical data

≤ 250 V AC/DC  
 6 A (per single wire at 40°C)  
 4 A (per single wire at 60°C)  
 20 A (per cable at 40°C)  
 16 A (per cable at 60°C)  
 4 kV  
 Basic insulation  
 39 Ω/km  
 AWG 21/0.5 mm<sup>2</sup>  
 16/Cu uninsulated  
 9 mm  
 -20°C ... 60°C  
 DIN EN 50178,  
 Can be plugged onto 20-pin I/O modules  
 COMBICON connectors SP-H 2,5/10

Technical data

≤ 250 V AC/DC  
 6 A (per single wire at 40°C)  
 4 A (per single wire at 60°C)  
 20 A (per cable at 40°C)  
 16 A (per cable at 60°C)  
 2.3 kV  
 Basic insulation  
 39 Ω/km  
 AWG 21/0.5 mm<sup>2</sup>  
 16/Cu uninsulated  
 13 mm  
 -20°C ... 60°C  
 DIN EN 50178,  
 Can be plugged onto 40-pin I/O modules  
 Open cable end

Technical data

≤ 250 V AC/DC  
 6 A (per single wire at 40°C)  
 4 A (per single wire at 60°C)  
 20 A (per cable at 40°C)  
 16 A (per cable at 60°C)  
 2.3 kV  
 Basic insulation  
 39 Ω/km  
 AWG 21/0.5 mm<sup>2</sup>  
 16/Cu uninsulated  
 9 mm  
 -20°C ... 60°C  
 DIN EN 50178,  
 Can be plugged onto 20-pin I/O modules  
 Open cable end

Ordering data

Type	Order No.	Pcs. / Pkt.
VIP-PA-PWR/2X10COMBI/ 0,5M/S7	2904713	1
VIP-PA-PWR/2X10COMBI/ 1,0M/S7	2904714	1
VIP-PA-PWR/2X10COMBI/ 1,5M/S7	2904715	1
VIP-PA-PWR/2X10COMBI/ 2,0M/S7	2904716	1
VIP-PA-PWR/2X10COMBI/ 2,5M/S7	2904717	1
VIP-PA-PWR/2X10COMBI/ 3,0M/S7	2904718	1
VIP-PA-PWR/2X10COMBI/ 4,0M/S7	2904719	1
VIP-PA-PWR/2X10COMBI/ 5,0M/S7	2904720	1
VIP-PA-PWR/2X10COMBI/ 6,0M/S7	2904721	1
VIP-PA-PWR/2X10COMBI/ 8,0M/S7	2904722	1
VIP-PA-PWR/2X10COMBI/10,0M/S7	2904723	1

Ordering data

Type	Order No.	Pcs. / Pkt.
VIP-PA-PWR/40XOE/ 1,0M/S7	2904731	1
VIP-PA-PWR/40XOE/ 2,0M/S7	2904732	1
VIP-PA-PWR/40XOE/ 3,0M/S7	2904733	1
VIP-PA-PWR/40XOE/ 4,0M/S7	2904734	1
VIP-PA-PWR/40XOE/ 6,0M/S7	2904735	1
VIP-PA-PWR/40XOE/ 8,0M/S7	2904736	1
VIP-PA-PWR/40XOE/10,0M/S7	2904737	1

Ordering data

Type	Order No.	Pcs. / Pkt.
VIP-PA-PWR/20XOE/ 1,0M/S7	2904724	1
VIP-PA-PWR/20XOE/ 2,0M/S7	2904725	1
VIP-PA-PWR/20XOE/ 3,0M/S7	2904726	1
VIP-PA-PWR/20XOE/ 4,0M/S7	2904727	1
VIP-PA-PWR/20XOE/ 6,0M/S7	2904728	1
VIP-PA-PWR/20XOE/ 8,0M/S7	2904729	1
VIP-PA-PWR/20XOE/10,0M/S7	2904730	1

### VIP output module

These VIP VARIOFACE output modules are used in combination with the respective front adapters. Like the front adapters, the modules are connected via 14-pos. system cables.

**Features:**

- Plug-in miniature relays, each with a PDT contact
- LED status display for each signal path and supply voltage
- Free-wheeling diode for each signal path
- Push-in connection



**Output module with 8 miniature relays, 1 PDT and fuse per output circuit**

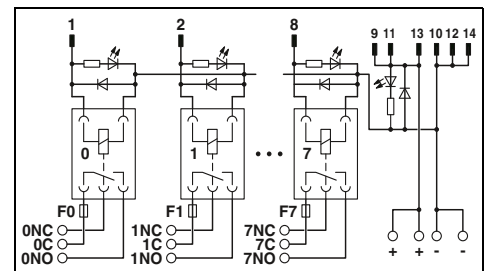

#### Technical data

<b>Coil side</b>		
Operating voltage $U_N$		24 V DC
Typ. input current at $U_N$		9 mA
Typ. response time at $U_N$		5 ms
Typ. release time at $U_N$		8 ms
Input circuit		Free-wheeling diode
Status display/channel		Yellow LED
Connection method		IDC/FLK pin strip (2.54 mm)
No. of pos.		14
<b>Contact side</b>		
Contact type		Single contact, 1-PDT
Contact material		AgSnO
Max. switching voltage		250 V AC/DC
Min. switching voltage		12 V AC/DC
Limiting continuous current		5 A (observe derating)
Min. switching current		10 mA
Max. interrupting rating:		24 V DC 140 W
		48 V DC 20 W
		60 V DC 18 W
		110 V DC 23 W
		220 V DC 40 W
		250 V AC 1500 VA
Connection method		Push-in connection
Connection data solid/stranded/AWG		0.14 ... 2.5 mm <sup>2</sup> /0.14 ... 2.5 mm <sup>2</sup> /26 - 14
<b>General data</b>		
Ambient temperature (operation)		-20°C ... 60°C
Nominal operating mode		100% operating factor
Mechanical service life		2 x 10 <sup>7</sup> cycles
Standards/regulations		DIN EN 50178
Mounting position		Any
Mounting		In rows with zero spacing
Dimensions	H / D	109.8 mm/63 mm
EMC note		Class A product, see page 443

#### Ordering data

Description	Module width W	Type	Order No.	Pcs. / Pkt.
VARIOFACE output module, with eight miniature relays, plugged, for 24 V DC (incl. relays)	87.6	VIP-8RPT-24DC/21/D0/FU/PLC	2903601	1

VIP input module

These VIP VARIOFACE input modules are used in combination with the respective front adapters. Like the front adapters, the modules are connected via 14-pos. system cables.

Features:

- Plug-in miniature relays, each with an N/O contact
- LED status display for each signal path and supply voltage
- Free-wheeling diode for each signal path
- Push-in connection



Digital input module with 8 channels for 24 V DC



Digital input module with 8 channels for 120 V AC

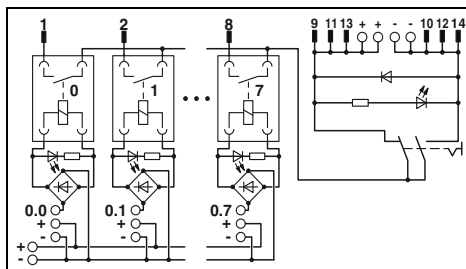

Technical data

Coil side	
Operating voltage $U_N$	24 V DC $\pm 10\%$ (Supply, 2 A)
Typ. input current at $U_N$	9 mA (per channel)
Typ. response time at $U_N$	5 ms
Typ. release time at $U_N$	8 ms
Input circuit	Free-wheeling diode
Status display/channel	Yellow LED
Connection method	Push-in connection
Connection data solid/stranded/AWG	0.14 ... 2.5 mm <sup>2</sup> /0.14 ... 2.5 mm <sup>2</sup> /26 - 14
Contact side	
Contact type	1 N/O contact
Contact material	AgSnO, hard gold-plated
Limiting continuous current	50 mA
Connection method	IDC/FLK pin strip (2.54 mm)
No. of pos.	14
General data	
Ambient temperature (operation)	-20°C ... 60°C
Nominal operating mode	100% operating factor
Mechanical service life	2 x 10 <sup>7</sup> cycles
Standards/regulations	DIN EN 50178
Mounting position	Any
Mounting	In rows with zero spacing
Dimensions	109.8 mm/63 mm
EMC note	Class A product, see page 443

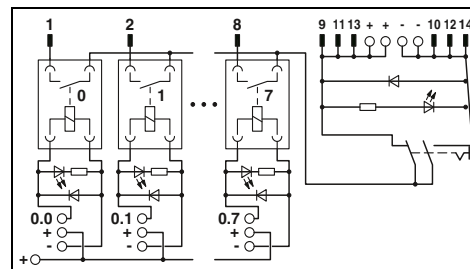

Technical data

Coil side	
Operating voltage $U_N$	120 V AC $\pm 10\%$ (Supply, 2 A)
Typ. input current at $U_N$	3.5 mA (per channel)
Typ. response time at $U_N$	6 ms
Typ. release time at $U_N$	15 ms
Input circuit	Free-wheeling diode
Status display/channel	Yellow LED
Connection method	Push-in connection
Connection data solid/stranded/AWG	0.14 ... 2.5 mm <sup>2</sup> /0.14 ... 2.5 mm <sup>2</sup> /26 - 26
Contact side	
Contact type	1 N/O contact
Contact material	AgSnO, hard gold-plated
Limiting continuous current	50 mA
Connection method	IDC/FLK pin strip (2.54 mm)
No. of pos.	14
General data	
Ambient temperature (operation)	-20°C ... 60°C
Nominal operating mode	100% operating factor
Mechanical service life	2 x 10 <sup>7</sup> cycles
Standards/regulations	DIN EN 50178
Mounting position	Any
Mounting	In rows with zero spacing
Dimensions	109.8 mm/63 mm
EMC note	Class A product, see page 443

Ordering data

Description	Module width W
<b>VARIOFACE interface module</b> , for eight channels, 24 V DC (incl. relays)	92.7
120 V AC (incl. relays)	92.7

Type	Order No.	Pcs. / Pkt.
<b>VIP-8RPT-24DC/1AU/DI/PLC</b>	<b>2903600</b>	1

Ordering data

Type	Order No.	Pcs. / Pkt.
<b>VIP-8RPT-120AC/1AU/DI/PLC</b>	<b>2904576</b>	1

### Emerson DeltaV VIP controller board with fuses for 8 channels

System-specific interface module for use in combination with the respective system cables. The controller board is connected to 8-channel modules through 16-position "mass termination blocks" with flat ribbon cable connection.

Features:

- Fuse per channel
- Separate equipotential terminals per channel
- Knife disconnection for each channel
- Push-in connection

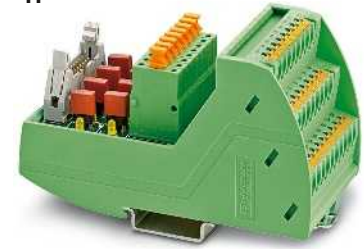

**Interface module with fuses  
for 16-pos. mass termination block**

#### Technical data

Max. perm. operating voltage	24 V DC
Max. perm. current (per branch)	63 mA (in as supplied state, with one 63 mA fuse)
Ambient temperature (operation)	-20°C ... 60°C
Mounting position	Any
Standards/regulations	DIN EN 50178,
Connection method	Field level Controller level Push-in connection
Connection data solid/stranded/AWG	IDC/FLK pin strip (2.54 mm) 0.14 ... 2.5 mm <sup>2</sup> /0.14 ... 2.5 mm <sup>2</sup> /26 - 14
Dimensions	H / D 109.8 mm/63 mm

#### Ordering data

Description	No. of pos.	Module width W	Type	Order No.	Pcs. / Pkt.
<b>Interface module</b> for 16-pos. mass termination block	16	57.1 mm	<b>VIP-PT/FLK16/DS/FU/LED/AN/DV</b>	<b>2903599</b>	<b>1</b>

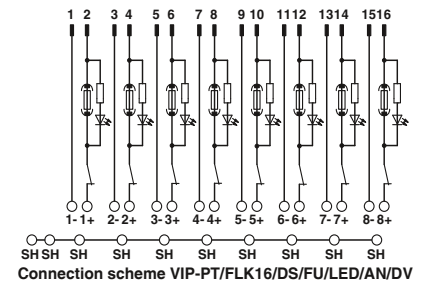

VIP potential distributor with fuses

The VIP-2/PT/PDM-2/16/FU 6.3A module has the following features:

- Two potential levels
- P1 potential has 6.3 A fusing
- Separate supply
- Consecutive labeling
- Push-in connection



Push-in connection and 2 potential levels

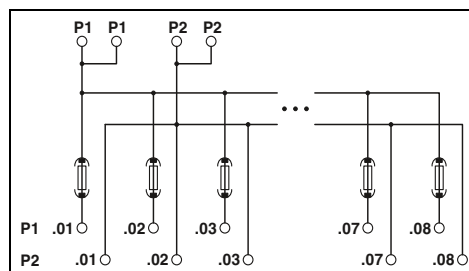

Operating voltage  
 Max. perm. current (per branch)  
 Total current  
 Ambient temperature (operation)  
 Mounting position  
 Standards/regulations  
 Supply connection data solid/stranded/AWG  
 Distribution connection data solid/stranded/AWG  
 Dimensions

250 V AC/DC  
 6.3 A (fuse limited)  
 30 A (per potential)  
 -20°C ... 60°C  
 Any  
 IEC 60664, DIN EN 50178, IEC 62103  
 0.2 - 10 mm<sup>2</sup>/0.2 - 6 mm<sup>2</sup>/24 - 8  
 0.14 - 2.5 mm<sup>2</sup>/0.14 - 2.5 mm<sup>2</sup>/26 - 14  
 109.8 mm/51 mm

Technical data

Ordering data

Description	No. of pos.	Module width W
<b>VARIOFACE module</b> with 2 busbars for potential distribution		
- 2 power terminal blocks/8 distributor blocks		97.70

Type	Order No.	Pcs. / Pkt.
VIP-2/PT/PDM-2/16/FU 6.3A	2903603	1



Industrial Ethernet  
**Power over Ethernet switch** Page 376  
**Lean Managed Switch** Page 378  
**Smart Managed Switches** Page 379  
**Advanced Managed Switches** Page 380



Industrial Ethernet  
**Redundancy modules acc. to IEC 61850/IEEE 1613** Page 382  
**Managed Switches acc. to IEC 61850/IEEE 1613** Page 383  
**Media module** Page 386



Industrial Ethernet  
**WLAN access point** Page 387



Industrial communication technology  
**Media converters for Ethernet applications in realtime** Page 388  
**COM server for extreme fields of application** Page 390  
**Patch panel** Page 392



Industrial communication technology  
**Remote signaling and remote control system** Page 394



Industrial communication technology  
**Fast connection plugs** Page 396

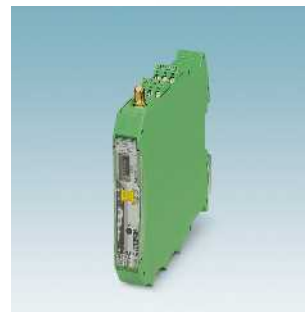

Industrial communication technology  
**Wireless system for license-free use in Europe** Page 398  
 Process infrastructure  
**Device couplers for field devices** Page 399



Functional Safety  
**Multifunctional safety relays** Page 400  
 Configurable safety modules  
**Safe relay extension module** Page 402



Functional Safety  
**Safe I/O modules** Page 404

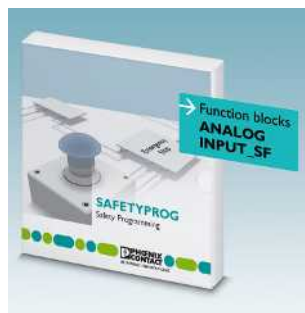

Functional Safety  
**Safe analog value processing** Page 406



I/O systems — Axioline F  
**Bus coupler** Page 408  
**Digital and analog input and output modules** Page 410  
**Temperature recording modules** Page 414



I/O systems — Inline  
**M-bus master terminal** Page 416





HMIs and industrial PCs  
HMIs for maritime applications Page 418



HMIs and industrial PCs  
Box PCs Page 420  
Panel PCs Page 422  
Outdoor panel PCs Page 424  
IP65 panel PCs Page 426



Software  
Visualization app Page 428  
Multiplexer function for retrofitting Page 429



Controllers  
Standard logic modules Page 430  
Programmable logic relay system Page 354

Industrial Ethernet switches

Power over Ethernet switch

Gigabit switch

The FL SWITCH 1708 M12 POE offers a unique combination of a high degree of protection, gigabit transmission, and Power over Ethernet.

The IP67 switches can be installed in a distributed manner and enable connection of Power over Ethernet devices with gigabit transmission.

Features:

- Connection via gigabit M12 plug CAT6A
- Flexible use of PoE devices thanks to powerful 30 W PoE ports (IEEE 802.3at)
- -40°C ... +70°C ambient temperature
- Gigabit support
- Jumbo frames with up to 9720 bytes
- Rugged metal housing
- IP67 protection
- Easy panel mounting

Ethernet



8 ports (M12 socket), for wall mounting

<b>Ethernet interface</b>	
Number of ports	8 (M12 socket)
Transmission speed	10/100/1000 Mbps
Connection method	M12 connector, 8-pos.
<b>Function</b>	
Basic functions	
Status and diagnostic indicators	
<b>Network expansion parameters</b>	
Cascading depth	Network, linear, and star structure: any
Maximum conductor length (twisted pair)	100 m
<b>Power supply</b>	
Supply voltage	24 V DC (M12 connector)
Residual ripple	3.6 V <sub>PP</sub>
Supply voltage range	18 V DC ... 32 V DC
Typical current consumption	300 mA (at U <sub>S</sub> = 24 V DC)
<b>General data</b>	
Weight	2300 g
Width	176 mm
Height	112 mm
Depth	100 mm
Degree of protection	IP65/IP66/IP67
Ambient temperature (operation)	-40°C ... 70°C (non-condensing)
Permissible humidity (operation)	10% ... 95%
Noise emission	EN 61000-6-4
Noise immunity	EN 61000-6-2:2005

**Technical data**

<b>Technical data</b>	
Store-and-forward switch, 10/100/1000 Mbps, auto negotiation, complies with standard IEEE 802.3, 4 priority classes according to IEEE 802.1p, PoE according to IEEE 802.3at/802.3af, jumbo frames up to 9720 bytes	
3 status LEDs per Ethernet port: LINK, Activity, and PoE status. Supply voltage U <sub>S1</sub> and U <sub>S2</sub> (redundant supply voltage) as well as FAIL, PoE Power Status.	

Description	<b>Gigabit Power-over-Ethernet switch</b>
-------------	---

**Ordering data**

Type	Order No.	Pcs. / Pkt.
FL SWITCH 1708 M12 POE	2701883	1



Industrial Ethernet switches

Managed switches

Lean Managed Switch

Maximum possible diagnostics in the minimum amount of space. The compact Ethernet switch is optimized for PROFINET applications in standard machine production.

The switch supports the functions required by PROFINET Class A, such as PTCP filter and Quality of Service. In addition, the Lean Managed Switch features important management functions such as a broadcast limiter, port mirroring, as well as the non-proprietary redundancy protocol RSTP.

Features:

- Compact housing
- PROFINET support
- RSTP
- PTCP filter
- Web-based management, SNMP
- Configuration can be stored externally
- Configurable alarm contact

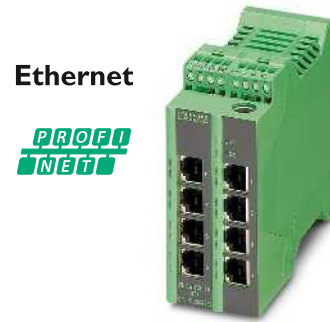

8 RJ45 ports

Technical data			
<b>Ethernet interface</b>			
Number of ports	8 (RJ45 ports)		
Transmission speed	10/100 Mbps		
Connection method	RJ45		
<b>Other connections</b>			
Serial (RS-232)	RS-232-C, 6-pos. MINI-DIN socket (PS/2)		
<b>Function</b>			
Basic functions	Store-and-forward switch complies with IEEE 802.3 2, priority classes according to IEEE 802.1 P, TCP/IP protocol, BootP-compatible, port mirroring, integrated web server function, multicast filtering, IGMP snooping, VLAN, Rapid Spanning Tree (RSTP), DHCP server, PTCP filter		
Supported browsers	Internet Explorer 5.5 or higher		
SNMP – Simple Network Management Protocol	Supported SNMP-MIBs: Enterprise, MIB II, Bridge		
Redundancy	Rapid Spanning Tree 802.1w, Fast Ring Detection		
Status and diagnostic indicators	2 status LEDs per Ethernet port: Link and Status Activity, 100 Mbps, full duplex, supply voltage $U_{S1}$ and $U_{S2}$ (redundant supply voltage)		
<b>Network expansion parameters</b>			
Cascading depth	Network, linear, and star structure: any		
Maximum conductor length (twisted pair)	100 m		
<b>Power supply</b>			
Supply voltage	24 V DC		
Residual ripple	3.6 V <sub>PP</sub>		
Supply voltage range	18.5 V DC ... 30.5 V DC		
Typical current consumption	250 mA (at $U_S = 24$ V DC)		
<b>General data</b>			
Weight	230 g		
Width	45 mm		
Height	99 mm		
Depth	112 mm		
Degree of protection	IP20		
Ambient temperature (operation)	0°C ... 55°C		
Permissible humidity (operation)	30% ... 95% (non-condensing)		
EMC note	Class A product, see page 443		
Noise emission	EN 61000-6-3/-4		
Noise immunity	EN 61000-6-2:2005		
Ordering data			
<b>Description</b>	<b>Type</b>	<b>Order No.</b>	<b>Pcs. / Pkt.</b>
<b>Lean Managed Switch</b>	<b>FL SWITCH LM 8TX-B</b>	<b>2989446</b>	<b>1</b>

## Smart Managed Switches

The Smart Managed Narrow switch **FL SWITCH SMN 8TX-PN** is an Ethernet switch suitable for industrial applications with eight Fast Ethernet ports in RJ45 format. The switch is optimized for use in PROFINET RT and EtherNet/IP™ applications.

The switch has PROFINET mode activated by default. You can easily and quickly switch to EtherNet/IP™ or universal mode using the SMART button.

**Features:**

- Narrow design
- VLANs
- RSTP
- MRP client
- MRP master with FL MEM PLUG/MRM configuration memory as an option
- Web-based management, SNMP
- PROFINET device function
- LLDP

## Ethernet



8 RJ45 ports

## Ethernet interface

Number of ports  
Transmission speed  
Connection method

8 (RJ45 ports)  
10/100 Mbps  
RJ45

## Other connections

Serial (RS-232)

RS-232-C, 6-pos. MINI-DIN socket (PS/2)

## Function

Basic functions

Store-and-forward switch complies with IEEE 802.3 4 priority classes in acc. with IEEE 802.1 P TCP/IP protocol, BootP-capable, port-mirroring, integrated web server function, multicast filtering, IGMP snooping, VLAN, Rapid Spanning Tree (RSTP), PROFINET Device, Media Redundancy Protocol (MRP).

## Status and diagnostic indicators

2 status LEDs per Ethernet: LINK and selectable Status Activity, 100 Mbps, full duplex, supply voltage  $U_{S1}$  and  $U_{S2}$  (redundant supply voltage) and FAIL. FD/FO LED indicates duplex mode for Twisted-Pair ports and the system reserve for optical interfaces.

## Network expansion parameters

Cascading depth  
Maximum conductor length (twisted pair)

Network, linear, and star structure: any  
100 m

## Power supply

Supply voltage  
Residual ripple  
Supply voltage range  
Typical current consumption

24 V DC  
3.6 V<sub>PP</sub>  
18 V DC ... 32 V DC  
320 mA (at  $U_S = 24$  V DC)

## General data

Weight  
Width  
Height  
Depth  
Degree of protection  
Ambient temperature (operation)  
Permissible humidity (operation)  
Noise emission  
Noise immunity

720 g  
56 mm  
133 mm  
125 mm  
IP20  
0°C ... 55°C (non-condensing)  
5% ... 95% (non-condensing)  
EN 61000-6-3 +A11  
EN 61000-6-2:2005

## Description

Smart Managed Narrow Switch

## Ordering data

Type	Order No.	Pcs. / Pkt.
FL SWITCH SMN 8TX-PN	2989501	1

## Accessories

Configuration memory, replaceable  
Configuration memory, can be replaced with MRM function

FL MEM PLUG	2891259	1
FL MEM PLUG/MRM	2891275	1

Industrial Ethernet switches

Advanced Managed Switches

The automation switches in the 7000 series are the first switches to support direct integration into a Device Level Ring (DLR). Direct integration of the switches into the DLR is a considerable advantage when installing and operating EtherNet/IP™ networks.

Up to six devices can be integrated into a DLR via the FL SWITCH 7000. In system networks, the switches allow the redundant rings to be connected to the higher-level networking level. In this way, you can create networks with minimal switch-over times of less than three milliseconds (< 3 ms).

The Managed Switches of the 7000 series communicate directly via the Common Industrial Protocol (CIP) in the EtherNet/IP™ network. Via CIP, you can integrate the switch into an EtherNet/IP™ control system from where it can be configured and diagnosed.

Pure copper versions and versions with up to three fiberglass ports are available for flexible use.

**Features:**

- Narrow design
- -40°C ... +70°C ambient temperature
- VLANs
- Common Industrial Protocol (CIP)
- Device Level Ring (DLR)
- RSTP
- Web-based management



Ethernet



8 RJ45 ports

Technical data			
Ethernet interface			
Number of ports	8 (RJ45 ports)		
Transmission speed	10/100 Mbps		
Connection method	RJ45		
Fiber optic interface			
Number of ports	-		
Transmission speed	-		
Connection method	-		
Transmission length	-		
Fiber optic interface			
Number of ports	-		
Transmission speed	-		
Connection method	-		
Transmission length	-		
Function			
Basic functions	Store-and-forward switch complies with IEEE 802.3, 8 priority classes in acc. with IEEE 802.1 P (QoS), N:1 port mirroring, IGMP snooping, VLANs, Rapid Spanning Tree (RSTP), Large Tree Support, Fast Ring Detection (FRD), link aggregation (802.3ad), MAC-based port security, DHCP option 82, LLDP, ACD, Device Level Ring (DLR), Common Industrial Protocol (CIP)		
Status and diagnostic indicators	2 status LEDs per Ethernet: LINK and selectable status LED: activity, 100 Mbps, full duplex. Supply voltage: U <sub>S1</sub> and U <sub>S2</sub> (redundant supply voltage) and FAIL. EtherNet/IP™ status LED: Net, Mod		
Network expansion parameters			
Cascading depth	Network, linear, and star structure: any		
Maximum conductor length (twisted pair)	100 m		
Power supply			
Supply voltage	24 V DC		
Residual ripple	3.6 V <sub>PP</sub>		
Supply voltage range	12 V DC ... 60 V DC		
Typical current consumption	350 mA (at U <sub>S</sub> = 24 V DC)		
General data			
Weight	900 g		
Width	60 mm		
Height	130 mm		
Depth	135.5 mm		
Degree of protection	IP20		
Ambient temperature (operation)	-40°C ... 70°C		
Permissible humidity (operation)	10% ... 95% (non-condensing)		
Noise emission	EN 61000-6-4		
Noise immunity	EN 61000-6-2:2005		
<b>Ordering data</b>			
Description	Type	Order No.	Pcs. / Pkt.
<b>Advanced Managed Switch</b>			
- 8 RJ45 ports	<b>FL SWITCH 7008-EIP</b>	<b>2701418</b>	<b>1</b>
- 6 RJ45 ports, 2 SC FO ports (multi-mode)			
- 5 RJ45 ports, 2 SC fiber optic ports (multi-mode), 1 SC fiber optic port (single-mode)			
<b>Accessories</b>			
Parameterization memory, replaceable	<b>SD FLASH 512MB</b>	<b>2988146</b>	<b>1</b>

Ethernet



**6 RJ45 ports and  
2 fiber optic ports (multi-mode)**

Ethernet



**5 RJ45 ports and  
1 fiber optic port (multi-mode),  
2 fiber optic ports (single-mode)**

**Technical data**

6 (RJ45 ports)  
10/100 Mbps  
RJ45

2 (SC multi-mode)  
100 Mbps (full duplex)  
SC  
11000 m (fiberglass with F-G 62.5/125 0.7 dB/km F1000)

-  
-  
-  
-

Store-and-forward switch complies with IEEE 802.3, 8 priority classes in acc. with IEEE 802.1 P (QoS), N:1 port mirroring, IGMP snooping, VLANs, Rapid Spanning Tree (RSTP), Large Tree Support, Fast Ring Detection (FRD), link aggregation (802.3ad), MAC-based port security, DHCP option 82, LLDP, ACD, Device Level Ring (DLR), Common Industrial Protocol (CIP)

2 status LEDs per Ethernet: LINK and selectable status LED: activity, 100 Mbps, full duplex. Supply voltage:  $U_{S1}$  and  $U_{S2}$  (redundant supply voltage) and FAIL. EtherNet/IP™ status LED: Net, Mod

Network, linear, and star structure: any  
100 m

24 V DC  
3.6 V<sub>pp</sub>  
12 V DC ... 60 V DC  
470 mA (at  $U_S = 24$  V DC)

990 g  
60 mm  
130 mm  
135.5 mm  
IP20  
-40°C ... 70°C  
10% ... 95% (non-condensing)  
EN 61000-6-4  
EN 61000-6-2:2005

**Ordering data**

Type	Order No.	Pcs. / Pkt.
FL SWITCH 7006/2FX-EIP	2701419	1

**Accessories**

SD FLASH 512MB	2988146	1
----------------	---------	---

**Technical data**

5 (RJ45 ports)  
10/100 Mbps  
RJ45

1 (SC multi-mode)  
100 Mbps (full duplex)  
SC  
11000 m (fiberglass with F-G 62.5/125 0.7 dB/km F1000)

2 (SC single-mode)  
100 Mbps (full duplex)  
SC  
36000 m (fiberglass with F-G 9/125 0.36 dB/km)

Store-and-forward switch complies with IEEE 802.3, 8 priority classes in acc. with IEEE 802.1 P (QoS), N:1 port mirroring, IGMP snooping, VLANs, Rapid Spanning Tree (RSTP), Large Tree Support, Fast Ring Detection (FRD), link aggregation (802.3ad), MAC-based port security, DHCP option 82, LLDP, ACD, Device Level Ring (DLR), Common Industrial Protocol (CIP)

2 status LEDs per Ethernet: LINK and selectable status LED: activity, 100 Mbps, full duplex. Supply voltage:  $U_{S1}$  and  $U_{S2}$  (redundant supply voltage) and FAIL. EtherNet/IP™ status LED: Net, Mod

Network, linear, and star structure: any  
100 m

24 V DC  
3.6 V<sub>pp</sub>  
12 V DC ... 60 V DC  
520 mA (at  $U_S = 24$  V DC)

1000 g  
60 mm  
130 mm  
135.5 mm  
IP20  
-40°C ... 70°C  
10% ... 95% (non-condensing)  
EN 61000-6-4  
EN 61000-6-2:2005

**Ordering data**

Type	Order No.	Pcs. / Pkt.
FL SWITCH 7005/FX-2FXSM-EIP	2701420	1

**Accessories**

SD FLASH 512MB	2988146	1
----------------	---------	---

Industrial Ethernet switches

Redundancy modules according to IEC 61850/IEEE 1613

Energy networks rely on particularly high fault tolerance. The new PRP redundancy modules enable parallel redundancy without switch-over time in the event of a fault. You can therefore ensure maximum availability of your network.

Interruption-free communication

- The FL RED 2000E redundancy module is equipped with the Parallel Redundancy Protocol (PRP)
- Interoperability in high-availability networks is possible, as required in the energy sector
- The system continues to operate in the case of redundancy without switch-over time

Robust design

- Developed according to the requirements of IEC 61850-3 and IEEE 1613: complies with the high requirements for network technology in this area
- Robust to withstand voltage fluctuations due to a wide input voltage range of 18 V DC ... 58 V DC
- Rugged metal housing
- -40°C ... 70°C operating temperature

Easy handling

- Design of a high-availability network without configuration
- LED indicators provide on-site information regarding the status of the network and redundancy
- Alarm signal contact indicates the status of the module and network

Ethernet

IEC 61850-3



Redundancy module

Ethernet interface	
Number of ports	3 (RJ45 ports)
Transmission speed	10/100 Mbps
Transmission length	100 m (per segment)
Fiber optic interface	
Interface	Ethernet FO
Number of ports	2
Transmission speed	100 Mbps (full duplex)
Connection method	LC
Transmission length	2 km (per segment)
Function	
Basic functions	Ethernet redundancy module for the Parallel Redundancy Protocol
Status and diagnostic indicators	
LEDs: U <sub>S1</sub> , U <sub>S2</sub> (redundant voltage supply), link and activity per port	
Power supply	
Supply voltage	24 V DC (redundant) 48 V DC (redundant)
Residual ripple	3.6 V <sub>pp</sub>
Supply voltage range	18 V DC ... 58 V DC
Typical current consumption	250 mA (@24 V DC)
General data	
Weight	
Width	40 mm
Height	100 mm
Depth	109 mm
Degree of protection	IP20
Ambient temperature (operation)	-40°C ... 70°C
Permissible humidity (operation)	10% ... 95% (non-condensing)
Noise emission	EN 61000-6-4
Noise immunity	IEC 61850-3, IEEE 1613, EN 61000-6-2: 2005

Technical data	
FL RED 2003E PRP	FL RED 2001E PRP 2LC
3 (RJ45 ports)	1 (RJ45 port)
	10/100 Mbps
	100 m (per segment)
-	Ethernet FO
-	2
-	100 Mbps (full duplex)
-	LC
-	2 km (per segment)
Ethernet redundancy module for the Parallel Redundancy Protocol	
LEDs: U <sub>S1</sub> , U <sub>S2</sub> (redundant voltage supply), link and activity per port	
24 V DC (redundant)	
48 V DC (redundant)	
3.6 V <sub>pp</sub>	
18 V DC ... 58 V DC	
250 mA (@24 V DC)	
40 mm	
100 mm	
109 mm	
IP20	
-40°C ... 70°C	
10% ... 95% (non-condensing)	
EN 61000-6-4	
IEC 61850-3, IEEE 1613, EN 61000-6-2: 2005	

Description
<b>Redundancy module</b>
- 3 RJ45 ports
- 1 RJ45 port, 2 LC fiber optic ports (multi-mode)

Ordering data		
Type	Order No.	Pcs. / Pkt.
FL RED 2003E PRP	2701863	1
FL RED 2001E PRP 2LC	2701864	1



## Managed Switches according to IEC 61850/IEEE 1613

Ethernet switches control Ethernet traffic and maximize uptime. Operation in extreme environments is assured with a wide temperature range and an electrical noise immunity up to four times that of normal industrial switches.

Features:

- DIN rail mounting
- Mix IEEE and Extended Ring redundancy options which provide 15 ms recovery time for hundreds of switches
- Comprehensive IEEE security and performance functions
- Unique web customization, diagnostic viewing mode and, help pages simplify maintenance
- Optional PRP redundancy modules provide 0 ms recovery times

Ethernet interface	
Number of ports	
Transmission speed	
Fiber optic interface	
Number of ports	
Transmission speed	
Connection method	
Function	
Basic functions	
Status and diagnostic indicators	
Network expansion parameters	
Cascading depth	
Maximum conductor length (twisted pair)	
Power supply	
Supply voltage	
Residual ripple	
Supply voltage range	
Typical current consumption	
General data	
Weight	
Width	
Height	
Depth	
Degree of protection	
Ambient temperature (operation)	
Permissible humidity (operation)	
EMC note	
Noise emission	
Noise immunity	

Description	
<b>Managed switch</b>	
- 16 RJ45 ports	
- 12 RJ45 and 2 SFP FO ports	

<b>Redundancy module</b>	
- 3 RJ45 ports	
- 1 RJ45 port, 2 LC fiber optic ports (multi-mode)	

Ethernet

IEC 61850-3



16 RJ45 ports

Technical data	
FL SWITCH 3016E	FL SWITCH 3012E-2SFX
16 (RJ45 ports)	12 (RJ45 ports)
10/100 Mbps (with auto negotiation)	
-	2 (FO ports)
-	100 Mbps (full duplex)
-	SFP ports
Store and forward switch, Extended Ring and IEEE redundancy, Multicast control, IGMP snooping, trunking, Port and Tagging VLANs, Port and IEEE 802.1x security, SNMP V3 and Https security, SNTP, web customization, user accounts	
LEDs: U <sub>S1</sub> , U <sub>S2</sub> (redundant voltage supply), link and activity per port	
Network, linear, and star structure: any	
100 m	
24 V DC	
3.6 V <sub>pp</sub>	
12 V DC ... 48 V DC	
312 mA (24 V DC)	
66 mm	
173 mm	
140 mm	
IP20	
-40°C ... 70°C	
5% ... 95% (non-condensing)	
Class A product, see page 443	
EN 61000-6-4	
IEC 61850-3, IEEE 1613, EN 61000-6-2: 2005	

Ordering data		
Type	Order No.	Pcs. / Pkt.
FL SWITCH 3016E	2891066	1
FL SWITCH 3012E-2SFX	2891067	1

Accessories		
Type	Order No.	Pcs. / Pkt.
FL RED 2003E PRP	2701863	1
FL RED 2001E PRP 2LC	2701864	1

Industrial Ethernet switches

**Managed Switches according to IEC 61850/IEEE 1613, 19" rack-mount**

The FL SWITCH 4800E line of managed switches combines 24 ports of 10/100 Mbps device connections with four 10/100/1000 Mbps uplink ports for a total of 28 ports. Application flexibility is assured with different mixes of copper/fiber and fiber types, gigabit fiber/copper "combination" ports and modular power supplies. Operation in extreme environments is assured with a wide temperature range and an electrical noise immunity up to four times that of normal industrial switches.

**Features:**

- All switches have four Gigabit RJ45/SFP combination ports for supervisory or high throughput field network connections
- Flexible cabling using eight or 24 10/100 Mbps RJ45 connections with up to 16 fiber (100 Mbps) fiber connections
- Mix IEEE and Extended Ring redundancy options which provide 15 ms recovery time for hundreds of switches
- Optional PRP redundancy modules provide 0 ms recovery times
- Comprehensive IEEE security and performance functions
- Unique web customization, diagnostic viewing mode and help pages simplify maintenance
- Supports up to two modular, hot-swappable power supplies for maximum power flexibility and uptime
- Electrical noise immunity per IEC 61850-3 and IEEE 1613

**Notes:**  
 1) Requires the installation of at least one FL SWITCH 4800E-P1 or FL SWITCH 4800E-P5 for operation.

**Ethernet**

IEC 61850-3



**24 RJ45 ports and 4 gigabit combo (SFP or RJ45) ports**

<b>Ethernet interface</b>	
Number of ports	24 (RJ45 ports)
Transmission speed	10/100 Mbps
<b>Ethernet (RJ45/FO combo)</b>	
Interface	Ethernet (RJ45/FO combo)
Connection method	RJ45, shielded or SFP module (LC)
Note on connection method	Auto negotiation and autocrossing (RJ45 interface)
<b>Fiber optic interface</b>	
Number of ports	-
Transmission speed	-
Connection method	-
Transmission length	-
<b>Function</b>	
Basic functions	Store and forward switch, Extended Ring and IEEE redundancy, Multicast control, IGMP snooping, trunking, Port and Tagging VLANs, Port and IEEE 802.1x security, SNMP V3 and Https security, SNTp, web customization, user accounts
<b>Status and diagnostic indicators</b>	
	LEDs: U <sub>S1</sub> , U <sub>S2</sub> (redundant voltage supply), link and activity per port
<b>Network expansion parameters</b>	
Cascading depth	Network, linear, and star structure: any
Maximum conductor length (twisted pair)	100 m
<b>Power supply</b>	
Power supply connection	From FL SWITCH 4800E-P...
Supply voltage	-
Nominal input voltage range	-
<b>General data</b>	
Weight	4494 g
Width	442 mm
Height	44 mm
Depth	375 mm
Degree of protection	IP20
Ambient temperature (operation)	-40°C ... 70°C
Permissible humidity (operation)	5% ... 95% (non-condensing)
Noise emission	EN 61000-6-4
Noise immunity	IEC 61850-3, IEEE 1613, EN 61000-6-2: 2005

**Technical data**

<b>Technical data</b>		
<b>Ethernet interface</b>		
Number of ports	24 (RJ45 ports)	
Transmission speed	10/100 Mbps	
<b>Ethernet (RJ45/FO combo)</b>		
Interface	Ethernet (RJ45/FO combo)	
Connection method	RJ45, shielded or SFP module (LC)	
Note on connection method	Auto negotiation and autocrossing (RJ45 interface)	
<b>Fiber optic interface</b>		
Number of ports	-	
Transmission speed	-	
Connection method	-	
Transmission length	-	
<b>Function</b>		
Basic functions	Store and forward switch, Extended Ring and IEEE redundancy, Multicast control, IGMP snooping, trunking, Port and Tagging VLANs, Port and IEEE 802.1x security, SNMP V3 and Https security, SNTp, web customization, user accounts	
<b>Status and diagnostic indicators</b>		
	LEDs: U <sub>S1</sub> , U <sub>S2</sub> (redundant voltage supply), link and activity per port	
<b>Network expansion parameters</b>		
Cascading depth	Network, linear, and star structure: any	
Maximum conductor length (twisted pair)	100 m	
<b>Power supply</b>		
Power supply connection	From FL SWITCH 4800E-P...	
Supply voltage	-	
Nominal input voltage range	-	
<b>General data</b>		
Weight	4494 g	
Width	442 mm	
Height	44 mm	
Depth	375 mm	
Degree of protection	IP20	
Ambient temperature (operation)	-40°C ... 70°C	
Permissible humidity (operation)	5% ... 95% (non-condensing)	
Noise emission	EN 61000-6-4	
Noise immunity	IEC 61850-3, IEEE 1613, EN 61000-6-2: 2005	

<b>Description</b>
<b>Managed switch</b> , 19-inch rack mounted - 24 RJ45 and 4 GB combo ports
<b>Managed switch</b> , 19-inch rack mounted with 8 RJ45 and 4 GB combo ports - 16 fiber optic (LC duplex) ports - 16 fiber optic (LC single-mode) ports - 16 fiber optic (SC duplex) ports - 16 fiber optic (SC single-mode) ports

**Ordering data**

Type	Order No.	Pcs. / Pkt.
<b>FL SWITCH 4824E-4GC<sup>1)</sup></b>	<b>2891072</b>	<b>1</b>

<b>Power supply</b> , modular redundant - 48 V DC nominal - 230 V nominal
<b>Redundancy module</b> - 3 RJ45 ports - 1 RJ45 port, 2 LC fiber optic ports (multi-mode)

**Accessories**

<b>FL SWITCH 4800E-P1</b>	<b>2891075</b>	<b>1</b>
<b>FL SWITCH 4800E-P5</b>	<b>2891076</b>	<b>1</b>
<b>FL RED 2003E PRP</b>	<b>2701863</b>	<b>1</b>
<b>FL RED 2001E PRP 2LC</b>	<b>2701864</b>	<b>1</b>

Ethernet

IEC 61850-3



8 RJ45 ports,  
4 gigabit combo (SFP or RJ45) ports,  
and 16 LC FO ports

Ethernet

IEC 61850-3



8 RJ45 ports,  
4 gigabit combo (SFP or RJ45) ports,  
and 16 SC FO ports

IEC 61850-3



Power supply modules for 4800E switches

Technical data	
FL SWITCH 4808E-16FX LC-4GC <sup>1)</sup>	FL SWITCH 4808E-16FX SM-LC-4GC <sup>1)</sup>
8 (RJ45 ports) 10/100 Mbps	
Ethernet (RJ45/FO combo) RJ45, shielded or SFP module (LC) Auto negotiation and autocrossing (RJ45 interface)	
16 (multi-mode) 100 Mbps (full duplex) LC	16 (single-mode) 40 km (typical)
2 km (typical)	
Store and forward switch, Extended Ring and IEEE redundancy, Multicast control, IGMP snooping, trunking, Port and Tagging VLANs, Port and IEEE 802.1x security, SNMP V3 and Https security, Sntp, web customization, user accounts	
LEDs: U <sub>S1</sub> , U <sub>S2</sub> (redundant voltage supply), link and activity per port	
Network, linear, and star structure: any 100 m	
From FL SWITCH 4800E-P... -	
4706 g	4700 g
442 mm 44 mm 375 mm IP20 -40°C ... 70°C 5% ... 95% (non-condensing) EN 61000-6-4	
IEC 61850-3, IEEE 1613, EN 61000-6-2: 2005	

Technical data	
FL SWITCH 4808E-16FX-4GC <sup>1)</sup>	FL SWITCH 4808E-16FX SM-4GC <sup>1)</sup>
8 (RJ45 ports) 10/100 Mbps	
Ethernet (RJ45/FO combo) RJ45, shielded or SFP module (LC) Auto negotiation and autocrossing (RJ45 interface)	
16 (multi-mode) 100 Mbps (full duplex) SC	16 (single-mode) 40 km (typical)
2 km (typical)	
Store and forward switch, Extended Ring and IEEE redundancy, Multicast control, IGMP snooping, trunking, Port and Tagging VLANs, Port and IEEE 802.1x security, SNMP V3 and Https security, Sntp, web customization, user accounts	
LEDs: U <sub>S1</sub> , U <sub>S2</sub> (redundant voltage supply), link and activity per port	
Network, linear, and star structure: any 100 m	
From FL SWITCH 4800E-P... -	
4470 g	4680 g
442 mm 44 mm 375 mm IP20 -40°C ... 70°C 5% ... 95% (non-condensing) EN 61000-6-4	
IEC 61850-3, IEEE 1613, EN 61000-6-2: 2005	

Technical data	
FL SWITCH 4800E-P1	FL SWITCH 4800E-P5
-	-
-	-
-	-
-	-
-	-
-	-
-	-
48 V DC 36 V DC ... 75 V DC	230 V AC/DC 88 V DC ... 370 V DC 90 V AC ... 264 V AC
836 g	884 g
	150 mm 40 mm 193 mm IP20 -40°C ... 75°C 5% ... 95% (non-condensing)
-	

Ordering data		
Type	Order No.	Pcs. / Pkt.
FL SWITCH 4808E-16FX LC-4GC <sup>1)</sup>	2891073	1
FL SWITCH 4808E-16FX SM LC-4GC <sup>1)</sup>	2891074	1

Ordering data		
Type	Order No.	Pcs. / Pkt.
FL SWITCH 4808E-16FX-4GC <sup>1)</sup>	2891079	1
FL SWITCH 4808E-16FX SM-4GC <sup>1)</sup>	2891080	1

Ordering data		
Type	Order No.	Pcs. / Pkt.
FL SWITCH 4800E-P1	2891075	1
FL SWITCH 4800E-P5	2891076	1

Accessories		
Type	Order No.	Pcs. / Pkt.
FL SWITCH 4800E-P1	2891075	1
FL SWITCH 4800E-P5	2891076	1
FL RED 2003E PRP	2701863	1
FL RED 2001E PRP 2LC	2701864	1

Accessories		
Type	Order No.	Pcs. / Pkt.
FL SWITCH 4800E-P1	2891075	1
FL SWITCH 4800E-P5	2891076	1
FL RED 2003E PRP	2701863	1
FL RED 2001E PRP 2LC	2701864	1

Accessories		
Type	Order No.	Pcs. / Pkt.
FL SWITCH 4800E-P1	2891075	1
FL SWITCH 4800E-P5	2891076	1

Industrial Ethernet switches

Fiber optic interface module

Rugged, small form-factor pluggable (SFP) modules provide a variety of fiber optic interfaces. They are inserted into SFP sockets on managed switches, customizing both quantity and type of fiber used.

Features:

- Supports 100 Mbps full duplex fiber communication
- Electrical noise immunity per IEC 61850-3 and IEEE 1613
- Wide temperature range



IEC 61850-3

SFP modules for transmission ranges up to 40 km

		Technical data		
Fiber optic interface		FL SFP FX	FL SFP FX SM	
Number of ports		1 (LC multi-mode)	1 (LC single-mode)	
Wavelength			1300 nm	
Transmission length		Typ. 2 km	Typ. 40 km	
Function		SFP module as FO port		
Basic functions		via SFP slot		
Power supply				
Power supply connection				
General data				
Ambient temperature (operation)		-40°C ... 85°C (non-condensing)		
Permissible humidity (operation)		30% ... 95% (non-condensing)		
		Ordering data		
Description		Type	Order No.	Pcs. / Pkt.
Small form pluggable (SFP) fiber module (100 Mbps)				
- Multi-mode (2 km)		FL SFP FX	2891081	1
- Single-mode (40 km)		FL SFP FX SM	2891082	1

**WLAN access point**

The latest generation of WLAN modules offers maximum reliability, data throughput, and range.

**Faster**

- The new high-speed WLAN 5100 brings WLAN 802.11n to industrial applications and with it a data rate of up to 300 Mbps

**Configuration**

- Central cluster management enables the entire wireless network to be set up in just minutes

**More reliable**

- MiMo technology with three antennas for wireless communication that is more robust, faster, and covers a wider range

**WLAN**

**WLAN access point/client 2.4 GHz, 5 GHz  
802.11 a, b, g, n  
Approval for Japan**

	Technical data
Wireless interface	
Wireless standard	IEEE 802.11
Frequency band	2.4 GHz/5 GHz
Antenna connection method	RSMA (female)
Number	3
Antenna	
Assembly instructions	Antennas not included in scope of supply
Ethernet ports	
Number	2
Connection method	RJ45 socket
Power supply for module electronics	
Supply voltage	24 V DC
Connection method	Via COMBICON
Supply voltage range	10 V DC ... 36 V DC
Supply current	200 mA
Security	
	802.11i WPA PSK (preshared key) WPA2 AES TKIP Supports 802.1X/RADIUS MAC filter
Function	
Operating modes	Access point/client adapter/repeater/WDS bridge
Basic functions	SNMP (V2/V3), CLI, WPS, DHCP, DCP, BootP, HTTP, HTTPS, Syslog, SD card, dual FW image, 1 x DI, 1 x DO, 2 x Ethernet 10/100 Mbit, auto crossover, auto negotiation, MODE button
Configuration	Cluster management, web-based management, WPS
General data	
Weight	418 g
Width	40 mm
Height	109 mm
Depth	109 mm
Degree of protection	IP20
Ambient temperature (operation)	-25°C ... 60°C (extended temperature range on request)
Permissible humidity (operation)	10% ... 95% (non-condensing)
Air pressure (operation)	800 hPa ... 1080 hPa (up to 2000 m above mean sea level)
Shock in acc. with EN 60068-2-27/IEC 60068-2-27	30g
Vibration resistance in acc. with EN 60068-2-6/IEC 60068-2-6	5g

Ordering data		
Type	Order No.	Pcs. / Pkt.
FL WLAN 5102	2701850	1
Accessories		
SD FLASH 2GB	2988162	1

Description
<b>Wireless LAN Access Point</b> - Approval for Japan

<b>Parameterization memory</b> , Flash card without license
---

Media converters

FL MC 2000T... media converters optimize the performance and reliability of industrial Ethernet applications and are optimized for use in extreme environments. Selectable port settings provide usability with a wider range of devices. Selectable low latency (700 ns) allows the media converter to be used in time-critical applications. Configurable link monitoring diagnostics increase network reliability.

Features:

- Optional multi-mode or single-mode SC duplex fiber optic connection at 100 Mbps
- DIP switch selectable auto negotiate or fixed port settings, data rate and half or full duplex
- DIP switch selectable store-and-forward or pass-through mode (low latency, 700 ns)
- Alarm contact provides power and link status diagnostics
- Link fault pass through (LFP) function for easy connection monitoring
- Wide operating temperature range (-40°C... 75°C)

Ethernet



Multi-mode fiberglass SC duplex or B-FOC (ST®) connection

<b>Supply</b>	
Supply voltage	12 V DC ... 48 V DC
Nominal current consumption	110 mA (24 V DC)
<b>FO interface</b>	
Wavelength	1310 nm
Transmission length Incl. 3 dB system reserve	9.6 km (fiberglass with F-G 50/125 0.7 dB/km F1200)
<b>Signal LEDs</b>	
Switching output	LNK/ACT
<b>Ethernet interface</b>	
Connection method	RJ45 socket, shielded
Transmission speed	10/100 Mbps
Link through	Link fault pass through
MDI-/MDI-X switchover	Auto-MDI(X)
Signal LEDs	LNK/ACT, 100
<b>General data</b>	
Ambient temperature (operation)	-40°C ... 75°C
Test voltage	500 V DC
Dimensions	28 mm/110 mm/70 mm

Technical data	
<b>Supply</b>	
Supply voltage	12 V DC ... 48 V DC
Nominal current consumption	110 mA (24 V DC)
<b>FO interface</b>	
Wavelength	1310 nm
Transmission length Incl. 3 dB system reserve	9.6 km (fiberglass with F-G 50/125 0.7 dB/km F1200)
<b>Signal LEDs</b>	
Switching output	LNK/ACT
<b>Ethernet interface</b>	
Connection method	RJ45 socket, shielded
Transmission speed	10/100 Mbps
Link through	Link fault pass through
MDI-/MDI-X switchover	Auto-MDI(X)
Signal LEDs	LNK/ACT, 100
<b>General data</b>	
Ambient temperature (operation)	-40°C ... 75°C
Test voltage	500 V DC
Dimensions	28 mm/110 mm/70 mm

Description
<b>FO converter, for converting 10/100 BASE-TX to:</b>
Multi-mode fiberglass (1300 nm), SC duplex connection
Multi-mode fiberglass (1300 nm), B-FOC (ST®) connection
<b>FO converter, for converting 10/100 BASE-TX to:</b>
Single-mode fiberglass (1300 nm), SC duplex connection
Single-mode fiberglass (1300 nm), LC duplex connection

Ordering data		
Type	Order No.	Pcs. / Pkt.
FL MC 2000T SC	2891315	1
FL MC 2000T ST	2891316	1

Ethernet



Single-mode fiberglass  
SC duplex connection

Ethernet



Single-mode fiberglass  
SC duplex connection

Ethernet

IEC 61850-3



Single-mode fiberglass  
LC duplex connection

Technical data
12 V DC ... 48 V DC 110 mA (24 V DC)
1310 nm 20 km (fiberglass with F-G 9/125 0.3 dB/km)
LNK/ACT Floating relay output
RJ45 socket, shielded 10/100 Mbps Link fault pass through Auto-MDI(X) LNK/ACT, 100
-40°C ... 75°C 500 V DC 28 mm/110 mm/70 mm

Technical data
12 V DC ... 48 V DC 110 mA (24 V DC)
1310 nm 40 km (fiberglass with F-G 9/125 0.3 dB/km)
LNK/ACT Floating relay output
RJ45 socket, shielded 10/100 Mbps Link fault pass through Auto-MDI(X) LNK/ACT, 100
-40°C ... 75°C 500 V DC 28 mm/110 mm/70 mm

Technical data
12 V DC ... 57 V DC 110 mA (24 V DC)
1300 nm 40 km (typical)
LNK/ACT Floating relay output
RJ45 socket, shielded 100 Mbps Link fault pass through Auto-MDI(X) LNK/ACT, 100
-40°C ... 75°C 500 V DC 30 mm/130 mm/100 mm

Ordering data		
Type	Order No.	Pcs. / Pkt.
FL MC 2000T SM20 SC	2891317	1

Ordering data		
Type	Order No.	Pcs. / Pkt.
FL MC 2000T SM40 SC	2891318	1

Ordering data		
Type	Order No.	Pcs. / Pkt.
FL MC 2000E SM40 LC	2891156	1

**COM server for extreme fields of application**



The **FL COMSERVER...232/422/485-T** offer extended temperature and supply voltage ranges. This means that you can now integrate serial RS-232/422/485 interfaces in existing Ethernet networks, even under extreme ambient conditions. Implement functions such as cable replacement, network integration or a Modbus gateway with ease.

Both devices extend the existing FL COMSERVER product range.

- FL COMSERVER BASIC 232/422/485 (Order No.: 2313478)
- FL COMSERVER UNI 232/422/485 (Order No.: 2313452)
- FL COMSERVER WLAN 232/422/485 (Order No.: 2313559)
- FL COMSERVER PRO 232/422/485 (Order No.: 2313465)

**Cable replacement**

Two devices in combination tunnel serial connections via Ethernet, using either the TCP or UDP protocol.

**Network integration**

You can integrate automation devices such as controllers or frequency inverters into a network using corresponding programming and diagnostics software. COM diversion software creates a virtual COM port on the PC and transmits the data to the FL COMSERVER.

**Modbus gateway**

The integrated Modbus gateway function provided in FL COMSERVER UNI converts serial Modbus ASCII or RTU data into Modbus TCP. Naturally, the conversion process also works in the opposite direction.

**Features of the T versions**

- Extended temperature range -40°C to +70°C
- Supply voltage 12 ... 30 V AC/DC
- Serial interfaces: RS-232, RS-422, RS-485
- 10/100 Base-T(X) interface
- Software for virtual COM ports supplied as standard
- 3-way electrical isolation VCC // RS-232/RS-422/RS-485 // network
- Configuration via web-based management

**FL COMSERVER UNI...-T**

- Supports TCP, UDP, Modbus TCP/RTU/ASCII
- Can be used exactly as required on Modbus master or slave

**FL COMSERVER BAS...-T**

- Best-value version
- Supports TCP and UDP

<b>Supply</b>		
Supply voltage		
Nominal current consumption		
<b>Serial port</b>		
Interfaces		
Connection method	RS-232	
	RS-422	
	RS-485	
Data format/encoding		
Data flow control/protocols		
Transmission speed		
Termination resistor		
<b>Ethernet interface</b>		
Connection method		
Transmission speed		
Transmission length		
Supported protocols		
Auxiliary protocols		
<b>Functions</b>		
Management		
<b>General data</b>		
Ambient temperature (operation)		
Electrical isolation		
Test voltage		
Electromagnetic compatibility		
Standards/regulations		
Dimensions		W / H / D
Conformance / approvals		ATEX

<b>Description</b>	
<b>FL COMSERVER...232/422/485</b> , for converting serial interfaces to Ethernet. COM port redirector software and additional software supplied as standard	
TCP, UDP, MODBUS, PPP	
TCP, UDP	

<b>D-SUB plug</b> , with screw connection	
- 9-pos., socket	
<b>RS-232-D-SUB cable</b> , length: 2 m	
- 9-pos. socket on 9-pos. socket	
- 9-pos. socket on 25-pos. socket	
<b>Patch cable</b> , CAT5, preassembled	
3 m	
<b>Shield connection clamp</b> for RS-485/422 operation	



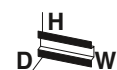

Ethernet



Universal device - Modbus gateway between RTU/ASCII and TCP



Ethernet



Basic version for redirector operation - TCP and UDP

Technical data
12 V AC/DC ... 30 V AC/DC (observe derating) 100 mA (24 V DC)
RS-232, RS-422, RS-485 D-SUB-9 plug Plug-in/screw connection via COMBICON Plug-in/screw connection via COMBICON UART/NRZ: 7/8 bit data, 1/2 bit stop, 1 bit parity
Software handshake, Xon/Xoff, or hardware handshake RTS/CTS // 3964 R compatible, Modbus RTU/ASCII
0.3; 0.6; 1.2; 2.4; 4.8; 7.2; 9.6; 19.2; 38.4; 57.6; 115.2; 187.5; 230.4 kbps 390 Ω/180 Ω/390 Ω (configurable)
RJ45 socket, shielded 10/100 Mbps, auto negotiation ≤ 100 m (shielded twisted pair) TCP/IP, UDP, Modbus (TCP, RTU/ASCII), PPP ARP, DHCP, BOOTP, SNMP, RIP, RARP, HTTP, TFTP
Web-based management, SNMP, emergency exit with Telnet and serial
-40°C ... 70°C (free-standing, 40mm space on all sides)
DIN EN 50178 (VCC // Ethernet // Serial) 1.5 kV <sub>rms</sub> (50 Hz, 1 min.) Conformance with EMC Directive 2004/108/EC EN 50121-4 45 mm/99 mm/116 mm
II 3G Ex nA IIC T4 Gc X

Technical data
12 V AC/DC ... 30 V AC/DC (observe derating) 100 mA (24 V DC)
RS-232, RS-422, RS-485 D-SUB-9 plug Plug-in/screw connection via COMBICON Plug-in/screw connection via COMBICON UART/NRZ: 7/8 bit data, 1/2 bit stop, 1 bit parity
Software handshake, Xon/Xoff, or hardware handshake RTS/CTS // 3964 R compatible, Modbus RTU/ASCII
0.3; 0.6; 1.2; 2.4; 4.8; 7.2; 9.6; 19.2; 38.4; 57.6; 115.2; 187.5; 230.4 kbps 390 Ω/180 Ω/390 Ω (configurable)
RJ45 socket, shielded 10/100 Mbps, auto negotiation ≤ 100 m (shielded twisted pair) TCP/IP, UDP ARP, DHCP, BOOTP, SNMP, RIP, RARP, HTTP, TFTP
Web-based management, SNMP, emergency exit with Telnet and serial
-40°C ... 70°C (free-standing, 40mm space on all sides)
DIN EN 50178 (VCC // Ethernet // Serial) 1.5 kV <sub>rms</sub> (50 Hz, 1 min.) Conformance with EMC Directive 2004/108/EC EN 50121-4 45 mm/99 mm/116 mm
II 3G Ex nA IIC T4 Gc X

Ordering data		
Type	Order No.	Pcs. / Pkt.
FL COMSERVER UNI 232/422/485-T	2904817	1

Ordering data		
Type	Order No.	Pcs. / Pkt.
FL COMSERVER BAS 232/422/485-T	2904681	1

Accessories		
SUBCON 9/F-SH	2761499	1
PSM-KA9SUB9/BB/2METER	2799474	1
PSM-KA 9 SUB 25/BB/2METER	2761059	1
FL CAT5 PATCH 3,0	2832292	10
ME-SAS	2853899	10

Accessories		
SUBCON 9/F-SH	2761499	1
PSM-KA9SUB9/BB/2METER	2799474	1
PSM-KA 9 SUB 25/BB/2METER	2761059	1
FL CAT5 PATCH 3,0	2832292	10
ME-SAS	2853899	10

Passive patch panel for the DIN rail

The mini patch panels provide a convenient alternative to on-site assembly of RJ45 plugs.

The cross-control-cabinet field cabling is simply connected to screw connection terminal blocks or RJ45 sockets, depending on the version selected.

The connection to the termination devices is then completed using pre-assembled RJ45 patch cables.

The new patch panels extend the product range of passive connection fields with new properties.

General features

- CAT5e
- 10/100 Mbps
- Mounted on DIN rails

FL-PP-RJ45/RJ45-B

Ethernet interface module with two RJ45 sockets as basic version with compact design and extended temperature range.

- Two RJ45 sockets
- 8-pin assignment: 1:1
- Extended temperature range -40°C to 85°C
- Narrow design W/H/D: 22.5 mm/78 mm/44 mm

FL-PP-RJ45-SCC/...

Y-splitter for transmission of two individual network connections with 10/100 Mbps via a CAT cable with eight wires.

- Spring-cage connection terminal blocks
- Option of shield contacting on DIN rail via jumpers
- For **FL-PP-.../SC041**: two RJ45 sockets, vertical
- For **FL-PP-.../SC045**: two RJ45 sockets, horizontal

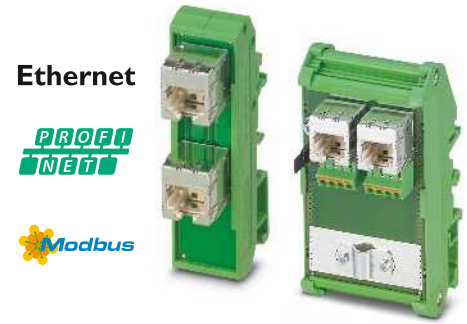

General data	
Cable impedance	100 Ω
Transmission speed	10/100 Mbps
Connection line	twisted pair, shielded, CAT5 or better
Transmission length	100 m (including patch cables)
Plug connection	RJ45 CAT5
Insertion/withdrawal cycles	≤ 2500
Degree of protection	IP20
Housing material	PA 6.6-FR
Weight	33 g

Technical data		
Cable impedance	100 Ω	
Transmission speed	10/100 Mbps	
Connection line	twisted pair, shielded, CAT5 or better	
Transmission length	100 m (including patch cables)	
Plug connection	RJ45 CAT5	
Insertion/withdrawal cycles	≤ 2500	
Degree of protection	IP20	
Housing material	PA 6.6-FR	
Weight	33 g	

Description	
<b>Patch panel, two RJ45 sockets</b> (1:1 assignment), <b>extended temperature range</b> , CAT5, 10/100 Mbps, DIN rail mounting, IP20, consistent shield, width 22.5 mm	

Ordering data		
Type	Order No.	Pcs. / Pkt.
FL-PP-RJ45/RJ45-B	2904933	10
FL-PP-RJ45-SCC/SC041	2903532	1
FL-PP-RJ45-SCC/SC045	2904577	1

Description	
<b>Cable sharing module</b> , two RJ45 sockets with Ethernet assignment, to 8 spring-cage connection terminal blocks, CAT5e, 10/100 Mbps, DIN rail mounting, IP20, option of shield contacting on DIN rail via jumpers	
- Cable outlet at the front, width 52 mm	
- Cable outlet at the top, width 56 mm	



Remote signaling and remote control system

Alarm and remote control via the mobile phone network

Use the mobile phone network, monitor analog and digital values, and switch relays remotely using the TC mobile I/O product range.

Depending on the product version, data is transmitted via SMS, e-mail, GPRS or ODP protocol.

Thanks to the large voltage range and the different inputs, the signaling system is suitable for use in a wide range of applications.

Features:

- Event-controlled or continual communication
- 4 digital inputs
- 2 analog inputs (current/voltage)
- 4 relay outputs, switchable via mobile phone
- Alarming in case of voltage failure via SMS
- Configuration via USB and web browser
- Standard SIM card
- Compact design: 4 pitches (DIN 43880)
- Cover can be sealed
- Numerous helpful software functions

Applications:

- Machine, building and system monitoring
- Pumps, sewage treatment plants, water supply
- Light controllers, remote switching systems
- Lifts, doors
- Alarm and domestic engineering
- Climate and ventilation engineering
- Battery monitoring up to 60 V
- Railway applications according to EN 50121-4

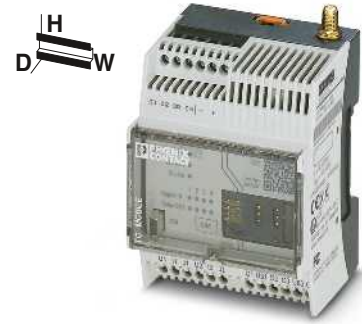

Communication via SMS and e-mail, 2 additional analog inputs

<b>Supply</b>	
Supply voltage	10 V DC ... 60 V DC
Supply voltage	-
Nominal current consumption	110 mA (24 V DC)
Stand-by current consumption	40 mA (stand by)
<b>USB interface</b>	
Connection method	Mini-USB type B, 5-pos.
Transmission length	≤ 3 m (only for configuration and diagnostics)
<b>Mobile phone network</b>	
Frequencies	850 MHz (2 W (EGSM))/900 MHz (2 W (EGSM)) / 1800 MHz (1 W (EGSM))/1900 MHz (1 W (EGSM))
<b>Digital input</b>	
Number of inputs	4
<b>Analog input</b>	
Number of inputs	2
Signal range	0 V DC ... 60 V DC/0 mA ... 20 mA/4 mA ... 20 mA (configurable)
Resolution	15 bit
Accuracy	± 0.1%
<b>Switching output</b>	
Contact type	4 x N/O contact
Max. switching voltage	60 V
Limiting continuous current	6 A
<b>General data</b>	
Ambient temperature (operation)	-25°C ... 70°C (for derating, see technical documentation)
Approvals for countries	EU, other countries in preparation
Electromagnetic compatibility	Conformance with EMC Directive 2004/108/EC
Dimensions	W / H / D 72 mm/90 mm/62 mm
ATEX	Ex II 3 G Ex nA nC IIC T4 Gc X

Technical data		
<b>Supply</b>		
Supply voltage	10 V DC ... 60 V DC	
Supply voltage	-	
Nominal current consumption	110 mA (24 V DC)	
Stand-by current consumption	40 mA (stand by)	
<b>USB interface</b>		
Connection method	Mini-USB type B, 5-pos.	
Transmission length	≤ 3 m (only for configuration and diagnostics)	
<b>Mobile phone network</b>		
Frequencies	850 MHz (2 W (EGSM))/900 MHz (2 W (EGSM)) / 1800 MHz (1 W (EGSM))/1900 MHz (1 W (EGSM))	
<b>Digital input</b>		
Number of inputs	4	
<b>Analog input</b>		
Number of inputs	2	
Signal range	0 V DC ... 60 V DC/0 mA ... 20 mA/4 mA ... 20 mA (configurable)	
Resolution	15 bit	
Accuracy	± 0.1%	
<b>Switching output</b>		
Contact type	4 x N/O contact	
Max. switching voltage	60 V	
Limiting continuous current	6 A	
<b>General data</b>		
Ambient temperature (operation)	-25°C ... 70°C (for derating, see technical documentation)	
Approvals for countries	EU, other countries in preparation	
Electromagnetic compatibility	Conformance with EMC Directive 2004/108/EC	
Dimensions	W / H / D 72 mm/90 mm/62 mm	
ATEX	Ex II 3 G Ex nA nC IIC T4 Gc X	

Description	<b>Compact signaling system</b> , for mobile phone networks, monitors inputs, switches relay outputs - Analog and digital inputs - Digital inputs
-------------	---

Ordering data		
Type	Order No.	Pcs. / Pkt.
TC MOBILE I/O X200	2903805	1

<b>Multi-band antenna</b> for UMTS and quad band GSM, with omnidirectional characteristic, 2 m antenna cable with SMA round plug, degree of protection: IP65, dimensions: 76 x 20 mm	<b>PSI-GSM/UMTS-QB-ANT</b>	2313371	1
<b>Multiband antenna</b> for external panel and external mast mounting for UMTS and quad-band GSM, with omnidirectional characteristics, 5 m antenna cable with SMA round plug	<b>PSI-GSM/UMTS-ANT-OMNI-2-5</b>	2900982	1
<b>Antenna extension cable</b> for UMTS and quad-band GSM, 5 m long, antenna cable with SMA plug and SMA coupling	<b>PSI-CAB-GSM/UMTS- 5M</b>	2900980	1
<b>Antenna extension cable</b> for UMTS and quad-band GSM, 10 m long, antenna cable with SMA plug and SMA coupling	<b>PSI-CAB-GSM/UMTS-10M</b>	2900981	1
<b>Power supply unit</b> , primary-switched	<b>STEP-PS/ 1AC/24DC/0.75</b>	2868635	1
<b>USB connecting cable</b> (individual) for configuration	<b>CABLE-USB/MINI-USB-3,0M</b>	2986135	1
<b>Surge protection</b> for UMTS and quad-band GSM antenna, with SMA plug and SMA coupling	<b>CSMA-LAMBDA/4-2.0-BS-SET</b>	2800491	1

Accessories			
<b>Multi-band antenna</b> for UMTS and quad band GSM, with omnidirectional characteristic, 2 m antenna cable with SMA round plug, degree of protection: IP65, dimensions: 76 x 20 mm	<b>PSI-GSM/UMTS-QB-ANT</b>	2313371	1
<b>Multiband antenna</b> for external panel and external mast mounting for UMTS and quad-band GSM, with omnidirectional characteristics, 5 m antenna cable with SMA round plug	<b>PSI-GSM/UMTS-ANT-OMNI-2-5</b>	2900982	1
<b>Antenna extension cable</b> for UMTS and quad-band GSM, 5 m long, antenna cable with SMA plug and SMA coupling	<b>PSI-CAB-GSM/UMTS- 5M</b>	2900980	1
<b>Antenna extension cable</b> for UMTS and quad-band GSM, 10 m long, antenna cable with SMA plug and SMA coupling	<b>PSI-CAB-GSM/UMTS-10M</b>	2900981	1
<b>Power supply unit</b> , primary-switched	<b>STEP-PS/ 1AC/24DC/0.75</b>	2868635	1
<b>USB connecting cable</b> (individual) for configuration	<b>CABLE-USB/MINI-USB-3,0M</b>	2986135	1
<b>Surge protection</b> for UMTS and quad-band GSM antenna, with SMA plug and SMA coupling	<b>CSMA-LAMBDA/4-2.0-BS-SET</b>	2800491	1

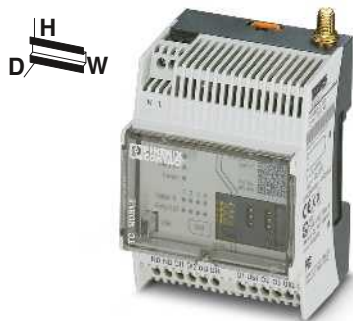

Communication via SMS and e-mail, with wide range power supply



Communication via ODP protocol, 2 additional analog inputs

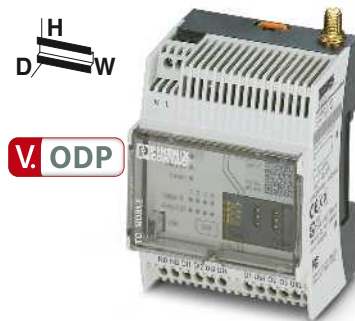

Communication via ODP protocol, with wide range power supply

Technical data
-
93 V AC ... 250 V AC (47.5 Hz ... 63 Hz)
30 mA (230 V AC)
10 mA (stand by)
USB 2.0
Mini-USB type B, 5-pos.
≤ 3 m (only for configuration and diagnostics)
850 MHz (2 W (EGSM))/900 MHz (2 W (EGSM))/1800 MHz (1 W (EGSM))/1900 MHz (1 W (EGSM))
4
-
-
-
-
4 x N/O contact
60 V
5 A
-25°C ... 70°C (for derating, see technical documentation)
EU, other countries in preparation
Conformance with EMC Directive 2004/108/EC
72 mm/90 mm/62 mm
Ex II 3 G Ex nA nC IIC T4 Gc X

Technical data
10 V DC ... 60 V DC
-
110 mA (24 V DC)
40 mA (stand by)
USB 2.0
Mini-USB type B, 5-pos.
≤ 3 m (only for configuration and diagnostics)
850 MHz (2 W (EGSM))/900 MHz (2 W (EGSM))/1800 MHz (1 W (EGSM))/1900 MHz (1 W (EGSM))
4
2
0 V DC ... 60 V DC/0 mA ... 20 mA/4 mA ... 20 mA (configurable)
15 bit
± 0.1%
4 x N/O contact
250 V AC
6 A
-25°C ... 70°C (for derating, see technical documentation)
EU, other countries in preparation
Conformance with EMC Directive 2004/108/EC
72 mm/90 mm/62 mm
Ex II 3 G Ex nA nC IIC T4 Gc X

Technical data
-
93 V AC ... 250 V AC (48 Hz ... 62 Hz)
30 mA (230 V AC)
10 mA (stand by)
USB 2.0
Mini-USB type B, 5-pos.
≤ 3 m (only for configuration and diagnostics)
850 MHz (2 W (EGSM))/900 MHz (2 W (EGSM))/1800 MHz (1 W (EGSM))/1900 MHz (1 W (EGSM))
4
-
-
-
-
4 x N/O contact
250 V AC
5 A
-25°C ... 70°C (for derating, see technical documentation)
EU, other countries in preparation
Conformance with EMC Directive 2004/108/EC
72 mm/90 mm/62 mm
Ex II 3 G Ex nA nC IIC T4 Gc X

Ordering data		
Type	Order No.	Pcs. / Pkt.
TC MOBILE I/O X200 AC	2903806	1

Ordering data		
Type	Order No.	Pcs. / Pkt.
TC MOBILE I/O X300	2903807	1

Ordering data		
Type	Order No.	Pcs. / Pkt.
TC MOBILE I/O X300 AC	2903808	1

Accessories		
Type	Order No.	Pcs. / Pkt.
PSI-GSM/UMTS-QB-ANT	2313371	1
PSI-GSM/UMTS-ANT-OMNI-2-5	2900982	1
PSI-CAB-GSM/UMTS- 5M	2900980	1
PSI-CAB-GSM/UMTS-10M	2900981	1
STEP-PS/ 1AC/24DC/0.75	2868635	1
CABLE-USB/MINI-USB-3,0M	2986135	1
CSMA-LAMBDA/4-2.0-BS-SET	2800491	1

Accessories		
Type	Order No.	Pcs. / Pkt.
PSI-GSM/UMTS-QB-ANT	2313371	1
PSI-GSM/UMTS-ANT-OMNI-2-5	2900982	1
PSI-CAB-GSM/UMTS- 5M	2900980	1
PSI-CAB-GSM/UMTS-10M	2900981	1
STEP-PS/ 1AC/24DC/0.75	2868635	1
CABLE-USB/MINI-USB-3,0M	2986135	1
CSMA-LAMBDA/4-2.0-BS-SET	2800491	1

Accessories		
Type	Order No.	Pcs. / Pkt.
PSI-GSM/UMTS-QB-ANT	2313371	1
PSI-GSM/UMTS-ANT-OMNI-2-5	2900982	1
PSI-CAB-GSM/UMTS- 5M	2900980	1
PSI-CAB-GSM/UMTS-10M	2900981	1
STEP-PS/ 1AC/24DC/0.75	2868635	1
CABLE-USB/MINI-USB-3,0M	2986135	1
CSMA-LAMBDA/4-2.0-BS-SET	2800491	1

**SUBCON-PLUS-M12-  
fast connection**

The new SUBCON-PLUS fast connection plugs with M12 connection ensure error-free installation of bus systems, thanks to the use of fully-tested components, such as cables and connection plugs.

The innovative housing concept is lightweight yet offers optimum mechanical protection against environmental influences. This means that the fast connection plugs are ideal, even in applications subject to vibration.

The unique SPEEDCON fast locking system on the M12 connections offers reliable connection with just half a turn.

**Features:**

- Easy startup, plug and play
- Error-free installation, particularly in standard machine production
- Quick connection thanks to M12-SPEEDCON fast locking system
- Low weight
- Termination using M12 termination resistor
- Adapter between IP20 and IP67 environments
- For PROFIBUS and CANopen® systems

General data	
Cable entry	90° (left)
Ambient temperature (operation)	-30°C ... 80°C
Degree of protection	IP40
Housing material	Polyamide
Number of positions	5
Termination resistor	(separately via M12 termination resistor)
SUBCON fixing	4-40 UNC 0.4 Nm
Dimensions	16 mm/41 mm/93 mm

Description	
<b>Fast connection plugs</b> , for PROFIBUS systems, Pin assignment 3, 5, 6, 8 - Standard version Pg version with programming connection	
<b>Fast connection plugs</b> , for CAN-based systems, Pin assignment 2, 3, 5, 7, 9 - Standard version Pg version with programming connection	

<b>PROFIBUS termination resistor</b> - M12 pin design - M12 socket design	
<b>PROFIBUS bus cable</b> , Straight socket, shielded, M12 B-coded, 2-pos., Straight pin, shielded, M12 B-coded, 2-pos. - Cable length 1 m - Variable cable length	
<b>DeviceNet™/CANopen® termination resistor</b> - M12 pin design - M12 socket design	
<b>DeviceNet™/CANopen® bus cable</b> , Straight socket, shielded, M12 A-coded, 5-pos., Straight pin, shielded, M12 A-coded, 5-pos. - Cable length 1 m - Variable cable length	

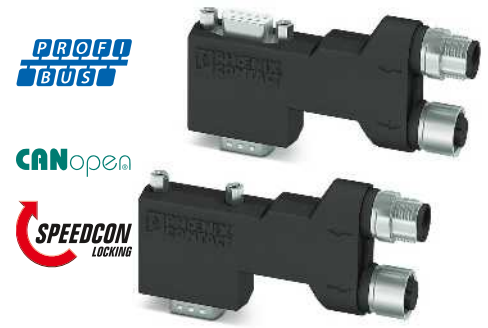

90° version, long,  
suitable for Siemens S7

**Technical data**

90° (left)
-30°C ... 80°C
IP40
Polyamide
5
(separately via M12 termination resistor)
4-40 UNC 0.4 Nm
16 mm/41 mm/93 mm

**Ordering data**

Type	Order No.	Pcs. / Pkt.
SUBCON-PLUS-PROFIB/90X/M12	2902729	1
SUBCON-PLUS-PROFIB/90X/PG/M12	2902728	1
SUBCON-PLUS-CAN/90X/M12	2902731	1
SUBCON-PLUS-CAN/90X/PG/M12	2902730	1

**Accessories**

SAC-5P-M12MS PB TR	1507803	5
SAC-5P-M12FS PB TR	1403911	1
SAC-2P-MSB/ 1,0-910/FSB SCO	1518122	1
SAC-2P-MSB-FSB SCO/910/...	1538092	1
SAC-5P-M12MS CAN TR	1507816	5
SAC-5P-M12FS CAN TR	1529344	5
SAC-5P-MS/ 1,0-920/FS SCO	1518274	1
SAC-5P-MS-FS SCO/920/...	1538157	1

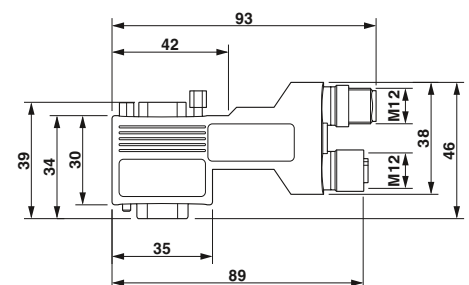

SUBCON-PLUS...90X...M12 dimensional drawing, long 90°  
version

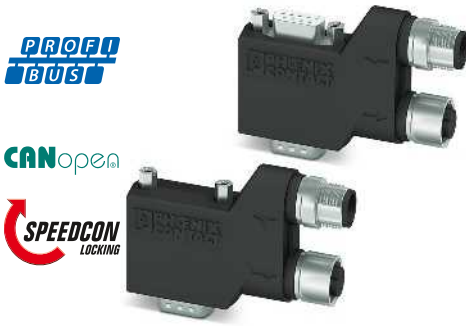

90° version, short, universal



35° version, universal

Technical data
90° (left)
-30°C ... 80°C
IP40
Polyamide
5
(separately via M12 termination resistor)
4-40 UNC 0.4 Nm
16 mm/41 mm/72 mm

Ordering data		
Type	Order No.	Pcs. / Pkt.
SUBCON-PLUS-PROFIB/90/M12	2902318	1
SUBCON-PLUS-PROFIB/90/PG/M12	2902317	1
SUBCON-PLUS-CAN/90/M12	2902323	1
SUBCON-PLUS-CAN/90/PG/M12	2902322	1

Accessories		
SAC-5P-M12MS PB TR	1507803	5
SAC-5P-M12FS PB TR	1403911	1
SAC-2P-MSB/ 1,0-910/FSB SCO	1518122	1
SAC-2P-MSB-FSB SCO/910/...	1538092	1
SAC-5P-M12MS CAN TR	1507816	5
SAC-5P-M12FS CAN TR	1529344	5
SAC-5P-MS/ 1,0-920/FS SCO	1518274	1
SAC-5P-MS-FS SCO/920/...	1538157	1

Technical data
35° (left)
-30°C ... 80°C
IP40
Polyamide
5
(separately via M12 termination resistor)
4-40 UNC 0.4 Nm
16 mm/48 mm /80 mm

Ordering data		
Type	Order No.	Pcs. / Pkt.
SUBCON-PLUS-PROFIB/35/M12	2902320	1
SUBCON-PLUS-PROFIB/35/PG/M12	2902319	1
SUBCON-PLUS-CAN/35/M12	2902325	1
SUBCON-PLUS-CAN/35/PG/M12	2902324	1

Accessories		
SAC-5P-M12MS PB TR	1507803	5
SAC-5P-M12FS PB TR	1403911	1
SAC-2P-MSB/ 1,0-910/FSB SCO	1518122	1
SAC-2P-MSB-FSB SCO/910/...	1538092	1
SAC-5P-M12MS CAN TR	1507816	5
SAC-5P-M12FS CAN TR	1529344	5
SAC-5P-MS/ 1,0-920/FS SCO	1518274	1
SAC-5P-MS-FS SCO/920/...	1538157	1

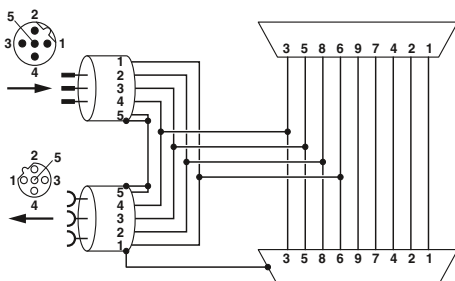

SUBCON-PLUS-PROFIB/...M12 function block diagram

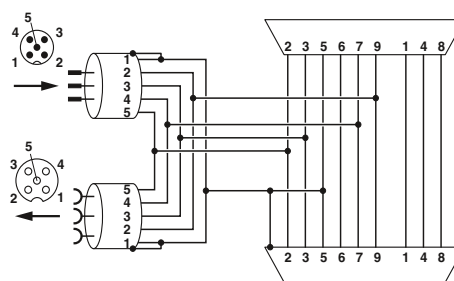

SUBCON-PLUS-CAN/...M12 function block diagram

**Wireless system for license-free use in Europe**

The RAD-868-IFS wireless module is suitable for license-free use in Europe.

**Features:**

- Trusted Wireless 2.0 wireless technology
- 868 MHz frequency band
- Adjustable transmission power up to 500 mW
- Range of up to several kilometers
- Integrated RS-232 and RS-485 interface
- Distribute signals at the turn of a switch (I/O mapping)
- Can be easily extended with up to 32 I/O extension modules via T-connector
- Optionally transmits I/O signals or serial data



**868 MHz wireless transceiver, can be extended with I/O extension modules**

Housing width 17.5 mm

<b>Wireless path</b>	
Direction	Bi-directional
Frequency range	869.4 MHz ... 869.65 MHz
Transmission power	≤ 500 mW (default setting, adjustable)
Security	128-bit data encryption
Connection method	RSMA (female)
<b>Serial port</b>	
Connection method	RS-232 COMBICON plug-in screw terminal block
Serial transmission speed	0.3 ... 115.2 kbit/s
Termination resistor (switchable via DIP switches)	-
<b>Analog output</b>	
Signal range	RSSI voltage output 0 V ... 3 V
<b>Digital output</b>	
Contact type	RF link relay output PDT
Switching voltage	30 V AC/60 V DC
Switching current	500 mA
<b>General data</b>	
Supply voltage	19.2 V DC ... 30.5 V DC
Degree of protection	IP20
Ambient temperature range	-40°C ... 70°C
Permissible humidity (operation)	20% ... 85%
Housing material	PA 6.6-FR
Dimensions W / H / D	17.5/99/114.5 mm
Screw connection solid / stranded / AWG	0.2 ... 2.5 mm <sup>2</sup> /0.2 ... 2.5 mm <sup>2</sup> /24 - 14
<b>Conformance / approvals</b>	
Conformance	CE compliance (R&TTE directive 1999/5/EC)
ATEX	Ex II 3 G Ex nA nC IIC T4 Gc X

**Technical data**

<b>RS-232</b>	
COMBICON plug-in screw terminal block	
0.3 ... 115.2 kbit/s	
-	
<b>RS-485</b>	
COMBICON plug-in screw terminal block	
0.3 ... 187.5 kbit/s	
390 Ω/150 Ω/390 Ω	

<b>RSSI voltage output</b>	
0 V ... 3 V	
<b>RF link relay output</b>	
PDT	
30 V AC/60 V DC	
500 mA	

<b>Supply voltage</b>	
19.2 V DC ... 30.5 V DC	
<b>Degree of protection</b>	
IP20	
<b>Ambient temperature range</b>	
-40°C ... 70°C	
<b>Permissible humidity (operation)</b>	
20% ... 85%	
<b>Housing material</b>	
PA 6.6-FR	
<b>Dimensions W / H / D</b>	
17.5/99/114.5 mm	
<b>Screw connection solid / stranded / AWG</b>	
0.2 ... 2.5 mm <sup>2</sup> /0.2 ... 2.5 mm <sup>2</sup> /24 - 14	

CE compliance (R&TTE directive 1999/5/EC)  
Ex II 3 G Ex nA nC IIC T4 Gc X

**Ordering data**

Description
<b>Wireless module</b>

Type	Order No.	Pcs. / Pkt.
<b>RAD-868-IFS</b>	<b>2904909</b>	1

**Accessories**

<b>Memory stick</b> , for saving custom configuration data
<b>USB cable</b> , for diagnostics and extended configuration

<b>RAD-MEMORY</b>	<b>2902828</b>	1
<b>RAD-CABLE-USB</b>	<b>2903447</b>	1



Device couplers for field devices

- Couple field devices and provide short-circuit current limiting
- Provide non-sparking and FISCO ic spur connections
- Single-sided connection configuration simplifies wiring in field housing
- Diagnostic LEDs indicate DC OK and errors at the spur connection
- Fulfills the requirements of EN 60079-0:2012, EN 60079-11:2012, EN 60079-15:2005, and EN 60079-15:2010.

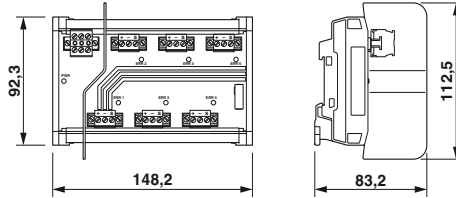

Device couplers for 6 and 12 spurs

Ex:

Technical data	
Supply	FB-6SP      FB-12SP
Supply voltage range	10.5 V DC ... 32 V DC (input on trunk line side)
Rated current	≤ 2 A
Nominal current consumption	4.8 mA      6.5 mA
Fieldbus interface	
Rated voltage	≤ 32 V (each spur)      ≤ 32 V (each spur)
Rated current	38 mA      38 mA
Termination resistor	100 Ω, external removable plug included
General data	FB-6SP      FB-12SP
Screw connection solid / stranded / AWG	0.2 - 2.5 mm <sup>2</sup> /0.2 - 2.5 mm <sup>2</sup> /24 - 12
Weight	240 g      395 g
Dimensions	W / H / D 148.2 mm/112.5 mm/83.5 mm      254.1 mm/112.5 mm/83.5 mm
Degree of protection	IP20
Ambient temperature (operation)	-50°C ... 90°C
Max. permissible relative humidity (operation)	< 95% (non-condensing)
Conformance / approvals	
NE	NE21
ATEX	Sira 13ATEX4247X;  Ex nA [ic] IIC T4 Gc, Entity/FISCO ic spurs Ex nA [nL] IIC T4 Gc;  Ex nA [ic] IIC T4 Gc, Entity/FISCO ic spurs; Ex nA [nL] IIC T4 Gc; Ex ic IIC T4 Gc, FISCO ic
IECEX	SIR 08.0110X; Ex nA [ic] IIC T4 Gc, Entity/FISCO ic spurs; Ex nA [nL] IIC T4 Gc; Ex ic IIC T4 Gc, FISCO ic
CSA, USA/Canada	Class I, Div. 2, Groups A, B, C, D; Ex nA [nL] IIC T4; Class I, Zone 2, AEx nA [nC] IIC T4
Fieldbus Foundation	FF-846

Ordering data			
Description	Type	Order No.	Pcs. / Pkt.
Device coupler, for Foundation Fieldbus and PROFIBUS PA			
- 6 spurs	FB-6SP	2316307	1
- 12 spurs	FB-12SP	2316310	1

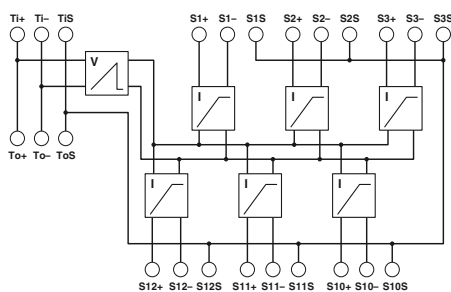

Connection diagram: FB-6SP

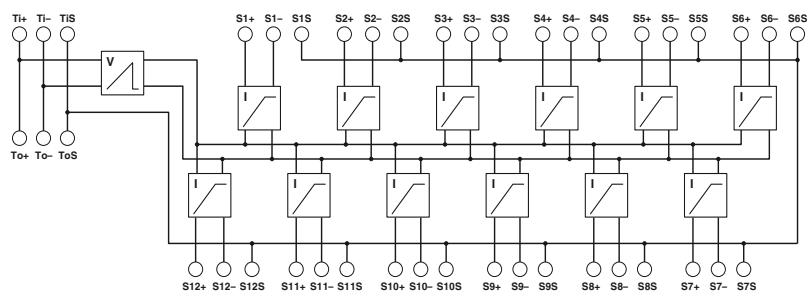

Connection diagram: FB-12SP

Functional Safety - safety switching devices

Multifunctional safety relays

You can easily implement three safety functions, such as emergency stop, safety door or light grid monitoring, with the PSR-MXF device range – and all using a single device.

In total, there are four function versions available each with three connection methods.

Features:

- Up to cat. 4/PL e according to EN ISO 13849-1
- Up to SIL 3 according to IEC 61508
- Up to SILCL 3 according to EN 62061
- Low housing width of only 22.5mm
- No software configuration required

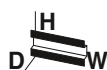

Screw connection



Spring-cage connection

△ FS

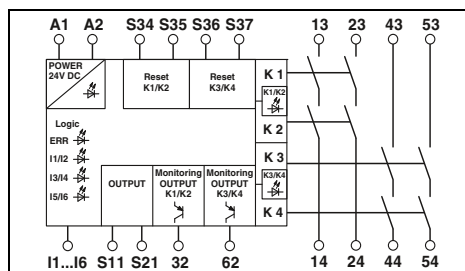

Technical data

Input data

Nominal input voltage  $U_N$   
Permissible range (with reference to  $U_N$ )  
Typ. current consumption (with reference to  $U_N$ )

24 V DC  
0.85 ... 1.1  
125 mA (with actuated relays)/55 mA (two-channel 24 V/0 V + max.  
200 mA control (message outputs 32/62) with non-actuated relays)

Recovery time

1 s (availability time after activation of sensor circuit: 100ms)

Output data

Contact type

Contact material  
Max./min. switching voltage  
Limiting continuous current

4 enabling current paths  
2 semiconductor alarm outputs  
AgCuNi, +0.2 -0.4  $\mu$ m Au  
250 V AC/DC/10 V AC/DC  
6 A (N/O contact), max. 100 mA (Alarm output (24 V DC))

Max./min. inrush current

Min. switching power  
Switching capacity (360/h cycles)  
Switching capacity (3600/h cycles)  
Short-circuit protection of the output circuits

6 A/10 mA  
0.1 W  
5 A (0.1 Hz; DC13; 24 V)  
3 A (AC15; 230 V)  
6 A gL/gG NEOZED (N/O contact),  
4 A gL/gG NEOZED (for low-demand applications)

General data

Ambient temperature range  
Air and creepage distances between the circuits  
Rated surge voltage/insulation

-20°C ... 45°C (see derating curve)  
DIN EN 50178/VDE 0160  
4 kV/basic isolation (safe isolation, reinforced insulation and 6 kV between input circuit, enabling current paths and safety circuit 1 (13/14, 23/24) and safety circuit 2 (43/44, 53/54).)

Dimensions

Screw connection Solid/stranded/AWG  
EMC note

W / H / D

22.5 mm/112.2 mm/114.5 mm  
0.2 - 2.5 mm<sup>2</sup>/0.2 - 2.5 mm<sup>2</sup>/24 - 12  
Class A product, see page 443

△ FS

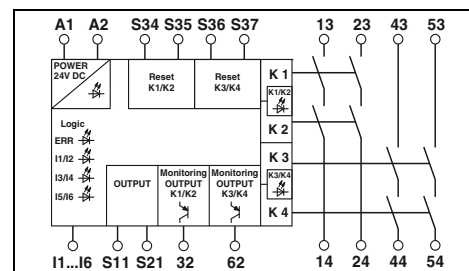

Technical data

24 V DC  
0.85 ... 1.1  
125 mA (with actuated relays)/55 mA (two-channel 24 V/0 V + max.  
200 mA control (message outputs 32/62) with non-actuated relays)

1 s (availability time after activation of sensor circuit: 100ms)

4 enabling current paths  
2 semiconductor alarm outputs  
AgCuNi, +0.2 -0.4  $\mu$ m Au  
250 V AC/DC/10 V AC/DC  
6 A (N/O contact), max. 100 mA (Alarm output (24 V DC))

6 A/10 mA  
0.1 W  
5 A (0.1 Hz; DC13; 24 V)  
3 A (AC15; 230 V)  
6 A gL/gG NEOZED (N/O contact),  
4 A gL/gG NEOZED (for low-demand applications)

-20°C ... 45°C (see derating curve)  
DIN EN 50178/VDE 0160  
4 kV/basic isolation (safe isolation, reinforced insulation and 6 kV between input circuit, enabling current paths and safety circuit 1 (13/14, 23/24) and safety circuit 2 (43/44, 53/54).)

22.5 mm/117.4 mm/114.5 mm  
0.2 - 1.5 mm<sup>2</sup>/0.2 - 1.5 mm<sup>2</sup>/24 - 16  
Class A product, see page 443

Ordering data

Description

**Multi-functional safety relay**, three safety functions, one and two-channel, two local shutdown levels

- Emergency stop and safety door monitoring
- Emergency stop and magnetic switch monitoring
- Emergency stop, safety door, and light grid monitoring
- Emergency stop, magnetic switch, and light grid monitoring

Type

Type	Order No.	Pcs. / Pkt.
PSR-SCP- 24DC/MXF1/4X1/2X2/B	2902725	1
PSR-SCP-24DC/MXF2/4X1/2X2/B	2903254	1
PSR-SCP-24DC/MXF3/4X1/2X2/B	2903257	1
PSR-SCP-24DC/MXF4/4X1/2X2/B	2903260	1

Ordering data

Type

Type	Order No.	Pcs. / Pkt.
PSR-SPP-24DC/MXF1/4X1/2X2/B	2902726	1
PSR-SPP-24DC/MXF2/4X1/2X2/B	2903255	1
PSR-SPP-24DC/MXF3/4X1/2X2/B	2903258	1
PSR-SPP-24DC/MXF4/4X1/2X2/B	2903261	1



Push-in connection

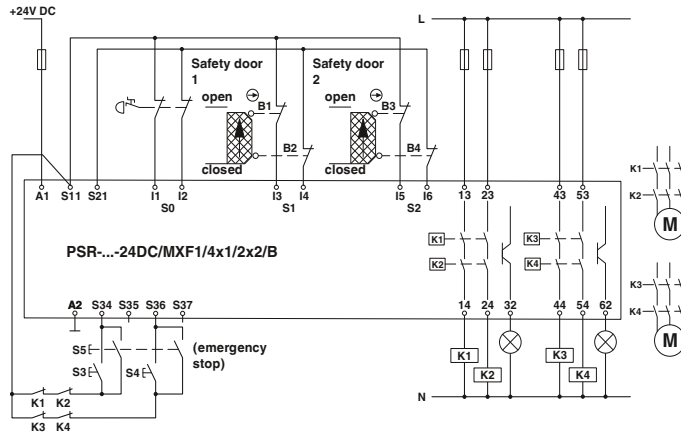

Emergency stop and safety door monitoring

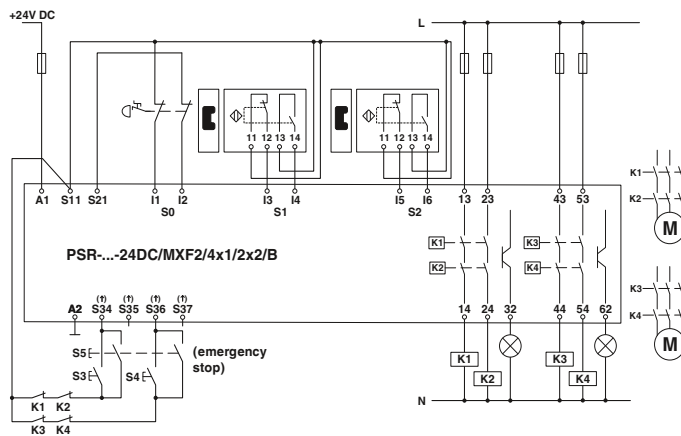

Emergency stop and magnetic switch monitoring

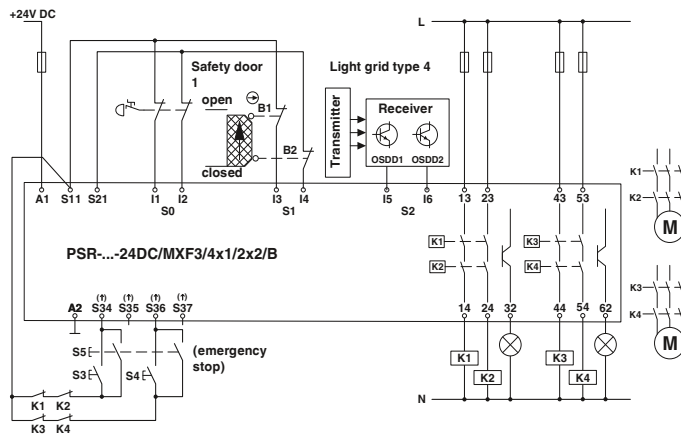

Emergency stop, safety door, and light grid monitoring

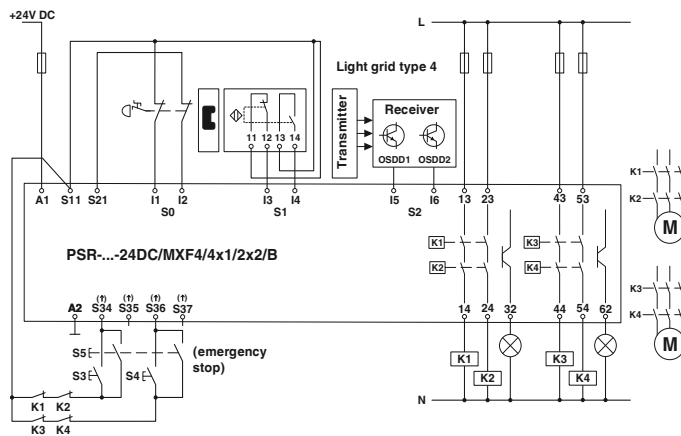

Emergency stop, magnetic switch, and light grid monitoring

FS

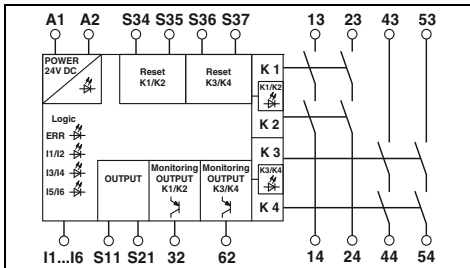

Technical data

24 V DC  
0.85 ... 1.1  
125 mA (with actuated relays)/55 mA (two-channel 24 V/0 V + max.  
200 mA control (message outputs 32/62) with non-actuated relays)

1 s (availability time after activation of sensor circuit: 100ms)

4 enabling current paths  
2 semiconductor alarm outputs  
AgCuNi, +0.2 -0.4 μm Au  
250 V AC/DC/10 V AC/DC  
6 A (N/O contact), max. 100 mA (Alarm output (24 V DC))

6 A/10 mA  
0.1 W  
5 A (0.1 Hz; DC13; 24 V)  
3 A (AC15; 230 V)  
6 A gL/gG NEOZED (N/O contact),  
4 A gL/gG NEOZED (for low-demand applications)

-20°C ... 45°C (see derating curve)  
DIN EN 50178/VDE 0160  
4 kV/basic isolation (safe isolation, reinforced insulation and 6 kV  
between input circuit, enabling current paths and safety circuit 1  
(13/14, 23/24) and safety circuit 2 (43/44, 53/54).)

22.5 mm/116.4 mm/114.5 mm  
0.2 - 2.5 mm<sup>2</sup>/0.2 - 2.5 mm<sup>2</sup>/24 - 12  
Class A product, see page 443

Ordering data

Type	Order No.	Pcs. / Pkt.
PSR-PIP-24DC/MXF1/4X1/2X2/B	2903253	1
PSR-PIP-24DC/MXF2/4X1/2X2/B	2903256	1
PSR-PIP-24DC/MXF3/4X1/2X2/B	2903259	1
PSR-PIP-24DC/MXF4/4X1/2X2/B	2903262	1

**PSR-TRISAFE modular**

The PSR-TS-SDOR4 is a safe relay extension module for the PSR-TRISAFE-M safety module. It makes additional configurable relay outputs available to the master module.

**Features:**

- Output extension for PSR-TRISAFE-M (modular)
- 4 single-channel relay outputs or (configurable via SAFECONF) 2 two-channel relay outputs
- 4 signal outputs
- Slim 22.5 mm housing
- Including PSR-TBUS DIN rail connector for adapting to the PSR-TRISAFE-M master module
- Up to cat. 4/PL e according to EN ISO 13849-1
- Up to SIL 3 according to IEC 61508
- Up to SILCL 3 according to EN 62061

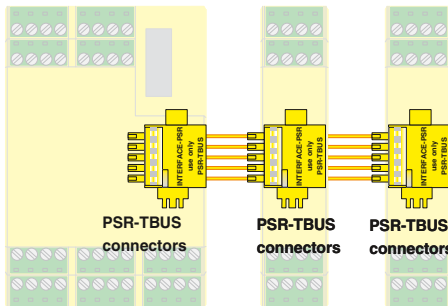

PSR-TBUS DIN rail connectors are used for cross-wiring between the modules.



Extension module with 4 relay outputs

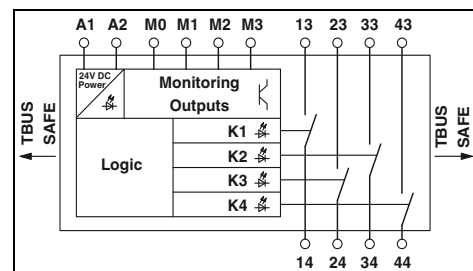

<b>Module data</b>	
Nominal input voltage $U_N$	24 V DC (via PSR-TBUS)
Permissible range (with reference to $U_N$ )	0.85 ... 1.1
Typ. current consumption (with reference to $U_N$ )	120 mA
Interfaces	
<b>Output data</b>	
Contact type	
Contact material	
Max./min. switching voltage	
Limiting continuous current	
Max./min. inrush current	
Min. switching power	
Switching capacity (3600/h cycles)	
Short-circuit protection of the output circuits	
Response time	
Alarm outputs	
<b>General data</b>	
Ambient temperature range	
Screw connection solid/stranded/AWG	
Spring-cage connection (solid/stranded/AWG)	
Dimensions	Screw version
W / H / D	Spring-cage version
EMC note	

<b>Technical data</b>		
24 V DC (via PSR-TBUS)		
0.85 ... 1.1		
120 mA		
DIN rail TBUS for connection to the master module, supplied as standard		
4 enabling current paths		
AgCuNi, + 0.2 μm Au		
250 V AC/5 V AC/DC		
4 A (see derating curve)		
6 A/5 mA		
60 mW		
3 A (230 V (AC 15)); 5 A (24 V (DC13))		
6 A gL/gG		
Max. 50 ms		
4		
-20°C ... 55°C		
0.2 - 2.5 mm <sup>2</sup> /0.2 - 2.5 mm <sup>2</sup> /24 - 12		
0.2 - 1.5 mm <sup>2</sup> /0.2 - 1.5 mm <sup>2</sup> /24 - 16		
22.5 mm/99 mm/114.5 mm		
22.5 mm/112 mm/114.5 mm		
Class A product, see page 443		

<b>Description</b>
<b>Extension module</b> , 4 relay outputs (1-channel) or 2 relay outputs (2-channel)
With screw connection
With spring-cage connection

<b>Ordering data</b>		
<b>Type</b>	<b>Order No.</b>	<b>Pcs. / Pkt.</b>
PSR-SCP- 24DC/TS/SDOR4/4X1	2986096	1
PSR-SPP- 24DC/TS/SDOR4/4X1	2986106	1

<b>Freely configurable master module</b> , for monitoring emergency stops, safety doors, light grids, etc., with 20 safe inputs and 4 safe outputs, 4 alarm outputs and 2 clock outputs, safe and standard extension, including memory stick and PSR-TBUS DIN rail connector
With screw connection
With spring-cage connection
<b>PSR-TBUS DIN rail connector</b> , for supplying/controlling/monitoring (depending on the module)

<b>Accessories</b>		
<b>PSR-SCP- 24DC/TS/M</b>	2986012	1
<b>PSR-SPP- 24DC/TS/M</b>	2986025	1
<b>PSR-TBUS</b>	2890425	50



Safe I/O modules

You can install the safety-related Axioline F PROFIsafe I/O modules anywhere inside an Axioline station. In addition to standard signals, this means you can now also read and output safe signals in the Axioline system.

Depending on the installation and parameterization, you can achieve the following safety characteristics with these modules:

- Up to cat. 4/PL e according to EN ISO 13849-1
- Up to SIL 3 according to IEC 61508
- Up to SILCL 3 according to EN 62061

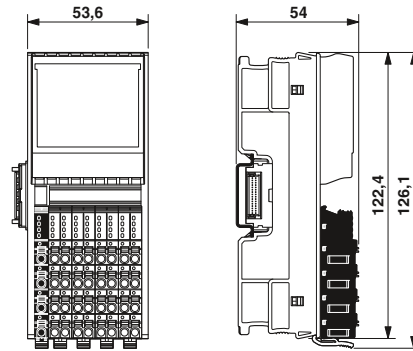

Digital input module

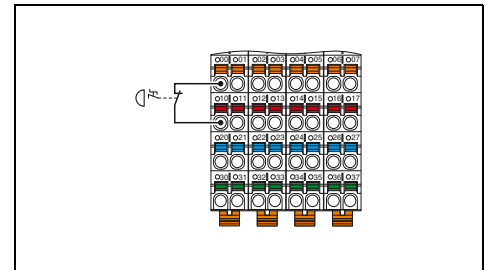

Technical data

Local bus interface	Axioline F local bus
Name	Bus base module
Connection method	
Power supply for module electronics	
Communications power $U_{Bus}$	5 V DC (via bus base module)
Current consumption from $U_{Bus}$	Typ. 280 mA (Normal operation)
I/O supply	
Supply of digital input modules $U_i$	24 V DC
Supply voltage range $U_i$	19.2 V DC ... 30.2 V DC (including all tolerances, including ripple)
Current consumption from $U_i$	Typ. 40 mA (when using the appropriate clock supply)
Protective circuit	Protection against polarity reversal, EMC protective circuit, undervoltage detection
Digital inputs	
Connection method	2, 3, 4-wire
Number of inputs	4 (with two-channel assignment) 8 (for single-channel assignment)
Description of the inputs	IEC 61131-2 type 3
Nominal input voltage $U_{IN}$	24 V DC
Nominal input current at $U_{IN}$	Typ. 4.2 mA
Input filter time	1.5 ms 3 ms (default) 5 ms 15 ms
General data	
Connection method	Direct plug-in technology
Connection data solid / stranded / AWG	0.2 ... 1.5 mm <sup>2</sup> /0.2 ... 1.5 mm <sup>2</sup> /24 - 16
Weight	220 g
Width	53.6 mm
Height	126.1 mm
Depth	54 mm
Ambient temperature (operation)	-35°C ... 60°C (mounting position: any)

Ordering data

Description	Type	Order No.	Pcs. / Pkt.
<b>Fail-safe digital input module</b>			
- 4 inputs (two-channel), 8 inputs (single-channel)	<b>AXL F PSDI8/4 1F</b>	<b>2701559</b>	<b>1</b>

Safe I/O modules

You can install the safety-related Axioline F PROFI-safe I/O modules anywhere inside an Axioline station. In addition to standard signals, this means you can now also read and output safe signals in the Axioline system.

Depending on the installation and parameterization, you can achieve the following safety characteristics with these modules:

- Up to cat. 4/PL e according to EN ISO 13849-1
- Up to SIL 3 according to IEC 61508
- Up to SILCL 3 according to EN 62061

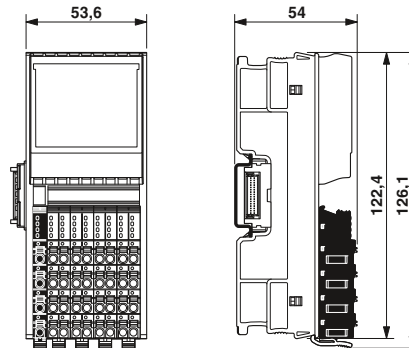

Digital output module

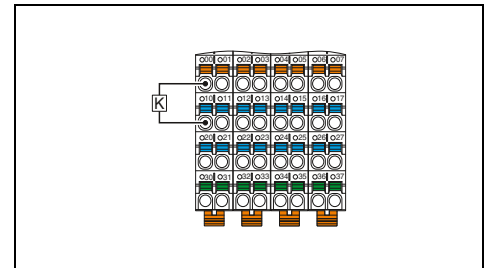

Technical data	
Local bus interface	
Name	Axioline F local bus
Connection method	Bus base module
Power supply for module electronics	
Communications power $U_{Bus}$	5 V DC (via bus base module)
Current consumption from $U_{Bus}$	Typ. 260 mA (Normal operation)
I/O supply	
Supply of digital output modules $U_o$	24 V DC
Supply voltage range $U_o$	19.2 V DC ... 30.2 V DC (including all tolerances, including ripple)
Current consumption from $U_o$	Typ. 26 mA (all outputs set including actuator current)
Protective circuit	Protection against polarity reversal, EMC protective circuit, undervoltage detection
Digital outputs	
Connection method	2, 3-wire
Number of outputs	4 (with two-channel assignment) 8 (for single-channel assignment)
Output voltage	24 V DC
Maximum output current per channel	2 A
Maximum output current per module / terminal block	8 A
Behavior with overload	Affected output is disabled and a diagnostic message is generated.
Protective circuit	Overload protection, freewheeling circuit for inductive loads, Discharge circuit for accelerated discharge of capacitive loads
General data	
Connection method	Direct plug-in technology
Connection data solid / stranded / AWG	0.2 ... 1.5 mm <sup>2</sup> /0.2 ... 1.5 mm <sup>2</sup> /24 - 16
Weight	220 g
Width	53.6 mm
Height	126.1 mm
Depth	54 mm
Ambient temperature (operation)	-35°C ... 60°C (mounting position: any)

Ordering data		
Type	Order No.	Pcs. / Pkt.
AXL F PSD08/3 1F	2701560	1

Description
<b>Fail-safe digital output module</b>
- 4 outputs (two-channel), 8 outputs (single-channel)

Safe analog value processing

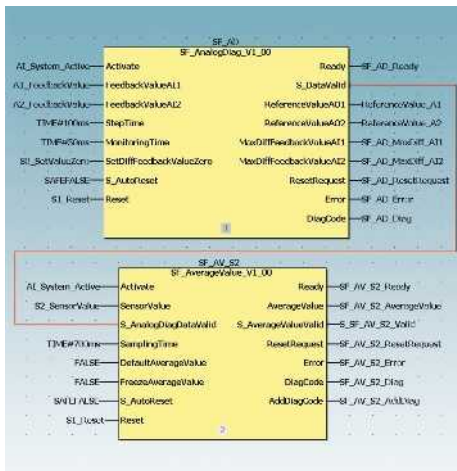

Wherever analog values need to be processed in a safety-related manner, the Safe AI solution package from Phoenix Contact is the ideal solution. With this TÜV-certified and software-based analog value processing, no safety-related I/O modules are required. This saves you money and offers flexibility.

**Components of the Safe AI solution package:**

- Initial application advice via telephone on the required software and hardware components
- License key for using the ANALOGINPUT\_SF function block library including user documentation
- Advice from the Competence Center Safety in the form of a web meeting

**24-hour safety hotline**

+49 5281 9-462777  
safety-service@phoenixcontact.com

Description
Function block library for safety-related analog acquisition with standard I/O modules

Ordering data		
Type	Order No.	Pcs. / Pkt.
SAFE AI	2400057	1





Bus couplers

The Axioline F bus coupler is the link between the Axioline F system and the higher-level third-generation Sercos network.

For startup tests, the Axioline F station can be started up independently of the higher-level network via either the service interface or an Ethernet port on the bus coupler using the Startup+ software.

Features:

- Sercos specification V1.3
- Minimum Sercos cycle time of 31.25 μs
- Two rotary encoding switches for address assignment
- 2 RJ45 connections (with integrated switch)
- Up to 63 additional Axioline devices can be connected
- Typical cycle time of the Axioline F local bus is around 10 μs
- Runtime in bus coupler is negligible (almost 0 μs)
- FSP-IO (Function Specific Profile-IO) for modular I/O devices
- Firmware can be updated
- Diagnostic and status indicators

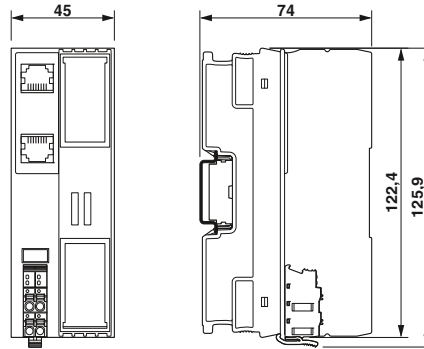

**sercos**  
the automation bus



Sercos III bus coupler

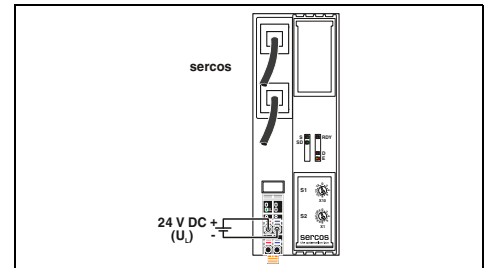

Technical data

Interface	
Fieldbus system	Sercos
Connection method	RJ45 socket, auto negotiation and auto crossing
Number	2
Transmission speed	100 Mbps (full duplex)
Transmission length	Max. 100 m
Network/bus system	
Device profile	FSP_IO
Equipment type	Sercos slave
Update rate	31.25 μs
Local bus interface	
Name	Axioline F local bus
Connection method	Bus base module
Transmission speed	100 Mbps
Number of supported devices	Max. 63 (per station)
Power supply for module electronics	
Supply of communications power U <sub>L</sub>	24 V DC
Maximum permissible voltage range	19.2 V DC ... 30 V DC (including all tolerances, including ripple)
Communications power U <sub>Bus</sub>	
Current supply at U <sub>Bus</sub>	5 V DC (via bus base module)
Protective circuit	2 A
General data	
Connection method	Push-in technology
Connection data solid / stranded / AWG	0.2 ... 1.5 mm <sup>2</sup> /0.2 ... 1.5 mm <sup>2</sup> /24 - 16
Weight	177 g

Sercos	
RJ45 socket, auto negotiation and auto crossing	
2	
100 Mbps (full duplex)	
Max. 100 m	
FSP_IO	
Sercos slave	
31.25 μs	
Axioline F local bus	
Bus base module	
100 Mbps	
Max. 63 (per station)	
24 V DC	
19.2 V DC ... 30 V DC (including all tolerances, including ripple)	
5 V DC (via bus base module)	
2 A	
Surge protection of the supply voltage	
Polarity reversal protection of the supply voltage	

Description
<b>Axioline bus coupler</b> - For Sercos

Ordering data		
Type	Order No.	Pcs. / Pkt.
<b>AXL F BK S3</b>	<b>2701686</b>	<b>1</b>

<b>Axioline bus base module</b> (replacement part)
--

Accessories		
<b>AXL BS BK</b>	<b>2701422</b>	<b>5</b>

### Bus coupler

The Axioline F bus coupler is the link between the Axioline F system and the higher-level Ethernet system.

The new version of the device features web-based management. It can be used to access static information (e.g., technical data, MAC address, IP address) or dynamic information (e.g., IP address, status information).

For startup tests, the Axioline F station can be started up independently of the higher-level network via either the service interface or an Ethernet port on the bus coupler using the Startup+ software.

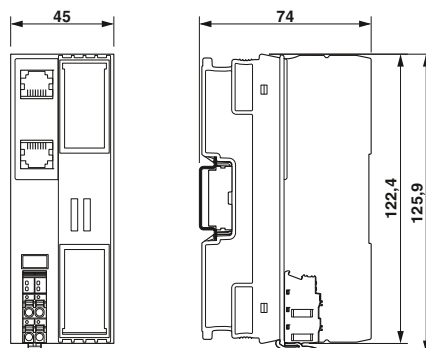

PROFINET bus coupler



#### Features:

- PROFINET RT and PROFINET IRT support
- Minimum cycle time of PROFINET for RT and IRT is 250 μs
- Module replacement without software possible
- 2 RJ45 connections (with integrated switch)
- Up to 63 additional Axioline devices can be connected
- Typical cycle time of the Axioline F local bus is around 10 μs
- MRP client
- Shared device
- Firmware can be updated
- Diagnostic and status indicators

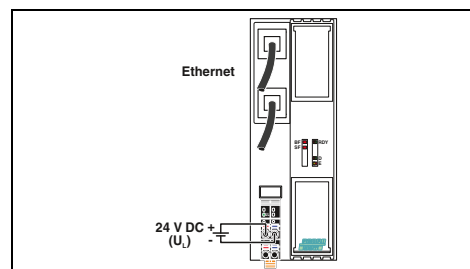

<b>Interface</b>	
Fieldbus system	PROFINET
Connection method	RJ45 socket, auto negotiation and autocrossing
Number	2
Transmission speed	100 Mbps (full duplex)
Transmission length	Max. 100 m
<b>Local bus interface</b>	
Name	Axioline F local bus
Connection method	Bus base module
Transmission speed	100 Mbps
Number of supported devices	Max. 63 (per station)
<b>Power supply for module electronics</b>	
Supply of communications power $U_L$	24 V DC
Maximum permissible voltage range	19.2 V DC ... 30 V DC (including all tolerances, including ripple)
Communications power $U_{Bus}$	5 V DC (via bus base module)
Current supply at $U_{Bus}$	2 A
Protective circuit	Surge protection of the supply voltage Polarity reversal protection of the supply voltage
<b>General data</b>	
Connection method	Push-in technology
Connection data solid / stranded / AWG	0.2 ... 1.5 mm <sup>2</sup> /0.2 ... 1.5 mm <sup>2</sup> /24 - 16
Weight	177 g

#### Technical data

<b>Technical data</b>	
PROFINET	PROFINET
RJ45 socket, auto negotiation and autocrossing	RJ45 socket, auto negotiation and autocrossing
2	2
100 Mbps (full duplex)	100 Mbps (full duplex)
Max. 100 m	Max. 100 m
<b>Local bus interface</b>	
Axioline F local bus	Axioline F local bus
Bus base module	Bus base module
100 Mbps	100 Mbps
Max. 63 (per station)	Max. 63 (per station)
<b>Power supply for module electronics</b>	
24 V DC	24 V DC
19.2 V DC ... 30 V DC (including all tolerances, including ripple)	19.2 V DC ... 30 V DC (including all tolerances, including ripple)
<b>Local bus interface</b>	
5 V DC (via bus base module)	5 V DC (via bus base module)
2 A	2 A
Surge protection of the supply voltage	Surge protection of the supply voltage
Polarity reversal protection of the supply voltage	Polarity reversal protection of the supply voltage
<b>General data</b>	
Push-in technology	Push-in technology
0.2 ... 1.5 mm <sup>2</sup> /0.2 ... 1.5 mm <sup>2</sup> /24 - 16	0.2 ... 1.5 mm <sup>2</sup> /0.2 ... 1.5 mm <sup>2</sup> /24 - 16
177 g	177 g

<b>Description</b>
<b>Axioline bus coupler</b> - For PROFINET

#### Ordering data

Type	Order No.	Pcs. / Pkt.
AXL F BK PN	2701815	1

<b>Axioline bus base module</b> (replacement part)
--

#### Accessories

AXL BS BK	2701422	5
-----------	---------	---

Digital input and output modules

This module is designed for use within an Axioline F station.

It is used to acquire and output digital data.

You can adjust the filter times of the inputs to increase noise immunity. Filter times of 100 µs enable you to implement a counting function with a maximum input frequency of 5 kHz in the application.

Features:

- 8 digital inputs and 8 digital outputs
- 24 V DC, 500 mA
- Connection of sensors or actuators in single-wire technology
- Minimum update time < 100 µs, bus synchronous
- Filter times can be set in three increments: < 100 µs, 1000 µs or 3000 µs
- Maximum input frequency: 5 kHz
- Short-circuit-proof outputs
- Stored device rating plate
- Diagnostic and status indicators

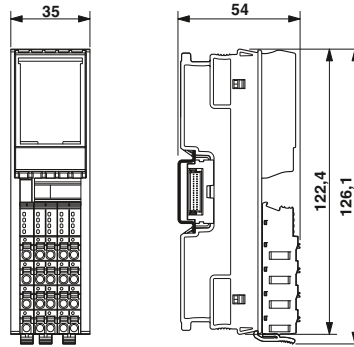

8 digital inputs and 8 digital outputs

BSH

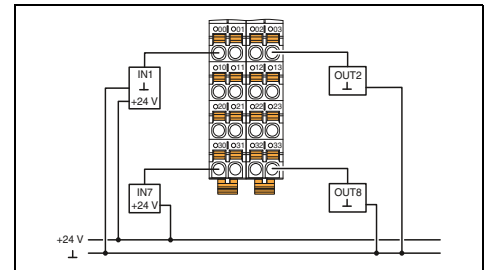

Technical data

Local bus interface	Axioline F local bus
Name	Bus base module
Connection method	
Power supply for module electronics	5 V DC (via bus base module)
Communications power U <sub>Bus</sub>	Max. 120 mA
Current consumption from U <sub>Bus</sub>	
I/O supply	24 V DC
Digital input and output module supply U <sub>IO</sub>	
Supply voltage range U <sub>IO</sub>	19.2 V DC ... 30 V DC (including all tolerances, including ripple)
Protective circuit	Surge protection of the supply voltage Polarity reversal protection of the supply voltage
Digital inputs	1-wire
Connection method	8
Number of inputs	EN 61131-2 types 1 and 3
Description of the inputs	24 V DC
Nominal input voltage U <sub>IN</sub>	2.4 mA
Nominal input current at U <sub>IN</sub>	< 100 µs
Input filter time	1000 µs
	3000 µs (default)
Protective circuit	Polarity reversal protection of the inputs
Digital outputs	1-wire
Connection method	8
Maximum number of outputs	24 V
Output voltage	500 mA
Maximum output current per channel	4 A (external fuse)
Maximum output current per module	Shutdown with automatic restart
Behavior with overload	Short-circuit protection, overload protection of the outputs
Protective circuit	
General data	Push-in technology
Connection method	0.2 ... 1.5 mm <sup>2</sup> /0.2 ... 1.5 mm <sup>2</sup> /24 - 16
Connection data solid / stranded / AWG	133 g
Weight	35 mm
Width	126.1 mm
Height	54 mm
Depth	Class A product, see page 443
EMC note	

Ordering data

Type	Order No.	Pcs. / Pkt.
AXL F DI8/1 DO8/1 1H	2701916	1

Accessories

AXL F BS H	2700992	5
------------	---------	---

Description	Axioline digital input/output module, complete with accessories (bus base module) - 8 inputs, 8 outputs
Axioline bus base module (replacement part)	

**Analog input modules**

This module is designed for use within an Axioline F station.

It is used to acquire standard analog voltage signals. Connection is via 2, 3 or 4-wire technology and a shield connection.

**Features:**

- 4 analog differential signal inputs
- Voltage measuring ranges
- Input filter selection
- Minimum update time of 250 µs, bus synchronous
- 16-bit measured value representation
- Stored device rating plate
- Integrated sensor supply
- Diagnostic and status indicators

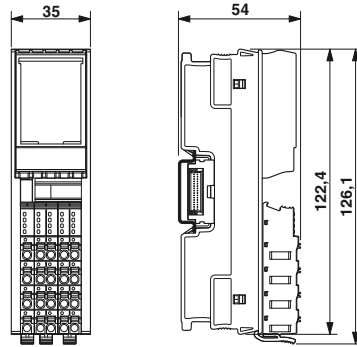

**4 analog inputs  
Voltage signals**

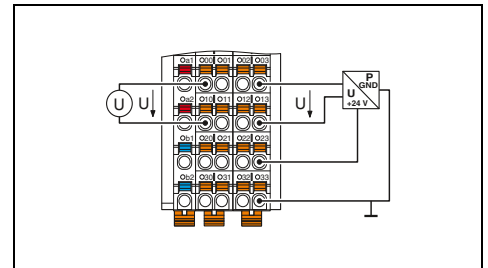

Local bus interface	
Name	Axioline F local bus
Connection method	Bus base module
Power supply for module electronics	
Communications power U <sub>Bus</sub>	5 V DC (via bus base module)
Current consumption from U <sub>Bus</sub>	Max. 150 mA
I/O supply	
Supply of analog modules U <sub>A</sub>	24 V DC
Protective circuit	Surge protection Protection against polarity reversal Transient protection
Analog inputs	
Connection method	2, 3, 4-wire (shielded)
Number of inputs	Max. 4 (differential inputs, voltage)
Voltage input signal	0 V ... 5 V/-5 V ... 5 V/0 V ... 10 V/-10 V ... 10 V
Characteristics	
Measured value representation	16 bits (15 bits + sign bit)
Input filter	30 Hz, 12 kHz and mean-value generation (can be parameterized)
Precision	0.1% (of measuring range final value for active mean-value generation and 30 Hz filter)
General data	
Connection method	Push-in technology
Connection data solid / stranded / AWG	0.2 ... 1.5 mm <sup>2</sup> /0.2 ... 1.5 mm <sup>2</sup> /24 - 16
Weight	145 g

**Technical data**

**Ordering data**

Description	Type	Order No.	Pcs. / Pkt.
<b>Axioline analog input module</b> , complete with accessories (bus base module) - 4 inputs	<b>AXL F AI4 U 1H</b>	<b>2688501</b>	<b>1</b>

**Accessories**

<b>Axioline bus base module</b> (replacement part)	<b>AXL F BS H</b>	<b>2700992</b>	<b>5</b>
<b>Axioline shield connection set</b>	<b>AXL SHIELD SET</b>	<b>2700518</b>	<b>1</b>

Analog input modules

This module is designed for use within an Axioline F station.

It is used to acquire standard analog current signals. Connection is via 2, 3 or 4-wire technology and a shield connection.

Features:

- 4 analog differential signal inputs
- Current measuring ranges
- Input filter selection
- Minimum update time of 250 µs, bus synchronous
- 16-bit measured value representation
- Stored device rating plate
- Integrated sensor supply
- Diagnostic and status indicators

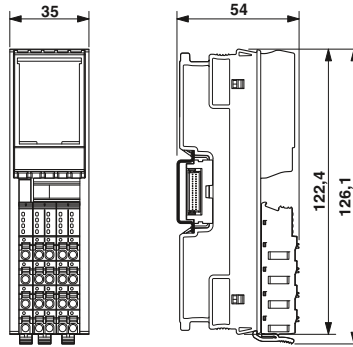

4 analog inputs  
Current signals

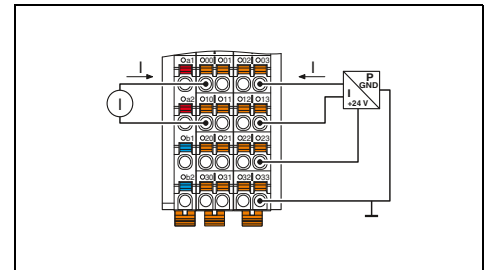

<b>Local bus interface</b>	
Name	Axioline F local bus
Connection method	Bus base module
<b>Power supply for module electronics</b>	
Communications power $U_{Bus}$	5 V DC (via bus base module)
Current consumption from $U_{Bus}$	Max. 150 mA
<b>I/O supply</b>	
Supply of analog modules $U_A$	24 V DC
Protective circuit	Surge protection Protection against polarity reversal Transient protection
<b>Analog inputs</b>	
Connection method	2, 3, 4-wire (shielded)
Number of inputs	Max. 4 (differential inputs, current)
Current input signal	0 mA ... 20 mA/4 mA ... 20 mA/-20 mA ... 20 mA
<b>Characteristics</b>	
Measured value representation	16 bits (15 bits + sign bit)
Input filter	30 Hz, 12 kHz and mean-value generation (can be parameterized)
Precision	0.1% (of measuring range final value for active mean-value generation and 30 Hz filter)
<b>General data</b>	
Connection method	Push-in technology
Connection data solid / stranded / AWG	0.2 ... 1.5 mm <sup>2</sup> /0.2 ... 1.5 mm <sup>2</sup> /24 - 16
Weight	145 g

Technical data

<b>Technical data</b>	
Axioline F local bus	
Bus base module	
5 V DC (via bus base module)	
Max. 150 mA	
24 V DC	
Surge protection	
Protection against polarity reversal	
Transient protection	
2, 3, 4-wire (shielded)	
Max. 4 (differential inputs, current)	
0 mA ... 20 mA/4 mA ... 20 mA/-20 mA ... 20 mA	
16 bits (15 bits + sign bit)	
30 Hz, 12 kHz and mean-value generation (can be parameterized)	
0.1% (of measuring range final value for active mean-value generation and 30 Hz filter)	
Push-in technology	
0.2 ... 1.5 mm <sup>2</sup> /0.2 ... 1.5 mm <sup>2</sup> /24 - 16	
145 g	

<b>Description</b>	
Axioline analog input module, complete with accessories (bus base module)	
- 4 inputs	

Ordering data

Type	Order No.	Pcs. / Pkt.
AXL F AI4 I 1H	2688491	1

Axioline bus base module (replacement part)	AXL F BS H	2700992	5
Axioline shield connection set	AXL SHIELD SET	2700518	1

Accessories

Axioline bus base module (replacement part)	AXL F BS H	2700992	5
Axioline shield connection set	AXL SHIELD SET	2700518	1

**Analog output modules**

This module is designed for use within an Axioline F station.

The module is used to output standard analog current and voltage signals. It is connected using 2-wire technology and a shield connection.

**Features:**

- 4 analog outputs
- Bipolar voltage outputs, Unipolar current outputs
- Minimum update time of 250 μs, bus synchronous
- 16-bit output value
- Overload and short-circuit protected
- Stored device rating plate
- Diagnostic and status indicators

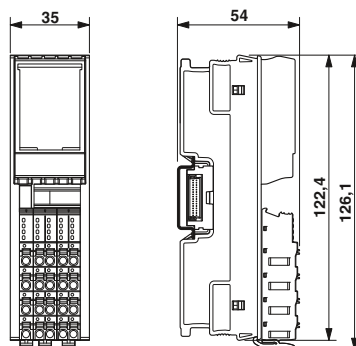

**4 analog outputs  
Current/voltage signals**

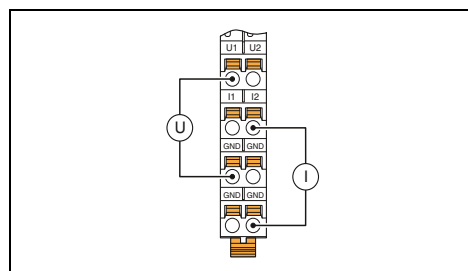

Local bus interface	
Name	Axioline F local bus
Connection method	Bus base module
Power supply for module electronics	
Communications power $U_{bus}$	5 V DC (via bus base module)
Current consumption from $U_{bus}$	Max. 150 mA
I/O supply	
Supply of analog modules $U_A$	24 V DC
Analog outputs	
Connection method	2-wire (shielded, twisted pair)
Number of outputs	4
Voltage output signal	0 V ... 5 V/-5 V ... 5 V/0 V ... 10 V/-10 V ... 10 V
Current output signal	0 mA ... 20 mA/4 mA ... 20 mA
Load/output load current output	to 500 Ω
Protective circuit	Short-circuit and overload protection Transient protection
Characteristics	
Representation of output values	16 bits (15 bits + sign)
Precision	Typ. 0.1% (of output range final value)
General data	
Connection method	Push-in technology
Connection data solid / stranded / AWG	0.2 ... 1.5 mm <sup>2</sup> /0.2 ... 1.5 mm <sup>2</sup> /24 - 16
Weight	145 g

**Technical data**

**Ordering data**

Description	Type	Order No.	Pcs. / Pkt.
<b>Axioline analog output module</b> , complete with accessories (bus base module) - 4 outputs	<b>AXL F AO4 1H</b>	<b>2688527</b>	<b>1</b>

**Accessories**

<b>Axioline bus base module</b> (replacement part)	<b>AXL F BS H</b>	<b>2700992</b>	<b>5</b>
<b>Axioline shield connection set</b>	<b>AXL SHIELD SET</b>	<b>2700518</b>	<b>1</b>

Temperature recording modules

This module is designed for use within an Axioline F station.

It is used to record resistive temperature sensors. Connection is via 2, 3 or 4-wire technology and a shield connection.

**RTD features:**

- 4 inputs for temperature shunts
- 500 Ω and 5 kΩ linear inputs
- Programmable filters
- Short-circuit-proof inputs
- Stored device rating plate

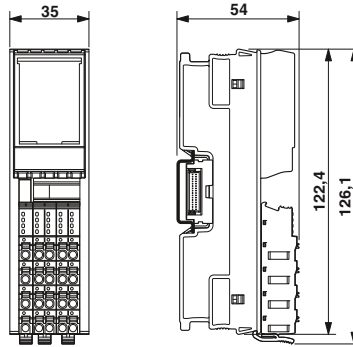

4 RTD inputs

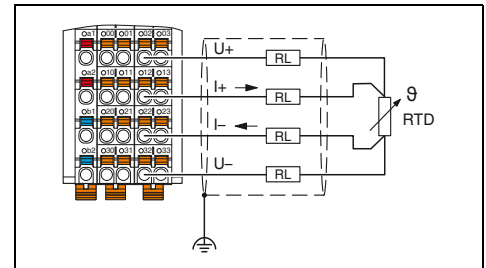

**Technical data**

Local bus interface	Axioline F local bus
Name	Bus base module
Connection method	
Power supply for module electronics	5 V DC (via bus base module)
Communications power $U_{Bus}$	Max. 140 mA
Current consumption from $U_{Bus}$	
I/O supply	24 V DC
Supply of analog modules $U_A$	Surge protection
Protective circuit	Protection against polarity reversal
	Transient protection
Analog inputs	2, 3, 4-wire (shielded)
Connection method	4 (for resistance temperature detectors)
Number of inputs	Short-circuit protection, overload protection of the inputs
Protective circuit	Transient protection of inputs
	Transient protection of sensor supplies
Sensor types (RTD) that can be used	Pt, Ni, KTY, Cu sensors
Linear resistance measuring range	0 Ω ... 500 Ω/0 kΩ ... 5 kΩ
Characteristics	16 bits (15 bits + sign bit)
Measured value representation	40 ms/60 ms/100 ms/120 ms (adjustable)
Input filter time	Typ. ± 0.1 K (Pt100 with 3-wire termination)
Accuracy	
General data	Push-in technology
Connection method	0.2 ... 1.5 mm <sup>2</sup> /0.2 ... 1.5 mm <sup>2</sup> /24 - 16
Connection data solid / stranded / AWG	144 g
Weight	

**Ordering data**

Type	Order No.	Pcs. / Pkt.
<b>AXL F RTD4 1H</b>	<b>2688556</b>	1

**Accessories**

<b>Axioline bus base module</b> (replacement part)	<b>AXL F BS H</b>	2700992	5
<b>Axioline shield connection set</b>	<b>AXL SHIELD SET</b>	2700518	1



Temperature recording modules

This module is designed for use within an Axioline F station.

It is used to acquire data from thermocouples. Connection is via 2-wire technology and a shield connection.

Features of UTH:

- 4 inputs for thermocouples
- Linear voltages from -100 mV to +100 mV
- 1 input from -5 V to +5 V
- 2 Pt 100 inputs (external cold junction)
- Configurable cold junction type
- Stored device rating plate

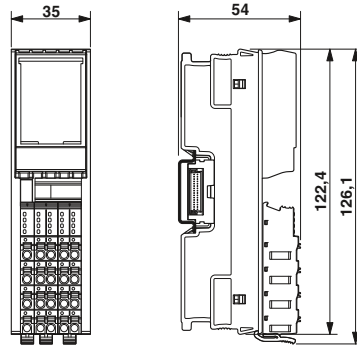

4 UTH inputs

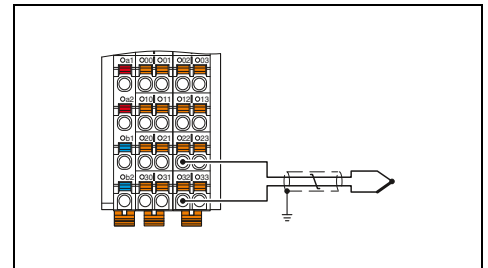

Technical data	
Local bus interface	
Name	Axioline F local bus
Connection method	Bus base module
Power supply for module electronics	
Communications power $U_{Bus}$	5 V DC (via bus base module)
Current consumption from $U_{Bus}$	Max. 40 mA
I/O supply	
Supply of analog modules $U_A$	24 V DC
Protective circuit	Surge protection of the supply voltage Polarity reversal protection of the supply voltage Transient protection
Analog inputs	
Connection method	2-wire (shielded, twisted pair)
Number of inputs	4 + 1 (4 inputs for thermocouples or linear voltage, plus 1 input -5 V to +5 V)
Protective circuit	Short-circuit protection, overload protection of the inputs Transient protection of inputs
Sensor types (RTD) that can be used	Pt 100 (2 external cold junctions, can also be used as a sensor input)
Linear voltage range	-100 mV ... 100 mV
Characteristics	
Measured value representation	16 bits (15 bits + sign bit)
Input filter time	40 ms/60 ms/100 ms/120 ms (adjustable)
Accuracy	Typ. $\pm 0.19$ K (Thermocouple type K, plus tolerance of cold junction)
General data	
Connection method	Push-in technology
Connection data solid / stranded / AWG	0.2 ... 1.5 mm <sup>2</sup> /0.2 ... 1.5 mm <sup>2</sup> /24 - 16
Weight	144 g
Ordering data	
Description	
<b>Axioline analog input module</b> , complete with accessories (bus base module)	
- 4 inputs for connection of thermocouple sensors	
<b>Axioline bus base module</b> (replacement part)	<b>AXL F BS H</b> 2700992 5
<b>Axioline shield connection set</b>	<b>AXL SHIELD SET</b> 2700518 1
Accessories	
<b>Axioline bus base module</b> (replacement part)	<b>AXL F BS H</b> 2700992 5
<b>Axioline shield connection set</b>	<b>AXL SHIELD SET</b> 2700518 1

**M-bus master terminal**

The Inline terminal is designed for use within an Inline station.

It enables communication with standard M-bus counters according to EN 13757.

**Features:**

- M-bus connection for up to 30 devices
- Transmission speed can be set from 300 baud to 19,200 baud
- Parameterization via process data
- Process data width: 16 words
- Diagnostic and status indicators

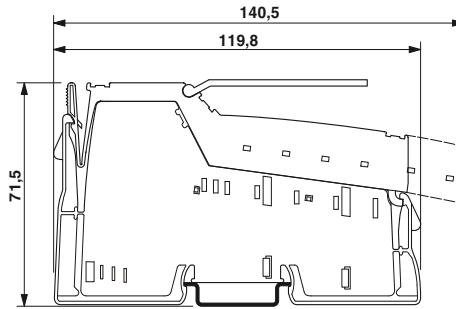

**M-bus master**

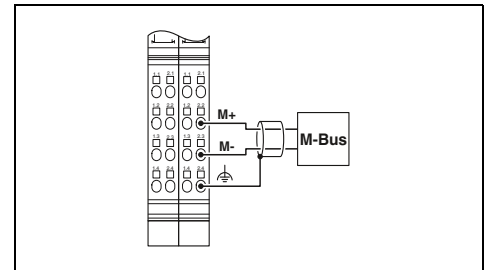

Local bus interface
Connection method
Communication interface
Interface
Connection method
Power supply for module electronics
Communications power $U_L$
Current consumption from $U_L$
General data
Connection method
Connection data solid / stranded / AWG
Weight
Width
Ambient temperature (operation)

Technical data	
Inline data jumper	
M-Bus	
Inline plugs	
7.5 V (via potential jumper)	
Typ. 65 mA	
Spring-cage connection	
0.08 ... 1.5 mm <sup>2</sup> /0.08 ... 1.5 mm <sup>2</sup> /28 - 16	
125 g	
24.4 mm	
-25°C ... 55°C	

Description
<b>Inline Modular communication terminal</b> , complete with accessories (connector plug and labeling field)
- for the connection of M-bus devices

Ordering data		
Type	Order No.	Pcs. / Pkt.
<b>IB IL MBUS-PAC</b>	<b>2701927</b>	<b>1</b>



HMIs and industrial PCS - HMIs

HMIs for maritime applications

HMI devices for maritime applications are the reliable and robust solution for demanding applications on ships. The touch panels are specifically tested and approved for shipbuilding.

Your advantages:

- Tested quality - certified according to GL, LR, BV, DNV, and ABS
- Flexible communication, even with third-party systems, thanks to numerous drivers
- Save costs and increase service life, thanks to LED backlighting that can be adjusted directly via buttons
- Increase system availability, thanks to temperature and voltage monitoring
- Save costs for acoustic signaling devices: integrated buzzer
- Global use: additional fonts are easy to install
- Cost-effective solution, since there are no additional costs for SCADA runtime: unlimited runtime license for Visu+ RT and AX OPC Server included



17.8 cm (7") TFT color display

<b>Display data</b>
Display
Monitor resolution
Display lighting type
Brightness
Display backlight MTBF
Color spectrum
Touch screen
<b>Computer data</b>
Operating systems
Processor
RAM
Mass storage
Interfaces
Network
<b>External dimensions</b>
Width
Height
Depth
<b>Installation dimensions</b>
Width
Height
Installation depth
<b>General data</b>
Degree of protection
Ambient temperature (operation)
Mounting type
Vibration (operation)
Shock
EMC note

Technical data	
17.8 cm/7" TFT	
800 x 480 pixels (WVGA)	
LED	
350 cd/m <sup>2</sup> , typical (adjustable)	
50000 h	
65,536 colors	
Resistive industrial touch screen	
Windows CE 6.0	
Xscale® PXA320, 806 MHz	
128 MByte SDRAM	
1 GB Flash	
2x USB Host 1.1, 1x Compact Flash®	
1 x Ethernet (10/100 Mbps), RJ45	
203 mm	
165 mm	
5 mm	
195 mm	
157 mm	
56 mm	
IP65 (front), IP20 (back)	
0°C ... 55°C	
Installation in front plate	
DIN EN 60068-2-6	
DIN EN 60068-2-27	
Class A product, see page 443	

Description
<b>Touch panel</b> with graphics-capable display, for maritime applications

Ordering data		
Type	Order No.	Pcs. / Pkt.
TP 07T/M 211	2701452	1

<b>Stylus</b> for touch screens
<b>USB Flash memory</b>
<b>CMOS battery</b>
<b>Mounting kit</b> , including hardware for installation
- panel installation
<b>Protective foil</b> for touch screen

Accessories		
Type	Order No.	Pcs. / Pkt.
TOUCH PEN	2701379	1
2 GB USB STICK	2701382	1
HMI BATTERY	2701383	1
HMI SCB MOUNTING KIT 6	2701385	1
7" DISPLAY PROTECTIVE FOIL	2701374	1



26.4 cm (10.4") TFT color display



30.7 cm (12.1") TFT color display



38.1 cm (15") color TFT display

Technical data
26.4 cm/10.4" TFT
640 x 480 pixels (VGA)
LED
350 cd/m <sup>2</sup> , typical (adjustable)
50000 h
65,536 colors
Resistive industrial touch screen
Windows CE 6.0
Xscale® PXA320, 806 MHz
128 MByte SDRAM
1 GB Flash
2x USB Host 1.1, 1x Compact Flash®
1 x Ethernet (10/100 Mbps), RJ45
328 mm
265 mm
5 mm
303 mm
238 mm
57 mm
IP65 (front), IP20 (back)
0°C ... 55°C
Installation in front plate
DIN EN 60068-2-6
DIN EN 60068-2-27
Class A product, see page 443

Technical data
30.7 cm/12.1" TFT
800 x 600 pixels (SVGA)
LED
300 cd/m <sup>2</sup> , typical (adjustable)
50000 h
65,536 colors
Resistive industrial touch screen
Windows CE 6.0
Xscale® PXA320, 806 MHz
128 MByte SDRAM
1 GB Flash
2x USB Host 1.1, 1x Compact Flash®
1 x Ethernet (10/100 Mbps), RJ45
340 mm
285 mm
5 mm
315 mm
259 mm
62 mm
IP65 (front), IP20 (back)
0°C ... 55°C
Installation in front plate
DIN EN 60068-2-6
DIN EN 60068-2-27
Class A product, see page 443

Technical data
38.1 cm/15" TFT
1024 x 768 pixels (XGA)
LED
480 cd/m <sup>2</sup>
50000 h
256 colors
Resistive industrial touch screen
Windows CE 6.0
Xscale® PXA320, 806 MHz
128 MByte SDRAM
1 GB Flash
2x USB Host 1.1, 1x Compact Flash®
1 x Ethernet (10/100 Mbps), RJ45
400 mm
338 mm
5 mm
373 mm
312 mm
62 mm
IP65 (front), IP20 (back)
0°C ... 55°C
Installation in front plate
DIN EN 60068-2-6
DIN EN 60068-2-27
Class A product, see page 443

Ordering data		
Type	Order No.	Pcs. / Pkt.
TP 10T/M 211	2701843	1

Ordering data		
Type	Order No.	Pcs. / Pkt.
TP 12T/M 211	2701844	1

Ordering data		
Type	Order No.	Pcs. / Pkt.
TP 15T/M 211	2701845	1

Accessories		
	Order No.	Pcs. / Pkt.
TOUCH PEN	2701379	1
2 GB USB STICK	2701382	1
HMI BATTERY	2701383	1
HMI SCB MOUNTING KIT 8	2701387	1
10,4" DISPLAY PROTECTIVE FOIL	2701376	1

Accessories		
	Order No.	Pcs. / Pkt.
TOUCH PEN	2701379	1
2 GB USB STICK	2701382	1
HMI BATTERY	2701383	1
HMI SCB MOUNTING KIT 8	2701387	1
12,1" DISPLAY PROTECTIVE FOIL	2701377	1

Accessories		
	Order No.	Pcs. / Pkt.
TOUCH PEN	2701379	1
2 GB USB STICK	2701382	1
HMI BATTERY	2701383	1
HMI SCB MOUNTING KIT 8	2701387	1
15,1" DISPLAY PROTECTIVE FOIL	2701378	1

Box PCs

Box PCs are compact and flexible. They can be used in a wide variety of applications such as measurement, control and process testing. The compact size and numerous mounting options also work well for distributed systems with remote monitors.

Features:

- High system availability thanks to a fanless design or convection booster, suitable for industrial applications and absence of moving parts
- 3rd generation of Intel® Celeron® and Core™ i7 processors
- Versatile use, thanks to various mounting options, e.g., on the DIN rail
- Large-scale compatibility with open IT standards, numerous interfaces and operating system options



Box PC for DIN rail or wall mounting

Computer data	
Processor	Intel® Celeron® N2920 2.0 GHz
RAM (configuration option)	2 GB DDR3 SODIMM 4 GB DDR3 SODIMM
Mass storage (configuration option)	
	CompactFlash® 2.5" SATA hard drive 2.5" SATA solid-state drive
Interfaces	
	1x USB 3.0 1x COM (RS-232/422/485) 2x COM (RS-232) 3x USB 2.0
Network	
Power supply unit	2x Ethernet (10/100/1000 Mbps), RJ45 24 V DC ±20%
General data	
Width	162 mm
Height	146.2 mm
Depth	49 mm
Degree of protection	IP20
Ambient temperature (operation)	0°C ... 50°C
Permissible humidity (operation)	5% ... 95% (non-condensing)
Mounting type	Wall or DIN rail
Vibration (operation)	DIN EN 60068-2-6
Shock	15g, 11 ms in accordance with IEC 60068-2-27

Technical data

Technical data		
Computer data		
Processor	Intel® Celeron® N2920 2.0 GHz	
RAM (configuration option)	2 GB DDR3 SODIMM 4 GB DDR3 SODIMM	
Mass storage (configuration option)		
	CompactFlash® 2.5" SATA hard drive 2.5" SATA solid-state drive	
Interfaces		
	1x USB 3.0 1x COM (RS-232/422/485) 2x COM (RS-232) 3x USB 2.0	
Network		
Power supply unit	2x Ethernet (10/100/1000 Mbps), RJ45 24 V DC ±20%	
General data		
Width	162 mm	
Height	146.2 mm	
Depth	49 mm	
Degree of protection	IP20	
Ambient temperature (operation)	0°C ... 50°C	
Permissible humidity (operation)	5% ... 95% (non-condensing)	
Mounting type	Wall or DIN rail	
Vibration (operation)	DIN EN 60068-2-6	
Shock	15g, 11 ms in accordance with IEC 60068-2-27	

Description	
<b>Industrial computer</b>	
- Configurable	
<b>Industrial computer</b>	
- Preconfigured with 2 GB RAM, no mass storage or operating system	
- Preconfigured with 4 GB RAM, no mass storage or operating system	

Ordering data

Type	Order No.	Pcs. / Pkt.
BL BPC 2000	2701712	1
BL BPC 2001	2701711	1



Box PC for wall mounting



High-performance box PC for wall mounting

Technical data
Intel® Celeron® 1020E 2.2 GHz
4 GB DDR3 SODIMM
8 GB DDR3 SODIMM
16 GB DDR3 SODIMM
CompactFlash®
2.5" SATA hard drive
2.5" SATA solid-state drive
4x USB 2.0
1x COM (RS-232/422/485)
2x COM (RS-232)
2x Ethernet (10/100/1000 Mbps), RJ45
24 V DC ±20%
357 mm
190 mm
87 mm
IP20
0°C ... 45°C
5% ... 95% (non-condensing)
Wall mount
DIN EN 60068-2-6
15g, 11 ms in accordance with IEC 60068-2-27

Technical data
Intel® Core™ i7-3555LE 3.2 GHz
4 GB DDR3 SODIMM
8 GB DDR3 SODIMM
16 GB DDR3 SODIMM
CompactFlash®
2.5" SATA hard drive
2.5" SATA solid-state drive
4x USB 2.0
1x COM (RS-232/422/485)
2x COM (RS-232)
2x Ethernet (10/100/1000 Mbps), RJ45
24 V DC ±20%
357 mm
190 mm
87 mm
IP20
0°C ... 45°C
5% ... 95% (non-condensing)
Wall mount
DIN EN 60068-2-6
15g, 11 ms in accordance with IEC 60068-2-27

Ordering data		
Type	Order No.	Pcs. / Pkt.
BL BPC 3000	2400082	1
BL BPC 3001	2400080	1

Ordering data		
Type	Order No.	Pcs. / Pkt.
BL BPC 7000	2400083	1
BL BPC 7001	2400081	1

HMI and industrial PCs - industrial PCs

Panel PCs

Panel PCs combine the advantages of a modern industrial PC with the operation and monitoring functions of a touch screen monitor. Typically installed in the front of the control cabinet, they provide monitoring and control directly on site.

Features:

- High system availability thanks to a fanless design or convection booster, suitable for industrial applications and absence of moving parts
- 3rd generation of Intel® Celeron® and Core™ i7 processors
- Large-scale compatibility with open IT standards, numerous interfaces and operating system options
- Display sizes from 12 (SVGA) to 17 (SXGA) inches
- High graphic performance with Intel HD graphics 4000



Panel PC with Atom™ processor

<b>Display data</b>	
Display (configuration option)	
<b>Monitor resolution</b>	
Brightness	
Display backlight MTBF	
Touch screen	
<b>Computer data</b>	
Processor (configuration option)	
RAM (configuration option)	
<b>Mass storage (configuration option)</b>	
<b>Interfaces</b>	
Network	
Power supply unit	
<b>General data</b>	
Degree of protection	
Ambient temperature (operation)	
Permissible humidity (operation)	
Mounting type	
Vibration (operation)	
Shock	
EMC note	

Technical data	
30.7 cm/12.1" TFT	
38.1 cm/15" TFT	
43.2 cm/17"-TFT	
800 x 600 pixels (SVGA)	
1024 x 768 pixels (XGA)	
1280 x 1024 pixels (SXGA)	
350 cd/m <sup>2</sup> , typical (adjustable)	
> 50000 h	
Resistive industrial touch screen	
Intel® Atom™ N455 1.66 GHz	
2 GB DDR3 SODIMM	
CompactFlash®	
2.5" SATA hard drive	
2.5" SATA solid-state drive	
4x USB 2.0	
1x COM (RS-232/422/485)	
2x COM (RS-232)	
2x Ethernet (10/100/1000 Mbps), RJ45	
24 V DC ±20%	
IP65 (front), IP20 (back)	
0°C ... 50°C	
5% ... 95% (non-condensing)	
Panel PC for mounting in the front panel	
DIN EN 60068-2-6	
15g, 11 ms in accordance with IEC 60068-2-27	
Class A product, see page 443	

Description
<b>Industrial panel PC (PPC)</b> with resistive touch screen. Configurable options for display size, memory and mass storage.
- Atom processor
- Celeron processor
- Core i7 processor
<b>Industrial panel PC (PPC)</b> with resistive touch screen.
- Preconfigured with 12.1-inch display, 2 GB RAM, no mass storage or operating system
- Preconfigured with 15-inch display, 2 GB RAM, no mass storage or operating system
- Preconfigured with 17-inch display, 2 GB RAM, no mass storage or operating system
- Preconfigured with 15-inch display, 4 GB RAM, no mass storage or operating system
- Preconfigured with 17-inch display, 4 GB RAM, no mass storage or operating system

Ordering data		
Type	Order No.	Pcs. / Pkt.
<b>BL PPC 1000</b>	<b>2701401</b>	1
<b>BL PPC12 1000</b>	<b>2701336</b>	1
<b>BL PPC15 1000</b>	<b>2701338</b>	1
<b>BL PPC17 1000</b>	<b>2701337</b>	1





Panel PC with Celeron® processor



Panel PC with Core™ i7 processor

Technical data
38.1 cm/15" TFT 43.2 cm/17"-TFT
1024 x 768 pixels (XGA) 1280 x 1024 pixels (SXGA)
350 cd/m <sup>2</sup> , typical (adjustable) > 50000 h Resistive industrial touch screen
Intel® Celeron® 1020E 2.2 GHz 4 GB DDR3 SODIMM 8 GB DDR3 SODIMM 16 GB DDR3 SODIMM CompactFlash® 2.5" SATA hard drive 2.5" SATA solid-state drive 4x USB 2.0 1x COM (RS-232/422/485) 2x COM (RS-232) 2x Ethernet (10/100/1000 Mbps), RJ45 24 V DC ±20%
IP65 (front), IP20 (back) 0°C ... 45°C 5% ... 95% (non-condensing) Panel PC for mounting in the front panel DIN EN 60068-2-6 15g, 11 ms in accordance with IEC 60068-2-27 Class A product, see page 443

Technical data
38.1 cm/15" TFT 43.2 cm/17"-TFT
1024 x 768 pixels (XGA) 1280 x 1024 pixels (SXGA)
350 cd/m <sup>2</sup> , typical (adjustable) > 50000 h Resistive industrial touch screen
Intel® Core™ i7-3555LE 3.2 GHz 4 GB DDR3 SODIMM 8 GB DDR3 SODIMM 16 GB DDR3 SODIMM CompactFlash® 2.5" SATA hard drive 2.5" SATA solid-state drive 4x USB 2.0 1x COM (RS-232/422/485) 2x COM (RS-232) 2x Ethernet (10/100/1000 Mbps), RJ45 24 V DC ±20%
IP65 (front), IP20 (back) 0°C ... 45°C 5% ... 95% (non-condensing) Panel PC for mounting in the front panel DIN EN 60068-2-6 15g, 11 ms in accordance with IEC 60068-2-27 Class A product, see page 443

Ordering data		
Type	Order No.	Pcs. / Pkt.
BL PPC 3000	2701397	1
BL PPC15 3000	2701393	1
BL PPC17 3000	2701394	1

Ordering data		
Type	Order No.	Pcs. / Pkt.
BL PPC 7000	2701398	1
BL PPC15 7000	2701395	1
BL PPC17 7000	2701396	1

Outdoor panel PCs

The new outdoor panel PCs fit seamlessly into the existing portfolio of panel PCs. Designed for use under extreme ambient conditions, the devices meet the requirements for an extended temperature range, easily readable displays in direct sunlight, UV resistance, and a high level of mechanical and chemical resistance.

**Additional features:**

- Display can be read in direct sunlight
- Resistant to UV and IR radiation
- Extended temperature range
- Watertight thanks to IP67 protection
- Resistant to environmental influences, such as salt spray and termites
- Resistant to chemicals, e.g., aggressive cleaning agents, deicers for aircraft
- Can be operated when wearing work gloves



17.8 cm (7") widescreen display

<b>Display data</b>
Display
Monitor resolution
Display lighting type
Brightness
Display backlight MTBF
Touch screen
<b>Computer data</b>
Processor
RAM
Mass storage (configuration option)
<b>Interfaces</b>
Slots
Monitor output
Network
Power supply unit
<b>General data</b>
Degree of protection
Ambient temperature (operation)
Permissible humidity (operation)
Mounting type
Vibration (operation)
Shock

Technical data	
17.8 cm/7" TFT	800 x 400 pixels (WVGA)
LED	350 cd/m <sup>2</sup> , typical (adjustable)
> 50000 h	Resistive industrial touch screen (GFG)
Intel® Atom™ E680T 1.6 GHz	2 GB DDR2 800
Flash SSD 8 GB	Flash SSD 16 GB
Flash SSD 32 GB	4 x USB host 2.0
SD card	Without
1 x Ethernet (10/100/1000 Mbps), RJ45	24 V DC ±20%
IP67 (front), IP20 (back)	-20°C ... 65°C
20% ... 85% (non-condensing)	Installation in front plate
DIN EN 60068-2-6	DIN EN 60068-2-27

<b>Description</b>
<b>Panel PC for outdoor applications</b>

Ordering data		
Type	Order No.	Pcs. / Pkt.
EL PPC7 1000/WT	2400065	1



30.5 cm (12.1") display



38.1 cm (15") display

Technical data
30.7 cm/12.1" TFT
800 x 600 pixels (SVGA)
LED
350 cd/m <sup>2</sup> , typical (adjustable)
> 50000 h
Resistive industrial touch screen (GFG)
Intel® Atom™ E680T 1.6 GHz
2 GB DDR2 800
Flash SSD 8 GB
Flash SSD 16 GB
Flash SSD 32 GB
4 x USB host 2.0
SD card
Without
1 x Ethernet (10/100/1000 Mbps), RJ45
24 V DC ±20%
IP67 (front), IP20 (back)
-20°C ... 65°C
20% ... 85% (non-condensing)
Installation in front plate
DIN EN 60068-2-6
DIN EN 60068-2-27

Technical data
38.1 cm/15" TFT
1024 x 768 pixels (XGA)
LED
350 cd/m <sup>2</sup> , typical (adjustable)
> 50000 h
Resistive industrial touch screen (GFG)
Intel® Atom™ E680T 1.6 GHz
2 GB DDR2 800
Flash SSD 8 GB
Flash SSD 16 GB
Flash SSD 32 GB
4 x USB host 2.0
SD card
Without
1 x Ethernet (10/100/1000 Mbps), RJ45
24 V DC ±20%
IP67 (front), IP20 (back)
-20°C ... 65°C
20% ... 85% (non-condensing)
Installation in front plate
DIN EN 60068-2-6
DIN EN 60068-2-27

Ordering data		
Type	Order No.	Pcs. / Pkt.
EL PPC12 1000/WT	2400066	1

Ordering data		
Type	Order No.	Pcs. / Pkt.
EL PPC15 1000/WT	2400067	1

**IP65 panel PCs**

Designline 7000 IPCs are powerful panel PCs that utilize Intel® Core™ i7 processors. The fanless design and completely enclosed IP65 housing makes the Designline 7000 suitable for demanding industrial applications. VESA 100 mounting allows installation directly on a machine or system for an integrated, attractive appearance.

**Features:**

- 4th generation Intel Core i7 processors
- Projected capacitive touch screen (PCT)
- 15-inch XGA to 21.5-inch displays with Intel HD graphics 5000
- Fanless for clean, quiet operation
- Slim, attractive design
- All-in-one, IP65-rated design
- Conforms to VESA MIS-D, 100 mounting standard

**Notes:**  
 1) Configuration options can affect the operating temperature. See data sheet for details.



**Fully enclosed IP65 IPC with 38.1 cm (15") display**

<b>Display data</b>	
Display	38.1 cm/15" TFT
Monitor resolution	1024 x 768 pixels (XGA)
Display lighting type	LED
Brightness	400 cd/m <sup>2</sup> , typical (adjustable)
Display backlight MTBF	> 50000 h
Touch screen	Capacitive multi-touch screen
<b>Computer data</b>	
Processor	Intel®Core™ i7-4650U 3.30 GHz
RAM (configuration option)	4 GB DDR3 8 GB DDR3 12 GB DDR3
Mass storage (configuration option)	2.5" SATA hard drive 2.5" SATA solid-state drive
<b>Interfaces</b>	
Network	4x USB 2.0, 1x USB 3.0 1x COM (RS-232/422/485) 1x Audio 2x Ethernet (10/100/1000 Mbps), RJ45
Power supply unit	24 V DC ±20%
<b>General data</b>	
Degree of protection	IP65
Ambient temperature (operation)	0°C ... 45°C <sup>1)</sup>
Permissible humidity (operation)	5% ... 95% (non-condensing)
Mounting type	VESA MIS-D (100 x 100)
Vibration (operation)	1g with SSD, 0.5g with HDD, according to EN 60068-2-6
Shock	15g, 11 ms in accordance with IEC 60068-2-27

**Technical data**

<b>Ordering data</b>		
<b>Type</b>	<b>Order No.</b>	<b>Pcs. / Pkt.</b>
<b>DL PPC15M 7000</b>	<b>2400017</b>	<b>1</b>

<b>Description</b>
<b>High performance IPC with touch screen and IP65 housing</b>
- 38.1 cm (15") display
- 47 cm (18.5") display
- 54.6 cm (21.5") display

**Ordering data**

<b>Type</b>	<b>Order No.</b>	<b>Pcs. / Pkt.</b>
<b>DL PPC15M 7000</b>	<b>2400017</b>	<b>1</b>



Fully enclosed IP65 IPC  
with 47 cm (18.5") display



Fully enclosed IP65 IPC  
with 54.6 cm (21.5") display

Technical data
47 cm/18,5" TFT
1366 x 768 pixels (WXGA)
LED
300 cd/m <sup>2</sup> , typical (adjustable)
> 50000 h
Capacitive multi-touch screen
Intel®Core™ i7-4650U 3.30 GHz
4 GB DDR3
8 GB DDR3
12 GB DDR3
2.5" SATA hard drive
2.5" SATA solid-state drive
4x USB 2.0, 1x USB 3.0
1x COM (RS-232/422/485)
1x Audio
2x Ethernet (10/100/1000 Mbps), RJ45
24 V DC ±20%
IP65
0°C ... 45°C <sup>1)</sup>
5% ... 95% (non-condensing)
VESA MIS-D (100 x 100)
1g with SSD, 0.5g with HDD, according to EN 60068-2-6
15g, 11 ms in accordance with IEC 60068-2-27

Technical data
54.6 cm/21,5" TFT
1920 x 1080 pixels (Full HD)
LED
300 cd/m <sup>2</sup> , typical (adjustable)
> 50000 h
Capacitive multi-touch screen
Intel®Core™ i7-4650U 3.30 GHz
4 GB DDR3
8 GB DDR3
12 GB DDR3
2.5" SATA hard drive
2.5" SATA solid-state drive
4x USB 2.0, 1x USB 3.0
1x COM (RS-232/422/485)
1x Audio
2x Ethernet (10/100/1000 Mbps), RJ45
24 V DC ±20%
IP65
0°C ... 45°C <sup>1)</sup>
5% ... 95% (non-condensing)
VESA MIS-D (100 x 100)
1g with SSD, 0.5g with HDD, according to EN 60068-2-6
15g, 11 ms in accordance with IEC 60068-2-27

Ordering data		
Type	Order No.	Pcs. / Pkt.
DL PPC18.5M 7000	2400015	1

Ordering data		
Type	Order No.	Pcs. / Pkt.
DL PPC21.5M 7000	2400016	1



Extend your system visualization to smartphones or tablets with the **Visu+ mobile** visualization app from Phoenix Contact. You can design flexible operating and monitoring concepts, as the Visu+ mobile app allows you to access your system at any time and from any location.

Integrate Visu+ mobile quickly and easily in existing touch panel or industrial PC visualization solutions. The Visu+ web server required for the app is already pre-installed in numerous devices from Phoenix Contact, such as touch panels. IPCs with Visu+ simply need to be extended with the web license option.

You can conveniently download the app in the usual way from the Google Play Store for Android or the App Store for Apple devices.

**Features:**

- Familiar comfort: simply use conventional smartphones or tablets to perform operation and monitoring
- Conventional SCADA functions such as trend display or alarm handling now also available on mobile devices
- Easy installation via Google Play store or App store
- High-performance, scalable Visu+ web server: up to 100 clients can be operated simultaneously in its maximum configuration
- Convenient generation of HTML visualization pages for the Visu+ web server from the Visu+ development environment



Easy app installation via Google Play store or Apple app store

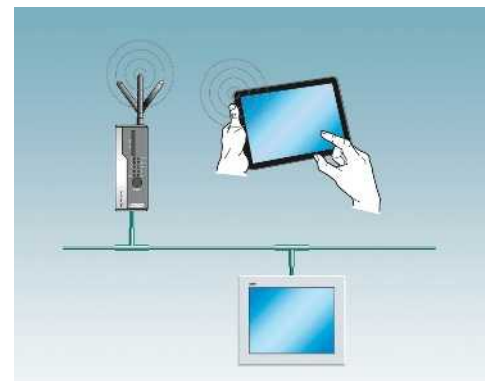

Visu+ mobile on a mobile termination device via access point, with a touch panel and web server

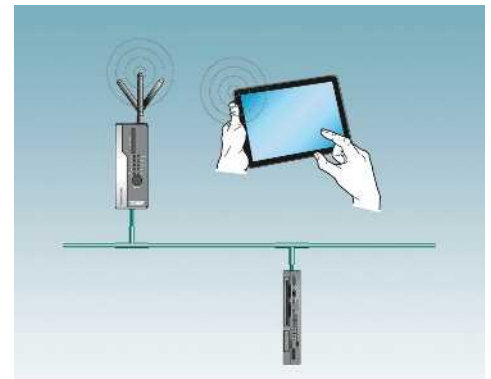

Visu+ mobile on a mobile termination device via access point, with an industrial PC and web server

## Multiplexer function for retrofitting

With the software for multiplexer systems, you can create a multiplexer system from two ILC 131 ETH small-scale controllers. Without any time-consuming programming.

To do so, extend each small-scale controller with an SD FLASH 512MB MODULAR MUX SD card and the corresponding I/O panel. Configuration is easy with few wire bridges - you just need to define the master and slave.

The software is therefore ideal for all areas of application where a multiplexer solution is required, without additional programming work for the controller.

- Wireless, Ethernet cable or network connection
- Multiplexer solution with standard components (2x ILC 131 ETH and 2x SD FLASH 512MB MODULAR MUX)
- Integration in Ethernet network via web interface, with PC and standard browser

### Notes:

When ordering, please note that you require two controllers and two SD cards respectively.



### Technical data

See [phoenixcontact.net/products](http://phoenixcontact.net/products)

### Ordering data

Description	Type	Order No.	Pcs. / Pkt.
Multiplexer application on SD card for configuring two ILC 131 ETH controllers as a multiplexer	SD FLASH 512MB MODULAR MUX	2701872	1

Controllers - programmable logic modules

Logic modules

Minimal effort with maximum benefits – for Nanoline programmable logic modules the focus is on simplicity and flexibility. This means a modular and adaptable design with optimum networking options.

**Your advantages:**

- Save time – by intelligently controlling basic tasks
- Easy use without prior knowledge, thanks to intuitive programming
- Versatile communication with numerous integration and networking options
- Maximum flexibility, thanks to the modular design

**Additional features:**

- Two high-speed counters and two analog inputs
- Supports four mathematical functions
- Integrated digital I/O
- Add an additional digital I/O extension module for a maximum of 12 I/O points
- Support for large Nanoline operator panel
- Integrated realtime clock (RTC)
- Integrated RS-232 for connection to a PC for programming and configuration
- Integrated RS-232 and RS-485 allow you to use your logic module as a Modbus RTU server
- Flexible programming with nanoNavigator or LOGIC+

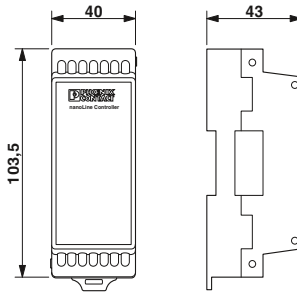

24 V DC, 4 digital inputs and 2 relay outputs

<b>Power supply</b>	
Supply voltage	24 V DC (power available to the I/O and Communications modules)
Supply voltage range	19.2 V DC ... 30 V DC
Typical current consumption	74 mA
Max. current consumption	81 mA
<b>Digital inputs</b>	
Number of inputs	4
Description of the inputs	PNP
Typical response time	10 µs (channel 1 and 2)
<b>Digital outputs</b>	
Number of outputs	2
Description of the outputs	Relay output
Maximum output current per channel	5 A
Maximum output current per module / terminal block	10 A
<b>Software interfaces</b>	
Programming tool	nanoNavigator 4.2 or above      LOGIC+
<b>General data</b>	
Connection method	Screw connection
Degree of protection	IP20
Ambient temperature (operation)	-25°C ... 70°C

Technical data	
NLC-035-024D 041-02QRD-05A	NLC-040-024D-041-02QRD-05A
24 V DC (power available to the I/O and Communications modules)	
19.2 V DC ... 30 V DC	
74 mA	
81 mA	
4	
PNP	
10 µs (channel 1 and 2)	
2	
Relay output	
5 A	
10 A	
nanoNavigator 4.2 or above      LOGIC+	
Screw connection	
IP20	
-25°C ... 70°C	

<b>Description</b>
<b>Nanoline controller</b>
- Programmable with nanoNavigator 4.2 and above
- Programmable with LOGIC+

Ordering data		
Type	Order No.	Pcs. / Pkt.
NLC-035-024D 041-02QRD-05A	2702031	1
NLC-040-024D-041-02QRD-05A	2400079	1

<b>Programming cable</b>
- 9-pos. D-SUB to RJ11/12

Accessories		
Type	Order No.	Pcs. / Pkt.
NLC-PC/SERIAL-CBL 1M	2701234	1



## Large operator panel

The operator panel is your interface for interacting with the Nanoline system. Read the status of all I/O points, registers, timers, counters, and system flags directly. In addition, the application program sends prompts and instructions to the display. The operator panel offers numerical (0-9), directional (up, down, left, right), and input keys. In addition, each of the 14 keys on the operator panel can be used to create user-specific menus in a flow chart.

### Additional features:

- 76 mm diagonal screen
- Variable text sizes for enhanced readability of custom messages (4 x 20 or 2 x 10 or a combination)
- Cable length of up to 15 m allows remote mounting away from the logic module
- External 24 V DC
- Variable backlight: red, blue or green
- Adjustable backlight timer to save energy



User interface for Nanoline controllers

Technical data		
Display data	Backlit LC display, monochrome, 4 lines with 20 characters or 2 lines with 10 characters	
Display		
Interfaces	9-pos. D-SUB male	
Operator panel	Max. 15 m	
Transmission length		
Power supply for module electronics	24 V DC	
Supply voltage	3-pos. Combicon	
Connection method	38 mA (24 V DC)	
Typical current consumption	40 mA (24 V DC)	
Max. current consumption		
General data		
Programming tool	nanoNavigator	
Mounting type	Panel mounting	
Keys	17	
Height	102 mm	
Width	128 mm	
Depth	44.5 mm	
Degree of protection	IP66	
Ambient temperature (operation)	0°C ... 50°C	
Ambient temperature (storage/transport)	0°C ... 60°C	
Ordering data		
Type	Order No.	Pcs. / Pkt.
NLC-OP2-LCD-076-4X20	2701945	1
Accessories		
NLC-OP1-MKT-BASE	2701250	1
SUBCON-PLUS-M/AX 9	2904467	1
Description		
Operator panel		
Base module for remote mounting Operator Panel (included in nLC-OP1-MKT)		
D-SUB plug, with two cable entries, universal type, pin assignment 1,2,3,4,5,6,7,8,9 on every screw terminal block		

Analog I/O extension module

Temperature extension module provides RTD and thermocouple inputs as well as four digital outputs.

- Two temperature sensor inputs
- Configuration options for PT100 and PT1000 RTD sensors with two or three wires
- Configuration options for thermocouple types B, E, J, K, N, R, S, and T
- Four PNP digital outputs
- Automatically recognized by nanoNavigator

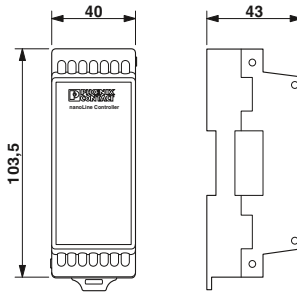

2 temperature inputs, 4 PNP outputs

<b>Power supply for module electronics</b>	
Supply voltage	24 V
<b>Temperature input</b>	
Connection method	2 or 3-wire (shielded)
Number of inputs	2
Sensor types (RTD) that can be used	Pt 100, Pt 1000
Sensor types that can be used (TC)	B, E, J, K, N, R, S, T
<b>Digital outputs</b>	
Number of outputs	4
Description of the outputs	PNP outputs
Nominal output voltage	24 V DC
Maximum output current per channel	0.5 A
Maximum output current per module / terminal block	2 A
Maximum switching voltage	24 V DC
Minimum switching voltage	0.8 V DC
<b>General data</b>	
Connection method	Screw connection
Ambient temperature (operation)	0°C ... 60°C

**Technical data**

Description	<b>Nanoline controllers, I/O extension module</b>	
	- 2 temperature inputs, 4 PNP outputs	

**Ordering data**

Type	Order No.	Pcs. / Pkt.
NLC-IO-2RTD/UTH-4QTP-01A	2701671	1

**Digital I/O extension module for NLC-035 and NLC-040 logic modules**

You can extend your Nanoline with an additional I/O extension module. Extension modules provide additional inputs and outputs beyond what is available on the logic module.

- The NLC-IOX is only compatible with the NLC-035 and NLC-040
- One module can be added to the right side of a logic module
- Automatically recognized by nanoNavigator

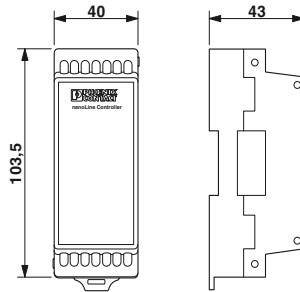

Digital I/O extension module

Power supply for module electronics	
Supply voltage	24 V DC
Digital inputs	
Maximum number of inputs	4
Description of the inputs	PNP
Digital outputs	
Number of outputs	2
Description of the outputs	Relay output
Maximum output current per channel	5 A
Maximum output current per module / terminal block	10 A

**Technical data**

Supply voltage	24 V DC
Maximum number of inputs	4
Description of the inputs	PNP
Number of outputs	2
Description of the outputs	Relay output
Maximum output current per channel	5 A
Maximum output current per module / terminal block	10 A

Description			
<b>Nanoline controllers, I/O extension module</b>			
- 4 digital inputs, 2 relay outputs			

**Ordering data**

Type	Order No.	Pcs. / Pkt.
NLC-IOX-041-02QRD-05A	2702032	1



Type	Order No.	Page	Type	Order No.	Page	Type	Order No.	Page	Type	Order No.	Page
DS-QTC 2.5	3206607	173	FBP-2/A7	3069497	103	FOC-V14-C1ZNI-B/SJFH	1407904	49	G-EDSWU-M40-L66L-STES-S	1411099	235
DT-TELE-SHDSL	2801593	314	FBP-2/B14	3069501	111	FOC-V14-C1ZNI-B/SJFH:10	1408055	49	G-EDSWU-M50-L66L-STES-S	1411101	235
			FBP-2/B19	3069503	115	FOC-V14-C1ZNI-B/SJFH	1407902	49	G-EDSWU-M63-L66L-STES-S	1411103	235
			FBP-2/B7	3069498	105	FOC-V14-C1ZNI-B/SJFP:10	1408053	49	G-ESS-M20-S66L-NTES-S	1411075	234
			FBP-2/C14	3069502	113	FOC-V14-C1ZNI-S/SJFG	1407898	48	G-ESS-M20-S66L-STES-S	1411076	234
			FBP-2/C19	3069504	117	FOC-V14-C1ZNI-S/SJFG:10	1408049	48	G-ESS-M25-M66L-NTES-S	1411077	234
			FBP-2/D19	3069671	119	FOC-V14-C1ZNI-S/SJFH	1407897	48	G-ESS-M25-M66L-STES-S	1411078	234
			FBP-2/E7	3069499	107	FOC-V14-C1ZNI-S/SJFH:10	1408048	48	G-ESS-M32-M66L-NTES-S	1411079	234
			FBP-2/F19	3069675	121	FOC-V14-C1ZNI-S/SJFP	1407896	48	G-ESS-M32-M66L-STES-S	1411080	234
			FBP-2/G19	3069676	123	FOC-V14-C1ZNI-S/SJFP:10	1408047	48	G-ESS-M40-L66L-NTES-S	1411081	234
			FBP-2/H19	3069677	125	FOC-V14-C1ZNI-T/SJFG	1408030	48	G-ESS-M40-L66L-STES-S	1411082	234
			FBP-2/I19	3069678	127	FOC-V14-C1ZNI-T/SJFH	1408029	48	G-ESS-M50-L66L-NTES-S	1411084	234
			FBS 1/3-8	3032363	101	FOC-V14-C1ZNI-T/SJFH:10	1408094	48	G-ESS-M50-L66L-STES-S	1411085	234
			FBS 1/3/5-8	3032389	101	FOC-V14-C1ZNI-T/SJFP	1408028	48	G-ESS-M63-L66L-NTES-S	1411086	234
			FBS 1/4-8	3032376	101	FOC-V14-C1ZNI-T/SJFP:10	1408093	48	G-ESS-M63-L66L-STES-S	1411087	234
			FBS 1/4/7/10-8	3032402	101	FT NUT M25 BK	1457937	77	G-ESSWU-M20-M66L-NTES-S	1411090	235
			FBS 2-5	3030161	160	FTP-2/1	3069469	103	G-ESSWU-M20S-S66L-NTES-S	1411088	235
			FBS 2-6	3030336	166	FTP-2/10	3001712	96	G-ESSWU-M25-M66L-NTES-S	1411092	235
			FBS 2-8	3030284	100	FTP-2/12	3001714	96	G-ESSWU-M32-L66L-NTES-S	1411094	235
			FBS 3-5	3030174	160	FTP-2/14	3001716	96	G-ESSWU-M40-L66L-NTES-S	1411097	235
			FBS 3-6	3030242	166	FTP-2/15	3001717	96	G-ESSWU-M50-L66L-NTES-S	1411100	235
			FBS 3-8	3030297	100	FTP-2/17	3001720	96	G-ESSWU-M63-L66L-NTES-S	1411102	235
			FBS 4-5	3030187	160	FTP-2/19	3001723	96	G-INS-M12-S68N-NNES-S	1411160	229
			FBS 4-6	3030255	166	FTP-2/20	3001724	96	G-INS-M12-S68N-PNES-BK	1411131	225
			FBS 4-8	3030307	100	FTP-2/21	3001725	96	G-INS-M12-S68N-PNES-GY	1411123	224
			FBS 5-5	3030190	160	FTP-2/22	3001726	96	G-INS-M16-S68N-NNES-S	1411162	229
			FBS 5-6	3030349	166	FTP-2/25	3001729	96	G-INS-M16-S68N-PNES-BK	1411132	225
			FBS 5-8	3030310	100	FTP-2/4	3001706	96	G-INS-M16-S68N-PNES-GY	1411124	224
			FBS 6-8	3032470	100	FTP-2/5	3001707	96	G-INS-M20-S68N-NNES-S	1411163	229
			FBS 10-3,5	3213056	156	FTP-2/9	3001711	96	G-INS-M20-S68N-PNES-BK	1411133	225
			FBS 10-5	3030213	160	FTP-2/A14	3069474	109	G-INS-M20-S68N-PNES-GY	1411125	224
			FBS 10-6	3030271	166	FTP-2/A7	3069470	103	G-INS-M25-M68N-NNES-S	1411165	229
			FBS 10-8	3030323	100	FTP-2/B14	3069475	111	G-INS-M25-M68N-PNES-BK	1411134	225
			FBS 2-18	2801068	306	FTP-2/B19	3069477	115	G-INS-M25-M68N-PNES-GY	1411126	224
			FBS 2-3,5	3213014	156	FTP-2/B7	3069471	105	G-INS-M32-M68N-NNES-S	1411166	229
			FBS 20-3,5	3213069	156	FTP-2/C14	3069476	113	G-INS-M32-M68N-PNES-BK	1411136	225
			FBS 20-5	3030226	160	FTP-2/C19	3069478	117	G-INS-M32-M68N-PNES-GY	1411127	224
			FBS 20-6	3030365	166	FTP-2/D19	3069479	119	G-INS-M40-M68N-NNES-S	1411167	229
			FBS 3-3,5	3213027	156	FTP-2/E7	3069472	107	G-INS-M40-M68N-PNES-BK	1411137	225
			FBS 4-3,5	3213030	156	FTP-2/F19	3069480	121	G-INS-M40-M68N-PNES-GY	1411128	224
			FBS 5-3,5	3213043	156	FTP-2/G19	3069481	123	G-INS-M50-L68L-PNES-BK	1411138	225
			FBS-FV	3032185	160	FTP-2/H19	3069482	125	G-INS-M50-L68L-PNES-GY	1411129	224
			FBSR 16-8	3033816	100	FTP-2/I19	3069483	127	G-INS-M50-L68N-NNES-S	1411168	229
			FBSRH 2-8	3033802	100	FTPR-2/10	3001688	96	G-INS-M63-L68L-PNES-BK	1411139	225
			FBSRH 3-8	3033803	100	FTPR-2/12	3001690	96	G-INS-M63-L68L-PNES-GY	1411130	224
			FBSRH 4-8	3033804	100	FTPR-2/14	3001692	96	G-INS-M63-L68N-NNES-S	1411169	229
			FL CAT5 PATCH 3,0	2832292	391	FTPR-2/15	3001693	96	G-INS-N11-M68L-PNES-BK	1411159	228
			FL COMSERVER BAS 232/422/485-T	2904681	391	FTPR-2/17	3001696	96	G-INS-N11-M68L-PNES-GY	1411155	227
			FL COMSERVER UNI 232/422/485-T	2904817	391	FTPR-2/19	3001698	96	G-INS-N12-S68L-PNES-BK	1411157	228
			FL MC 2000E SM40 LC	2891156	389	FTPR-2/20	3001699	96	G-INS-N12-S68L-PNES-GY	1411153	227
			FL MC 2000T SC	2891315	388	FTPR-2/21	3001700	96	G-INS-N3/4-M68L-PNES-BK	1411158	228
			FL MC 2000T SM20 SC	2891317	389	FTPR-2/22	3001701	96	G-INS-N3/4-M68L-PNES-GY	1411154	227
			FL MC 2000T SM40 SC	2891318	389	FTPR-2/25	3001704	96	G-INS-N3/8-S68L-PNES-BK	1411156	228
			FL MC 2000T ST	2891316	388	FTPR-2/4	3001681	96	G-INS-N3/8-S68L-PNES-GY	1411152	227
			FL MEM PLUG	2891259	379	FTPR-2/6	3001683	96	G-INS-NPT1-M68L-NNES-S	1411185	231
			FL MEM PLUG/MRM	2891275	379	FTPR-2/9	3001687	96	G-INS-NPT1/2-S68L-NNES-S	1411183	231
			FL RED 2001E PRP 2LC	2701864	382	FTPR-2/A14	3069487	109	G-INS-NPT3/4-M68L-NNES-S	1411184	231
			FL RED 2003E PRP	2701863	382	FTPR-2/A7	3069484	103	G-INS-NPT3/8-S68L-NNES-S	1411182	231
			FL SFP FX	2891081	386	FTPR-2/B14	3069488	111	G-INS-PG11-S68N-NNES-S	1411172	230
			FL SFP FX SM	2891082	386	FTPR-2/B19	3069490	115	G-INS-PG11-S68N-PNES-GY	1411142	226
			FL SWITCH 1708 M12 POE	2701883	376	FTPR-2/B7	3069485	105	G-INS-PG13,5-S68N-NNES-S	1411173	230
			FL SWITCH 3012E-2SFX	2891067	383	FTPR-2/C14	3069489	113	G-INS-PG13,5-S68N-PNES-GY	1411143	226
			FL SWITCH 3016E	2891066	383	FTPR-2/C19	3069491	117	G-INS-PG16-S68N-NNES-S	1411174	230
			FL SWITCH 4800E-P1	2891075	384	FTPR-2/D19	3069492	119	G-INS-PG16-S68N-PNES-GY	1411144	226
			FL SWITCH 4800E-P5	2891076	384	FTPR-2/E7	3069486	107	G-INS-PG21-M68N-NNES-S	1411175	230
			FL SWITCH 4808E-16FX LC-4GC	2891073	385	FTPR-2/F19	3069493	121	G-INS-PG21-M68N-PNES-GY	1411145	226
			FL SWITCH 4808E-16FX SM LC-4GC	2891074	385	FTPR-2/G19	3069494	123	G-INS-PG29-M68N-NNES-S	1411176	230
			FL SWITCH 4808E-16FX SM-4GC	2891080	385	FTPR-2/H19	3069495	125	G-INS-PG29-M68N-PNES-GY	1411146	226
			FL SWITCH 4808E-16FX-4GC	2891079	385	FTPR-2/I19	3069496	127	G-INS-PG36-L68N-NNES-S	1411178	230
			FL SWITCH 4824E-4GC	2891072	384				G-INS-PG36-L68N-PNES-GY	1411147	226
			FL SWITCH 7005/FX-2FXSM-EIP	2701420	381				G-INS-PG42-L68N-NNES-S	1411179	230
			FL SWITCH 7006/2FX-EIP	2701419	381				G-INS-PG42-L68N-PNES-GY	1411149	226
			FL SWITCH 7008-EIP	2701418	380				G-INS-PG48-L68N-NNES-S	1411181	230
			FL SWITCH LM 8TX-B	2989446	378				G-INS-PG48-L68N-PNES-GY	1411150	226
			FL SWITCH SMN 8TX-PN	2989501	379				G-INS-PG7-S68N-NNES-S	1411170	230
			FL WLAN 5102	2701850	387				G-INS-PG7-S68N-PNES-GY	1411140	226
			FL-PP-RJ45-SCC/SC041	2903532	392	G-EDSWU-M20-M66L-STES-S	1411091	235	G-INS-PG9-S68N-NNES-S	1411171	230
			FL-PP-RJ45-SCC/SC045	2904577	392	G-EDSWU-M20S-S66L-STES-S	1411089	235	G-INS-PG9-S68N-PNES-GY	1411141	226
			FL-PP-RJ45/RJ45-B	2904933	392	G-EDSWU-M25-M66L-STES-S	1411093	235	G-INSEC-M12-S68N-NCRS-S	1411187	232
			FOC-V14-C1ZNI-B/SJFG	1407905	49	G-EDSWU-M32-L66L-STES-S	1411095	235	G-INSEC-M16-S68N-NCRS-S	1411188	232

# Index

## Alphabetical

Type	Order No.	Page	Type	Order No.	Page	Type	Order No.	Page	Type	Order No.	Page
G-INSEC-M20-S68N-NCRS-S	1411189	232	HC-EVO-B16-CHWS-ELC-AL	1411464	208	HMI SCB MOUNTING KIT 8	2701387	419	KV-DI-PG16-1XASI	1582462	195
G-INSEC-M25-S68N-NCRS-S	1411190	232	HC-EVO-B16-HHFD-EL-AL	1411460	209	HSCH 2,5-2U-2220 9005	2201792	35	KV-DI-PG16-2XASI	1582464	195
G-INSEC-M32-M68N-NCRS-S	1411191	232	HC-EVO-B16-HHFS-EL-AL	1411461	208	HC-EVO-B16-HHWD-EL-AL	2201791	35			
G-INSEC-M40-M68N-NCRS-S	1411192	232	HC-EVO-B16-HHWD-EL-AL	1411462	210	HSCH 2,5-2U-TTTT 9005	2201790	35			
G-INSEC-M50-L68N-NCRS-S	1411193	232	HC-EVO-B16PT-BWD-HH-M25ELC-AL	1411489	209	HSCH 2,5-2U/ 8 9005	2201789	35			
G-INSEC-M63-L68N-NCRS-S	1411194	232	HC-EVO-B16PT-BWSC-HH-M25ELC-AL	1411492	208	HSCH 2,5-3U/12 9005	2201788	35			
G-INSEC-PG11-S68N-NCRS-S	1411197	233	HC-EVO-B24-CHWD-ELC-AL	1411475	212	HSCP-SP 2,5-1U-20 7035	2201782	35			
G-INSEC-PG13,5-S68N-NCRS-S	1411198	233	HC-EVO-B24-CHWS-ELC-AL	1411476	211	HSCP-SP 2,5-1U-TT 7035	2201781	35			
G-INSEC-PG16-S68N-NCRS-S	1411199	233	HC-EVO-B24-HHFD-EL-AL	1411472	212						
G-INSEC-PG21-S68N-NCRS-S	1411200	233	HC-EVO-B24-HHFS-EL-AL	1411473	211	HSCP-SP 2,5-1U/ 4 7035	2201780	35	LS-EML (180X180) BK-WH	0831784	262
G-INSEC-PG29-M68N-NCRS-S	1411201	233	HC-EVO-B24-HHWD-EL-AL	1411474	213				LS-EML (180X180) BK-WH CUS	0832070	262
G-INSEC-PG36-L68N-NCRS-S	1411202	233	HC-EVO-B24PT-BWD-HH-M32ELC-AL	1411490	212				LS-EMLP (100X60) SR	0831726	257
									LS-EMLP (100X60) SR CUS	0832012	259
G-INSEC-PG42-L68N-NCRS-S	1411203	233	HC-EVO-B24PT-BWSC-HH-M32ELC-AL	1411493	211				LS-EMLP (100X60) WH	0831699	256
G-INSEC-PG48-L68N-NCRS-S	1411204	233	HC-EVO-D15-BWS-PLR-BK	1411336	196				LS-EMLP (100X60) WH CUS	0831985	258
G-INSEC-PG7-S68N-NCRS-S	1411195	233	HC-EVO-D15-BWSC-PLR-BK	1411337	196				LS-EMLP (100X60) YE	0831753	257
G-INSEC-PG9-S68N-NCRS-S	1411196	233	HC-EVO-D15-CHWS-PL-BK	1411338	196				LS-EMLP (100X60) YE CUS	0832039	259
GPE 13X 9 WH	0806932	195	HC-EVO-D15-HHFS-PL-BK	1411340	196	IB IL MBUS-PAC	2701927	416	LS-EMLP (11X9) SR	0831705	257
			HC-EVO-D15-SLWS-2SSM25-PLR-BK	1411341	196	IFS-CONFSTICK	2986122	358	LS-EMLP (11X9) SR CUS	0831991	259
			HC-EVO-D15-SLWSC-2SSM25-PLR-BK	1411343	196	IFS-USB-DATACABLE	2320500	358	LS-EMLP (11X9) WH	0831678	256
			HC-EVO-D25-BWS-PLR-BK	1411344	197	IFS-USB-PROG-ADAPTER	2811271	339	LS-EMLP (11X9) WH CUS	0831964	258
			HC-EVO-D25-BWSC-PLR-BK	1411345	197				LS-EMLP (11X9) YE	0831732	257
			HC-EVO-D25-CHWS-PLR-BK	1411346	197	IMC 1,5/ 2-G-3,5 P20 THR	1830414	16	LS-EMLP (11X9) YE CUS	0832018	259
			HC-EVO-D25-HHFS-PL-BK	1411347	197	IMC 1,5/ 3-G-3,5 P20 THR	1830427	16	LS-EMLP (13X9) SR	0831706	257
			HC-EVO-D25-SLWS-2SSM25-PLR-BK	1411348	197	IMC 1,5/ 3-G-3,5 RN P20 THR	1830579	17	LS-EMLP (13X9) SR CUS	0831992	259
			HC-EVO-D25-SLWSC-2SSM25-PLR-BK	1411349	197	IMC 1,5/ 4-G-3,5 P20 THR	1830430	16	LS-EMLP (13X9) WH	0831679	256
			HC-EVO-D15-BWS-PLR-BK	1411122	214	IMC 1,5/ 4-G-3,5 RN P20 THR	1830582	17	LS-EMLP (13X9) WH CUS	0831965	258
			HC-HPR-B06-HHWH-1STM20-EM-BK	1411878	214	IMC 1,5/ 5-G-3,5 P20 THR	1830443	16	LS-EMLP (13X9) YE	0831733	257
			HC-HPR-B06-HHWH-1STM25-EM-BK	1411119	214	IMC 1,5/ 5-G-3,5 RN P20 THR	1830595	17	LS-EMLP (13X9) YE CUS	0832019	259
			HC-HPR-B06-HHWH-1TTM20-EM-BK	1411879	214	IMC 1,5/ 6-G-3,5 P20 THR	1830456	16	LS-EMLP (17,5X12) SR	0831709	257
			HC-HPR-B06-HHWH-1TTM25-EM-BK	1411106	214	IMC 1,5/ 6-G-3,5 RN P20 THR	1830605	17	LS-EMLP (17,5X12) SR CUS	0831995	259
			HC-HPR-B06-SHFH-2SSM20-EMR-BK	1411880	214	IMC 1,5/ 7-G-3,5 P20 THR	1830469	16	LS-EMLP (17,5X12) WH	0831682	256
			HC-HPR-B06-SHFH-2SSM25-EMR-BK	1411103	214	IMC 1,5/ 7-G-3,5 RN P20 THR	1830618	17	LS-EMLP (17,5X12) WH CUS	0831968	258
			HC-HPR-B10-BFH-EMR-BK	1411083	215	IMC 1,5/ 8-G-3,5 P20 THR	1830472	16	LS-EMLP (17,5X12) YE	0831736	257
			HC-HPR-B10-HHWH-1STM25EM-BK	1411881	215	IMC 1,5/ 8-G-3,5 RN P20 THR	1830621	17	LS-EMLP (17,5X12) YE CUS	0832022	259
			HC-HPR-B10-HHWH-1STM32-EM-BK	1411070	215	IMC 1,5/ 9-G-3,5 P20 THR	1830485	16	LS-EMLP (17,5X15) SR	0831710	257
			HC-HPR-B10-HHWH-1TTM25-EM-BK	1411882	215	IMC 1,5/ 9-G-3,5 RN P20 THR	1830634	17	LS-EMLP (17,5X15) SR CUS	0831996	259
			HC-HPR-B10-HHWH-1TTM32-EM-BK	1411067	215	IMC 1,5/10-G-3,5 P20 THR	1830498	16	LS-EMLP (17,5X15) WH	0831683	256
			HC-HPR-B10-SHFH-2SSM25-EMR-BK	1411883	215	IMC 1,5/10-G-3,5 RN P20 THR	1830647	17	LS-EMLP (17,5X15) WH CUS	0831969	258
			HC-HPR-B10-SHFH-2SSM32-EMR-BK	1411096	215	IMC 1,5/11-G-3,5 P20 THR	1830508	16	LS-EMLP (17,5X15) YE	0831737	257
			HC-HPR-B16-BFH-EMR-BK	1411060	216	IMC 1,5/11-G-3,5 RN P20 THR	1830650	17	LS-EMLP (17,5X15) YE CUS	0832023	259
			HC-HPR-B16-HHWH-1STM32-EM-BK	1411058	216	IMC 1,5/12-G-3,5 P20 THR	1830511	16	LS-EMLP (17X7) SR	0831707	257
			HC-HPR-B16-HHWH-1STM40-EM-BK	1411884	216	IMC 1,5/12-G-3,5 RN P20 THR	1830663	17	LS-EMLP (17X7) SR CUS	0831993	259
			HC-HPR-B16-HHWH-1TTM32-EM-BK	1411059	216	IMCV 1,5/ 2-G-3,5 P20 THR	1830715	17	LS-EMLP (17X7) WH	0831680	256
			HC-HPR-B16-HHWH-1TTM40-EM-BK	1411885	216	IMCV 1,5/ 2-G-3,5 RN P20 THR	1830867	17	LS-EMLP (17X7) WH CUS	0831966	258
			HC-HPR-B16-SHFH-2SSM32-EMR-BK	1411054	216	IMCV 1,5/ 3-G-3,5 P20 THR	1830728	17	LS-EMLP (17X7) YE	0831734	257
			HC-HPR-B16-SHFH-2SSM40-EMR-BK	1411886	216	IMCV 1,5/ 3-G-3,5 RN P20 THR	1830870	17	LS-EMLP (17X7) YE CUS	0832020	259
			HC-HPR-B24-BFH-EMR-BK	1411055	217	IMCV 1,5/ 4-G-3,5 P20 THR	1830731	17	LS-EMLP (17X9) SR	0831708	257
			HC-HPR-B24-HHWH-1STM32-EM-BK	1411887	217	IMCV 1,5/ 4-G-3,5 RN P20 THR	1830883	17	LS-EMLP (17X9) SR CUS	0831994	259
			HC-HPR-B24-HHWH-1STM40-EM-BK	1411061	217	IMCV 1,5/ 5-G-3,5 P20 THR	1830744	17	LS-EMLP (17X9) WH	0831681	256
			HC-HPR-B24-HHWH-1TTM32-EM-BK	1411888	217	IMCV 1,5/ 5-G-3,5 RN P20 THR	1830896	17	LS-EMLP (17X9) WH CUS	0831967	258
			HC-HPR-B24-HHWH-1TTM40-EM-BK	1411062	217	IMCV 1,5/ 6-G-3,5 P20 THR	1830757	17	LS-EMLP (17X9) YE	0831735	257
			HC-HPR-B24-SHFH-2SSM32-EMR-BK	1411889	217	IMCV 1,5/ 6-G-3,5 RN P20 THR	1830906	17	LS-EMLP (17X9) YE CUS	0832021	259
			HC-HPR-B24-SHFH-2SSM40-EMR-BK	1411063	217	IMCV 1,5/ 7-G-3,5 P20 THR	1830760	17	LS-EMLP (20X7) SR	0831711	257
			HC-HS06-I-UT-F	1406530	201	IMCV 1,5/ 7-G-3,5 RN P20 THR	1830919	17	LS-EMLP (20X7) SR CUS	0831997	259
			HC-HS06-I-UT-F 7-12	1406533	201	IMCV 1,5/ 8-G-3,5 P20 THR	1830773	17	LS-EMLP (20X7) WH	0831684	256
			HC-HS06-I-UT-M	1406531	201	IMCV 1,5/ 8-G-3,5 RN P20 THR	1830922	17	LS-EMLP (20X7) WH CUS	0831970	258
			HC-HS06-I-UT-M 7-12	1406534	201	IMCV 1,5/ 9-G-3,5 P20 THR	1830786	17	LS-EMLP (20X7) YE	0831738	257
			HC-K-BS-M25 BK	1411245	219	IMCV 1,5/ 9-G-3,5 RN P20 THR	1830935	17	LS-EMLP (20X7) YE CUS	0832024	259
			HC-K-BS-M32-BK	1410754	219	IMCV 1,5/10-G-3,5 P20 THR	1830799	17	LS-EMLP (20X8) SR	0831712	257
			HC-K-BS-M40-BK	1410767	219	IMCV 1,5/10-G-3,5 RN P20 THR	1830948	17	LS-EMLP (20X8) SR CUS	0831998	259
			HC-K-KV-M20(5-13)BK	1411261	218	IMCV 1,5/11-G-3,5 P20 THR	1830809	17	LS-EMLP (20X8) WH	0831685	256
			HC-K-KV-M25(8-17)BK	1411258	218	IMCV 1,5/11-G-3,5 RN P20 THR	1830951	17	LS-EMLP (20X8) WH CUS	0831971	258
			HC-K-KV-M32(12-21)BK	1407673	218	IMCV 1,5/12-G-3,5 P20 THR	1830812	17	LS-EMLP (20X8) YE	0831739	257
			HC-K-KV-M40(16-28)BK	1407674	218	IMCV 1,5/12-G-3,5 RN P20 THR	1830964	17	LS-EMLP (20X8) YE CUS	0832025	259
			HC-EVO-A16UT-BWSC-HH-M25-PLR-BK	1411359	197	ISH 2,5/0,2	3002843	160	LS-EMLP (22X12) SR	0831713	257
			HC-EVO-B06-CHWS-ELC-AL	1411450	204	ISH 2,5/0,5	3002856	160	LS-EMLP (22X12) SR CUS	0831999	259
			HC-EVO-B06-HHFS-EL-AL	1411447	204	ISH 2,5/1,0	3002869	160	LS-EMLP (22X12) WH	0831686	256
			HC-EVO-B06-HLFS-EL-AL	1411448	204				LS-EMLP (22X12) WH CUS	0831972	258
			HC-EVO-B06PT-BWSC-HL-M20ELC-AL	1411487	204	HC-STA-B10-BWS-ELC-AL	1411320	205	LS-EMLP (22X12) YE	0831740	257
			HC-EVO-B10-CHWD-ELC-AL	1411458	206	HC-STA-B10-BWSC-ELC-AL	1411321	205	LS-EMLP (22X12) YE CUS	0832026	259
			HC-EVO-B10-CHWS-ELC-AL	1411459	205	HC-STA-B16-BFDC-ELC-AL	1411328	210	LS-EMLP (22X22) SR	0831714	257
			HC-EVO-B10-HHFD-EL-AL	1411451	206	HC-STA-B16-BWD-ELC-AL	1411327	209	LS-EMLP (22X22) SR CUS	0832000	259
			HC-EVO-B10-HHFS-EL-AL	1411453	205	HC-STA-B16-BWS-ELC-AL	1411324	208	LS-EMLP (22X22) WH	0831687	256
			HC-EVO-B10-HHWD-EL-AL	1411454	207	HC-STA-B16-BWSC-ELC-AL	1411325				

Type	Order No.	Page	Type	Order No.	Page	Type	Order No.	Page	Type	Order No.	Page
LS-EMLP (27X12,5) YE	0831743	257	LS-EMLP-AL (100X60)	0831586	252	LS-EMSP-AL (150X80)	0831621	251	LS-WMTB-V4A (29X8)	0831516	247
LS-EMLP (27X12,5) YE CUS	0832029	259	LS-EMLP-AL (100X60) BK	0831595	253	LS-EMSP-AL (150X80) BK	0831632	251	LS-WMTB-V4A (29X8) CUS	0831802	247
LS-EMLP (27X15) SR	0831717	257	LS-EMLP-AL (100X60) BK CUS	0831881	253	LS-EMSP-AL (150X80) BK CUS	0831918	251	LS-WMTB-V4A (40X15)	0831517	247
LS-EMLP (27X15) SR CUS	0832003	259	LS-EMLP-AL (100X60) CUS	0831872	252	LS-EMSP-AL (150X80) CUS	0831907	251	LS-WMTB-V4A (40X15) CUS	0831803	247
LS-EMLP (27X15) WH	0831690	256	LS-EMLP-AL (27X15)	0831580	252	LS-EMSP-AL (170X180)	0831623	251	LS-WMTB-V4A (60X15)	0831518	247
LS-EMLP (27X15) WH CUS	0831976	258	LS-EMLP-AL (27X15) BK	0831589	253	LS-EMSP-AL (170X180) BK	0831634	251	LS-WMTB-V4A (60X15) CUS	0831804	247
LS-EMLP (27X15) YE	0831744	257	LS-EMLP-AL (27X15) BK CUS	0831875	253	LS-EMSP-AL (170X180) BK CUS	0831920	251	LS-WMTB-V4A (D25)	0831520	249
LS-EMLP (27X15) YE CUS	0832030	259	LS-EMLP-AL (27X15) CUS	0831866	252	LS-EMSP-AL (170X180) CUS	0831909	251	LS-WMTB-V4A (D25) CUS	0831806	249
LS-EMLP (27X18) SR	0831718	257	LS-EMLP-AL (27X18)	0831581	252	LS-EMSP-AL (39X15)	0831615	251	LS-WMTB-V4A (D30)	0831521	249
LS-EMLP (27X18) SR CUS	0832004	259	LS-EMLP-AL (27X18) BK	0831590	253	LS-EMSP-AL (39X15) BK	0831626	251	LS-WMTB-V4A (D30) CUS	0831807	249
LS-EMLP (27X18) WH	0831691	256	LS-EMLP-AL (27X18) BK CUS	0831876	253	LS-EMSP-AL (39X15) BK CUS	0831912	251			
LS-EMLP (27X18) WH CUS	0831977	258	LS-EMLP-AL (27X18) CUS	0831867	252	LS-EMSP-AL (39X15) CUS	0831901	251			
LS-EMLP (27X18) YE	0831745	257	LS-EMLP-AL (49X15)	0831582	252	LS-EMSP-AL (50X15)	0831616	251			
LS-EMLP (27X18) YE CUS	0832031	259	LS-EMLP-AL (49X15) BK	0831591	253	LS-EMSP-AL (50X15) BK	0831627	251			
LS-EMLP (27X27) SR	0831719	257	LS-EMLP-AL (49X15) BK CUS	0831877	253	LS-EMSP-AL (50X15) BK CUS	0831913	251			
LS-EMLP (27X27) SR CUS	0832005	259	LS-EMLP-AL (49X15) CUS	0831868	252	LS-EMSP-AL (50X15) CUS	0831902	251			
LS-EMLP (27X27) WH	0831692	256	LS-EMLP-AL (60X15)	0831583	252	LS-EMSP-AL (50X30)	0831617	251	MACX MCR-EX-I20	2905679	346
LS-EMLP (27X27) WH CUS	0832008	258	LS-EMLP-AL (60X15) BK	0831592	253	LS-EMSP-AL (50X30) BK	0831628	251	MACX MCR-I20	2905680	343
LS-EMLP (27X27) YE	0831746	257	LS-EMLP-AL (60X15) BK CUS	0831878	253	LS-EMSP-AL (50X30) BK CUS	0831914	251	MACX PL-EX-RPSS-2I-2I	2904963	345
LS-EMLP (27X27) YE CUS	0832032	259	LS-EMLP-AL (60X15) CUS	0831869	252	LS-EMSP-AL (50X30) BU	0831645	251	MACX PL-EX-RPSS-2I-2I-SP	2904964	345
LS-EMLP (27X8) SR	0831715	257	LS-EMLP-AL (60X30)	0831584	252	LS-EMSP-AL (50X30) BU CUS	0831931	251	MACX PL-EX-RPSSI-2I	2904959	344
LS-EMLP (27X8) SR CUS	0832001	259	LS-EMLP-AL (60X30) BK	0831593	253	LS-EMSP-AL (50X30) BK	0831903	251	MACX PL-EX-RPSSI-2I-SP	2904960	344
LS-EMLP (27X8) WH	0831688	256	LS-EMLP-AL (60X30) BK CUS	0831879	253	LS-EMSP-AL (50X30) GN	0831649	251	MACX PL-EX-T-UIREL-UP	2904910	346
LS-EMLP (27X8) WH CUS	0831974	258	LS-EMLP-AL (60X30) BU	0831606	253	LS-EMSP-AL (50X30) GN CUS	0831935	251	MACX PL-EX-T-UIREL-UP-SP	2904912	346
LS-EMLP (27X8) YE	0831742	257	LS-EMLP-AL (60X30) BU CUS	0831892	253	LS-EMSP-AL (50X30) OG	0831641	251	MACX PL-RPSSI-2I	2904961	342
LS-EMLP (27X8) YE CUS	0832004	259	LS-EMLP-AL (60X30) CUS	0831870	252	LS-EMSP-AL (50X30) OG CUS	0831927	251	MACX PL-RPSSI-2I-SP	2904962	342
LS-EMLP (45X14) SR	0831720	257	LS-EMLP-AL (60X30) GN	0831610	253	LS-EMSP-AL (50X30) RD	0831637	251	MACX PL-T-UIREL-UP	2904901	343
LS-EMLP (45X14) SR CUS	0832006	259	LS-EMLP-AL (60X30) GN CUS	0831896	253	LS-EMSP-AL (50X30) RD CUS	0831923	251	MACX PL-T-UIREL-UP-SP	2904903	343
LS-EMLP (45X14) WH	0831693	256	LS-EMLP-AL (60X30) OG	0831602	253	LS-EMSP-AL (75,6X54)	0831618	251	MC 1,5/13-G-3,81 P20 THR	1829056	18
LS-EMLP (45X14) WH CUS	0831979	258	LS-EMLP-AL (60X30) OG CUS	0831888	253	LS-EMSP-AL (75,6X54) BK	0831629	251	MC 1,5/13-G-3,81 P20 THRR72	1828691	20
LS-EMLP (45X14) YE	0831747	257	LS-EMLP-AL (60X30) RD	0831598	253	LS-EMSP-AL (75,6X54) BK CUS	0831915	251	MC 1,5/13-GF-3,81 P20 THR	1829137	19
LS-EMLP (45X14) YE CUS	0832033	259	LS-EMLP-AL (60X30) RD CUS	0831884	253	LS-EMSP-AL (75,6X54) BU	0831646	251	MC 1,5/13-GF-3,81 P20 THRR72	1828772	21
LS-EMLP (45X15) SR	0831721	257	LS-EMLP-AL (85,6X54)	0831585	252	LS-EMSP-AL (75,6X54) BU CUS	0831932	251	MC 1,5/14-G-3,81 P20 THR	1829072	18
LS-EMLP (45X15) SR CUS	0832007	259	LS-EMLP-AL (85,6X54) BK	0831594	253	LS-EMSP-AL (75,6X54) CUS	0831904	251	MC 1,5/14-G-3,81 P20 THRR88	1828701	20
LS-EMLP (45X15) WH	0831694	256	LS-EMLP-AL (85,6X54) BK CUS	0831880	253	LS-EMSP-AL (75,6X54) GN	0831650	251	MC 1,5/14-GF-3,81 P20 THR	1829140	19
LS-EMLP (45X15) WH CUS	0831980	258	LS-EMLP-AL (85,6X54) BU	0831607	253	LS-EMSP-AL (75,6X54) GN CUS	0831936	251	MC 1,5/14-GF-3,81 P20 THRR88	1828785	21
LS-EMLP (45X15) YE	0831748	257	LS-EMLP-AL (85,6X54) BU CUS	0831893	253	LS-EMSP-AL (75,6X54) OG	0831642	251	MC 1,5/15-G-3,81 P20 THR	1829072	18
LS-EMLP (45X15) YE CUS	0832034	259	LS-EMLP-AL (85,6X54) CUS	0831871	252	LS-EMSP-AL (75,6X54) OG CUS	0831928	251	MC 1,5/15-G-3,81 P20 THRR88	1828714	20
LS-EMLP (49X15) SR	0831722	257	LS-EMLP-AL (85,6X54) GN	0831611	253	LS-EMSP-AL (75,6X54) RD	0831638	251	MC 1,5/15-GF-3,81 P20 THR	1829153	19
LS-EMLP (49X15) SR CUS	0832008	259	LS-EMLP-AL (85,6X54) GN CUS	0831897	253	LS-EMSP-AL (75,6X54) RD CUS	0831924	251	MC 1,5/15-GF-3,81 P20 THRR88	1828798	21
LS-EMLP (49X15) WH	0831695	256	LS-EMLP-AL (85,6X54) OG	0831603	253	LS-EMSP-AL (90X60)	0831619	251	MC 1,5/16-G-3,81 P20 THR	1829085	18
LS-EMLP (49X15) WH CUS	0831981	258	LS-EMLP-AL (85,6X54) OG CUS	0831889	253	LS-EMSP-AL (90X60) BK	0831630	251	MC 1,5/16-G-3,81 P20 THRR88	1828727	20
LS-EMLP (49X15) YE	0831749	257	LS-EMLP-AL (85,6X54) RD	0831599	253	LS-EMSP-AL (90X60) BK CUS	0831916	251	MC 1,5/16-GF-3,81 P20 THR	1829166	19
LS-EMLP (49X15) YE CUS	0832035	259	LS-EMLP-AL (85,6X54) RD CUS	0831885	253	LS-EMSP-AL (90X60) CUS	0831905	251	MC 1,5/16-GF-3,81 P20 THRR88	1828808	21
LS-EMLP (60X15) SR	0831723	257	LS-EMP-AL (100X60)	0831667	254	LS-EMSP-V4A (39X15)	0831653	250	MC 1,5/17-G-3,81 P20 THR	1829098	18
LS-EMLP (60X15) SR CUS	0832009	259	LS-EMP-AL (100X60) BK	0831675	255	LS-EMSP-V4A (39X15) CUS	0831939	250	MC 1,5/17-G-3,81 P20 THRR88	1828730	20
LS-EMLP (60X15) WH	0831696	256	LS-EMP-AL (100X60) BK CUS	0831961	255	LS-EMSP-V4A (50X15)	0831654	250	MC 1,5/17-GF-3,81 P20 THR	1829179	19
LS-EMLP (60X15) WH CUS	0831982	258	LS-EMP-AL (100X60) CUS	0831953	254	LS-EMSP-V4A (50X15) CUS	0831940	250	MC 1,5/17-GF-3,81 P20 THRR88	1828811	21
LS-EMLP (60X15) YE	0831750	257	LS-EMP-AL (27X15)	0831661	254	LS-EMSP-V4A (50X30)	0831655	250	MC 1,5/18-G-3,81 P20 THR	1829108	18
LS-EMLP (60X15) YE CUS	0832036	259	LS-EMP-AL (27X15) BK	0831669	255	LS-EMSP-V4A (50X30) CUS	0831941	250	MC 1,5/18-G-3,81 P20 THRR88	1828743	20
LS-EMLP (60X30) SR	0831724	257	LS-EMP-AL (27X15) BK CUS	0831955	255	LS-EMSP-V4A (75,6X54)	0831656	250	MC 1,5/18-GF-3,81 P20 THR	1829182	19
LS-EMLP (60X30) SR CUS	0832010	259	LS-EMP-AL (27X15) CUS	0831947	254	LS-EMSP-V4A (75,6X54) CUS	0831942	250	MC 1,5/18-GF-3,81 P20 THRR88	1828824	21
LS-EMLP (60X30) WH	0831697	256	LS-EMP-AL (27X18)	0831662	254	LS-EMSP-V4A (90X60)	0831657	250	MC 1,5/19-G-3,81 P20 THR	1829111	18
LS-EMLP (60X30) WH CUS	0831983	258	LS-EMP-AL (27X18) BK	0831670	255	LS-EMSP-V4A (90X60) CUS	0831943	250	MC 1,5/19-G-3,81 P20 THRR104	1828756	20
LS-EMLP (60X30) YE	0831751	257	LS-EMP-AL (27X18) BK CUS	0831956	255	LS-WMTB-AL (100X15)	0831503	247	MC 1,5/19-GF-3,81 P20 THR	1829195	19
LS-EMLP (60X30) YE CUS	0832037	259	LS-EMP-AL (27X18) CUS	0831948	254	LS-WMTB-AL (100X15) BK	0831511	247	MC 1,5/19-GF-3,81 P20 THRR104	1828837	21
LS-EMLP (85,6X54) SR	0831725	257	LS-EMP-AL (49X15)	0831663	254	LS-WMTB-AL (100X15) BK CUS	0831797	247	MC 1,5/20-G-3,81 P20 THR	1829124	18
LS-EMLP (85,6X54) SR CUS	0832011	259	LS-EMP-AL (49X15) BK	0831671	255	LS-WMTB-AL (100X15) CUS	0831789	247	MC 1,5/20-G-3,81 P20 THRR104	1828769	20
LS-EMLP (85,6X54) WH	0831698	256	LS-EMP-AL (49X15) BK CUS	0831957	255	LS-EMSP-AL (29X8)	0831500	247	MC 1,5/20-GF-3,81 P20 THR	1829205	19
LS-EMLP (85,6X54) WH CUS	0831984	258	LS-EMP-AL (49X15) CUS	0831949	254	LS-WMTB-AL (29X8) BK	0831508	247	MC 1,5/20-GF-3,81 P20 THRR104	1828840	21
LS-EMLP (85,6X54) YE	0831752	257	LS-EMP-AL (60X15)	0831664	254	LS-WMTB-AL (29X8) BK CUS	0831794	247	MCV 1,5/13-G-3,81 P20 THR	1828895	19
LS-EMLP (85,6X54) YE CUS	0832038	259	LS-EMP-AL (60X15) BK	0831672	255	LS-WMTB-AL (29X8) CUS	0831786	247	MCV 1,5/13-G-3,81 P20 THRR72	1828536	21
LS-EMLP 24 (30X12) SR	0831727	260	LS-EMP-AL (60X15) BK CUS	0831958	255	LS-WMTB-AL (40X15)	0831501	247	MCV 1,5/13-GF-3,81 P20 THR	1828976	19
LS-EMLP 24 (30X12) SR CUS	0832013	260	LS-EMP-AL (60X15) CUS	0831950	254	LS-WMTB-AL (40X15) BK	0831509	247	MCV 1,5/13-GF-3,81 P20 THRR72	1828617	21
LS-EMLP 24 (30X12) WH	0831700	260	LS-EMP-AL (60X30)	0831665	254	LS-WMTB-AL (40X15) BK CUS	0831795	247	MCV 1,5/14-G-3,81 P20 THR	1828905	19
LS-EMLP 24 (30X12) WH CUS	0831986	260	LS-EMP-AL (60X30) BK	0831673	255	LS-WMTB-AL (40X15) CUS	0831787	247	MCV 1,5/14-G-3,81 P20 THRR88	1828549	21
LS-EMLP 24 (30X12) YE	0831754	260	LS-EMP-AL (60X30) BK CUS	0831959	255	LS-WMTB-AL (60X15)	0831502	247	MCV 1,5/14-GF-3,81 P20 THR	1828989	19
LS-EMLP 24 (30X12) YE CUS	0832040	260	LS-EMP-AL (60X30) CUS	0831951	254	LS-WMTB-AL (60X15) BK	0831510	247	MCV 1,5/14-GF-3,81 P20 THRR88	1828620	21
LS-EMLP 30 (45X10) SR	0831728	261	LS-EMP-AL (85,6X54)	0831666	254	LS-WMTB-AL (60X15) BK CUS	0831796	247	MCV 1,5/15-G-3,81 P20 THR	1828918	19
LS-EMLP 30 (4											

# Index

## Alphabetical

Type	Order No.	Page	Type	Order No.	Page	Type	Order No.	Page	Type	Order No.	Page	
MCV 1,5/18-G-3,81 P20 THR	1828947	19	<b>N</b>	NLC-035-024D-041-02QRD-05A	2702031	430	PRC 5-FT25-MC6-150	1409213	77	PT-IQ-4X1+F-5DC-UT	2801216	311
MCV 1,5/18-G-3,81 P20 THRR88	1828581	21		NLC-040-024D-041-02QRD-05A	2400079	430	PRC 5-TC-FS6 8-21	1621325	76	PT-IQ-4X1-5DC-P	2800811	311
MCV 1,5/18-GF-3,81 P20 THR	1829027	19		NLC-IO-2RTD/UTH-4QTP-01A	2701671	432	PRC COVER F	1409236	76	PT-IQ-4X1-5DC-PT	2801267	311
MCV 1,5/18-GF-3,81 P20 THRR88	1828662	21		NLC-IOX-041-02QRD-05A	2702032	433	PRC COVER M	1409237	77	PT-IQ-4X1-5DC-UT	2801215	311
MCV 1,5/19-G-3,81 P20 THR	1828950	19		NLC-OP1-MKT-BASE	2701250	431	PS 6-CT-SD	3246857	171	PT-IQ-EX-H-PP	2905024	312
MCV 1,5/19-G-3,81 P20 THRR104	1828594	21	NLC-OP2-LCD-076-4X20	2701945	431	PS 6-DI-SD	3246856	171	PT-IQ-EX-L-PP	2905023	312	
MCV 1,5/19-GF-3,81 P20 THR	1829030	19	NLC-PC/SERIAL-CBL 2M	2701234	430	PS 6-VT-SD	3246858	171	PT/FS 4,8	1670497	195	
MCV 1,5/19-GF-3,81 P20 THRR104	1828675	21				PS-5	3030983	160	PTRE 6-2/10	3069855	93	
MCV 1,5/20-G-3,81 P20 THR	1828963	19				PS-5/2,3MM RD	3038723	158	PTRE 6-2/12	3069861	93	
MCV 1,5/20-G-3,81 P20 THRR104	1828604	21				PS-6	3030996	162	PTRE 6-2/14	3069863	93	
MCV 1,5/20-GF-3,81 P20 THR	1829043	19				PSBJ-URTK 6 BK	3026447	99	PTRE 6-2/15	3069864	93	
MCV 1,5/20-GF-3,81 P20 THRR104	1828688	21				PSBJ-URTK 6 BN	3026971	99	PTRE 6-2/17	3069866	93	
ME 17,5 TBUS 1,5/ 5-ST-3,81 GN	2709561	337				PSBJ-URTK 6 BU	3026434	99	PTRE 6-2/19	3069868	93	
ME 17,5 TBUS 1,5/4P1S KMGY	2201731	39				PSBJ-URTK 6 FARBLOS	3026450	99	PTRE 6-2/20	3069869	93	
ME 17,5 TBUS ADAPTER KMGY	2201757	39				PSBJ-URTK 6 GN	3026418	99	PTRE 6-2/21	3069870	93	
ME 18,8 TBUS 1,5/5-ST-3,81KMGY	2201813	35				PSBJ-URTK 6 GY	3026612	99	PTRE 6-2/22	3069871	93	
ME 22,5 TBUS 1,5/ 5-ST-3,81 GN	2707437	358	<b>P</b>	P-CO	3036796	158	PSBJ-URTK 6 RD	3026719	99	PTRE 6-2/25	3069874	93
ME 22,5 TBUS 1,5/4P1S KMGY	2201732	39		P-DI	3036783	158	PSBJ-URTK 6 VT	3026421	99	PTRE 6-2/4	3069849	93
ME 22,5 TBUS ADAPTER KMGY	2201756	39		P-FIX	3038956	158	PSBJ-URTK 6 YE	3026405	99	PTRE 6-2/5	3069850	93
ME 6,2 TBUS-2 1,5/5-ST-3,81 GN	2869728	336		P-FU 5X20	3036806	164	PSI-CAB-GSM/UMTS- 5M	2900980	394	PTRE 6-2/9	3069854	93
ME 6,2 TBUS-2 1,5/5-ST-3,81 GY	2695439	336		P-FU 5X20 LA 250-EX	3036836	163	PSI-CAB-GSM/UMTS-10M	2900981	394	PTRE 6-2/A14	3069452	109
ME-IO 18,8 B/FE 3/9U TBUS 7035	2201963	34	P-FU 5X20 LED 24-5	3209248	158	PSI-GSM/UMTS-ANT-OMNI-2-5	2900982	394	PTRE 6-2/A7	3069449	103	
ME-IO 18,8 B/FE 5/9U TBUS 7035	2201962	34	P-FU 5X20 LED 24-EX	3036821	163	PSI-GSM/UMTS-QB-ANT	2313371	394	PTRE 6-2/B14	3069453	111	
ME-IO 18,8 B/FE 7/9U TBUS 7035	2201961	34	P-FU 5X20 LED 250-5	3209264	158	PSK APS7004IOL	2700710	350	PTRE 6-2/B19	3069455	115	
ME-IO 18,8 B/FE 9/9U TBUS 7035	2201960	34	P-FU 5X20 LED 60-5	3209251	158	PSM-KA 9 SUB 25/BB/2METER	2761059	391	PTRE 6-2/B7	3069450	105	
ME-IO 18,8 C 2U 7035	2201799	35	P-FU 5X20 LED 60-EX	3036823	163	PSM-KA9SUB9/BB/2METER	2799474	391	PTRE 6-2/C14	3069454	113	
ME-IO 18,8 C 3U 7035	2201800	35	P-FU 5X20-5	3209235	158	PSR-PIP-24DC/MXF1/4X1/2X2/B	2903253	401	PTRE 6-2/C19	3069456	117	
ME-IO 18,8 C 3U S1 7035	2201801	35	P-FU 5X20-EX	3036807	163	PSR-PIP-24DC/MXF2/4X1/2X2/B	2903256	401	PTRE 6-2/D19	3069457	119	
ME-IO 18,8 C 4U 7035	2201802	35	P-FU 6,3X32 LA 250-EX	3046525	163	PSR-PIP-24DC/MXF3/4X1/2X2/B	2903259	401	PTRE 6-2/E7	3069451	107	
ME-IO 18,8 C 5U 7035	2201803	35	P-FU 6,3X32 LED 24-EX	3046509	163	PSR-PIP-24DC/MXF4/4X1/2X2/B	2903262	401	PTRE 6-2/F19	3069458	121	
ME-IO 18,8 C 6U 7035	2201804	35	P-FU 6,3X32 LED 60-EX	3046512	163	PSR-SCP- 24DC/MXF1/4X1/2X2/B	2902725	400	PTRE 6-2/G19	3069459	123	
ME-IO 18,8 C 7U 7035	2201805	35	P-FU 6,3X32-EX	3046499	163	PSR-SCP- 24DC/TS/M	2986012	402	PTRE 6-2/H19	3069460	125	
ME-SAS	2853899	391	PACT RCP-4000A-1A-D140	2904922	353	PSR-SCP- 24DC/TS/SDOR4/4X1	2986096	402	PTRE 6-2/I19	3069461	127	
MICROFOX-SP-1	1212487	44	PACT RCP-4000A-1A-D190	2904923	353	PSR-SCP-24DC/MXF2/4X1/2X2/B	2903254	400	PTSM 0,5/ 1-2,5-H SMD WH L R24	1840035	23	
MINI FD BLUETOOTH	0830986	289	PACT RCP-4000A-1A-D95	2904921	353	PSR-SCP-24DC/MXF3/4X1/2X2/B	2903257	400	PTSM 0,5/ 2-HTB-2,5-SMD WH R32	1830126	23	
MINI MCR-2-FM-RC	2904504	338	PACT RCP-CLAMP	2904895	353	PSR-SCP-24DC/MXF4/4X1/2X2/B	2903260	400	PTSM 0,5/ 2-HV-2,5-SMD WH R32	1778696	23	
MINI MCR-2-FM-RC-PT	2904508	338	PAI-4-N GY	3032871	162	PSR-SPP- 24DC/TS/M	2986025	402	PTSM 0,5/ 3-HTB-2,5-SMD WH R32	1830139	23	
MINI MCR-2-I-I	2901998	328	PBR 42A BU	2201916	38	PSR-SPP- 24DC/TS/SDOR4/4X1	2986106	402	PTSM 0,5/ 3-HV-2,5-SMD WH R32	1778706	23	
MINI MCR-2-I-I-PT	2901999	328	PBR 42A KMGY	2201917	38	PSR-SPP-24DC/MXF1/4X1/2X2/B	2902726	400	PTSM 0,5/ 4-HTB-2,5-SMD WH R44	1830142	23	
MINI MCR-2-I0-U	2902000	328	PBR 42A RD	2201915	38	PSR-SPP-24DC/MXF2/4X1/2X2/B	2903255	400	PTSM 0,5/ 4-HTB-2,5-SMD WH R44	1778719	23	
MINI MCR-2-I0-U-PT	2902001	328	PC-FTP-TRI	3069898	99	PSR-SPP-24DC/MXF3/4X1/2X2/B	2903258	400	PTSM 0,5/ 5-HTB-2,5-SMD WH R44	1830155	23	
MINI MCR-2-I4-U	2902002	328	PC-UTWE-TRI	3069897	99	PSR-SPP-24DC/MXF4/4X1/2X2/B	2903261	400	PTSM 0,5/ 5-HV-2,5-SMD WH R44	1778722	23	
MINI MCR-2-I4-U-PT	2902003	328	PCO 17,5-L KMGY	2201684	38	PSR-TBUS	2890425	402	PTSM 0,5/ 6-HTB-2,5-SMD WH R44	1830168	23	
MINI MCR-2-POT-UI	2902016	334	PCO 22,5-L KMGY	2201685	38	PT 1,5/S-MT	3210301	156	PTSM 0,5/ 6-HV-2,5-SMD WH R44	1778735	23	
MINI MCR-2-POT-UI-C	2905005	334	PLC-LOGIC-STARTERKIT1	2905504	359	PT 1,5/S-MT BU	3210302	156	PTSM 0,5/ 7-HTB-2,5-SMD WH R44	1830171	23	
MINI MCR-2-POT-UI-PT	2902017	334	PLC-OPT- 24DC/230AC/2,4/ACT	2904632	366	PT 1,5/S-MTD	3210308	156	PTSM 0,5/ 7-HV-2,5-SMD WH R44	1778748	23	
MINI MCR-2-POT-UI-PT-C	2905006	334	PLC-OSC- 24DC/230AC/2,4/ACT	2904631	366	PT 1,5/S-MTD BU	3210309	156	PTSM 0,5/ 8-HTB-2,5-SMD WH R44	1830184	23	
MINI MCR-2-PTB	2902066	336	PLC-V8C/CAB/TBUS/0,3M	2905263	358	PT 1,5/S-QUATTRO-MT	3210321	157	PTSM 0,5/ 8-HV-2,5-SMD WH R44	1778751	23	
MINI MCR-2-PTB-PT	2902067	336	PLC-V8C/PT-24DC/BM	2905135	357	PT 1,5/S-QUATTRO-MT BU	3210322	157	PTT 1,5/S-2L	3210356	157	
MINI MCR-2-PPSS-I-I	2902014	329	PLC-V8C/PT-24DC/EM	2905137	357	PT 1,5/S-QUATTRO-MTD	3210328	157	PTT 1,5/S-2L BU	3210357	157	
MINI MCR-2-PPSS-I-I-PT	2902015	329	PLC-V8C/PT-24DC/SAM	2905136	356	PT 1,5/S-QUATTRO-MTD BU	3210329	157	PTT 1,5/S-2MT	3210351	157	
MINI MCR-2-RTD-UI	2902049	330	PLC-V8C/SC-24DC/BM	2903094	357	PT 1,5/S-TWIN-MT	3210311	157	PTT 1,5/S-2MT BU	3210352	157	
MINI MCR-2-RTD-UI-C	2902048	330	PLC-V8C/SC-24DC/EM	2903095	357	PT 1,5/S-TWIN-MT BU	3210312	157	PTT 1,5/S-LMT	3210341	157	
MINI MCR-2-RTD-UI-PT	2902052	330	PLC-V8C/SC-24DC/SAM	2905082	356	PT 1,5/S-TWIN-MTD	3210317	157	PTT 1,5/S-LMT BU	3210342	157	
MINI MCR-2-RTD-UI-PT-C	2902051	330	PMST (9X38)	0830960	285	PT 1,5/S-TWIN-MTD BU	3210319	157	PTT 2,5-2L	3210267	159	
MINI MCR-2-TB	2902068	338	PMST (9X38) BK	0830965	285	PT-IQ-1X2-EX-24DC-P	2801514	312	PTT 2,5-2L BU	3210268	159	
MINI MCR-2-TC-UI	2902055	332	PMST (9X38) BN	0830968	285	PT-IQ-1X2-EX-24DC-UT	2801512	312	PTT 2,5-2MT	3210258	159	
MINI MCR-2-TC-UI-C	2902053	332	PMST (9X38) BU	0830969	285	PT-IQ-2X2+F-48DC-PT	2801266	311	PTT 2,5-2MT BU	3210265	159	
MINI MCR-2-TC-UI-PT	2905249	332	PMST (9X38) GN	0830961	285	PT-IQ-2X2+F-48DC-UT	2800987	311	PTT 2,5-LMT	3210251	159	
MINI MCR-2-TC-UI-PT-C	2905248	332	PMST (9X38) GY	0830963	285	PT-IQ-2X2+F-5DC-PT	2801260	311	PTT 2,5-LMT BU	3210257	159	
MINI MCR-2-U-I0	2902022	328	PMST (9X38) OG	0830966	285	PT-IQ-2X2+F-5DC-UT	2800809	311	PTT 2,5-LTG	3210230	158	
MINI MCR-2-U-I0-PT	2902023	328	PMST (9X38) RD	0830962	285	PT-IQ-2X2-48DC-P	2800810	310	PTT 2,5-LTG BU	3210270	158	
MINI MCR-2-U-I4	2902029	328	PMST (9X38) VT	0830967	285	PT-IQ-2X2-48DC-PT	2801265	310	PTTBS 2,5-2MTB	3210400	161	
MINI MCR-2-U-I4-PT	2902030	328	PMST (9X38) YE	0830964	285	PT-IQ-2X2-48DC-UT	2800986	310	PTTBS 2,5-2MTB BU	3210401	161	
MINI MCR-2-U-U	2902042	328	PRC 3-FC-FS6 8-12	1410658	76	PT-IQ-2X2-5DC-P	2800802	310	PTTBS 2,5-2TGB	3210402	160	
MINI MCR-2-U-U-PT	2902043	328	PRC 3-FC-FS6 8-21	1410661	76	PT-IQ-2X2-5DC-PT	2801259	310	PTWE 6-2/10	3069833	92	
MINI MCR-2-UI-UI	2902037	326	PRC 3-FC-FS6 12-16	1409217	76	PT-IQ-2X2-5DC-UT	2800807	310	PTWE 6-2/12	3069835	92	
MINI MCR-2-UI-UI-C	2902036	326	PRC 3-FC-FS6 16-21	1410659	76	PT-IQ-2X2-EX-24DC-P	2801515	312	PTWE 6-2/14	3069837	92	
MINI MCR-2-UI-UI-PT	2902040	326	PRC 3-FT25-MC	1409218	77	PT-IQ-2X2-EX-24DC-UT	2801513	312	PTWE 6-2/15	3069838	92	
MINI MCR-2-UI-UI-PT-C	2902039	326	PRC 3-FT25-MC2,5-150	1409219	77	PT-IQ-3-HF-F-12DC-PT	2801289	313	PTWE 6-2/17	3069840	92	
MINI-PS-100-240AC/24DC/1,5/EX	2866653	337	PRC 3-FT25-MC4-150	1409220	77	PT-IQ-3-HF-F-12DC-UT	2800995	313	PTWE 6-2/19	3069842	92	
MINI-SYS-PS-100-240AC/24DC/1,5	2866983	337	PRC 3-FT25-MC6-150	1409221	77	PT-IQ-3-HF-12DC-P	2800784	313	PTWE 6-2/20	3069843	92	
MPB 18/1-57	2809328	156	PRC 3-TC-FS6 8-21	1621326	76	PT-IQ-3-HF-12DC-UT	2801288	313	PTWE 6-2/21	3069844	92	
MPS-IH RD	0201676	156	PRC 5-FC-FS6 8-12									



Type	Order No.	Page	Type	Order No.	Page	Type	Order No.	Page	Type	Order No.	Page
PTWE 6-2/B14	3069440	110	QPD W 4PE2,5 6-11 M25 0,5 EX	1411387	192	SAC-2P- 5,0-PUR/SUSFS	1410750	181	SACC-DSI-M12F5B-5P-M16XL/0,5	1411587	54
PTWE 6-2/B19	3069442	114	QPD W 4PE2,5 6-11 M25 1,0 EX	1411388	192	SAC-2P-10,0-PUR/DTFS	1410727	182	SACC-DSI-M12FSD-4P-M16XL/0,5	1411585	54
PTWE 6-2/B7	3069437	104	QPD W 4PE2,5 6-11 M25 DT BK	1411432	191	SAC-2P-10,0-PUR/DTFS-1L	1410731	182	SACC-DSI-M12FSS-3P-M16/0,5 PE	1411652	58
PTWE 6-2/C14	3069441	112	QPD W 4PE2,5 6-11 M25 DT GY	1411434	191	SAC-2P-10,0-PUR/DTFS-1L-S	1410735	183	SACC-DSI-M12FSS-4P-M16XL/0,5PE	1411598	56
PTWE 6-2/C19	3069443	116	QPD W 4PE2,5 6-11 M25 FC EX	1411389	192	SAC-2P-10,0-PUR/SUSFS	1410751	181	SACC-DSI-M12FST-4P-M16XL/0,5	1411599	56
PTWE 6-2/D19	3069444	118	QPD W 4PE2,5 9-16 M20 0,5 EX	1411397	192	SAC-2P-MSB-FSB SCO/910/...	1538092	396	SACC-DSI-M12MS-12P-M16XL/0,5	1411596	54
PTWE 6-2/E7	3069438	106	QPD W 4PE2,5 9-16 M20 1,0 EX	1411398	192	SAC-2P-MSB/ 1,0-910/FSB SCO	1518122	396	SACC-DSI-M12MS-17P-M16XL/0,5	1411597	54
PTWE 6-2/F19	3069445	120	QPD W 4PE2,5 9-16 M20 FC EX	1411399	192	SAC-2P-SUSMS/ 0,3-PUR/SUSFS	1410757	181	SACC-DSI-M12MS-4P-M16XL/0,5	1411591	54
PTWE 6-2/G19	3069446	122	QPD W 4PE2,5 9-16 M25 0,5 EX	1411390	192	SAC-2P-SUSMS/ 0,6-PUR/SUSFS	1410759	181	SACC-DSI-M12MS-5P-M16XL/0,5	1411593	54
PTWE 6-2/H19	3069447	124	QPD W 4PE2,5 9-16 M25 1,0 EX	1411391	192	SAC-2P-SUSMS/ 1,5-PUR	1410752	181	SACC-DSI-M12MS-8P-M16XL/0,5	1411595	54
PTWE 6-2/I19	3069448	126	QPD W 4PE2,5 9-16 M25 DT BK	1411433	191	SAC-2P-SUSMS/ 1,5-PUR/SUSFS	1410760	181	SACC-DSI-M12MSB-5P-M16XL/0,5	1411594	54
PV-MI-CABLE SPLICE 3P	1812403	72	QPD W 4PE2,5 9-16 M25 DT GY	1411435	191	SAC-2P-SUSMS/ 3,0-PUR	1410753	181	SACC-DSI-M12MSD-4P-M16XL/0,5	1411592	54
PV-MI-CABLE TERMINATOR 3P	1812416	72	QPD W 4PE2,5 9-16 M25 FC EX	1411392	192	SAC-2P-SUSMS/ 3,0-PUR/SUSFS	1410761	181	SACC-DSI-M12MSS-3P-M16/0,5 PE	1411653	58
PV-MI-YC-1,15-3-12-NA-0,50-OE	1706518	70	QPD W 4PE6,0 12-20 M25 0,5 BK	1410394	193	SAC-2P-SUSMS/ 5,0-PUR	1410755	181	SACC-DSI-M12MSS-4P-M16XL/0,5PE	1411603	56
PV-MI-YC-1,15-3-25-EU-0,50-OE	1621351	70	QPD W 4PE6,0 12-20 M25 0,5 GY	1410401	193	SAC-2P-SUSMS/10,0-PUR	1410756	181	SACC-DSI-M12MST-4P-M16XL/0,5	1411604	56
PV-MI-YC-CARRIER-CAP-TP	1706808	70	QPD W 4PE6,0 12-20 M25 1,0 BK	1410395	193	SAC-3P- 1,0-PVC/FRS PE SCO	1411648	184	SACC-E-M12FS-12P-M16XL/0,5	1411574	55
PV-MI-YC-CARRIER-CAP-TS	1706599	70	QPD W 4PE6,0 12-20 M25 1,0 GY	1410402	193	SAC-3P- 1,0-PVC/FSB PE SCO	1411644	184	SACC-E-M12FS-17P-M16XL/0,5	1411576	55
PV-MI-YC-GC-P-1,00-3-12-NA SET	1707091	70	QPD W 4PE6,0 9-14 M25 0,5 BK	1410392	193	SAC-3P- 1,5-PUO/A-1L-Z OD	1407287	180	SACC-E-M12FS-4P-M16XL/0,5	1411568	55
PV-MI-YC-GC-P-1,00-3-25-EU SET	1621349	70	QPD W 4PE6,0 9-14 M25 0,5 GY	1410399	193	SAC-3P- 1,5-PUR/A-1L-R-ES 4A	1400827	177	SACC-E-M12FS-5P-M16XL/0,5	1411571	55
PV-MI-YC-GC-S-1,00-3-12-NA SET	1707092	71	QPD W 4PE6,0 9-14 M25 1,0 BK	1410393	193	SAC-3P- 1,5-PUR/B-1L-R-ES	1401294	177	SACC-E-M12FS-8P-M16XL/0,5	1411573	55
PV-MI-YC-GC-S-1,00-3-25-EU SET	1621350	71	QPD W 4PE6,0 9-14 M25 1,0 GY	1410400	193	SAC-3P- 1,5-PUR/BI-1L-R-ES	1401340	178	SACC-E-M12FSB-5P-M16XL/0,5	1411572	55
PV-MI-YC-PATCH-1,00-3-12-NA	1707091	70	QPD W 4PE6,0 M25 0,5 BK	1410396	193	SAC-3P- 1,5-PUR/C-1L-R-ES	1401434	178	SACC-E-M12MSS-4P-M16XL/0,5	1411569	55
PV-MI-YC-PATCH-1,00-3-25-EU	1621352	71	QPD W 4PE6,0 M25 0,5 GY	1410403	193	SAC-3P- 1,5-PUR/CI-1L-R-ES	1401466	179	SACC-E-M12FSS-3P-M16/0,5 PE	1411654	58
PV-MI-YC-PROTECTION-CAP-TP	1706610	70	QPD W 4PE6,0 M25 1,0 BK	1410397	193	SAC-3P- 2,0-PVC/FRS PE SCO	1411649	184	SACC-E-M12FSS-4P-M16XL/0,5 PE	1411605	57
PV-MI-YC-PROTECTION-CAP-TS	1706515	70	QPD W 4PE6,0 M25 1,0 GY	1410404	193	SAC-3P- 2,0-PVC/FSB PE SCO	1411645	184	SACC-E-M12FST-4P-M16XL/0,5	1411606	57
PV-MI-YC-UNLOCKTOOL	1706514	70	QSS 15	1641992	195	SAC-3P- 3,0-PUR/A-1L-Z OD	1407288	180	SACC-E-M12MSS-4P-M16XL/0,5	1411582	55
PWO 16-UW	1844387	29	QSS 19	1670895	195	SAC-3P- 3,0-PUR/A-1L-R-ES 4A	1401131	177	SACC-E-M12MS-17P-M16XL/0,5	1411583	55
PWO 16-UW/S	1844390	29	QSS 22	1670206	195	SAC-3P- 3,0-PUR/B-1L-R-ES	1401295	177	SACC-E-M12MS-4P-M16XL/0,5	1411577	55
			QSS 24	1670219	195	SAC-3P- 3,0-PUR/BI-1L-R-ES	1401350	178	SACC-E-M12MS-5P-M16XL/0,5	1411579	55
			QSS 27	1670646	195	SAC-3P- 3,0-PUR/C-1L-R-ES	1401435	178	SACC-E-M12MS-8P-M16XL/0,5	1411581	55
			QTC 2,5-QUATTRO	3206446	173	SAC-3P- 3,0-PUR/CI-1L-R-ES	1401542	179	SACC-E-M12MSB-5P-M16XL/0,5	1411580	55
			QTC 2,5-QUATTRO BU	3206447	173	SAC-3P- 5,0-PUO/A-1L-Z OD	1407289	180	SACC-E-M12MSD-4P-M16XL/0,5	1411578	55
						SAC-3P- 5,0-PUR/A-1L-R-ES 4A	1401136	177	SACC-E-M12MSS-3P-M16/0,5 PE	1411655	58
						SAC-3P- 5,0-PUR/B-1L-R-ES	1401338	177	SACC-E-M12MSS-4P-M16XL/0,5 PE	1411607	57
						SAC-3P- 5,0-PUR/BI-1L-R-ES	1401358	178	SACC-E-M12MST-4P-M16XL/0,5	1411608	57
						SAC-3P- 5,0-PUR/C-1L-R-ES	1401448	178	SACC-M12MRD-4CT SH PN	1411047	185
						SAC-3P- 5,0-PUR/CI-1L-R-ES	1401544	179	SACC-M12MSD-4CT SH PN	1411046	185
						SAC-3P- 5,0-PVC/FRS PE SCO	1411650	184	SAFE AI	2400057	406
						SAC-3P- 5,0-PVC/FSB PE SCO	1411646	184	SCRT 9X16-27	0830970	285
						SAC-3P-10,0-PUO/A-1L-Z OD	1407290	180	SCRT 9X25-40	0830971	285
						SAC-3P-10,0-PUR/A-1L-R-ES 4A	1401168	177	SCRT 9X40-60	0830972	285
						SAC-3P-10,0-PUR/B-1L-R-ES	1401339	177	SCRT 9X60-80	0830973	285
						SAC-3P-10,0-PUR/BI-1L-R-ES	1401359	178	SCRT 9X80-100	0830974	285
						SAC-3P-10,0-PUR/CI-1L-R-ES	1401465	178	SCRT 9X100-120	0830975	285
						SAC-3P-10,0-PUR/CI-1L-R-ES	1401617	179	SCRT 9X140-160	0830976	285
						SAC-3P-10,0-PVC/FRS PE SCO	1411651	184	SCRT 9X160-180	0830977	285
						SAC-3P-10,0-PVC/FSB PE SCO	1411647	184	SCRT 9X180-200	0830978	285
						SAC-3P-MRS/ 1,0-PVC PE SCO	1411640	184	SD FLASH 2GB	2988162	387
						SAC-3P-MRS/ 2,0-PVC PE SCO	1411641	184	SD FLASH 2GB EMWISE EXTENDED	2701747	348
						SAC-3P-MRS/ 5,0-PVC PE SCO	1411642	184	SD FLASH 2GB EMWISE IMP ANALOG	2701746	348
						SAC-3P-MRS/10,0-PVC PE SCO	1411643	184	SD FLASH 2GB EMWISE IMPULS	2701745	348
						SAC-3P-MSS/ 1,0-PVC PE SCO	1411636	184	SD FLASH 512MB	2988146	380
						SAC-3P-MSS/ 2,0-PVC PE SCO	1411637	184	SD FLASH 512MB ILDLF FLEX	2701873	349
						SAC-3P-MSS/ 5,0-PVC PE SCO	1411638	184	SD FLASH 512MB MODULAR MUX	2701872	429
						SAC-3P-MSS/10,0-PVC PE SCO	1411639	184	SEALING PLUG 10X16 RD	1400284	195
						SAC-4PY-MT/2XFT VP	1410632	186	SEALING PLUG 14X22 RD	1400270	195
						SAC-5P- 1,5-PUO/AD-2L OD	1407291	180	SF-08KP010	1621574	66
						SAC-5P- 2,0-92X/M12FS SH OD	1410474	187	SF-08KP020	1621575	66
						SAC-5P- 3,0-PUO/AD-2L OD	1407292	180	SF-08KS010	1621571	66
						SAC-5P- 5,0-92X/M12FS SH OD	1410494	187	SF-08KS020	1621573	66
						SAC-5P- 5,0-PUO/AD-2L OD	1407293	180	SF-20KP021	1621579	66
						SAC-5P-10,0-92X/M12FS SH OD	1410496	187	SF-20KP022	1621580	66
						SAC-5P-10,0-PUO/AD-2L OD	1407294	180	SF-20KP023	1621581	66
						SAC-5P-M12FS CAN TR	1529344	396	SF-20KS021	1621576	66
						SAC-5P-M12FS PB TR	1403911	396	SF-20KS022	1621577	66
						SAC-5P-M12MS CAN TR	1507816	396	SF-20KS023	1621578	66
						SAC-5P-M12MS PB TR	1507803	396	SF-BIT-HEX 3-50	1212647	222
						SAC-5P-M12MS/ 2,0-92X SH OD	1410471	187	SF-M BH	1212070	222
						SAC-5P-M12MS/ 5,0-92X SH OD	1410472	187	SF-SL 0,6X3,5-100 S-VDE	1212587	170
						SAC-5P-M12MS/10,0-92X SH OD	1410473	187	SF-SL 0,8X4,0-100	1212551	92
						SAC-5P-M12MS/2,0-92X/M12FSSHOD	1410467	187	SH-8EPC58A8L1B1S	1621533	62
						SAC-5P-M12MS/5,0-92X/M12FSSHOD	1410470	187	SH-8EPC58A8L2B2S	1621532	62
						SAC-5P-MS-FS SCO/920/...	1538157	396	SH-8EPC58A8L3B3S	1621531	62
						SAC-5P-MS/ 1,0-920/FS SCO	1518274	396	SH-8EPC58A8L4B4S	1621530	62
						SACC-CC1,0-T-0,50-M AU PU100	1412351	185	SH-8EPC58A8L5B5S	1621529	62
						SACC-DSI-M12FS-12P-M16XL/0,5	1411589	54	SH-8EPC58A9L1B1S	1621533	62
						SACC-DSI-M12FS-17P-M16XL/0,5	1411590	54	SH-8EPC58A9L2B2S	1621532	62
						SACC-DSI-M12FS-4P-M16XL/0,5	1411584	54	SH-8EPC58A9L3B3S	1621531	62
						SACC-DSI-M12FS-5P-M16XL/0,5	1411586	54	SH-8EPC58A9L4B4S	1621530	62
						SACC-DSI-M12FS-8P-M16XL/0,5	1411588	54	SH-8EPC58A9L5B5S	1621529	62

# Index

## Alphabetical

Type	Order No.	Page	Type	Order No.	Page	Type	Order No.	Page	Type	Order No.	Page
SH-8EPC58AAC00S	1621561	65	SPT-SMD 1,5/ 6-V-3,81 R44	1824239	7	SPT-THR 1,5/ 3-V-5,0 P26	1822545	13	SPT-THR 1,5/ 8-V-5,0 P26	1822590	13
SH-8EPC58AAD00S	1621565	65	SPT-SMD 1,5/ 6-V-5,0 R44	1824349	9	SPT-THR 1,5/ 3-V-5,08 P20 R32	1823531	13	SPT-THR 1,5/ 8-V-5,08 P20 R88	1823586	13
SH-8EPC58AWA00S	1621569	64	SPT-SMD 1,5/ 6-V-5,08 R44	1824459	9	SPT-THR 1,5/ 3-V-5,08 P26	1822655	13	SPT-THR 1,5/ 8-V-5,08 P26	1822707	13
SH-8EPS48A8LB1S	1621538	62	SPT-SMD 1,5/ 7-H-3,5 R44	1824572	7	SPT-THR 1,5/ 4-H-3,5 P20 R32	1823654	11	SPT-THR 1,5/ 9-H-3,5 P20 R72	1823706	11
SH-8EPS48A8LB2S	1621537	62	SPT-SMD 1,5/ 7-H-3,81 R44	1824682	7	SPT-THR 1,5/ 4-H-3,5 P26	1822778	10	SPT-THR 1,5/ 9-H-3,5 P26	1822820	10
SH-8EPS48A8LB3S	1621536	62	SPT-SMD 1,5/ 7-H-5,0 R88	1824792	9	SPT-THR 1,5/ 4-H-3,81 P20 R32	1823764	11	SPT-THR 1,5/ 9-H-3,81 P20 R72	1823816	11
SH-8EPS48A8LB4S	1621535	62	SPT-SMD 1,5/ 7-H-5,08 R88	1824909	9	SPT-THR 1,5/ 4-H-3,81 P26	1822888	10	SPT-THR 1,5/ 9-H-3,81 P26	1822930	10
SH-8EPS48A8LDLS	1621534	62	SPT-SMD 1,5/ 7-V-3,5 R44	1824132	7	SPT-THR 1,5/ 4-H-5,0 P20 R32	1823874	13	SPT-THR 1,5/ 9-H-5,0 P20 R88	1823926	13
SH-8EPS48A9LB1S	1621558	63	SPT-SMD 1,5/ 7-V-3,81 R44	1824242	7	SPT-THR 1,5/ 4-H-5,0 P26	1822998	12	SPT-THR 1,5/ 9-H-5,0 P26	1823049	12
SH-8EPS48A9LB2S	1621557	63	SPT-SMD 1,5/ 7-V-5,0 R88	1824352	9	SPT-THR 1,5/ 4-H-5,08 P20 R32	1823984	13	SPT-THR 1,5/ 9-H-5,08 P20 R88	1824035	13
SH-8EPS48A9LB3S	1621556	63	SPT-SMD 1,5/ 7-V-5,08 R88	1824462	9	SPT-THR 1,5/ 4-H-5,08 P26	1823104	12	SPT-THR 1,5/ 9-H-5,08 P26	1823159	12
SH-8EPS48A9LB4S	1621555	63	SPT-SMD 1,5/ 8-H-3,5 R72	1824585	7	SPT-THR 1,5/ 4-V-3,5 P20 R44	1823214	11	SPT-THR 1,5/ 9-V-3,5 P20 R72	1823269	11
SH-8EPS48A9LDLS	1621554	63	SPT-SMD 1,5/ 8-H-3,81 R72	1824695	7	SPT-THR 1,5/ 4-V-3,5 P26	1822338	11	SPT-THR 1,5/ 9-V-3,5 P26	1822383	11
SH-8EPS48AAC00S	1621562	65	SPT-SMD 1,5/ 8-H-5,0 R88	1824802	9	SPT-THR 1,5/ 4-V-3,81 P20 R44	1823324	11	SPT-THR 1,5/ 9-V-3,81 P20 R72	1823379	11
SH-8EPS48AAD00S	1621566	65	SPT-SMD 1,5/ 8-H-5,08 R88	1824912	9	SPT-THR 1,5/ 4-V-3,81 P26	1822448	11	SPT-THR 1,5/ 9-V-3,81 P26	1822493	11
SH-8EPS48AWA00S	1621570	64	SPT-SMD 1,5/ 8-V-3,5 R72	1824145	7	SPT-THR 1,5/ 4-V-5,0 P20 R56	1823434	13	SPT-THR 1,5/ 9-V-5,0 P20 R88	1823489	13
SH-8ESC58A8LB1S	1621523	62	SPT-SMD 1,5/ 8-V-3,81 R72	1824255	7	SPT-THR 1,5/ 4-V-5,0 P26	1822558	13	SPT-THR 1,5/ 9-V-5,0 P26	1822600	13
SH-8ESC58A8LB2S	1621522	62	SPT-SMD 1,5/ 8-V-5,0 R88	1824365	9	SPT-THR 1,5/ 8-V-5,0 P20 R56	1823544	13	SPT-THR 1,5/ 9-V-5,08 P20 R88	1823599	13
SH-8ESC58A8LB3S	1621521	62	SPT-SMD 1,5/ 8-V-5,08 R88	1824475	9	SPT-THR 1,5/ 4-V-5,08 P26	1822668	13	SPT-THR 1,5/ 9-V-5,08 P26	1822710	13
SH-8ESC58A8LB4S	1621520	62	SPT-SMD 1,5/ 9-H-3,5 R72	1824598	7	SPT-THR 1,5/ 5-H-3,5 P20 R32	1823667	11	SPT-THR 1,5/ 10-H-3,5 P20 R72	1823719	11
SH-8ESC58A8LDLS	1621517	62	SPT-SMD 1,5/ 9-H-3,81 R72	1824705	7	SPT-THR 1,5/ 5-H-3,5 P26	1822781	10	SPT-THR 1,5/ 10-H-3,5 P26	1822833	10
SH-8ESC58A9LB1S	1621543	63	SPT-SMD 1,5/ 9-H-5,0 R88	1824815	9	SPT-THR 1,5/ 5-H-3,81 P20 R32	1823777	11	SPT-THR 1,5/ 10-H-3,81 P20 R72	1823829	11
SH-8ESC58A9LB2S	1621542	63	SPT-SMD 1,5/ 9-H-5,08 R88	1824925	9	SPT-THR 1,5/ 5-H-3,81 P26	1822891	10	SPT-THR 1,5/ 10-H-3,81 P26	1822943	10
SH-8ESC58A9LB3S	1621541	63	SPT-SMD 1,5/ 9-V-3,5 R72	1824158	7	SPT-THR 1,5/ 5-H-5,0 P20 R56	1823887	13	SPT-THR 1,5/ 10-H-5,0 P20 R88	1823939	13
SH-8ESC58A9LB4S	1621540	63	SPT-SMD 1,5/ 9-V-3,81 R72	1824268	7	SPT-THR 1,5/ 5-H-5,0 P26	1823007	12	SPT-THR 1,5/ 10-H-5,0 P26	1823052	12
SH-8ESC58A9LDLS	1621539	63	SPT-SMD 1,5/ 9-V-5,0 R88	1824378	9	SPT-THR 1,5/ 5-V-3,81 P20 R56	1823997	13	SPT-THR 1,5/ 10-H-5,08 P20 R88	1824048	13
SH-8ESC58AAC00S	1621559	65	SPT-SMD 1,5/ 9-V-5,08 R88	1824488	9	SPT-THR 1,5/ 5-H-5,08 P26	1823117	12	SPT-THR 1,5/ 10-H-5,08 P26	1823162	12
SH-8ESC58AAD00S	1621563	65	SPT-SMD 1,5/ 10-H-3,5 R72	1824608	7	SPT-THR 1,5/ 5-V-3,5 P20 R44	1823227	11	SPT-THR 1,5/ 10-V-3,5 P20 R72	1823272	11
SH-8ESC58AWA00S	1621567	64	SPT-SMD 1,5/ 10-H-3,81 R72	1824718	7	SPT-THR 1,5/ 5-V-3,5 P26	1822341	11	SPT-THR 1,5/ 10-V-3,5 P26	1822396	11
SH-8ESS48A8LB1S	1621528	62	SPT-SMD 1,5/ 10-H-5,0 R88	1824828	9	SPT-THR 1,5/ 5-V-3,81 P20 R44	1823337	11	SPT-THR 1,5/ 10-V-3,81 P20 R72	1823382	11
SH-8ESS48A8LB2S	1621527	62	SPT-SMD 1,5/ 10-H-5,08 R88	1824938	9	SPT-THR 1,5/ 5-V-3,81 P26	1822451	11	SPT-THR 1,5/ 10-V-3,81 P26	1822503	11
SH-8ESS48A8LB3S	1621526	62	SPT-SMD 1,5/ 10-V-3,5 R72	1824161	7	SPT-THR 1,5/ 5-V-5,0 P20 R56	1823447	13	SPT-THR 1,5/ 10-V-5,0 P20 R88	1823492	13
SH-8ESS48A8LB4S	1621525	62	SPT-SMD 1,5/ 10-V-3,81 R72	1824271	7	SPT-THR 1,5/ 5-V-5,0 P26	1822561	13	SPT-THR 1,5/ 10-V-5,0 P26	1822613	13
SH-8ESS48A8LDLS	1621524	62	SPT-SMD 1,5/ 10-V-5,0 R88	1824381	9	SPT-THR 1,5/ 5-V-5,08 P20 R56	1823557	13	SPT-THR 1,5/ 10-V-5,08 P20 R88	1823609	13
SH-8ESS48A9LB1S	1621548	63	SPT-SMD 1,5/ 10-V-5,08 R88	1824491	9	SPT-THR 1,5/ 5-V-5,08 P26	1822671	13	SPT-THR 1,5/ 10-V-5,08 P26	1822723	13
SH-8ESS48A9LB2S	1621547	63	SPT-SMD 1,5/ 11-H-3,5 R72	1824611	7	SPT-THR 1,5/ 6-H-3,5 P20 R44	1823670	11	SPT-THR 1,5/ 11-H-3,5 P20 R72	1823722	11
SH-8ESS48A9LB3S	1621546	63	SPT-SMD 1,5/ 11-H-3,81 R72	1824721	7	SPT-THR 1,5/ 6-H-3,5 P26	1822794	10	SPT-THR 1,5/ 11-H-3,5 P26	1822846	10
SH-8ESS48A9LB4S	1621545	63	SPT-SMD 1,5/ 11-H-5,0 R88	1824831	9	SPT-THR 1,5/ 6-H-3,81 P20 R44	1823780	11	SPT-THR 1,5/ 11-H-3,81 P20 R72	1823832	11
SH-8ESS48A9LDLS	1621544	63	SPT-SMD 1,5/ 11-H-5,08 R88	1824941	9	SPT-THR 1,5/ 6-H-3,81 P26	1822901	10	SPT-THR 1,5/ 11-H-3,81 P26	1822956	10
SH-8ESS48AAC00S	1621560	65	SPT-SMD 1,5/ 11-V-3,5 R72	1824174	7	SPT-THR 1,5/ 6-H-5,0 P20 R56	1823890	13	SPT-THR 1,5/ 11-H-5,0 P20 R88	1823942	13
SH-8ESS48AAD00S	1621564	65	SPT-SMD 1,5/ 11-V-3,81 R72	1824284	7	SPT-THR 1,5/ 6-H-5,0 P26	1823010	12	SPT-THR 1,5/ 11-H-5,0 P26	1823065	12
SH-8ESS48AWA00S	1621568	64	SPT-SMD 1,5/ 11-V-5,0 R88	1824394	9	SPT-THR 1,5/ 6-H-5,08 P20 R56	1824006	13	SPT-THR 1,5/ 11-H-5,08 P20 R88	1824051	13
SK 5,0 WH:REEL	0805221	339	SPT-SMD 1,5/ 11-V-5,08 R88	1824501	9	SPT-THR 1,5/ 6-H-5,08 P26	1823120	12	SPT-THR 1,5/ 11-H-5,08 P26	1823175	12
SPT-SMD 1,5/ 2-H-3,5 R24	1824527	7	SPT-SMD 1,5/ 12-H-3,5 R72	1824624	7	SPT-THR 1,5/ 6-V-3,5 P20 R44	1823230	11	SPT-THR 1,5/ 11-V-3,5 P20 R72	1823285	11
SPT-SMD 1,5/ 2-H-3,81 R24	1824637	7	SPT-SMD 1,5/ 12-H-5,0 R88	1824734	7	SPT-THR 1,5/ 6-V-3,5 P26	1822354	11	SPT-THR 1,5/ 11-V-3,5 P26	1822406	11
SPT-SMD 1,5/ 2-H-5,0 R24	1824747	9	SPT-SMD 1,5/ 12-H-5,08 R88	1824844	9	SPT-THR 1,5/ 6-V-3,81 P20 R44	1823340	11	SPT-THR 1,5/ 11-V-3,81 P20 R72	1823395	11
SPT-SMD 1,5/ 2-H-5,08 R24	1824857	9	SPT-SMD 1,5/ 12-H-5,08 R88	1824954	9	SPT-THR 1,5/ 6-V-3,81 P26	1822464	11	SPT-THR 1,5/ 11-V-3,81 P26	1822516	11
SPT-SMD 1,5/ 2-V-3,5 R24	1824080	7	SPT-SMD 1,5/ 12-V-3,5 R72	1824187	7	SPT-THR 1,5/ 6-V-5,0 P20 R56	1823450	13	SPT-THR 1,5/ 11-V-5,0 P20 R88	1823502	13
SPT-SMD 1,5/ 2-V-3,81 R24	1824190	7	SPT-SMD 1,5/ 12-V-3,81 R72	1824297	7	SPT-THR 1,5/ 6-V-5,0 P26	1822574	13	SPT-THR 1,5/ 11-V-5,0 P26	1822626	13
SPT-SMD 1,5/ 2-V-5,0 R24	1824307	9	SPT-SMD 1,5/ 12-V-5,0 R88	1824404	9	SPT-THR 1,5/ 6-V-5,08 P20 R56	1823560	13	SPT-THR 1,5/ 11-V-5,08 P20 R88	1823612	13
SPT-SMD 1,5/ 2-V-5,08 R24	1824417	9	SPT-SMD 1,5/ 12-V-5,08 R88	1824514	9	SPT-THR 1,5/ 6-V-5,08 P26	1822684	13	SPT-THR 1,5/ 11-V-5,08 P26	1822736	13
SPT-SMD 1,5/ 3-H-3,5 R24	1824530	7	SPT-THR 1,5/ 2-H-3,5 P20 R24	1823638	11	SPT-THR 1,5/ 7-H-3,5 P20 R44	1823683	11	SPT-THR 1,5/ 12-H-3,5 P20 R72	1823735	11
SPT-SMD 1,5/ 3-H-3,81 R24	1824640	7	SPT-THR 1,5/ 2-H-3,5 P26	1822752	10	SPT-THR 1,5/ 7-H-3,5 P26	1822804	10	SPT-THR 1,5/ 12-H-3,5 P26	1822859	10
SPT-SMD 1,5/ 3-H-5,0 R32	1824750	9	SPT-THR 1,5/ 2-H-3,81 P20 R24	1823748	11	SPT-THR 1,5/ 7-H-3,81 P20 R44	1823793	11	SPT-THR 1,5/ 12-H-3,81 P20 R72	1823845	11
SPT-SMD 1,5/ 3-H-5,08 R32	1824860	9	SPT-THR 1,5/ 2-H-3,81 P26	1822862	10	SPT-THR 1,5/ 7-H-3,81 P26	1822914	10	SPT-THR 1,5/ 12-H-3,81 P26	1822969	10
SPT-SMD 1,5/ 3-V-3,5 R32	1824093	7	SPT-THR 1,5/ 2-H-5,0 P20 R24	1823858	13	SPT-THR 1,5/ 7-H-5,0 P20 R56	1823900	13	SPT-THR 1,5/ 12-H-5,0 P20 R88	1823955	13
SPT-SMD 1,5/ 3-V-3,81 R32	1824200	7	SPT-THR 1,5/ 2-H-5,0 P26	1822972	12	SPT-THR 1,5/ 7-H-5,0 P26	1823023	12	SPT-THR 1,5/ 12-H-5,0 P26	1823078	12
SPT-SMD 1,5/ 3-V-5,0 R32	1824310	9	SPT-THR 1,5/ 2-H-5,08 P20 R24	1823968	13	SPT-THR 1,5/ 7-H-5,08 P20 R56	1824019	13	SPT-THR 1,5/ 12-H-5,08 P20 R88	1824064	13
SPT-SMD 1,5/ 3-V-5,08 R32	1824420	9	SPT-THR 1,5/ 2-H-5,08 P26	1823081	12	SPT-THR 1,5/ 7-H-5,08 P26	1823133	12	SPT-THR 1,5/ 12-H-5,08 P26	1823188	12
SPT-SMD 1,5/ 4-H-3,5 R44	1824543	7	SPT-THR 1,5/ 2-V-3,5 P20 R24	1823191	11	SPT-THR 1,5/ 7-V-3,5 P20 R44	1823243	11	SPT-THR 1,5/ 12-V-3,5 P20 R72	1823298	11
SPT-SMD 1,5/ 4-H-3,81 R44	1824653	7	SPT-THR 1,5/ 2-V-3,5 P26	1822312	11	SPT-THR 1,5/ 7-V-3,5 P26	1822367	11	SPT-THR 1,5/ 12-V-3,5 P26	1822419	11
SPT-SMD 1,5/ 4-H-5,0 R44	1824763	9	SPT-THR 1,5/ 2-V-3,81 P20 R24	1823308	11	SPT-THR 1,5/ 7-V-3,81 P20 R44	1823353	11	SPT-THR 1,5/ 12-V-3,81 P20 R72	1823405	11
SPT-SMD 1,5/ 4-H-5,08 R44	1824873	9	SPT-THR 1,5/ 2-V-3,81 P26	1822422	11	SPT-THR 1,5/ 7-V-3,81 P26	1822477	11	SPT-THR 1,5/ 12-V-3,81 P26	1822529	11
SPT-SMD 1,5/ 4-V-3,5 R44	1824103	7	SPT-THR 1,5/ 2-V-5,0 P20 R24	1823418	13	SPT-THR 1,5/ 7-V-5,0 P20 R56	1823463	13	SPT-THR 1,5/ 12-V-5,0 P20 R88	1823515	13
SPT-SMD 1,5/ 4-V-3,81 R44	1824213	7	SPT-THR 1,5/ 2-V-5,0 P26	1822532	13	SPT-THR 1,5/ 7-V-5,0 P26	1822587	13	SPT-THR 1,5/ 12-V-5,0 P26	1822639	13
SPT-SMD 1,											

Type	Order No.	Page	Type	Order No.	Page	Type	Order No.	Page	Type	Order No.	Page
SPTA 5/5-7,5-ZB	1819118	25	TMT (EX5,5)R CUS	0803072	266	UCT-WMCO 3,5 (18X4)	0830783	269	UT 6-TG P/P-EX	3073870	163
SPTA 5/6-7,5-ZB	1819121	25	TMT (EX6,2)R	0803063	266	UCT-WMCO 3,5 (18X4) CUS	0830791	269	UT 6-TG-EX	3046486	163
SPTA 5/7-7,5-ZB	1819134	25	TMT (EX6,2)R CUS	0803073	266	UCT-WMCO 4,1 (12X4)	0830784	269	UTRE 6-2/10	3069811	95
SPTA 5/8-7,5-ZB	1819147	25	TMT (EX6,5)R	0803064	266	UCT-WMCO 4,1 (12X4) CUS	0830792	269	UTRE 6-2/12	3069813	95
SPTA 5/9-7,5-ZB	1819150	25	TMT (EX6,5)R CUS	0803075	266	UCT-WMCO 4,1 (18X4)	0830785	269	UTRE 6-2/14	3069815	95
SPTA 5/10-7,5-ZB	1819163	25	TMT (EX7,5)R	0803065	266	UCT-WMCO 4,1 (18X4) CUS	0830793	269	UTRE 6-2/15	3069816	95
SPTA 5/11-7,5-ZB	1819176	25	TMT (EX7,5)R CUS	0803076	266	UCT-WMCO 4,7 (12X4)	0830786	269	UTRE 6-2/17	3069818	95
SPTA 5/12-7,5-ZB	1819189	25	TMT (EX8)R	0803066	266	UCT-WMCO 4,7 (12X4) CUS	0830794	269	UTRE 6-2/19	3069820	95
SPTD 1,5/2-H-3,5	1841490	15	TMT (EX8)R CUS	0803077	266	UCT-WMCO 4,7 (18X4)	0830787	269	UTRE 6-2/20	3069821	95
SPTD 1,5/3-H-3,5	1841500	15	TMT (EX8,5)R	0803067	266	UCT-WMCO 4,7 (18X4) CUS	0830795	269	UTRE 6-2/21	3069822	95
SPTD 1,5/4-H-3,5	1841513	15	TMT (EX8,5)R CUS	0803078	266	UCT-WMTBA (24X4)	1014082	270	UTRE 6-2/22	3069823	95
SPTD 1,5/5-H-3,5	1841526	15	TMT (EX9,5)R	0828295	266	UCT-WMTBA (24X4) CUS	1014088	270	UTRE 6-2/25	3069826	95
SPTD 1,5/6-H-3,5	1841539	15	TMT (EX9,5)R CUS	0803079	266	UCT-WMTBA (24X4) YE	1014083	270	UTRE 6-2/4	3069805	95
SPTD 1,5/7-H-3,5	1841542	15	TMT TOOL	0816650	266	UCT-WMTBA (24X6) YE CUS	1014089	270	UTRE 6-2/5	3069806	95
SPTD 1,5/8-H-3,5	1841555	15	TMT2 (EX11)R	0802683	266	UCT-WMTBA (29X6)	1014084	271	UTRE 6-2/9	3069810	95
SPTD 1,5/9-H-3,5	1841568	15	TMT2 (EX11)R CUS	0830811	266	UCT-WMTBA (29X6) CUS	1014090	271	UTRE 6-2/A14	3069426	135
SPTD 1,5/10-H-3,5	1841571	15	TOOL-BAG CUS	1200081	296	UCT-WMTBA (29X6) YE	1014085	271	UTRE 6-2/A7	3069423	129
SPTD 1,5/11-H-3,5	1841584	15	TOOL-BELTPOUCH CUS	1200084	297	UCT-WMTBA (29X6) YE CUS	1014091	271	UTRE 6-2/B14	3069427	137
SPTD 1,5/12-H-3,5	1841597	15	TOOL-CARRIER CUS	1200082	296	UCT-WMTBA (40X17)	1014086	271	UTRE 6-2/B19	3069429	141
ST-10KP010	1618255	66	TOOL-CASE	1212629	296	UCT-WMTBA (40X17) CUS	1014092	271	UTRE 6-2/B7	3069424	131
ST-10KP020	1618256	66	TOOL-CASE CUS	1200072	296	UCT-WMTBA (40X17) YE	1014087	271	UTRE 6-2/C14	3069428	139
ST-10KP030	1618261	66	TOOL-KIT CUS	1200085	297	UCT-WMTBA (40X17) YE CUS	1014093	271	UTRE 6-2/C19	3069430	143
ST-10KS010	1618239	66	TOOL-WRAP CUS	1200083	297	UK 4-SD	3246861	170	UTRE 6-2/D19	3069431	145
ST-10KS020	1618251	66	TOPMARK LASER	0831831	245	UM1-TM (12X10)	0830916	264	UTRE 6-2/E7	3069425	133
ST-10KS030	1618254	66	TOPMARK LASER STATION	0831835	245	UM1-TM (3,5X12)	0830925	264	UTRE 6-2/F19	3069432	147
STEP-PS/1AC/24DC/0,75	2868635	394	TOPMARK LASER-MAG CARD	0831837	245	UM1-TM (5X10)	0830905	264	UTRE 6-2/G19	3069433	149
STP 5-2-ZB	3037643	173	TOPMARK LASER-MAG SHEET	0831836	245	UM1-TM (5X12)	0830912	264	UTRE 6-2/H19	3069434	151
SUBCON 9/F-SH	2761499	391	TOUCH PEN	2701379	418	UM1-TM (6X10)	0830903	264	UTRE 6-2/I19	3069435	153
SUBCON-PLUS-CAN/35/M12	2902325	397	TP 07T/M 211	2701452	418	UM1-TM (6X12)	0830909	264	UTT 2,5-2MT-P/P	3044670	165
SUBCON-PLUS-CAN/35/PG/M12	2902324	397	TP 10T/M 211	2701843	419	UM1-TM (8X10)	0830906	264	UTT 2,5-2MT-P/P BU	3044671	165
SUBCON-PLUS-CAN/90/M12	2902323	397	TP 12T/M 211	2701844	419	UM1-TM (8X12)	0830920	264	UTTB 2,5-MT-P/P	3044640	165
SUBCON-PLUS-CAN/90/PG/M12	2902322	397	TP 15T/M 211	2701845	419	UM1-TMF (3,5X5)	0830935	265	UTTB 2,5-MT-P/P BU	3044641	165
SUBCON-PLUS-CAN/90X/M12	2902731	396				UM1-TMF (5X5)	0830902	265	UTTB 2,5-TG-P/P	3044644	164
SUBCON-PLUS-CAN/90X/PG/M12	2902730	396				UM1-TMF (6X5)	0830904	265	UTWE 6-2/10	3069658	94
SUBCON-PLUS-M/AX 9	2904467	431				UM1-TMF (8X5)	0830924	265	UTWE 6-2/12	3069660	94
SUBCON-PLUS-PROFIB/35/M12	2902320	397				UM1U-TM (5X10)	0830910	265	UTWE 6-2/14	3069663	94
SUBCON-PLUS-PROFIB/35/PG/M12	2902319	397	UC-EMLP (15X5)	0819301	339	UM1U-TM (6X10)	0830907	265	UTWE 6-2/15	3069664	94
SUBCON-PLUS-PROFIB/90/M12	2902318	397	UC-EMLP (15X5) CUS	0824550	339	UNO-PS/1AC/5DC/25W	2904374	316	UTWE 6-2/17	3069667	94
SUBCON-PLUS-PROFIB/90/PG/M12	2902317	397	UC-EMLP (22X22)-EX	0803224	276	UNO-PS/1AC/5DC/40W	2904375	316	UTWE 6-2/19	3069672	94
SUBCON-PLUS-PROFIB/90X/M12	2902729	396	UC-EMLP (22X22)-EX CUS	0803229	276	UNO-PS/1AC/12DC/100W	2902997	317	UTWE 6-2/20	3069673	94
SUBCON-PLUS-PROFIB/90X/PG/M12	2902728	396	UC-EMLP (27X18)-EX	0803225	276	UNO-PS/1AC/15DC/55W	2903001	317	UTWE 6-2/21	3069800	94
SZF 0-0,4X2,5	1204504	156	UC-EMLP (27X18)-EX CUS	0803230	276	UNO-PS/1AC/15DC/100W	2903002	317	UTWE 6-2/22	3069801	94
SZF 1-0,6X3,5	1204517	158	UC-EMLP (27X27)-EX	0803226	276	UNO-PS/1AC/15DC/30W	2903000	317	UTWE 6-2/25	3069804	94
SZG 0,6X3,5 VDE	1205121	164	UC-EMLP (27X27)-EX CUS	0803231	276	UNO-PS/1AC/24DC/90W/C2LPS	2902994	318	UTWE 6-2/4	3069650	94
SZS 0,6X3,5	1205053	162	UC-EMLP (49X15)-EX	0803227	276	UNO-PS/1AC/48DC/60W	2902995	319	UTWE 6-2/5	3069651	94
SZS 1,0X4,0 VDE	1205066	163	UC-EMLP (49X15)-EX CUS	0803232	276	UNO-PS/1AC/48DC/100W	2902996	319	UTWE 6-2/9	3069656	94
			UC-EMLP (60X30)-EX	0803228	276	UNO-PS/2AC/24DC/90W/C2LPS	2904371	319	UTWE 6-2/A14	3069413	134
			UC-EMLP (60X30)-EX CUS	0803233	276	US-EMLP-HA (17X7)	0830988	278	UTWE 6-2/A7	3069410	128
			UC-TMF 5	0818153	44	US-EMLP-HA (17X7) CUS	0830994	278	UTWE 6-2/B14	3069414	136
			UCT-EM (30X5)	0801505	339	US-EMLP-HA (20X9)	0830989	278	UTWE 6-2/B19	3069416	140
			UCT-EM (30X5) CUS	0801589	339	US-EMLP-HA (20X9) CUS	0830995	278	UTWE 6-2/B7	3069411	130
			UCT-EMP (25X6)	1014117	272	US-EMLP-HA (60X30)	0830990	278	UTWE 6-2/C14	3069415	138
			UCT-EMP (25X6) CUS	1014121	272	US-EMLP-HA (60X30) CUS	0830996	278	UTWE 6-2/C19	3069417	142
			UCT-EMP (29X8)	1014118	273	US-EMLP-HA (60X30) SR	0830991	278	UTWE 6-2/D19	3069418	144
			UCT-EMP (29X8) CUS	1014122	273	US-EMLP-HA (60X30) SR CUS	0830997	278	UTWE 6-2/E7	3069412	132
			UCT-EMP (40X17)	1014120	273	US-EMLP-HA (85,6X54)	0830992	278	UTWE 6-2/F19	3069419	146
			UCT-EMP (40X17) CUS	1014124	273	US-EMLP-HA (85,6X54) CUS	0830998	278	UTWE 6-2/G19	3069420	148
			UCT-EMP (60X15)	1014119	273	US-EMLP-HA (85,6X54) SR	0830993	278	UTWE 6-2/H19	3069421	150
			UCT-EMP (60X15) CUS	1014123	273	US-EMLP-HA (85,6X54) SR CUS	0830999	278	UTWE 6-2/I19	3069422	152
			UCT-PMLP (90X38)	0803041	286	US-EMP (25X6)-1	0802754	272			
			UCT-PMLP (90X38) CUS	0803042	286	US-EMP (29X8)	0829436	273			
			UCT-PMLP-RFID/HF (90X38)	0830956	282	US-EMP (40X17)	0829437	273			
			UCT-PMLP-RFID/UHF (90X38)	0830957	283	US-EMP (60X15)	0828781	273			
			UCT-PMP (90X38)	0803039	287	USA 10/4,6	1202713	195			
			UCT-PMP (90X38) BU	0803047	287	UT 4-L	3214363	166	VAL-MS 350 VF ST	2856595	306
			UCT-PMP (90X38) BU CUS	8190566	287	UT 4-L/HESI (5X20)	3214325	168	VAL-MS 75 VF ST	2805318	306
			UCT-PMP (90X38) CUS	0803040	287	UT 4-L/L	3214362	166	VAL-MS BE-AR	2801065	306
			UCT-PMP (90X38) VT	0803132	287	UT 4-MT-EX	3046141	163	VAL-MS BE-AR/FM	2801066	306
			UCT-PMP (90X38) VT CUS	8190707	287	UT 4-MT-P/P-EX	3046173	163	VAL-MS-AR 350 VF	2801489	306
			UCT-PMP (90X38) YE	0803133	287	UT 4-PE/L/HEDI	3214324	169	VAL-MS-AR 350 VF/FM	2801490	306
			UCT-PMP (90X38) YE CUS	8190708	287	UT 4-PE/L/HESI (5X20)	3214320	169	VAL-MS-AR 75 VF	2801487	306
			UCT-PMP-RFID/HF (90X38)	0830954	284	UT 4-PE/L/HESI (5X20)	3214321	169	VAL-MS-AR 75 VF/FM	2801488	306
			UCT-PMP-RFID/HF (90X38) CUS	0830955	285	UT 4-PE/L/HESI (5X20)	3214323	169	VAL-MS-AR-T1/T2 75	2801491	306
			UCT-PMP-RFID/UHF (90X38)	0830348	285	UT 4-PE/L/HESI (5X20)	3214322	169	VAL-MS-AR-T1/T2 75/FM	2801492	306
			UCT-WMCO 2,9 (12X4)	0830780	268	UT 4-PE/L/L	3214360	167	VAL-MS-T1/T2 48/12,5 ST	2801242	307
			UCT-WMCO 2,9 (12X4) CUS	0830788	268	UT 4-PE/L/MT	3214364	167	VAL-MS-T1/T2 48/12,5+1V	2801532	307
			UCT-WMCO 2,9 (18X4)	0830781	268	UT 4-PE/L/N	3214361	167	VAL-MS-T1/T2 48/12,5+1V-FM	2801533	307
			UCT-WMCO 2,9 (18X4) CUS	0830789	268	UT 4-PE/L/TG	3214365	167	VAL-MS-T1/T2 75/12,5 ST	2801146	306
			UCT-WMCO 3,5 (12X4)	0830782	269	UT 4-TG-EX	3046143	162	VAL-SQ NP 120-2-A 32	2800371	309
			UCT-WMCO 3,5 (12X4) CUS	0830790	269	UT 4-TG-P/P-EX	3046169	162	VAL-SQ NP 120-2-A 32 ST	2800369	309

T

U

V

# Index

## Alphabetical

Type	Order No.	Page	Type	Order No.	Page	Type	Order No.	Page
VAL-SQ NP 120-2-A BE	2800749	309						
VIP-2/PT/PDM-2/16/FU 6.3A	2903603	373						
VIP-8RPT-120AC/1AU/DI/PLC	2904576	371						
VIP-8RPT-24DC/1AU/DI/PLC	2903600	371						
VIP-8RPT-24DC/21/D0/FU/PLC	2903601	370						
VIP-PA-PWR/20XOE/ 1,0M/S7	2904724	369						
VIP-PA-PWR/20XOE/ 2,0M/S7	2904725	369						
VIP-PA-PWR/20XOE/ 3,0M/S7	2904726	369						
VIP-PA-PWR/20XOE/ 4,0M/S7	2904727	369						
VIP-PA-PWR/20XOE/ 6,0M/S7	2904728	369						
VIP-PA-PWR/20XOE/ 8,0M/S7	2904729	369						
VIP-PA-PWR/20XOE/10,0M/S7	2904730	369						
VIP-PA-PWR/2X10COMBI/ 0,5M/S7	2904713	369						
VIP-PA-PWR/2X10COMBI/ 1,0M/S7	2904714	369						
VIP-PA-PWR/2X10COMBI/ 1,5M/S7	2904715	369						
VIP-PA-PWR/2X10COMBI/ 2,0M/S7	2904716	369						
VIP-PA-PWR/2X10COMBI/ 2,5M/S7	2904717	369						
VIP-PA-PWR/2X10COMBI/ 3,0M/S7	2904718	369						
VIP-PA-PWR/2X10COMBI/ 4,0M/S7	2904719	369						
VIP-PA-PWR/2X10COMBI/ 5,0M/S7	2904720	369						
VIP-PA-PWR/2X10COMBI/ 6,0M/S7	2904721	369						
VIP-PA-PWR/2X10COMBI/ 8,0M/S7	2904722	369						
VIP-PA-PWR/2X10COMBI/10,0M/S7	2904723	369						
VIP-PA-PWR/40XOE/ 1,0M/S7	2904731	369						
VIP-PA-PWR/40XOE/ 2,0M/S7	2904732	369						
VIP-PA-PWR/40XOE/ 3,0M/S7	2904733	369						
VIP-PA-PWR/40XOE/ 4,0M/S7	2904734	369						
VIP-PA-PWR/40XOE/ 6,0M/S7	2904735	369						
VIP-PA-PWR/40XOE/ 8,0M/S7	2904736	369						
VIP-PA-PWR/40XOE/10,0M/S7	2904737	369						
VIP-PA-PWR/4X10COMBI/ 0,5M/S7	2904702	368						
VIP-PA-PWR/4X10COMBI/ 1,0M/S7	2904703	368						
VIP-PA-PWR/4X10COMBI/ 1,5M/S7	2904704	368						
VIP-PA-PWR/4X10COMBI/ 2,0M/S7	2904705	368						
VIP-PA-PWR/4X10COMBI/ 2,5M/S7	2904706	368						
VIP-PA-PWR/4X10COMBI/ 3,0M/S7	2904707	368						
VIP-PA-PWR/4X10COMBI/ 4,0M/S7	2904708	368						
VIP-PA-PWR/4X10COMBI/ 5,0M/S7	2904709	368						
VIP-PA-PWR/4X10COMBI/ 6,0M/S7	2904710	368						
VIP-PA-PWR/4X10COMBI/ 8,0M/S7	2904711	368						
VIP-PA-PWR/4X10COMBI/10,0M/S7	2904712	368						
VIP-PT/FLK16/DS/FU/LED/AN/DV	2903599	372						
VS-CABLE-STRIP-VARIO	1657407	44						

## W

WIREFOX 10 CUS	1212760	301
WIREFOX 16 CUS	1212761	301
WIREFOX 4 CUS	1212762	301
WIREFOX 6SC CUS	1212763	301
WT-HP HF 3,6X140	0830982	272
WT-HP HF 4,5X290	0830984	272
WT-HP HF 4,8X200	0830983	272
WT-UV HF 3,6X140 BK	3240832	274
WT-UV HF 4,5X200 BK	3240834	274
WT-UV HF 4,5X290 BK	3240835	274

Type	Order No.	Page	Type	Order No.	Page	Type	Order No.	Page	Type	Order No.	Page
------	-----------	------	------	-----------	------	------	-----------	------	------	-----------	------

**EMC: Class A product:**

In accordance with statutory regulations, our products are indicated with this footnote if they are intended for use in industrial environments. This means that the permissible limit values for residential applications may be exceeded in the event of conducted and emitted interference. In such cases, the operator may have to take additional safety measures in order to ensure electromagnetic compatibility in residential applications.



Компания «Океан Электроники» предлагает заключение долгосрочных отношений при поставках импортных электронных компонентов на взаимовыгодных условиях!

Наши преимущества:

- Поставка оригинальных импортных электронных компонентов напрямую с производств Америки, Европы и Азии, а так же с крупнейших складов мира;
- Широкая линейка поставок активных и пассивных импортных электронных компонентов (более 30 млн. наименований);
- Поставка сложных, дефицитных, либо снятых с производства позиций;
- Оперативные сроки поставки под заказ (от 5 рабочих дней);
- Экспресс доставка в любую точку России;
- Помощь Конструкторского Отдела и консультации квалифицированных инженеров;
- Техническая поддержка проекта, помощь в подборе аналогов, поставка прототипов;
- Поставка электронных компонентов под контролем ВП;
- Система менеджмента качества сертифицирована по Международному стандарту ISO 9001;
- При необходимости вся продукция военного и аэрокосмического назначения проходит испытания и сертификацию в лаборатории (по согласованию с заказчиком);
- Поставка специализированных компонентов военного и аэрокосмического уровня качества (Xilinx, Altera, Analog Devices, Intersil, Interpoint, Microsemi, Actel, Aeroflex, Peregrine, VPT, Syfer, Eurofarad, Texas Instruments, MS Kennedy, Miteq, Cobham, E2V, MA-COM, Hittite, Mini-Circuits, General Dynamics и др.);

Компания «Океан Электроники» является официальным дистрибьютором и эксклюзивным представителем в России одного из крупнейших производителей разъемов военного и аэрокосмического назначения «JONHON», а так же официальным дистрибьютором и эксклюзивным представителем в России производителя высокотехнологичных и надежных решений для передачи СВЧ сигналов «FORSTAR».



## JONHON

«JONHON» (основан в 1970 г.)

Разъемы специального, военного и аэрокосмического назначения:

(Применяются в военной, авиационной, аэрокосмической, морской, железнодорожной, горно- и нефтедобывающей отраслях промышленности)

«FORSTAR» (основан в 1998 г.)

ВЧ соединители, коаксиальные кабели, кабельные сборки и микроволновые компоненты:

(Применяются в телекоммуникациях гражданского и специального назначения, в средствах связи, РЛС, а так же военной, авиационной и аэрокосмической отраслях промышленности).



Телефон: 8 (812) 309-75-97 (многоканальный)

Факс: 8 (812) 320-03-32

Электронная почта: [ocean@oceanchips.ru](mailto:ocean@oceanchips.ru)

Web: <http://oceanchips.ru/>

Адрес: 198099, г. Санкт-Петербург, ул. Калинина, д. 2, корп. 4, лит. А