

FEATURES

- Qualified for automotive applications
- Integrates all typical PWM controller functions
 - 7 PWM control signals
 - Digital control loop
 - Integrated programmable loop filters
 - Programmable voltage line feedforward
 - Dedicated soft start filter
 - Remote and local voltage sense
 - Primary and secondary side current sense
 - Synchronous rectifier control
 - Current sharing
 - OrFET control
- I²C interface
- Extensive fault detection and protection
- Extensive programming and telemetry
- Fast digital calibration
- User accessible EEPROM

APPLICATIONS

- AC-to-DC power supplies
- Isolated dc-to-dc power supplies
- Redundant power supply systems
- Server, storage, network, and communications infrastructure

GENERAL DESCRIPTION

The ADP1046AW is a flexible, digital secondary side controller designed for ac-to-dc and isolated dc-to-dc secondary side applications. The ADP1046AW is pin-compatible with the ADP1043A and offers several enhancements and new features, including voltage feedforward and improved loop response to maximize efficiency.

The ADP1046AW is optimized for minimal component count, maximum flexibility, and minimum design time. Features include local and remote voltage sense, primary and secondary side current sense, digital pulse-width modulation (PWM) generation, current sharing, and redundant OrFET control. The control loop digital filter and compensation terms are integrated and can be programmed over the I²C interface. Programmable protection features include overcurrent protection (OCP), over-voltage protection (OVP), undervoltage lockout (UVLO), and overtemperature protection (OTP).

The built-in EEPROM provides extensive programming of the integrated loop filter, PWM signal timing, inrush current, and soft start timing and sequencing. Reliability is improved through a built-in checksum and programmable protection circuits.

A comprehensive GUI is provided for easy design of loop filter characteristics and programming of the safety features. The industry-standard I²C bus provides access to the many monitoring and system test functions.

The ADP1046AW is available in a 32-lead LFCSP and operates from a single 3.3 V supply.

TYPICAL APPLICATION CIRCUIT



Figure 1.

11742-001

Rev. 0

Document Feedback

Information furnished by Analog Devices is believed to be accurate and reliable. However, no responsibility is assumed by Analog Devices for its use, nor for any infringements of patents or other rights of third parties that may result from its use. Specifications subject to change without notice. No license is granted by implication or otherwise under any patent or patent rights of Analog Devices. Trademarks and registered trademarks are the property of their respective owners.

TABLE OF CONTENTS

Features	1	First Flag Fault ID and Value Registers	28
Applications	1	External Flag Input (FLAGIN Pin)	28
General Description	1	Temperature Readings (RTD Pin)	28
Typical Application Circuit	1	Overtemperature Protection (OTP)	29
Revision History	3	Overcurrent Protection (OCP)	29
Specifications	4	Constant Current Mode	30
Absolute Maximum Ratings	9	Overvoltage Protection (OVP)	30
Thermal Resistance	9	Undervoltage Protection (UVP)	31
Soldering	9	AC Sense (ACSNS)	31
ESD Caution	9	Volt-Second Balance	32
Pin Configuration and Function Descriptions	10	Digital Load Line and Slew Rate	32
Typical Performance Characteristics	12	Power Supply Calibration and Trim	33
Theory of Operation	14	CS1 Trim	33
Current Sense	15	CS2 Trim	33
Voltage Sense and Control Loop	16	Voltage Calibration and Trim	34
ADCs	16	Output Voltage Setting (VS3+, VS3– Trim)	34
VS1 Operation (VS1)	16	VS1 Trim	34
VS2 Operation (VS2)	17	VS2 Trim	34
VS3 Operation (VS3+, VS3–)	17	RTD/OTP Trim	34
Voltage Line Feedforward and ACSNS	17	ACSNS Calibration and Trim	35
Digital Filter	17	Layout Guidelines	36
PWM and Synchronous Rectifier Outputs (OUTA, OUTB, OUTC, OUTD, OUTAUX, SR1, SR2)	18	CS2+ and CS2–	36
Synchronous Rectification	19	VS3+ and VS3–	36
Synchronous Rectifier (SR) Delay	19	VDD	36
Light Load Mode	19	SDA and SCL	36
Modulation Limit	19	CS1	36
Soft Start	20	Exposed Pad	36
OrFET Control (GATE Pin)	22	VCORE	36
VDD	24	RES	36
VDD/VCORE OVLO	24	RTD	36
Power Good	24	AGND, DGND, and PGND	36
Current Sharing	25	I ² C Interface Communication	37
Power Supply System and Fault Monitoring	27	I ² C Overview	37
Flags	27	I ² C Address	37
Monitoring Functions	27	Data Transfer	37
Voltage Readings	27	General Call Support	39
Current Readings	27	10-Bit Addressing	39
Power Readings	28	Fast Mode	39
Power Monitoring Accuracy	28	Repeated Start Condition	39
		Electrical Specifications	39

Fault Conditions.....	39	PWM and Synchronous Rectifier Timing Registers.....	63
Timeout Condition.....	39	Digital Filter Programming Registers.....	73
Data Transmission Faults.....	39	Soft Start Filter Programming Registers.....	75
Data Content Faults.....	39	Extended Functions Registers.....	75
EEPROM.....	41	EEPROM Registers.....	79
EEPROM Overview.....	41	Resonant Mode Operation.....	82
Page Erase Operation.....	41	Resonant Mode Enable.....	82
Read Operation (Byte Read and Block Read).....	41	PWM Timing in Resonant Mode.....	82
Write Operation (Byte Write and Block Write).....	42	Synchronous Rectification in Resonant Mode.....	82
EEPROM Password.....	42	Adjusting the Timing of the PWM Outputs.....	83
Downloading EEPROM Settings to Internal Registers.....	42	Frequency Limit Setting.....	83
Saving Register Settings to the EEPROM.....	43	Feedback Control in Resonant Mode.....	83
EEPROM CRC Checksum.....	43	Soft Start in Resonant Mode.....	83
Software GUI.....	44	Light Load Operation (Burst Mode).....	83
Register Listing.....	45	OUTAUX Pin in Resonant Mode.....	83
Detailed Register Descriptions.....	48	Protections in Resonant Mode.....	83
Fault Registers.....	48	Resonant Mode Register Descriptions.....	84
Value Registers.....	51	Outline Dimensions.....	88
Current Sense and Current Limit Registers.....	54	Ordering Guide.....	88
Voltage Sense Registers.....	59	Automotive Products.....	88
ID Registers.....	62		

REVISION HISTORY

12/13—Revision 0: Initial Version

SPECIFICATIONS

$V_{DD} = 3.0\text{ V to }3.6\text{ V}$, $T_A = -40^\circ\text{C to }+125^\circ\text{C}$, unless otherwise noted. FSR = full-scale range.

Table 1.

Parameter	Symbol	Test Conditions/Comments	Min	Typ	Max	Unit
SUPPLY						
Supply Voltage	V_{DD}	4.7 μF capacitor connected to AGND	3.05	3.3	3.6	V
Supply Current	I_{DD}	Normal operation (PSON is high or low) During EEPROM programming (40 ms) Shutdown (V_{DD} below UVLO)		20 $I_{DD} + 8$ 100		mA mA μA
POWER-ON RESET						
Power-On Reset		V_{DD} rising			3.02	V
UVLO		V_{DD} falling	2.75	2.85	2.97	V
UVLO Hysteresis				40		mV
OVLO			3.75	4.0	4.13	V
OVLO Debounce		When set to 2 μs When set to 500 μs		2.0 500		μs μs
VCORE PIN						
Output Voltage		0.33 μF capacitor connected to DGND $T_A = 25^\circ\text{C}$	2.4	2.5	2.7	V
OSCILLATOR AND PLL						
PLL Frequency		RES = 10 k Ω ($\pm 0.1\%$)	190	200	210	MHz
OUTA, OUTB, OUTC, OUTD, OUTAUX, SR1, SR2, GATE PINS						
Output Low Voltage	V_{OL}	Source current = 10 mA			0.4	V
Output High Voltage	V_{OH}	Source current = 10 mA	$V_{DD} - 0.4$			V
Rise Time		$C_{LOAD} = 50\text{ pF}$		3.5		ns
Fall Time		$C_{LOAD} = 50\text{ pF}$		1.5		ns
VS1, VS2, VS3 LOW SPEED ADCs						
Input Voltage Range	V_{IN}	Differential voltage from VS1, VS2 to PGND, and from VS3+ to VS3-	0	1	1.6	V
Usable Input Voltage Range			0		1.4	V
ADC Clock Frequency				1.56		MHz
Register Update Rate				10		ms
Voltage Sense Measurement Accuracy		Factory trimmed at 1.0 V				
		0% to 100% of usable input voltage range	-3.0		+3.0	% FSR
			-48		+48	mV
		10% to 90% of usable input voltage range	-2.0		+2.0	% FSR
			-32		+32	mV
		900 mV to 1.1 V	-1.2		+1.2	% FSR
			-16		+16	mV
Temperature Coefficient					65	ppm/ $^\circ\text{C}$
Leakage Current					1.0	μA
Voltage Sense Measurement Resolution				12		Bits
Common-Mode Voltage Offset			-0.25		+0.25	% FSR
Voltage Differential from VS3- to PGND			-200		+200	mV
VS1 Accurate OVP Speed		Register 0x32[1:0] = 00; equivalent resolution is 7 bits		80		μs
VS1 OVP Threshold Accuracy		Relative to nominal voltage (1 V) on VS1	-2.0		+2.0	% FSR
VS2 and VS3 OVP Speed		Register 0x33[1:0] = 00; equivalent resolution is 7 bits		80		μs
VS2 and VS3 OVP Threshold Accuracy		Relative to nominal voltage (1 V) on VS2 and VS3	-2.0		+2.0	% FSR

Parameter	Symbol	Test Conditions/Comments	Min	Typ	Max	Unit	
VS3 HIGH SPEED ADC Equivalent Sampling Frequency	f_{SAMP}	$f_{sw} = 390.6 \text{ kHz}$		f_{sw}		kHz	
Equivalent Resolution Dynamic Range				6 ± 30		Bits mV	
VS1 FAST OVP COMPARATOR Threshold Accuracy		At factory trim of 1.2 V At other thresholds (0.8 V to 1.6 V)	-2.06	1	1.60	%	
Propagation Delay		Does not include debounce time (Register 0x0A[7] = 1)		40	+2.06	ns	
VS1 UVP DIGITAL COMPARATOR VS1 UVP Accuracy Propagation Delay		Does not include debounce time (Register 0x0B[3] = 1)	-3.0	80	+3.0	% FSR μs	
AC SENSE COMPARATOR Input Voltage Threshold Propagation Delay	V_{ACSNS}	PWM and resonant mode	0.4	0.45	0.5	V	
ADC Clock Frequency		From ACSNS threshold to SRx rising edge (resonant mode only)		1.56		MHz	
Input Voltage Range			0	1	1.6	V	
Usable Input Voltage Range			0		1.4	V	
Sampling Frequency for I ² C Reporting				100		Hz	
Sampling Period for Feedforward			Equivalent resolution is 11 bits		10	μs	
Measurement Accuracy			Factory trimmed at 1.0 V				
			0% to 100% of usable input voltage range	-5.0		+3.0	% FSR
			10% to 90% of usable input voltage range	-2.0		+2.0	% FSR
			900 mV to 1.1 V	-1.2		+1.2	% FSR
Leakage Current			-16		+16	mV μA	
CURRENT SENSE 1 (CS1 PIN) Input Voltage Range Usable Input Voltage Range ADC Clock Frequency Register Update Rate Current Sense Measurement Accuracy	V_{IN}	Factory trimmed at 0.7 V; tested under dc input conditions	0	1	1.4	V	
		10% to 50% of usable input voltage range	0		1.3	V	
					1.56	MHz	
					10	ms	
				-3.0		+3.0	% FSR
				-41.4		+41.4	mV
			0% to 100% of usable input voltage range	-6.0		+3.0	% FSR
				-84		+42	mV
			40% to 60% of usable input voltage range	-1.0		+1.0	% FSR
					12		Bits
Current Sense Measurement Resolution			1.175	1.2	1.216	V	
CS1 Fast OCP Threshold				80	100	ns	
CS1 Fast OCP Speed			-2.0		+2.0	% FSR	
CS1 Accurate OCP DC Accuracy		10% to 90% of usable input voltage range	-28		+28	mV	
CS1 Accurate OCP Speed				2.62	5.24	ms	
Leakage Current				0.8	1.1	μA	

Parameter	Symbol	Test Conditions/Comments	Min	Typ	Max	Unit					
CURRENT SENSE 2 (CS2+, CS2– PINS)	V _{IN}	Differential voltage from CS2+ to CS2–, LSB = 29.297 μ V	0	1.56	120	mV					
Input Voltage Range											
Usable Input Voltage Range											
ADC Clock Frequency											
Temperature Coefficient											
120 mV Range							0 mV to 100 mV	78	ppm/°C		
60 mV Range							0 mV to 50 mV	70	ppm/°C		
							0 mV to 50 mV	156	ppm/°C		
							0 mV to 25 mV	140	ppm/°C		
Current Sense Measurement							0 mV to 110 mV	–2.1	+2.1	% FSR	
120 mV Setting								–2.52	+2.52	mV	
60 mV Setting								–4.2	+4.2	% FSR	
								–5.04	+5.04	mV	
Current Sense Measurement Accuracy							With 0.01% level shifting resistors				
120 mV Setting							0 mV to 100 mV, V _{DD} = 3.3 V	–1.3	+1.3	% FSR	
60 mV Setting							0 mV to 55 mV, V _{DD} = 3.3 V	–1.08	+1.08	mV	
								–1.8	+1.8	% FSR	
		–2.16	+2.16	mV							
Current Sense Measurement Resolution		12		Bits							
CS2 Accurate OCP Speed		2.62	5.24	ms							
Current Sink (High Side)		2		mA							
Current Source (Low Side)		200		μ A							
Common-Mode Voltage at the CS2+ and CS2– Pins	To achieve CS2 measurement accuracy	0.8	1.0	1.4	V						
OrFET PROTECTION (CS2+, CS2–)		Low-side and high-side current sensing									
Fast OrFET Accuracy		–3 mV setting	+4.2	–2.6	–9.5	mV					
		–6 mV setting	+1.2	–5.9	–12.7	mV					
		–9 mV setting	–2.0	–9	–16.2	mV					
		–12 mV setting	–5.3	–12.5	–19.4	mV					
		–15 mV setting	–8	–15.5	–22	mV					
		–18 mV setting	–11.7	–19	–25.9	mV					
		–21 mV setting	–14.8	–22.1	–29.2	mV					
		–24 mV setting	–17.5	–25.3	–31.5	mV					
Fast OrFET Speed		Debounce = 40 ns		110	150	ns					
RTD TEMPERATURE SENSE				1.56		MHz					
ADC Clock Frequency		RTD to AGND	0		1.6	V					
Input Voltage Range			0		1.3	V					
Usable Input Voltage Range		Factory trimmed to 46 μ A (Register 0x11 set to 0xE6)	44.35	46	47.65	μ A					
Source Current			9.25	10.1	10.85	μ A					
			18.35	20.1	21.85	μ A					
			28.45	30.2	31.95	μ A					
			38.45	40.3	41.95	μ A					
Source Current Fine Setting		See Register 0x11[5:0]		160		nA					
RTD ADC				10		ms					
Register Update Rate				12		Bits					
Resolution											

Parameter	Symbol	Test Conditions/Comments	Min	Typ	Max	Unit
Measurement Accuracy		Factory trimmed at 1 V 10 mV to 160 mV	-0.5 -8		+0.5 +8	% FSR mV
Temperature Readings Using Internal Linearization Scheme		0% to 100% of usable input voltage range	-3.0 -42		+3.0 +42	% FSR mV
		RTD source set to 46 μ A (Register 0x11 set to 0xE6); NTC R0 = 100 k Ω , 1%; beta = 4250, 1%; R _{EXT} = 16.5 k Ω , 1%			7	$^{\circ}$ C
		25 $^{\circ}$ C to 100 $^{\circ}$ C			5	$^{\circ}$ C
100 $^{\circ}$ C to 125 $^{\circ}$ C						
OTP						
Threshold Accuracy		T = 85 $^{\circ}$ C with 100 k Ω 16.5 k Ω	-0.25 -4		+0.9 +14.4	% FSR mV
		T = 100 $^{\circ}$ C with 100 k Ω 16.5 k Ω	-0.5 -8		+1.1 +17.6	% FSR mV
Comparator Speed				10.5		ms
OTP Threshold Hysteresis				16		mV
PGOOD1, PGOOD2, SHAREo PINS		Open-drain outputs			0.4	V
Output Low Voltage	V _{OL}				0.4	V
PSOn, SHAREi PINS		Digital inputs			0.8	V
Input Low Voltage	V _{IL}				0.8	V
Input High Voltage	V _{IH}		V _{DD} - 0.8			V
Leakage Current					1.0	μ A
FLAGIN PIN		Digital input			0.4	V
Input Low Voltage	V _{IL}				0.4	V
Input High Voltage	V _{IH}		V _{DD} - 0.8			V
Propagation Delay		Does not include debounce time (Register 0x0A[3] = 1); flag action set to disable PSU		200		ns
Leakage Current					1.0	μ A
GATE PIN					0.4	V
Output Low Voltage	V _{OL}				0.4	V
Output High Voltage	V _{OH}		V _{DD} - 0.4			V
SDA/SCL PINS		V _{DD} = 3.3 V			0.8	V
Input Low Voltage	V _{IL}				0.8	V
Input High Voltage	V _{IH}		V _{DD} - 0.8			V
Output Low Voltage	V _{OL}				0.4	V
Leakage Current					1.0	μ A
SERIAL BUS TIMING		See Figure 2				
Clock Operating Frequency			10	100	400	kHz
Bus-Free Time	t _{BUF}	Between stop and start conditions	1.3			μ s
Start Hold Time	t _{HD;STA}	Hold time after (repeated) start condition; after this period, the first clock is generated	0.6			μ s
Start Setup Time	t _{SU;STA}	Repeated start condition setup time	0.6			μ s
Stop Setup Time	t _{SU;STO}		0.6			μ s
SDA Setup Time	t _{SU;DAT}		100			ns
SDA Hold Time	t _{HD;DAT}	For readback	125			ns
		For write	300			ns
SCL Low Timeout	t _{TIMEOUT}		25		35	ms
SCL Low Period	t _{LOW}		1.3			μ s
SCL High Period	t _{HIGH}		0.6			μ s
Clock Low Extend Time	t _{LO;SEXT}				25	ms
SCL, SDA Fall Time	t _F		20		300	ns
SCL, SDA Rise Time	t _R		20		300	ns

Parameter	Symbol	Test Conditions/Comments	Min	Typ	Max	Unit
EEPROM RELIABILITY						
Endurance ¹		$T_J = 85^\circ\text{C}$	10,000			Cycles
		$T_J = 125^\circ\text{C}$	1000			Cycles
Data Retention ²		$T_J = 85^\circ\text{C}$	20			Years
		$T_J = 125^\circ\text{C}$	10			Years

¹ Endurance is qualified as per JEDEC Standard 22, Method A117, and is measured at -40°C , $+25^\circ\text{C}$, $+85^\circ\text{C}$, and $+125^\circ\text{C}$. Endurance conditions are subject to change pending EEPROM qualification.

² Retention lifetime equivalent at junction temperature (T_J) = 85°C as per JEDEC Standard 22, Method A117. The derated retention lifetime equivalent at junction temperature $T_J = 125^\circ\text{C}$ is 2.87 years and is subject to change pending EEPROM qualification.

Timing Diagram

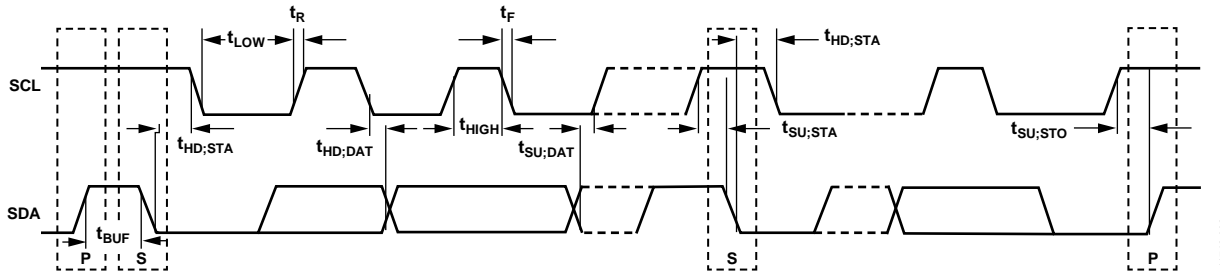

Figure 2. Serial Bus Timing Diagram

11742-902

ABSOLUTE MAXIMUM RATINGS

Table 2.

Parameter	Rating
Supply Voltage (Continuous), V_{DD}	4.2 V
Digital Pins: OUTA, OUTB, OUTC, OUTD, OUTAUX, SR1, SR2, GATE, PGOOD1, PGOOD2	-0.3 V to $V_{DD} + 0.3$ V
VS3- to PGND, AGND, DGND	-0.3 V to +0.3 V
VS1, VS2, VS3+, ACSNS	-0.3 V to $V_{DD} + 0.3$ V
RTD, ADD	-0.3 V to $V_{DD} + 0.3$ V
CS1, CS2+, CS2-	-0.3 V to $V_{DD} + 0.3$ V
FLAGIN, PSON	-0.3 V to $V_{DD} + 0.3$ V
SDA, SCL	-0.3 V to $V_{DD} + 0.3$ V
SHAREo, SHAREi	-0.3 V to $V_{DD} + 0.3$ V
Operating Temperature Range	-40°C to +125°C
Storage Temperature Range	-65°C to +150°C
Junction Temperature	150°C
Peak Solder Reflow Temperature	
SnPb Assemblies (10 sec to 30 sec)	240°C
RoHS-Compliant Assemblies (20 sec to 40 sec)	260°C
ESD Charged Device Model	1.5 kV
ESD Human Body Model	3.5 kV

Stresses above those listed under Absolute Maximum Ratings may cause permanent damage to the device. This is a stress rating only; functional operation of the device at these or any other conditions above those indicated in the operational section of this specification is not implied. Exposure to absolute maximum rating conditions for extended periods may affect device reliability.

THERMAL RESISTANCE

θ_{JA} is specified for the worst-case conditions, that is, a device soldered in a circuit board for surface-mount packages.

Table 3. Thermal Resistance

Package Type	θ_{JA}	θ_{JC}	Unit
32-Lead LFCSP	44.4	6.4	°C/W

SOLDERING

It is important to follow the correct guidelines when laying out the PCB footprint for the [ADP1046AW](#) and when soldering the part onto the PCB. For detailed information about these guidelines, see the [AN-772 Application Note](#).

ESD CAUTION



ESD (electrostatic discharge) sensitive device. Charged devices and circuit boards can discharge without detection. Although this product features patented or proprietary protection circuitry, damage may occur on devices subjected to high energy ESD. Therefore, proper ESD precautions should be taken to avoid performance degradation or loss of functionality.

PIN CONFIGURATION AND FUNCTION DESCRIPTIONS

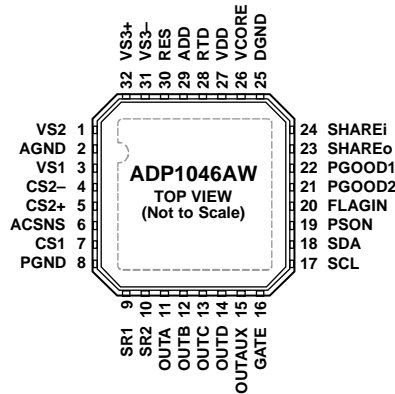

NOTES

1. THE ADP1046AW HAS AN EXPOSED THERMAL PAD ON THE UNDERSIDE OF THE PACKAGE. FOR INCREASED RELIABILITY OF THE SOLDER JOINTS AND MAXIMUM THERMAL CAPABILITY, IT IS RECOMMENDED THAT THE PAD BE SOLDERED TO THE PCB AGND PLANE.

11742-003

Figure 3. Pin Configuration

Table 4. Pin Function Descriptions

Pin No.	Mnemonic	Description
1	VS2	Power Supply Output Voltage Sense Input. This signal is referenced to PGND and is the input to a low frequency Σ - Δ ADC. Nominal voltage at this pin should be 1 V. The resistor divider on this input must have a tolerance specification of 0.5% or better to allow for trimming.
2	AGND	Analog Ground. This pin is the ground for the analog circuitry and the return for the VDD pin of the ADP1046AW .
3	VS1	Local Output Voltage Sense Input. This signal is referenced to PGND. Nominal voltage at this pin should be 1 V. The resistor divider on this input must have a tolerance specification of 0.5% or better to allow for trimming.
4	CS2-	Inverting Differential Current Sense Input. Nominal voltage at this pin should be 1 V for best operation. When using low-side current sensing, place a 5 k Ω resistor between the sense resistor and this pin. When using high-side current sensing in a 12 V application, place a 5.5 k Ω resistor between the sense resistor and this pin. When using high-side current sensing with a voltage other than 12 V, use the following formula to calculate the resistor value: $R = (V_{OUT} - 1)/2 \text{ mA}$. A 0.1% resistor must be used to connect this circuit. If this pin is not used, connect it to PGND and set CS2 \pm to high-side current sense mode (set Bit 2 of Register 0x27). It is recommended that a 500 pF to 1000 pF capacitor be connected either across the resistor or from this pin to AGND.
5	CS2+	Noninverting Differential Current Sense Input. Nominal voltage at this pin should be 1 V for best operation. When using low-side current sensing, place a 5 k Ω resistor between the sense resistor and this pin. When using high-side current sensing in a 12 V application, place a 5.5 k Ω resistor between the sense resistor and this pin. When using high-side current sensing with a voltage other than 12 V, use the following formula to calculate the resistor value: $R = (V_{OUT} - 1)/2 \text{ mA}$. A 0.1% resistor must be used to connect this circuit. If this pin is not used, connect it to PGND and set CS2 \pm to high-side current sense mode (set Bit 2 of Register 0x27). It is recommended that a 500 pF to 1000 pF capacitor be connected either across the resistor or from this pin to AGND.
6	ACSNS	AC Sense Input. This input is connected upstream of the main output inductor through a resistor divider network. The nominal voltage for this circuit is 0.45 V. This pin is also connected to the voltage feedforward ADC (nominal voltage 1 V). This signal is referenced to PGND.
7	CS1	Primary Side Current Sense Input. This pin is connected to the primary side current sensing ADC and to the fast OCP comparator. This signal is referenced to PGND. The resistors on this input must have a tolerance specification of 0.5% or better to allow for trimming. If this pin is not used, connect it to PGND.
8	PGND	Power Ground. This pin is the ground connection for the main power rail of the power supply and is the reference for all voltage and current sensing other than CS2 \pm and VS3 \pm . Star connect to AGND.
9	SR1	Synchronous Rectifier Output. This PWM output connects to the input of a FET driver. This signal is referenced to AGND. This pin can be disabled when not in use.
10	SR2	Synchronous Rectifier Output. This PWM output connects to the input of a FET driver. This signal is referenced to AGND. This pin can be disabled when not in use.
11	OUTA	PWM Output for Primary Side Switch. This signal is referenced to AGND. This pin can be disabled when not in use.
12	OUTB	PWM Output for Primary Side Switch. This signal is referenced to AGND. This pin can be disabled when not in use.
13	OUTC	PWM Output for Primary Side Switch. This signal is referenced to AGND. This pin can be disabled when not in use.

Pin No.	Mnemonic	Description
14	OUTD	PWM Output for Primary Side Switch. This signal is referenced to AGND. This pin can be disabled when not in use.
15	OUTAUX	Auxiliary PWM Output. This signal is referenced to AGND. This pin can be disabled when not in use.
16	GATE	OrFET Gate Drive Output. This signal is referenced to AGND. If this pin is not used, leave it floating.
17	SCL	I ² C Serial Clock Input. This signal is referenced to AGND.
18	SDA	I ² C Serial Data Input and Output (Open Drain). This signal is referenced to AGND.
19	PSON	Power Supply On Input. This signal is referenced to AGND. This pin is the hardware PSON control signal. It is recommended that a 1 nF capacitor be connected from the PSON pin to AGND for noise debouncing and decoupling.
20	FLAGIN	Flag Input. An external signal can be input at this pin to generate a flag condition.
21	PGOOD2	Power-Good Output (Open Drain). This signal is referenced to AGND. This pin is controlled by the PGOOD2 flag. This pin is set by a programmable combination of internal flags. If this pin is not used, connect it to AGND.
22	PGOOD1	Power-Good Output (Open Drain). This signal is referenced to AGND. This pin is controlled by the PGOOD1 flag. This pin is set by a programmable combination of internal flags. If this pin is not used, connect it to AGND.
23	SHAREo	Share Bus Output Voltage Pin. Connect this pin to 3.3 V through a pull-up resistor (typically 2.2 k Ω). When configured for a digital share bus, this pin is a digital output. This signal is referenced to AGND. If this pin is not used, connect it to AGND.
24	SHAREi	Share Bus Feedback Pin. Connect this pin to the SHAREo pin. This signal is referenced to AGND. If this pin is not used, connect it to AGND.
25	DGND	Digital Ground. This pin is the ground reference for the digital circuitry of the ADP1046AW . Star connect to AGND.
26	VCORE	Output of the 2.5 V Regulator. Connect a decoupling capacitor of at least 330 nF (1 μ F maximum) from this pin to DGND as close to the IC as possible to minimize PCB trace length. It is recommended that the VCORE pin not be used as a reference or to generate other logic levels using resistive dividers.
27	VDD	Positive Supply Input. This signal is referenced to AGND. Connect a 4.7 μ F decoupling capacitor from this pin to AGND as close to the IC as possible to minimize PCB trace length.
28	RTD	Thermistor Input. Place a thermistor (100 k Ω , 1%; beta = 4250, 1%) in parallel with a 16.5 k Ω , 1% resistor. This pin is referenced to AGND. If this pin is not used, connect it to AGND.
29	ADD	Address Select Input. This pin is used to program the I ² C address. Connect a resistor from ADD to AGND. This signal is referenced to AGND.
30	RES	Resistor Input. This pin sets up the internal voltage reference for the ADP1046AW . Connect a 10 k Ω , \pm 0.1% resistor from RES to AGND. This signal is referenced to AGND.
31	VS3-	Inverting Remote Voltage Sense Input. There should be a low ohmic connection to AGND. The resistor divider on this input must have a tolerance specification of 0.5% or better to allow for trimming. Connect a 0.1 μ F capacitor from VS3- to AGND.
32	VS3+	Noninverting Remote Voltage Sense Input. This signal is referenced to VS3-, and the nominal input voltage at this pin is 1 V. The resistor divider on this input must have a tolerance specification of 0.5% or better to allow for trimming. This pin is the input to the high frequency Δ - Σ ADC.
	EP	Exposed Pad. The ADP1046AW has an exposed thermal pad on the underside of the package. For increased reliability of the solder joints and maximum thermal capability, it is recommended that the pad be soldered to the PCB AGND plane.

TYPICAL PERFORMANCE CHARACTERISTICS



Figure 4. VS1 ADC Accuracy vs. Temperature (from 10% to 90% of FSR)



Figure 7. CS1 ADC Accuracy vs. Temperature (from 10% to 50% of FSR)



Figure 5. VS2 ADC Accuracy vs. Temperature (from 10% to 90% of FSR)



Figure 8. CS2 ADC Accuracy vs. Temperature (from 10% to 90% of FSR)



Figure 6. VS3 ADC Accuracy vs. Temperature (from 10% to 90% of FSR)



Figure 9. RTD ADC Accuracy vs. Temperature (from 10% to 90% of FSR)



Figure 10. ACSNS ADC Accuracy vs. Temperature (from 10% to 90% of FSR)

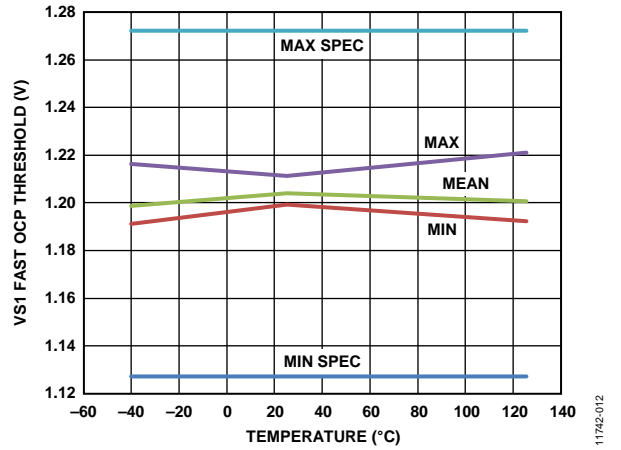

Figure 12. VS1 Fast OCP Threshold vs. Temperature



Figure 11. CS1 Fast OCP Threshold vs. Temperature

THEORY OF OPERATION

The **ADP1046AW** is a secondary side controller for switch mode power supplies. It is designed for use in isolated redundant applications. The **ADP1046AW** integrates the typical functions that are needed to control a power supply, such as

- Output voltage sense and feedback
- Voltage line feedforward control
- Digital loop filter compensation
- PWM generation
- Current sharing
- Current, voltage, and temperature sense
- OrFET control
- Housekeeping and I²C interface
- Calibration and trimming

The main function of controlling the output voltage is performed using the feedback ADCs, the digital loop filter, and the PWM block.

The feedback ADCs use a multipath approach (patent pending). The **ADP1046AW** combines a high speed, low resolution (fast and coarse) ADC with a low speed, high resolution (slow and accurate) ADC. Loop compensation is implemented using the digital filter. This proportional, integral, derivative (PID) filter is implemented in the digital domain to allow easy programming of filter characteristics, which is of great value in customizing and debugging designs.

The PWM block generates up to seven programmable PWM outputs for control of FET drivers and synchronous rectification FET drivers. This programmability allows many traditional and unique switching topologies to be realized.

A current share bus interface is provided for paralleling multiple power supplies. The **ADP1046AW** also has hot-swap OrFET sense and control for N + 1 redundant power supplies.

Conventional power supply housekeeping features, such as remote and local voltage sense and primary and secondary side current sense, are included. An extensive set of protections is offered, including overvoltage protection (OVP), overcurrent protection (OCP), overtemperature protection (OTP), undervoltage protection (UVP), ground continuity monitoring (voltage continuity), and ac sense.

All these features are programmable through the I²C bus interface. This bus interface is also used to calibrate the power supply. Other information that is useful for power monitoring, such as input current, output current, and fault flags, is also available through the I²C bus interface.

The internal EEPROM can store all programmed values and allows standalone control without a microcontroller. A free, downloadable GUI is available and provides all the necessary software to program the **ADP1046AW**. To obtain the latest software and a user guide, visit <http://www.analog.com/digitalpower>.

The **ADP1046AW** operates from a single 3.3 V supply and is specified from -40°C to +125°C.



Figure 13. Simplified Block Diagram

11742-013

CURRENT SENSE

The ADP1046AW has two current sense inputs: CS1 and CS2±. These inputs sense, protect, and control the primary input current, secondary output current, and the share bus information. They can be calibrated to reduce errors due to external components.

CS1 Operation (CS1)

CS1 is typically used for the monitoring and protection of the primary side current, which is commonly sensed using a current transformer (CT). The input signal at the CS1 pin is fed into an ADC for current monitoring. The range of the ADC is 0 V to 1.4 V. The input signal is also fed into a comparator for pulse-by-pulse OCP protection. The typical configuration for the CS1 current sense is shown in Figure 14.



Figure 14. Current Sense 1 (CS1) Operation

The CS1 ADC is used to measure the average value of the primary current; the reading is averaged every 2.62 ms in an asynchronous fashion to make fault decisions. The ADP1046AW also writes the 12-bit CS1 reading every 10 ms to Register 0x13.

The fast OCP comparator is used to limit the instantaneous primary current within each switching cycle and has a nominal threshold of 1.2 V.

Various thresholds and limits can be set for CS1, as described in the Current Sense and Current Limit Registers section.

CS2 Operation (CS2+, CS2-)

CS2+ and CS2- are differential inputs used for the monitoring and protection of the secondary side current. The full-scale range of the CS2 ADC is programmable to 60 mV or 120 mV. The differential inputs are fed into an ADC through a pair of external resistors that provide the necessary level shifting. The device pins, CS2+ and CS2-, are internally regulated to approximately 1 V by internal current sources.

When using low-side current sensing, the current sources are 200 μA; therefore, the required resistor value is $1\text{ V}/200\ \mu\text{A} = 5\ \text{k}\Omega$. When using high-side current sensing, the current sources are 2 mA; therefore, the resistor value required is $(V_{\text{OUT}} - 1\ \text{V})/2\ \text{mA}$. In the case of $V_{\text{OUT}} = 12\ \text{V}$, the required resistor value is 5.5 kΩ.

Typical configurations are shown in Figure 15 and Figure 16. Various thresholds and limits can be set for CS2±, such as OCP. These thresholds and limits are described in the Current Sense and Current Limit Registers section.



Figure 15. Low-Side Resistive Current Sense (Recommended)



Figure 16. High-Side Resistive Current Sense

When the CS2+ and CS2- inputs are not in use, connect them directly to PGND, and set CS2± to high-side current sense mode (Register 0x27[2] = 1).

The CS2 ADC is used to measure the CS2 current; the reading is averaged every 2.62 ms in an asynchronous fashion. This averaged reading is used to make fault decisions, such as the CS2 OCP fault. The ADP1046AW also writes the 12-bit CS2 reading every 10 ms to Register 0x18.

VOLTAGE SENSE AND CONTROL LOOP

Multiple voltage sense inputs on the ADP1046AW are used for the monitoring, control, and protection of the power supply output. This information is available through the I²C interface. All voltage sense points can be calibrated digitally to minimize errors due to external components. This calibration can be performed in the production environment, and the settings can be stored in the EEPROM of the ADP1046AW (see the Power Supply Calibration and Trim section for more information).

For voltage monitoring, the VS1, VS2, and VS3 voltage value registers (Register 0x15, Register 0x16, and Register 0x17, respectively) are updated every 10 ms. The ADP1046AW stores every ADC sample for 10 ms and then outputs the average value at the end of the 10 ms period. Therefore, if these registers are read at least every 10 ms, a true average value is read.

The ADP1046AW uses two separate sensing points: VS1 and VS3±, depending on the condition of the OrFET. When the OrFET is turned off, the control loop is regulated via VS1; when the OrFET is turned on, the control loop is regulated via the differential sensing on VS3±. This sensing mechanism effectively performs a local and remote voltage sense.

The control loop of the ADP1046AW features a patented multi-path architecture. The output voltage is converted simultaneously by two ADCs: a high accuracy ADC and a high speed ADC. The complete signal is reconstructed and processed in the digital filter to provide a high performance, cost competitive solution.

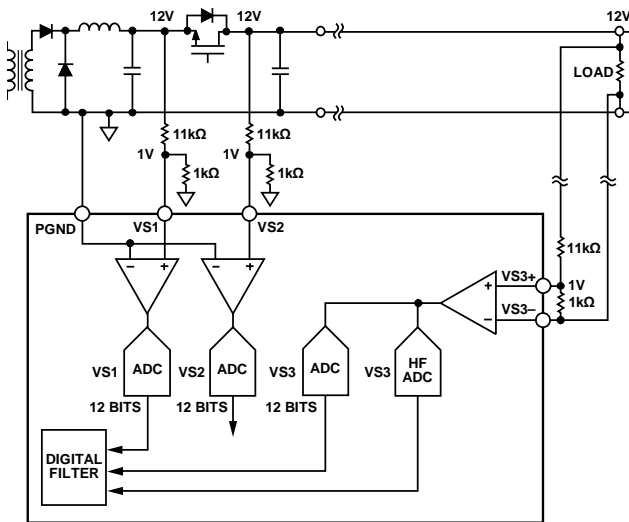

Figure 17. Voltage Sense Configuration

ADCs

Two kinds of Σ-Δ ADCs are used in the feedback loop of the ADP1046AW: a low frequency (LF) ADC that runs at 1.56 MHz and a high frequency (HF) ADC that runs at 25 MHz.

Σ-Δ ADCs have a resolution of one bit and operate differently from traditional flash ADCs. The equivalent resolution that can be obtained depends on how long the output bit stream of the Σ-Δ ADC is sampled.

Σ-Δ ADCs also differ from Nyquist rate ADCs in that the quantization noise is not uniform across the frequency spectrum. At lower frequencies, the noise is lower, and at higher frequencies, the noise is higher (see Figure 18).

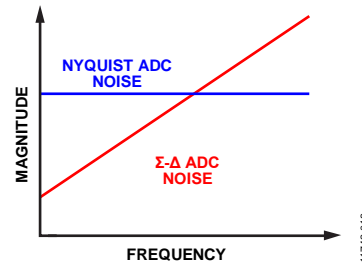

Figure 18. Noise Performance for Nyquist Rate and Σ-Δ ADCs

The low frequency ADC runs at approximately 1.56 MHz. For a specified bandwidth, the equivalent resolution can be calculated as follows:

$$\ln(1.56 \text{ MHz}/BW)/\ln(2) = N \text{ bits}$$

For example, at a bandwidth of 95 Hz, the equivalent resolution/noise is

$$\ln(1.56 \text{ MHz}/95)/\ln(2) = 14 \text{ bits}$$

At a bandwidth of 1.5 kHz, the equivalent resolution/noise is

$$\ln(1.56 \text{ MHz}/1.5 \text{ kHz})/\ln(2) = 10 \text{ bits}$$

The high frequency ADC has a clock of 25 MHz. It is comb filtered and outputs at the switching frequency (f_{sw}) into the digital filter. The equivalent resolution at some sample frequencies is listed in Table 5.

Table 5. Equivalent Resolutions for High Frequency ADC at Various Switching Frequencies

f_{sw} (kHz)	High Frequency ADC Resolution
48.8	9 bits
97.7	8 bits
195.3	7 bits
390.6	6 bits

The HF ADC has a range of ±30 mV. Using a base switching frequency (f_{sw}) of 100 kHz (8-bit HF ADC resolution), when f_{sw} increases to 200 kHz (7-bit HF ADC resolution), the quantization noise is 0.9375 mV (1 LSB). Increasing f_{sw} to 400 kHz increases the quantization noise to 3.75 mV (1 LSB = $2 \times 30 \text{ mV}/2^6 = 0.9375 \text{ mV}$).

VS1 OPERATION (VS1)

VS1 is used for the monitoring and protection of the power supply voltage at the output of the LC stage, upstream of the OrFET. The VS1 sense point on the power rail needs an external resistor divider to bring the nominal input voltage to 1 V at the VS1 pin (see Figure 17). The resistor divider is necessary because the VS1 ADC input range is 0 V to 1.6 V (12-bit reading). This divided-down signal is internally fed into a low speed Σ-Δ ADC. The output of the VS1 ADC goes to the digital filter and is also updated in Register 0x15 every 10 ms. The VS1 signal is referenced to PGND. When the OrFET is turned off, the power supply is regulated from the VS1 sense point instead of the VS3± sense point.

VS2 OPERATION (VS2)

VS2 is used in conjunction with VS1 to control the OrFET gate drive turn-on. The VS2 sense point on the power rail needs an external resistor divider to bring the nominal common-mode signal to 1 V at the VS2 pin (see Figure 17).

The resistor divider is necessary because the VS2 ADC input range is 0 V to 1.6 V. This divided-down signal is internally fed into the VS2 ADC. The output of the VS2 ADC goes to the VS2 voltage value register (Register 0x16). The VS2 signal is never used for the control loop but is used to control the turn-on and turn-off of the OrFET (see the OrFET Control (GATE Pin) section) as well as the voltage continuity flag. If the OrFET function of the ADP1046AW is not used, it is recommended that the VS2 input be connected directly to PGND. The VS2 value is updated in Register 0x16 every 10 ms.

VS3 OPERATION (VS3+, VS3-)

VS3± is used for the monitoring and protection of the remote load voltage. VS3± is a fully differential input that is the main feedback sense point for the power supply control loop. The VS3± sense point on the power rail needs an external resistor divider to bring the nominal common-mode signal to 1 V at the VS3± pins (see Figure 17). The resistor divider is necessary because the VS3 ADC input range is 0 V to 1.6 V. This divided-down signal is internally fed into a high frequency (HF) ADC. The output of the VS3 ADC goes to the digital filter and is also updated in Register 0x17 every 10 ms. The HF ADC is also the high frequency feedback loop for the power supply.

VOLTAGE LINE FEEDFORWARD AND ACSNS

The ADP1046AW supports voltage line feedforward control to improve line transient performance. The ACSNS value is used to divide the output of the digital filter, and the result is fed into the PWM engine. The input voltage signal can be sensed at the secondary winding of the isolation transformer and must be filtered by an RCD network to eliminate the voltage spike at the switch node (see Figure 19).

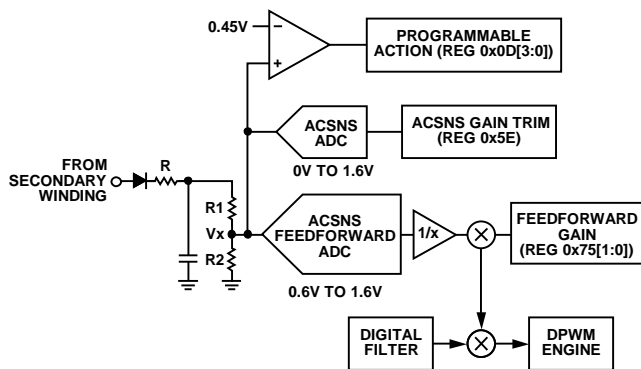

Figure 19. Feedforward Configuration

The ACSNS voltage must be set to 1 V when the nominal input voltage is applied. The ACSNS ADC sampling period is 10 μs; therefore, the decision to modify the PWM outputs based on input voltage is performed at this rate.

The feedforward scheme modifies the modulation value based on the ACSNS voltage. When the ACSNS input is 1 V, the line feedforward has no effect. For example, if the digital filter output remains unchanged and the ACSNS voltage changes to 50% of its original value (still higher than 0.5 V), the modulation of the falling edge of OUTx doubles and vice versa (see Figure 20). The voltage line feedforward function is optional and is programmable using Register 0x75.

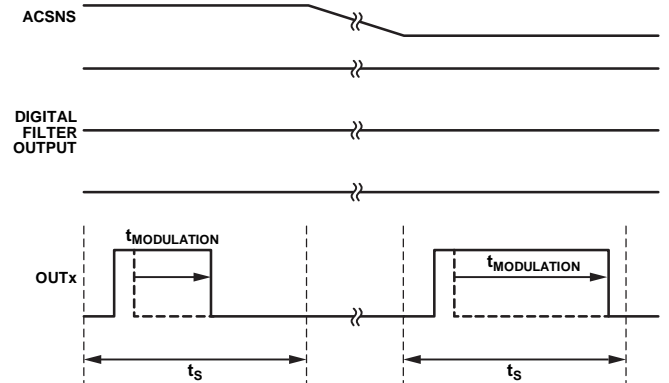

Figure 20. Feedforward Control on Modulation

The ACSNS level comparator is also connected on the same pin and flags an ACSNS fault when the voltage on the pin is below 0.45 V within each switching period. The ACSNS level comparator is used to detect whether the node is switching.

DIGITAL FILTER

The loop response of the power supply can be changed using the internal programmable digital filter. A Type 3 filter architecture has been implemented. To tailor the loop response to the specific application, the low frequency gain, zero location, pole location, and high frequency gain can all be set individually (see the Digital Filter Programming Registers section). It is recommended that the Analog Devices, Inc., software GUI be used to program the filter. The software GUI displays the filter response in Bode plot format and can be used to calculate all stability criteria for the power supply.

From the sensed voltage to the duty cycle, the transfer function of the filter in z-domain is as follows:

$$H(z) = \left(\frac{d}{202.24 \times m} \times \frac{z}{z-1} \right) + \left(\frac{c}{7.68} \times \frac{z-b}{z-a} \right)$$

where:

a = filter_pole_register_value/256.

b = filter_zero_register_value/256.

c = high_frequency_gain_register_value.

d = low_frequency_gain_register_value.

m = 1 when 48.8 kHz ≤ f_{sw} < 97.7 kHz.

m = 2 when 97.7 kHz ≤ f_{sw} < 195.3 kHz.

m = 4 when 195.3 kHz ≤ f_{sw} < 390.6 kHz.

m = 8 when 390.6 kHz ≤ f_{sw}.

f_{sw} is the switching frequency.

To transfer the z-domain value to the s-domain, plug the following bilinear transformation equation into the H(z) equation:

$$z(s) = \frac{2f_{sw} + s}{2f_{sw} - s}$$

The digital filter introduces an extra phase delay element into the control loop. The digital filter circuit sends the duty cycle information to the PWM circuit at the beginning of each switching cycle (unlike an analog controller, which makes decisions on the duty cycle information continuously). Therefore, the extra phase delay for phase margin, Φ , introduced by the filter block is

$$\Phi = 360 \times (f_c/f_{sw})$$

where:

f_c is the crossover frequency.

f_{sw} is the switching frequency.

At one-tenth the switching frequency, the phase delay is 36° . The GUI incorporates this phase delay into its calculations. Note that the GUI does not account for other delays such as gate driver and propagation delays.

Two sets of registers allow for two distinct filter responses. The main filter, called the normal mode filter, is controlled by programming Register 0x60 to Register 0x63. The light load mode filter is controlled by programming Register 0x64 to Register 0x67. The ADP1046AW uses the light load mode filter only when the output current measured on CS2± is below the load current threshold (programmed using Register 0x3B[2:0]).

The Analog Devices software GUI allows the user to program the light load mode filter in the same manner as the normal mode filter. It is recommended that the GUI be used for this purpose.

In addition, during the soft start process, a soft start filter can be used in combination with the normal mode filter and the light load mode filter. The soft start filter is programmed using Register 0x71 to Register 0x74. For more information, see the Soft Start section.

Filter Transitions

To avoid output voltage glitches and provide a seamless transition from one filter to another, the ADP1046AW supports programmable filter transitions. This feature allows a gradual transition from one filter to another. Filter transitions are programmed using Register 0x7A[2:0].

PWM AND SYNCHRONOUS RECTIFIER OUTPUTS (OUTA, OUTB, OUTC, OUTD, OUTAUX, SR1, SR2)

The PWM and SR outputs are used for control of the primary side drivers and the synchronous rectifier drivers. These outputs can be used for several control topologies such as full-bridge, phase-shifted ZVS configurations and interleaved, two switch forward converter configurations. Delays between rising and falling edges can be individually programmed. Special care must be taken to avoid shoot-through and cross-conduction. It is recommended that the Analog Devices software GUI be used to program these outputs. Figure 21 shows an example configuration to drive a full-bridge, phase-shifted topology with synchronous rectification.



Figure 21. PWM Pin Assignment for Full-Bridge, Phase-Shifted Topology with Synchronous Rectification

The PWM and SR outputs are all synchronized with each other. Therefore, when reprogramming more than one of these outputs, it is important to first update all the registers and then latch the information into the ADP1046AW at the same time. During reprogramming, the outputs are temporarily disabled. A special instruction is sent to the ADP1046AW to ensure that new timing information is programmed simultaneously. This is done by setting Bit 1 in Register 0x7F. It is recommended that PWM outputs be disabled when not in use.

OUTAUX is an additional PWM output pin. OUTAUX allows an extra PWM signal to be generated at a different frequency from the other six PWM outputs. This signal can be used to drive an extra power converter stage, such as a buck controller located in front of a full-bridge converter. OUTAUX can also be used as a clock reference signal.

For more information about the various programmable switching frequencies and PWM timings, see the PWM and Synchronous Rectifier Timing Registers section (Register 0x3F to Register 0x5C).

SYNCHRONOUS RECTIFICATION

SR1 and SR2 are recommended for use as the PWM control signals when using synchronous rectification. These PWM signals can be configured much like the other PWM outputs.

An optional soft start can be applied to the synchronous rectifier PWM outputs. The SR soft start can be programmed using Register 0x54[1:0].

- When SR soft start is disabled (Register 0x54[0] = 0), the SR signals are turned on to their full PWM duty cycle values immediately.
- When SR soft start is enabled (Register 0x54[0] = 1), the SR signals ramp up from zero duty cycle to the desired duty cycle in steps of 40 ns per switching cycle.

The advantage of ramping the SR signals is to minimize the output voltage step that occurs when the SR FETs are turned on without a soft start. The advantage of turning the SR signals completely on immediately is that they can help to minimize the voltage transient caused by a load step.

Using Register 0x54[1], the SR soft start can be programmed to occur only once (the first time that the SR signals are enabled) or every time that the SR signals are enabled, for example, when the system enters or exits light load mode.

When programming the ADP1046AW to use SR soft start, ensure correct operation of this function by setting the falling edge of SR1 (t_{10}) to a lower value than the rising edge of SR1 (t_9) and by setting the falling edge of SR2 (t_{12}) to a lower value than the rising edge of SR2 (t_{11}). SR soft start can also be disabled by setting Register 0x0F[7] = 1.

SYNCHRONOUS RECTIFIER (SR) DELAY

The ADP1046AW is well suited for dc-to-dc converters in isolated topologies. Every time a PWM signal crosses the isolation barrier an additional propagation delay is added due to the isolating components. The ADP1046AW allows programming of an adjustable delay (0 ns to 315 ns in steps of 5 ns) using Register 0x79[5:0]. This delay moves both SR1 and SR2 later in time to compensate for the added delay due to the isolating components (see Figure 57). In this way, the edges of all PWM outputs can be aligned, and the SR delay can be applied separately as a constant dead time.

LIGHT LOAD MODE

The ADP1046AW can be configured to disable PWM outputs under light load conditions based on the value of CS2.

Register 0x3B and Register 0x7D are used to program the light load mode thresholds for turn-off and turn-on of SR1, SR2, and other PWM outputs. Below the light load threshold programmed in Register 0x3B, the SR outputs are disabled; the user can also program any of the other PWM outputs to shut down below this threshold. Light load mode allows the ADP1046AW to be used with interleaved topologies that incorporate automatic phase shedding at light load.

To prevent the system from oscillating between light load and normal modes due to the thresholds being programmed too close to each other, a programmable debounce is provided in Register 0x7D[5:4]. This debounce prevents the part from changing state within the programmed interval.

The speed of the SR enable is programmable from 37.5 μ s to 300 μ s in four discrete steps using Register 0x7D[3:2]. This ensures that, in case of a load step, the SR signals (and any other PWM outputs that are temporarily disabled) can be turned on quickly enough to prevent damage to the FETs that they are controlling.

The light load mode digital filter is also used during light load mode.

MODULATION LIMIT

The modulation limit register (Register 0x2E) can be programmed to apply a maximum duty cycle modulation limit to any PWM signal, thus limiting the modulation range of any PWM output. When modulation is enabled, the maximum modulation limit is applied to all PWM outputs collectively. As shown in Figure 22, this limit is the maximum time variation for the modulated edges from the default timing, following the configured modulation direction. There is no minimum duty cycle limit setting. Therefore, the user must set the rising edges and falling edges based on the case with the least modulation.

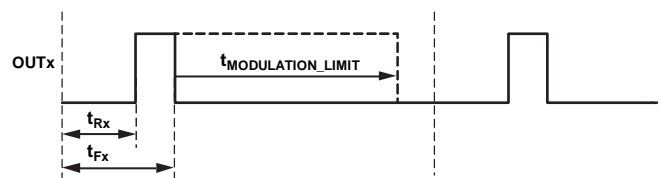

Figure 22. Modulation Limit Settings

Each LSB in Register 0x2E corresponds to a different time step size, depending on the switching frequency (see Table 46). The modulated edges cannot extend beyond one switching cycle.

The GUI provided with the ADP1046AW is recommended for programming this feature (see Figure 23).



Figure 23. Setting Modulation Limits (Modulation Range Shown by Arrows)

SOFT START

The turning on and off of the [ADP1046AW](#) is controlled by the hardware PS_ON pin and/or the software PS_ON register, depending on the configured settings in Register 0x2C. When the user turns on the power supply (enables PS_ON), the following soft start procedure occurs (see Figure 24).

1. The PS_ON signal is enabled at Time t_0 . If the part is programmed to be always on (Register 0x2C[7:6] = 00), PS_ON is enabled as soon as V_{CORE} is above UVLO.
2. The [ADP1046AW](#) waits for the programmed PS_ON delay (set in Register 0x2C[4:3]).
3. The soft start begins to ramp up the internal digital reference. The total duration of the soft start ramp is programmable from 5 ms to 100 ms using Register 0x5F[7:5].
4. If the soft start from precharge function is enabled (Register 0x5F[4] = 1), the soft start ramp starts from the value of the output voltage sensed on VS1 or VS3± (depending on the OrFET status), and the soft start ramp time is reduced proportionally. If the soft start from precharge function is disabled, the soft start ramp time is the programmed value in Register 0x5F[7:5].
5. When the power supply voltage exceeds the VS1 under-voltage protection (UVP) limit (set in Register 0x34[6:0]), the UVP flag is reset.
6. The OrFET is turned on as soon as the OrFET enable threshold is met. (The OrFET enable threshold is programmed in Register 0x30[6:5].) The regulation point is switched from VS1 to VS3±.
7. If no other fault conditions are present, the PGOOD_x signals wait for the programmed debounce time (set in Register 0x2D[7:4]) and are then enabled. The soft start flag must be unmasked in Register 0x7B and Register 0x7C (Bit 7 must be set to 0).
8. If no OrFET is used, the power supply must be configured to regulate using VS3 at all times (Register 0x33[2] = 1). VS2 can be used as a secondary OVP mechanism.

Fault Condition During Soft Start

If a fault condition occurs during soft start, the controller responds as programmed unless the flag is blanked. Flag blanking during soft start is programmed in Register 0x0F. The ACSNS flag is always blanked during soft start. The OTP, FLAGIN, OVP, and OCP fault flags can be blanked during soft start by setting the appropriate bits in Register 0x0F.

The UVP fault is blanked only for the debounce time during soft start. Therefore, if the soft start period exceeds the debounce time, the UVP fault is triggered and stored in the first flag ID register (Register 0x10). A read of the latched fault registers and the first flag ID register clears the falsely triggered UVP condition.

Digital Compensation Filters During Soft Start

The [ADP1046AW](#) has a dedicated soft start filter (SSF) that can be used to fine-tune and optimize the dynamic response during the output voltage ramp-up.

Before it ramps up the internal reference after the PS_ON signal is enabled, the [ADP1046AW](#) evaluates whether the OrFET should be turned on or off by looking at the difference between VS1 and VS2. This step is done to determine whether the regulation point should be VS1 or VS3± (see Figure 24).

- If the regulation point is VS1, the soft start filter is used by default during the ramp-up. At the end of the soft start ramp, the part switches to the normal mode filter (NMF).
- If the regulation point is VS3±, the part starts the ramp using the normal mode filter (NMF).

In both cases, after the voltage reaches 12.5% of the nominal output voltage value, the load current is evaluated.

- If the load current is below the light load mode threshold, the part switches to the light load mode filter (LLF).
- If the load current is above the light load mode threshold, the normal mode filter is used until the end of the soft start ramp, even if the system subsequently enters light load mode based on a change to the load current.

Register 0x2C can be programmed to configure the use of the different filters during soft start as follows:

- Force soft start filter (Bit 0). This option forces the part to use the soft start filter even when the regulation point is VS3. In some cases, this option allows better fine-tuning of the ramp-up voltage. This option can also be selected when an OrFET is not used.
- Disable light load mode during soft start (Bit 1). This option prevents the use of the light load mode filter during soft start, even if the light load condition is met. The light load mode filter is available for use after the end of the soft start ramp.

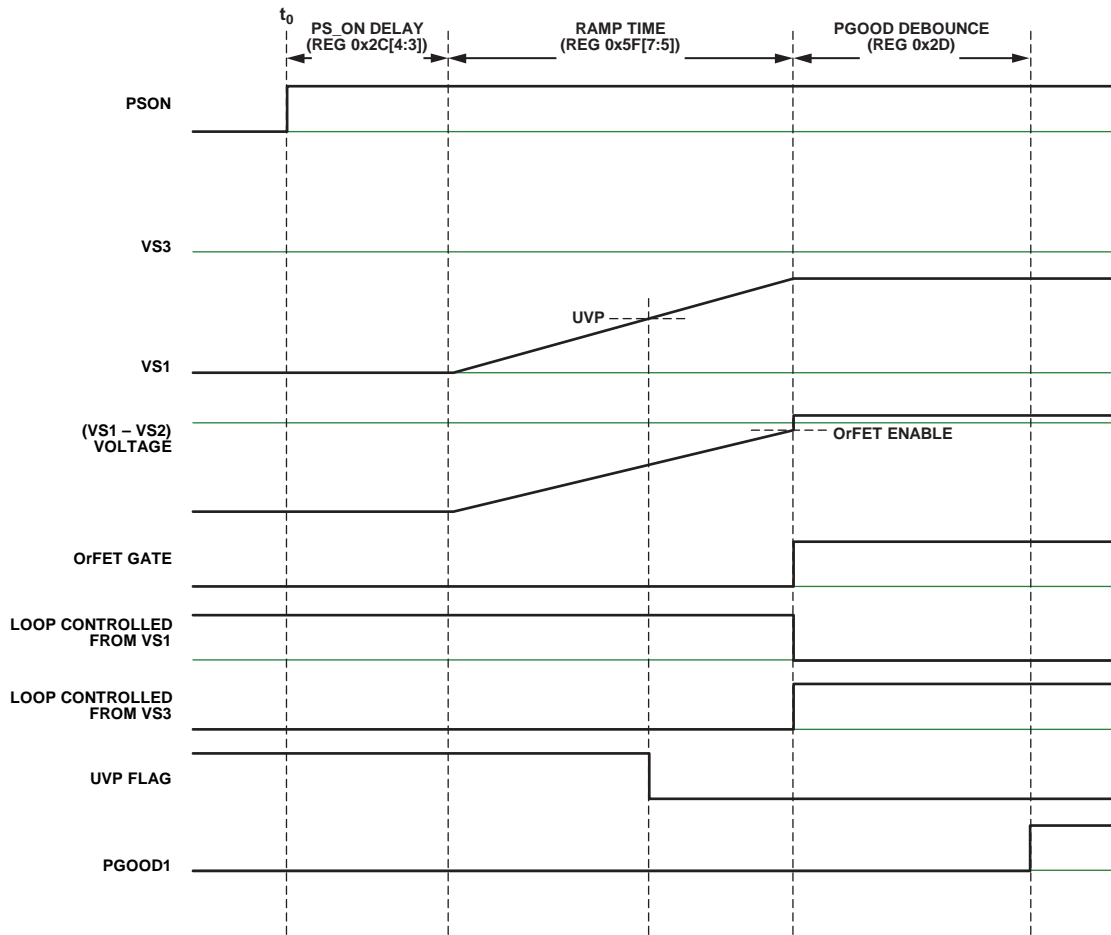

Figure 24. Soft Start Timing Diagram

11742-024

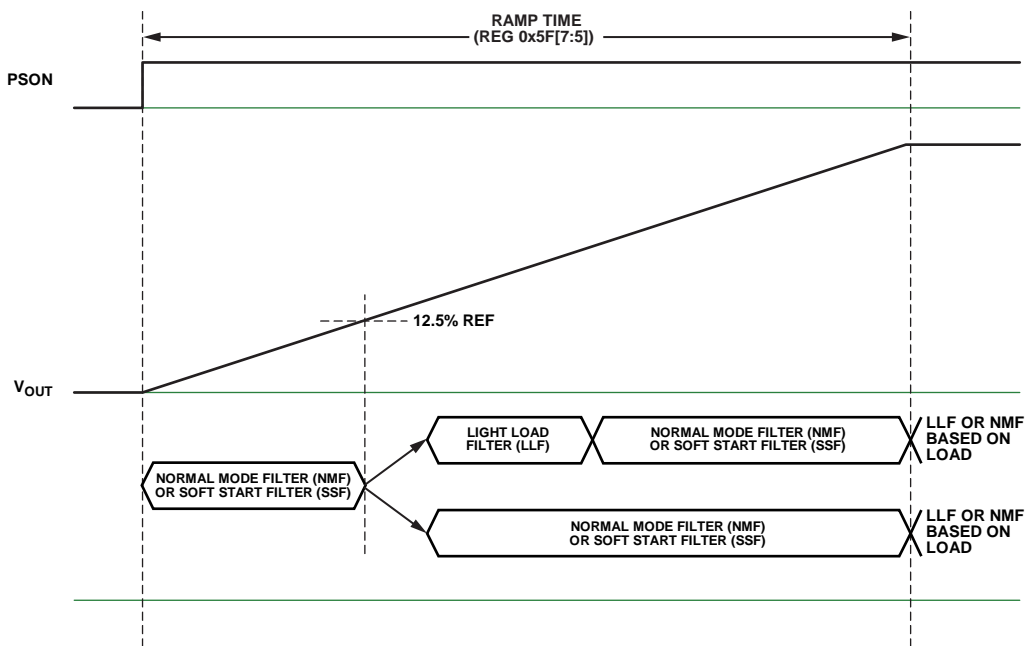

Figure 25. Filter Sequencing at Startup

11742-025

OrFET CONTROL (GATE PIN)

The GATE control signal drives an external OrFET. The OrFET is used in redundant systems to protect against power flow into the power supply from the output terminals of another supply. This ensures that power flows only out of the power supply and that the unit can be hot-swapped.

The GATE pin is a totem-pole output and does not require a pull-up resistor. The GATE pin polarity can be programmed via Register 0x2D[1] to be active high or active low. The GATE output is CMOS level (0 V to 3.3 V). An external driver is required to turn the OrFET on or off.

OrFET Turn-On

The turn-on process for the OrFET is controlled by the voltage difference between VS1 and VS2. For this reason, the VS1 and VS2 readings must be correctly calibrated for the OrFET function to perform properly.

The OrFET turn-on circuit detects the voltage difference between VS1 and VS2 (see Figure 26). When the forward voltage drop from VS1 to VS2 is greater than the programmable OrFET enable threshold set in Register 0x30[6:5], the OrFET is enabled. The OrFET enable threshold can be set to 0%, -0.5%, -1%, or -2% of the nominal output voltage.

OrFET Turn-Off

The OrFET can be turned off by three methods:

- Fault flag. Any flag in a fault configuration register (Register 0x08 to Register 0x0D) can be programmed with an action to turn off the OrFET. The OrFET is kept off for as long as the flag is set.

- OrFET programmable comparator. If the reverse voltage present on CS2± exceeds the analog comparator threshold programmed in Register 0x30[4:2], the OrFET is turned off. This comparator can be disabled using Register 0x30[0].
- GATE signal disable. When Register 0x5D[0] = 1, the GATE signal is disabled and has no effect on the VSx feedback point.

OrFET GATE Control and Regulation Points

The GATE signal is enabled when the threshold configured in Register 0x30[6:5] is met. The GATE signal controls a very important function of output voltage regulation: the control loop sensing point.

- When the GATE signal is disabled, the OrFET is turned off and the voltage regulation sensing point is VS1.
- When the GATE signal is enabled, the OrFET is turned on and the voltage regulation sensing point is VS3±.

Recommended Setup for a 12 V Application

In normal operating mode, follow this procedure:

- When $12\text{ V} < V_{\text{OUT}} < \text{OVP}$, use the fast OrFET control circuit to turn off the OrFET.
- When $V_{\text{OUT}} > \text{OVP}$, use load OVP to turn off the OrFET.

In light load mode, follow this procedure:

- When $12\text{ V} < V_{\text{OUT}} < \text{OVP}$, use ACSNS to turn off the OrFET.
- When $V_{\text{OUT}} > \text{OVP}$, use load OVP to turn off the OrFET.

In a 12 V application, when an internal short circuit occurs, use CS1 OCP or VS1 UVP to shut down the unit and restart it.



Figure 26. OrFET Control Circuit Detailed Internal Diagram

11742-026

OrFET Operation Examples

Hot Plug into a Live Bus

A new PSU is plugged into a live 12 V bus (yellow). The internal voltage, VS1 (red), is ramped up before the OrFET is turned on. After the OrFET is turned on (green), current in the new PSU begins to flow to the load (blue). The turn-on voltage threshold between the new PSU and the bus is programmable.

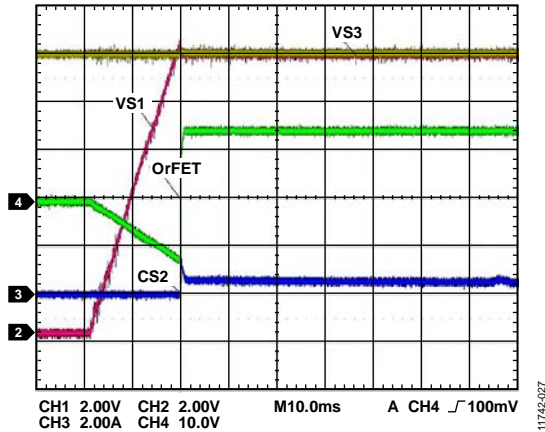

Figure 27. Hot Plug into a Live Bus (Yellow Is Bus Voltage; Red Is VS1 Voltage; Green Is OrFET Control Signal; Blue Is Load Current)

Runaway Master

A rogue PSU on the bus (yellow) has a fault condition, causing the bus voltage to increase above the OVP threshold. The good PSU turns off the OrFET (green) and regulates its internal voltage, VS1 (red). When the rogue power supply fault condition is removed, the bus voltage decreases. The OrFET of the good PSU is immediately turned on, and the good PSU resumes regulating from VS3±.

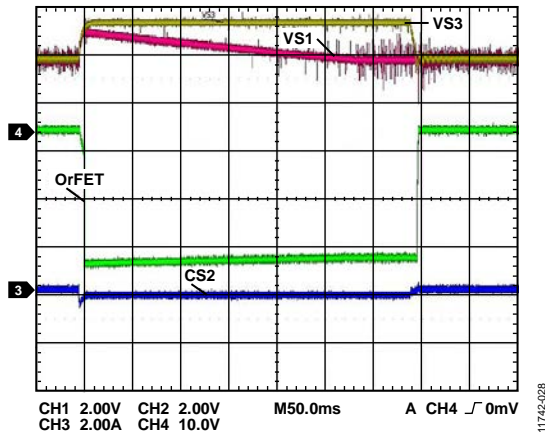

Figure 28. Runaway Master (Yellow Is Bus Voltage; Red Is VS1 Voltage; Green Is OrFET Control Signal; Blue Is Load Current)

Short Circuit

When one of the output rectifiers fails, the bus voltage can collapse if the OrFET is not promptly turned off. The fast OrFET comparator is used to protect the system from this fault event. Figure 29 shows a short circuit applied to the output capacitors before the OrFET. After the fast OrFET threshold for CS2± (blue) is triggered, the OrFET (green) is turned off. Figure 29 also shows the operation when the short circuit is removed. The internal regulation point, VS1 (red), returns to 12 V, and the OrFET (green) is reenabled. The PSU again begins to contribute current to the load (blue).

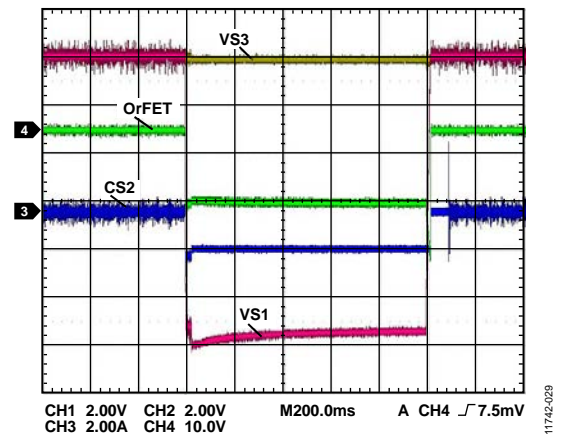

Figure 29. Internal Short Circuit (Yellow Is Bus Voltage; Red Is VS1 Voltage; Green Is OrFET Control Signal; Blue Is Load Current)

Light Load Mode Operation

PSU 1 increases its voltage at light load from 12 V to 12.1 V (yellow). Both PSU 1 and PSU 2 are CCM; therefore PSU 1 sources current and PSU 2 sinks current (blue). In PSU 2, the OrFET control turns off the OrFET to prevent reverse current from flowing. Note that the OrFET voltage (green) is solid during this transition because PSU 1 and PSU 2 are in CCM mode.

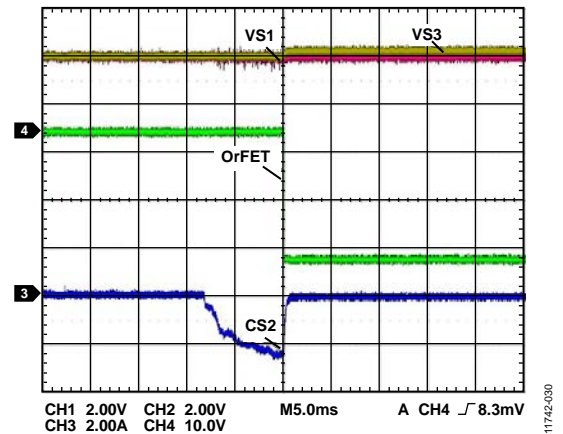

Figure 30. Light Load Mode (Yellow Is Bus Voltage; Red Is VS1 Voltage; Green Is OrFET Control Signal; Blue Is Load Current)

VDD

When VDD is applied, a certain time elapses before the part is capable of regulating the power supply. When VDD rises above the power-on reset and UVLO levels, it takes approximately 20 μ s for V_{CORE} to reach its operational point of 2.5 V. The EEPROM contents are then downloaded to the registers. The download takes an additional 25 μ s (approximately). After the EEPROM download, the ADP1046AW is ready for operation.

If the ADP1046AW is programmed to power up at this time (PSON is enabled), the soft start ramp begins. Otherwise, the part waits for the PSON signal.

The proper amount of decoupling capacitance must be placed between VDD and AGND, as close as possible to the device to minimize the trace length. It is recommended that the V_{CORE} pin not be used as a reference or to generate other logic levels using resistive dividers.

VDD/V_{CORE} OVLO

The ADP1046AW has built-in overvoltage protection (OVP) on its supply rails. When the VDD or V_{CORE} voltage rises above the OVLO threshold, the response can be programmed using Register 0x0E[7:5]. It is recommended that when a VDD/V_{CORE} OVP fault occurs, the response be set to download the EEPROM before restarting the part (set Register 0x0E[6] = 1).

POWER GOOD

The ADP1046AW has two open-drain power-good pins. The PGOOD1 pin is driven low when a PGOOD1 fault condition is present; the PGOOD2 pin is driven low when a PGOOD2 fault condition is present.

The PGOOD1 and PGOOD2 pins and flags can be programmed to respond to the following flags:

- Soft start
- CS1 fast OCP
- CS1 accurate OCP
- CS2 accurate OCP
- UVP
- Local OVP (fast and accurate)
- Load OVP
- OrFET (GATE pin)

The masking of these flags is programmed in Register 0x7B (for PGOOD1) and Register 0x7C (for PGOOD2). When a flag is masked, it does not set PGOOD1 or PGOOD2.

The following additional flags can also set the PGOOD2 pin either unconditionally or based on the flag response, as programmed in Register 0x2D[3] (see Figure 31 and Table 45).

- Voltage continuity
- OrFET disable
- ACSNS
- External flag (FLAGIN pin)
- OTP

These additional flags can be programmed in Register 0x2D[3] to always set PGOOD2 or to set PGOOD2 only if the flag action is not set to “ignore” in the fault configuration register for that flag (see Table 12 and Table 13).

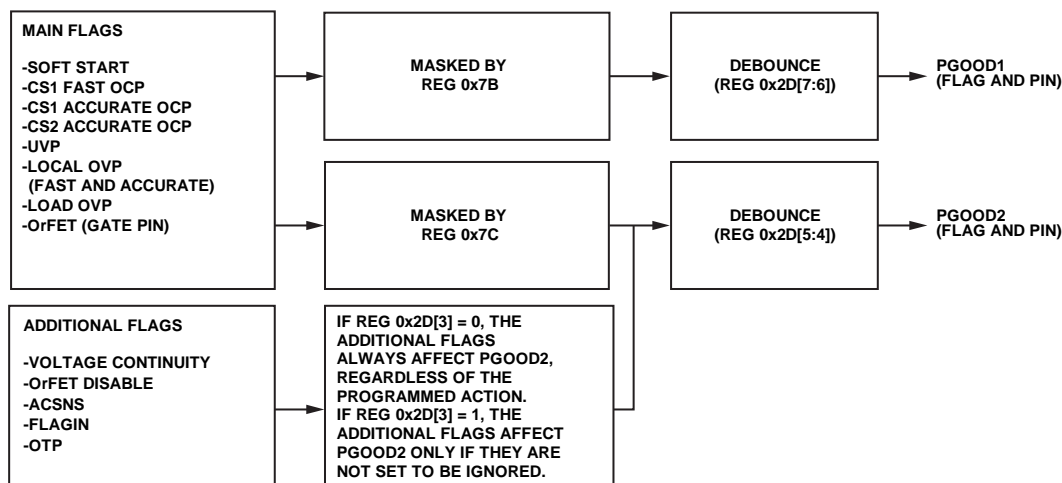

Figure 31. PGOOD1, PGOOD2 Programming

11742-001

CURRENT SHARING

The ADP1046AW supports both analog current sharing and digital current sharing. The ADP1046AW uses the CS2 current information for current sharing (this setting is programmed in Register 0x29[3]).

Analog Current Sharing

Analog current sharing uses the internal current sensing circuitry to provide a current reading to an external current error amplifier. Therefore, an additional differential current amplifier is not necessary.

The current reading from CS2 can be output to the SHAREo pin in the form of a digital bit stream, which is the output of the current sense ADC (see Figure 33). The bit stream from the Σ - Δ ADC is proportional to the current delivered by this unit to the load. By filtering this digital bit stream using an external RC filter, the current information is turned into an analog voltage that is proportional to the current delivered by this unit to the load. This voltage can be compared to the share bus voltage. If the unit is not supplying enough current, an error signal can be applied to the VS3± feedback point. This signal causes the unit to increase its output voltage and, in turn, its current contribution to the load.

Digital Share Bus

The digital share bus scheme is similar in principle to the traditional analog share bus scheme. The difference is that instead of using a voltage on the share bus to represent current, a digital word is used.

The ADP1046AW outputs a digital word onto the share bus. The digital word is a function of the current that the power supply is providing (the higher the current, the larger the digital word).

The power supply with the highest current controls the bus (master). A power supply that is putting out less current (slave) sees that another supply is providing more power to the load than it is.

During the next cycle, the slave increases its current output contribution by increasing its output voltage. This cycle continues until the slave outputs the same current as the master, within a programmable tolerance range. Figure 32 shows the configuration of the digital share bus.



Figure 32. Digital Current Share Configuration

The digital share bus is based on a single-wire communication bus principle; that is, the clock and data signals are contained together.

When two or more ADP1046AW devices are connected, they synchronize their share bus timing. This synchronization is performed by the start bit at the beginning of a communications frame. If a new ADP1046AW is hot-swapped onto an existing digital share bus, the device waits to begin sharing until the next frame. The new ADP1046AW monitors the share bus until it sees a stop bit, which designates the end of a share frame. It then performs synchronization with the other ADP1046AW devices during the next start bit. The digital share bus frame is shown in Figure 34.



Figure 33. Analog Current Share Configuration



Figure 34. Digital Current Share Frame Timing Diagram

Figure 35 shows the possible signals on the share bus.



Figure 35. Share Bus High, Low, and Idle Bits

The length of a bit (t_{BIT}) is fixed at 10 μ s. A Logic 1 is defined as a high-to-low transition at the start of the bit and a low-to-high transition at 75% of t_{BIT} . A Logic 0 is defined as a high-to-low transition at the start of the bit and a low-to-high transition at 25% of t_{BIT} .

The bus is idle when it is high during the whole period of t_{BIT} . All other activity on the bus is illegal. Glitches up to t_{GLITCH} (200 ns) are ignored.

The digital word that represents the current information is eight bits long. The ADP1046AW takes the eight MSBs of the CS2 reading and uses this reading as the digital word (see Figure 36).

Digital Share Bus Scheme

Each power supply compares the digital word that it is outputting with the digital words of all the other supplies on the bus.

Round 1

In Round 1, every supply first places its MSB on the bus. If a supply senses that its MSB is the same as the value on the bus, it continues to Round 2. If a supply senses that its MSB is less than the value on the bus, it means that this supply must be a slave.

When a supply becomes a slave, it stops communicating on the share bus because it knows that it is not the master. The supply then increases its output voltage in an attempt to share more current.

If two units have the same MSB, they both continue to Round 2 because either of them may be the master.

Round 2

In Round 2, all supplies that are still communicating on the bus place their second MSB on the share bus. If a supply senses that its MSB is less than the value on the bus, it means that this supply must be a slave and it stops communicating on the share bus.

Round 3 to Round 8

The same algorithm is repeated for up to eight rounds to allow supplies to compare their digital words and, in this way, to determine whether each unit is the master or a slave.

Digital Share Bus Configuration

The digital share bus can be configured in various ways. The bandwidth of the share bus loop is programmable in Register 0x29[2:0]. The extent to which a slave tries to match the current of the master is programmable in Register 0x2A[3:0]. Enable the digital share bus by setting Register 0x29[3] to 1.



Figure 36. How the Share Bus Generates the Digital Word to Place on the Digital Share Bus

POWER SUPPLY SYSTEM AND FAULT MONITORING

The ADP1046AW has extensive system and fault monitoring capabilities. The system monitoring functions include voltage, current, power, and temperature readings. The fault conditions include out-of-limit values for current, voltage, power, and temperature. The limits for the fault conditions are programmable. The ADP1046AW has an extensive set of flags that are set when certain programmed thresholds or limits are exceeded. These thresholds and limits are described in the Fault Registers section.

FLAGS

The ADP1046AW has an extensive set of flags that are set when certain limits, conditions, and thresholds are exceeded. The real-time status of these flags can be read in Register 0x00 to Register 0x03. The response to these flags is individually programmable. Flags can be ignored or used to trigger actions such as turning off certain PWM outputs or the OrFET gate. Flags can also be used to turn off the power supply. The ADP1046AW can be programmed to respond when these flags are reset. For more information, see the Fault Registers section.

The ADP1046AW also has a set of latched fault registers (Register 0x04 to Register 0x07). The latched fault registers have the same flags as Register 0x00 to Register 0x03, but the flags in the latched registers remain set so that intermittent faults can be detected. Reading a latched fault register resets all the flags in that register.

MONITORING FUNCTIONS

The ADP1046AW monitors and reports several signals, including voltages, currents, power, and temperature. All these values are stored in separate registers and can be read through the I²C interface. For more information, see the Value Registers section.

VOLTAGE READINGS

The VS1, VS2, and VS3 ADCs have an input range of 1.6 V. The outputs of the ADCs are 12-bit values, which means that the LSB size is $1.6 \text{ V}/4096 = 390.625 \mu\text{V}$. The user is limited to an input range of 1.4 V, which means that the ADC output code is limited to $1.4 \text{ V}/390.6 \mu\text{V} = 3584$.

The equation to calculate the ADC code at a specified voltage (V_x) at the pin is given by the following formula:

$$ADC \text{ Code} = V_x/1.6 \times 4096$$

For example, when there is 1 V on the input of the ADC,

$$ADC \text{ Code} = 1 \text{ V}/1.6 \times 4096$$

$$ADC \text{ Code} = 2560$$

In a 12 V application, the 12 V reading is divided down using a resistor divider network to provide 1 V at the sense pin. Therefore, to convert the register value to a real voltage, use the following formula:

$$V_{OUT} = (LSB \times 2560) \times ((R1 + R2)/R2)$$

In a 12 V system, this equates to

$$V_{OUT} = (390.625 \mu\text{V} \times 2560) \times (11 \text{ k}\Omega + 1 \text{ k}\Omega)/1 \text{ k}\Omega$$

CURRENT READINGS

CS1 Pin

CS1 has an input range of 1.4 V. The ADC performs a 12-bit reading conversion of this value, which means that the LSB size is $1.4 \text{ V}/4096 = 341.8 \mu\text{V}$.

When there is exactly 1 V on the CS1 pin, the value in the CS1 value register (Register 0x13[15:4]) reads 2926.

The equation to calculate the ADC code at a specified CS1 input voltage (V_x) is given by the following formula:

$$ADC \text{ Code} = V_x/1.4 \times 4096$$

For example, when there is 1 V on the CS1 input pin,

$$ADC \text{ Code} = 1 \text{ V}/1.4 \times 4096$$

$$ADC \text{ Code} = 2926$$

CS2+, CS2– Pins

The full-scale (FS) range for the CS2 ADC can be set to 60 mV or 120 mV using Register 0x27[5].

The CS2 ADC has an input range of 120 mV. The resolution is 12 bits, which means that the LSB size is $120 \text{ mV}/4096 = 29.30 \mu\text{V}$. The user is limited to an input range of 110 mV.

The equation to calculate the ADC code at a specified CS2 input voltage (V_x) is given by the following formula:

$$ADC \text{ Code} = V_x/(120 \text{ mV}) \times 4096$$

For example, when there is 50 mV on the input of the ADC,

$$ADC \text{ Code} = 50 \text{ mV}/120 \text{ mV} \times 4096$$

$$ADC \text{ Code} = 1707$$

Therefore, to convert the CS2 register value to a real current, use the following formula:

$$I_{OUT} = (CS2_ADC_CODE/4096) \times (FS/R_{SENSE})$$

where:

CS2_ADC_CODE is the value in Register 0x18[15:4].

FS is the full-scale voltage drop (60 mV or 120 mV).

R_{SENSE} is the sense resistor value.

For example, if CS2_ADC_CODE = 1520, R_{SENSE} = 10 mΩ, and FS = 120 mV, the real current is calculated as follows:

$$I_{OUT} = (1520/4096) \times (120 \text{ mV}/10 \text{ m}\Omega)$$

$$I_{OUT} = 4.453 \text{ A}$$

POWER READINGS

The output power value register (Register 0x19) is the product of the VS3 voltage value and the CS2 current value. Therefore, a combination of the formulas in the Voltage Readings section and the CS2+, CS2– Pins section is used to calculate the power reading in watts. This register is a 16-bit word. It multiplies two 12-bit numbers and discards the eight LSBs.

$$P_{OUT} = V_{OUT} \times I_{OUT}$$

For example,

$$P_{OUT} = 12\text{ V} \times 4.453\text{ A} = 53.436\text{ W}$$

POWER MONITORING ACCURACY

The ADP1046AW power monitoring accuracy is specified relative to the full-scale range of the signal that it is measuring.

FIRST FLAG FAULT ID AND VALUE REGISTERS

When the ADP1046AW registers several fault conditions, it stores the value of the first fault in a dedicated register. For example, if the overtemperature (OTP) fault is registered followed by an OVP fault, the OTP flag is stored in the first flag ID register (Register 0x10). This register gives the user more information for fault diagnosis than a simple flag. The contents of this register are latched, meaning that they are stored until read by the user. The contents are also reset by toggling PSON. If a flag is set to be ignored, it does not appear in the first flag register.

EXTERNAL FLAG INPUT (FLAGIN PIN)

The FLAGIN pin can be used to send an external fault signal into the ADP1046AW. Register 0x0A[3:0] can be used to program the FLAGIN flag to trigger an action.

TEMPERATURE READINGS (RTD PIN)

The RTD pin is set up for use with an external negative temperature coefficient (NTC) thermistor (see Figure 38). The RTD pin has an internal programmable current source. An ADC monitors the voltage on the RTD pin.

The RTD temperature value register, Register 0x1A, is updated every 10 ms. The ADP1046AW stores every ADC sample for 10 ms and then outputs the average value at the end of the 10 ms period.

The RTD ADC has an input range of 1.6 V and a resolution of 12 bits, which means that the LSB size is $1.6\text{ V}/4096 = 390.625\text{ }\mu\text{V}$. The user is limited to an input range of 1.3 V, which means that the maximum ADC output code is limited to $1.3\text{ V}/390.6\text{ }\mu\text{V} = 3328$.

The output of the RTD ADC is linearly proportional to the voltage on the RTD pin. However, thermistors exhibit a nonlinear function of resistance vs. temperature. Therefore, the user must perform postprocessing on the RTD ADC reading to accurately read the temperature.

By connecting an external resistor (R_{EXT}) in parallel with the NTC thermistor (TH), a constant current can be used to achieve linearization (see Figure 37).



Figure 37. Temperature Measurement Using Thermistor

An internal, precision current source of 10 μA , 20 μA , 30 μA , or 40 μA can be selected in Register 0x11. This current source can be trimmed by means of an internal DAC to compensate for thermistor accuracy (see the RTD/OTP Trim section). The user can select the size of the output current source using Bits[7:6] of Register 0x11.

The ADP1046AW implements a linearization scheme based on a preselected combination of external components and current selection for best performance when measuring linearized temperatures in degrees Celsius in the industrial range.

For more information about the required thermistor and selecting and trimming the precision current sources, see the Temperature Linearization Scheme section.

Optionally, the user can process the RTD reading and perform postprocessing in the form of a lookup table or polynomial equation to match the specific NTC thermistor used. With the internal current source set to 46 μA , the equation to calculate the ADC code at a specified NTC thermistor value (R_x) is given by the following formula:

$$ADC\ CODE = 46\ \mu\text{A} \times R_x / 1.6 \times 4096$$

For example, at 60°C, the NTC thermistor at the RTD pin is 21.82 k Ω .

$$RTD_ADC_CODE = 46\ \mu\text{A} \times 21.82\text{ k}\Omega / 1.6 \times 4096 = 2570$$

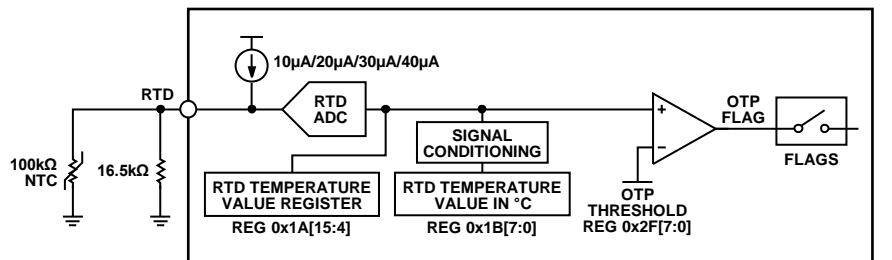

Figure 38. RTD Pin Internal Details

Temperature Linearization Scheme

The ADP1046AW implements a linearization scheme based on a preselected combination of thermistor (100 kΩ, 1%), external resistor (16.5 kΩ, 1%), and the 46 μA current source for best performance when linearizing measured temperatures in the industrial range.

The required NTC thermistor should have a resistance of 100 kΩ, 1%, such as the NCP15WF104F03RC (beta = 4250, 1%). It is recommended that 1% tolerance be used for both the resistor and beta values.

Reading the Linearized Temperature

Reading Register 0x1B (updated every 10 ms) returns the current temperature according to an internal linearization scheme. See Table 1 for the specified accuracy of these measurements. The temperature reading result is represented in 8-bit decimal format in °C; therefore, the temperature range for this reading is from 0°C to 255°C.

OVERTEMPERATURE PROTECTION (OTP)

If the temperature sensed at the RTD pin exceeds the threshold programmed in Register 0x2F, the OTP flag is set. The response to the OTP flag is programmable using Register 0x0B[7:4].

An RTD trim is required to make accurate temperature readings at the lower end of the RTD ADC range to account for tolerances in the NTC thermistor and the external resistor. This trim results in a more accurate measurement for determining the OTP threshold (see the RTD/OTP Trim section).

OVERCURRENT PROTECTION (OCP)

The ADP1046AW has several OCP functions. CS1 and CS2± have separate OCP circuits to provide both primary and secondary side protection.

CS1 OCP

CS1 has two protection circuits: CS1 fast OCP and CS1 accurate OCP (see Figure 39).

CS1 Fast OCP

CS1 fast OCP is an analog comparator. When the voltage at the CS1 pin exceeds the (fixed) 1.2 V threshold, the CS1 fast OCP flag is set. A programmable blanking time can be set to ignore the leading edge current spike at the beginning of the current signal (leading edge blanking).

A debounce time can be programmed to improve the noise immunity of the OCP circuit. When the CS1 fast OCP comparator is set, the OUTA, OUTB, OUTC, and OUTD PWM outputs are immediately disabled for the remainder of the switching cycle. These outputs are reenabled at the start of the next switching cycle. This function cannot be bypassed.

CS1 Accurate OCP

CS1 accurate OCP is used for more precise control of overcurrent protection. With CS1 accurate OCP, the reading at the output of the CS1 ADC (Register 0x13) is compared to a programmable OCP limit. The CS1 accurate OCP value can be programmed from 0 to 31 decimal using Register 0x22[4:0]. If the CS1 reading exceeds the CS1 accurate OCP limit, the CS1 accurate OCP flag is set. The CS1 ADC is asynchronously sampled, and the readings are averaged every 2.62 ms to make a fault decision. The flag response is programmed in Register 0x08.



Figure 39. CS1 OCP Detailed Internal Schematic



Figure 40. CS2 OCP Detailed Internal Schematic

CS2 OCP

CS2 has one OCP protection circuit: CS2 accurate OCP (see Figure 40). The reading at the output of the CS2 ADC (Register 0x18) is compared to a programmable OCP threshold. The CS2 OCP threshold can be programmed using Register 0x26[7:0]. If the CS2 reading exceeds the CS2 OCP threshold, the CS2 accurate OCP flag is set. The CS2 ADC is asynchronously sampled, and the readings are averaged every 2.62 ms to make a fault decision. The flag response is programmed in Register 0x09.

CONSTANT CURRENT MODE

The ADP1046AW can be configured to operate in constant current mode. The threshold to enter constant current mode operation is 3% current below the CS2 accurate OCP setting (see Figure 41). Below this current, the part operates in constant voltage mode, using the output voltage as the feedback signal for closed-loop operation.

Figure 41. Constant Current Mode (V_{OUT} vs. I_{OUT})

When the ADP1046AW reaches the constant current mode threshold, a flag is set in Register 0x02[4] and in Register 0x06[4] (real-time and latched flag registers, respectively). When this flag is set, the CS2 current reading is used to control the output voltage regulation point. The output voltage is ramped down linearly as the load increases to ensure that the current remains constant.

The constant current control loop is relatively low bandwidth because the current is averaged over a 328 μ s period. The output voltage changes at a maximum rate of 1.18 V/sec at the VS3 \pm pins; therefore, the instantaneous value of the current can exceed the constant current limit for a very short period of time, depending upon the transient.

As the output voltage falls, the UVP flag (Register 0x0B[3:0]) can be used to program a shutdown action.

OVERVOLTAGE PROTECTION (OVP)

The ADP1046AW has three separate OVP circuits. If the output voltage at the VS1 pin, VS2 pin, or VS3 \pm pins exceeds the programmable threshold for that pin, the appropriate OVP flag is set. The flag response is programmed in Register 0x09[3:0] for the VS2 and VS3 OVP flags or in Register 0x0A[7:4] for the VS1 OVP flag.

VS1 has two OVP circuits: a fast comparator (fast OVP) and an ADC-based comparator (accurate OVP). VS2 and VS3 share an accurate OVP circuit.

The OVP circuits can be programmed for different OVP thresholds. See Register 0x32 and Register 0x33 for more information.

The sampling time for the ADC-based comparators is 80 μ s. Additional debounce in steps of 80 μ s can be added using Bits[1:0] of Register 0x32 and Register 0x33.

The fast OVP comparator also has a programmable threshold and debounce time. These values are programmed in Register 0x37.

UNDERVOLTAGE PROTECTION (UVP)

If the voltage sensed at the VS1 pin falls 12.5 mV below the programmable UVP threshold, the UVP flag is set. The UVP threshold is programmed in Register 0x34; the GUI can also be used, as shown in Figure 42.

The response to the UVP flag is programmable in Register 0x0B[3:0]. Undervoltage protection and the UVP flag are disabled during soft start.

AC SENSE (ACSNS)

The ACSNS circuit performs multiple monitoring and control functions. Two ADCs and a fast comparator are connected to this pin.

- The fast ADC is used for the voltage feedforward function (see the Voltage Line Feedforward and ACSNS section). This ADC has an equivalent resolution of 11 bits at 10 μs.
- The slow ADC is used to report the input voltage. This ADC has a resolution of 12 bits at 10 ms.
- The fast comparator is used to monitor whether a switching waveform is present at the output of the synchronous rectifier stage (or rectifier diodes).

The pick-off point upstream of the output inductor is connected to the ACSNS pin through an external RCD divider network.

The output of the ACSNS slow ADC is a 12-bit value reported in Register 0x14. The gain of this ADC can be adjusted using Register 0x5E[6:0] to compensate for divider errors and the voltage spike.

The equation to calculate the ADC code is given by the following formula:

$$ADC\ Code = Vx / 1.6 \times 4096$$

where Vx is the voltage at the ACSNS pin.

For example, when there is 1 V on the input of the ADC

$$ADC\ Code = 1\ V / 1.6 \times 4096$$

$$ADC\ Code = 2560$$

$$V_{SENSE} = (Vx) \times (R1 + R2) / R2$$

where V_{SENSE} is the filtered secondary voltage.

The primary input voltage can be calculated by multiplying V_{SENSE} by the turns ratio ($N1/N2$) as follows:

$$V_{PRIMARY} = Vx \times (R1 + R2) / R2 \times (N1/N2)$$

The ACSNS comparator threshold is set at 0.45 V. If the average voltage on the ACSNS pin falls below this threshold, the ACSNS flag is set in Register 0x03[2] and in Register 0x07[2] (real-time and latched flag registers, respectively), and the programmed action for the flag is executed.

When operating in resonant mode, the ACSNS comparator is used for the timing of the synchronous rectifiers and, therefore, the additional features of the ADC cannot be used. For more information, see the Resonant Mode Operation section.

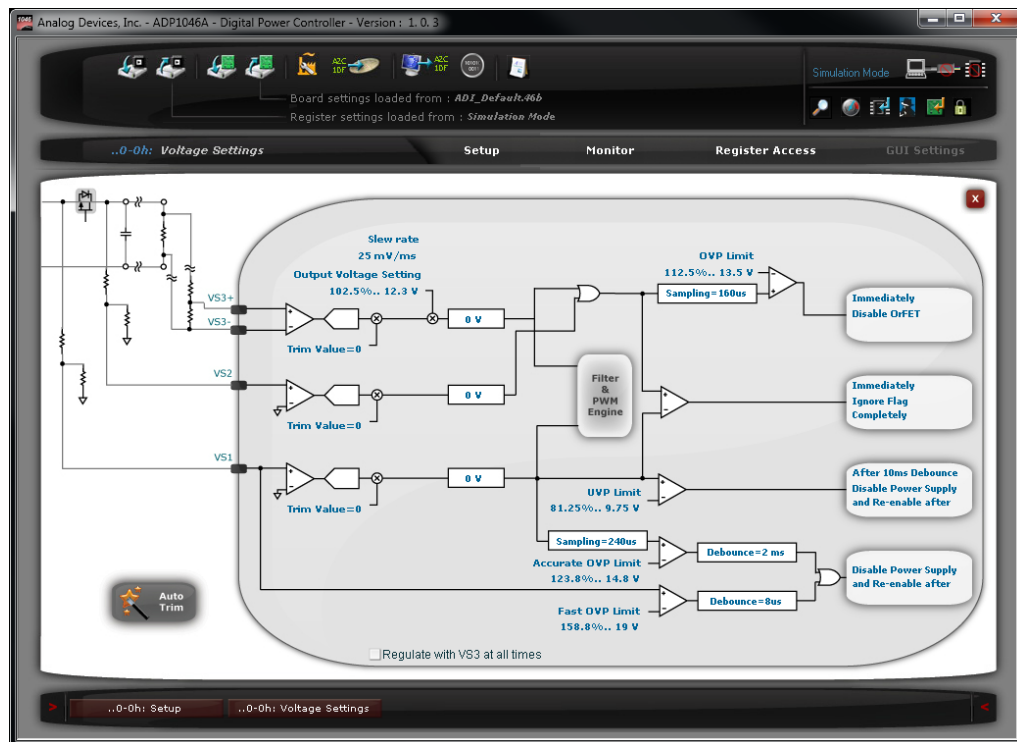

Figure 42. Voltage Sense Window in Simulation Mode (ADP1046AW GUI)

VOLT-SECOND BALANCE

The ADP1046AW has a dedicated circuit to maintain volt-second balance in the main transformer when operating in full-bridge topology. This circuit eliminates the need for a dc blocking capacitor. In interleaved topologies, volt-second balance can also be used for current balancing to ensure that each interleaved phase contributes equal power.

The circuit monitors the current flowing in both legs of the full-bridge topology and stores this information. It compensates the selected PWM signals to ensure equal current flow in both legs of the full-bridge topology. The input is through the CS1 pin.

Several switching cycles are required for the circuit to operate effectively. The maximum amount of modulation applied to each edge of the selected PWM outputs is programmable to ±80 ns or ±160 ns in Register 0x28[2].

The volt-second balance settings are programmed in Register 0x28 and in Register 0x76 through Register 0x78. It is recommended that the Analog Devices software GUI be used to program these settings.

The compensation of the PWM drive signals is performed on the edges of two selected outputs. The SR1 and SR2 edges can also be independently set to modulate due to the volt-second balance circuit to maintain the timing relation to the primary side signals.

DIGITAL LOAD LINE AND SLEW RATE

The ADP1046AW can optionally introduce a digital load line into the power supply. This option is programmed in the load line impedance register (Register 0x36). Two parameters can be configured independently: slew rate and load line value.

The slew rate (Register 0x36[6:4]) determines how quickly the output voltage is adjusted in response to a change in the digital reference. Eight different settings are available.

The load line value (Register 0x36[2:0]) controls the slope of the load line. The amount of output resistance introduced can be calculated as follows:

$$R_{OUT} = 0.1 \times V_{OUT_NOM} \times CS2\ R_{SENSE} / (CS2\ Range \times 2^{LOAD_SET[2:0]})$$

where:

V_{OUT_NOM} is the nominal output voltage when VS3 = 1 V.

$CS2\ R_{SENSE}$ is the sense resistor value.

$CS2\ Range$ is 120 mV or 60 mV.

$LOAD_SET[2:0]$ is the value of Bits[2:0] in Register 0x36 (0 to 7 decimal).

For example, if $V_{OUT_NOM} = 12\ V$, $CS2\ R_{SENSE} = 10\ m\Omega$, $CS2\ Range = 120\ mV$, and $LOAD_SET[2:0] = 3$,

$$R_{OUT} = 0.1 \times 12\ V \times 10\ m\Omega / (120\ mV \times 2^3) = 12.5\ m\Omega$$

This feature can be used for advanced current sharing techniques. By default, the load line is disabled. The load line is introduced digitally by modifying the value of the digital reference based on the CS2 reading.

Figure 43 and Figure 44 show the load line as a percentage of V_{OUT} vs. the R_{SENSE} voltage drop.

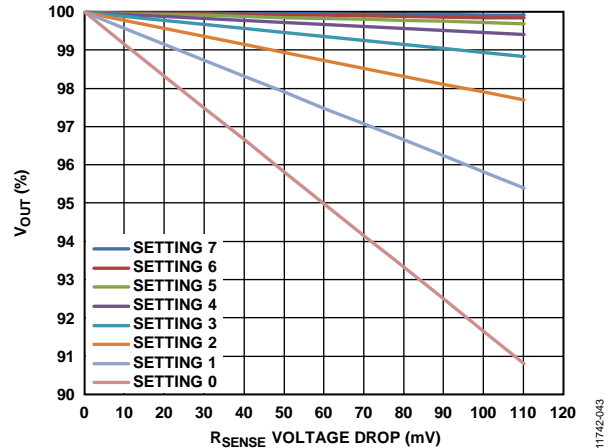

Figure 43. Load Line Settings with 120 mV CS2 Range

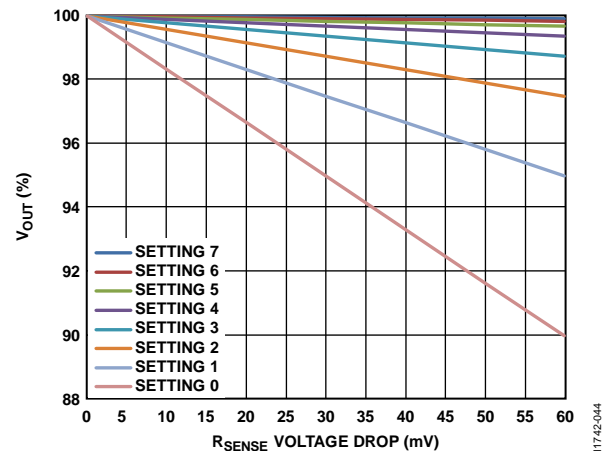

Figure 44. Load Line Settings with 60 mV CS2 Range

POWER SUPPLY CALIBRATION AND TRIM

The [ADP1046AW](#) allows the entire power supply to be calibrated and trimmed digitally in the production environment. It can calibrate items such as output voltage and trim for tolerance errors introduced by sense resistors and resistor dividers, as well as its own internal circuitry. The part is factory trimmed, but it can be retrimmed by the user to compensate for the errors introduced by external components. The [ADP1046AW](#) GUI allows the user to automatically revert the trim settings to their factory default values.

To unlock the trim registers for write access, write to the TRIM_PASSWORD register (Register 0x89). Write the trim password twice (the factory default password is 0xFF).

The [ADP1046AW](#) allows the user enough trim capability to trim for external components with a tolerance of 0.5% or better. If the [ADP1046AW](#) is not trimmed in the production environment, it is recommended that components with a tolerance of 0.1% or better be used for the inputs to CS1, CS2, VS1, VS2, and VS3 to meet data sheet specifications.

CS1 TRIM

Using a DC Signal

A known voltage (V_x) is applied at the CS1 pin. The CS1 ADC should output a digital code equal to $V_x/1.4 \times 4096$. The CS1 gain trim register (Register 0x21) is adjusted until the CS1 ADC value in Register 0x13[15:4] reads the correct digital code.

Using an AC Signal

A known current (I_x) is applied to the PSU input. This current passes through a current transformer, a diode rectifier, and an external resistor (R_{CS1}) to convert the current information to a voltage (V_x). This voltage is fed into the CS1 pin. The voltage (V_x) is calculated as follows:

$$V_x = I_x \times (N1/N2) \times R_{CS1}$$

where $N1/N2$ is the turns ratio of the current transformer.

The CS1 ADC outputs a digital code equal to $V_x/1.4 \times 4096$. The CS1 gain trim register (Register 0x21) is adjusted until the CS1 ADC value in Register 0x13[15:4] reads the correct digital code.

CS2 TRIM

The CS2 trim must compensate for offset and gain errors. The offset error requires both an analog trim and a digital trim. This error includes the mismatch of the level shifting resistors to the inputs of the CS2± differential amplifier and the tolerance of the current sense element.

CS2 Offset Trim

Offset errors can be introduced by the external level shifting resistors and the internal current sources. It is best to use two 0.1% matched resistors or matched resistors within the same package.

It is important to perform the CS2 offset trim as described in the following steps:

1. Set high-side or low-side current sensing using Register 0x27[2].
2. Set the nominal full-scale sense resistor voltage drop in Register 0x27[5] to 1 for the 120 mV range or to 0 for the 60 mV range.
3. Apply no-load current across the sense resistor.
4. Set the CS2 gain trim value to 0 (Register 0x23 = 0).
5. Set the CS2 digital offset trim value to 0 (Register 0x25 = 0).
6. Adjust the CS2 analog offset trim value in Register 0x24[6:0]. For the 120 mV range, adjust Register 0x24 until the CS2 value in Register 0x18[15:4] reads as close to 100 decimal (0x64) as possible; this value must be greater than 50 (0x32). For the 60 mV range, adjust Register 0x24 until the CS2 value in Register 0x18[15:4] reads as close to 200 decimal (0xC8) as possible; this value must be greater than 100 (0x64).
7. Adjust the CS2 digital offset trim value in Register 0x25 until the CS2 value in Register 0x18[15:4] reads 0.

The offset trim is now completed, and the ADC code reads 0 when there is a no-load current across the sense resistor.

CS2 Gain Trim

After performing the offset trim, perform the gain trim to remove any mismatch that is introduced by the sense resistor tolerance. The [ADP1046AW](#) can trim for sense resistors with a tolerance of 1% or better.

1. Apply a known load current (I_{OUT}) across the sense resistor.
2. Adjust the CS2 gain trim value in Register 0x23[5:0] until the CS2 value in Register 0x18[15:4] reads the value calculated by the following formula:

$$CS2 \text{ Value} = I_{OUT} \times R_{SENSE} / FS \times 4096$$

where:

FS is the full-scale voltage drop (120 mV or 60 mV).

R_{SENSE} is the sense resistor value.

If CS2 is programmed to the 120 mV range and $I_{OUT} = 10 \text{ A}$, $R_{SENSE} = 10 \text{ m}\Omega$, and $FS = 120 \text{ mV}$,

$$CS2 \text{ Value} = (10 \text{ A} \times 10 \text{ m}\Omega) / 120 \text{ mV} \times 4096$$

$$CS2 \text{ Value} = 3413 \text{ decimal}$$

If CS2 is programmed to the 60 mV range and $I_{OUT} = 5 \text{ A}$, $R_{SENSE} = 5 \text{ m}\Omega$, and $FS = 60 \text{ mV}$,

$$CS2 \text{ Value} = (5 \text{ A} \times 5 \text{ m}\Omega) / 60 \text{ mV} \times 4096$$

$$CS2 \text{ Value} = 1707 \text{ decimal}$$

The CS2 circuit is now trimmed. The OCP limits and settings should be configured after the current sense trim is performed.

VOLTAGE CALIBRATION AND TRIM

The voltage sense inputs are optimized for sensing signals at 1 V (the usable input range is 1.4 V). In a 12 V system, a 12:1 resistor divider is required to reduce the 12 V signal to below 1.4 V. It is recommended that the output voltage of the power supply be reduced to 1 V at this pin for best performance. The tolerance of the resistor divider introduces errors that need to be trimmed. The ADP1046AW has enough trim range to trim out errors introduced by resistors with a tolerance of 0.5% or better.

The VS1, VS2, and VS3 ADCs produce a digital code equal to $VSx/1.6 \times 4096$. The ADCs output a digital word of 2560 decimal (0xA00) in Bits[15:4] of Register 0x15, Register 0x16, and Register 0x17 when there is exactly 1 V at their inputs.

OUTPUT VOLTAGE SETTING (VS3+, VS3– TRIM)

The VS3± inputs require a gain trim. Set the output regulation point to 100% of the nominal value (Register 0x31 = 0xA0). Enable the power supply with no-load current. The power supply output voltage is divided down by the VS3 resistor divider to give 1 V across the VS3+ and VS3– differential input pins. The VS3 trim register (Register 0x3A) is adjusted until the output voltage is at the desired value. This step should be performed before any other trim routine. The VS3 voltage value in Register 0x17[15:4] reads 2560 decimal (0xA00).

VS1 TRIM

The VS1 input requires a gain trim. Enable the power supply with no-load current. It is recommended that the VS1 voltage be divided down by the VS1 resistor divider to give 1 V at the VS1 pin. The VS1 trim register (Register 0x38) is adjusted until the VS1 value in Register 0x15[15:4] reads 2560 decimal (0xA00).

VS2 TRIM

The VS2 input requires a gain trim. Enable the power supply with no-load current. It is recommended that the VS2 voltage be divided down by the VS2 resistor divider to give 1 V at the VS2 pin. The VS2 trim register (Register 0x39) is adjusted until the VS2 value in Register 0x16[15:4] reads 2560 decimal (0xA00).

RTD/OTP TRIM

The RTD input requires two trims: one for the current source and one for the ADC. To use the internal linearization scheme, additional trimming procedures are required.

Trimming the Current Source

Bits[7:6] of Register 0x11 set the value of the current source to 10 μ A, 20 μ A, 30 μ A, or 40 μ A. Bits[5:0] of Register 0x11 can be used to fine-tune the current value. By fine-tuning the internal current source, component tolerance can be compensated for and errors can be minimized. One LSB in Bits[5:0] = 160 nA. A decimal value of 1 adds 160 nA to the current source set by Bits[7:6]; a decimal value of 63 adds $63 \times 160 \text{ nA} = 10.08 \mu\text{A}$ to the current source set by Bits[7:6].

To program a value for the current source, select the nearest possible option (10 μ A, 20 μ A, 30 μ A, or 40 μ A) using Register 0x11[7:6]. Then use Register 0x11[5:0] to achieve the finer step size.

For example, to use a value of 46 μ A as the current source, follow these steps:

1. Place a known resistor (R_x) from RTD to AGND.
2. Set Register 0x11[7:6] to 11 (40 μ A).
3. Increase the value of Register 0x11[5:0] one LSB at a time until the voltage at the RTD pin is $V_{\text{RTD}} = 46 \mu\text{A} \times R_x$.

The current source is now calibrated and is set to the factory default value.

Trimming the ADC

Due to the nonlinear nature of the thermistor, two trimming options can be used.

Using the Internal Linearization Scheme

The first option uses the internal linearization scheme with 46 μ A RTD current, which provides an accurate reading in $^{\circ}\text{C}$ read in Register 0x1B in decimal format.

A 100 k Ω , 1% NTC thermistor with $\beta = 4250$, 1% (such as the NCP15WF104F03RC) in parallel with an external resistor of 16.5 k Ω , 1%, should be used with the ADP1046AW. With this NTC thermistor and resistor combination, the ADP1046AW default current source trim is set to 46 μ A to achieve the best possible accuracy over temperatures ranging from 85 $^{\circ}\text{C}$ to 125 $^{\circ}\text{C}$.

If an external microcontroller is used, the RTD ADC code in Register 0x1A can be fed into the microcontroller and a different linearization scheme can be implemented in terms of a best-fit polynomial for the selected NTC characteristics.

Using the OTP Value

The second option does not use the linearization scheme. Instead, the user programs an RTD current and sets the OTP threshold in millivolts. Due to the nonlinear nature of the NTC thermistor, it is best to use a resistor in parallel with the NTC thermistor to aid in the linearization of the voltage seen at the RTD pin.

This procedure trims out the errors/tolerances in the NTC thermistor and the external resistor. Calculation of the parallel resistor can be done by knowing the NTC resistance characteristic across various temperatures.

To use this procedure, the temperatures and equivalent resistances of the NTC thermistor and parallel resistor combination must be known.

In Figure 45, T2 is the OTP threshold that sets the OTP flag, and T1 is the temperature at which the OTP flag is cleared.



Figure 45. RTD Pin Voltage, ADC Code, and Temperature

The following procedure should be used:

1. Adjust the desired RTD current source, I_{RTD} , as described in the Trimming the Current Source section.
2. Set the temperature to the OTP threshold.
3. Adjust the offset trim registers (Register 0x1C and Register 0x20) until the reading in Register 0x1A is the same as V2 (in mV).
4. Set the OTP threshold (Register 0x2F) to the value of V2.
5. Set the temperature to the hysteresis point where the OTP flag is cleared.
6. Adjust the temperature gain trim register (Register 0x2B) until the correct voltage is seen in Register 0x1A.

The ADC is now trimmed and is linear between the two temperatures of interest.

This procedure achieves the most accurate OTP because it takes into account the part-to-part variations of the ADP1046AW and the tolerances of the thermistor being used.

ACSNS CALIBRATION AND TRIM

The ACSNS feedforward ADC (see Figure 19) is used for voltage line feedforward and cannot be trimmed by the user.

The ACSNS slow ADC requires a gain trim. Enable the power supply with full load current at the nominal input voltage. The secondary peak reverse voltage on the output rectifiers is filtered by an external RCD circuit (see Figure 19).

To trim the ACSNS ADC, the user can reverse-calculate the primary voltage as follows:

$$V_{PRIMARY} = V_X \times (R1 + R2)/R2 \times (N1/N2)$$

where:

V_X is the voltage at the ACSNS pin.

$N1/N2$ is the turns ratio.

The ACSNS gain trim register (Register 0x5E) is adjusted until this calculated voltage is equal to the desired primary input voltage.

Another way to trim the ACSNS ADC uses the average secondary voltage. With known values for the nominal input voltage, transformer turns ratio, and resistor dividers at the ACSNS pin, the ACSNS gain trim register (Register 0x5E) is adjusted to give code 2560 decimal (0xA00).

$$ADC\ Code = V_X / 1.6 \times 4096$$

where V_X is the voltage at the ACSNS pin.

The resistors in Figure 19 are sized such that the first time constant, RC , is long enough to prevent overcharging of the capacitor (roughly 200 ns in a typical application), whereas the second time constant, $(R1 + R2) \times C$, is long enough to keep the average voltage constant during the rectifier off time.

LAYOUT GUIDELINES

This section explains best practices that should be followed to ensure optimal performance of the [ADP1046AW](#). In general, place all components as close to the [ADP1046AW](#) as possible. All signals should be referenced to their respective grounds.

CS2+ AND CS2-

Route the traces from the sense resistor to the [ADP1046AW](#) parallel to each other. Keep the traces close together and as far from the switch nodes as possible.

VS3+ AND VS3-

Route the traces from the remote voltage sense point to the [ADP1046AW](#) parallel to each other. Keep the traces close together and as far from the switch nodes as possible. Place a 100 nF capacitor from VS3- to AGND to reduce common-mode noise.

VDD

Place the decoupling capacitors as close to the part as possible. A 4.7 μ F capacitor from VDD to AGND is recommended.

SDA AND SCL

Route the traces to these pins parallel to each other. Keep the traces close together and as far from the switch nodes as possible.

CS1

Route the traces from the current sense transformer to the [ADP1046AW](#) parallel to each other. Keep the traces close together and as far from the switch nodes as possible.

EXPOSED PAD

Solder the exposed pad underneath the [ADP1046AW](#) to the PCB AGND plane.

VCORE

Place a 330 nF decoupling capacitor from this pin to DGND as close to the part as possible.

RES

Place a 10 k Ω , \pm 0.1% resistor from this pin to AGND as close to the part as possible.

RTD

Route a single trace to the [ADP1046AW](#) from the thermistor using a dedicated trace to AGND. Place the thermistor close to the hottest part of the power supply.

AGND, DGND, AND PGND

Create an AGND ground plane and make a single-point (star) connection to the power supply system ground. Connect DGND to AGND with a very short trace using a star connection. Connect PGND to AGND using a star connection.

I²C INTERFACE COMMUNICATION

The [ADP1046AW](#) I²C slave is a 2-wire interface that can be used to communicate with other I²C-compliant master devices and is compatible in a multimaster, multislave bus configuration.

The function of the I²C slave is to decode the command sent from the master device and respond as requested. Communication is established using a 2-wire interface with a clock line (SCL) and data line (SDA). The I²C slave is designed to externally move chunks of 8-bit data (bytes) while maintaining compliance with the I²C protocol, based on the Philips *I²C Bus Specification*, Version 2.1, dated January 2000. The I²C protocol incorporates the following features:

- Slave operation on multiple device systems
- 7-bit addressing
- 100 kB/sec and 400 kB/sec data rates
- General call address support
- Support for clock low extension (clock stretching)
- Separate multiple byte receive and transmit FIFO
- Extensive communication fault monitoring

I²C OVERVIEW

The I²C slave module is a 2-wire interface that can be used to communicate with other I²C-compliant master devices. Its transfer protocol is based on the I²C transfer mechanism. The [ADP1046AW](#) is always configured as a slave device in the overall system. The [ADP1046AW](#) communicates with the master device using one data pin (SDA) and one clock pin (SCL). Because the [ADP1046AW](#) is a slave device, it cannot generate the clock signal. However, it is capable of stretching the SCL line to place the master device in a wait state when it is not ready to respond to the master's request.

Communication is initiated when the master device sends a command to the I²C slave device. Commands can be read or write commands, in which case data is transferred between the devices in a byte-wide format. Commands can also be send commands, in which case the command is executed by the slave device upon receiving the stop bit. The stop bit is the last bit in a complete data transfer, as defined in the I²C communication protocol. During communication, the master and slave devices send acknowledge (A) or no acknowledge (NA) bits as a method of handshaking between devices. Refer to the Philips *I²C Bus Specification*, Version 2.1, dated January 2000, for a more detailed description of the communication protocol.

I²C ADDRESS

The I²C address of the [ADP1046AW](#) is set by connecting an external resistor from the ADD pin to AGND. Table 6 lists the recommended resistor values and the associated I²C addresses. Seven different addresses can be used.

The recommended resistor values in Table 6 must be 1% tolerance resistors.

Table 6. Recommended Resistor Values for I²C Addresses

I ² C Address	Resistor Value (k Ω)
0x50	10 (or connect the ADD pin directly to AGND)
0x51	28.7
0x52	48.7
0x53	68.1
0x54	88.7
0x55	109
0x57	200 (or connect the ADD pin directly to VDD)

DATA TRANSFER

Format Overview

The I²C slave follows the transfer protocol of the Philips *I²C Bus Specification*. Data transfers are byte-wide, lower byte first. Each byte is transmitted serially, most significant bit (MSB) first. A typical transfer is shown in Figure 46.



Figure 46. Basic Data Transfer

Figure 46 to Figure 53 use the following abbreviations:

- S = start condition
- Sr = repeated start condition
- P = stop condition
- R = read bit
- \bar{W} = write bit
- A = acknowledge bit (0)
- NA = no acknowledge bit (1)

Refer to the I²C specification for an in-depth discussion of the transfer protocols.

Command Overview

Data transfer using the I²C slave is established using commands. All commands start with a slave address with the R/W bit cleared (set to 0), followed by the command code (register address). All commands supported by the ADP1046AW follow one of the protocol types shown in Figure 47 to Figure 53.



Figure 47. Send Byte Protocol



Figure 48. Write Byte Protocol



Figure 49. Write Word Protocol



Figure 50. Read Byte Protocol



Figure 51. Read Word Protocol

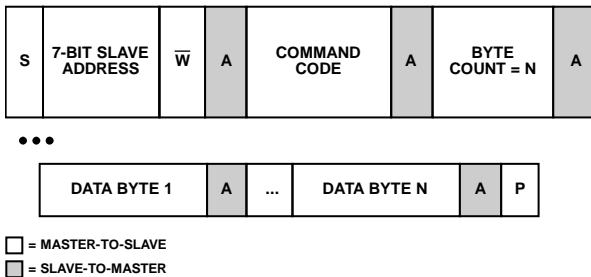

Figure 52. Block Write Protocol

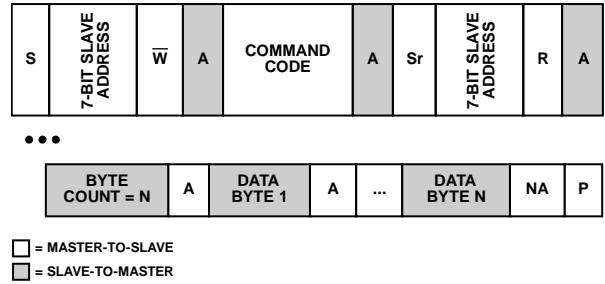

Figure 53. Block Read Protocol

Clock Generation and Stretching

The ADP1046AW is always a slave in the overall system; therefore, the device never needs to generate the clock, which is done by the master device in the system. However, the I²C slave device is capable of clock stretching to place the master in a wait state. By stretching the SCL signal during the low period, the slave device communicates to the master device that it is not ready and that the master device must wait.

Conditions where the I²C slave device stretches the SCL line low include the following:

- The master device is transmitting at a higher baud rate than the slave device.
- The receive FIFO buffer of the slave device is full and must be read before continuing. This prevents a data overflow condition.
- The slave device is not ready to send data that the master has requested.

Note that the slave device can stretch the SCL line only during the low period. Also, whereas the I²C specification allows indefinite stretching of the SCL line, the ADP1046AW limits the maximum time that the SCL line can be stretched, or held low. For more information about the maximum time, see the Timeout Condition section.

Start and Stop Conditions

Start and stop conditions involve serial data transitions while the serial clock is at a logic high level. The I²C slave device monitors the SDA and SCL lines to detect the start and stop conditions and transition its internal state machine accordingly. Typical start and stop conditions are shown in Figure 54.

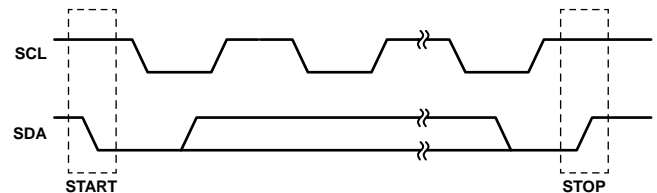

Figure 54. Start and Stop Transitions

GENERAL CALL SUPPORT

The [ADP1046AW](#) is capable of decoding and acknowledging a general call address. The general call address is supported for send, write, and read commands that use Address 0x00 as the slave address. The I²C slave responds to both its own address and to the general call address (0x00).

Note that all commands start with a slave address with the $\overline{R/W}$ bit cleared (set to 0), followed by the command code. This is also true when using the general call address to communicate with the I²C slave device.

10-BIT ADDRESSING

The [ADP1046AW](#) does not support 10-bit addressing as defined in the I²C specification.

FAST MODE

Fast mode (400 kB/sec) uses essentially the same mechanics as the standard mode of operation; the electrical specifications and timing are most affected. The I²C slave is capable of communicating with a master device operating in standard mode (100 kB/sec) or fast mode.

REPEATED START CONDITION

In general, a repeated start condition is the absence of a stop condition between two transfers. The two transfers can be of any direction type, for example, a transmit followed by a receive or a receive followed by a transmit. However, the [ADP1046AW](#) I²C communication protocol uses the repeated start condition only when performing a read access (read byte, read word, and block read). Other uses of the repeated start condition are not allowed.

ELECTRICAL SPECIFICATIONS

All logic complies with the electrical specifications outlined in the Philips *I²C Bus Specification*, Version 2.1, dated January 2000.

FAULT CONDITIONS

The I²C protocol provides a very comprehensive set of fault conditions that are monitored during communication. These communication faults are error conditions associated with the data transfer mechanism of the I²C protocol and are explained in the following sections.

TIMEOUT CONDITION

A timeout condition occurs if any single SCL clock pulse is held low for longer than the $t_{\text{TIMEOUT, MIN}}$ of 25 ms. Upon detecting the timeout condition, the I²C slave device has 10 ms to abort the transfer, release the bus lines, and be ready to accept a new start condition. The device initiating the timeout is required to hold the SCL clock line low for a minimum of $t_{\text{TIMEOUT, MAX}} = 35$ ms, guaranteeing that the slave device is given enough time to reset its communication protocol.

DATA TRANSMISSION FAULTS

Data transmission faults occur when two communicating devices violate the I²C communication protocol.

Sending Too Few Bits

Transmission is interrupted by a start or stop condition before a complete byte (eight bits) has been sent. Not supported; any transmitted data is ignored.

Reading Too Few Bits

Transmission is interrupted by a start or stop condition before a complete byte (eight bits) has been read. Not supported; any received data is ignored.

Host Sends or Reads Too Few Bytes

If a host ends a packet with a stop condition before the required bytes are sent/received, it is assumed that the host intended to stop the transfer. Therefore, the I²C slave does not consider this to be an error and takes no action, except to flush any remaining bytes in the transmit FIFO.

Host Sends Too Many Bytes

If a host sends more bytes than are expected for the corresponding command, the I²C slave considers this a data transmission fault and responds as follows:

- Issues a no acknowledge for all unexpected bytes as they are received
- Flushes and ignores the received command and data

Host Reads Too Many Bytes

If a host reads more bytes than are expected for the corresponding command, the I²C slave considers this a data transmission fault and sends all 1s (0xFF) as long as the host continues to request data.

Device Busy

The I²C slave device is too busy to respond to a request from the master device. Typically SCL clock stretching is involved until the device is free to communicate.

DATA CONTENT FAULTS

Data content faults occur when data transmission is successful, but the I²C slave device cannot process the data that is received from the master device.

Improperly Set Read Bit in the Address Byte

All I²C commands start with a slave address with the $\overline{R/W}$ bit cleared (set to 0), followed by the command code. If a host starts an I²C transaction with $\overline{R/W}$ set in the address phase (equivalent to an I²C read), the I²C slave considers this a data content fault and responds as follows:

- Acknowledges the address byte
- Issues a no acknowledge for the command and data bytes
- Sends all 1s (0xFF) as long as the host continues to request data

Invalid or Unsupported Command Code

If an invalid or unsupported command code is sent to the I²C slave, the I²C slave considers this a data content fault and responds as follows:

- Issues a no acknowledge for the illegal/unsupported command byte and data bytes
- Flushes and ignores the received command and data

Reserved Bits

Accesses to reserved bits are not a fault. Writes to reserved bits are ignored, and reads from reserved bits return undefined data.

Write to Read-Only Commands

If a host performs a write to a read-only command, the I²C slave considers this a data content fault and responds as follows:

- Issues a no acknowledge for all unexpected data bytes as they are received
- Flushes and ignores the received command and data

Note that this is the same error described in the Host Sends Too Many Bytes section.

Read from Write-Only Commands

If a host performs a read from a write-only command, the I²C slave considers this a data content fault and send all 1s (0xFF) as long as the host continues to request data.

Note that this is the same error described in the Host Reads Too Many Bytes section.

EEPROM

The [ADP1046AW](#) has a built-in EEPROM controller that is used to communicate with the embedded 8K × 8-byte EEPROM. The EEPROM, also called Flash®/EE, is partitioned into two major blocks: the INFO block and the main block. The INFO block contains 128 8-bit bytes (for internal use only), and the main block contains 8K 8-bit bytes. The main block is further partitioned into 16 pages, each page containing 512 bytes.

EEPROM OVERVIEW

The EEPROM controller provides an interface between the [ADP1046AW](#) core logic and the built-in Flash/EE. The user can control data access to and from the EEPROM through this controller interface. Different I²C commands are available for the different operations to the EEPROM.

Communication is initiated by the master device sending a command to the I²C slave device to access data from or send data to the EEPROM. Using read and write commands, data is transferred between devices in a byte-wide format. Using a read command, data is received from the EEPROM and transmitted to the master device. Using a write command, data is received from the master device and stored in the EEPROM through the EEPROM controller. Send commands are also supported, in which case the command is executed by the slave device upon receiving the stop bit. The stop bit is the last bit in a complete data transfer, as defined in the I²C communication protocol.

For a complete description of the I²C protocol, see the Philips *I²C Bus Specification*, Version 2.1, dated January 2000.

PAGE ERASE OPERATION

The main block consists of 16 equivalent pages of 512 bytes each, numbered Page 0 to Page 15. Page 0 and Page 1 of the main block are reserved for storing the default settings and user settings, respectively. The user cannot perform a page erase operation on Page 0 or Page 1. Page 2 and Page 3 are reserved for internal use; do not erase the contents of Page 2 or Page 3.

Only Page 4 to Page 15 of the main block should be used to store data. To erase any page from Page 4 to Page 15, the EEPROM must first be unlocked for access. For instructions on how to unlock the EEPROM, see the Unlock the EEPROM section.

Page 4 to Page 15 of the main block can be individually erased using the EEPROM_PAGE_ERASE command (Register 0x87).

For example, to perform a page erase of Page 10, execute the following command:



Figure 55. Example Erase Command

In this example, command code = 0x87 and data byte = 0x0A.

Note that it is necessary to wait at least 35 ms for the page erase operation to complete before executing the next I²C command.

The EEPROM allows erasing of whole pages only; therefore, to change the data of any single byte in a page, the entire page must first be erased (set high) for that byte to be writable. Subsequent writes to any bytes in that page are allowed as long as that byte has not been written to a logic low previously.

READ OPERATION (BYTE READ AND BLOCK READ)

Read from Main Block, Page 0 and Page 1

Page 0 and Page 1 of the main block are reserved for storing the default settings and user settings, respectively, and are intended to prevent third-party access to this data. To read from Page 0 or Page 1, the user must first unlock the EEPROM (see the Unlock the EEPROM section). After the EEPROM is unlocked, Page 0 and Page 1 are readable using the EEPROM_DATA_xx commands, as described in the Read from Main Block, Page 2 to Page 15 section. Note that when the EEPROM is locked, a read from Page 0 or Page 1 returns invalid data.

Read from Main Block, Page 2 to Page 15

Data in Page 2 to Page 15 of the main block is always readable, even with the EEPROM locked. The data in the EEPROM main block can be read one byte at a time or in multiple bytes in series using the EEPROM_DATA_xx commands (Register 0x8B to Register 0x9A).

Before executing this command, the user must program the number of bytes to read using the EEPROM_NUM_RD_BYTES command (Register 0x86). The user can also program the offset from the page boundary where the first read byte is returned using the EEPROM_ADDR_OFFSET command (Register 0x85).

In the following example, three bytes from Page 4 are read from the EEPROM, starting from the fifth byte of that page.

1. Set the number of return bytes = 3.



2. Set address offset = 5.

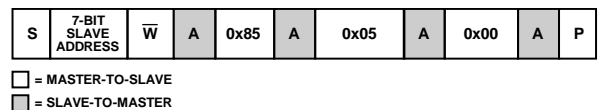

3. Read three bytes from Page 4.

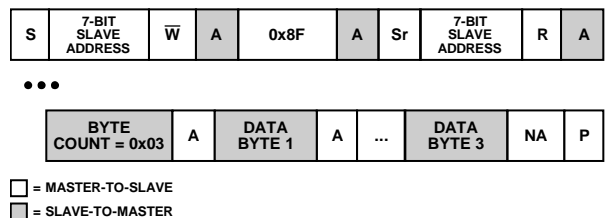

Note that the block read command can read a maximum of 256 bytes for any single transaction (set the number of return bytes = 0).

WRITE OPERATION (BYTE WRITE AND BLOCK WRITE)

Write to Main Block, Page 0 and Page 1

Page 0 and Page 1 of the main block are reserved for storing the default settings and user settings, respectively. The user cannot perform a direct write operation to Page 0 or Page 1 using the EEPROM_DATA_00 and EEPROM_DATA_01 commands. A user write to Page 0 or Page 1 returns a no acknowledge. To program the register contents of Page 1 of the main block, it is recommended that the STORE_USER_ALL command be used (Register 0x82). See the Save Register Settings to User Settings section.

Write to Main Block, Page 2 and Page 3

Page 2 and Page 3 of the main block are reserved for internal use and their contents should not be written to. Only Page 4 to Page 15 should be used to store data.

Write to Main Block, Page 4 to Page 15

Before performing a write to Page 4 through Page 15 of the main block, the user must first unlock the EEPROM (see the Unlock the EEPROM section).

Data in Page 4 to Page 15 of the EEPROM main block can be programmed (written to) one byte at a time or in multiple bytes in series using the EEPROM_DATA_xx commands (Register 0x8B to Register 0x9A). Before executing this command, the user can program the offset from the page boundary where the first byte is written using the EEPROM_ADDR_OFFSET command (Register 0x85).

If the targeted page has not yet been erased, the user can erase the page as described in the Page Erase Operation section.

In the following example, four bytes are written to Page 9, starting from the 256th byte of that page.

1. Set address offset = 256.

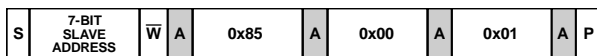

= MASTER-TO-SLAVE
 = SLAVE-TO-MASTER

11742-059

2. Write four bytes to Page 9.

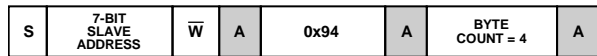

•••



= MASTER-TO-SLAVE
 = SLAVE-TO-MASTER

11742-060

Note that the block write command can write a maximum of 256 bytes for any single transaction (set the byte count = 0).

EEPROM PASSWORD

On power-up, the EEPROM is locked and protected from accidental writes or erases. Only reads from Page 2 to Page 15 of the main block are allowed when the EEPROM is locked. Before any data can be written (programmed) to the EEPROM, the EEPROM must be unlocked for write access. After it is unlocked, the EEPROM is opened for reading, writing, and erasing.

Unlock the EEPROM

To unlock the EEPROM, perform two consecutive writes with the correct password (default = 0xFF) using the EEPROM_PASSWORD command (Register 0x88). The EEPROM unlocked flag (Bit 0 of Register 0x03) is set to indicate that the EEPROM is unlocked for write access.

Lock the EEPROM

To lock the EEPROM, write any byte other than the correct password using the EEPROM_PASSWORD command (Register 0x88). The EEPROM unlocked flag (Bit 0 of Register 0x03) is cleared to indicate that the EEPROM is locked from write access.

Change the EEPROM Password

To change the EEPROM password, first write the correct password using the EEPROM_PASSWORD command (Register 0x88). Immediately write the new password using the same command. The password is now changed to the new password.

DOWNLOADING EEPROM SETTINGS TO INTERNAL REGISTERS

Download User Settings to Registers

The user settings are stored in Page 1 of the EEPROM main block. These settings are downloaded from the EEPROM into the registers under the following conditions:

- On power-up. The user settings are automatically downloaded into the internal registers, powering the part up in a state previously saved by the user.
- On execution of the RESTORE_USER_ALL command (Register 0x83). This command allows the user to force a download of the user settings from Page 1 of the EEPROM main block into the internal registers.

Download Factory Default Settings to Registers

The factory default settings are stored in Page 0 of the EEPROM main block. The factory default settings can be downloaded from the EEPROM into the internal registers using the RESTORE_DEFAULT_ALL command (Register 0x81).

When this command is executed, the EEPROM password is also reset to the factory default setting of 0xFF.

SAVING REGISTER SETTINGS TO THE EEPROM

The register settings cannot be saved to the factory default settings located in Page 0 of the EEPROM main block. This is to prevent the user from accidentally overriding the factory trim settings and default register settings.

Save Register Settings to User Settings

The register settings can be saved to the user settings located in Page 1 of the EEPROM main block using the STORE_USER_ALL command (Register 0x82). Before this command can be executed, the EEPROM must first be unlocked for writing (see the Unlock the EEPROM section).

After the register settings are saved to the user settings, any subsequent power cycle automatically downloads the latest stored user information from the EEPROM into the internal registers.

Note that execution of the STORE_USER_ALL command automatically performs a page erase to Page 1 of the EEPROM main block, after which the register settings are stored in the EEPROM. Therefore, it is important to wait at least 40 ms for the operation to complete before executing the next I²C command.

EEPROM CRC CHECKSUM

As a simple method of checking that the values downloaded from the EEPROM are consistent with the internal registers, a CRC checksum is implemented.

- When the data from the internal registers is saved to the EEPROM (Page 1 of the main block), the total number of 1s from all the registers is counted and written into the EEPROM as the last byte of information. This is called the CRC checksum.
- When the data is downloaded from the EEPROM into the internal registers, a similar counter that sums all 1s from the values loaded into the registers is saved. This value is compared with the CRC checksum from the previous upload operation.

If the values match, the download operation was successful. If the values differ, the EEPROM download operation failed, and the EEPROM CRC fault flag is set (Bit 1 of Register 0x03).

To read the EEPROM CRC checksum value, execute the EEPROM_CRC_CHKSUM command (Register 0x84). This command returns the CRC checksum accumulated in the counter during the download operation.

Note that the CRC checksum is an 8-bit cyclical accumulator that wraps around to 0 when 255 is reached.

SOFTWARE GUI

A free software GUI is available for programming and configuring the [ADP1046AW](#). The GUI is designed to be intuitive to power supply designers and dramatically reduces power supply design and development time. The software includes filter design and power supply PWM topology windows.

The GUI is also an information center, displaying the status of all readings, monitoring, and flags on the [ADP1046AW](#).

For more information about the GUI, contact Analog Devices for the latest software and a user guide. Evaluation boards are also available by contacting Analog Devices.

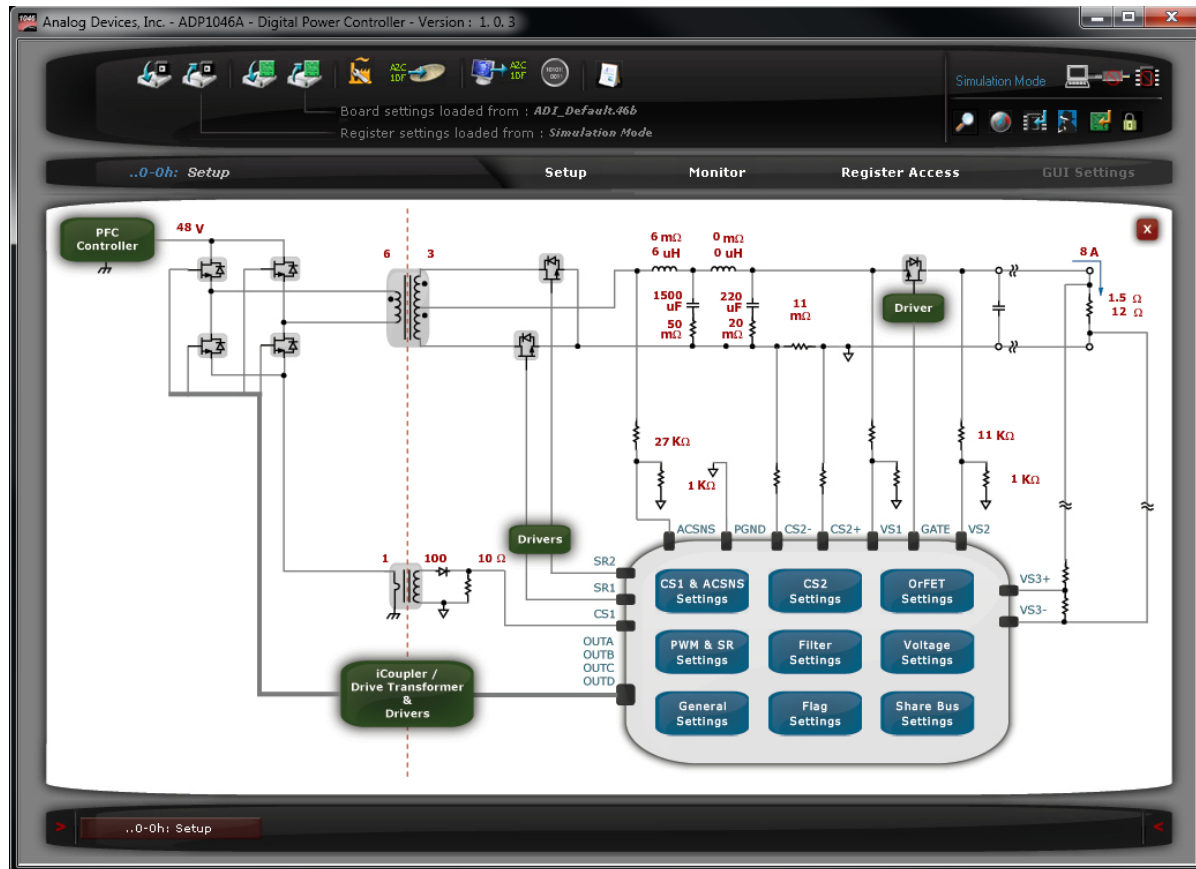

Figure 56. ADP1046AW GUI

11742-081

REGISTER LISTING

Table 7. Register List

Address	Register Name
Fault Registers	
0x00	Fault Register 1
0x01	Fault Register 2
0x02	Fault Register 3
0x03	Fault Register 4
0x04	Latched Fault Register 1
0x05	Latched Fault Register 2
0x06	Latched Fault Register 3
0x07	Latched Fault Register 4
0x08	Fault Configuration Register 1
0x09	Fault Configuration Register 2
0x0A	Fault Configuration Register 3
0x0B	Fault Configuration Register 4
0x0C	Fault Configuration Register 5
0x0D	Fault Configuration Register 6
0x0E	Flag configuration
0x0F	Soft start blank fault flags
Value Registers	
0x10	First flag ID
0x11	RTD current source
0x12	HF ADC reading
0x13	CS1 value (input current)
0x14	ACSNS value
0x15	VS1 voltage value
0x16	VS2 voltage value
0x17	VS3 voltage value (output voltage)
0x18	CS2 value (output current)
0x19	CS2 × VS3 value (output power)
0x1A	RTD temperature value
0x1B	Read temperature
0x1C	RTD offset trim (MSB)
0x1D	Share bus value
0x1E	Modulation value
0x1F	Line impedance value
0x20	RTD offset trim (LSBs)
Current Sense and Current Limit Registers	
0x21	CS1 gain trim
0x22	CS1 accurate OCP limit
0x23	CS2 gain trim
0x24	CS2 analog offset trim
0x25	CS2 digital offset trim
0x26	CS2 accurate OCP limit
0x27	CS1/CS2 fast OCP settings
0x28	Volt-second balance settings
0x29	Share bus bandwidth
0x2A	Share bus setting
0x2B	Temperature gain trim
0x2C	PSON/soft start
0x2D	PGOOD debounce and pin polarity settings
0x2E	Modulation limit
0x2F	OTP threshold
0x30	OrFET

Address	Register Name
Voltage Sense Registers	
0x31	VS3 voltage setting (remote voltage)
0x32	VS1 overvoltage limit (OVP)
0x33	VS2 and VS3 overvoltage limit (OVP)
0x34	VS1 undervoltage limit (UVP)
0x35	Line impedance limit
0x36	Load line impedance
0x37	Fast OVP comparator
0x38	VS1 trim
0x39	VS2 trim
0x3A	VS3 trim
0x3B	Light load mode disable settings
ID Registers	
0x3C	Silicon revision ID
0x3D	Manufacturer ID
0x3E	Device ID
PWM and Synchronous Rectification Timing Registers	
0x3F	OUTAUX switching frequency setting
0x40	PWM switching frequency setting
0x41	OUTA rising edge timing (OUTA pin)
0x42	OUTA rising edge setting (OUTA pin)
0x43	OUTA falling edge timing (OUTA pin)
0x44	OUTA falling edge setting (OUTA pin)
0x45	OUTB rising edge timing (OUTB pin)
0x46	OUTB rising edge setting (OUTB pin)
0x47	OUTB falling edge timing (OUTB pin)
0x48	OUTB falling edge setting (OUTB pin)
0x49	OUTC rising edge timing (OUTC pin)
0x4A	OUTC rising edge setting (OUTC pin)
0x4B	OUTC falling edge timing (OUTC pin)
0x4C	OUTC falling edge setting (OUTC pin)
0x4D	OUTD rising edge timing (OUTD pin)
0x4E	OUTD rising edge setting (OUTD pin)
0x4F	OUTD falling edge timing (OUTD pin)
0x50	OUTD falling edge setting (OUTD pin)
0x51	SR1 rising edge timing (SR1 pin)
0x52	SR1 rising edge setting (SR1 pin)
0x53	SR1 falling edge timing (SR1 pin)
0x54	SR1 falling edge setting (SR1 pin)
0x55	SR2 rising edge timing (SR2 pin)
0x56	SR2 rising edge setting (SR2 pin)
0x57	SR2 falling edge timing (SR2 pin)
0x58	SR2 falling edge setting (SR2 pin)
0x59	OUTAUX rising edge timing (OUTAUX pin)
0x5A	OUTAUX rising edge setting (OUTAUX pin)
0x5B	OUTAUX falling edge timing (OUTAUX pin)
0x5C	OUTAUX falling edge setting (OUTAUX pin)
0x5D	OUTx and SRx pin disable settings
0x5E	ACSNS gain trim
Digital Filter Programming Registers	
0x5F	Soft start and output voltage slew rate settings
0x60	Normal mode digital filter LF gain setting
0x61	Normal mode digital filter zero setting
0x62	Normal mode digital filter pole setting
0x63	Normal mode digital filter HF gain setting
0x64	Light load mode digital filter LF gain setting

Address	Register Name
0x65	Light load mode digital filter zero setting
0x66	Light load mode digital filter pole setting
0x67	Light load mode digital filter HF gain setting
0x68	Reserved
Soft Start Filter Programming Registers	
0x71	Soft start digital filter LF gain setting
0x72	Soft start digital filter zero setting
0x73	Soft start digital filter pole setting
0x74	Soft start digital filter HF gain setting
Extended Functions Registers	
0x75	Voltage line feedforward
0x76	Volt-second balance settings (OUTA and OUTB pins)
0x77	Volt-second balance settings (OUTC and OUTD pins)
0x78	Volt-second balance settings (SR1 and SR2 pins)
0x79	SR delay compensation
0x7A	Filter transitions
0x7B	PGOOD1 flag masking
0x7C	PGOOD2 flag masking
0x7D	Light load mode threshold settings
0x7E	Reserved
0x7F	GO byte
0x80	Reserved
EEPROM Registers	
0x81	RESTORE_DEFAULT_ALL
0x82	STORE_USER_ALL
0x83	RESTORE_USER_ALL
0x84	EEPROM_CRC_CHKSUM
0x85	EEPROM_ADDR_OFFSET
0x86	EEPROM_NUM_RD_BYTES
0x87	EEPROM_PAGE_ERASE
0x88	EEPROM_PASSWORD
0x89	TRIM_PASSWORD
0x8A	EEPROM_INFO
0x8B	EEPROM_DATA_00
0x8C	EEPROM_DATA_01
0x8D	EEPROM_DATA_02
0x8E	EEPROM_DATA_03
0x8F	EEPROM_DATA_04
0x90	EEPROM_DATA_05
0x91	EEPROM_DATA_06
0x92	EEPROM_DATA_07
0x93	EEPROM_DATA_08
0x94	EEPROM_DATA_09
0x95	EEPROM_DATA_10
0x96	EEPROM_DATA_11
0x97	EEPROM_DATA_12
0x98	EEPROM_DATA_13
0x99	EEPROM_DATA_14
0x9A	EEPROM_DATA_15

DETAILED REGISTER DESCRIPTIONS

FAULT REGISTERS

Register 0x04 to Register 0x07 are latched fault registers. In these registers, flags are not reset when the fault disappears. Flags are cleared only by a register read (provided that the fault no longer persists). Note that latched bits are clocked on a low-to-high transition only. Also note that these register bits are cleared when read via the I²C interface unless the fault is still present. It is recommended that the latched fault register be read again after the faults disappear to ensure that the register is reset.

Table 8. Register 0x00—Fault Register 1 and Register 0x04—Latched Fault Register 1 (1 = Fault, 0 = Normal Operation)

Bits	Bit Name	R/W	Description	Register	Action
7	Power supply	R	1 = power supply is off. All PWM outputs are disabled. This bit stays high until the power supply is restarted.		None
6	OrFET	R	1 = OrFET control signal at the GATE pin (Pin 16) is off.	0x30	
5	PGOOD1 fault	R	1 = Power-Good 1 fault. At least one of the following flags has been set: soft start flag, CS1 fast OCP, CS1 accurate OCP, CS2 accurate OCP, UVP, local OVP, load OVP, or OrFET (GATE pin). These flags can be masked using Register 0x7B.	0x2D	None
4	PGOOD2 fault	R	1 = Power-Good 2 fault. At least one of the following flags has been set: soft start flag, CS1 fast OCP, CS1 accurate OCP, CS2 accurate OCP, UVP, local OVP, load OVP, or OrFET (GATE pin). These flags can be masked using Register 0x7C. The following flags can also set PGOOD2, either unconditionally or based on the flag response, as defined in Register 0x2D[3] (see Table 45): voltage continuity, OrFET disable, ACSNS, external flag (FLAGIN pin), and OTP.	0x2D	None
3	SR off	R	SR1 and SR2 synchronous rectifiers are disabled. This flag is set when one of the following cases is true: SR1 and SR2 are disabled by the user. The load current has fallen below the threshold in Register 0x3B. A flag has been set that is configured to disable the synchronous rectifiers.	0x5D 0x3B 0x08 to 0x0D	None
2	CS1 fast OCP	R	CS1 current is above its fast overcurrent protection limit. There is a 1.2 V threshold on the CS1 pin. Fast OCP is a comparator.		Programmable
1	CS1 accurate OCP	R	CS1 current is above its accurate overcurrent protection limit.	0x22	Programmable
0	CS2 accurate OCP	R	CS2 current is above its accurate overcurrent protection limit.	0x26	Programmable

Table 9. Register 0x01—Fault Register 2 and Register 0x05—Latched Fault Register 2 (1 = Fault, 0 = Normal Operation)

Bits	Bit Name	R/W	Description	Register	Action
7	Voltage continuity	R	Voltage differential between VS1 and VS2 pins or between VS2 and VS3± pins is outside limits. Either (VS1 – VS2) > 50 mV or (VS2 – VS3) > 50 mV at the pins.		Programmable
6	UVP	R	VS1 is below its undervoltage limit.	0x34	Programmable
5	CS2 reverse current	R	Reverse voltage across the CS2± pins is above limit. This is the OrFET reverse voltage.	0x30	Programmable
4	VDD UV	R	VDD is below limit.		Immediate shutdown
3	VCORE OV	R	2.5 V VCORE is above limit.		Immediate shutdown
2	VDD OV	R	VDD is above limit. The I ² C interface stays functional, but a PSON toggle is required to restart the power supply.	0x0E	Programmable
1	Load OVP	R	VS2 or VS3± is above its overvoltage limit.	0x33	Programmable
0	Local OVP	R	VS1 is above its overvoltage limit.	0x32	Programmable

Table 10. Register 0x02—Fault Register 3 and Register 0x06—Latched Fault Register 3 (1 = Fault, 0 = Normal Operation)

Bits	Bit Name	R/W	Description	Register	Action
7	OTP	R	Temperature is above OTP limit.	0x2F	Programmable
6	Fast OVP	R	Fast OVP threshold was exceeded.	0x37	Programmable
5	Share bus	R	Current share is outside regulation limit.	0x2A	Programmable
4	Constant current	R	Power supply is operating in constant current mode (constant current mode is enabled).	0x27	None
3	Soft start	R	The reference is being ramped.		None
2	Line impedance	R	Line impedance between VS2 and VS3± is above limit.	0x35	None
1	Soft start filter	R	The soft start filter is in use.	0x5F	None
0	External flag	R	The external flag pin (FLAGIN) is set.		Programmable

Table 11. Register 0x03—Fault Register 4 and Register 0x07—Latched Fault Register 4 (1 = Fault, 0 = Normal Operation)

Bits	Bit Name	R/W	Description	Register	Action
7	Volt-second balance	R	Volt-second balance is at its maximum or minimum limit.		None
6	Modulation	R	Modulation is at its maximum or minimum limit.	0x2E	None
5	Reserved	R	Reserved.		None
4	Light load mode	R	The system is in light load mode.	0x3B	None
3	Reserved	R	Reserved.		None
2	ACSNS	R	The ac sense (comparator) amplitude is not correct.		Programmable
1	CRC fault	R	The EEPROM contents downloaded are incorrect.		Immediate shutdown
0	EEPROM unlocked	R	The EEPROM is unlocked.		None

Table 12. Register 0x08 to Register 0x0D—Fault Configuration Registers

Register Name	Address	Bits	Flag	Shutdown Debounce
Fault Configuration Register 1	0x08	[7:4] [3:0]	CS1 fast OCP CS1 accurate OCP	See Register 0x27 in Table 39 See Register 0x0E in Table 14
Fault Configuration Register 2	0x09	[7:4] [3:0]	CS2 accurate OCP Load OVP (VS2 or VS3)	See Register 0x0E in Table 14 2 ms
Fault Configuration Register 3	0x0A	[7:4] [3:0]	Local accurate OVP (VS1) and fast OVP (VS1) External flag input (FLAGIN)	2 ms (see Register 0x37 in Table 55) 10 ms
Fault Configuration Register 4	0x0B	[7:4] [3:0]	OTP UVP	100 ms 10 ms
Fault Configuration Register 5	0x0C	[7:4] [3:0]	CS2 reverse voltage Voltage continuity	10 ms 100 ms
Fault Configuration Register 6	0x0D	[7:4] [3:0]	Share bus ACSNS	100 ms 10 ms

Register 0x08 to Register 0x0D allow the user to program the response when each flag is set.

Table 13. Register 0x08 to Register 0x0D—Fault Configuration Register Bit Descriptions

Bits	Bit Name	R/W	Description																																				
7	Timing	R/W	This bit specifies when the flag is set. 0 = after debounce. 1 = immediately.																																				
[6:4]	Action	R/W	These bits specify the action that the part takes in response to the flag.																																				
			<table border="1"> <thead> <tr> <th>Bit 6</th> <th>Bit 5</th> <th>Bit 4</th> <th>Action</th> </tr> </thead> <tbody> <tr> <td>0</td> <td>0</td> <td>0</td> <td>Ignore flag completely</td> </tr> <tr> <td>0</td> <td>0</td> <td>1</td> <td>Disable SR1 and SR2</td> </tr> <tr> <td>0</td> <td>1</td> <td>0</td> <td>Disable OrFET</td> </tr> <tr> <td>0</td> <td>1</td> <td>1</td> <td>Disable the power supply and reenable it after the power supply reenable time set in Register 0x0E[1:0]</td> </tr> <tr> <td>1</td> <td>0</td> <td>0</td> <td>Disable OUTAUX</td> </tr> <tr> <td>1</td> <td>0</td> <td>1</td> <td>Disable all PWM outputs except OUTAUX</td> </tr> <tr> <td>1</td> <td>1</td> <td>0</td> <td>Disable SR1, SR2, and OrFET</td> </tr> <tr> <td>1</td> <td>1</td> <td>1</td> <td>Disable the power supply and keep it disabled; PSON signal is necessary to restart</td> </tr> </tbody> </table>	Bit 6	Bit 5	Bit 4	Action	0	0	0	Ignore flag completely	0	0	1	Disable SR1 and SR2	0	1	0	Disable OrFET	0	1	1	Disable the power supply and reenable it after the power supply reenable time set in Register 0x0E[1:0]	1	0	0	Disable OUTAUX	1	0	1	Disable all PWM outputs except OUTAUX	1	1	0	Disable SR1, SR2, and OrFET	1	1	1	Disable the power supply and keep it disabled; PSON signal is necessary to restart
Bit 6	Bit 5	Bit 4	Action																																				
0	0	0	Ignore flag completely																																				
0	0	1	Disable SR1 and SR2																																				
0	1	0	Disable OrFET																																				
0	1	1	Disable the power supply and reenable it after the power supply reenable time set in Register 0x0E[1:0]																																				
1	0	0	Disable OUTAUX																																				
1	0	1	Disable all PWM outputs except OUTAUX																																				
1	1	0	Disable SR1, SR2, and OrFET																																				
1	1	1	Disable the power supply and keep it disabled; PSON signal is necessary to restart																																				
3	Timing	R/W	Same as Bit 7.																																				
[2:0]	Action	R/W	Same as Bits[6:4].																																				

Table 14. Register 0x0E—Flag Configuration Register

Bits	Bit Name	R/W	Description																																				
7	VDD OV/VCORE OV flags ignore	R/W	Setting this bit to 1 means that the VDD OV and VCORE OV flags are ignored.																																				
6	VDD OV/VCORE OV restart	R/W	This bit specifies whether the part downloads the EEPROM contents before it restarts. 1 = if the part shuts down, it downloads the EEPROM contents again before restarting. 0 = if the part shuts down, it does not download the EEPROM contents again before restarting.																																				
5	VDD OV/VCORE OV debounce	R/W	Setting this bit to 1 means that there is a 500 μ s debounce before the part shuts down. Setting this bit to 0 means that there is a 2 μ s debounce before the part shuts down.																																				
[4:2]	Accurate OCP debounce for CS1 and CS2	R/W	When an accurate OCP flag is set, there is a debounce time before the flag action is performed. These bits set the flag debounce time. The ADC sampling rate adds a variable latency from 2.62 ms to 5.24 ms to this debounce time.																																				
			<table border="1"> <thead> <tr> <th>Bit 4</th> <th>Bit 3</th> <th>Bit 2</th> <th>Debounce</th> </tr> </thead> <tbody> <tr> <td>0</td> <td>0</td> <td>0</td> <td>2.6 ms</td> </tr> <tr> <td>0</td> <td>0</td> <td>1</td> <td>9.8 ms</td> </tr> <tr> <td>0</td> <td>1</td> <td>0</td> <td>130 ms</td> </tr> <tr> <td>0</td> <td>1</td> <td>1</td> <td>260 ms</td> </tr> <tr> <td>1</td> <td>0</td> <td>0</td> <td>600 ms</td> </tr> <tr> <td>1</td> <td>0</td> <td>1</td> <td>1.3 sec</td> </tr> <tr> <td>1</td> <td>1</td> <td>0</td> <td>2 sec</td> </tr> <tr> <td>1</td> <td>1</td> <td>1</td> <td>2.6 sec</td> </tr> </tbody> </table>	Bit 4	Bit 3	Bit 2	Debounce	0	0	0	2.6 ms	0	0	1	9.8 ms	0	1	0	130 ms	0	1	1	260 ms	1	0	0	600 ms	1	0	1	1.3 sec	1	1	0	2 sec	1	1	1	2.6 sec
Bit 4	Bit 3	Bit 2	Debounce																																				
0	0	0	2.6 ms																																				
0	0	1	9.8 ms																																				
0	1	0	130 ms																																				
0	1	1	260 ms																																				
1	0	0	600 ms																																				
1	0	1	1.3 sec																																				
1	1	0	2 sec																																				
1	1	1	2.6 sec																																				
[1:0]	Power supply reenable time	R/W	These bits specify the time delay before restarting the power supply after a shutdown. SR1, SR2, and OrFET are reenabled immediately.																																				
			<table border="1"> <thead> <tr> <th>Bit 1</th> <th>Bit 0</th> <th>Time (sec)</th> </tr> </thead> <tbody> <tr> <td>0</td> <td>0</td> <td>0.5</td> </tr> <tr> <td>0</td> <td>1</td> <td>1</td> </tr> <tr> <td>1</td> <td>0</td> <td>2</td> </tr> <tr> <td>1</td> <td>1</td> <td>4</td> </tr> </tbody> </table>	Bit 1	Bit 0	Time (sec)	0	0	0.5	0	1	1	1	0	2	1	1	4																					
Bit 1	Bit 0	Time (sec)																																					
0	0	0.5																																					
0	1	1																																					
1	0	2																																					
1	1	4																																					

Register 0x0F allows the user to program the [ADP1046AW](#) to ignore the specified flags until the end of the soft start ramp time. The UVP and ACSNS flags are always active during soft start.

Table 15. Register 0x0F—Soft Start Blank Fault Flags Register

Bits	Bit Name	R/W	Description
7	Blank SR	R/W	Setting this bit means that the SR1 and SR2 PWM outputs are not enabled until the end of the soft start ramp time.
6	Blank OTP	R/W	Setting this bit means that the OTP flag is ignored until the end of the soft start ramp time.
5	Blank FLAGIN	R/W	Setting this bit means that the FLAGIN flag is ignored until the end of the soft start ramp time.
4	Blank local OVP (accurate and fast)	R/W	Setting this bit means that the local OVP flag is ignored until the end of the soft start ramp time.
3	Blank load OVP	R/W	Setting this bit means that the load OVP flag is ignored until the end of the soft start ramp time.
2	Blank CS2 accurate OCP	R/W	Setting this bit means that the CS2 accurate OCP flag is ignored until the end of the soft start ramp time.
1	Blank CS1 accurate OCP	R/W	Setting this bit means that the CS1 accurate OCP flag is ignored until the end of the soft start ramp time.
0	Blank CS1 fast OCP	R/W	Setting this bit means that the CS1 fast OCP flag is ignored until the end of the soft start ramp time.

VALUE REGISTERS

Table 16. Register 0x10—First Flag ID

Bits	Bit Name	R/W	Description																																																																																																						
[7:4]	Reserved	R	Reserved.																																																																																																						
[3:0]	First flag ID	R	These bits record the flag that was set first. Restarting the power supply resets this register. Reading this register also resets the register.																																																																																																						
			<table border="1"> <thead> <tr> <th>Bit 3</th> <th>Bit 2</th> <th>Bit 1</th> <th>Bit 0</th> <th>Fault Register</th> <th>Flag</th> </tr> </thead> <tbody> <tr> <td>0</td> <td>0</td> <td>0</td> <td>0</td> <td>None</td> <td>No flag</td> </tr> <tr> <td>0</td> <td>0</td> <td>0</td> <td>1</td> <td>Register 0x01, Bit 3</td> <td>VCORE OV</td> </tr> <tr> <td>0</td> <td>0</td> <td>1</td> <td>0</td> <td>Register 0x01, Bit 2</td> <td>VDD OV</td> </tr> <tr> <td>0</td> <td>0</td> <td>1</td> <td>1</td> <td>Register 0x03, Bit 1</td> <td>EEPROM CRC fault</td> </tr> <tr> <td>0</td> <td>1</td> <td>0</td> <td>0</td> <td>Register 0x00, Bit 2</td> <td>CS1 fast OCP</td> </tr> <tr> <td>0</td> <td>1</td> <td>0</td> <td>1</td> <td>Register 0x00, Bit 1</td> <td>CS1 accurate OCP</td> </tr> <tr> <td>0</td> <td>1</td> <td>1</td> <td>0</td> <td>Register 0x00, Bit 0</td> <td>CS2 accurate OCP</td> </tr> <tr> <td>0</td> <td>1</td> <td>1</td> <td>1</td> <td>Register 0x01, Bit 1</td> <td>Load OVP</td> </tr> <tr> <td>1</td> <td>0</td> <td>0</td> <td>0</td> <td>Register 0x01, Bit 0</td> <td>Local OVP (fast and accurate)</td> </tr> <tr> <td>1</td> <td>0</td> <td>0</td> <td>1</td> <td>Register 0x02, Bit 0</td> <td>FLAGIN</td> </tr> <tr> <td>1</td> <td>0</td> <td>1</td> <td>0</td> <td>Register 0x02, Bit 7</td> <td>OTP</td> </tr> <tr> <td>1</td> <td>0</td> <td>1</td> <td>1</td> <td>Register 0x01, Bit 6</td> <td>UVP</td> </tr> <tr> <td>1</td> <td>1</td> <td>0</td> <td>0</td> <td>Register 0x01, Bit 5</td> <td>CS2 reverse current</td> </tr> <tr> <td>1</td> <td>1</td> <td>0</td> <td>1</td> <td>Register 0x01, Bit 7</td> <td>Voltage continuity</td> </tr> <tr> <td>1</td> <td>1</td> <td>1</td> <td>0</td> <td>Register 0x02, Bit 5</td> <td>Share bus</td> </tr> <tr> <td>1</td> <td>1</td> <td>1</td> <td>1</td> <td>Register 0x03, Bit 2</td> <td>ACSNS</td> </tr> </tbody> </table>	Bit 3	Bit 2	Bit 1	Bit 0	Fault Register	Flag	0	0	0	0	None	No flag	0	0	0	1	Register 0x01, Bit 3	VCORE OV	0	0	1	0	Register 0x01, Bit 2	VDD OV	0	0	1	1	Register 0x03, Bit 1	EEPROM CRC fault	0	1	0	0	Register 0x00, Bit 2	CS1 fast OCP	0	1	0	1	Register 0x00, Bit 1	CS1 accurate OCP	0	1	1	0	Register 0x00, Bit 0	CS2 accurate OCP	0	1	1	1	Register 0x01, Bit 1	Load OVP	1	0	0	0	Register 0x01, Bit 0	Local OVP (fast and accurate)	1	0	0	1	Register 0x02, Bit 0	FLAGIN	1	0	1	0	Register 0x02, Bit 7	OTP	1	0	1	1	Register 0x01, Bit 6	UVP	1	1	0	0	Register 0x01, Bit 5	CS2 reverse current	1	1	0	1	Register 0x01, Bit 7	Voltage continuity	1	1	1	0	Register 0x02, Bit 5	Share bus	1	1	1	1	Register 0x03, Bit 2	ACSNS
Bit 3	Bit 2	Bit 1	Bit 0	Fault Register	Flag																																																																																																				
0	0	0	0	None	No flag																																																																																																				
0	0	0	1	Register 0x01, Bit 3	VCORE OV																																																																																																				
0	0	1	0	Register 0x01, Bit 2	VDD OV																																																																																																				
0	0	1	1	Register 0x03, Bit 1	EEPROM CRC fault																																																																																																				
0	1	0	0	Register 0x00, Bit 2	CS1 fast OCP																																																																																																				
0	1	0	1	Register 0x00, Bit 1	CS1 accurate OCP																																																																																																				
0	1	1	0	Register 0x00, Bit 0	CS2 accurate OCP																																																																																																				
0	1	1	1	Register 0x01, Bit 1	Load OVP																																																																																																				
1	0	0	0	Register 0x01, Bit 0	Local OVP (fast and accurate)																																																																																																				
1	0	0	1	Register 0x02, Bit 0	FLAGIN																																																																																																				
1	0	1	0	Register 0x02, Bit 7	OTP																																																																																																				
1	0	1	1	Register 0x01, Bit 6	UVP																																																																																																				
1	1	0	0	Register 0x01, Bit 5	CS2 reverse current																																																																																																				
1	1	0	1	Register 0x01, Bit 7	Voltage continuity																																																																																																				
1	1	1	0	Register 0x02, Bit 5	Share bus																																																																																																				
1	1	1	1	Register 0x03, Bit 2	ACSNS																																																																																																				

Table 17. Register 0x11—RTD Current Source

Bits	Bit Name	R/W	Description															
[7:6]	RTD current setting	R/W	These bits set the size of the current source on the RTD pin.															
			<table border="1"> <thead> <tr> <th>Bit 7</th> <th>Bit 6</th> <th>Current Source (μA)</th> </tr> </thead> <tbody> <tr> <td>0</td> <td>0</td> <td>10</td> </tr> <tr> <td>0</td> <td>1</td> <td>20</td> </tr> <tr> <td>1</td> <td>0</td> <td>30</td> </tr> <tr> <td>1</td> <td>1</td> <td>40</td> </tr> </tbody> </table>	Bit 7	Bit 6	Current Source (μA)	0	0	10	0	1	20	1	0	30	1	1	40
Bit 7	Bit 6	Current Source (μA)																
0	0	10																
0	1	20																
1	0	30																
1	1	40																
[5:0]	Current trim	R/W	These six bits are used to trim the current source on the RTD pin. Each LSB corresponds to 160 nA, independent of the RTD current setting selected in Register 0x11[7:6].															

Table 18. Register 0x12—HF ADC Reading

Bits	Bit Name	R/W	Description
[7:0]	HF ADC reading	R	This register contains the reading from the high frequency ADC.

Table 19. Register 0x13—CS1 Value (Input Current)

Bits	Bit Name	R/W	Description
[15:4]	Input current value	R	This register contains the 12-bit input current information. This value is derived from a voltage measurement at the CS1 input. To read the input current information, this register must be read using two consecutive read operations. The eight bits of the first read return the eight MSBs of the input current information. The top four bits of the second read return the four LSBs of the input current information. The range of the CS1 input pin is from 0 V to 1.4 V. This value has 12 bits of resolution, which results in an LSB size of 342 μ V. At 0 V input, the value in this register is 0 (0x000). At 1 V input, the value in this register is 2926 (0xB6E).
[3:0]	Reserved	R	Reserved.

Table 20. Register 0x14—ACSNS Value

Bits	Bit Name	R/W	Description
[15:4]	ACSNS voltage value	R	This register contains the 12-bit ACSNS slow ADC voltage information.
[3:0]	Reserved	R	Reserved.

Table 21. Register 0x15—VS1 Voltage Value

Bits	Bit Name	R/W	Description
[15:4]	VS1 voltage value	R	This register contains the 12-bit local output voltage information. This voltage is measured at the VS1 pin. To read the VS1 voltage information, this register must be read using two consecutive read operations. The eight bits of the first read return the eight MSBs of the local output voltage information. The top four bits of the second read return the four LSBs of the local output voltage information. The range of the VS1 input pin is from 0 V to 1.6 V. This value has 12 bits of resolution, which results in an LSB size of 390.625 μ V. At 0 V input, the value in this register is 0 (0x000). The recommended nominal voltage at this pin is 1 V. At 1 V input, these bits read 2560 (0xA00).
[3:0]	Reserved	R	Reserved.

Table 22. Register 0x16—VS2 Voltage Value

Bits	Bit Name	R/W	Description
[15:4]	VS2 voltage value	R	This register contains the 12-bit load output voltage information. This voltage is measured at the VS2 pin. To read the load VS2 voltage information, this register must be read using two consecutive read operations. The eight bits of the first read return the eight MSBs of the load output voltage information. The top four bits of the second read return the four LSBs of the load output voltage information. The range of the VS2 input pin is from 0 V to 1.6 V. This value has 12 bits of resolution, which results in an LSB size of 390.625 μ V. At 0 V input, the value in this register is 0 (0x000). The recommended nominal voltage at this pin is 1 V. At 1 V input, these bits read 2560 (0xA00).
[3:0]	Reserved	R	Reserved.

Table 23. Register 0x17—VS3 Voltage Value (Output Voltage)

Bits	Bit Name	R/W	Description
[15:4]	VS3 voltage value	R	This register contains the 12-bit remote output voltage information. This value is the differential voltage between the VS3+ and VS3– pins. To read the remote output voltage information, this register must be read using two consecutive read operations. The eight bits of the first read return the eight MSBs of the remote output voltage information. The top four bits of the second read return the four LSBs of the remote output voltage information. The range of the VS3 \pm input pins is from 0 V to 1.6 V. This value has 12 bits of resolution, which results in an LSB size of 390.625 μ V. At 0 V input, the value in this register is 0 (0x000). The recommended nominal voltage at this pin is 1 V. At 1 V input, these bits read 2560 (0xA00).
[3:0]	Reserved	R	Reserved.

Table 24. Register 0x18—CS2 Value (Output Current)

Bits	Bit Name	R/W	Description
[15:4]	Output current value	R	This register contains the 12-bit output current information. This value is the voltage drop across the sense resistor. To obtain the current value, the user must divide the value of this register by the sense resistor value (see the CS2+, CS2– Pins section). The CS2± pins have a full-scale input range of 120 mV or 60 mV (set in Register 0x27[5]). This value has 12 bits of resolution; the LSB step size depends on the input range value. When the CS2 input range is set to 120 mV, the LSB step size is 29.30 μ V. For example, at a 30 mV input signal on CS2, the value in this register is 30 mV/29.30 μ V = 1024 (0x400). When the CS2 input range is set to 60 mV, the LSB step size is 14.65 μ V. For example, at a 30 mV input signal on CS2, the value in this register is 30 mV/14.65 μ V = 2048 (0x800).
[3:0]	Reserved	R	Reserved.

Table 25. Register 0x19—CS2 \times VS3 Value (Output Power)

Bits	Bit Name	R/W	Description
[15:0]	Output power value	R	This register contains the 16-bit output power information. This value is the product of the remote output voltage value (VS3) and the output current reading (CS2). See the Power Readings section for the formulas needed to convert this digital reading into power information.

Table 26. Register 0x1A—RTD Temperature Value

Bits	Bit Name	R/W	Description
[15:4]	Temperature value	R	This register contains the 12-bit output temperature information, as determined from the RTD pin. The range of the RTD pin is from 0 V to 1.6 V. This value has 12 bits of resolution, which results in an LSB size of 390.625 μ V. At 0 V input, the value in this register is 0 (0x000). The recommended nominal voltage at this pin is 1 V. At 1 V input, these bits read 2560 (0xA00).
[3:0]	Reserved	R	Reserved.

Table 27. Register 0x1B—Read Temperature

Bits	Bit Name	R/W	Description
[7:0]	Read temperature	R/W	This register returns an 8-bit temperature in $^{\circ}$ C (unsigned decimal format). For this feature to function correctly, the external thermistor must be 100 k Ω with a 16.5 k Ω , 1% resistor in parallel, and the selected current source must be trimmed to 46 μ A by selecting 40 μ A in Register 0x11[7:6] and using the current trim (fine-trim) bits in Register 0x11[5:0].

Table 28. Register 0x1C—RTD Offset Trim (MSB)

Bits	Bit Name	R/W	Description
[7:2]	Reserved	R	Reserved.
1	Trim polarity	R/W	Setting this bit to 1 means that negative offset is introduced. Setting this bit to 0 means that positive offset is introduced.
0	RTD offset trim (MSB)	R/W	This bit is the MSB of the RTD offset trim. Together with Register 0x20 (the LSBs), this bit sets the amount of offset trim that is applied to the RTD ADC reading.

Table 29. Register 0x1D—Share Bus Value

Bits	Bit Name	R/W	Description
[7:0]	Share bus value	R	This register contains the 8-bit share bus voltage information. If the power supply is the master, this register outputs 0.

Table 30. Register 0x1E—Modulation Value

Bits	Bit Name	R/W	Description
[7:0]	Modulation value	R	This register contains the 8-bit modulation information. It outputs the amount of modulation from 0% to 100% that is being placed on the modulating edges.

Table 31. Register 0x1F—Line Impedance Value

Bits	Bit Name	R/W	Description
[7:0]	Line impedance value	R	This register contains the 8-bit line impedance information. This value is (VS2 – VS3)/CS2.

Table 32. Register 0x20—RTD Offset Trim (LSBs)

Bits	Bit Name	R/W	Description
[7:0]	RTD offset trim (LSBs)	R/W	These eight bits, together with Register 0x1C[0] (the MSB), set the amount of offset trim that is applied to the RTD ADC reading.

CURRENT SENSE AND CURRENT LIMIT REGISTERS**Table 33. Register 0x21—CS1 Gain Trim**

Bits	Bit Name	R/W	Description
7	Gain polarity	R/W	1 = negative gain is introduced. 0 = positive gain is introduced.
[6:0]	CS1 gain trim	R/W	This value calibrates the primary side current sense gain. See the CS1 Trim section for more information.

Table 34. Register 0x22—CS1 Accurate OCP Limit

Bits	Bit Name	R/W	Description			
[7:5]	CS1 fast OCP blanking	R/W	These bits determine the blanking time for CS1 before fast OCP is enabled. This time is measured from the start of a switching cycle. If using OUTAUX, the time is synchronized with the rising edge of OUTAUX.			
				Bit 7	Bit 6	Bit 5
			0	0	0	0
			0	0	1	40
			0	1	0	80
			0	1	1	120
			1	0	0	200
			1	0	1	400
			1	1	0	600
	1	1	1	800		
[4:0]	CS1 accurate OCP	R/W	These bits set the CS1 accurate OCP threshold. The digital word that is output from the CS1 ADC is compared with this threshold. If the CS1 ADC reading (Register 0x13) is greater than the OCP threshold set by these bits, the CS1 accurate OCP flag is set. This value should be programmed only after the CS1 trim has been performed. The range of these bits is from 0 to 31, that is, 0 V to 1.4 V in 43.75 mV steps. The following equation gives the CS1 accurate OCP threshold: $CS1_OCP_Threshold = (CS1_OCP_Limit \times 1.4V/32) + 16 \times 1.4/2^{12}$			

Table 35. Register 0x23—CS2 Gain Trim

Bits	Bit Name	R/W	Description
[7:6]	Reserved	R/W	Reserved.
5	Gain polarity	R/W	1 = negative gain is introduced. 0 = positive gain is introduced.
[4:0]	CS2 gain trim	R/W	This register calibrates the secondary side (CS2) current sense gain. It calibrates for errors in the sense resistor. See the CS2 Trim section for more information.

Table 36. Register 0x24—CS2 Analog Offset Trim

Bits	Bit Name	R/W	Description
7	Reserved	R/W	Reserved.
6	Offset polarity	R/W	1 = negative offset is introduced. 0 = positive offset is introduced.
[5:0]	CS2 offset trim	R/W	This register calibrates the secondary side (CS2) current sense common-mode error. It calibrates for errors in the resistor divider network. See the CS2 Trim section for more information.

Table 37. Register 0x25—CS2 Digital Offset Trim

Bits	Bit Name	R/W	Description
[7:0]	CS2 digital offset trim	R/W	This register contains the CS2 digital trim level. This value is used to calibrate the CS2 value that is read in Register 0x18. See the CS2 Trim section for more information.

Table 38. Register 0x26—CS2 Accurate OCP Limit

Bits	Bit Name	R/W	Description
[7:0]	CS2 accurate OCP	R/W	This register sets the CS2 accurate OCP current level. This 8-bit number is compared to the CS2 value register (Register 0x18). When the CS2 value register is greater than the value in this register, the CS2 accurate OCP flag is set. The following equation gives the CS2 accurate OCP threshold: $CS2_OCP_Threshold = CS2_OCP_Limit \times (ADC_Range)/256 + 16 \times (ADC_Range)/2^{12}$

Table 39. Register 0x27—CS1/CS2 Fast OCP Settings

Bits	Bit Name	R/W	Description		
[7:6]	CS1 fast OCP debounce	R/W	These bits set the CS1 fast OCP debounce value. This is the minimum time that the CS1 signal must be constantly above the fast OCP limit before the PWM outputs are shut down. When this happens, all PWM outputs are disabled for the remainder of the switching cycle.		
			Bit 7	Bit 6	Debounce (ns)
			0	0	0
			0	1	40
			1	0	80
1	1	120			
5	CS2 nominal voltage drop	R/W	These bits set the nominal full-scale voltage drop across the sense resistor. See the CS2 Trim section for more information. These bits set the LSB step size of the CS2 ADC.		
			Bit 5	ADC Range (mV)	LSB Step Size (μV)
			0	60	14.65
1	120	29.30			
4	CS1 fast OCP bypass	R/W	Setting this bit to 1 means that the FLAGIN pin is used for CS1 fast OCP instead of the CS1 pin.		
3	Constant current mode	R/W	When this bit is set, constant current mode is enabled to 97% of the CS2 accurate OCP limit. 1 = constant current mode enabled. 0 = constant current mode disabled.		
2	CS2 current sensing	R/W	This bit is set high if high-side current sensing is used. This bit is set low if low-side current sensing is used. See the CS2 Trim section for more information.		
[1:0]	CS1 fast OCP timeout	R/W	If the CS1 fast OCP comparator is set, all PWM outputs that are on at that time are immediately disabled for the remainder of the switching cycle. The PWM outputs resume normal operation at the beginning of the next switching cycle. These bits set the number of consecutive switching cycles for the comparator before the CS1 fast OCP response is activated.		
			Bit 1	Bit 0	Number of Switching Cycles
			0	0	1
			0	1	62
			1	0	188
1	1	440			

Table 40. Register 0x28—Volt-Second Balance Settings

Bits	Bit Name	R/W	Description		
7	Reserved	R/W	Reserved.		
6	Volt-second balance enable	R/W	Setting this bit enables volt-second balance for the main transformer (used for full-bridge configurations). For more information, see the Volt-Second Balance section.		
5	Volt-second balance leading edge blanking	R/W	Setting this bit means that CS1 is blanked for volt-second balance calculations at the rising edge of the PWM outputs that are selected for volt-second balance. The blanking value is the same value configured for CS1 fast OCP blanking in Register 0x22[7:5].		
4	Volt-second disable during soft start	R/W	0 = do not blank volt-second balance control during soft start. 1 = blank volt-second balance control during soft start.		
3	50% blanking of each phase	R/W	Setting this bit limits the sampling period for the current on CS1 to less than 50% of a half cycle.		
2	Volt-second balance modulation	R/W	This bit specifies the maximum amount of modulation from volt-second balance. 0 = ±80 ns maximum. 1 = ±160 ns maximum.		
[1:0]	Volt-second balance gain setting	R/W	These bits set the gain of the volt-second balance circuit. The gain can be changed by a factor of 64. When these bits are set to 00, it takes approximately 700 ms to achieve volt-second balance. When these bits are set to 11, it takes approximately 10 ms to achieve volt-second balance.		
			Bit 1	Bit 0	Volt-Second Balance Gain
			0	0	1
			0	1	4
			1	0	16
1	1	64			

Table 41. Register 0x29—Share Bus Bandwidth

Bits	Bit Name	R/W	Description																																				
[7:5]	Reserved	R/W	Reserved.																																				
4	Bit stream	R/W	1 = the current sense ADC reading is output on the SHAREo pin. This bit stream can be used for analog current sharing. 0 = the digital share bus signal is output on the SHAREo pin. This signal can be used for digital current sharing.																																				
3	Current share enable	R/W	1 = Reserved. 0 = CS2 reading used for current share.																																				
[2:0]	Share bus bandwidth	R/W	These bits determine the amount of bandwidth dedicated to the share bus. A value of 000 is the lowest possible bandwidth, and a value of 111 is the highest possible bandwidth. The slave is incremented by 1 LSB per share bus transaction (eight data bits plus start and stop bits). The master is decremented by N LSBs per share bus transaction, where N is the value of Register 0x2A[7:4].																																				
			<table border="1"> <thead> <tr> <th>Bit 2</th> <th>Bit 1</th> <th>Bit 0</th> <th>Bandwidth</th> </tr> </thead> <tbody> <tr> <td>0</td> <td>0</td> <td>0</td> <td>Divide LSB by 16, that is, 1 LSB = 24 μV/16</td> </tr> <tr> <td>0</td> <td>0</td> <td>1</td> <td>Divide LSB by 8</td> </tr> <tr> <td>0</td> <td>1</td> <td>0</td> <td>Divide LSB by 4</td> </tr> <tr> <td>0</td> <td>1</td> <td>1</td> <td>Divide LSB by 2</td> </tr> <tr> <td>1</td> <td>0</td> <td>0</td> <td>Nominal</td> </tr> <tr> <td>1</td> <td>0</td> <td>1</td> <td>Multiply LSB by 2</td> </tr> <tr> <td>1</td> <td>1</td> <td>0</td> <td>Multiply LSB by 4</td> </tr> <tr> <td>1</td> <td>1</td> <td>1</td> <td>Multiply LSB by 8</td> </tr> </tbody> </table>	Bit 2	Bit 1	Bit 0	Bandwidth	0	0	0	Divide LSB by 16, that is, 1 LSB = 24 μ V/16	0	0	1	Divide LSB by 8	0	1	0	Divide LSB by 4	0	1	1	Divide LSB by 2	1	0	0	Nominal	1	0	1	Multiply LSB by 2	1	1	0	Multiply LSB by 4	1	1	1	Multiply LSB by 8
Bit 2	Bit 1	Bit 0	Bandwidth																																				
0	0	0	Divide LSB by 16, that is, 1 LSB = 24 μ V/16																																				
0	0	1	Divide LSB by 8																																				
0	1	0	Divide LSB by 4																																				
0	1	1	Divide LSB by 2																																				
1	0	0	Nominal																																				
1	0	1	Multiply LSB by 2																																				
1	1	0	Multiply LSB by 4																																				
1	1	1	Multiply LSB by 8																																				

Table 42. Register 0x2A—Share Bus Setting

Bits	Bit Name	R/W	Description
[7:4]	Number of bits dropped by master	R/W	These bits determine how much a master device reduces its output voltage to maintain current sharing. For more information, see the description of Bits[2:0] in Register 0x29.
[3:0]	Bit difference between master and slave	R/W	These bits determine how closely a slave tries to match the current of the master device. The higher the setting, the larger the voltage difference that satisfies the current sharing criteria.

Table 43. Register 0x2B—Temperature Gain Trim

Bits	Bit Name	R/W	Description
7	Gain polarity	R/W	1 = negative gain is introduced. 0 = positive gain is introduced.
[6:0]	Gain trim	R/W	This register calibrates the RTD ADC gain. It calibrates for errors in the ADC.

Table 44. Register 0x2C—PSON/Soft Start

Bits	Bit Name	R/W	Description															
[7:6]	PS_ON setting	R/W	These bits determine which signal is used by the ADP1046AW as the PS_ON control.															
			<table border="1"> <thead> <tr> <th>Bit 7</th> <th>Bit 6</th> <th>PS_ON Setting</th> </tr> </thead> <tbody> <tr> <td>0</td> <td>0</td> <td>The ADP1046AW is always on.</td> </tr> <tr> <td>0</td> <td>1</td> <td>Hardware PS_ON pin is used to enable or disable the power supply.</td> </tr> <tr> <td>1</td> <td>0</td> <td>Software PS_ON bit (Bit 5) is used to enable or disable the power supply.</td> </tr> <tr> <td>1</td> <td>1</td> <td>Both the software PS_ON bit and the hardware PS_ON pin must be enabled before the ADP1046AW is enabled.</td> </tr> </tbody> </table>	Bit 7	Bit 6	PS_ON Setting	0	0	The ADP1046AW is always on.	0	1	Hardware PS_ON pin is used to enable or disable the power supply.	1	0	Software PS_ON bit (Bit 5) is used to enable or disable the power supply.	1	1	Both the software PS_ON bit and the hardware PS_ON pin must be enabled before the ADP1046AW is enabled.
Bit 7	Bit 6	PS_ON Setting																
0	0	The ADP1046AW is always on.																
0	1	Hardware PS_ON pin is used to enable or disable the power supply.																
1	0	Software PS_ON bit (Bit 5) is used to enable or disable the power supply.																
1	1	Both the software PS_ON bit and the hardware PS_ON pin must be enabled before the ADP1046AW is enabled.																
5	PS_ON	R/W	Software PS_ON bit. 0 = power supply off. 1 = power supply on.															
[4:3]	PS_ON delay	R/W	These bits set the time from when the PS_ON control signal is set to when the soft start begins.															
			<table border="1"> <thead> <tr> <th>Bit 4</th> <th>Bit 3</th> <th>Typical Delay (sec)</th> </tr> </thead> <tbody> <tr> <td>0</td> <td>0</td> <td>0</td> </tr> <tr> <td>0</td> <td>1</td> <td>0.5</td> </tr> <tr> <td>1</td> <td>0</td> <td>1</td> </tr> <tr> <td>1</td> <td>1</td> <td>2</td> </tr> </tbody> </table>	Bit 4	Bit 3	Typical Delay (sec)	0	0	0	0	1	0.5	1	0	1	1	1	2
Bit 4	Bit 3	Typical Delay (sec)																
0	0	0																
0	1	0.5																
1	0	1																
1	1	2																

Bits	Bit Name	R/W	Description
2	Reserved	R/W	Set this bit to 0 for normal operation.
1	Disable light load during soft start	R/W	0 = allow switching to light load mode filter during soft start. 1 = never switch to light load mode filter during soft start.
0	Force soft start filter	R/W	0 = use normal mode filter or soft start filter, depending on the OrFET status. If regulating from VS3 (OrFET on), the normal mode filter is used. If regulating from VS1 (OrFET off), the soft start filter is used. 1 = use soft start filter as the initial filter regardless of OrFET status.

Table 45. Register 0x2D—PGOOD Debounce and Pin Polarity Settings

Bits	Bit Name	R/W	Description		
[7:6]	PGOOD1 turn-on debounce	R/W	These bits set the debounce time before the PGOOD1 pin and flag are set. This debounce time starts at the end of the soft start ramp and can vary by ± 50 ms. The turn-off of PGOOD1 is always immediate (no debounce).		
			Bit 7	Bit 6	Typical Debounce Time (ms)
			0	0	350
			0	1	150
			1	0	550
			1	1	0
[5:4]	PGOOD2 turn-on debounce	R/W	These bits set the debounce time before the PGOOD2 pin and flag are set. This debounce time starts at the end of the soft start ramp and can vary by ± 50 ms. The turn-off of PGOOD2 is always immediate (no debounce).		
			Bit 5	Bit 4	Typical Debounce Time (ms)
			0	0	350
			0	1	150
			1	0	550
			1	1	0
3	PGOOD2 flags	R/W	The following flags can also set the PGOOD2 pin: voltage continuity, OrFET disable, ACSNS, FLAGIN, and OTP. This bit specifies whether these flags unconditionally set PGOOD2 or whether these flags set PGOOD2 only if the flag action is not set to ignore in the appropriate fault configuration register (see Table 12 and Table 13). 0 = voltage continuity, OrFET disable, ACSNS, FLAGIN, and OTP flags always set the PGOOD2 pin. 1 = voltage continuity, OrFET disable, ACSNS, FLAGIN, and OTP flags set the PGOOD2 pin only if the flag action is not set to ignore.		
2	FLAGIN polarity	R/W	This bit sets the polarity of the FLAGIN input pin: 1 = inverted (low = 0 V = on).		
1	GATE polarity	R/W	This bit sets the polarity of the OrFET GATE control pin: 1 = inverted (low = 0 V = on).		
0	PSON polarity	R/W	This bit sets the polarity of the PSON input pin: 1 = inverted (low = 0 V = on).		

Table 46. Register 0x2E—Modulation Limit

Bits	Bit Name	R/W	Description	
7	Full-bridge mode	R/W	Enable this bit when operating in full-bridge mode. It affects the modulation high limit.	
[6:0]	Modulation limits	R/W	This value sets the minimum/maximum modulation limits relative to the nominal edge value. The resolution depends on the switching frequency range.	
			Switching Frequency Range	Resolution Corresponding to LSB
			48.8 kHz to 86.8 kHz	160 ns
			97.7 kHz to 183.8 kHz	80 ns
			195 kHz to 378.8 kHz	40 ns
			390.6 kHz to 625.0 kHz	20 ns

Table 47. Register 0x2F—OTP Threshold

Bits	Bit Name	R/W	Description																																																																																																
[7:0]	OTP threshold	R/W	This register, adding 0 as the MSB, results in a 9-bit OTP threshold value. This 9-bit value is compared to the nine MSBs of the RTD ADC reading. If the RTD ADC reading is lower than the threshold set by these bits, the OTP flag is set. This 8-bit register provides 256 threshold settings from 0 mV to 800 mV. One LSB equates to $800 \text{ mV}/256 = 3.125 \text{ mV}$. Some of the threshold settings at the high and low ends of the range are not allowed. The OTP flag has a hysteresis of 16 mV.																																																																																																
			<table border="1"> <thead> <tr> <th>Bit 7</th> <th>Bit 6</th> <th>...</th> <th>Bit 3</th> <th>Bit 2</th> <th>Bit 1</th> <th>Bit 0</th> <th>OTP Limit (mV)</th> </tr> </thead> <tbody> <tr> <td>0</td> <td>0</td> <td>...</td> <td>0</td> <td>0</td> <td>0</td> <td>0</td> <td>0</td> </tr> <tr> <td>0</td> <td>0</td> <td>...</td> <td>0</td> <td>0</td> <td>0</td> <td>1</td> <td>3.125</td> </tr> <tr> <td>0</td> <td>0</td> <td>...</td> <td>0</td> <td>0</td> <td>1</td> <td>0</td> <td>6.25</td> </tr> <tr> <td>0</td> <td>0</td> <td>...</td> <td>0</td> <td>0</td> <td>1</td> <td>1</td> <td>9.375</td> </tr> <tr> <td>0</td> <td>0</td> <td>...</td> <td>0</td> <td>1</td> <td>0</td> <td>0</td> <td>12.5</td> </tr> <tr> <td>0</td> <td>0</td> <td>...</td> <td>0</td> <td>1</td> <td>0</td> <td>1</td> <td>15.625</td> </tr> <tr> <td>...</td> <td>...</td> <td>...</td> <td>...</td> <td>...</td> <td>...</td> <td>...</td> <td>...</td> </tr> <tr> <td>1</td> <td>1</td> <td>...</td> <td>1</td> <td>0</td> <td>0</td> <td>1</td> <td>778.125</td> </tr> <tr> <td>1</td> <td>1</td> <td>...</td> <td>1</td> <td>0</td> <td>1</td> <td>0</td> <td>781.25</td> </tr> <tr> <td>...</td> <td>...</td> <td>...</td> <td>...</td> <td>...</td> <td>...</td> <td>...</td> <td>...</td> </tr> <tr> <td>1</td> <td>1</td> <td>...</td> <td>1</td> <td>1</td> <td>1</td> <td>1</td> <td>796.875</td> </tr> </tbody> </table>	Bit 7	Bit 6	...	Bit 3	Bit 2	Bit 1	Bit 0	OTP Limit (mV)	0	0	...	0	0	0	0	0	0	0	...	0	0	0	1	3.125	0	0	...	0	0	1	0	6.25	0	0	...	0	0	1	1	9.375	0	0	...	0	1	0	0	12.5	0	0	...	0	1	0	1	15.625	1	1	...	1	0	0	1	778.125	1	1	...	1	0	1	0	781.25	1	1	...	1	1	1	1	796.875
Bit 7	Bit 6	...	Bit 3	Bit 2	Bit 1	Bit 0	OTP Limit (mV)																																																																																												
0	0	...	0	0	0	0	0																																																																																												
0	0	...	0	0	0	1	3.125																																																																																												
0	0	...	0	0	1	0	6.25																																																																																												
0	0	...	0	0	1	1	9.375																																																																																												
0	0	...	0	1	0	0	12.5																																																																																												
0	0	...	0	1	0	1	15.625																																																																																												
...																																																																																												
1	1	...	1	0	0	1	778.125																																																																																												
1	1	...	1	0	1	0	781.25																																																																																												
...																																																																																												
1	1	...	1	1	1	1	796.875																																																																																												

Table 48. Register 0x30—OrFET

Bits	Bit Name	R/W	Description																																				
7	OrFET enable delay	R/W	0 = delay of 328 μs , equivalent to 9 bits of (VS1 – VS2) data. 1 = delay of 164 μs , equivalent to 8 bits of (VS1 – VS2) data.																																				
[6:5]	OrFET enable threshold	R/W	These bits program the voltage difference between VS1 and VS2 before the OrFET is enabled. The VS1 and VS2 input pins are used to control the OrFET enable function.																																				
			<table border="1"> <thead> <tr> <th rowspan="2">Bit 6</th> <th rowspan="2">Bit 5</th> <th rowspan="2">ADC Full-Scale Range (%)</th> <th colspan="2">Voltage Difference from VS1 to VS2</th> </tr> <tr> <th>V_{OUT} = 12 V (mV)</th> <th>V_{OUT} = 48 V (mV)</th> </tr> </thead> <tbody> <tr> <td>0</td> <td>0</td> <td>–2</td> <td>–384</td> <td>–1504</td> </tr> <tr> <td>0</td> <td>1</td> <td>–1</td> <td>–192</td> <td>–752</td> </tr> <tr> <td>1</td> <td>0</td> <td>–0.5</td> <td>–96</td> <td>–376</td> </tr> <tr> <td>1</td> <td>1</td> <td>0</td> <td>0</td> <td>0</td> </tr> </tbody> </table>	Bit 6	Bit 5	ADC Full-Scale Range (%)	Voltage Difference from VS1 to VS2		V _{OUT} = 12 V (mV)	V _{OUT} = 48 V (mV)	0	0	–2	–384	–1504	0	1	–1	–192	–752	1	0	–0.5	–96	–376	1	1	0	0	0									
Bit 6	Bit 5	ADC Full-Scale Range (%)	Voltage Difference from VS1 to VS2																																				
			V _{OUT} = 12 V (mV)	V _{OUT} = 48 V (mV)																																			
0	0	–2	–384	–1504																																			
0	1	–1	–192	–752																																			
1	0	–0.5	–96	–376																																			
1	1	0	0	0																																			
[4:2]	Fast OrFET threshold	R/W	These bits program the threshold voltage difference between CS2+ and CS2– at which the OrFET is disabled. The CS2+ and CS2– input pins are used to control this function. The internal circuit is an analog comparator.																																				
			<table border="1"> <thead> <tr> <th>Bit 4</th> <th>Bit 3</th> <th>Bit 2</th> <th>Voltage Difference from CS2+ to CS2– (mV)</th> </tr> </thead> <tbody> <tr> <td>0</td> <td>0</td> <td>0</td> <td>–3</td> </tr> <tr> <td>0</td> <td>0</td> <td>1</td> <td>–6</td> </tr> <tr> <td>0</td> <td>1</td> <td>0</td> <td>–9</td> </tr> <tr> <td>0</td> <td>1</td> <td>1</td> <td>–12</td> </tr> <tr> <td>1</td> <td>0</td> <td>0</td> <td>–15</td> </tr> <tr> <td>1</td> <td>0</td> <td>1</td> <td>–18</td> </tr> <tr> <td>1</td> <td>1</td> <td>0</td> <td>–21</td> </tr> <tr> <td>1</td> <td>1</td> <td>1</td> <td>–24</td> </tr> </tbody> </table>	Bit 4	Bit 3	Bit 2	Voltage Difference from CS2+ to CS2– (mV)	0	0	0	–3	0	0	1	–6	0	1	0	–9	0	1	1	–12	1	0	0	–15	1	0	1	–18	1	1	0	–21	1	1	1	–24
Bit 4	Bit 3	Bit 2	Voltage Difference from CS2+ to CS2– (mV)																																				
0	0	0	–3																																				
0	0	1	–6																																				
0	1	0	–9																																				
0	1	1	–12																																				
1	0	0	–15																																				
1	0	1	–18																																				
1	1	0	–21																																				
1	1	1	–24																																				
1	Fast OrFET debounce	R/W	These bits determine the debounce on the fast OrFET control before it disables the OrFET. 0 = 40 ns. 1 = 200 ns.																																				
0	Fast OrFET bypass	R/W	Set this bit to completely bypass fast OrFET control. The action programmed for the OrFET flag is executed, unless the flag is programmed to be ignored.																																				

VOLTAGE SENSE REGISTERS

Table 49. Register 0x31—VS3 Voltage Setting (Remote Voltage)

Bits	Bit Name	R/W	Description
[7:0]	VS3 voltage setting	R/W	This register is used to set the output voltage (voltage differential at the VS3+ and VS3– pins). Each LSB corresponds to a 0.6% increase. Setting this register to a value of 0xA0 gives an output voltage setting of 100% of the nominal voltage. This is the default value that is stored in this register when the part is shipped from the factory. Updating the VS3 voltage setting is a two-stage process. The user must first change the value in this register; this information is stored in a shadow register. To latch the new VS3 voltage setting into the state machine, the user must set the voltage reference GO bit (Register 0x7F[0]). After that, the voltage changes with a limited slew rate (programmed in Register 0x5F[2:0]).

Table 50. Register 0x32—VS1 Overvoltage Limit (OVP)

Bits	Bit Name	R/W	Description															
[7:3]	VS1 OVP setting	R/W	Local overvoltage limit. This limit is programmable from 111.25% to 150% of the nominal VS1 voltage; 0x00 corresponds to 111.25%. Each LSB results in an increase of 1.25%. The VS1 OVP threshold is calculated as follows: $VS1_OVP_Threshold = [(89 + VS1_OVP_Setting)/128] \times 1.6 V$ For example, if the VS1 OVP setting is 10, then $VS1_OVP_Threshold = [(89 + 10)/128] \times 1.6 V = 1.2375 V$ Setting these bits to 0 gives an OVP limit of 111.25% of the nominal VS1 voltage. Setting these bits to 7 gives an OVP limit of 120% of the nominal VS1 voltage. Setting these bits to 15 gives an OVP limit of 130% of the nominal VS1 voltage. Setting these bits to 31 gives an OVP limit of 150% of the nominal VS1 voltage.															
2	Reserved	R/W	Reserved.															
[1:0]	OVP sampling	R/W	The OVP flag is set if the average voltage during the OVP sampling period is greater than the OVP threshold. This OVP flag sampling period is 80 μ s. The number of samples can be increased using these bits. If the number of samples is increased, the average voltage must be greater than the OVP threshold for each of those cycles. For example, if this value is set to two cycles, the average voltage must be greater than the OVP threshold for both cycles.															
			<table border="1"> <thead> <tr> <th>Bit 1</th> <th>Bit 0</th> <th>Additional Sampling (μs)</th> </tr> </thead> <tbody> <tr> <td>0</td> <td>0</td> <td>0 (one sample sets the OVP flag)</td> </tr> <tr> <td>0</td> <td>1</td> <td>80 (two samples set the OVP flag)</td> </tr> <tr> <td>1</td> <td>0</td> <td>160 (three samples set the OVP flag)</td> </tr> <tr> <td>1</td> <td>1</td> <td>240 (four samples set the OVP flag)</td> </tr> </tbody> </table>	Bit 1	Bit 0	Additional Sampling (μ s)	0	0	0 (one sample sets the OVP flag)	0	1	80 (two samples set the OVP flag)	1	0	160 (three samples set the OVP flag)	1	1	240 (four samples set the OVP flag)
Bit 1	Bit 0	Additional Sampling (μ s)																
0	0	0 (one sample sets the OVP flag)																
0	1	80 (two samples set the OVP flag)																
1	0	160 (three samples set the OVP flag)																
1	1	240 (four samples set the OVP flag)																

Table 51. Register 0x33—VS2 and VS3 Overvoltage Limit (OVP)

Bits	Bit Name	R/W	Description
[7:3]	VS2 and VS3 OVP setting	R/W	Local overvoltage limit. This limit is programmable from 111.25% to 150% of the nominal VSx voltage; 0x00 corresponds to 111.25%. Each LSB results in an increase of 1.25%. The VSx OVP threshold is calculated as follows: $VSx_OVP_Threshold = [(89 + VSx_OVP_Setting)/128] \times 1.6 V$ For example, if the VS2 OVP setting is 10, then $VS2_OVP_Threshold = [(89 + 10)/128] \times 1.6 V = 1.2375 V$ Setting these bits to 0 gives an OVP limit of 111.25% of the nominal VSx voltage. Setting these bits to 7 gives an OVP limit of 120% of the nominal VSx voltage. Setting these bits to 15 gives an OVP limit of 130% of the nominal VSx voltage. Setting these bits to 31 gives an OVP limit of 150% of the nominal VSx voltage.
2	Regulating point	R/W	When this bit is set, the ADP1046AW regulates from the VS3 node at all times. When this bit is not set, the ADP1046AW uses the VS1 voltage as the regulating point during soft start and when the OrFET is disabled.

Bits	Bit Name	R/W	Description															
[1:0]	OVP sampling	R/W	The OVP flag is set if the average voltage during the OVP sampling period is greater than the OVP threshold. This OVP flag sampling period is 80 μ s. The number of samples can be increased using these bits. If the number of samples is increased, the average voltage must be greater than the OVP threshold for each of those cycles. For example, if this value is set to two cycles, the average voltage must be greater than the OVP threshold for both cycles.															
			<table border="1"> <thead> <tr> <th>Bit 1</th> <th>Bit 0</th> <th>Additional Sampling (μs)</th> </tr> </thead> <tbody> <tr> <td>0</td> <td>0</td> <td>0 (one sample sets the OVP flag)</td> </tr> <tr> <td>0</td> <td>1</td> <td>80 (two samples set the OVP flag)</td> </tr> <tr> <td>1</td> <td>0</td> <td>160 (three samples set the OVP flag)</td> </tr> <tr> <td>1</td> <td>1</td> <td>240 (four samples set the OVP flag)</td> </tr> </tbody> </table>	Bit 1	Bit 0	Additional Sampling (μ s)	0	0	0 (one sample sets the OVP flag)	0	1	80 (two samples set the OVP flag)	1	0	160 (three samples set the OVP flag)	1	1	240 (four samples set the OVP flag)
Bit 1	Bit 0	Additional Sampling (μ s)																
0	0	0 (one sample sets the OVP flag)																
0	1	80 (two samples set the OVP flag)																
1	0	160 (three samples set the OVP flag)																
1	1	240 (four samples set the OVP flag)																

Table 52. Register 0x34—VS1 Undervoltage Limit (UVP)

Bits	Bit Name	R/W	Description
7	End of cycle shutdown	R/W	This bit is valid only when the OUTAUX pin is used for regulation. When any flag shuts down the power supply, the OUTAUX PWM is immediately shut down. This bit specifies when the other PWM outputs are shut down. 1 = all other PWM outputs are shut down at the end of the switching cycle. 0 = all other PWM outputs are immediately shut down.
[6:0]	VS1 UVP setting	R/W	These bits set the UVP limit to one of 127 settings. The UVP limit can be programmed from 1.25% to 158.75% of the nominal VS1 voltage. Each LSB increases the voltage by $158.75\%/128 = 1.25\%$. In reality, there are 81 usable settings, which program the UVP threshold from 1.25% to 100% of the nominal VS1 voltage. The VS1 UVP threshold is calculated as follows: $VS1_UVP_Threshold = [(VS1_UVP_Setting + 1)/128] \times 1.6\text{ V} - 12.5\text{ mV}$ For example, if the VS1 UVP setting is 60, then $VS1_UVP_Threshold = [(60 + 1)/128] \times 1.6\text{ V} - 12.5\text{ mV} = 750\text{ mV}$ Setting these bits to 1 gives a UVP limit of 1.25% of the nominal VS1 voltage. Setting these bits to 72 (0x48) gives a UVP limit of 90% of the nominal VS1 voltage. Setting these bits to 76 (0x4C) gives a UVP limit of 95% of the nominal VS1 voltage. Setting these bits to 80 (0x50) gives a UVP limit of 100% of the nominal VS1 voltage. Setting these bits to 127 (0x7F) gives a UVP limit of 158.75% of the nominal VS1 voltage.

Table 53. Register 0x35—Line Impedance Limit

Bits	Bit Name	R/W	Description
[7:0]	Line impedance limit	R/W	This value sets the threshold at which the line impedance flag is enabled. This 8-bit value is compared with the line impedance value (Register 0x1F). If the line impedance value exceeds this value, the line impedance flag is set (Register 0x02, Bit 2).

Table 54. Register 0x36—Load Line Impedance

Bits	Bit Name	R/W	Description																																				
7	Load line enable	R/W	Set this bit to enable the load line.																																				
[6:4]	Slew rate	R/W	These bits set the load line slew rate limit, which determines the maximum slew rate for changing the reference when adjusting the output load line value.																																				
			<table border="1"> <thead> <tr> <th>Bit 6</th> <th>Bit 5</th> <th>Bit 4</th> <th>Maximum Slew Rate Duration</th> </tr> </thead> <tbody> <tr> <td>0</td> <td>0</td> <td>0</td> <td>200 mV/ms</td> </tr> <tr> <td>0</td> <td>0</td> <td>1</td> <td>100 mV/ms</td> </tr> <tr> <td>0</td> <td>1</td> <td>0</td> <td>50 mV/ms</td> </tr> <tr> <td>0</td> <td>1</td> <td>1</td> <td>25 mV/ms</td> </tr> <tr> <td>1</td> <td>0</td> <td>0</td> <td>12.5 mV/ms</td> </tr> <tr> <td>1</td> <td>0</td> <td>1</td> <td>6.25 mV/ms</td> </tr> <tr> <td>1</td> <td>1</td> <td>0</td> <td>3.125 mV/ms</td> </tr> <tr> <td>1</td> <td>1</td> <td>1</td> <td>1.5625 mV/ms (4 LSB/ms)</td> </tr> </tbody> </table>	Bit 6	Bit 5	Bit 4	Maximum Slew Rate Duration	0	0	0	200 mV/ms	0	0	1	100 mV/ms	0	1	0	50 mV/ms	0	1	1	25 mV/ms	1	0	0	12.5 mV/ms	1	0	1	6.25 mV/ms	1	1	0	3.125 mV/ms	1	1	1	1.5625 mV/ms (4 LSB/ms)
Bit 6	Bit 5	Bit 4	Maximum Slew Rate Duration																																				
0	0	0	200 mV/ms																																				
0	0	1	100 mV/ms																																				
0	1	0	50 mV/ms																																				
0	1	1	25 mV/ms																																				
1	0	0	12.5 mV/ms																																				
1	0	1	6.25 mV/ms																																				
1	1	0	3.125 mV/ms																																				
1	1	1	1.5625 mV/ms (4 LSB/ms)																																				
3	Reserved	R/W	Reserved.																																				

Bits	Bit Name	R/W	Description																																				
[2:0]	Load line setting	R/W	<p>These bits specify how much the output voltage decreases from nominal at full load. The amount of output resistance introduced can be calculated as follows (these bits specify the value of N):</p> $R_{OUT} = 0.1 \times V_{OUT_NOM} \times CS2 \times R_{SENSE} / (CS2 \text{ Range} \times 2^N)$ <p>For more information, see the Digital Load Line and Slew Rate section.</p> <table border="1"> <thead> <tr> <th>Bit 2</th> <th>Bit 1</th> <th>Bit 0</th> <th>Impedance Setting</th> </tr> </thead> <tbody> <tr><td>0</td><td>0</td><td>0</td><td>Setting 0</td></tr> <tr><td>0</td><td>0</td><td>1</td><td>Setting 1</td></tr> <tr><td>0</td><td>1</td><td>0</td><td>Setting 2</td></tr> <tr><td>0</td><td>1</td><td>1</td><td>Setting 3</td></tr> <tr><td>1</td><td>0</td><td>0</td><td>Setting 4</td></tr> <tr><td>1</td><td>0</td><td>1</td><td>Setting 5</td></tr> <tr><td>1</td><td>1</td><td>0</td><td>Setting 6</td></tr> <tr><td>1</td><td>1</td><td>1</td><td>Setting 7</td></tr> </tbody> </table>	Bit 2	Bit 1	Bit 0	Impedance Setting	0	0	0	Setting 0	0	0	1	Setting 1	0	1	0	Setting 2	0	1	1	Setting 3	1	0	0	Setting 4	1	0	1	Setting 5	1	1	0	Setting 6	1	1	1	Setting 7
Bit 2	Bit 1	Bit 0	Impedance Setting																																				
0	0	0	Setting 0																																				
0	0	1	Setting 1																																				
0	1	0	Setting 2																																				
0	1	1	Setting 3																																				
1	0	0	Setting 4																																				
1	0	1	Setting 5																																				
1	1	0	Setting 6																																				
1	1	1	Setting 7																																				

Table 55. Register 0x37—Fast OVP Comparator

Bits	Bit Name	R/W	Description																												
[7:6]	Fast OVP debounce	R/W	<p>These bits set the fast OVP debounce time.</p> <table border="1"> <thead> <tr> <th rowspan="2">Bit 7</th> <th rowspan="2">Bit 6</th> <th colspan="3">Debounce Time (μs)</th> </tr> <tr> <th>Min</th> <th>Typ</th> <th>Max</th> </tr> </thead> <tbody> <tr><td>0</td><td>0</td><td>0</td><td>0</td><td>0</td></tr> <tr><td>0</td><td>1</td><td>0.64</td><td>0.96</td><td>1.28</td></tr> <tr><td>1</td><td>0</td><td>1.92</td><td>2.24</td><td>2.56</td></tr> <tr><td>1</td><td>1</td><td>7.98</td><td>8</td><td>8.32</td></tr> </tbody> </table>	Bit 7	Bit 6	Debounce Time (μ s)			Min	Typ	Max	0	0	0	0	0	0	1	0.64	0.96	1.28	1	0	1.92	2.24	2.56	1	1	7.98	8	8.32
Bit 7	Bit 6	Debounce Time (μ s)																													
		Min	Typ	Max																											
0	0	0	0	0																											
0	1	0.64	0.96	1.28																											
1	0	1.92	2.24	2.56																											
1	1	7.98	8	8.32																											
[5:0]	Fast OVP threshold	R/W	<p>These bits set the threshold for the fast OVP analog comparator. This threshold is programmable from 0.8 V to 1.6 V. Setting this value to 0x00 corresponds to a 0.8 V threshold. Setting this value to 0x3F corresponds to a 1.6 V threshold. Each LSB increments the threshold by 12.5 mV. The fast OVP threshold can be set using the following formula:</p> $Fast_OVP_Threshold = (Bits[5:0] \times 0.8 \text{ V}/63) + 0.8 \text{ V}$																												

Table 56. Register 0x38—VS1 Trim

Bits	Bit Name	R/W	Description
7	Trim polarity	R/W	<p>1 = negative gain is introduced. 0 = positive gain is introduced.</p>
[6:0]	VS1 trim	R/W	<p>These bits set the amount of gain trim that is applied to the VS1 ADC reading. This register trims the voltage at the VS1 pin for external resistor tolerances. When there is 1 V on the VS1 pin, this register is trimmed until the VS1 voltage value (Register 0x15[15:4]) reads 2560 (0xA00).</p>

Table 57. Register 0x39—VS2 Trim

Bits	Bit Name	R/W	Description
7	Trim polarity	R/W	<p>1 = negative gain is introduced. 0 = positive gain is introduced.</p>
[6:0]	VS2 trim	R/W	<p>These bits set the amount of gain trim that is applied to the VS2 ADC reading. This register trims the voltage at the VS2 pin for external resistor tolerances. When there is 1 V on the VS2 pin, this register is trimmed until the VS2 voltage value (Register 0x16[15:4]) reads 2560 (0xA00).</p>

Table 58. Register 0x3A—VS3 Trim

Bits	Bit Name	R/W	Description
7	Trim polarity	R/W	<p>1 = negative gain is introduced. 0 = positive gain is introduced.</p>
[6:0]	VS3 trim	R/W	<p>These bits set the amount of gain trim that is applied to the VS3 ADC reading. This register trims the voltage at the VS3 pins for external resistor tolerances. When there is 1 V on each VS3 pin, this register is trimmed until the VS3 voltage value (Register 0x17[15:4]) reads 2560 (0xA00). The VS3 trim must be performed before the load OVP and load UVP trims are performed.</p>

Table 59. Register 0x3B—Light Load Mode Disable Settings

Bits	Bit Name	R/W	Description																																																																						
7	Disable OUTAUX	R/W	Setting this bit means that OUTAUX is also disabled if the load current falls below the light load SR disable threshold.																																																																						
6	Disable OUTD	R/W	Setting this bit means that OUTD is also disabled if the load current falls below the light load SR disable threshold.																																																																						
5	Disable OUTC	R/W	Setting this bit means that OUTC is also disabled if the load current falls below the light load SR disable threshold.																																																																						
4	Disable OUTB	R/W	Setting this bit means that OUTB is also disabled if the load current falls below the light load SR disable threshold.																																																																						
3	Disable OUTA	R/W	Setting this bit means that OUTA is also disabled if the load current falls below the light load SR disable threshold.																																																																						
[2:0]	Light load SR disable	R/W	<p>These bits set the load current limit on the CS2 ADC below which the synchronous rectifier outputs (SR1 and SR2) are disabled. This value also determines the point at which the power supply goes into light load mode and the light load mode filter is used. This value is programmable as a percentage of the CS2 ADC full scale (either 60 mV or 120 mV). The hysteresis and the averaging speed are programmable in Register 0x7D.</p> <table border="1"> <thead> <tr> <th colspan="3"></th> <th colspan="4">Light Load Threshold as % of Full Scale</th> </tr> <tr> <th>Bit 2</th> <th>Bit 1</th> <th>Bit 0</th> <th>37.5 μs</th> <th>75 μs</th> <th>150 μs</th> <th>300 μs</th> </tr> </thead> <tbody> <tr> <td>0</td> <td>0</td> <td>0</td> <td>0%</td> <td>0%</td> <td>0%</td> <td>0%</td> </tr> <tr> <td>0</td> <td>0</td> <td>1</td> <td>7.81%</td> <td>3.91%</td> <td>1.95%</td> <td>0.98%</td> </tr> <tr> <td>0</td> <td>1</td> <td>0</td> <td>15.63%</td> <td>7.81%</td> <td>3.91%</td> <td>1.95%</td> </tr> <tr> <td>0</td> <td>1</td> <td>1</td> <td>23.44%</td> <td>11.72%</td> <td>5.86%</td> <td>2.93%</td> </tr> <tr> <td>1</td> <td>0</td> <td>0</td> <td>31.25%</td> <td>15.63%</td> <td>7.81%</td> <td>3.91%</td> </tr> <tr> <td>1</td> <td>0</td> <td>1</td> <td>39.06%</td> <td>19.53%</td> <td>9.77%</td> <td>4.88%</td> </tr> <tr> <td>1</td> <td>1</td> <td>0</td> <td>46.88%</td> <td>23.44%</td> <td>11.72%</td> <td>5.86%</td> </tr> <tr> <td>1</td> <td>1</td> <td>1</td> <td>54.69%</td> <td>27.34%</td> <td>13.67%</td> <td>6.84%</td> </tr> </tbody> </table>				Light Load Threshold as % of Full Scale				Bit 2	Bit 1	Bit 0	37.5 μ s	75 μ s	150 μ s	300 μ s	0	0	0	0%	0%	0%	0%	0	0	1	7.81%	3.91%	1.95%	0.98%	0	1	0	15.63%	7.81%	3.91%	1.95%	0	1	1	23.44%	11.72%	5.86%	2.93%	1	0	0	31.25%	15.63%	7.81%	3.91%	1	0	1	39.06%	19.53%	9.77%	4.88%	1	1	0	46.88%	23.44%	11.72%	5.86%	1	1	1	54.69%	27.34%	13.67%	6.84%
			Light Load Threshold as % of Full Scale																																																																						
Bit 2	Bit 1	Bit 0	37.5 μ s	75 μ s	150 μ s	300 μ s																																																																			
0	0	0	0%	0%	0%	0%																																																																			
0	0	1	7.81%	3.91%	1.95%	0.98%																																																																			
0	1	0	15.63%	7.81%	3.91%	1.95%																																																																			
0	1	1	23.44%	11.72%	5.86%	2.93%																																																																			
1	0	0	31.25%	15.63%	7.81%	3.91%																																																																			
1	0	1	39.06%	19.53%	9.77%	4.88%																																																																			
1	1	0	46.88%	23.44%	11.72%	5.86%																																																																			
1	1	1	54.69%	27.34%	13.67%	6.84%																																																																			

ID REGISTERS

Table 60. Register 0x3C—Silicon Revision ID

Bits	Bit Name	R/W	Description
[7:0]	Silicon revision	R	This register contains the manufacturer's silicon revision code for the device. This value is used by the manufacturer for tracking purposes.

Table 61. Register 0x3D—Manufacturer ID

Bits	Bit Name	R/W	Description
[7:0]	Manufacturer ID code	R	This register contains the manufacturer's ID code for the device. It is used by the manufacturer for test purposes and should not be read from in normal operation. This value is hardwired to 0x41 to represent the Analog Devices ID code.

Table 62. Register 0x3E—Device ID

Bits	Bit Name	R/W	Description
[7:0]	Device ID code	R	This register contains the ID code for the device. This value is hardwired to 0x46 to represent the ADP1046AW .

PWM AND SYNCHRONOUS RECTIFIER TIMING REGISTERS

Figure 57 and Table 63 to Table 93 describe the implementation and programming of the seven PWM signals that are output from the ADP1046AW. In general, it is recommended that t_1 be set to 0 and that t_1 be set as the reference point for the other signals.

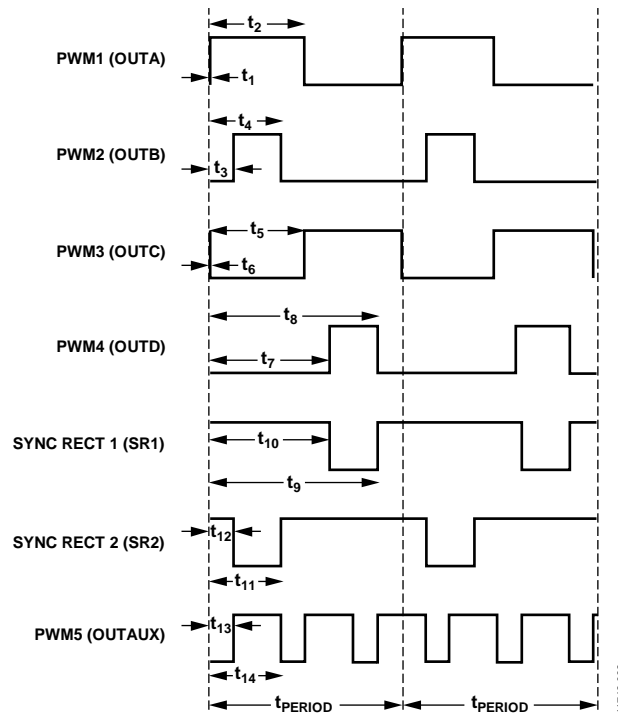

Figure 57. PWM Timing Diagram

Table 63. Register 0x3F—OUTAUX Switching Frequency Setting

Bits	Bit Name	R/W	Description				
7	Pulse skipping	R/W	Setting this bit enables pulse skipping mode. If the ADP1046AW requires a duty cycle lower than the modulation low limit, pulse skipping is enabled.				
6	Pulse skipping zero PWM	R/W	0 = pulse skipping drives all modulated PWM outputs to 0 V. 1 = sets all modulated edges to $t = 0$ (the crossing rule set in Register 0x52[0] applies).				
[5:0]	Switching frequency	R/W	This register sets the switching frequency of the OUTAUX signal.				
	Bit 5	Bit 4	Bit 3	Bit 2	Bit 1	Bit 0	Frequency (kHz)
	0	0	0	0	0	0	48.83
	0	0	0	0	0	1	50.40
	0	0	0	0	1	0	52.08
	0	0	0	0	1	1	53.88
	0	0	0	1	0	0	55.80
	0	0	0	1	0	1	57.87
	0	0	0	1	1	0	60.1
	0	0	0	1	1	1	62.5
	0	0	1	0	0	0	65.1
	0	0	1	0	0	1	67.93
	0	0	1	0	1	0	71.02
	0	0	1	0	1	1	74.4
	0	0	1	1	0	0	78.13
	0	0	1	1	0	1	82.24
	0	0	1	1	1	0	86.81
	0	0	1	1	1	1	91.91
	0	1	0	0	0	0	97.66
	0	1	0	0	0	1	100.81
	0	1	0	0	1	0	104.17

Bits	Bit Name	R/W	Description						Frequency (kHz)
			Bit 5	Bit 4	Bit 3	Bit 2	Bit 1	Bit 0	
[5:0]	Switching frequency	R/W	0	1	0	0	1	1	107.76
0			1	0	1	0	0	111.61	
0			1	0	1	0	1	115.74	
0			1	0	1	0	1	120.19	
0			1	0	1	0	1	125.0	
0			1	1	0	0	0	130.21	
0			1	1	0	0	1	135.87	
0			1	1	0	1	0	142.05	
0			1	1	0	1	1	148.81	
0			1	1	1	1	0	156.25	
0			1	1	1	1	0	164.47	
0			1	1	1	1	1	173.61	
0			1	1	1	1	1	183.82	
1			0	0	0	0	0	195.31	
1			0	0	0	0	0	201.61	
1			0	0	0	0	1	208.33	
1			0	0	0	0	1	215.52	
1			0	0	0	1	0	223.21	
1			0	0	0	1	0	231.48	
1			0	0	0	1	1	240.38	
1			0	0	0	1	1	250	
1			0	1	0	0	0	260.42	
1			0	1	0	0	1	271.42	
1			0	1	0	1	0	284.09	
1			0	1	0	1	1	297.62	
1			0	1	1	0	0	312.5	
1			0	1	1	1	0	328.95	
1			0	1	1	1	1	347.22	
1			0	1	1	1	1	367.65	
1			1	0	0	0	0	390.63	
1			1	0	0	0	1	416.67	
1			1	0	0	1	0	446.43	
1	1	0	0	1	1	480.77			
1	1	0	1	0	0	520.83			
1	1	0	1	0	1	568.18			
1	1	0	1	1	0	625			

Table 64. Register 0x40—PWM Switching Frequency Setting

Bits	Bit Name	R/W	Description																																																																																																																																																																																																																																																																																																																																																														
[7:6]	Reserved	R/W	Reserved.																																																																																																																																																																																																																																																																																																																																																														
[5:0]	Switching frequency	R/W	This register sets the switching frequency of all the PWM pins other than the OUTAUX pin.																																																																																																																																																																																																																																																																																																																																																														
			<table border="1"> <thead> <tr> <th>Bit 5</th> <th>Bit 4</th> <th>Bit 3</th> <th>Bit 2</th> <th>Bit 1</th> <th>Bit 0</th> <th>Frequency (kHz)</th> </tr> </thead> <tbody> <tr><td>0</td><td>0</td><td>0</td><td>0</td><td>0</td><td>0</td><td>48.83</td></tr> <tr><td>0</td><td>0</td><td>0</td><td>0</td><td>0</td><td>1</td><td>50.40</td></tr> <tr><td>0</td><td>0</td><td>0</td><td>0</td><td>1</td><td>0</td><td>52.08</td></tr> <tr><td>0</td><td>0</td><td>0</td><td>0</td><td>1</td><td>1</td><td>53.88</td></tr> <tr><td>0</td><td>0</td><td>0</td><td>1</td><td>0</td><td>0</td><td>55.80</td></tr> <tr><td>0</td><td>0</td><td>0</td><td>1</td><td>0</td><td>1</td><td>57.87</td></tr> <tr><td>0</td><td>0</td><td>0</td><td>1</td><td>1</td><td>0</td><td>60.1</td></tr> <tr><td>0</td><td>0</td><td>0</td><td>1</td><td>1</td><td>1</td><td>62.5</td></tr> <tr><td>0</td><td>0</td><td>1</td><td>0</td><td>0</td><td>0</td><td>65.1</td></tr> <tr><td>0</td><td>0</td><td>1</td><td>0</td><td>0</td><td>1</td><td>67.93</td></tr> <tr><td>0</td><td>0</td><td>1</td><td>0</td><td>1</td><td>0</td><td>71.02</td></tr> <tr><td>0</td><td>0</td><td>1</td><td>0</td><td>1</td><td>1</td><td>74.4</td></tr> <tr><td>0</td><td>0</td><td>1</td><td>1</td><td>0</td><td>0</td><td>78.13</td></tr> <tr><td>0</td><td>0</td><td>1</td><td>1</td><td>0</td><td>1</td><td>82.24</td></tr> <tr><td>0</td><td>0</td><td>1</td><td>1</td><td>1</td><td>0</td><td>86.81</td></tr> <tr><td>0</td><td>0</td><td>1</td><td>1</td><td>1</td><td>1</td><td>91.91</td></tr> <tr><td>0</td><td>1</td><td>0</td><td>0</td><td>0</td><td>0</td><td>97.66</td></tr> <tr><td>0</td><td>1</td><td>0</td><td>0</td><td>0</td><td>1</td><td>100.81</td></tr> <tr><td>0</td><td>1</td><td>0</td><td>0</td><td>1</td><td>0</td><td>104.17</td></tr> <tr><td>0</td><td>1</td><td>0</td><td>0</td><td>1</td><td>1</td><td>107.76</td></tr> <tr><td>0</td><td>1</td><td>0</td><td>1</td><td>0</td><td>0</td><td>111.61</td></tr> <tr><td>0</td><td>1</td><td>0</td><td>1</td><td>0</td><td>1</td><td>115.74</td></tr> <tr><td>0</td><td>1</td><td>0</td><td>1</td><td>1</td><td>0</td><td>120.19</td></tr> <tr><td>0</td><td>1</td><td>0</td><td>1</td><td>1</td><td>1</td><td>125.0</td></tr> <tr><td>0</td><td>1</td><td>1</td><td>0</td><td>0</td><td>0</td><td>130.21</td></tr> <tr><td>0</td><td>1</td><td>1</td><td>0</td><td>0</td><td>1</td><td>135.87</td></tr> <tr><td>0</td><td>1</td><td>1</td><td>0</td><td>1</td><td>0</td><td>142.05</td></tr> <tr><td>0</td><td>1</td><td>1</td><td>0</td><td>1</td><td>1</td><td>148.81</td></tr> <tr><td>0</td><td>1</td><td>1</td><td>1</td><td>0</td><td>0</td><td>156.25</td></tr> <tr><td>0</td><td>1</td><td>1</td><td>1</td><td>0</td><td>1</td><td>164.47</td></tr> <tr><td>0</td><td>1</td><td>1</td><td>1</td><td>1</td><td>0</td><td>173.61</td></tr> <tr><td>0</td><td>1</td><td>1</td><td>1</td><td>1</td><td>1</td><td>183.82</td></tr> <tr><td>1</td><td>0</td><td>0</td><td>0</td><td>0</td><td>0</td><td>195.31</td></tr> <tr><td>1</td><td>0</td><td>0</td><td>0</td><td>0</td><td>1</td><td>201.61</td></tr> <tr><td>1</td><td>0</td><td>0</td><td>0</td><td>1</td><td>0</td><td>208.33</td></tr> <tr><td>1</td><td>0</td><td>0</td><td>0</td><td>1</td><td>1</td><td>215.52</td></tr> <tr><td>1</td><td>0</td><td>0</td><td>1</td><td>0</td><td>0</td><td>223.21</td></tr> <tr><td>1</td><td>0</td><td>0</td><td>1</td><td>0</td><td>1</td><td>231.48</td></tr> <tr><td>1</td><td>0</td><td>0</td><td>1</td><td>1</td><td>0</td><td>240.38</td></tr> <tr><td>1</td><td>0</td><td>0</td><td>1</td><td>1</td><td>1</td><td>250</td></tr> <tr><td>1</td><td>0</td><td>1</td><td>0</td><td>0</td><td>0</td><td>260.42</td></tr> <tr><td>1</td><td>0</td><td>1</td><td>0</td><td>0</td><td>1</td><td>271.42</td></tr> <tr><td>1</td><td>0</td><td>1</td><td>0</td><td>1</td><td>0</td><td>284.09</td></tr> <tr><td>1</td><td>0</td><td>1</td><td>0</td><td>1</td><td>1</td><td>297.62</td></tr> <tr><td>1</td><td>0</td><td>1</td><td>1</td><td>0</td><td>0</td><td>312.5</td></tr> <tr><td>1</td><td>0</td><td>1</td><td>1</td><td>0</td><td>1</td><td>328.95</td></tr> <tr><td>1</td><td>0</td><td>1</td><td>1</td><td>1</td><td>0</td><td>347.22</td></tr> <tr><td>1</td><td>0</td><td>1</td><td>1</td><td>1</td><td>1</td><td>367.65</td></tr> <tr><td>1</td><td>1</td><td>0</td><td>0</td><td>0</td><td>0</td><td>390.63</td></tr> </tbody> </table>	Bit 5	Bit 4	Bit 3	Bit 2	Bit 1	Bit 0	Frequency (kHz)	0	0	0	0	0	0	48.83	0	0	0	0	0	1	50.40	0	0	0	0	1	0	52.08	0	0	0	0	1	1	53.88	0	0	0	1	0	0	55.80	0	0	0	1	0	1	57.87	0	0	0	1	1	0	60.1	0	0	0	1	1	1	62.5	0	0	1	0	0	0	65.1	0	0	1	0	0	1	67.93	0	0	1	0	1	0	71.02	0	0	1	0	1	1	74.4	0	0	1	1	0	0	78.13	0	0	1	1	0	1	82.24	0	0	1	1	1	0	86.81	0	0	1	1	1	1	91.91	0	1	0	0	0	0	97.66	0	1	0	0	0	1	100.81	0	1	0	0	1	0	104.17	0	1	0	0	1	1	107.76	0	1	0	1	0	0	111.61	0	1	0	1	0	1	115.74	0	1	0	1	1	0	120.19	0	1	0	1	1	1	125.0	0	1	1	0	0	0	130.21	0	1	1	0	0	1	135.87	0	1	1	0	1	0	142.05	0	1	1	0	1	1	148.81	0	1	1	1	0	0	156.25	0	1	1	1	0	1	164.47	0	1	1	1	1	0	173.61	0	1	1	1	1	1	183.82	1	0	0	0	0	0	195.31	1	0	0	0	0	1	201.61	1	0	0	0	1	0	208.33	1	0	0	0	1	1	215.52	1	0	0	1	0	0	223.21	1	0	0	1	0	1	231.48	1	0	0	1	1	0	240.38	1	0	0	1	1	1	250	1	0	1	0	0	0	260.42	1	0	1	0	0	1	271.42	1	0	1	0	1	0	284.09	1	0	1	0	1	1	297.62	1	0	1	1	0	0	312.5	1	0	1	1	0	1	328.95	1	0	1	1	1	0	347.22	1	0	1	1	1	1	367.65	1	1	0	0	0	0	390.63
Bit 5	Bit 4	Bit 3	Bit 2	Bit 1	Bit 0	Frequency (kHz)																																																																																																																																																																																																																																																																																																																																																											
0	0	0	0	0	0	48.83																																																																																																																																																																																																																																																																																																																																																											
0	0	0	0	0	1	50.40																																																																																																																																																																																																																																																																																																																																																											
0	0	0	0	1	0	52.08																																																																																																																																																																																																																																																																																																																																																											
0	0	0	0	1	1	53.88																																																																																																																																																																																																																																																																																																																																																											
0	0	0	1	0	0	55.80																																																																																																																																																																																																																																																																																																																																																											
0	0	0	1	0	1	57.87																																																																																																																																																																																																																																																																																																																																																											
0	0	0	1	1	0	60.1																																																																																																																																																																																																																																																																																																																																																											
0	0	0	1	1	1	62.5																																																																																																																																																																																																																																																																																																																																																											
0	0	1	0	0	0	65.1																																																																																																																																																																																																																																																																																																																																																											
0	0	1	0	0	1	67.93																																																																																																																																																																																																																																																																																																																																																											
0	0	1	0	1	0	71.02																																																																																																																																																																																																																																																																																																																																																											
0	0	1	0	1	1	74.4																																																																																																																																																																																																																																																																																																																																																											
0	0	1	1	0	0	78.13																																																																																																																																																																																																																																																																																																																																																											
0	0	1	1	0	1	82.24																																																																																																																																																																																																																																																																																																																																																											
0	0	1	1	1	0	86.81																																																																																																																																																																																																																																																																																																																																																											
0	0	1	1	1	1	91.91																																																																																																																																																																																																																																																																																																																																																											
0	1	0	0	0	0	97.66																																																																																																																																																																																																																																																																																																																																																											
0	1	0	0	0	1	100.81																																																																																																																																																																																																																																																																																																																																																											
0	1	0	0	1	0	104.17																																																																																																																																																																																																																																																																																																																																																											
0	1	0	0	1	1	107.76																																																																																																																																																																																																																																																																																																																																																											
0	1	0	1	0	0	111.61																																																																																																																																																																																																																																																																																																																																																											
0	1	0	1	0	1	115.74																																																																																																																																																																																																																																																																																																																																																											
0	1	0	1	1	0	120.19																																																																																																																																																																																																																																																																																																																																																											
0	1	0	1	1	1	125.0																																																																																																																																																																																																																																																																																																																																																											
0	1	1	0	0	0	130.21																																																																																																																																																																																																																																																																																																																																																											
0	1	1	0	0	1	135.87																																																																																																																																																																																																																																																																																																																																																											
0	1	1	0	1	0	142.05																																																																																																																																																																																																																																																																																																																																																											
0	1	1	0	1	1	148.81																																																																																																																																																																																																																																																																																																																																																											
0	1	1	1	0	0	156.25																																																																																																																																																																																																																																																																																																																																																											
0	1	1	1	0	1	164.47																																																																																																																																																																																																																																																																																																																																																											
0	1	1	1	1	0	173.61																																																																																																																																																																																																																																																																																																																																																											
0	1	1	1	1	1	183.82																																																																																																																																																																																																																																																																																																																																																											
1	0	0	0	0	0	195.31																																																																																																																																																																																																																																																																																																																																																											
1	0	0	0	0	1	201.61																																																																																																																																																																																																																																																																																																																																																											
1	0	0	0	1	0	208.33																																																																																																																																																																																																																																																																																																																																																											
1	0	0	0	1	1	215.52																																																																																																																																																																																																																																																																																																																																																											
1	0	0	1	0	0	223.21																																																																																																																																																																																																																																																																																																																																																											
1	0	0	1	0	1	231.48																																																																																																																																																																																																																																																																																																																																																											
1	0	0	1	1	0	240.38																																																																																																																																																																																																																																																																																																																																																											
1	0	0	1	1	1	250																																																																																																																																																																																																																																																																																																																																																											
1	0	1	0	0	0	260.42																																																																																																																																																																																																																																																																																																																																																											
1	0	1	0	0	1	271.42																																																																																																																																																																																																																																																																																																																																																											
1	0	1	0	1	0	284.09																																																																																																																																																																																																																																																																																																																																																											
1	0	1	0	1	1	297.62																																																																																																																																																																																																																																																																																																																																																											
1	0	1	1	0	0	312.5																																																																																																																																																																																																																																																																																																																																																											
1	0	1	1	0	1	328.95																																																																																																																																																																																																																																																																																																																																																											
1	0	1	1	1	0	347.22																																																																																																																																																																																																																																																																																																																																																											
1	0	1	1	1	1	367.65																																																																																																																																																																																																																																																																																																																																																											
1	1	0	0	0	0	390.63																																																																																																																																																																																																																																																																																																																																																											

Bits	Bit Name	R/W	Description						
			Bit 5	Bit 4	Bit 3	Bit 2	Bit 1	Bit 0	Frequency (kHz)
[5:0]	Switching frequency	R/W	1	1	0	0	0	1	416.67
			1	1	0	0	1	0	446.43
			1	1	0	0	1	1	480.77
			1	1	0	1	0	0	520.83
			1	1	0	1	0	1	568.18
			1	1	0	1	1	0	625
			1	1	1	1	1	1	Resonant mode

Table 65. Register 0x41—OUTA Rising Edge Timing (OUTA Pin)

Bits	Bit Name	R/W	Description
[7:0]	t ₁	R/W	This register contains the eight MSBs of the 12-bit t ₁ time. This value is always used with the top four bits of Register 0x42, which contains the four LSBs of the t ₁ time. Each LSB corresponds to 5 ns resolution. The entire switching period is divided into 40 ns time steps. If the t _{Rx} and t _{Fx} of a PWM edge occur within the same 40 ns time step, the PWM output is 0 V. If the t _{Rx} and t _{Fx} occur in different 40 ns time steps, the PWM output is set to the programmed value. The absolute maximum pulse width is t _{PERIOD} – 5 ns.

Table 66. Register 0x42—OUTA Rising Edge Setting (OUTA Pin)

Bits	Bit Name	R/W	Description
[7:4]	t ₁	R/W	These bits contain the four LSBs of the 12-bit t ₁ time. This value is always used with the eight bits of Register 0x41, which contains the eight MSBs of the t ₁ time. Each LSB corresponds to 5 ns resolution. The entire switching period is divided into 40 ns time steps. If the t _{Rx} and t _{Fx} of a PWM edge occur within the same 40 ns time step, the PWM output is 0 V. If the t _{Rx} and t _{Fx} occur in different 40 ns time steps, the PWM output is set to the programmed value. The absolute maximum pulse width is t _{PERIOD} – 5 ns.
3	Modulate enable	R/W	1 = PWM modulation acts on the t ₁ edge. 0 = no PWM modulation of the t ₁ edge.
2	t ₁ sign	R/W	1 = negative sign. Increase of PWM modulation moves t ₁ right. 0 = positive sign. Increase of PWM modulation moves t ₁ left.
1	Reserved	R/W	Reserved.
0	Volt-second balance source selection	R/W	If this bit is set to 1, the OUTA rising edge is selected as the start of the integration period for volt-second balance.

Table 67. Register 0x43—OUTA Falling Edge Timing (OUTA Pin)

Bits	Bit Name	R/W	Description
[7:0]	t ₂	R/W	This register contains the eight MSBs of the 12-bit t ₂ time. This value is always used with the top four bits of Register 0x44, which contains the four LSBs of the t ₂ time. Each LSB corresponds to 5 ns resolution. The entire switching period is divided into 40 ns time steps. If the t _{Rx} and t _{Fx} of a PWM edge occur within the same 40 ns time step, the PWM output is 0 V. If the t _{Rx} and t _{Fx} occur in different 40 ns time steps, the PWM output is set to the programmed value. The absolute maximum pulse width is t _{PERIOD} – 5 ns.

Table 68. Register 0x44—OUTA Falling Edge Setting (OUTA Pin)

Bits	Bit Name	R/W	Description
[7:4]	t ₂	R/W	These bits contain the four LSBs of the 12-bit t ₂ time. This value is always used with the eight bits of Register 0x43, which contains the eight MSBs of the t ₂ time. Each LSB corresponds to 5 ns resolution. The entire switching period is divided into 40 ns time steps. If the t _{Rx} and t _{Fx} of a PWM edge occur within the same 40 ns time step, the PWM output is 0 V. If the t _{Rx} and t _{Fx} occur in different 40 ns time steps, the PWM output is set to the programmed value. The absolute maximum pulse width is t _{PERIOD} – 5 ns.
3	Modulate enable	R/W	1 = PWM modulation acts on the t ₂ edge. 0 = no PWM modulation of the t ₂ edge.
2	t ₂ sign	R/W	1 = negative sign. Increase of PWM modulation moves t ₂ right. 0 = positive sign. Increase of PWM modulation moves t ₂ left.
[1:0]	Reserved	R/W	Reserved.

Table 69. Register 0x45—OUTB Rising Edge Timing (OUTB Pin)

Bits	Bit Name	R/W	Description
[7:0]	t_3	R/W	This register contains the eight MSBs of the 12-bit t_3 time. This value is always used with the top four bits of Register 0x46, which contains the four LSBs of the t_3 time. Each LSB corresponds to 5 ns resolution. The entire switching period is divided into 40 ns time steps. If the t_{RX} and t_{FX} of a PWM edge occur within the same 40 ns time step, the PWM output is 0 V. If the t_{RX} and t_{FX} occur in different 40 ns time steps, the PWM output is set to the programmed value. The absolute maximum pulse width is $t_{PERIOD} - 5$ ns.

Table 70. Register 0x46—OUTB Rising Edge Setting (OUTB Pin)

Bits	Bit Name	R/W	Description
[7:4]	t_3	R/W	These bits contain the four LSBs of the 12-bit t_3 time. This value is always used with the eight bits of Register 0x45, which contains the eight MSBs of the t_3 time. Each LSB corresponds to 5 ns resolution. The entire switching period is divided into 40 ns time steps. If the t_{RX} and t_{FX} of a PWM edge occur within the same 40 ns time step, the PWM output is 0 V. If the t_{RX} and t_{FX} occur in different 40 ns time steps, the PWM output is set to the programmed value. The absolute maximum pulse width is $t_{PERIOD} - 5$ ns.
3	Modulate enable	R/W	1 = PWM modulation acts on the t_3 edge. 0 = no PWM modulation of the t_3 edge.
2	t_3 sign	R/W	1 = negative sign. Increase of PWM modulation moves t_3 right. 0 = positive sign. Increase of PWM modulation moves t_3 left.
1	Reserved	R/W	Reserved.
0	Volt-second balance source selection	R/W	If this bit is set to 1, the OUTB rising edge is selected as the start of the integration period for volt-second balance.

Table 71. Register 0x47—OUTB Falling Edge Timing (OUTB Pin)

Bits	Bit Name	R/W	Description
[7:0]	t_4	R/W	This register contains the eight MSBs of the 12-bit t_4 time. This value is always used with the top four bits of Register 0x48, which contains the four LSBs of the t_4 time. Each LSB corresponds to 5 ns resolution. The entire switching period is divided into 40 ns time steps. If the t_{RX} and t_{FX} of a PWM edge occur within the same 40 ns time step, the PWM output is 0 V. If the t_{RX} and t_{FX} occur in different 40 ns time steps, the PWM output is set to the programmed value. The absolute maximum pulse width is $t_{PERIOD} - 5$ ns.

Table 72. Register 0x48—OUTB Falling Edge Setting (OUTB Pin)

Bits	Bit Name	R/W	Description
[7:4]	t_4	R/W	These bits contain the four LSBs of the 12-bit t_4 time. This value is always used with the eight bits of Register 0x47, which contains the eight MSBs of the t_4 time. Each LSB corresponds to 5 ns resolution. The entire switching period is divided into 40 ns time steps. If the t_{RX} and t_{FX} of a PWM edge occur within the same 40 ns time step, the PWM output is 0 V. If the t_{RX} and t_{FX} occur in different 40 ns time steps, the PWM output is set to the programmed value. The absolute maximum pulse width is $t_{PERIOD} - 5$ ns.
3	Modulate enable	R/W	1 = PWM modulation acts on the t_4 edge. 0 = no PWM modulation of the t_4 edge.
2	t_4 sign	R/W	1 = negative sign. Increase of PWM modulation moves t_4 right. 0 = positive sign. Increase of PWM modulation moves t_4 left.
[1:0]	Reserved	R/W	Reserved.

Table 73. Register 0x49—OUTC Rising Edge Timing (OUTC Pin)

Bits	Bit Name	R/W	Description
[7:0]	t_5	R/W	This register contains the eight MSBs of the 12-bit t_5 time. This value is always used with the top four bits of Register 0x4A, which contains the four LSBs of the t_5 time. Each LSB corresponds to 5 ns resolution. The entire switching period is divided into 40 ns time steps. If the t_{RX} and t_{FX} of a PWM edge occur within the same 40 ns time step, the PWM output is 0 V. If the t_{RX} and t_{FX} occur in different 40 ns time steps, the PWM output is set to the programmed value. The absolute maximum pulse width is $t_{PERIOD} - 5$ ns.

Table 74. Register 0x4A—OUTC Rising Edge Setting (OUTC Pin)

Bits	Bit Name	R/W	Description
[7:4]	t_5	R/W	These bits contain the four LSBs of the 12-bit t_5 time. This value is always used with the eight bits of Register 0x49, which contains the eight MSBs of the t_5 time. Each LSB corresponds to 5 ns resolution. The entire switching period is divided into 40 ns time steps. If the t_{RX} and t_{FX} of a PWM edge occur within the same 40 ns time step, the PWM output is 0 V. If the t_{RX} and t_{FX} occur in different 40 ns time steps, the PWM output is set to the programmed value. The absolute maximum pulse width is $t_{PERIOD} - 5$ ns.
3	Modulate enable	R/W	1 = PWM modulation acts on the t_5 edge. 0 = no PWM modulation of the t_5 edge.
2	t_5 sign	R/W	1 = negative sign. Increase of PWM modulation moves t_5 right. 0 = positive sign. Increase of PWM modulation moves t_5 left.
1	Reserved	R/W	Reserved.
0	Volt-second balance source selection	R/W	If this bit is set to 1, the OUTC rising edge is selected as the start of the integration period for volt-second balance.

Table 75. Register 0x4B—OUTC Falling Edge Timing (OUTC Pin)

Bits	Bit Name	R/W	Description
[7:0]	t_6	R/W	This register contains the eight MSBs of the 12-bit t_6 time. This value is always used with the top four bits of Register 0x4C, which contains the four LSBs of the t_6 time. Each LSB corresponds to 5 ns resolution. The entire switching period is divided into 40 ns time steps. If the t_{RX} and t_{FX} of a PWM edge occur within the same 40 ns time step, the PWM output is 0 V. If the t_{RX} and t_{FX} occur in different 40 ns time steps, the PWM output is set to the programmed value. The absolute maximum pulse width is $t_{PERIOD} - 5$ ns.

Table 76. Register 0x4C—OUTC Falling Edge Setting (OUTC Pin)

Bits	Bit Name	R/W	Description
[7:4]	t_6	R/W	These bits contain the four LSBs of the 12-bit t_6 time. This value is always used with the eight bits of Register 0x4B, which contains the eight MSBs of the t_6 time. Each LSB corresponds to 5 ns resolution. The entire switching period is divided into 40 ns time steps. If the t_{RX} and t_{FX} of a PWM edge occur within the same 40 ns time step, the PWM output is 0 V. If the t_{RX} and t_{FX} occur in different 40 ns time steps, the PWM output is set to the programmed value. The absolute maximum pulse width is $t_{PERIOD} - 5$ ns.
3	Modulate enable	R/W	1 = PWM modulation acts on the t_6 edge. 0 = no PWM modulation of the t_6 edge.
2	t_6 sign	R/W	1 = negative sign. Increase of PWM modulation moves t_6 right. 0 = positive sign. Increase of PWM modulation moves t_6 left.
[1:0]	Reserved	R/W	Reserved.

Table 77. Register 0x4D—OUTD Rising Edge Timing (OUTD Pin)

Bits	Bit Name	R/W	Description
[7:0]	t_7	R/W	This register contains the eight MSBs of the 12-bit t_7 time. This value is always used with the top four bits of Register 0x4E, which contains the four LSBs of the t_7 time. Each LSB corresponds to 5 ns resolution. The entire switching period is divided into 40 ns time steps. If the t_{RX} and t_{FX} of a PWM edge occur within the same 40 ns time step, the PWM output is 0 V. If the t_{RX} and t_{FX} occur in different 40 ns time steps, the PWM output is set to the programmed value. The absolute maximum pulse width is $t_{PERIOD} - 5$ ns.

Table 78. Register 0x4E—OUTD Rising Edge Setting (OUTD Pin)

Bits	Bit Name	R/W	Description
[7:4]	t_7	R/W	These bits contain the four LSBs of the 12-bit t_7 time. This value is always used with the eight bits of Register 0x4D, which contains the eight MSBs of the t_7 time. Each LSB corresponds to 5 ns resolution. The entire switching period is divided into 40 ns time steps. If the t_{RX} and t_{FX} of a PWM edge occur within the same 40 ns time step, the PWM output is 0 V. If the t_{RX} and t_{FX} occur in different 40 ns time steps, the PWM output is set to the programmed value. The absolute maximum pulse width is $t_{PERIOD} - 5$ ns.
3	Modulate enable	R/W	1 = PWM modulation acts on the t_7 edge. 0 = no PWM modulation of the t_7 edge.
2	t_7 sign	R/W	1 = negative sign. Increase of PWM modulation moves t_7 right. 0 = positive sign. Increase of PWM modulation moves t_7 left.
1	Reserved	R/W	Reserved.
0	Volt-second balance source selection	R/W	If this bit is set to 1, the OUTD rising edge is selected as the start of the integration period for volt-second balance.

Table 79. Register 0x4F—OUTD Falling Edge Timing (OUTD Pin)

Bits	Bit Name	R/W	Description
[7:0]	t_8	R/W	This register contains the eight MSBs of the 12-bit t_8 time. This value is always used with the top four bits of Register 0x50, which contains the four LSBs of the t_8 time. Each LSB corresponds to 5 ns resolution. The entire switching period is divided into 40 ns time steps. If the t_{RX} and t_{FX} of a PWM edge occur within the same 40 ns time step, the PWM output is 0 V. If the t_{RX} and t_{FX} occur in different 40 ns time steps, the PWM output is set to the programmed value. The absolute maximum pulse width is $t_{PERIOD} - 5$ ns.

Table 80. Register 0x50—OUTD Falling Edge Setting (OUTD Pin)

Bits	Bit Name	R/W	Description
[7:4]	t_8	R/W	These bits contain the four LSBs of the 12-bit t_8 time. This value is always used with the eight bits of Register 0x4F, which contains the eight MSBs of the t_8 time. Each LSB corresponds to 5 ns resolution. The entire switching period is divided into 40 ns time steps. If the t_{RX} and t_{FX} of a PWM edge occur within the same 40 ns time step, the PWM output is 0 V. If the t_{RX} and t_{FX} occur in different 40 ns time steps, the PWM output is set to the programmed value. The absolute maximum pulse width is $t_{PERIOD} - 5$ ns.
3	Modulate enable	R/W	1 = PWM modulation acts on the t_8 edge. 0 = no PWM modulation of the t_8 edge.
2	t_8 sign	R/W	1 = negative sign. Increase of PWM modulation moves t_8 right. 0 = positive sign. Increase of PWM modulation moves t_8 left.
[1:0]	Reserved	R/W	Reserved.

Table 81. Register 0x51—SR1 Rising Edge Timing (SR1 Pin)

Bits	Bit Name	R/W	Description
[7:0]	t_9	R/W	This register contains the eight MSBs of the 12-bit t_9 time. This value is always used with the top four bits of Register 0x52, which contains the four LSBs of the t_9 time. Each LSB corresponds to 5 ns resolution. The entire switching period is divided into 40 ns time steps. If the t_{RX} and t_{FX} of a PWM edge occur within the same 40 ns time step, the PWM output is 0 V. If the t_{RX} and t_{FX} occur in different 40 ns time steps, the PWM output is set to the programmed value. The absolute maximum pulse width is $t_{PERIOD} - 5$ ns. It is recommended that the SR1 rising edge not be set between 80 ns and 115 ns when using the SR soft start.

Table 82. Register 0x52—SR1 Rising Edge Setting (SR1 Pin)

Bits	Bit Name	R/W	Description
[7:4]	t_9	R/W	These bits contain the four LSBs of the 12-bit t_9 time. This value is always used with the eight bits of Register 0x51, which contains the eight MSBs of the t_9 time. Each LSB corresponds to 5 ns resolution. The entire switching period is divided into 40 ns time steps. If the t_{RX} and t_{FX} of a PWM edge occur within the same 40 ns time step, the PWM output is 0 V. If the t_{RX} and t_{FX} occur in different 40 ns time steps, the PWM output is set to the programmed value. The absolute maximum pulse width is $t_{PERIOD} - 5$ ns. It is recommended that the SR1 rising edge not be set between 80 ns and 115 ns when using the SR soft start.
3	Modulate enable	R/W	1 = PWM modulation acts on the t_9 edge. 0 = no PWM modulation of the t_9 edge.
2	t_9 sign	R/W	1 = negative sign. Increase of PWM modulation moves t_9 right. 0 = positive sign. Increase of PWM modulation moves t_9 left.
1	Reserved	R/W	Reserved.
0	SR soft start edge control	R/W	0 = always allow SR edge crossing. 1 = allow SR edge crossing only during SR soft start (recommended).

Table 83. Register 0x53—SR1 Falling Edge Timing (SR1 Pin)

Bits	Bit Name	R/W	Description
[7:0]	t_{10}	R/W	This register contains the eight MSBs of the 12-bit t_{10} time. This value is always used with the top four bits of Register 0x54, which contains the four LSBs of the t_{10} time. Each LSB corresponds to 5 ns resolution. The entire switching period is divided into 40 ns time steps. If the t_{RX} and t_{FX} of a PWM edge occur within the same 40 ns time step, the PWM output is 0 V. If the t_{RX} and t_{FX} occur in different 40 ns time steps, the PWM output is set to the programmed value. The absolute maximum pulse width is $t_{PERIOD} - 5$ ns.

Table 84. Register 0x54—SR1 Falling Edge Setting (SR1 Pin)

Bits	Bit Name	R/W	Description
[7:4]	t_{10}	R/W	These bits contain the four LSBs of the 12-bit t_{10} time. This value is always used with the eight bits of Register 0x53, which contains the eight MSBs of the t_{10} time. Each LSB corresponds to 5 ns resolution. The entire switching period is divided into 40 ns time steps. If the t_{RX} and t_{FX} of a PWM edge occur within the same 40 ns time step, the PWM output is 0 V. If the t_{RX} and t_{FX} occur in different 40 ns time steps, the PWM output is set to the programmed value. The absolute maximum pulse width is $t_{PERIOD} - 5$ ns.
3	Modulate enable	R/W	1 = PWM modulation acts on the t_{10} edge. 0 = no PWM modulation of the t_{10} edge.
2	t_{10} sign	R/W	1 = negative sign. Increase of PWM modulation moves t_{10} right. 0 = positive sign. Increase of PWM modulation moves t_{10} left.
1	SR soft start setting	R/W	1 = SR signals perform a soft start every time that they are enabled. 0 = SR signals perform a soft start only the first time that they are enabled.
0	SR soft start enable	R/W	Setting this bit enables the soft start function for the SR signals.

Table 85. Register 0x55—SR2 Rising Edge Timing (SR2 Pin)

Bits	Bit Name	R/W	Description
[7:0]	t_{11}	R/W	This register contains the eight MSBs of the 12-bit t_{11} time. This value is always used with the top four bits of Register 0x56, which contains the four LSBs of the t_{11} time. Each LSB corresponds to 5 ns resolution. The entire switching period is divided into 40 ns time steps. If the t_{RX} and t_{FX} of a PWM edge occur within the same 40 ns time step, the PWM output is 0 V. If the t_{RX} and t_{FX} occur in different 40 ns time steps, the PWM output is set to the programmed value. The absolute maximum pulse width is $t_{PERIOD} - 5$ ns. It is recommended that the SR2 rising edge not be set between 80 ns and 115 ns when using the SR soft start.

Table 86. Register 0x56—SR2 Rising Edge Setting (SR2 Pin)

Bits	Bit Name	R/W	Description
[7:4]	t ₁₁	R/W	These bits contain the four LSBs of the 12-bit t ₁₁ time. This value is always used with the eight bits of Register 0x55, which contains the eight MSBs of the t ₁₁ time. Each LSB corresponds to 5 ns resolution. The entire switching period is divided into 40 ns time steps. If the t _{Rx} and t _{Fx} of a PWM edge occur within the same 40 ns time step, the PWM output is 0 V. If the t _{Rx} and t _{Fx} occur in different 40 ns time steps, the PWM output is set to the programmed value. The absolute maximum pulse width is t _{PERIOD} – 5 ns. It is recommended that the SR2 rising edge not be set between 80 ns and 115 ns when using the SR soft start.
3	Modulate enable	R/W	1 = PWM modulation acts on the t ₁₁ edge. 0 = no PWM modulation of the t ₁₁ edge.
2	t ₁₁ sign	R/W	1 = negative sign. Increase of PWM modulation moves t ₁₁ right. 0 = positive sign. Increase of PWM modulation moves t ₁₁ left.
[1:0]	Reserved	R/W	Reserved.

Table 87. Register 0x57—SR2 Falling Edge Timing (SR2 Pin)

Bits	Bit Name	R/W	Description
[7:0]	t ₁₂	R/W	This register contains the eight MSBs of the 12-bit t ₁₂ time. This value is always used with the top four bits of Register 0x58, which contains the four LSBs of the t ₁₂ time. Each LSB corresponds to 5 ns resolution. The entire switching period is divided into 40 ns time steps. If the t _{Rx} and t _{Fx} of a PWM edge occur within the same 40 ns time step, the PWM output is 0 V. If the t _{Rx} and t _{Fx} occur in different 40 ns time steps, the PWM output is set to the programmed value. The absolute maximum pulse width is t _{PERIOD} – 5 ns.

Table 88. Register 0x58—SR2 Falling Edge Setting (SR2 Pin)

Bits	Bit Name	R/W	Description
[7:4]	t ₁₂	R/W	These bits contain the four LSBs of the 12-bit t ₁₂ time. This value is always used with the eight bits of Register 0x57, which contains the eight MSBs of the t ₁₂ time. Each LSB corresponds to 5 ns resolution. The entire switching period is divided into 40 ns time steps. If the t _{Rx} and t _{Fx} of a PWM edge occur within the same 40 ns time step, the PWM output is 0 V. If the t _{Rx} and t _{Fx} occur in different 40 ns time steps, the PWM output is set to the programmed value. The absolute maximum pulse width is t _{PERIOD} – 5 ns.
3	Modulate enable	R/W	1 = PWM modulation acts on the t ₁₂ edge. 0 = no PWM modulation of the t ₁₂ edge.
2	t ₁₂ sign	R/W	1 = negative sign. Increase of PWM modulation moves t ₁₂ right. 0 = positive sign. Increase of PWM modulation moves t ₁₂ left.
[1:0]	Reserved	R/W	Reserved.

Table 89. Register 0x59—OUTAUX Rising Edge Timing (OUTAUX Pin)

Bits	Bit Name	R/W	Description
[7:0]	t ₁₃	R/W	This register contains the eight MSBs of the 12-bit t ₁₃ time. This value is always used with the top four bits of Register 0x5A, which contains the four LSBs of the t ₁₃ time. Each LSB corresponds to 5 ns resolution. The entire switching period is divided into 40 ns time steps. If the t _{Rx} and t _{Fx} of a PWM edge occur within the same 40 ns time step, the PWM output is 0 V. If the t _{Rx} and t _{Fx} occur in different 40 ns time steps, the PWM output is set to the programmed value. The absolute maximum pulse width is t _{PERIOD} – 5 ns. Depending on the switching frequency and the OUTAUX frequency, there is a constant lag/lead time between this edge and the other edges (t ₁ to t ₁₂); therefore, OUTAUX is not synchronized to the other PWM outputs but can be made synchronous by adjusting the delay accordingly. If either the OUTAUX switching frequency (Register 0x3F) or the PWM switching frequency (Register 0x40) is changed after edge adjustment, the synchronization between OUTAUX and the PWM edges is no longer maintained. The OUTAUX delay must be adjusted again to synchronize the edges to the PWM edges for the new set of switching frequencies.

Table 90. Register 0x5A—OUTAUX Rising Edge Setting (OUTAUX Pin)

Bits	Bit Name	R/W	Description
[7:4]	t ₁₃	R/W	These bits contain the four LSBs of the 12-bit t ₁₃ time. This value is always used with the eight bits of Register 0x59, which contains the eight MSBs of the t ₁₃ time. Each LSB corresponds to 5 ns resolution. The entire switching period is divided into 40 ns time steps. If the t _{RX} and t _{FX} of a PWM edge occur within the same 40 ns time step, the PWM output is 0 V. If the t _{RX} and t _{FX} occur in different 40 ns time steps, the PWM output is set to the programmed value. The absolute maximum pulse width is t _{PERIOD} – 5 ns. Depending on the switching frequency and the OUTAUX frequency, there is a constant lag/lead time between this edge and the other edges (t ₁ to t ₁₂); therefore, OUTAUX is not synchronized to the other PWM outputs but can be made synchronous by adjusting the delay accordingly. If either the OUTAUX switching frequency (Register 0x3F) or the PWM switching frequency (Register 0x40) is changed after edge adjustment, the synchronization between OUTAUX and the PWM edges is no longer maintained. The OUTAUX delay must be adjusted again to synchronize the edges to the PWM edges for the new set of switching frequencies.
3	Modulate enable	R/W	1 = PWM modulation acts on the t ₁₃ edge. 0 = no PWM modulation of the t ₁₃ edge.
2	t ₁₃ sign	R/W	1 = negative sign. Increase of PWM modulation moves t ₁₃ right. 0 = positive sign. Increase of PWM modulation moves t ₁₃ left.
[1:0]	Reserved	R/W	Reserved.

Table 91. Register 0x5B—OUTAUX Falling Edge Timing (OUTAUX Pin)

Bits	Bit Name	R/W	Description
[7:0]	t ₁₄	R/W	This register contains the eight MSBs of the 12-bit t ₁₄ time. This value is always used with the top four bits of Register 0x5C, which contains the four LSBs of the t ₁₄ time. Each LSB corresponds to 5 ns resolution. The entire switching period is divided into 40 ns time steps. If the t _{RX} and t _{FX} of a PWM edge occur within the same 40 ns time step, the PWM output is 0 V. If the t _{RX} and t _{FX} occur in different 40 ns time steps, the PWM output is set to the programmed value. The absolute maximum pulse width is t _{PERIOD} – 5 ns. Depending on the switching frequency and the OUTAUX frequency, there is a constant lag/lead time between this edge and the other edges (t ₁ to t ₁₂); therefore, OUTAUX is not synchronized to the other PWM outputs but can be made synchronous by adjusting the delay accordingly. If either the OUTAUX switching frequency (Register 0x3F) or the PWM switching frequency (Register 0x40) is changed after edge adjustment, the synchronization between OUTAUX and the PWM edges is no longer maintained. The OUTAUX delay must be adjusted again to synchronize the edges to the PWM edges for the new set of switching frequencies.

Table 92. Register 0x5C—OUTAUX Falling Edge Setting (OUTAUX Pin)

Bits	Bit Name	R/W	Description
[7:4]	t ₁₄	R/W	These bits contain the four LSBs of the 12-bit t ₁₄ time. This value is always used with the eight bits of Register 0x5B, which contains the eight MSBs of the t ₁₄ time. Each LSB corresponds to 5 ns resolution. The entire switching period is divided into 40 ns time steps. If the t _{RX} and t _{FX} of a PWM edge occur within the same 40 ns time step, the PWM output is 0 V. If the t _{RX} and t _{FX} occur in different 40 ns time steps, the PWM output is set to the programmed value. The absolute maximum pulse width is t _{PERIOD} – 5 ns. Depending on the switching frequency and the OUTAUX frequency, there is a constant lag/lead time between this edge and the other edges (t ₁ to t ₁₂); therefore, OUTAUX is not synchronized to the other PWM outputs but can be made synchronous by adjusting the delay accordingly. If either the OUTAUX switching frequency (Register 0x3F) or the PWM switching frequency (Register 0x40) is changed after edge adjustment, the synchronization between OUTAUX and the PWM edges is no longer maintained. The OUTAUX delay must be adjusted again to synchronize the edges to the PWM edges for the new set of switching frequencies.
3	Modulate enable	R/W	1 = PWM modulation acts on the t ₁₄ edge. 0 = no PWM modulation of the t ₁₄ edge.
2	t ₁₄ sign	R/W	1 = negative sign. Increase of PWM modulation moves t ₁₄ right. 0 = positive sign. Increase of PWM modulation moves t ₁₄ left.
1	Regulate with OUTAUX	R/W	1 = control loop PWM modulation is regulated by OUTAUX. When this bit is set, the CS1 blanking signal is synchronized with OUTAUX. 0 = control loop PWM modulation is regulated by OUTA, OUTB, OUTC, OUTD, SR1, and SR2 (normal mode). Note that a write to this bit immediately switches the regulation point and frequency settings; however, the correct modulation limit and filter settings do not take effect until a subsequent frequency GO is executed using Register 0x7F[2]. For this reason, it is not recommended that the regulation point be changed on the fly using Register 0x5C[1].
0	Reserved	R/W	Reserved. Set this bit to 0 for normal operation.

Table 93. Register 0x5D—OUTx and SRx Pin Disable Settings

Bits	Bit Name	R/W	Description
7	OUTAUX disable	R/W	Setting this bit disables the OUTAUX output.
6	SR2 disable	R/W	Setting this bit disables the SR2 output.
5	SR1 disable	R/W	Setting this bit disables the SR1 output.
4	OUTD disable	R/W	Setting this bit disables the OUTD output.
3	OUTC disable	R/W	Setting this bit disables the OUTC output.
2	OUTB disable	R/W	Setting this bit disables the OUTB output.
1	OUTA disable	R/W	Setting this bit disables the OUTA output.
0	GATE disable	R/W	Setting this bit disables the GATE output but does not affect the VSx feedback point.

Table 94. Register 0x5E—ACSNS Gain Trim

Bits	Bit Name	R/W	Description
7	Gain polarity	R/W	1 = negative gain is introduced. 0 = positive gain is introduced.
[6:0]	ACSNS gain trim	R/W	These bits set the gain trim for the ACSNS ADC.

DIGITAL FILTER PROGRAMMING REGISTERS

Register 0x5F to Register 0x67 can be used to program the digital filters. It is recommended that the software GUI be used to program the digital filters.

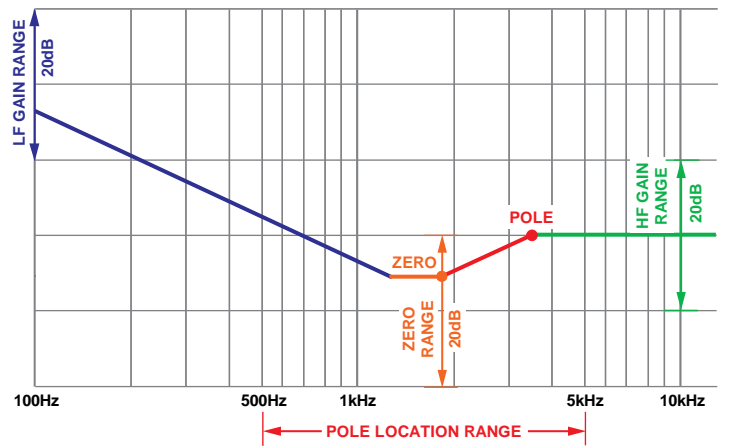

Figure 58. Digital Filter Programmability

Table 95. Register 0x5F—Soft Start and Output Voltage Slew Rate Settings

Bits	Bit Name	R/W	Description			
[7:5]	Soft start ramp	R/W	These bits determine the duration of the soft start ramp.			
			Bit 7	Bit 6	Bit 5	Ramp Duration
			0	0	0	5 ms
			0	0	1	10 ms
			0	1	0	15 ms
			0	1	1	20 ms
			1	0	0	40 ms
			1	0	1	50 ms
1	1	0	80 ms			
1	1	1	100 ms			
4	Soft start from precharge	R/W	Setting this bit to 1 enables the soft start from precharge function. When this function is enabled, the soft start ramp starts from the value of the voltage detected on VS1 or VS3± (depending on the OrFET status).			
3	Reserved	R/W	Reserved.			

Bits	Bit Name	R/W	Description																																				
[2:0]	Slew rate	R/W	These bits specify the slew rate at the VS3± pins for the change in the voltage reference setting.																																				
			<table border="1"> <thead> <tr> <th>Bit 2</th> <th>Bit 1</th> <th>Bit 0</th> <th>Slew Rate</th> </tr> </thead> <tbody> <tr> <td>0</td> <td>0</td> <td>0</td> <td>200 mV/ms</td> </tr> <tr> <td>0</td> <td>0</td> <td>1</td> <td>100 mV/ms</td> </tr> <tr> <td>0</td> <td>1</td> <td>0</td> <td>50 mV/ms</td> </tr> <tr> <td>0</td> <td>1</td> <td>1</td> <td>25 mV/ms</td> </tr> <tr> <td>1</td> <td>0</td> <td>0</td> <td>12.5 mV/ms</td> </tr> <tr> <td>1</td> <td>0</td> <td>1</td> <td>6.25 mV/ms</td> </tr> <tr> <td>1</td> <td>1</td> <td>0</td> <td>3.125 mV/ms</td> </tr> <tr> <td>1</td> <td>1</td> <td>1</td> <td>1.5625 mV/ms (4 LSB/ms)</td> </tr> </tbody> </table>	Bit 2	Bit 1	Bit 0	Slew Rate	0	0	0	200 mV/ms	0	0	1	100 mV/ms	0	1	0	50 mV/ms	0	1	1	25 mV/ms	1	0	0	12.5 mV/ms	1	0	1	6.25 mV/ms	1	1	0	3.125 mV/ms	1	1	1	1.5625 mV/ms (4 LSB/ms)
Bit 2	Bit 1	Bit 0	Slew Rate																																				
0	0	0	200 mV/ms																																				
0	0	1	100 mV/ms																																				
0	1	0	50 mV/ms																																				
0	1	1	25 mV/ms																																				
1	0	0	12.5 mV/ms																																				
1	0	1	6.25 mV/ms																																				
1	1	0	3.125 mV/ms																																				
1	1	1	1.5625 mV/ms (4 LSB/ms)																																				

Table 96. Register 0x60—Normal Mode Digital Filter LF Gain Setting

Bits	Bit Name	R/W	Description
[7:0]	LF gain setting	R/W	This register determines the low frequency gain of the loop response in normal mode. The LF gain is programmable over a 20 dB range (see Figure 58).

Table 97. Register 0x61—Normal Mode Digital Filter Zero Setting

Bits	Bit Name	R/W	Description
[7:0]	Zero setting	R/W	This register determines the position of the final zero in normal mode (see Figure 58).

Table 98. Register 0x62—Normal Mode Digital Filter Pole Setting

Bits	Bit Name	R/W	Description
[7:0]	Pole location	R/W	This register determines the position of the final pole in normal mode (see Figure 58).

Table 99. Register 0x63—Normal Mode Digital Filter HF Gain Setting

Bits	Bit Name	R/W	Description
[7:0]	HF gain setting	R/W	This register determines the high frequency gain of the loop response in normal mode. The HF gain is programmable over a 20 dB range (see Figure 58).

Table 100. Register 0x64—Light Load Mode Digital Filter LF Gain Setting

Bits	Bit Name	R/W	Description
[7:0]	LF gain setting	R/W	This register determines the low frequency gain of the loop response in light load mode. The LF gain is programmable over a 20 dB range (see Figure 58).

Table 101. Register 0x65—Light Load Mode Digital Filter Zero Setting

Bits	Bit Name	R/W	Description
[7:0]	Zero setting	R/W	This register determines the position of the final zero in light load mode (see Figure 58).

Table 102. Register 0x66—Light Load Mode Digital Filter Pole Setting

Bits	Bit Name	R/W	Description
[7:0]	Pole location	R/W	This register determines the position of the final pole in light load mode (see Figure 58).

Table 103. Register 0x67—Light Load Mode Digital Filter HF Gain Setting

Bits	Bit Name	R/W	Description
[7:0]	HF gain setting	R/W	This register determines the high frequency gain of the loop response in light load mode. The HF gain is programmable over a 20 dB range (see Figure 58).

Table 104. Register 0x68—Reserved

Bits	Bit Name	R/W	Description
[7:0]	Reserved	R/W	Set these bits to 0x00 for proper operation.

SOFT START FILTER PROGRAMMING REGISTERS**Table 105. Register 0x71—Soft Start Digital Filter LF Gain Setting**

Bits	Bit Name	R/W	Description
[7:0]	LF gain setting	R/W	This register determines the low frequency gain of the loop response during soft start. The LF gain is programmable over a 20 dB range (see Figure 58).

Table 106. Register 0x72—Soft Start Digital Filter Zero Setting

Bits	Bit Name	R/W	Description
[7:0]	Zero setting	R/W	This register determines the position of the final zero during soft start (see Figure 58).

Table 107. Register 0x73—Soft Start Digital Filter Pole Setting

Bits	Bit Name	R/W	Description
[7:0]	Pole location	R/W	This register determines the position of the final pole during soft start (see Figure 58).

Table 108. Register 0x74—Soft Start Digital Filter HF Gain Setting

Bits	Bit Name	R/W	Description
[7:0]	HF gain setting	R/W	This register determines the high frequency gain of the loop response during soft start. The HF gain is programmable over a 20 dB range (see Figure 58).

EXTENDED FUNCTIONS REGISTERS**Table 109. Register 0x75—Voltage Line Feedforward**

Bits	Bit Name	R/W	Description															
[7:4]	Reserved	R/W	Reserved.															
3	Disable feedforward during soft start	R/W	If voltage line feedforward is enabled, this bit disables it during the reference ramp-up (soft start). This operation is gated by the filter GO bit (Register 0x7F[3]). 0 = feedforward enabled during soft start (recommended setting). 1 = feedforward disabled during soft start.															
2	Feedforward enable	R/W	This bit enables the voltage line feedforward loop. This operation is gated by the filter GO bit (Register 0x7F[3]). 0 = feedforward disabled. 1 = feedforward enabled.															
[1:0]	Gain setting	R/W	These bits set the gain for the voltage feedforward function.															
			<table border="1"> <thead> <tr> <th>Bit 1</th> <th>Bit 0</th> <th>Gain</th> </tr> </thead> <tbody> <tr> <td>0</td> <td>0</td> <td>1</td> </tr> <tr> <td>0</td> <td>1</td> <td>0.875</td> </tr> <tr> <td>1</td> <td>0</td> <td>0.75</td> </tr> <tr> <td>1</td> <td>1</td> <td>0.5</td> </tr> </tbody> </table>	Bit 1	Bit 0	Gain	0	0	1	0	1	0.875	1	0	0.75	1	1	0.5
Bit 1	Bit 0	Gain																
0	0	1																
0	1	0.875																
1	0	0.75																
1	1	0.5																

Table 110. Register 0x76—Volt-Second Balance Settings (OUTA and OUTB Pins)

Bits	Bit Name	R/W	Description
7	Modulate enable, t_1	R/W	Setting this bit enables modulation from balance control on the OUTA rising edge, t_1 . It is recommended that volt-second balance not be enabled on edges that are between 0 ns and 640 ns of the switching period.
6	t_1 sign	R/W	0 = positive sign. Increase of balance control modulation moves t_1 right. 1 = negative sign. Increase of balance control modulation moves t_1 left.
5	Modulate enable, t_2	R/W	Setting this bit enables modulation from balance control on the OUTA falling edge, t_2 . It is recommended that volt-second balance not be enabled on edges that are between 0 ns and 640 ns of the switching period.
4	t_2 sign	R/W	0 = positive sign. Increase of balance control modulation moves t_2 right. 1 = negative sign. Increase of balance control modulation moves t_2 left.
3	Modulate enable, t_3	R/W	Setting this bit enables modulation from balance control on the OUTB rising edge, t_3 . It is recommended that volt-second balance not be enabled on edges that are between 0 ns and 640 ns of the switching period.

Bits	Bit Name	R/W	Description
2	t ₃ sign	R/W	0 = positive sign. Increase of balance control modulation moves t ₃ right. 1 = negative sign. Increase of balance control modulation moves t ₃ left.
1	Modulate enable, t ₄	R/W	Setting this bit enables modulation from balance control on the OUTB falling edge, t ₄ . It is recommended that volt-second balance not be enabled on edges that are between 0 ns and 640 ns of the switching period.
0	t ₄ sign	R/W	0 = positive sign. Increase of balance control modulation moves t ₄ right. 1 = negative sign. Increase of balance control modulation moves t ₄ left.

Table 111. Register 0x77—Volt-Second Balance Settings (OUTC and OUTD Pins)

Bits	Bit Name	R/W	Description
7	Modulate enable, t ₅	R/W	Setting this bit enables modulation from balance control on the OUTC rising edge, t ₅ . It is recommended that volt-second balance not be enabled on edges that are between 0 ns and 640 ns of the switching period.
6	t ₅ sign	R/W	0 = positive sign. Increase of balance control modulation moves t ₅ right. 1 = negative sign. Increase of balance control modulation moves t ₅ left.
5	Modulate enable, t ₆	R/W	Setting this bit enables modulation from balance control on the OUTC falling edge, t ₆ . It is recommended that volt-second balance not be enabled on edges that are between 0 ns and 640 ns of the switching period.
4	t ₆ sign	R/W	0 = positive sign. Increase of balance control modulation moves t ₆ right. 1 = negative sign. Increase of balance control modulation moves t ₆ left.
3	Modulate enable, t ₇	R/W	Setting this bit enables modulation from balance control on the OUTD rising edge, t ₇ . It is recommended that volt-second balance not be enabled on edges that are between 0 ns and 640 ns of the switching period.
2	t ₇ sign	R/W	0 = positive sign. Increase of balance control modulation moves t ₇ right. 1 = negative sign. Increase of balance control modulation moves t ₇ left.
1	Modulate enable, t ₈	R/W	Setting this bit enables modulation from balance control on the OUTD falling edge, t ₈ . It is recommended that volt-second balance not be enabled on edges that are between 0 ns and 640 ns of the switching period.
0	t ₈ sign	R/W	0 = positive sign. Increase of balance control modulation moves t ₈ right. 1 = negative sign. Increase of balance control modulation moves t ₈ left.

Table 112. Register 0x78—Volt-Second Balance Settings (SR1 and SR2 Pins)

Bits	Bit Name	R/W	Description
7	Modulate enable, t ₉	R/W	Setting this bit enables modulation from balance control on the SR1 rising edge, t ₉ . It is recommended that volt-second balance not be enabled on edges that are between 0 ns and 640 ns of the switching period.
6	t ₉ sign	R/W	0 = positive sign. Increase of balance control modulation moves t ₉ right. 1 = negative sign. Increase of balance control modulation moves t ₉ left.
5	Modulate enable, t ₁₀	R/W	Setting this bit enables modulation from balance control on the SR1 falling edge, t ₁₀ . It is recommended that volt-second balance not be enabled on edges that are between 0 ns and 640 ns of the switching period.
4	t ₁₀ sign	R/W	0 = positive sign. Increase of balance control modulation moves t ₁₀ right. 1 = negative sign. Increase of balance control modulation moves t ₁₀ left.
3	Modulate enable, t ₁₁	R/W	Setting this bit enables modulation from balance control on the SR2 rising edge, t ₁₁ . It is recommended that volt-second balance not be enabled on edges that are between 0 ns and 640 ns of the switching period.
2	t ₁₁ sign	R/W	0 = positive sign. Increase of balance control modulation moves t ₁₁ right. 1 = negative sign. Increase of balance control modulation moves t ₁₁ left.
1	Modulate enable, t ₁₂	R/W	Setting this bit enables modulation from balance control on the SR2 falling edge, t ₁₂ . It is recommended that volt-second balance not be enabled on edges that are between 0 ns and 640 ns of the switching period.
0	t ₁₂ sign	R/W	0 = positive sign. Increase of balance control modulation moves t ₁₂ right. 1 = negative sign. Increase of balance control modulation moves t ₁₂ left.

Table 113. Register 0x79—SR Delay Compensation

Bits	Bit Name	R/W	Description
[7:6]	Reserved	R/W	Reserved.
[5:0]	SR driver delay	R/W	These bits specify the 6-bit representation of the SR delay in steps of 5 ns. 000000 = 0 ns. 111111 = 63 ns × 5 ns = 315 ns.

Table 114. Register 0x7A—Filter Transitions

Bits	Bit Name	R/W	Description															
[7:6]	Reserved	R/W	Reserved.															
[5:3]	HF ADC configuration	R/W	Set these bits to 001 at all times for proper operation.															
2	Enable soft transition	R/W	Setting this bit enables a soft transition between filter settings to minimize output transients. All four parameters of each filter are linearly transitioned to the new value.															
[1:0]	Transition speed	R/W	These bits set the transition speed from one filter to another. The filter changes in 32 steps; each step is applied at the multiple of switching cycles (t_{sw}) specified by these bits.															
			<table border="1"> <thead> <tr> <th>Bit 1</th> <th>Bit 0</th> <th>Speed ($t_{sw} = \text{One Switching Cycle}$)</th> </tr> </thead> <tbody> <tr> <td>0</td> <td>0</td> <td>32 t_{sw} (total transition time = $32 \times 32 t_{sw} = 1024 \times t_{sw}$)</td> </tr> <tr> <td>0</td> <td>1</td> <td>8 t_{sw} (total transition time = $8 \times 32 t_{sw} = 256 \times t_{sw}$)</td> </tr> <tr> <td>1</td> <td>0</td> <td>2 t_{sw} (total transition time = $64 \times t_{sw}$)</td> </tr> <tr> <td>1</td> <td>1</td> <td>1 t_{sw} (total transition time = $32 \times t_{sw}$)</td> </tr> </tbody> </table>	Bit 1	Bit 0	Speed ($t_{sw} = \text{One Switching Cycle}$)	0	0	32 t_{sw} (total transition time = $32 \times 32 t_{sw} = 1024 \times t_{sw}$)	0	1	8 t_{sw} (total transition time = $8 \times 32 t_{sw} = 256 \times t_{sw}$)	1	0	2 t_{sw} (total transition time = $64 \times t_{sw}$)	1	1	1 t_{sw} (total transition time = $32 \times t_{sw}$)
Bit 1	Bit 0	Speed ($t_{sw} = \text{One Switching Cycle}$)																
0	0	32 t_{sw} (total transition time = $32 \times 32 t_{sw} = 1024 \times t_{sw}$)																
0	1	8 t_{sw} (total transition time = $8 \times 32 t_{sw} = 256 \times t_{sw}$)																
1	0	2 t_{sw} (total transition time = $64 \times t_{sw}$)																
1	1	1 t_{sw} (total transition time = $32 \times t_{sw}$)																

Table 115. Register 0x7B—PGOOD1 Flag Masking

Bits	Bit Name	R/W	Description
7	Soft start flag	R/W	If this bit is set to 1, the soft start flag is ignored by PGOOD1. This bit must be set to 0 to enable proper PGOOD1 debounce timing after the end of the soft start ramp.
6	CS1 fast OCP	R/W	If this bit is set to 1, the CS1 fast OCP flag is ignored by PGOOD1.
5	CS1 accurate OCP	R/W	If this bit is set to 1, the CS1 accurate OCP flag is ignored by PGOOD1.
4	CS2 accurate OCP	R/W	If this bit is set to 1, the CS2 accurate OCP flag is ignored by PGOOD1.
3	UVP	R/W	If this bit is set to 1, the UVP flag is ignored by PGOOD1.
2	Local OVP (fast and accurate)	R/W	If this bit is set to 1, the local OVP flag is ignored by PGOOD1.
1	Load OVP	R/W	If this bit is set to 1, the load OVP flag is ignored by PGOOD1.
0	OrFET	R/W	If this bit is set to 1, the OrFET flag is ignored by PGOOD1.

Table 116. Register 0x7C—PGOOD2 Flag Masking

Bits	Bit Name	R/W	Description
7	Soft start flag	R/W	If this bit is set to 1, the soft start flag is ignored by PGOOD2. This bit must be set to 0 to enable proper PGOOD2 debounce timing after the end of the soft start ramp.
6	CS1 fast OCP	R/W	If this bit is set to 1, the CS1 fast OCP flag is ignored by PGOOD2.
5	CS1 accurate OCP	R/W	If this bit is set to 1, the CS1 accurate OCP flag is ignored by PGOOD2.
4	CS2 accurate OCP	R/W	If this bit is set to 1, the CS2 accurate OCP flag is ignored by PGOOD2.
3	UVP	R/W	If this bit is set to 1, the UVP flag is ignored by PGOOD2.
2	Local OVP (fast and accurate)	R/W	If this bit is set to 1, the local OVP flag is ignored by PGOOD2.
1	Load OVP	R/W	If this bit is set to 1, the load OVP flag is ignored by PGOOD2.
0	OrFET	R/W	If this bit is set to 1, the OrFET flag is ignored by PGOOD2.

Table 117. Register 0x7D—Light Load Mode Threshold Settings

Bits	Bit Name	R/W	Description		
[7:6]	Reserved	R/W	Reserved.		
[5:4]	Debounce	R/W	After the SR outputs are turned on or off, any further transition of the thresholds is ignored for the amount of time programmed in these bits. This debounce is provided to avoid false transitions and improve noise immunity. The debounce time is calculated as a number of PWM switching cycles (t_{sw}). For example, at 100 kHz, $t_{sw} = 10 \mu s$, $64 \times t_{sw} = 640 \mu s$.		
			Bit 5	Bit 4	Debounce Time
			0	0	$0 t_{sw}$
			0	1	$64 t_{sw}$
			1	0	$128 t_{sw}$
1	1	$256 t_{sw}$			
[3:2]	Light load mode averaging speed	R/W	These bits set the averaging speed and resolution used for the light load mode threshold. Faster speed corresponds to lower resolution and, therefore, to lower accuracy of the threshold.		
			Bit 3	Bit 2	Speed (Resolution)
			0	0	$37.5 \mu s$ (6 bits)
			0	1	$75 \mu s$ (7 bits)
			1	0	$150 \mu s$ (8 bits)
1	1	$300 \mu s$ (9 bits)			
[1:0]	Light load mode hysteresis	R/W	These bits set the amount of hysteresis applied to the light load mode threshold. The size of the LSB is affected by the speed and resolution selected in Bits[3:2]. If the CS2 ADC range of 120 mV is used with 8-bit resolution, the LSB size is $120 mV/2^8 = 469 \mu V$.		
			Bit 1	Bit 0	Hysteresis (LSB)
			0	0	3
			0	1	8
			1	0	12
1	1	16			

Table 118. Register 0x7F—GO Byte

Bits	Bit Name	R/W	Description
[7:4]	Reserved	R/W	Reserved.
3	Filter GO	W	This bit latches all the filter registers: Register 0x60 to Register 0x67 and Register 0x71 to Register 0x75.
2	Frequency GO	W	This bit latches Register 0x3F and Register 0x40 to prevent the switching frequency settings from being temporarily incorrect.
1	PWM settings GO	W	This bit latches Register 0x41 to Register 0x5C to prevent the PWM settings from being temporarily incorrect. Note that Register 0x5C[1] is not gated by this bit (Register 0x7F[1]). A write to Register 0x5C[1] immediately switches the regulation point and frequency settings; however, the correct modulation limit and filter settings do not take effect until a subsequent frequency GO is executed using Register 0x7F[2]. For this reason, it is not recommended that the regulation point be changed on the fly using Register 0x5C[1].
0	Voltage reference GO	W	This bit latches Register 0x31 to prevent the reference setting from being temporarily incorrect.

EEPROM REGISTERS

Refer to the I²C communication protocol specification for more information about how to write these commands to the [ADP1046AW](#).

Table 119. Register 0x81—RESTORE_DEFAULT_ALL

Bits	Bit Name	Type	Description
N/A	RESTORE_DEFAULT_ALL	Send byte	Download the factory default settings from EEPROM (Page 0 of the main block) into operating memory. The password is also reset to the default value (0xFF).

Table 120. Register 0x82—STORE_USER_ALL

Bits	Bit Name	Type	Description
N/A	STORE_USER_ALL	Send byte	Copy the entire contents of operating memory (registers) into EEPROM (Page 1 of the main block). The EEPROM must first be unlocked.

Table 121. Register 0x83—RESTORE_USER_ALL

Bits	Bit Name	Type	Description
N/A	RESTORE_USER_ALL	Send byte	Download the stored user settings from EEPROM (Page 1 of the main block) into operating memory. The EEPROM must first be unlocked.

Table 122. Register 0x84—EEPROM_CRC_CHKSUM

Bits	Bit Name	Type	Description
[7:0]	EEPROM_CRC_CHKSUM	R	Return the CRC checksum value from the EEPROM download operation.

Table 123. Register 0x85—EEPROM_ADDR_OFFSET

Bits	Bit Name	Type	Description
[15:0]	EEPROM_ADDR_OFFSET	R/W	Set the address offset of the current EEPROM page.

Table 124. Register 0x86—EEPROM_NUM_RD_BYTES

Bits	Bit Name	Type	Description
[7:0]	EEPROM_NUM_RD_BYTES	R/W	Set the number of read bytes returned when using the EEPROM_DATA_xx command.

Table 125. Register 0x87—EEPROM_PAGE_ERASE

Bits	Bit Name	Type	Description
[7:4]	Reserved	R	Reserved.
[3:0]	EEPROM_PAGE_ERASE	W	Perform a page erase on the selected EEPROM page (Page 4 to Page 15). Wait 35 ms after each page erase operation. The EEPROM must first be unlocked. Page 0 and Page 1 are reserved for storing the default settings and user settings, respectively. The user cannot perform a page erase of Page 0 or Page 1. Page 2 and Page 3 are reserved for internal use; do not erase the contents of Page 2 or Page 3.

Table 126. Register 0x88—EEPROM_PASSWORD

Bits	Bit Name	Type	Description
[7:0]	EEPROM_PASSWORD	W	Write the password to this register two consecutive times to unlock the EEPROM and/or to change the EEPROM password. The factory default password is 0xFF. To lock the EEPROM, type any value other than the password to this register.

Table 127. Register 0x89—TRIM_PASSWORD

Bits	Bit Name	Type	Description
[7:0]	TRIM_PASSWORD	R/W	Write the password to this register to unlock the trim registers for write access. Write the trim password twice to unlock the register; write any other value to exit. The trim password is the same as the EEPROM password.

Table 128. Register 0x8A—EEPROM_INFO

Bits	Bit Name	Type	Description
Variable	EEPROM_INFO	Block read	Block read from the EEPROM INFO block.

Table 129. Register 0x8B—EEPROM_DATA_00

Bits	Bit Name	Type	Description
Variable	EEPROM_DATA_00	Block read	Block read from the EEPROM main block, Page 0. The EEPROM must first be unlocked. This page contains the factory default settings.

Table 130. Register 0x8C—EEPROM_DATA_01

Bits	Bit Name	Type	Description
Variable	EEPROM_DATA_01	Block read	Block read from the EEPROM main block, Page 1. The EEPROM must first be unlocked. This page contains the user settings.

Table 131. Register 0x8D—EEPROM_DATA_02

Bits	Bit Name	Type	Description
Variable	EEPROM_DATA_02	Block read	Block read from the EEPROM main block, Page 2. This page contains internal settings and should not be written to or erased.

Table 132. Register 0x8E—EEPROM_DATA_03

Bits	Bit Name	Type	Description
Variable	EEPROM_DATA_03	Block read	Block read from the EEPROM main block, Page 3. This page contains internal settings and should not be written to or erased.

Table 133. Register 0x8F—EEPROM_DATA_04

Bits	Bit Name	Type	Description
Variable	EEPROM_DATA_04	Block read/ write	Block read or write from the EEPROM main block, Page 4. To write to this page, the EEPROM must first be unlocked. This page is available to the user for storing data.

Table 134. Register 0x90—EEPROM_DATA_05

Bits	Bit Name	Type	Description
Variable	EEPROM_DATA_05	Block read/ write	Block read or write from the EEPROM main block, Page 5. To write to this page, the EEPROM must first be unlocked. This page is available to the user for storing data.

Table 135. Register 0x91—EEPROM_DATA_06

Bits	Bit Name	Type	Description
Variable	EEPROM_DATA_06	Block read/ write	Block read or write from the EEPROM main block, Page 6. To write to this page, the EEPROM must first be unlocked. This page is available to the user for storing data.

Table 136. Register 0x92—EEPROM_DATA_07

Bits	Bit Name	Type	Description
Variable	EEPROM_DATA_07	Block read/ write	Block read or write from the EEPROM main block, Page 7. To write to this page, the EEPROM must first be unlocked. This page is available to the user for storing data.

Table 137. Register 0x93—EEPROM_DATA_08

Bits	Bit Name	Type	Description
Variable	EEPROM_DATA_08	Block read/ write	Block read or write from the EEPROM main block, Page 8. To write to this page, the EEPROM must first be unlocked. This page is available to the user for storing data.

Table 138. Register 0x94—EEPROM_DATA_09

Bits	Bit Name	Type	Description
Variable	EEPROM_DATA_09	Block read/ write	Block read or write from the EEPROM main block, Page 9. To write to this page, the EEPROM must first be unlocked. This page is available to the user for storing data.

Table 139. Register 0x95—EEPROM_DATA_10

Bits	Bit Name	Type	Description
Variable	EEPROM_DATA_10	Block read/ write	Block read or write from the EEPROM main block, Page 10. To write to this page, the EEPROM must first be unlocked. This page is available to the user for storing data.

Table 140. Register 0x96—EEPROM_DATA_11

Bits	Bit Name	Type	Description
Variable	EEPROM_DATA_11	Block read/ write	Block read or write from the EEPROM main block, Page 11. To write to this page, the EEPROM must first be unlocked. This page is available to the user for storing data.

Table 141. Register 0x97—EEPROM_DATA_12

Bits	Bit Name	Type	Description
Variable	EEPROM_DATA_12	Block read/ write	Block read or write from the EEPROM main block, Page 12. To write to this page, the EEPROM must first be unlocked. This page is available to the user for storing data.

Table 142. Register 0x98—EEPROM_DATA_13

Bits	Bit Name	Type	Description
Variable	EEPROM_DATA_13	Block read/ write	Block read or write from the EEPROM main block, Page 13. To write to this page, the EEPROM must first be unlocked. This page is available to the user for storing data.

Table 143. Register 0x99—EEPROM_DATA_14

Bits	Bit Name	Type	Description
Variable	EEPROM_DATA_14	Block read/ write	Block read or write from the EEPROM main block, Page 14. To write to this page, the EEPROM must first be unlocked. This page is available to the user for storing data.

Table 144. Register 0x9A—EEPROM_DATA_15

Bits	Bit Name	Type	Description
Variable	EEPROM_DATA_15	Block read/ write	Block read or write from the EEPROM main block, Page 15. To write to this page, the EEPROM must first be unlocked. This page is available to the user for storing data.

RESONANT MODE OPERATION

The ADP1046AW supports control of a resonant converter. Resonant converters are an alternative to traditional fixed frequency converters. They offer high switching frequency, small size, and high efficiency. Figure 59 illustrates a widely used series resonant converter.

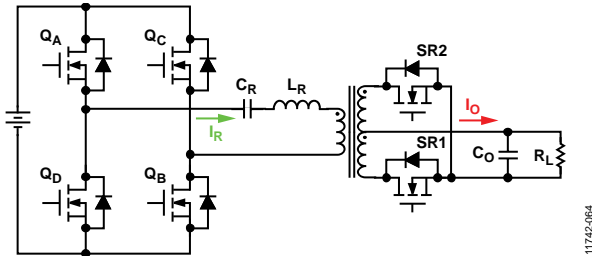

Figure 59. Series Resonant Converter

RESONANT MODE ENABLE

To enable the ADP1046AW to control a resonant switching converter, Register 0x40 must be set to a value of 0x3F. In resonant mode, the PWM outputs have a fixed duty cycle with variable frequency.

PWM TIMING IN RESONANT MODE

With variable frequency control, OUTA and OUTB can only be high during the first half of the switching cycle (t_A to t_B), whereas OUTC and OUTD can only be high during the second half of the switching cycle (t_B to t_C), as shown in Figure 60. The frequency resolution of the control law is in steps of 10 ns.

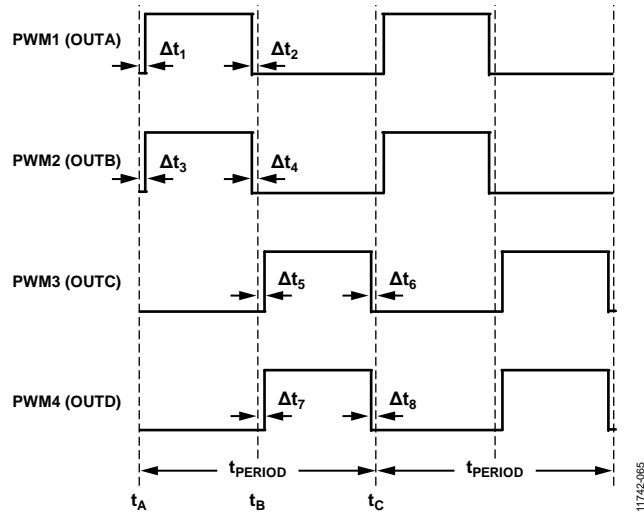

Figure 60. OUTA, OUTB, OUTC, and OUTD PWM Timing Diagram in Resonant Mode

SYNCHRONOUS RECTIFICATION IN RESONANT MODE

Control of the synchronous rectifiers in a resonant controller is a complicated issue. The ADP1046AW ACSNS comparator can be used to control the SR signals. In resonant mode operation, the SR1 output is driven by the rising edge of the ACSNS comparator, and the SR2 output is driven by the falling edge of the comparator, as shown in Figure 61.

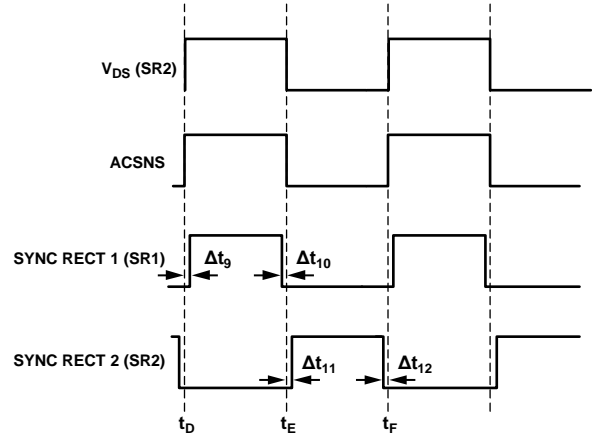

Figure 61. SR1 and SR2 PWM Timing Diagram in Resonant Mode

Following is an example of how the ADP1046AW can be used in a series resonant topology and also achieve control of the synchronous rectifiers. The V_{DS} voltage of SR2 (see Figure 61) can be used to control the SR signals. The ACSNS pin is connected to the divided-down SR2 V_{DS} voltage. This provides the timing information for both synchronous rectifiers (see Figure 62).

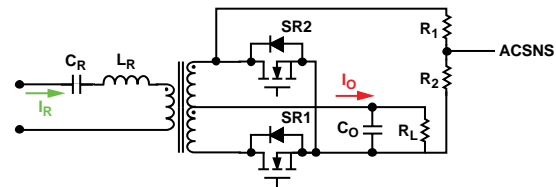

Figure 62. Resonant Synchronous Rectifier Control Circuit

After the timing information is obtained, SR1 is driven by the rising edge of the ACSNS comparator, and SR2 is driven by the falling edge of the comparator, as shown in Figure 61. In this way, it is possible to achieve synchronous rectification. Turn-on and turn-off delays can be programmed for the SR1 and SR2 signals individually.

This example is not the only way to control the SR signals. If the user has another method to control the SR signals, this method can be used to connect to the ACSNS input instead of the V_{DS} voltage of SR2.

When the ADP1046AW is used to control a resonant converter, it is recommended that SR soft start be disabled during soft start of the device (set Register 0x0F[7] = 1).

ADJUSTING THE TIMING OF THE PWM OUTPUTS

To accurately adjust the timing of the PWM outputs, the following registers can be used to set the dead time and delays of the PWM outputs: Register 0x41, Register 0x43, Register 0x45, Register 0x47, Register 0x49, Register 0x4B, Register 0x4D, Register 0x4F, Register 0x51, Register 0x53, Register 0x55, and Register 0x57. The resolution for adjusting the dead time is 5 ns. See the Resonant Mode Register Descriptions section for more information. The software GUI for the [ADP1046AW](#) can be used to set the frequency limit registers, as well as all other settings related to the resonant mode of operation.

FREQUENCY LIMIT SETTING

The minimum frequency is set by Register 0x42 and the first four bits of Register 0x44.

For example, Register 0x42 is set to 0xA0 (160 decimal) and Bits[7:4] of Register 0x44 are set to 0xF (15 decimal).

The maximum switching cycle is

$$(160 \times 16 + 15) \times 5 \text{ ns} = 12.875 \mu\text{s}$$

The lowest switching frequency limit is

$$1/12.875 \mu\text{s} = 77.7 \text{ kHz}$$

The maximum frequency is set by Register 0x46 and by Bits[7:4] of Register 0x48.

For example, Register 0x46 is set to 0x10 (16 decimal) and Bits[7:4] of Register 0x48 are set to 0x9 (9 decimal).

The minimum switching cycle is

$$(16 \times 16 + 9) \times 5 \text{ ns} = 1.325 \mu\text{s}$$

The highest switching frequency limit is

$$1/1.325 \mu\text{s} = 755 \text{ kHz}$$

FEEDBACK CONTROL IN RESONANT MODE

In contrast to a traditional fixed frequency PWM converter, the output voltage of a resonant converter is regulated by changing the switching frequency. When the [ADP1046AW](#) is operated in resonant mode, the switching frequency decreases when the sensed voltage is lower than the reference voltage. This makes the [ADP1046AW](#) capable of controlling a resonant converter in zero-voltage switching (ZVS) mode.

Although the switching frequency is variable, the high frequency feedback voltage sampling frequency (VS3± pins) is fixed at 400 kHz. The parameters of the feedback filter are based on this frequency. The method for calculating the filter parameters (gains, zeros, and poles) is the same as that for the fixed frequency PWM mode (see the Digital Filter section).

SOFT START IN RESONANT MODE

During soft start, the reference voltage of the [ADP1046AW](#) ramps up. With the feedback loop closed, the switching frequency is reduced from the highest limit to a regulation value. The soft start timing settings and the filter settings are the same as those for the fixed frequency PWM mode (see the Soft Start section).

LIGHT LOAD OPERATION (BURST MODE)

To control the converter at very light load, the [ADP1046AW](#) can operate in burst mode. Burst mode can be enabled or disabled using Bits[7:6] of Register 0x4A. When the desired switching frequency is higher than the burst mode threshold, the part enters burst mode. The threshold is determined by the maximum frequency and the burst mode offset setting.

The threshold value used to enter burst mode is determined as follows:

$$\begin{aligned} \text{Threshold value for burst mode} = \\ ((\text{Register } 0x46 \times 16) + \text{Register } 0x48[7:4]) + \\ (\text{Register } 0x4A[5:0] \times 2) \end{aligned}$$

The threshold value used to exit burst mode is determined by the entrance value plus 0x10.

For example, Register 0x46 is set to 0x10 (16 decimal), Bits[7:4] of Register 0x48 are set to 0, and Bits[5:0] of Register 0x4A are set to 0x8 (8 decimal).

The minimum switching cycle is

$$(16 \times 16 + 0) \times 5 \text{ ns} = 1.28 \mu\text{s}$$

The highest switching frequency limit is

$$1/1.28 \mu\text{s} = 781 \text{ kHz}$$

The threshold to enter burst mode is

$$[(16 \times 16 + 0) + (8 \times 2)] \times 5 \text{ ns} = 1.36 \mu\text{s}$$

When the desired switching frequency is higher than $1/1.36 \mu\text{s} = 735 \text{ kHz}$, the PWM outputs are shut down and the part enters burst mode.

The threshold to exit burst mode is

$$[(16 \times 16 + 0) + (8 \times 2) + 16] \times 5 \text{ ns} = 1.44 \mu\text{s}$$

Therefore, when the desired switching frequency becomes lower than $1/1.44 \mu\text{s} = 694 \text{ kHz}$, the PWM signals are reenabled, and the part exits burst mode.

OUTAUX PIN IN RESONANT MODE

In resonant mode, the OUTAUX pin cannot be used as a control signal. However, OUTAUX can be used as a fixed frequency PWM signal with a fixed duty cycle.

PROTECTIONS IN RESONANT MODE

All of the flags and protections that are available in resonant mode behave in the same manner as in fixed frequency PWM mode.

RESONANT MODE REGISTER DESCRIPTIONS

Table 145. Register 0x40—PWM Switching Frequency Setting in Resonant Mode

Bits	Bit Name	R/W	Description
[7:6]	Reserved	R/W	Reserved.
[5:0]	Switching frequency	R/W	This register sets the switching frequency of the PWM pins and enables resonant mode. To enable resonant mode, set these bits to 0x3F (111111).

Table 146. Register 0x41—OUTA Rising Edge Dead Time in Resonant Mode

Bits	Bit Name	R/W	Description																																													
[7:0]	Δt_1 (rising edge dead time of OUTA)	R/W	This register sets Δt_1 , which is the delay of the rising edge of OUTA from the start of the switching cycle, t_A . Each LSB corresponds to 5 ns of resolution.																																													
			<table border="1"> <thead> <tr> <th>Bit 7</th> <th>Bit 6</th> <th>Bit 5</th> <th>Bit 4</th> <th>Bit 3</th> <th>Bit 2</th> <th>Bit 1</th> <th>Bit 0</th> <th>Δt_1 (ns)</th> </tr> </thead> <tbody> <tr> <td>0</td> <td>0</td> <td>0</td> <td>0</td> <td>0</td> <td>0</td> <td>0</td> <td>0</td> <td>0</td> </tr> <tr> <td>0</td> <td>0</td> <td>0</td> <td>0</td> <td>0</td> <td>0</td> <td>0</td> <td>1</td> <td>5</td> </tr> <tr> <td>...</td> <td>...</td> <td>...</td> <td>...</td> <td>...</td> <td>...</td> <td>...</td> <td>...</td> <td>...</td> </tr> <tr> <td>1</td> <td>1</td> <td>1</td> <td>1</td> <td>1</td> <td>1</td> <td>1</td> <td>1</td> <td>1275</td> </tr> </tbody> </table>	Bit 7	Bit 6	Bit 5	Bit 4	Bit 3	Bit 2	Bit 1	Bit 0	Δt_1 (ns)	0	0	0	0	0	0	0	0	0	0	0	0	0	0	0	0	1	5	1	1	1	1	1	1	1	1	1275
Bit 7	Bit 6	Bit 5	Bit 4	Bit 3	Bit 2	Bit 1	Bit 0	Δt_1 (ns)																																								
0	0	0	0	0	0	0	0	0																																								
0	0	0	0	0	0	0	1	5																																								
...																																								
1	1	1	1	1	1	1	1	1275																																								

Table 147. Register 0x42—Lowest Switching Frequency Limit Setting (Maximum Switching Cycle in Resonant Mode)

Bits	Bit Name	R/W	Description
[7:0]	Lowest frequency	R/W	This register contains the eight MSBs of the 12-bit value of the lowest switching frequency (maximum switching cycle) limit. This value is always used with the top four bits of Register 0x44, which contain the four LSBs of the lowest switching frequency limit. Each LSB of the 12-bit value corresponds to 5 ns of resolution for the switching cycle. For example, if Register 0x42 is set to 0xA0 (160 decimal) and Bits[7:4] of Register 0x44 are set to 0xF (15 decimal), the maximum switching cycle is $(160 \times 16 + 15) \times 5 \text{ ns} = 12.875 \mu\text{s}$, and the lowest switching frequency limit is $1/12.875 \mu\text{s} = 77.7 \text{ kHz}$.

Table 148. Register 0x43—OUTA Falling Edge Dead Time in Resonant Mode

Bits	Bit Name	R/W	Description																																																																								
[7:0]	Δt_2 (falling edge dead time of OUTA)	R/W	This register sets Δt_2 , which is the difference between the falling edge of OUTA and the mid-point of the switching cycle, t_B . Each LSB corresponds to 5 ns of resolution. When the register value is from 0x00 to 0x7F, the falling edge of OUTA is trailing t_B . When the value is from 0x80 to 0xFF, the falling edge of OUTA is leading t_B .																																																																								
			<table border="1"> <thead> <tr> <th>Bit 7</th> <th>Bit 6</th> <th>Bit 5</th> <th>Bit 4</th> <th>Bit 3</th> <th>Bit 2</th> <th>Bit 1</th> <th>Bit 0</th> <th>Δt_2</th> </tr> </thead> <tbody> <tr> <td>0</td> <td>0</td> <td>0</td> <td>0</td> <td>0</td> <td>0</td> <td>0</td> <td>0</td> <td>0 ns</td> </tr> <tr> <td>0</td> <td>0</td> <td>0</td> <td>0</td> <td>0</td> <td>0</td> <td>0</td> <td>1</td> <td>5 ns trailing</td> </tr> <tr> <td>...</td> <td>...</td> <td>...</td> <td>...</td> <td>...</td> <td>...</td> <td>...</td> <td>...</td> <td>...</td> </tr> <tr> <td>0</td> <td>1</td> <td>1</td> <td>1</td> <td>1</td> <td>1</td> <td>1</td> <td>1</td> <td>635 ns trailing</td> </tr> <tr> <td>1</td> <td>0</td> <td>0</td> <td>0</td> <td>0</td> <td>0</td> <td>0</td> <td>0</td> <td>640 ns leading</td> </tr> <tr> <td>...</td> <td>...</td> <td>...</td> <td>...</td> <td>...</td> <td>...</td> <td>...</td> <td>...</td> <td>...</td> </tr> <tr> <td>1</td> <td>1</td> <td>1</td> <td>1</td> <td>1</td> <td>1</td> <td>1</td> <td>1</td> <td>5 ns leading</td> </tr> </tbody> </table>	Bit 7	Bit 6	Bit 5	Bit 4	Bit 3	Bit 2	Bit 1	Bit 0	Δt_2	0	0	0	0	0	0	0	0	0 ns	0	0	0	0	0	0	0	1	5 ns trailing	0	1	1	1	1	1	1	1	635 ns trailing	1	0	0	0	0	0	0	0	640 ns leading	1	1	1	1	1	1	1	1	5 ns leading
Bit 7	Bit 6	Bit 5	Bit 4	Bit 3	Bit 2	Bit 1	Bit 0	Δt_2																																																																			
0	0	0	0	0	0	0	0	0 ns																																																																			
0	0	0	0	0	0	0	1	5 ns trailing																																																																			
...																																																																			
0	1	1	1	1	1	1	1	635 ns trailing																																																																			
1	0	0	0	0	0	0	0	640 ns leading																																																																			
...																																																																			
1	1	1	1	1	1	1	1	5 ns leading																																																																			

Table 149. Register 0x44—Lowest Switching Frequency Limit Setting (Maximum Switching Cycle in Resonant Mode)

Bits	Bit Name	R/W	Description
[7:4]	Lowest frequency	R/W	This register contains the four LSBs of the 12-bit value of the lowest switching frequency (maximum switching cycle) limit. This value is always used with the eight bits of Register 0x42, which contain the eight MSBs of the lowest switching frequency limit. Each LSB of the 12-bit value corresponds to 5 ns of resolution for the switching cycle. For example, if Register 0x42 is set to 0xA0 (160 decimal) and Bits[7:4] of Register 0x44 are set to 0xF (15 decimal), the maximum switching cycle is $(160 \times 16 + 15) \times 5 \text{ ns} = 12.875 \mu\text{s}$, and the lowest switching frequency limit is $1/12.875 \mu\text{s} = 77.7 \text{ kHz}$.
[3:0]	Reserved	R/W	Reserved.

Table 150. Register 0x45—OUTB Rising Edge Dead Time in Resonant Mode

Bits	Bit Name	R/W	Description																																													
[7:0]	Δt_3 (rising edge dead time of OUTB)	R/W	This register sets Δt_3 , which is the delay time of the rising edge of OUTB from the start of the switching cycle, t_A . Each LSB corresponds to 5 ns of resolution.																																													
			<table border="1"> <thead> <tr> <th>Bit 7</th> <th>Bit 6</th> <th>Bit 5</th> <th>Bit 4</th> <th>Bit 3</th> <th>Bit 2</th> <th>Bit 1</th> <th>Bit 0</th> <th>Δt_3 (ns)</th> </tr> </thead> <tbody> <tr> <td>0</td> <td>0</td> <td>0</td> <td>0</td> <td>0</td> <td>0</td> <td>0</td> <td>0</td> <td>0</td> </tr> <tr> <td>0</td> <td>0</td> <td>0</td> <td>0</td> <td>0</td> <td>0</td> <td>0</td> <td>1</td> <td>5</td> </tr> <tr> <td>...</td> <td>...</td> <td>...</td> <td>...</td> <td>...</td> <td>...</td> <td>...</td> <td>...</td> <td>...</td> </tr> <tr> <td>1</td> <td>1</td> <td>1</td> <td>1</td> <td>1</td> <td>1</td> <td>1</td> <td>1</td> <td>1275</td> </tr> </tbody> </table>	Bit 7	Bit 6	Bit 5	Bit 4	Bit 3	Bit 2	Bit 1	Bit 0	Δt_3 (ns)	0	0	0	0	0	0	0	0	0	0	0	0	0	0	0	0	1	5	1	1	1	1	1	1	1	1	1275
Bit 7	Bit 6	Bit 5	Bit 4	Bit 3	Bit 2	Bit 1	Bit 0	Δt_3 (ns)																																								
0	0	0	0	0	0	0	0	0																																								
0	0	0	0	0	0	0	1	5																																								
...																																								
1	1	1	1	1	1	1	1	1275																																								

Table 151. Register 0x46—Highest Switching Frequency Limit Setting (Minimum Switching Cycle in Resonant Mode)

Bits	Bit Name	R/W	Description
[7:0]	Highest frequency	R/W	This register contains the eight MSBs of the 12-bit value of the highest switching frequency (minimum switching cycle) limit. This value is always used with the top four bits of Register 0x48, which contain the four LSBs of the highest switching frequency limit. Each LSB of the 12-bit value corresponds to 5 ns of resolution for the switching cycle. For example, if Register 0x46 is set to 0x10 (16 decimal) and Bits[7:4] of Register 0x48 are set to 0x9 (9 decimal), the minimum switching cycle is $(16 \times 16 + 9) \times 5 \text{ ns} = 1.325 \mu\text{s}$, and the highest switching frequency limit is $1/1.325 \mu\text{s} = 755 \text{ kHz}$. It is recommended that the maximum frequency be limited to 1 MHz.

Table 152. Register 0x47—OUTB Falling Edge Dead Time in Resonant Mode

Bits	Bit Name	R/W	Description																																																																								
[7:0]	Δt_4 (falling edge dead time of OUTB)	R/W	This register sets Δt_4 , which is the difference between the falling edge of OUTB and the mid-point of the switching cycle, t_B . Each LSB corresponds to 5 ns of resolution. When the register value is from 0x00 to 0x7F, the falling edge of OUTB is trailing t_B . When the value is from 0x80 to 0xFF, the falling edge of OUTB is leading t_B .																																																																								
			<table border="1"> <thead> <tr> <th>Bit 7</th> <th>Bit 6</th> <th>Bit 5</th> <th>Bit 4</th> <th>Bit 3</th> <th>Bit 2</th> <th>Bit 1</th> <th>Bit 0</th> <th>Δt_4</th> </tr> </thead> <tbody> <tr> <td>0</td> <td>0</td> <td>0</td> <td>0</td> <td>0</td> <td>0</td> <td>0</td> <td>0</td> <td>0 ns</td> </tr> <tr> <td>0</td> <td>0</td> <td>0</td> <td>0</td> <td>0</td> <td>0</td> <td>0</td> <td>1</td> <td>5 ns trailing</td> </tr> <tr> <td>...</td> <td>...</td> <td>...</td> <td>...</td> <td>...</td> <td>...</td> <td>...</td> <td>...</td> <td>...</td> </tr> <tr> <td>0</td> <td>1</td> <td>1</td> <td>1</td> <td>1</td> <td>1</td> <td>1</td> <td>1</td> <td>635 ns trailing</td> </tr> <tr> <td>1</td> <td>0</td> <td>0</td> <td>0</td> <td>0</td> <td>0</td> <td>0</td> <td>0</td> <td>640 ns leading</td> </tr> <tr> <td>...</td> <td>...</td> <td>...</td> <td>...</td> <td>...</td> <td>...</td> <td>...</td> <td>...</td> <td>...</td> </tr> <tr> <td>1</td> <td>1</td> <td>1</td> <td>1</td> <td>1</td> <td>1</td> <td>1</td> <td>1</td> <td>5 ns leading</td> </tr> </tbody> </table>	Bit 7	Bit 6	Bit 5	Bit 4	Bit 3	Bit 2	Bit 1	Bit 0	Δt_4	0	0	0	0	0	0	0	0	0 ns	0	0	0	0	0	0	0	1	5 ns trailing	0	1	1	1	1	1	1	1	635 ns trailing	1	0	0	0	0	0	0	0	640 ns leading	1	1	1	1	1	1	1	1	5 ns leading
Bit 7	Bit 6	Bit 5	Bit 4	Bit 3	Bit 2	Bit 1	Bit 0	Δt_4																																																																			
0	0	0	0	0	0	0	0	0 ns																																																																			
0	0	0	0	0	0	0	1	5 ns trailing																																																																			
...																																																																			
0	1	1	1	1	1	1	1	635 ns trailing																																																																			
1	0	0	0	0	0	0	0	640 ns leading																																																																			
...																																																																			
1	1	1	1	1	1	1	1	5 ns leading																																																																			

Table 153. Register 0x48—Highest Switching Frequency Limit Setting (Minimum Switching Cycle in Resonant Mode)

Bits	Bit Name	R/W	Description
[7:4]	Highest frequency	R/W	This register contains the four LSBs of the 12-bit value of the highest switching frequency (minimum switching cycle) limit. This value is always used with the eight bits of Register 0x46, which contain the eight MSBs of the highest switching frequency limit. Each LSB of the 12-bit value corresponds to 5 ns of resolution for the switching cycle. For example, if Register 0x46 is set to 0x10 (16 decimal) and Bits[7:4] of Register 0x48 are set to 0x9 (9 decimal), the minimum switching cycle is $(16 \times 16 + 9) \times 5 \text{ ns} = 1.325 \mu\text{s}$, and the highest switching frequency limit is $1/1.325 \mu\text{s} = 755 \text{ kHz}$.
[3:0]	Reserved	R/W	Reserved.

Table 154. Register 0x49—OUTC Rising Edge Dead Time in Resonant Mode

Bits	Bit Name	R/W	Description																																																																								
[7:0]	Δt_5 (rising edge dead time of OUTC)	R/W	This register sets Δt_5 , which is the difference between the rising edge of OUTC and the mid-point of the switching cycle, t_B . Each LSB corresponds to 5 ns of resolution. When the register value is from 0x00 to 0x7F, the rising edge of OUTC is trailing t_B . When the value is from 0x80 to 0xFF, the rising edge of OUTC is leading t_B .																																																																								
			<table border="1"> <thead> <tr> <th>Bit 7</th> <th>Bit 6</th> <th>Bit 5</th> <th>Bit 4</th> <th>Bit 3</th> <th>Bit 2</th> <th>Bit 1</th> <th>Bit 0</th> <th>Δt_5</th> </tr> </thead> <tbody> <tr> <td>0</td> <td>0</td> <td>0</td> <td>0</td> <td>0</td> <td>0</td> <td>0</td> <td>0</td> <td>0 ns</td> </tr> <tr> <td>0</td> <td>0</td> <td>0</td> <td>0</td> <td>0</td> <td>0</td> <td>0</td> <td>1</td> <td>5 ns trailing</td> </tr> <tr> <td>...</td> <td>...</td> <td>...</td> <td>...</td> <td>...</td> <td>...</td> <td>...</td> <td>...</td> <td>...</td> </tr> <tr> <td>0</td> <td>1</td> <td>1</td> <td>1</td> <td>1</td> <td>1</td> <td>1</td> <td>1</td> <td>635 ns trailing</td> </tr> <tr> <td>1</td> <td>0</td> <td>0</td> <td>0</td> <td>0</td> <td>0</td> <td>0</td> <td>0</td> <td>640 ns leading</td> </tr> <tr> <td>...</td> <td>...</td> <td>...</td> <td>...</td> <td>...</td> <td>...</td> <td>...</td> <td>...</td> <td>...</td> </tr> <tr> <td>1</td> <td>1</td> <td>1</td> <td>1</td> <td>1</td> <td>1</td> <td>1</td> <td>1</td> <td>5 ns leading</td> </tr> </tbody> </table>	Bit 7	Bit 6	Bit 5	Bit 4	Bit 3	Bit 2	Bit 1	Bit 0	Δt_5	0	0	0	0	0	0	0	0	0 ns	0	0	0	0	0	0	0	1	5 ns trailing	0	1	1	1	1	1	1	1	635 ns trailing	1	0	0	0	0	0	0	0	640 ns leading	1	1	1	1	1	1	1	1	5 ns leading
Bit 7	Bit 6	Bit 5	Bit 4	Bit 3	Bit 2	Bit 1	Bit 0	Δt_5																																																																			
0	0	0	0	0	0	0	0	0 ns																																																																			
0	0	0	0	0	0	0	1	5 ns trailing																																																																			
...																																																																			
0	1	1	1	1	1	1	1	635 ns trailing																																																																			
1	0	0	0	0	0	0	0	640 ns leading																																																																			
...																																																																			
1	1	1	1	1	1	1	1	5 ns leading																																																																			

Table 155. Register 0x4A—Burst Mode Operation in Resonant Mode

Bits	Bit Name	R/W	Description															
[7:6]	Burst mode enable	R/W	These bits are used to enable or disable burst mode operation.															
			<table border="1"> <thead> <tr> <th>Bit 7</th> <th>Bit 6</th> <th>Burst Mode</th> </tr> </thead> <tbody> <tr> <td>0</td> <td>0</td> <td>Disabled</td> </tr> <tr> <td>0</td> <td>1</td> <td>Enabled for normal operation, but disabled during soft start</td> </tr> <tr> <td>1</td> <td>0</td> <td>Disabled</td> </tr> <tr> <td>1</td> <td>1</td> <td>Enabled for normal operation and during soft start</td> </tr> </tbody> </table>	Bit 7	Bit 6	Burst Mode	0	0	Disabled	0	1	Enabled for normal operation, but disabled during soft start	1	0	Disabled	1	1	Enabled for normal operation and during soft start
Bit 7	Bit 6	Burst Mode																
0	0	Disabled																
0	1	Enabled for normal operation, but disabled during soft start																
1	0	Disabled																
1	1	Enabled for normal operation and during soft start																
[5:0]	Burst mode offset	R/W	These bits, along with the highest switching frequency limit, determine the threshold value for enabling burst mode operation. For information about how to set this value, see the Light Load Operation (Burst Mode) section. During burst mode, the PWM frequency is the maximum frequency limit set in Register 0x46.															

Table 156. Register 0x4B—OUTC Falling Edge Dead Time in Resonant Mode

Bits	Bit Name	R/W	Description																																													
[7:0]	Δt_6 (falling edge dead time of OUTC)	R/W	This register sets Δt_6 , which is the leading time of the falling edge of OUTC from the end of the switching cycle, t_C . Each LSB corresponds to 5 ns of resolution.																																													
			<table border="1"> <thead> <tr> <th>Bit 7</th> <th>Bit 6</th> <th>Bit 5</th> <th>Bit 4</th> <th>Bit 3</th> <th>Bit 2</th> <th>Bit 1</th> <th>Bit 0</th> <th>Δt_6 (ns)</th> </tr> </thead> <tbody> <tr> <td>0</td> <td>0</td> <td>0</td> <td>0</td> <td>0</td> <td>0</td> <td>0</td> <td>0</td> <td>0</td> </tr> <tr> <td>0</td> <td>0</td> <td>0</td> <td>0</td> <td>0</td> <td>0</td> <td>0</td> <td>1</td> <td>5</td> </tr> <tr> <td>...</td> <td>...</td> <td>...</td> <td>...</td> <td>...</td> <td>...</td> <td>...</td> <td>...</td> <td>...</td> </tr> <tr> <td>1</td> <td>1</td> <td>1</td> <td>1</td> <td>1</td> <td>1</td> <td>1</td> <td>1</td> <td>1275</td> </tr> </tbody> </table>	Bit 7	Bit 6	Bit 5	Bit 4	Bit 3	Bit 2	Bit 1	Bit 0	Δt_6 (ns)	0	0	0	0	0	0	0	0	0	0	0	0	0	0	0	0	1	5	1	1	1	1	1	1	1	1	1275
Bit 7	Bit 6	Bit 5	Bit 4	Bit 3	Bit 2	Bit 1	Bit 0	Δt_6 (ns)																																								
0	0	0	0	0	0	0	0	0																																								
0	0	0	0	0	0	0	1	5																																								
...																																								
1	1	1	1	1	1	1	1	1275																																								

Table 157. Register 0x4D—OUTD Rising Edge Dead Time in Resonant Mode

Bits	Bit Name	R/W	Description																																																																								
[7:0]	Δt_7 (rising edge dead time of OUTD)	R/W	This register sets Δt_7 , which is the difference between the rising edge of OUTD and the mid-point of the switching cycle, t_B . Each LSB corresponds to 5 ns of resolution. When the register value is from 0x00 to 0x7F, the rising edge of OUTD is trailing t_B . When the value is from 0x80 to 0xFF, the rising edge of OUTD is leading t_B .																																																																								
			<table border="1"> <thead> <tr> <th>Bit 7</th> <th>Bit 6</th> <th>Bit 5</th> <th>Bit 4</th> <th>Bit 3</th> <th>Bit 2</th> <th>Bit 1</th> <th>Bit 0</th> <th>Δt_7</th> </tr> </thead> <tbody> <tr> <td>0</td> <td>0</td> <td>0</td> <td>0</td> <td>0</td> <td>0</td> <td>0</td> <td>0</td> <td>0 ns</td> </tr> <tr> <td>0</td> <td>0</td> <td>0</td> <td>0</td> <td>0</td> <td>0</td> <td>0</td> <td>1</td> <td>5 ns trailing</td> </tr> <tr> <td>...</td> <td>...</td> <td>...</td> <td>...</td> <td>...</td> <td>...</td> <td>...</td> <td>...</td> <td>...</td> </tr> <tr> <td>0</td> <td>1</td> <td>1</td> <td>1</td> <td>1</td> <td>1</td> <td>1</td> <td>1</td> <td>635 ns trailing</td> </tr> <tr> <td>1</td> <td>0</td> <td>0</td> <td>0</td> <td>0</td> <td>0</td> <td>0</td> <td>0</td> <td>640 ns leading</td> </tr> <tr> <td>...</td> <td>...</td> <td>...</td> <td>...</td> <td>...</td> <td>...</td> <td>...</td> <td>...</td> <td>...</td> </tr> <tr> <td>1</td> <td>1</td> <td>1</td> <td>1</td> <td>1</td> <td>1</td> <td>1</td> <td>1</td> <td>5 ns leading</td> </tr> </tbody> </table>	Bit 7	Bit 6	Bit 5	Bit 4	Bit 3	Bit 2	Bit 1	Bit 0	Δt_7	0	0	0	0	0	0	0	0	0 ns	0	0	0	0	0	0	0	1	5 ns trailing	0	1	1	1	1	1	1	1	635 ns trailing	1	0	0	0	0	0	0	0	640 ns leading	1	1	1	1	1	1	1	1	5 ns leading
Bit 7	Bit 6	Bit 5	Bit 4	Bit 3	Bit 2	Bit 1	Bit 0	Δt_7																																																																			
0	0	0	0	0	0	0	0	0 ns																																																																			
0	0	0	0	0	0	0	1	5 ns trailing																																																																			
...																																																																			
0	1	1	1	1	1	1	1	635 ns trailing																																																																			
1	0	0	0	0	0	0	0	640 ns leading																																																																			
...																																																																			
1	1	1	1	1	1	1	1	5 ns leading																																																																			

Table 158. Register 0x4F—OUTD Falling Edge Dead Time in Resonant Mode

Bits	Bit Name	R/W	Description																																													
[7:0]	Δt_8 (falling edge dead time of OUTD)	R/W	This register sets Δt_8 , which is the leading time of the falling edge of OUTD from the end of the switching cycle, t_c . Each LSB corresponds to 5 ns of resolution.																																													
			<table border="1"> <thead> <tr> <th>Bit 7</th> <th>Bit 6</th> <th>Bit 5</th> <th>Bit 4</th> <th>Bit 3</th> <th>Bit 2</th> <th>Bit 1</th> <th>Bit 0</th> <th>Δt_8 (ns)</th> </tr> </thead> <tbody> <tr> <td>0</td> <td>0</td> <td>0</td> <td>0</td> <td>0</td> <td>0</td> <td>0</td> <td>0</td> <td>0</td> </tr> <tr> <td>0</td> <td>0</td> <td>0</td> <td>0</td> <td>0</td> <td>0</td> <td>0</td> <td>1</td> <td>5</td> </tr> <tr> <td>...</td> <td>...</td> <td>...</td> <td>...</td> <td>...</td> <td>...</td> <td>...</td> <td>...</td> <td>...</td> </tr> <tr> <td>1</td> <td>1</td> <td>1</td> <td>1</td> <td>1</td> <td>1</td> <td>1</td> <td>1</td> <td>1275</td> </tr> </tbody> </table>	Bit 7	Bit 6	Bit 5	Bit 4	Bit 3	Bit 2	Bit 1	Bit 0	Δt_8 (ns)	0	0	0	0	0	0	0	0	0	0	0	0	0	0	0	0	1	5	1	1	1	1	1	1	1	1	1275
Bit 7	Bit 6	Bit 5	Bit 4	Bit 3	Bit 2	Bit 1	Bit 0	Δt_8 (ns)																																								
0	0	0	0	0	0	0	0	0																																								
0	0	0	0	0	0	0	1	5																																								
...																																								
1	1	1	1	1	1	1	1	1275																																								

Table 159. Register 0x51—SR1 Rising Edge Dead Time in Resonant Mode

Bits	Bit Name	R/W	Description																																													
[7:0]	Δt_9 (rising edge dead time of SR1)	R/W	This register sets Δt_9 , which is the delay time of the rising edge of SR1 from the ACSNS rising edge, t_D . Each LSB corresponds to 5 ns of resolution.																																													
			<table border="1"> <thead> <tr> <th>Bit 7</th> <th>Bit 6</th> <th>Bit 5</th> <th>Bit 4</th> <th>Bit 3</th> <th>Bit 2</th> <th>Bit 1</th> <th>Bit 0</th> <th>Δt_9 (ns)</th> </tr> </thead> <tbody> <tr> <td>0</td> <td>0</td> <td>0</td> <td>0</td> <td>0</td> <td>0</td> <td>0</td> <td>0</td> <td>0</td> </tr> <tr> <td>0</td> <td>0</td> <td>0</td> <td>0</td> <td>0</td> <td>0</td> <td>0</td> <td>1</td> <td>5</td> </tr> <tr> <td>...</td> <td>...</td> <td>...</td> <td>...</td> <td>...</td> <td>...</td> <td>...</td> <td>...</td> <td>...</td> </tr> <tr> <td>1</td> <td>1</td> <td>1</td> <td>1</td> <td>1</td> <td>1</td> <td>1</td> <td>1</td> <td>1275</td> </tr> </tbody> </table>	Bit 7	Bit 6	Bit 5	Bit 4	Bit 3	Bit 2	Bit 1	Bit 0	Δt_9 (ns)	0	0	0	0	0	0	0	0	0	0	0	0	0	0	0	0	1	5	1	1	1	1	1	1	1	1	1275
Bit 7	Bit 6	Bit 5	Bit 4	Bit 3	Bit 2	Bit 1	Bit 0	Δt_9 (ns)																																								
0	0	0	0	0	0	0	0	0																																								
0	0	0	0	0	0	0	1	5																																								
...																																								
1	1	1	1	1	1	1	1	1275																																								

Table 160. Register 0x53—SR1 Falling Edge Dead Time in Resonant Mode

Bits	Bit Name	R/W	Description																																													
[7:0]	Δt_{10} (falling edge dead time of SR1)	R/W	This register sets Δt_{10} , which is the leading time of the falling edge of SR1 from the ACSNS falling edge, t_E . Each LSB corresponds to 5 ns of resolution.																																													
			<table border="1"> <thead> <tr> <th>Bit 7</th> <th>Bit 6</th> <th>Bit 5</th> <th>Bit 4</th> <th>Bit 3</th> <th>Bit 2</th> <th>Bit 1</th> <th>Bit 0</th> <th>Δt_{10} (ns)</th> </tr> </thead> <tbody> <tr> <td>0</td> <td>0</td> <td>0</td> <td>0</td> <td>0</td> <td>0</td> <td>0</td> <td>0</td> <td>0</td> </tr> <tr> <td>0</td> <td>0</td> <td>0</td> <td>0</td> <td>0</td> <td>0</td> <td>0</td> <td>1</td> <td>5</td> </tr> <tr> <td>...</td> <td>...</td> <td>...</td> <td>...</td> <td>...</td> <td>...</td> <td>...</td> <td>...</td> <td>...</td> </tr> <tr> <td>1</td> <td>1</td> <td>1</td> <td>1</td> <td>1</td> <td>1</td> <td>1</td> <td>1</td> <td>1275</td> </tr> </tbody> </table>	Bit 7	Bit 6	Bit 5	Bit 4	Bit 3	Bit 2	Bit 1	Bit 0	Δt_{10} (ns)	0	0	0	0	0	0	0	0	0	0	0	0	0	0	0	0	1	5	1	1	1	1	1	1	1	1	1275
Bit 7	Bit 6	Bit 5	Bit 4	Bit 3	Bit 2	Bit 1	Bit 0	Δt_{10} (ns)																																								
0	0	0	0	0	0	0	0	0																																								
0	0	0	0	0	0	0	1	5																																								
...																																								
1	1	1	1	1	1	1	1	1275																																								

Table 161. Register 0x55—SR2 Rising Edge Dead Time in Resonant Mode

Bits	Bit Name	R/W	Description																																													
[7:0]	Δt_{11} (rising edge dead time of SR2)	R/W	This register sets Δt_{11} , which is the delay time of the rising edge of SR2 from the ACSNS falling edge, t_E . Each LSB corresponds to 5 ns of resolution.																																													
			<table border="1"> <thead> <tr> <th>Bit 7</th> <th>Bit 6</th> <th>Bit 5</th> <th>Bit 4</th> <th>Bit 3</th> <th>Bit 2</th> <th>Bit 1</th> <th>Bit 0</th> <th>Δt_{11} (ns)</th> </tr> </thead> <tbody> <tr> <td>0</td> <td>0</td> <td>0</td> <td>0</td> <td>0</td> <td>0</td> <td>0</td> <td>0</td> <td>0</td> </tr> <tr> <td>0</td> <td>0</td> <td>0</td> <td>0</td> <td>0</td> <td>0</td> <td>0</td> <td>1</td> <td>5</td> </tr> <tr> <td>...</td> <td>...</td> <td>...</td> <td>...</td> <td>...</td> <td>...</td> <td>...</td> <td>...</td> <td>...</td> </tr> <tr> <td>1</td> <td>1</td> <td>1</td> <td>1</td> <td>1</td> <td>1</td> <td>1</td> <td>1</td> <td>1275</td> </tr> </tbody> </table>	Bit 7	Bit 6	Bit 5	Bit 4	Bit 3	Bit 2	Bit 1	Bit 0	Δt_{11} (ns)	0	0	0	0	0	0	0	0	0	0	0	0	0	0	0	0	1	5	1	1	1	1	1	1	1	1	1275
Bit 7	Bit 6	Bit 5	Bit 4	Bit 3	Bit 2	Bit 1	Bit 0	Δt_{11} (ns)																																								
0	0	0	0	0	0	0	0	0																																								
0	0	0	0	0	0	0	1	5																																								
...																																								
1	1	1	1	1	1	1	1	1275																																								

Table 162. Register 0x57—SR2 Falling Edge Dead Time in Resonant Mode

Bits	Bit Name	R/W	Description																																													
[7:0]	Δt_{12} (falling edge dead time of SR2)	R/W	This register sets Δt_{12} , which is the leading time of the falling edge of SR2 from the ACSNS rising edge, t_F . Each LSB corresponds to 5 ns of resolution.																																													
			<table border="1"> <thead> <tr> <th>Bit 7</th> <th>Bit 6</th> <th>Bit 5</th> <th>Bit 4</th> <th>Bit 3</th> <th>Bit 2</th> <th>Bit 1</th> <th>Bit 0</th> <th>Δt_{12} (ns)</th> </tr> </thead> <tbody> <tr> <td>0</td> <td>0</td> <td>0</td> <td>0</td> <td>0</td> <td>0</td> <td>0</td> <td>0</td> <td>0</td> </tr> <tr> <td>0</td> <td>0</td> <td>0</td> <td>0</td> <td>0</td> <td>0</td> <td>0</td> <td>1</td> <td>5</td> </tr> <tr> <td>...</td> <td>...</td> <td>...</td> <td>...</td> <td>...</td> <td>...</td> <td>...</td> <td>...</td> <td>...</td> </tr> <tr> <td>1</td> <td>1</td> <td>1</td> <td>1</td> <td>1</td> <td>1</td> <td>1</td> <td>1</td> <td>1275</td> </tr> </tbody> </table>	Bit 7	Bit 6	Bit 5	Bit 4	Bit 3	Bit 2	Bit 1	Bit 0	Δt_{12} (ns)	0	0	0	0	0	0	0	0	0	0	0	0	0	0	0	0	1	5	1	1	1	1	1	1	1	1	1275
Bit 7	Bit 6	Bit 5	Bit 4	Bit 3	Bit 2	Bit 1	Bit 0	Δt_{12} (ns)																																								
0	0	0	0	0	0	0	0	0																																								
0	0	0	0	0	0	0	1	5																																								
...																																								
1	1	1	1	1	1	1	1	1275																																								

OUTLINE DIMENSIONS

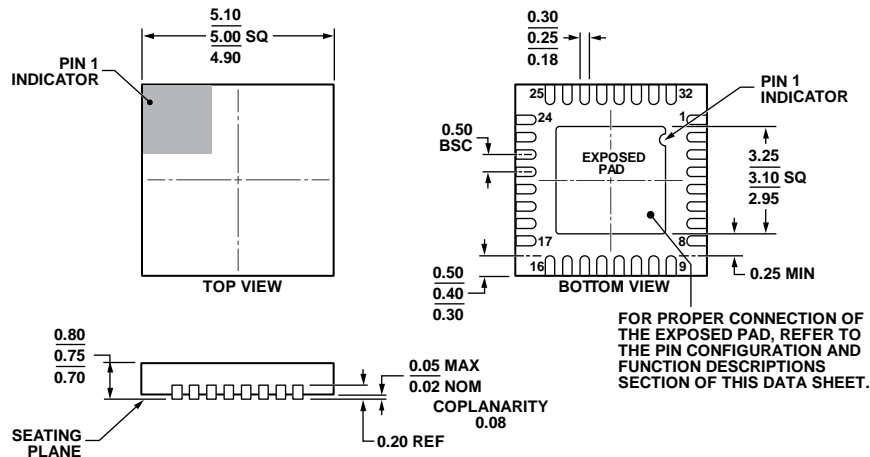

COMPLIANT TO JEDEC STANDARDS MO-220-WHHD.

Figure 63. 32-Lead Lead Frame Chip Scale Package [LFCSP_WQ]
5 mm × 5 mm Body, Very Very Thin Quad
(CP-32-7)

Dimensions shown in millimeters

112408-A

ORDERING GUIDE

Model ^{1, 2}	Temperature Range	Package Description	Package Option
ADP1046AWACPZ-R7	-40°C to +125°C	32-Lead Lead Frame Chip Scale Package [LFCSP_WQ]	CP-32-7
ADP1046A-100-EVALZ		ADP1046AW 100 W Evaluation Board	
ADP1046ADC1-EVALZ		ADP1046AW Daughter Card	
ADP-I2C-USB-Z		USB to I ² C Adapter	

¹ Z = RoHS Compliant Part.

² W = Qualified for Automotive Applications.

AUTOMOTIVE PRODUCTS

The [ADP1046AW](#) models are available with controlled manufacturing to support the quality and reliability requirements of automotive applications. Note that these automotive models may have specifications that differ from the commercial models; therefore, designers should review the Specifications section of this data sheet carefully. Only the automotive grade products shown are available for use in automotive applications. Contact your local Analog Devices account representative for specific product ordering information and to obtain the specific Automotive Reliability reports for these models.

I²C refers to a communications protocol originally developed by Philips Semiconductors (now NXP Semiconductors).

Компания «Океан Электроники» предлагает заключение долгосрочных отношений при поставках импортных электронных компонентов на взаимовыгодных условиях!

Наши преимущества:

- Поставка оригинальных импортных электронных компонентов напрямую с производств Америки, Европы и Азии, а так же с крупнейших складов мира;
- Широкая линейка поставок активных и пассивных импортных электронных компонентов (более 30 млн. наименований);
- Поставка сложных, дефицитных, либо снятых с производства позиций;
- Оперативные сроки поставки под заказ (от 5 рабочих дней);
- Экспресс доставка в любую точку России;
- Помощь Конструкторского Отдела и консультации квалифицированных инженеров;
- Техническая поддержка проекта, помощь в подборе аналогов, поставка прототипов;
- Поставка электронных компонентов под контролем ВП;
- Система менеджмента качества сертифицирована по Международному стандарту ISO 9001;
- При необходимости вся продукция военного и аэрокосмического назначения проходит испытания и сертификацию в лаборатории (по согласованию с заказчиком);
- Поставка специализированных компонентов военного и аэрокосмического уровня качества (Xilinx, Altera, Analog Devices, Intersil, Interpoint, Microsemi, Actel, Aeroflex, Peregrine, VPT, Syfer, Eurofarad, Texas Instruments, MS Kennedy, Miteq, Cobham, E2V, MA-COM, Hittite, Mini-Circuits, General Dynamics и др.);

Компания «Океан Электроники» является официальным дистрибьютором и эксклюзивным представителем в России одного из крупнейших производителей разъемов военного и аэрокосмического назначения «JONHON», а так же официальным дистрибьютором и эксклюзивным представителем в России производителя высокотехнологичных и надежных решений для передачи СВЧ сигналов «FORSTAR».



JONHON

«JONHON» (основан в 1970 г.)

Разъемы специального, военного и аэрокосмического назначения:

(Применяются в военной, авиационной, аэрокосмической, морской, железнодорожной, горно- и нефтедобывающей отраслях промышленности)

«FORSTAR» (основан в 1998 г.)

ВЧ соединители, коаксиальные кабели,
кабельные сборки и микроволновые компоненты:

(Применяются в телекоммуникациях гражданского и специального назначения, в средствах связи, РЛС, а так же военной, авиационной и аэрокосмической отраслях промышленности).



Телефон: 8 (812) 309-75-97 (многоканальный)

Факс: 8 (812) 320-03-32

Электронная почта: ocean@oceanchips.ru

Web: <http://oceanchips.ru/>

Адрес: 198099, г. Санкт-Петербург, ул. Калинина, д. 2, корп. 4, лит. А