

## E Series Power MOSFET

**Thin-Lead TO-220 FULLPAK**

### FEATURES

- Low figure-of-merit (FOM)  $R_{on} \times Q_g$
- Low input capacitance ( $C_{iss}$ )
- Reduced switching and conduction losses
- Ultra low gate charge ( $Q_g$ )
- Avalanche energy rated (UIS)
- Material categorization: for definitions of compliance please see [www.vishay.com/doc?99912](http://www.vishay.com/doc?99912)

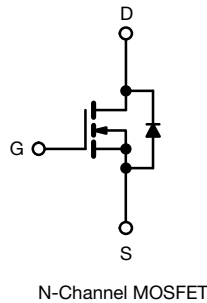

**RoHS**  
COMPLIANT  
HALOGEN  
**FREE**

### APPLICATIONS

- Server and telecom power supplies
- Switch mode power supplies (SMPS)
- Power factor correction power supplies (PFC)
- Lighting
  - High-intensity discharge (HID)
  - Fluorescent ballast lighting
- Industrial
  - Welding
  - Induction heating
  - Motor drives
  - Battery chargers
  - Renewable energy
  - Solar (PV inverters)

### PRODUCT SUMMARY

$V_{DS}$ (V) at $T_J$ max.	850	
$R_{DS(on)}$ typ. ( $\Omega$ ) at 25 °C	$V_{GS} = 10$ V	1.1
$Q_g$ max. (nC)	32	
$Q_{gs}$ (nC)	4	
$Q_{gd}$ (nC)	6	
Configuration	Single	

### ORDERING INFORMATION

Package	Thin-lead TO-220 FULLPAK
Lead (Pb)-free and halogen-free	SiHA4N80E-GE3

### ABSOLUTE MAXIMUM RATINGS ( $T_C = 25$ °C, unless otherwise noted)

PARAMETER	SYMBOL	LIMIT	UNIT
Drain-source voltage	$V_{DS}$	800	V
Gate-source voltage	$V_{GS}$	$\pm 30$	
Continuous drain current ( $T_J = 150$ °C) <sup>e</sup>	$V_{GS}$ at 10 V	$T_C = 25$ °C	A
		$T_C = 100$ °C	
Pulsed drain current <sup>a</sup>	$I_{DM}$	11	
Linear derating factor		0.24	W/°C
Single pulse avalanche energy <sup>b</sup>	$E_{AS}$	56	mJ
Maximum power dissipation	$P_D$	69	W
Operating junction and storage temperature range	$T_J, T_{stg}$	-55 to +150	°C
Drain-source voltage slope	dv/dt	$T_J = 125$ °C	70
Reverse diode dv/dt <sup>d</sup>		0.3	
Soldering recommendations (peak temperature) <sup>c</sup>	For 10 s	300	°C
Mounting torque	M3 screw	0.6	Nm

#### Notes

- Repetitive rating; pulse width limited by maximum junction temperature
- $V_{DD} = 140$  V, starting  $T_J = 25$  °C,  $L = 28.2$  mH,  $R_g = 25$   $\Omega$ ,  $I_{AS} = 2.0$  A
- 1.6 mm from case
- $I_{SD} \leq I_D$ ,  $di/dt = 100$  A/ $\mu$ s, starting  $T_J = 25$  °C
- Limited by maximum junction temperature



THERMAL RESISTANCE RATINGS				
PARAMETER	SYMBOL	TYP.	MAX.	UNIT
Maximum junction-to-ambient	R <sub>thJA</sub>	-	65	°C/W
Maximum junction-to-case (drain)	R <sub>thJC</sub>	-	4.1	

SPECIFICATIONS (T <sub>J</sub> = 25 °C, unless otherwise noted)							
PARAMETER	SYMBOL	TEST CONDITIONS		MIN.	TYP.	MAX.	UNIT
<b>Static</b>							
Drain-source breakdown voltage	V <sub>DS</sub>	V <sub>GS</sub> = 0 V, I <sub>D</sub> = 250 μA		800	-	-	V
V <sub>DS</sub> temperature coefficient	ΔV <sub>DS</sub> /T <sub>J</sub>	Reference to 25 °C, I <sub>D</sub> = 1 mA		-	1.1	-	V/°C
Gate-source threshold Voltage (N)	V <sub>GS(th)</sub>	V <sub>DS</sub> = V <sub>GS</sub> , I <sub>D</sub> = 250 μA		2.0	-	4.0	V
Gate-source leakage	I <sub>GSS</sub>	V <sub>GS</sub> = ± 20 V		-	-	± 100	nA
		V <sub>GS</sub> = ± 30 V		-	-	± 1	μA
Zero gate voltage drain current	I <sub>DSS</sub>	V <sub>DS</sub> = 800 V, V <sub>GS</sub> = 0 V		-	-	1	μA
		V <sub>DS</sub> = 640 V, V <sub>GS</sub> = 0 V, T <sub>J</sub> = 125 °C		-	-	10	
Drain-source on-state resistance	R <sub>DS(on)</sub>	V <sub>GS</sub> = 10 V	I <sub>D</sub> = 2 A	-	1.1	1.27	Ω
Forward transconductance	g <sub>fs</sub>	V <sub>DS</sub> = 30 V, I <sub>D</sub> = 2 A		-	1.5	-	S
<b>Dynamic</b>							
Input capacitance	C <sub>iss</sub>	V <sub>GS</sub> = 0 V, V <sub>DS</sub> = 100 V, f = 1 MHz		-	622	-	pF
Output capacitance	C <sub>oss</sub>			-	34	-	
Reverse transfer capacitance	C <sub>rss</sub>			-	5	-	
Effective output capacitance, energy related <sup>a</sup>	C <sub>o(er)</sub>			-	21	-	
Effective output capacitance, time related <sup>b</sup>	C <sub>o(tr)</sub>	V <sub>DS</sub> = 0 V to 480 V, V <sub>GS</sub> = 0 V		-	91	-	
Total gate charge	Q <sub>g</sub>	V <sub>GS</sub> = 10 V	I <sub>D</sub> = 2 A, V <sub>DS</sub> = 480 V	-	16	32	nC
Gate-source charge	Q <sub>gs</sub>			-	4	-	
Gate-drain charge	Q <sub>gd</sub>			-	6	-	
Turn-on delay time	t <sub>d(on)</sub>	V <sub>DD</sub> = 480 V, I <sub>D</sub> = 2 A, V <sub>GS</sub> = 10 V, R <sub>g</sub> = 9.1 Ω		-	12	24	ns
Rise time	t <sub>r</sub>			-	7	14	
Turn-off delay time	t <sub>d(off)</sub>			-	26	52	
Fall time	t <sub>f</sub>			-	20	40	
Gate input resistance	R <sub>g</sub>			f = 1 MHz, open drain		0.6	
<b>Drain-Source Body Diode Characteristics</b>							
Continuous source-drain diode current	I <sub>S</sub>	MOSFET symbol showing the integral reverse p - n junction diode 		-	-	4.4	A
Pulsed diode forward current	I <sub>SM</sub>			-	-	11	
Diode forward voltage	V <sub>SD</sub>	T <sub>J</sub> = 25 °C, I <sub>S</sub> = 2 A, V <sub>GS</sub> = 0 V		-	-	1.2	V
Reverse recovery time	t <sub>rr</sub>	T <sub>J</sub> = 25 °C, I <sub>F</sub> = I <sub>S</sub> = 2 A, di/dt = 100 A/μs, V <sub>R</sub> = 25 V		-	248	496	ns
Reverse recovery charge	Q <sub>rr</sub>			-	1.4	2.8	μC
Reverse recovery current	I <sub>RRM</sub>			-	9.2	-	A

**Notes**

- a. C<sub>oss(er)</sub> is a fixed capacitance that gives the same energy as C<sub>oss</sub> while V<sub>DS</sub> is rising from 0 V to 480 V V<sub>DSS</sub>
- b. C<sub>oss(tr)</sub> is a fixed capacitance that gives the same charging time as C<sub>oss</sub> while V<sub>DS</sub> is rising from 0 V to 480 V V<sub>DSS</sub>

**TYPICAL CHARACTERISTICS** (25 °C, unless otherwise noted)

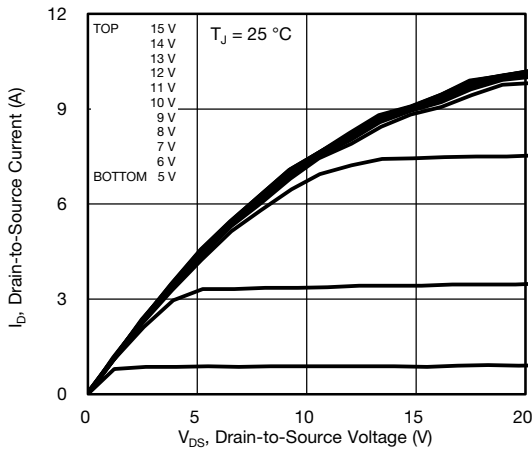

**Fig. 1 - Typical Output Characteristics**

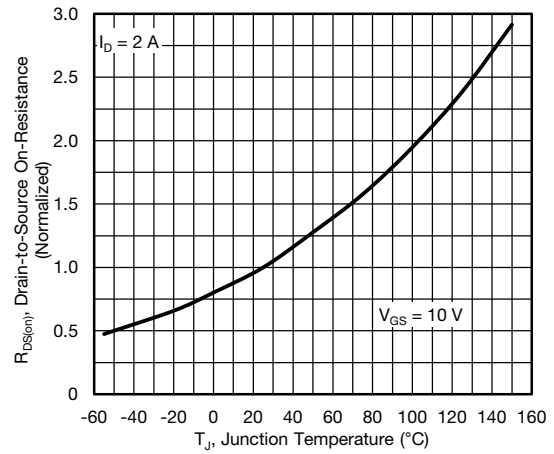

**Fig. 4 - Normalized On-Resistance vs. Temperature**

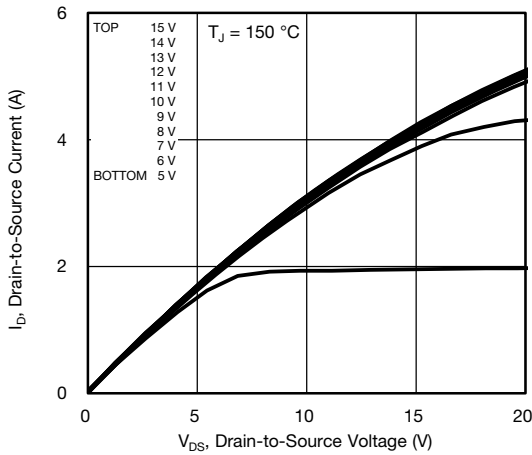

**Fig. 2 - Typical Output Characteristics**

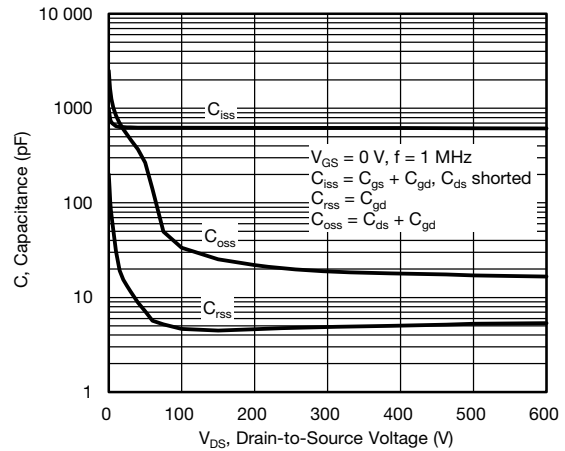

**Fig. 5 - Typical Capacitance vs. Drain-to-Source Voltage**

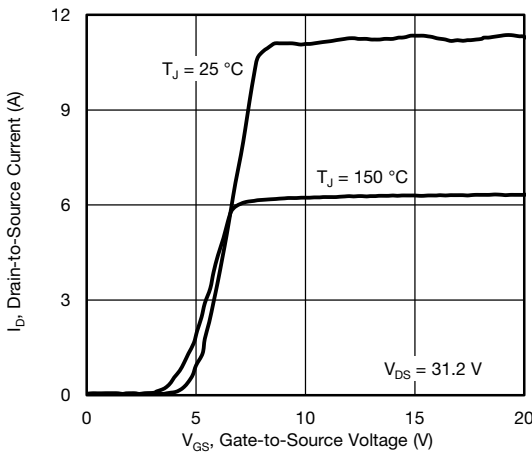

**Fig. 3 - Typical Transfer Characteristics**

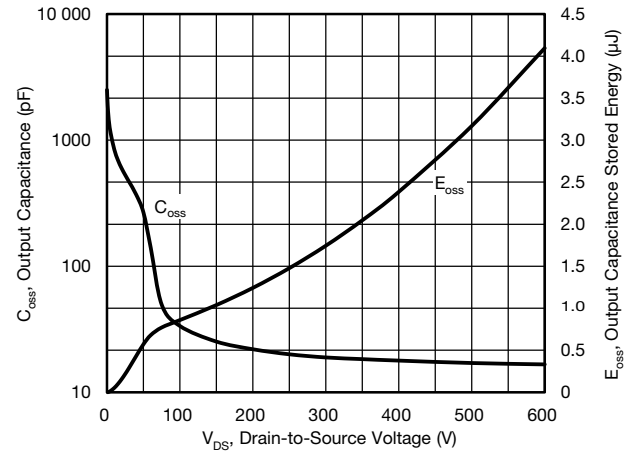

**Fig. 6 -  $C_{oss}$  and  $E_{oss}$  vs.  $V_{DS}$**

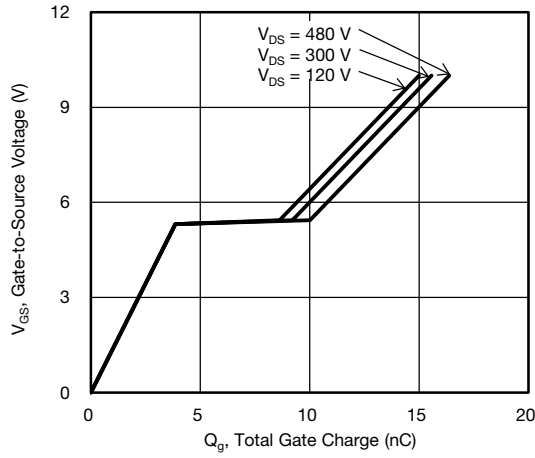

Fig. 7 - Typical Gate Charge vs. Gate-to-Source Voltage

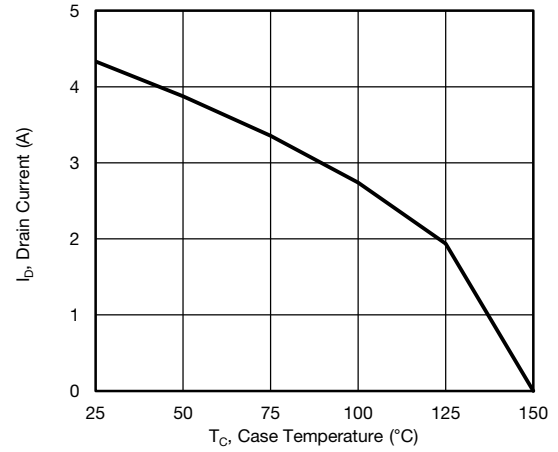

Fig. 10 - Maximum Drain Current vs. Case Temperature

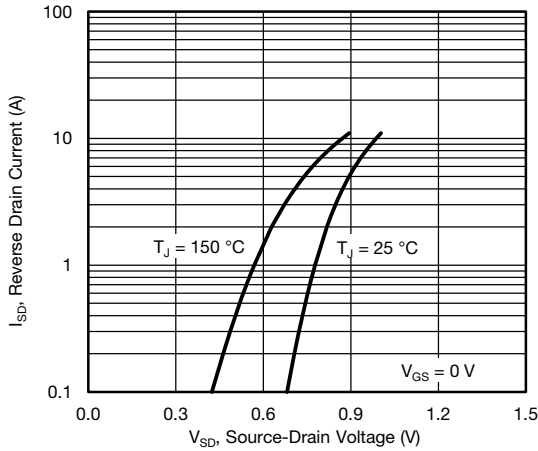

Fig. 8 - Typical Source-Drain Diode Forward Voltage

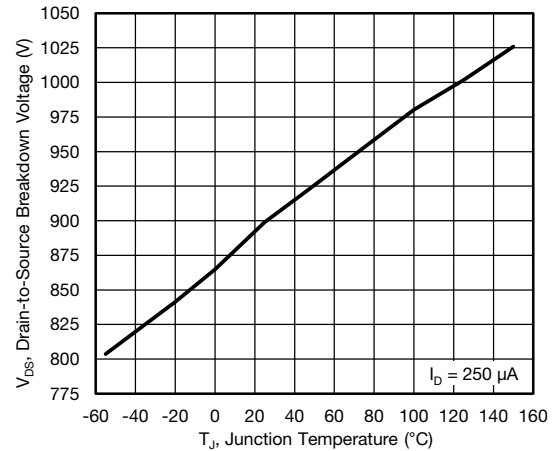

Fig. 11 - Temperature vs. Drain-to-Source Voltage

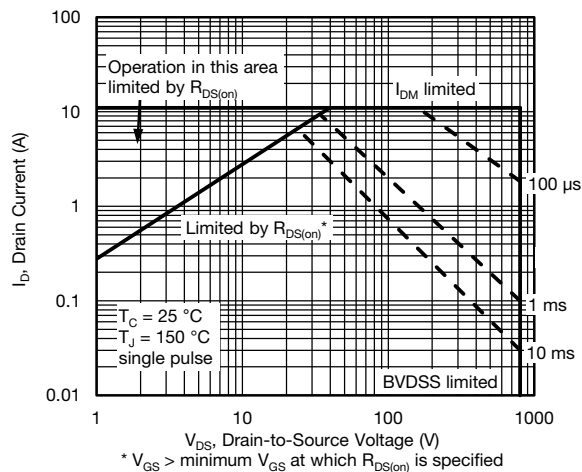

Fig. 9 - Maximum Safe Operating Area

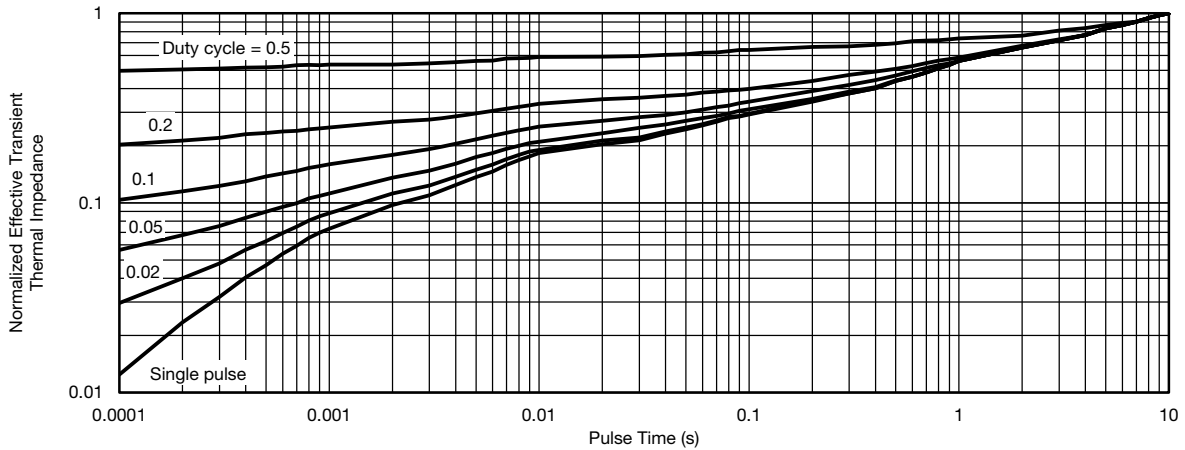

Fig. 12 - Normalized Thermal Transient Impedance, Junction-to-Case



Fig. 13 - Switching Time Test Circuit

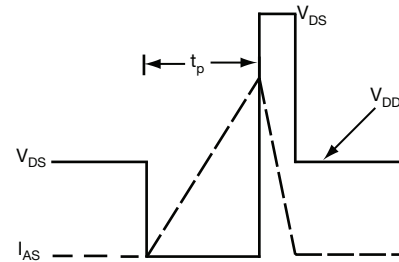

Fig. 16 - Unclamped Inductive Waveforms

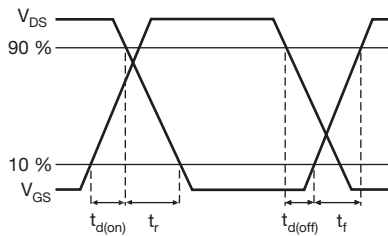

Fig. 14 - Switching Time Waveforms

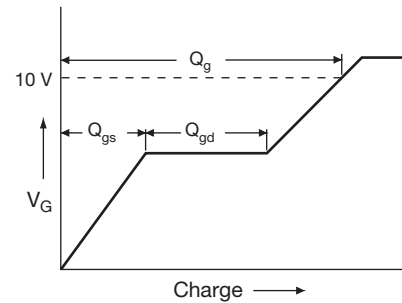

Fig. 17 - Basic Gate Charge Waveform

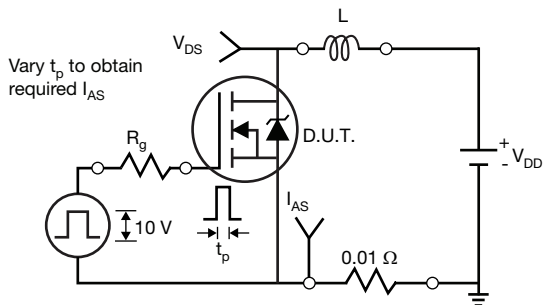

Fig. 15 - Unclamped Inductive Test Circuit

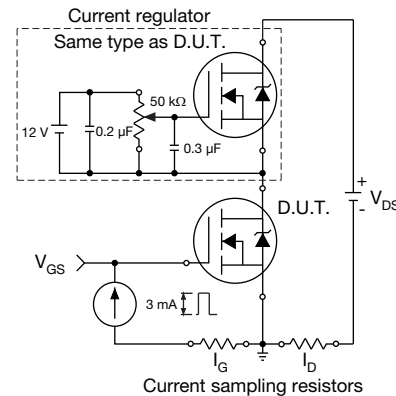
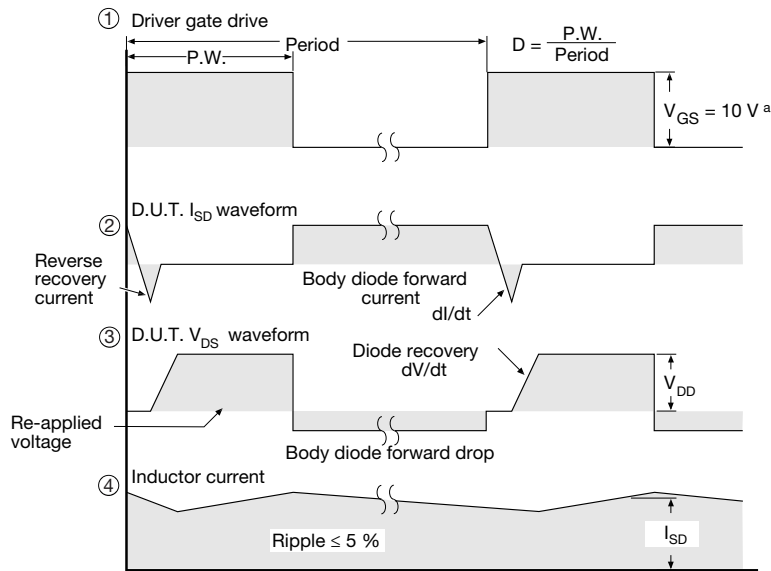
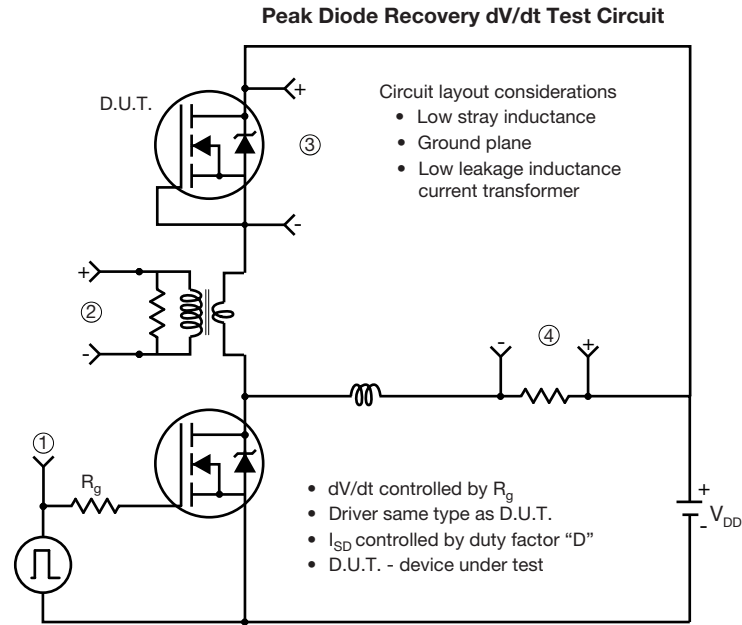

Fig. 18 - Gate Charge Test Circuit



**Note**  
 a.  $V_{GS} = 5 V$  for logic level devices

**Fig. 19 - For N-Channel**

Vishay Siliconix maintains worldwide manufacturing capability. Products may be manufactured at one of several qualified locations. Reliability data for Silicon Technology and Package Reliability represent a composite of all qualified locations. For related documents such as package/tape drawings, part marking, and reliability data, see [www.vishay.com/ppg?92020](http://www.vishay.com/ppg?92020).



## **Disclaimer**

ALL PRODUCT, PRODUCT SPECIFICATIONS AND DATA ARE SUBJECT TO CHANGE WITHOUT NOTICE TO IMPROVE RELIABILITY, FUNCTION OR DESIGN OR OTHERWISE.

Vishay Intertechnology, Inc., its affiliates, agents, and employees, and all persons acting on its or their behalf (collectively, "Vishay"), disclaim any and all liability for any errors, inaccuracies or incompleteness contained in any datasheet or in any other disclosure relating to any product.

Vishay makes no warranty, representation or guarantee regarding the suitability of the products for any particular purpose or the continuing production of any product. To the maximum extent permitted by applicable law, Vishay disclaims (i) any and all liability arising out of the application or use of any product, (ii) any and all liability, including without limitation special, consequential or incidental damages, and (iii) any and all implied warranties, including warranties of fitness for particular purpose, non-infringement and merchantability.

Statements regarding the suitability of products for certain types of applications are based on Vishay's knowledge of typical requirements that are often placed on Vishay products in generic applications. Such statements are not binding statements about the suitability of products for a particular application. It is the customer's responsibility to validate that a particular product with the properties described in the product specification is suitable for use in a particular application. Parameters provided in datasheets and / or specifications may vary in different applications and performance may vary over time. All operating parameters, including typical parameters, must be validated for each customer application by the customer's technical experts. Product specifications do not expand or otherwise modify Vishay's terms and conditions of purchase, including but not limited to the warranty expressed therein.

Except as expressly indicated in writing, Vishay products are not designed for use in medical, life-saving, or life-sustaining applications or for any other application in which the failure of the Vishay product could result in personal injury or death. Customers using or selling Vishay products not expressly indicated for use in such applications do so at their own risk. Please contact authorized Vishay personnel to obtain written terms and conditions regarding products designed for such applications.

No license, express or implied, by estoppel or otherwise, to any intellectual property rights is granted by this document or by any conduct of Vishay. Product names and markings noted herein may be trademarks of their respective owners.

Компания «Океан Электроники» предлагает заключение долгосрочных отношений при поставках импортных электронных компонентов на взаимовыгодных условиях!

Наши преимущества:

- Поставка оригинальных импортных электронных компонентов напрямую с производств Америки, Европы и Азии, а так же с крупнейших складов мира;
- Широкая линейка поставок активных и пассивных импортных электронных компонентов (более 30 млн. наименований);
- Поставка сложных, дефицитных, либо снятых с производства позиций;
- Оперативные сроки поставки под заказ (от 5 рабочих дней);
- Экспресс доставка в любую точку России;
- Помощь Конструкторского Отдела и консультации квалифицированных инженеров;
- Техническая поддержка проекта, помощь в подборе аналогов, поставка прототипов;
- Поставка электронных компонентов под контролем ВП;
- Система менеджмента качества сертифицирована по Международному стандарту ISO 9001;
- При необходимости вся продукция военного и аэрокосмического назначения проходит испытания и сертификацию в лаборатории (по согласованию с заказчиком);
- Поставка специализированных компонентов военного и аэрокосмического уровня качества (Xilinx, Altera, Analog Devices, Intersil, Interpoint, Microsemi, Actel, Aeroflex, Peregrine, VPT, Syfer, Eurofarad, Texas Instruments, MS Kennedy, Miteq, Cobham, E2V, MA-COM, Hittite, Mini-Circuits, General Dynamics и др.);

Компания «Океан Электроники» является официальным дистрибьютором и эксклюзивным представителем в России одного из крупнейших производителей разъемов военного и аэрокосмического назначения «JONHON», а так же официальным дистрибьютором и эксклюзивным представителем в России производителя высокотехнологичных и надежных решений для передачи СВЧ сигналов «FORSTAR».



## JONHON

«JONHON» (основан в 1970 г.)

Разъемы специального, военного и аэрокосмического назначения:

(Применяются в военной, авиационной, аэрокосмической, морской, железнодорожной, горно- и нефтедобывающей отраслях промышленности)

«FORSTAR» (основан в 1998 г.)

ВЧ соединители, коаксиальные кабели, кабельные сборки и микроволновые компоненты:

(Применяются в телекоммуникациях гражданского и специального назначения, в средствах связи, РЛС, а так же военной, авиационной и аэрокосмической отраслях промышленности).



Телефон: 8 (812) 309-75-97 (многоканальный)

Факс: 8 (812) 320-03-32

Электронная почта: [ocean@oceanchips.ru](mailto:ocean@oceanchips.ru)

Web: <http://oceanchips.ru/>

Адрес: 198099, г. Санкт-Петербург, ул. Калинина, д. 2, корп. 4, лит. А