

THIS DRAWING IS UNPUBLISHED. RELEASED FOR PUBLICATION 20  
 © COPYRIGHT 20 BY - ALL RIGHTS RESERVED.

LOC		DIST		REVISIONS			
P	LTR	DESCRIPTION		DATE	DWN	APVD	
	A4	REVISED PER ECR-13-007047		16MAY2013	RS	DD	
	A5	REVISED PER ECR-15-003564		13MAR2015	RS	DD	
	B	REVISED PER ECR-15-004054		28JUL2015	RS	DD	
	C	REVISED PER ECR-15-017995		18DEC2015	RS	DD	

1 MATERIALS AND FINISH:  
 - HOUSING: LCP, COLOR: NATURAL  
 - CONTACTS: COPPER ALLOY, FINISH: Sn OVER Ni

2. COMPLY WITH DIRECTIVE 2002/95/EC (ROHS).

3. 18-24AWG SOLID OR STRANDED WIRE.  
 PLEASE REFER TO APPLICATION SPEC 114-13266  
 FOR RECOMMENDED STRAND COUNT.  
 18AWG MAX INSULATION OD: 2.20  
 20AWG MAX INSULATION OD: 1.90  
 22AWG MAX INSULATION OD: 1.70  
 24AWG MAX INSULATION OD: 1.45

4. PACKAGE IN TAPE AND REEL. PER EIA-481 SPECIFICATION;  
 (EXCEPT 1 POSITION CONNECTOR).

5 WIRE SIZE MARKING IN APPROXIMATE LOCATION SHOWN.

6 DATUMS AND BASIC DIMENSIONS ESTABLISHED BY CUSTOMER.

7 COLOR CODE MARKING, STRAIGHT LINE.

8 1 POSITION ASSEMBLY DOES NOT COMPLY WITH EIA 481 SPECIFICATION.

COLOR CODE	DIM D	WIRE SIZE	POSN	COLOR	PART NUMBER
RED	17.70	24 AWG	4	BLACK	7-2106003-4
	13.70	24 AWG	3	BLACK	7-2106003-3
	9.70	24 AWG	2	BLACK	7-2106003-2
	5.70	24 AWG	1	BLACK	7-2106003-1 <sup>8</sup>
GREEN	17.70	22 AWG	4	BLACK	6-2106003-4
	13.70	22 AWG	3	BLACK	6-2106003-3
	9.70	22 AWG	2	BLACK	6-2106003-2
	5.70	22 AWG	1	BLACK	6-2106003-1 <sup>8</sup>
BLUE	17.70	20 AWG	4	BLACK	5-2106003-4
	13.70	20 AWG	3	BLACK	5-2106003-3
	9.70	20 AWG	2	BLACK	5-2106003-2
	5.70	20 AWG	1	BLACK	5-2106003-1 <sup>8</sup>
YELLOW	17.70	18 AWG	4	BLACK	4-2106003-4
	13.70	18 AWG	3	BLACK	4-2106003-3
	9.70	18 AWG	2	BLACK	4-2106003-2
	5.70	18 AWG	1	BLACK	4-2106003-1 <sup>8</sup>
RED	17.70	24 AWG	4	NATURAL	3-2106003-4
	13.70	24 AWG	3	NATURAL	3-2106003-3
	9.70	24 AWG	2	NATURAL	3-2106003-2
	5.70	24 AWG	1	NATURAL	3-2106003-1 <sup>8</sup>
GREEN	17.70	22 AWG	4	NATURAL	2-2106003-4
	13.70	22 AWG	3	NATURAL	2-2106003-3
	9.70	22 AWG	2	NATURAL	2-2106003-2
	5.70	22 AWG	1	NATURAL	2-2106003-1 <sup>8</sup>
BLUE	17.70	20 AWG	4	NATURAL	1-2106003-4
	13.70	20 AWG	3	NATURAL	1-2106003-3
	9.70	20 AWG	2	NATURAL	1-2106003-2
	5.70	20 AWG	1	NATURAL	1-2106003-1 <sup>8</sup>
YELLOW	17.70	18 AWG	4	NATURAL	2106003-4
	13.70	18 AWG	3	NATURAL	2106003-3
	9.70	18 AWG	2	NATURAL	2106003-2
	5.70	18 AWG	1	NATURAL	2106003-1 <sup>8</sup>

THIS DRAWING IS A CONTROLLED DOCUMENT.		DWN C DAILY 09DEC2008	<b>STE</b> TE Connectivity	
		CHK J DYER 09DEC2008		
DIMENSIONS: mm	TOLERANCES UNLESS OTHERWISE SPECIFIED:	APVD -	NAME ASSEMBLY, IDC SSL CONNECTOR, SMT, CLOSED END	
	0 PLC ± 1 PLC ±0.5 2 PLC ±0.13 3 PLC ± 4 PLC ±	PRODUCT SPEC 108-2404	SIZE A2	CAGE CODE 00779
MATERIAL	ANGLES ± FINISH	APPLICATION SPEC 114-13266	DRAWING NO C-2106003	RESTRICTED TO -
		WEIGHT -	SCALE 2:1	SHEET 1 OF 4
Customer Drawing			REV C	

THIS DRAWING IS UNPUBLISHED. RELEASED FOR PUBLICATION 20  
 © COPYRIGHT 20 BY - ALL RIGHTS RESERVED.

LOC		DIST		REVISIONS			
P	LTR	DESCRIPTION		DATE	DWN	APVD	
-	-	SEE SHEET 1		-	-	-	



2 POSITION  
SHOWN AS SHIPPED



FOR 1 POSITION ONLY



2 POSITION  
SHOWN CLOSED  
SCALE 8:1



FOR 2, 3 AND 4 POSITIONS

THIS DRAWING IS A CONTROLLED DOCUMENT.		DWN C DAILY 09DEC2008	<b>STE</b> TE Connectivity	
		CHK J DYER 09DEC2008		
DIMENSIONS:		APVD -	NAME ASSEMBLY, IDC SSL CONNECTOR, SMT, CLOSED END	
mm	TOLERANCES UNLESS OTHERWISE SPECIFIED:	PRODUCT SPEC 108-2404	SIZE A2	CAGE CODE 00779
	0 PLC ±	APPLICATION SPEC 114-13266	DRAWING NO C-2106003	RESTRICTED TO -
	1 PLC ±0.5	WEIGHT -	SCALE 2:1	SHEET 1
	2 PLC ±0.13		OF 4	REV C
	3 PLC ±			
	4 PLC ±			
MATERIAL	FINISH	Customer Drawing		
material_2	finish_spec_2			

THIS DRAWING IS UNPUBLISHED. RELEASED FOR PUBLICATION 20  
 © COPYRIGHT 20 BY - ALL RIGHTS RESERVED.

LOC		DIST		REVISIONS				
P	LTR	DESCRIPTION			DATE	DWN	APVD	
-	-	SEE SHEET 1			-	-	-	

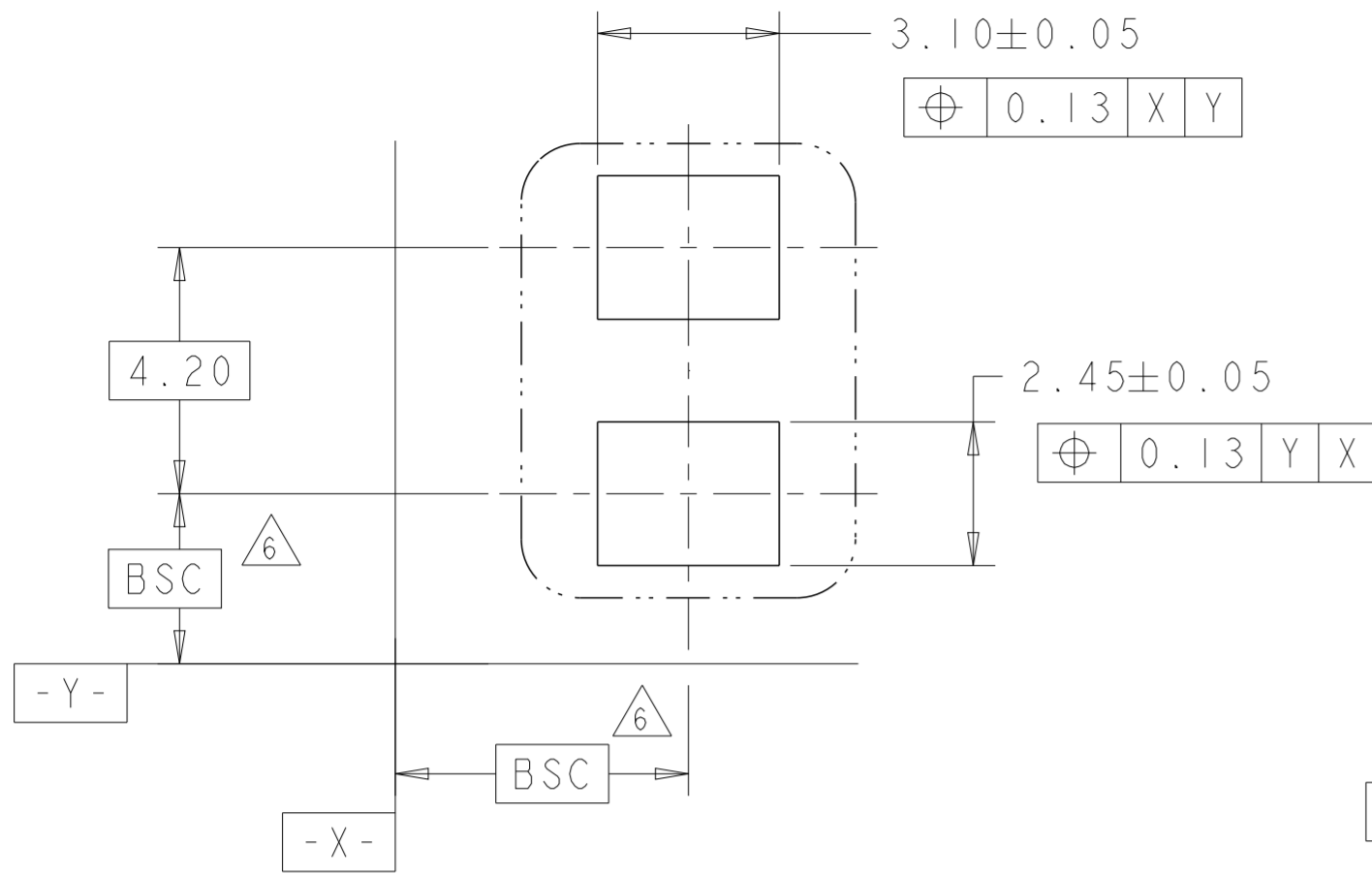

1 POSITION  
RECOMMENDED PAD LAYOUT  
SCALE 8:1

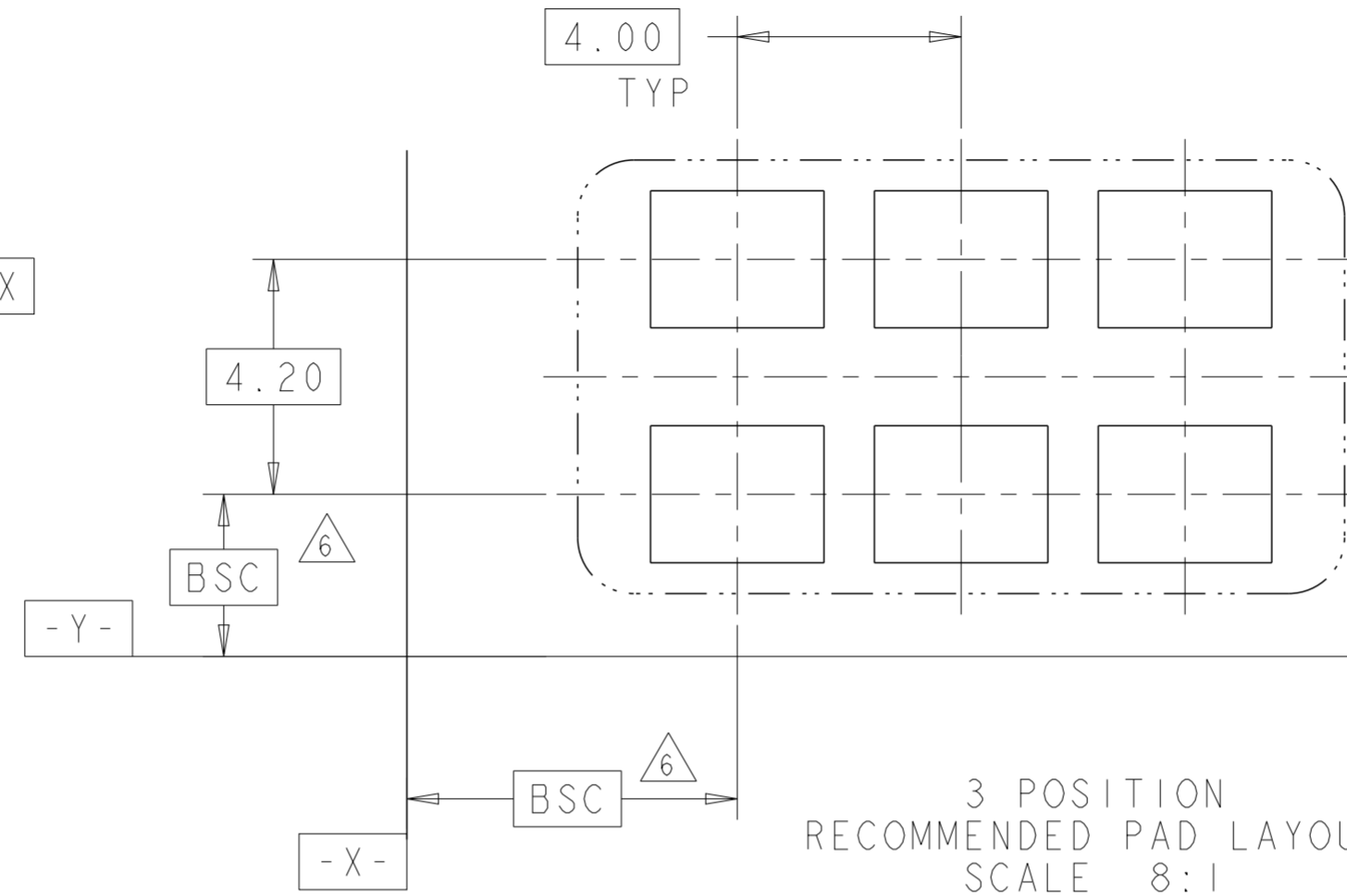

3 POSITION  
RECOMMENDED PAD LAYOUT  
SCALE 8:1

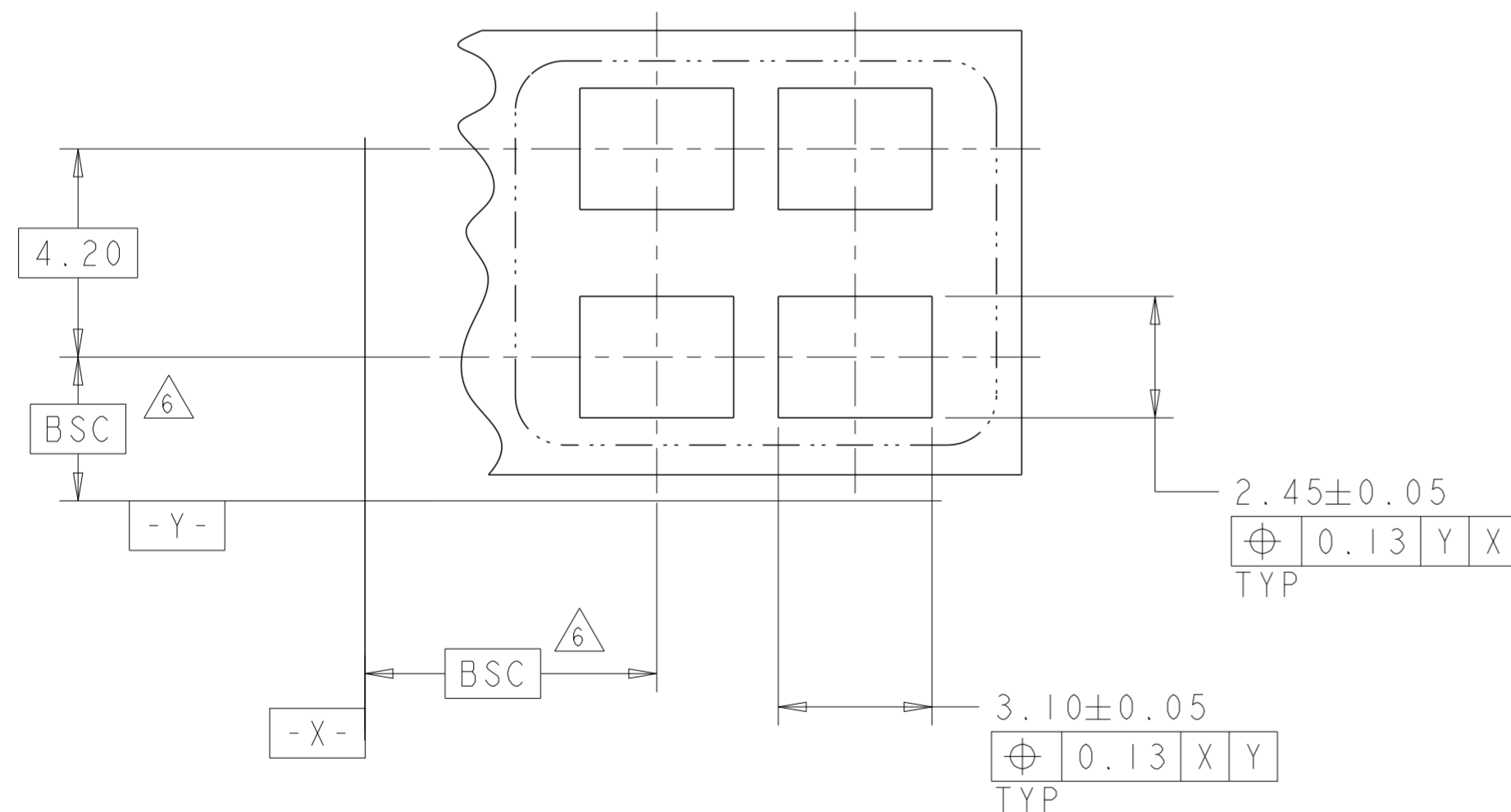

2 POSITION  
RECOMMENDED PAD LAYOUT  
SCALE 8:1

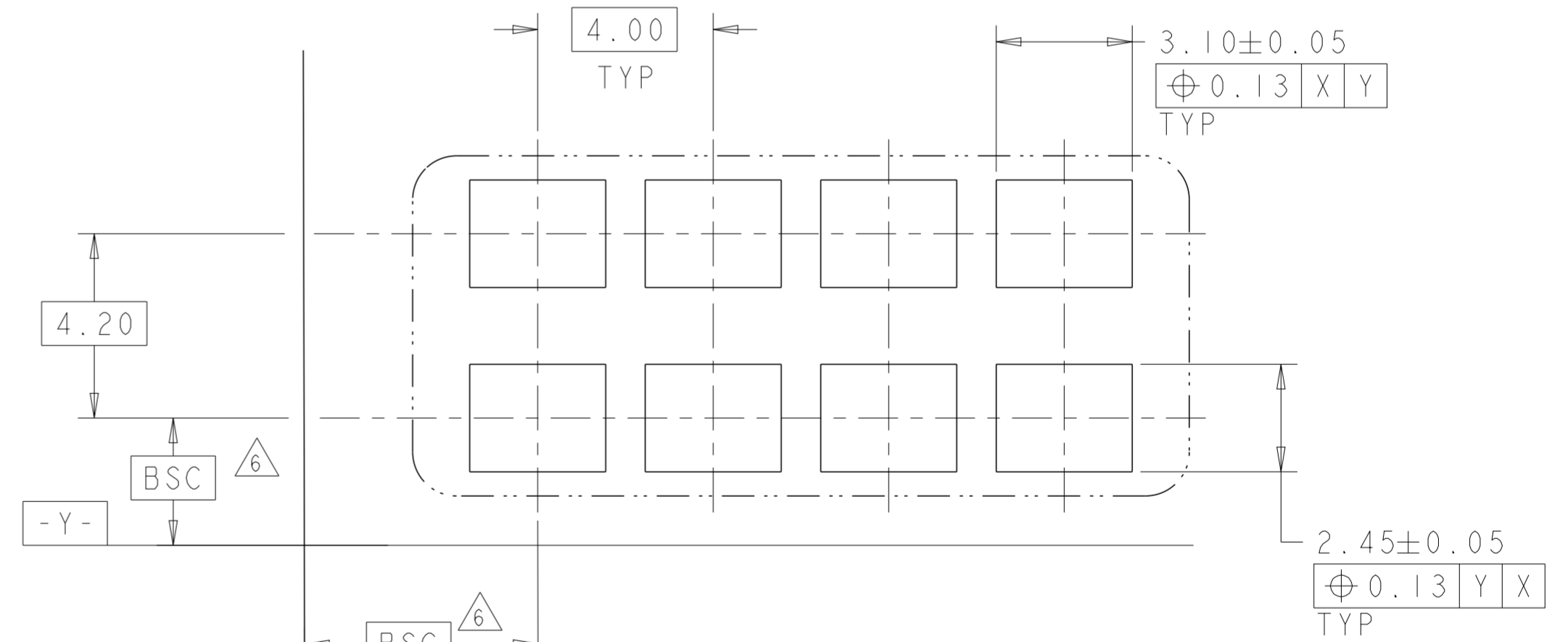

4 POSITION  
RECOMMENDED PAD LAYOUT  
SCALE 8:1

THIS DRAWING IS A CONTROLLED DOCUMENT.		DWN C DAILY 09DEC2008	 TE Connectivity	
		CHK J DYER 09DEC2008		
DIMENSIONS:	TOLERANCES UNLESS OTHERWISE SPECIFIED:	APVD	NAME	
mm	0 PLC ± 1 PLC ±0.5 2 PLC ±0.13 3 PLC ± 4 PLC ± ANGLES ± FINISH -	PRODUCT SPEC 108-2404	ASSEMBLY, IDC SSL CONNECTOR, SMT, CLOSED END	
MATERIAL	material_2	APPLICATION SPEC 114-13266	SIZE	RESTRICTED TO
	finish_spec_2	WEIGHT	A200779	
		Customer Drawing	DRAWING NO C-2106003	
			SCALE 2:1	SHEET 1 OF 4
				REV C

THIS DRAWING IS UNPUBLISHED. RELEASED FOR PUBLICATION 20  
 © COPYRIGHT 20 BY - ALL RIGHTS RESERVED.

LOC		DIST		REVISIONS				
P	LTR	DESCRIPTION			DATE	DWN	APVD	
-	-	SEE SHEET 1			-	-	-	

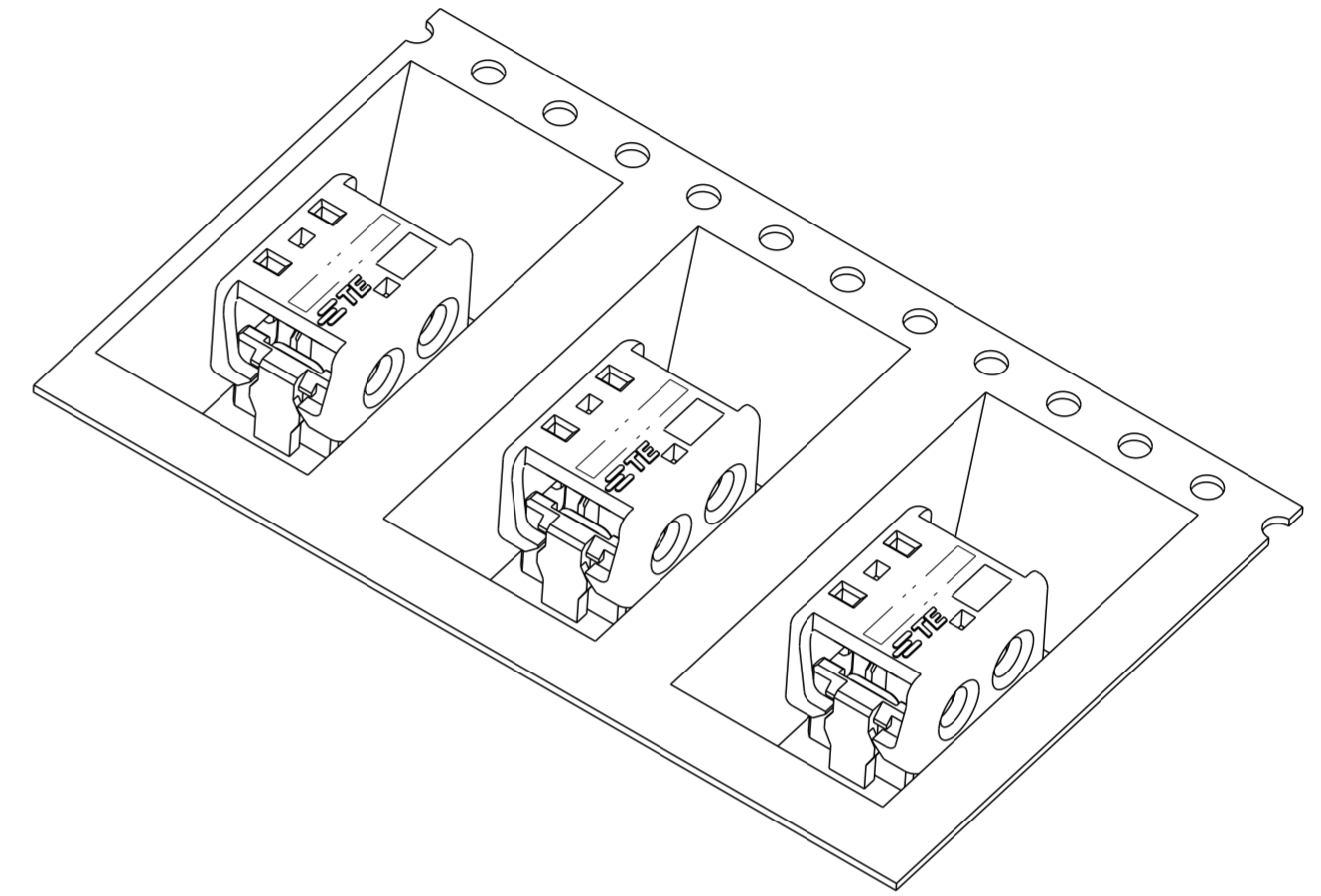

SECTION X-X

2106003-2 SHOWN IN POCKET TAPE

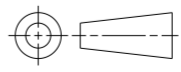
THIS DRAWING IS A CONTROLLED DOCUMENT.		DWN C DAILY 09DEC2008	 TE Connectivity	
		CHK J DYER 09DEC2008		
DIMENSIONS: mm		TOLERANCES UNLESS OTHERWISE SPECIFIED:		NAME ASSEMBLY, IDC SSL CONNECTOR, SMT, CLOSED END
		0 PLC ±	1 PLC ±0.5	PRODUCT SPEC 108-2404
MATERIAL material_2		2 PLC ±0.13	3 PLC ±	APPLICATION SPEC 114-13266
finish_spec_2		4 PLC ±	ANGLES ±	WEIGHT -
		FINISH -		SIZE A200779
				CAGE CODE C-2106003
				DRAWING NO Customer Drawing
				RESTRICTED TO -
				SCALE 2:1
				SHEET 1 OF 4
				REV C

Компания «Океан Электроники» предлагает заключение долгосрочных отношений при поставках импортных электронных компонентов на взаимовыгодных условиях!

Наши преимущества:

- Поставка оригинальных импортных электронных компонентов напрямую с производств Америки, Европы и Азии, а так же с крупнейших складов мира;
- Широкая линейка поставок активных и пассивных импортных электронных компонентов (более 30 млн. наименований);
- Поставка сложных, дефицитных, либо снятых с производства позиций;
- Оперативные сроки поставки под заказ (от 5 рабочих дней);
- Экспресс доставка в любую точку России;
- Помощь Конструкторского Отдела и консультации квалифицированных инженеров;
- Техническая поддержка проекта, помощь в подборе аналогов, поставка прототипов;
- Поставка электронных компонентов под контролем ВП;
- Система менеджмента качества сертифицирована по Международному стандарту ISO 9001;
- При необходимости вся продукция военного и аэрокосмического назначения проходит испытания и сертификацию в лаборатории (по согласованию с заказчиком);
- Поставка специализированных компонентов военного и аэрокосмического уровня качества (Xilinx, Altera, Analog Devices, Intersil, Interpoint, Microsemi, Actel, Aeroflex, Peregrine, VPT, Syfer, Eurofarad, Texas Instruments, MS Kennedy, Miteq, Cobham, E2V, MA-COM, Hittite, Mini-Circuits, General Dynamics и др.);

Компания «Океан Электроники» является официальным дистрибьютором и эксклюзивным представителем в России одного из крупнейших производителей разъемов военного и аэрокосмического назначения «JONHON», а так же официальным дистрибьютором и эксклюзивным представителем в России производителя высокотехнологичных и надежных решений для передачи СВЧ сигналов «FORSTAR».



## JONHON

«JONHON» (основан в 1970 г.)

Разъемы специального, военного и аэрокосмического назначения:

(Применяются в военной, авиационной, аэрокосмической, морской, железнодорожной, горно- и нефтедобывающей отраслях промышленности)

«FORSTAR» (основан в 1998 г.)

ВЧ соединители, коаксиальные кабели, кабельные сборки и микроволновые компоненты:

(Применяются в телекоммуникациях гражданского и специального назначения, в средствах связи, РЛС, а так же военной, авиационной и аэрокосмической отраслях промышленности).



Телефон: 8 (812) 309-75-97 (многоканальный)

Факс: 8 (812) 320-03-32

Электронная почта: [ocean@oceanchips.ru](mailto:ocean@oceanchips.ru)

Web: <http://oceanchips.ru/>

Адрес: 198099, г. Санкт-Петербург, ул. Калинина, д. 2, корп. 4, лит. А