

## Notice for TAIYO YUDEN Products

[ For High Quality and/or Reliability Equipment  
(Automotive Electronic Equipment / Industrial Equipment) ]

Please read this notice before using the TAIYO YUDEN products.

### REMINDERS

- Product information in this catalog is as of October 2018. All of the contents specified herein are subject to change without notice due to technical improvements, etc. Therefore, please check for the latest information carefully before practical application or use of our products.

Please note that TAIYO YUDEN shall not be in any way responsible for any damages and defects in products or equipment incorporating our products, which are caused under the conditions other than those specified in this catalog or individual product specification sheets.

- Please contact TAIYO YUDEN for further details of product specifications as the individual product specification sheets are available.
- Please conduct validation and verification of our products in actual condition of mounting and operating environment before using our products.
- The products listed in this catalog are intended for use in general electronic equipment (e.g., AV equipment, OA equipment, home electric appliances, office equipment, information and communication equipment), medical equipment classified as Class I or II by IMDRF, industrial equipment, and automotive interior applications, etc. Please be sure to contact TAIYO YUDEN for further information before using the products for any equipment which may directly cause loss of human life or bodily injury (e.g., transportation equipment including, without limitation, automotive powertrain control system, train control system, and ship control system, traffic signal equipment, medical equipment classified as Class III by IMDRF).

Please do not incorporate our products into any equipment requiring high levels of safety and/or reliability (e.g., aerospace equipment, aviation equipment\*, medical equipment classified as Class IV by IMDRF, nuclear control equipment, undersea equipment, military equipment).

\*Note: There is a possibility that our products can be used only for aviation equipment that does not directly affect the safe operation of aircraft (e.g., in-flight entertainment, cabin light, electric seat, cooking equipment) if such use meets requirements specified separately by TAIYO YUDEN. Please be sure to contact TAIYO YUDEN for further information before using our products for such aviation equipment.

When our products are used even for high safety and/or reliability-required devices or circuits of general electronic equipment, it is strongly recommended to perform a thorough safety evaluation prior to use of our products and to install a protection circuit as necessary.

Please note that unless you obtain prior written consent of TAIYO YUDEN, TAIYO YUDEN shall not be in any way responsible for any damages incurred by you or third parties arising from use of the products listed in this catalog for any equipment requiring inquiry to TAIYO YUDEN or prohibited for use by TAIYO YUDEN as described above.

- Information contained in this catalog is intended to convey examples of typical performances and/or applications of our products and is not intended to make any warranty with respect to the intellectual property rights or any other related rights of TAIYO YUDEN or any third parties nor grant any license under such rights.
- Please note that the scope of warranty for our products is limited to the delivered our products themselves and TAIYO YUDEN shall not be in any way responsible for any damages resulting from a fault or defect in our products. Notwithstanding the foregoing, if there is a written agreement (e.g., supply and purchase agreement, quality assurance agreement) signed by TAIYO YUDEN and your company, TAIYO YUDEN will warrant our products in accordance with such agreement.
- The contents of this catalog are applicable to our products which are purchased from our sales offices or authorized distributors (hereinafter "TAIYO YUDEN's official sales channel"). Please note that the contents of this catalog are not applicable to our products purchased from any seller other than TAIYO YUDEN's official sales channel.

#### ■ Caution for Export

Some of our products listed in this catalog may require specific procedures for export according to "U.S. Export Administration Regulations", "Foreign Exchange and Foreign Trade Control Law" of Japan, and other applicable regulations. Should you have any questions on this matter, please contact our sales staff.

# Automotive Application Guide

We classify automotive electronic equipment into the following four application categories and set usable application categories for each of our products. When using our products for automotive electronic equipment, please be sure to check such application categories and use our products accordingly. Should you have any questions on this matter, please contact us.

Category	Automotive Electronic Equipment (Typical Example)
POWERTRAIN	<ul style="list-style-type: none"> <li>• Engine ECU (Electronically Controlled Fuel Injector)</li> <li>• Cruise Control Unit</li> <li>• 4WS (4 Wheel Steering)</li> <li>• Automatic Transmission</li> <li>• Power Steering</li> <li>• HEV/PHV/EV Core Control (Battery, Inverter, DC-DC)</li> <li>• Automotive Locator (Car location information providing device), etc.</li> </ul>
SAFETY	<ul style="list-style-type: none"> <li>• ABS (Anti-Lock Brake System)</li> <li>• ESC (Electronic Stability Control)</li> <li>• Airbag</li> <li>• ADAS (Equipment that directly controls running, turning and stopping), etc.</li> </ul>
BODY & CHASSIS	<ul style="list-style-type: none"> <li>• Wiper</li> <li>• Automatic Door</li> <li>• Power Window</li> <li>• Keyless Entry System</li> <li>• Electric Door Mirror</li> <li>• Interior Lighting</li> <li>• LED Headlight</li> <li>• TPMS (Tire Pressure Monitoring System)</li> <li>• Anti-Theft Device (Immobilizer), etc.</li> </ul>
INFOTAINMENT	<ul style="list-style-type: none"> <li>• Car Infotainment System</li> <li>• ITS/Telematics System</li> <li>• Instrument Cluster</li> <li>• ADAS (Sensor, Equipment that is not interlocked with safety equipment or powertrain), etc.</li> </ul>



REFLOW  
AEC-Q200

# MULTILAYER CERAMIC CAPACITORS

■ PART NUMBER

J	M	K	3	1	6	△	B	J	1	0	6	M	L	H	T	△
①	②	③	④	⑤	⑥	⑦	⑧	⑨	⑩	⑪	⑫					

△=Blank space

① Rated voltage

Code	Rated voltage[VDC]
A	4
J	6.3
L	10
E	16
T	25
G	35
U	50
H	100
Q	250
S	630

③ End termination

Code	End termination
K	Plated
J	Soft Termination
S	Cu Internal Electrodes (For High Frequency)
F	High Reliability Application

② Series name

Code	Series name
M	Multilayer ceramic capacitor
V	Multilayer ceramic capacitor for high frequency
W	LW reverse type multilayer capacitor

④ Dimension (L × W)

Type	Dimensions (L × W) [mm]	EIA (inch)
063	0.6 × 0.3	0201
105	1.0 × 0.5	0402
	0.52 × 1.0 ※	0204
107	1.6 × 0.8	0603
	0.8 × 1.6 ※	0306
212	2.0 × 1.25	0805
	1.25 × 2.0 ※	0508
316	3.2 × 1.6	1206
325	3.2 × 2.5	1210
432	4.5 × 3.2	1812

Note : ※LW reverse type (□WK) only

⑤ Dimension tolerance

Code	Type	L[mm]	W[mm]	T[mm]
△	ALL	Standard	Standard	Standard
A	063	0.6±0.05	0.3±0.05	0.3±0.05
	105	1.0±0.10	0.5±0.10	0.5±0.10
	107	1.6+0.15/-0.05	0.8+0.15/-0.05	0.8+0.15/-0.05
	212	2.0+0.15/-0.05	1.25+0.15/-0.05	0.85±0.10
	316	3.2±0.20	1.6±0.20	1.25+0.15/-0.05
	325	3.2±0.30	2.5±0.30	1.6±0.20
B	105	1.0+0.15/-0.05	0.5+0.15/-0.05	2.5±0.30
	107	1.6+0.20/-0	0.8+0.20/-0	0.5+0.15/-0.05
	212	2.0+0.20/-0	1.25+0.20/-0	0.8+0.20/-0
C	316	3.2±0.30	1.6±0.30	0.85±0.10
	105	1.0+0.20/-0	0.5+0.20/-0	1.25+0.20/-0
	107	1.6+0.25/-0	0.8+0.25/-0	1.6±0.30
K	212	2.0±0.15	1.25±0.15	0.5+0.20/-0
	316	3.2±0.20	1.6±0.20	0.8+0.25/-0
K	325	3.2±0.50	2.5±0.30	1.25+0.25/-0
	325	3.2±0.50	2.5±0.30	1.25+0.25/-0

Note: cf. STANDARD EXTERNAL DIMENSIONS

△= Blank space

⑥ Temperature characteristics code

■ High dielectric type

Code	Applicable standard	Temperature range [°C]	Ref. Temp. [°C]	Capacitance change	Capacitance tolerance	Tolerance code
BJ	EIA	X5R	-55~+85	25	±15%	±10%
						±20%
C6	EIA	X6S	-55~+105	25	±22%	±10%
						±20%
B7	EIA	X7R	-55~+125	25	±15%	±10%
						±20%
C7	EIA	X7S	-55~+125	25	±22%	±10%
						±20%
D7	EIA	X7T	-55~+125	25	+22%/-33%	±10%
						±20%

▶ This catalog contains the typical specification only due to the limitation of space. When you consider the purchase of our products, please check our product specification sheets. For details of each product (characteristics graph, reliability information, precautions for use, and so on), see our website (<http://www.ty-top.com/>).

## ■ Temperature compensating type

Code	Applicable standard		Temperature range [°C]	Ref. Temp. [°C]	Capacitance change	Capacitance tolerance	Tolerance code
CG	JIS	CG	-55 ~ +125	20	0 ± 30ppm/°C	± 0.1pF	B
						± 0.25pF	C
						± 0.5pF	D
	EIA	COG		25		± 1pF	F
						± 2%	G
						± 5%	J

## ⑦ Nominal capacitance

Code (example)	Nominal capacitance
OR5	0.5pF
010	1pF
100	10pF
101	100pF
102	1,000pF
103	0.01 μF
104	0.1 μF
105	1.0 μF
106	10 μF
107	100 μF

Note : R=Decimal point

## ⑧ Capacitance tolerance

Code	Capacitance tolerance
A	± 0.05pF
B	± 0.1pF
C	± 0.25pF
D	± 0.5pF
G	± 2%
J	± 5%
K	± 10%
M	± 20%

## ⑨ Thickness

Code	Thickness [mm]
P	0.3
T	
V	0.5
C	0.7(107type or more)
A	0.8
D	0.85(212type or more)
F	1.15
G	1.25
L	1.6
N	1.9
M	2.5

## ⑩ Special code

Code	Special code
H	MLCC for Industrial and Automotive

## ⑪ Packaging

Code	Packaging
F	φ 178mm Taping (2mm pitch)
R	φ 178mm Embossed Taping (4mm pitch)
T	φ 178mm Taping (4mm pitch)
P	φ 178mm Taping (4mm pitch, 1000 pcs/reel) 325 type (Thickness code M)

## ⑫ Internal code

Code	Internal code
△	Standard

STANDARD EXTERNAL DIMENSIONS

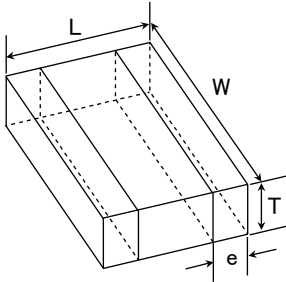

※ LW reverse type

Type( EIA )	Dimension [mm] (inch)				
	L	W	T	*1	e
□MK063(0201)	0.6±0.03 (0.024±0.001)	0.3±0.03 (0.012±0.001)	0.3±0.03 (0.012±0.001)	T	0.15±0.05 (0.006±0.002)
□MK105(0402) □MF105(0402)	1.0±0.05 (0.039±0.002)	0.5±0.05 (0.020±0.002)	0.5±0.05 (0.020±0.002)	V	0.25±0.10 (0.010±0.004)
□WK105(0204)※	0.52±0.05 (0.020±0.002)	1.0±0.05 (0.039±0.002)	0.3±0.05 (0.012±0.002)	P	0.18±0.08 (0.007±0.003)
□MK107(0603) □MF107(0603)	1.6±0.10 (0.063±0.004)	0.8±0.10 (0.031±0.004)	0.8±0.10 (0.031±0.004)	A	0.35±0.25 (0.014±0.010)
□MJ107(0603)	1.6±0.10 (0.063±0.004)	0.8±0.10 (0.031±0.004)	0.8±0.10 (0.031±0.004)	A	0.35+0.3/-0.25 (0.014+0.012/-0.010)
□VS107(0603)	1.6±0.10 (0.063±0.004)	0.8±0.10 (0.031±0.004)	0.7±0.10 (0.028±0.004)	C	0.35±0.25 (0.014±0.010)
□WK107(0306)※	0.8±0.10 (0.031±0.004)	1.6±0.10 (0.063±0.004)	0.5±0.05 (0.020±0.002)	V	0.25±0.15 (0.010±0.006)
□MK212(0805) □MF212(0805)	2.0±0.10 (0.079±0.004)	1.25±0.10 (0.049±0.004)	0.85±0.10 (0.033±0.004)	D	0.5±0.25 (0.020±0.010)
1.25±0.10 (0.049±0.004)			G		
□MJ212(0805)	2.0±0.10 (0.079±0.004)	1.25±0.10 (0.049±0.004)	0.85±0.10 (0.033±0.004)	D	0.5+0.35/-0.25 (0.020+0.014/-0.010)
1.25±0.10 (0.049±0.004)			G		
□VS212(0805)	2.0±0.10 (0.079±0.004)	1.25±0.10 (0.049±0.004)	0.85±0.10 (0.033±0.004)	D	0.5±0.25 (0.020±0.010)
□WK212(0508)※	1.25±0.15 (0.049±0.006)	2.0±0.15 (0.079±0.006)	0.85±0.10 (0.033±0.004)	D	0.3±0.2 (0.012±0.008)
□MK316(1206) □MF316(1206)	3.2±0.15 (0.126±0.006)	1.6±0.15 (0.063±0.006)	1.15±0.10 (0.045±0.004)	F	0.5+0.35/-0.25 (0.020+0.014/-0.010)
1.6±0.20 (0.063±0.008)			L		
□MJ316(1206)	3.2±0.15 (0.126±0.006)	1.6±0.15 (0.063±0.006)	1.15±0.10 (0.045±0.004)	F	0.6+0.4/-0.3 (0.024+0.016/-0.012)
1.6±0.20 (0.063±0.008)			L		
□MK325(1210) □MF325(1210)	3.2±0.30 (0.126±0.012)	2.5±0.20 (0.098±0.008)	1.15±0.10 (0.045±0.004)	F	0.6±0.3 (0.024±0.012)
1.9±0.20 (0.075±0.008)			N		
2.5±0.20 (0.098±0.008)			M		
□MJ325(1210)	3.2±0.30 (0.126±0.012)	2.5±0.20 (0.098±0.008)	1.9±0.20 (0.075±0.008)	N	0.6+0.4/-0.3 (0.024+0.016/-0.012)
2.5±0.20 (0.098±0.008)			M		
□MK432(1812)	4.5±0.40 (0.177±0.016)	3.2±0.30 (0.126±0.012)	2.5±0.20 (0.098±0.008)	M	0.9±0.6 (0.035±0.024)

Note : ※: LW reverse type, \*1.Thickness code

► This catalog contains the typical specification only due to the limitation of space. When you consider the purchase of our products, please check our product specification sheets. For details of each product (characteristics graph, reliability information, precautions for use, and so on), see our website (<http://www.ty-top.com/>).

## ■ STANDARD QUANTITY

Type	EIA (inch)	Dimension		Standard quantity [pcs]	
		[mm]	Code	Paper tape	Embossed tape
063	0201	0.3	T	15000	—
105	0402	0.5	V	10000	—
	0204 ※	0.30	P		
107	0603	0.7	C	4000	—
		0.8	A		
		0.8	A	3000 (Soft Termination)	—
		0.8	A	—	3000 (Soft Termination)
	0306 ※	0.50	V	—	4000
212	0805	0.85	D	4000	—
		1.25	G	—	3000
		1.25	G	—	2000 (Soft Termination)
	0508 ※	0.85	D	4000	—
316	1206	1.15	F	—	3000
		1.6	L	—	2000
325	1210	1.15	F	—	2000
		1.9	N		
		2.5	M	—	500 (T), 1000 (P)
432	1812	2.5	M	—	500

Note : ※: LW Reverse type (□WK)

■ PART NUMBER

**Soft Termination Multilayer Ceramic Capacitors**

● 107TYPE (Dimension:1.6×0.8mm JIS:1608 EIA:0603)

【Temperature Characteristic B7 : X7R(-55~+125°C)】 0.8mm thickness(A)

Part number 1	Part number 2	Rated voltage [V]	Temperature characteristics	Capacitance [F]	Capacitance tolerance [%]	tan δ [%]	HTLT		Thickness*3 [mm]	Note
							Rated voltage x %			
TMJ107BB7473[AHT]		25	X7R	0.047 μ	±10, ±20	3.5	200	0.8+0.20/-0	*1, *2	
TMJ107BB7104[AHT]			X7R	0.1 μ	±10, ±20	3.5	200	0.8+0.20/-0	*1, *2	
TMJ107BB7224[AHT]			X7R	0.22 μ	±10, ±20	10	150	0.8+0.20/-0	*1, *2	
TMJ107BB7474[AHT]			X7R	0.47 μ	±10, ±20	10	150	0.8+0.20/-0	*1, *2	
TMJ107CB7105[AHR]			X7R	1 μ	±10, ±20	10	150	0.8+0.25/-0	*1, *2	
GMJ107BB7473[AHT]			35	X7R	0.047 μ	±10, ±20	3.5	200	0.8+0.20/-0	*1, *2
GMJ107BB7104[AHT]		X7R		0.1 μ	±10, ±20	3.5	200	0.8+0.20/-0	*1, *2	
GMJ107BB7224[AHT]		X7R		0.22 μ	±10, ±20	10	150	0.8+0.20/-0	*1, *2	
GMJ107BB7474[AHT]		X7R		0.47 μ	±10, ±20	10	150	0.8+0.20/-0	*1, *2	
GMJ107CB7105[AHR]		X7R		1 μ	±10, ±20	10	150	0.8+0.25/-0	*1, *2	
UMJ107AB7102[AHT]		50		X7R	1000 p	±10, ±20	3.5	200	0.8+0.15/-0.05	*1, *2
UMJ107AB7222[AHT]			X7R	2200 p	±10, ±20	3.5	200	0.8+0.15/-0.05	*1, *2	
UMJ107BB7472[AHT]			X7R	4700 p	±10, ±20	3.5	200	0.8+0.20/-0	*1, *2	
UMJ107BB7103[AHT]			X7R	0.01 μ	±10, ±20	3.5	200	0.8+0.20/-0	*1, *2	
UMJ107BB7223[AHT]			X7R	0.022 μ	±10, ±20	3.5	200	0.8+0.20/-0	*1, *2	
UMJ107BB7473[AHT]			X7R	0.047 μ	±10, ±20	3.5	200	0.8+0.20/-0	*1, *2	
UMJ107BB7104[AHT]		100	X7R	0.1 μ	±10, ±20	3.5	200	0.8+0.20/-0	*1, *2	
HMJ107AB7102[AHT]			X7R	1000 p	±10, ±20	3.5	200	0.8+0.15/-0.05	*1, *2	
HMJ107AB7222[AHT]			X7R	2200 p	±10, ±20	3.5	200	0.8+0.15/-0.05	*1, *2	
HMJ107BB7472[AHT]			X7R	4700 p	±10, ±20	3.5	200	0.8+0.20/-0	*1, *2	
HMJ107BB7103[AHT]			X7R	0.01 μ	±10, ±20	3.5	200	0.8+0.20/-0	*1, *2	
HMJ107BB7223[AHT]			X7R	0.022 μ	±10, ±20	3.5	200	0.8+0.20/-0	*1, *2	
HMJ107BB7473[AHT]		100	X7R	0.047 μ	±10, ±20	3.5	200	0.8+0.20/-0	*1, *2	
HMJ107BB7104[AHT]			X7R	0.1 μ	±10, ±20	3.5	200	0.8+0.20/-0	*1, *2	

● 212TYPE (Dimension:2.0×1.25mm JIS:2012 EIA:0805)

【Temperature Characteristic B7 : X7R(-55~+125°C), C7 : X7S(-55~+125°C)】 0.85mm thickness(D)、1.25mm thickness(G)

Part number 1	Part number 2	Rated voltage [V]	Temperature characteristics	Capacitance [F]	Capacitance tolerance [%]	tan δ [%]	HTLT		Thickness*3 [mm]	Note
							Rated voltage x %			
JMJ212CB7106[GHT]		6.3	X7R	10 μ	±10, ±20	10	150	1.25+0.25/-0	*1, *2	
EMJ212CB7225[GHT]		16	X7R	2.2 μ	±10, ±20	10	150	1.25+0.25/-0	*1, *2	
EMJ212CB7475[GHT]			X7R	4.7 μ	±10, ±20	10	150	1.25+0.25/-0	*1, *2	
TMJ212CB7225[GHT]		25	X7R	2.2 μ	±10, ±20	10	150	1.25+0.25/-0	*1, *2	
GMJ212CB7105[GHT]		35	X7R	1 μ	±10, ±20	10	150	1.25+0.25/-0	*1, *2	
UMJ212BB7103[GHT]			X7R	0.01 μ	±10, ±20	3.5	200	1.25+0.20/-0	*1, *2	
UMJ212BB7223[GHT]		50	X7R	0.022 μ	±10, ±20	3.5	200	1.25+0.20/-0	*1, *2	
UMJ212BB7473[GHT]			X7R	0.047 μ	±10, ±20	3.5	200	1.25+0.20/-0	*1, *2	
UMJ212BB7104[GHT]			X7R	0.1 μ	±10, ±20	3.5	200	1.25+0.20/-0	*1, *2	
UMJ212BB7224[GHT]			X7R	0.22 μ	±10, ±20	3.5	200	1.25+0.20/-0	*1, *2	
UMJ212CC7474[GHT]			X7S	0.47 μ	±10, ±20	3.5	150	1.25+0.25/-0	*1, *2	
UMJ212CB7105[GHT]			X7R	1 μ	±10, ±20	10	150	1.25+0.25/-0	*1, *2	
HMJ212KB7102[DHT]		100	X7R	1000 p	±10, ±20	3.5	200	0.85±0.15	*1, *2	
HMJ212KB7222[DHT]			X7R	2200 p	±10, ±20	3.5	200	0.85±0.15	*1, *2	
HMJ212BB7472[GHT]			X7R	4700 p	±10, ±20	3.5	200	1.25+0.20/-0	*1, *2	
HMJ212BB7103[GHT]			X7R	0.01 μ	±10, ±20	3.5	200	1.25+0.20/-0	*1, *2	
HMJ212BB7223[GHT]			X7R	0.022 μ	±10, ±20	3.5	200	1.25+0.20/-0	*1, *2	
HMJ212BB7473[GHT]			X7R	0.047 μ	±10, ±20	3.5	200	1.25+0.20/-0	*1, *2	
HMJ212BB7104[GHT]		250	X7R	0.1 μ	±10, ±20	3.5	200	1.25+0.20/-0	*1, *2	
HMJ212BB7224[GHT]			X7R	0.22 μ	±10, ±20	3.5	200	1.25+0.20/-0	*1, *2	
HMJ212CC7474[GHT]			X7S	0.47 μ	±10, ±20	3.5	150	1.25+0.25/-0	*1, *2	
QMJ212KB7102[DHT]			X7R	1000 p	±10, ±20	2.5	150	0.85±0.15	*1, *2	
QMJ212KB7222[DHT]			X7R	2200 p	±10, ±20	2.5	150	0.85±0.15	*1, *2	
QMJ212BB7472[GHT]			X7R	4700 p	±10, ±20	2.5	150	1.25+0.20/-0	*1, *2	
QMJ212BB7103[GHT]		250	X7R	0.01 μ	±10, ±20	2.5	150	1.25+0.20/-0	*1, *2	
QMJ212BB7223[GHT]			X7R	0.022 μ	±10, ±20	2.5	150	1.25+0.20/-0	*1, *2	

▶ This catalog contains the typical specification only due to the limitation of space. When you consider the purchase of our products, please check our product specification sheets. For details of each product (characteristics graph, reliability information, precautions for use, and so on), see our website (<http://www.ty-top.com/>).

■ PART NUMBER

● 316TYPE (Dimension:3.2×1.6mm JIS:3216 EIA:1206)

【Temperature Characteristic B7 : X7R(−55~+125°C), C7 : X7S(−55~+125°C)】 1.15mm thickness (F)、1.6mm thickness (L)

Part number 1	Part number 2	Rated voltage [V]	Temperature characteristics	Capacitance [F]	Capacitance tolerance [%]	tan δ [%]	HTLT		Thickness*3 [mm]	Note
							Rated voltage x %			
LMJ316BB7226□LHT		10	X7R	22 μ	±10, ±20	10	150		1.6±0.30	*1, *2
EMJ316BB7475□LHT		16	X7R	4.7 μ	±10, ±20	10	150		1.6±0.30	*1, *2
EMJ316BB7106□LHT			X7R	10 μ	±10, ±20	10	150		1.6±0.30	*1, *2
TMJ316BB7474□LHT			X7R	0.47 μ	±10, ±20	3.5	200		1.6±0.30	*1, *2
TMJ316BB7475□LHT		25	X7R	4.7 μ	±10, ±20	10	150		1.6±0.30	*1, *2
TMJ316BB7106□LHT			X7R	10 μ	±10, ±20	10	150		1.6±0.30	*1, *2
GMJ316BB7474□LHT			X7R	0.47 μ	±10, ±20	3.5	200		1.6±0.30	*1, *2
GMJ316AB7225□LHT		35	X7R	2.2 μ	±10, ±20	10	150		1.6±0.20	*1, *2
GMJ316BB7475□LHT			X7R	4.7 μ	±10, ±20	10	150		1.6±0.30	*1, *2
GMJ316BB7106□LHT			X7R	10 μ	±10, ±20	10	150		1.6±0.30	*1, *2
UMJ316BB7473□LHT			X7R	0.047 μ	±10, ±20	3.5	200		1.6±0.30	*1, *2
UMJ316BB7104□LHT			X7R	0.1 μ	±10, ±20	3.5	200		1.6±0.30	*1, *2
UMJ316BB7224□LHT			X7R	0.22 μ	±10, ±20	3.5	200		1.6±0.30	*1, *2
UMJ316BB7474□LHT		50	X7R	0.47 μ	±10, ±20	3.5	200		1.6±0.30	*1, *2
UMJ316BB7105□LHT			X7R	1 μ	±10, ±20	3.5	200		1.6±0.30	*1, *2
UMJ316AB7225□LHT			X7R	2.2 μ	±10, ±20	10	150		1.6±0.20	*1, *2
UMJ316BC7475□LHTE			X7S	4.7 μ	±10, ±20	2.5	150		1.6±0.30	*1, *2
HMJ316 B7102□FHT			X7R	1000 p	±10, ±20	3.5	200		1.15±0.10	*1, *2
HMJ316 B7222□FHT			X7R	2200 p	±10, ±20	3.5	200		1.15±0.10	*1, *2
HMJ316 B7472□FHT			X7R	4700 p	±10, ±20	3.5	200		1.15±0.10	*1, *2
HMJ316KB7103□FHT			X7R	0.01 μ	±10, ±20	3.5	200		1.15±0.20	*1, *2
HMJ316BB7223□LHT			X7R	0.022 μ	±10, ±20	3.5	200		1.6±0.30	*1, *2
HMJ316BB7473□LHT		100	X7R	0.047 μ	±10, ±20	3.5	200		1.6±0.30	*1, *2
HMJ316BB7104□LHT			X7R	0.1 μ	±10, ±20	3.5	200		1.6±0.30	*1, *2
HMJ316BB7224□LHT			X7R	0.22 μ	±10, ±20	3.5	200		1.6±0.30	*1, *2
HMJ316BB7474□LHT			X7R	0.47 μ	±10, ±20	3.5	200		1.6±0.30	*1, *2
HMJ316BB7105□LHT			X7R	1 μ	±10, ±20	3.5	200		1.6±0.30	*1, *2
HMJ316BC7225□LHTE			X7S	2.2 μ	±10, ±20	3.5	150		1.6±0.30	*1, *2
QMJ316 B7102□FHT			X7R	1000 p	±10, ±20	2.5	150		1.15±0.10	*1, *2
QMJ316 B7222□FHT			X7R	2200 p	±10, ±20	2.5	150		1.15±0.10	*1, *2
QMJ316 B7472□FHT			X7R	4700 p	±10, ±20	2.5	150		1.15±0.10	*1, *2
QMJ316KB7103□FHT		250	X7R	0.01 μ	±10, ±20	2.5	150		1.15±0.20	*1, *2
QMJ316BB7223□LHT			X7R	0.022 μ	±10, ±20	2.5	150		1.6±0.30	*1, *2
QMJ316BB7473□LHT			X7R	0.047 μ	±10, ±20	2.5	150		1.6±0.30	*1, *2
QMJ316BB7104□LHT			X7R	0.1 μ	±10, ±20	2.5	150		1.6±0.30	*1, *2
SMJ316 B7102□FHT			X7R	1000 p	±10, ±20	2.5	120		1.15±0.10	*1, *2
SMJ316 B7222□FHT			X7R	2200 p	±10, ±20	2.5	120		1.15±0.10	*1, *2
SMJ316 B7472□FHT		630	X7R	4700 p	±10, ±20	2.5	120		1.15±0.10	*1, *2
SMJ316KB7103□FHT			X7R	0.01 μ	±10, ±20	2.5	120		1.15±0.20	*1, *2
SMJ316BB7223□LHT			X7R	0.022 μ	±10, ±20	2.5	120		1.6±0.30	*1, *2

● 325TYPE (Dimension:3.2×2.5mm JIS:3225 EIA:1210)

【Temperature Characteristic B7 : X7R(−55~+125°C), C7 : X7S(−55~+125°C)】 1.9mm thickness (N)、2.5mm thickness (M)

Part number 1	Part number 2	Rated voltage [V]	Temperature characteristics	Capacitance [F]	Capacitance tolerance [%]	tan δ [%]	HTLT		Thickness*3 [mm]	Note
							Rated voltage x %			
JMJ325KB7476□MHP		6.3	X7R	47 μ	±10, ±20	10	150		2.5±0.30	*1, *2
EMJ325KB7226□MHP		16	X7R	22 μ	±10, ±20	10	150		2.5±0.30	*1, *2
TMJ325AB7475□MHP			X7R	4.7 μ	±10, ±20	5	150		2.5±0.30	*1, *2
TMJ325KB7106□MHP		25	X7R	10 μ	±10, ±20	10	150		2.5±0.30	*1, *2
GMJ325AB7475□MHP			X7R	4.7 μ	±10, ±20	5	150		2.5±0.30	*1, *2
GMJ325KB7106□MHP		35	X7R	10 μ	±10, ±20	10	150		2.5±0.30	*1, *2
UMJ325AB7225□MHP			X7R	2.2 μ	±10, ±20	3.5	200		2.5±0.30	*1, *2
UMJ325AB7475□MHP		50	X7R	4.7 μ	±10, ±20	5	150		2.5±0.30	*1, *2
UMJ325KB7106□MHP			X7R	10 μ	±10, ±20	10	150		2.5±0.30	*1, *2
HMJ325 B7223□NHT			X7R	0.022 μ	±10, ±20	3.5	200		1.9±0.20	*1, *2
HMJ325 B7473□NHT			X7R	0.047 μ	±10, ±20	3.5	200		1.9±0.20	*1, *2
HMJ325 B7104□NHT			X7R	0.1 μ	±10, ±20	3.5	200		1.9±0.20	*1, *2
HMJ325 B7224□NHT		100	X7R	0.22 μ	±10, ±20	3.5	200		1.9±0.20	*1, *2
HMJ325 B7474□NHT			X7R	0.47 μ	±10, ±20	3.5	200		1.9±0.20	*1, *2
HMJ325 B7105□NHT			X7R	1 μ	±10, ±20	3.5	200		1.9±0.20	*1, *2
HMJ325AB7225□MHP			X7R	2.2 μ	±10, ±20	3.5	200		2.5±0.30	*1, *2
HMJ325KC7475□MHPE			X7S	4.7 μ	±10, ±20	3.5	150		2.5±0.30	*1, *2
QMJ325 B7223□NHT			X7R	0.022 μ	±10, ±20	2.5	150		1.9±0.20	*1, *2
QMJ325 B7473□NHT			X7R	0.047 μ	±10, ±20	2.5	150		1.9±0.20	*1, *2
QMJ325 B7104□NHT		250	X7R	0.1 μ	±10, ±20	2.5	150		1.9±0.20	*1, *2
QMJ325 B7224□NHT			X7R	0.22 μ	±10, ±20	2.5	150		1.9±0.20	*1, *2
SMJ325 B7223□NHT			X7R	0.022 μ	±10, ±20	2.5	120		1.9±0.20	*1, *2
SMJ325 B7473□NHT		630	X7R	0.047 μ	±10, ±20	2.5	120		1.9±0.20	*1, *2

▶ This catalog contains the typical specification only due to the limitation of space. When you consider the purchase of our products, please check our product specification sheets. For details of each product (characteristics graph, reliability information, precautions for use, and so on), see our website (<http://www.ty-top.com/>).



# Multilayer Ceramic Capacitors

## PACKAGING

### ① Minimum Quantity

#### ● Taped package

Type(EIA)	Thickness		Standard quantity [pcs]	
	mm	code	Paper tape	Embossed tape
<input type="checkbox"/> MK021(008004)	0.125	K	—	50000
<input type="checkbox"/> VS021(008004)				
<input type="checkbox"/> MK042(01005)	0.2	C, D	—	40000
<input type="checkbox"/> VS042(01005)				
<input type="checkbox"/> MK063(0201)	0.3	P, T	15000	—
<input type="checkbox"/> WK105(0204) ※	0.3	P	10000	—
<input type="checkbox"/> MK105(0402) <input type="checkbox"/> MF105(0402)	0.13	H	—	20000
	0.18	E	—	15000
	0.2	C	20000	—
	0.3	P	15000	—
	0.5	V	10000	—
<input type="checkbox"/> VK105(0402)	0.5	W	10000	—
<input type="checkbox"/> MK107(0603)	0.45	K	4000	—
<input type="checkbox"/> WK107(0306) ※				
<input type="checkbox"/> MF107(0603)	0.5	V	—	4000
<input type="checkbox"/> VS107(0603)	0.8	A	4000	—
<input type="checkbox"/> MJ107(0603)	0.7	C	4000	—
<input type="checkbox"/> MK212(0805)	0.85	D	4000	—
<input type="checkbox"/> WK212(0508) ※				
<input type="checkbox"/> MF212(0805)				
<input type="checkbox"/> VS212(0805)	1.25	G	—	3000
<input type="checkbox"/> MJ212(0805)	0.85	D	4000	—
<input type="checkbox"/> MK316(1206) <input type="checkbox"/> MF316(1206)	0.85	D	4000	—
	1.15	F	—	3000
<input type="checkbox"/> MJ316(1206)	1.6	L	—	2000
	1.15	F	—	3000
	1.6	L	—	2000
<input type="checkbox"/> MK325(1210) <input type="checkbox"/> MF325(1210)	0.85	D	—	2000
	1.15	F		
	1.9	N		
	2.0max.	Y		
<input type="checkbox"/> MJ325(1210)	2.5	M	—	1000
	1.9	N	—	2000
	2.5	M	—	500(T), 1000(P)
<input type="checkbox"/> MK432(1812)	2.5	M	—	500

Note : ※ LW Reverse type.

### ② Taping material

※No bottom tape for pressed carrier tape

#### ● Card board carrier tape



#### ● Embossed tape

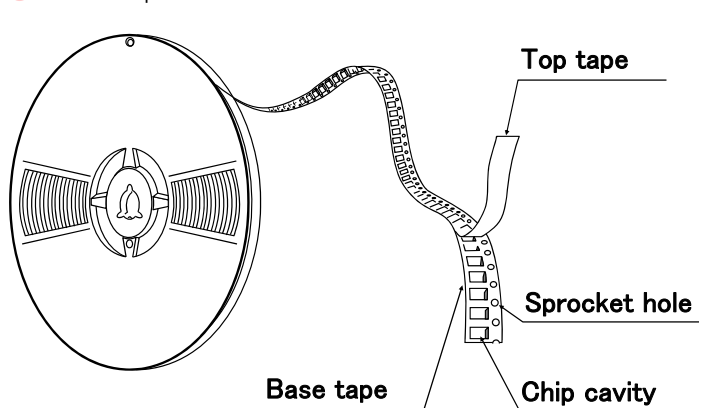

▶ This catalog contains the typical specification only due to the limitation of space. When you consider the purchase of our products, please check our specification. For details of each product (characteristics graph, reliability information, precautions for use, and so on), see our Web site (<http://www.ty-top.com/>).

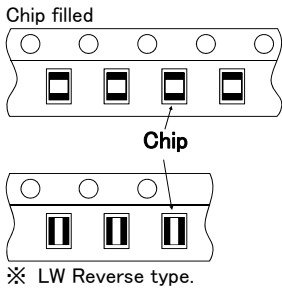

### ③ Representative taping dimensions

● Paper Tape (8mm wide)

● Pressed carrier tape ( 2mm pitch)

Unit: mm (inch)

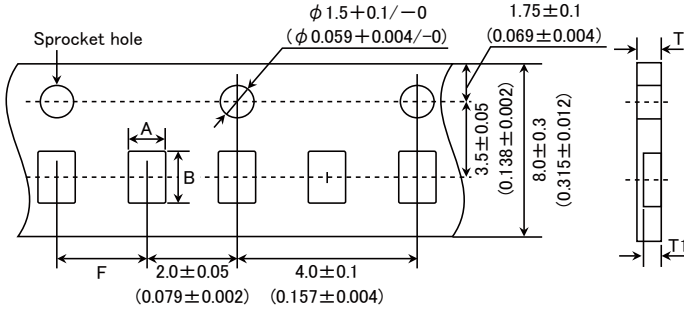

Type(EIA)	Chip Cavity		Insertion Pitch F	Tape Thickness	
	A	B		T	T1
□MK063(0201)	0.37	0.67	2.0±0.05	0.45max.	0.42max.
□WK105(0204) ※	0.65	1.15		0.4max.	0.3max.
□MK105(0402) (*1 C)				0.45max.	0.42max.
□MK105(0402) (*1 P)					

Note \*1 Thickness, C: 0.2mm ,P: 0.3mm. ※ LW Reverse type.

Unit: mm

● Punched carrier tape (2mm pitch)

Unit: mm (inch)

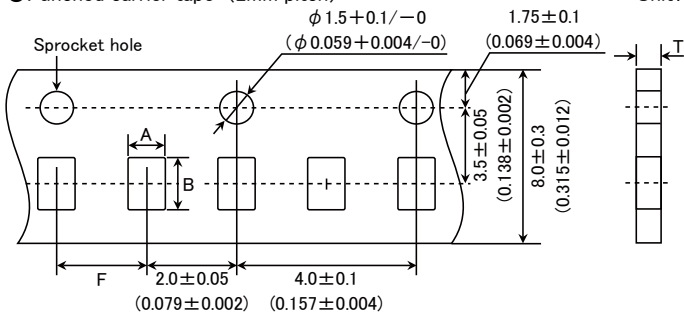

Type(EIA)	Chip Cavity		Insertion Pitch F	Tape Thickness
	A	B		T
□MK105 (0402)	0.65	1.15	2.0±0.05	0.8max.
□MF105 (0402)				
□VK105 (0402)				

Unit: mm

● Punched carrier tape (4mm pitch)

Unit: mm (inch)

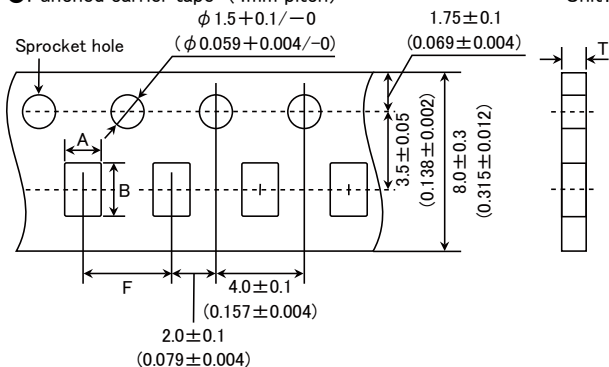

Type(EIA)	Chip Cavity		Insertion Pitch	Tape Thickness	
	A	B		F	T
□MK107(0603) □WK107(0306) ※ □MF107(0603)	1.0	1.8	4.0±0.1	1.1max.	
□MK212(0805) □WK212(0508) ※	1.65	2.4		1.1max.	
□MK316(1206)	2.0	3.6			

Note: Taping size might be different depending on the size of the product. ※ LW Reverse type.

Unit: mm



Type(EIA)	Chip Cavity		Insertion Pitch	Tape Thickness	
	A	B		K	T
□MK021(008004) □VS021(008004)	0.135	0.27	1.0±0.02	0.5max.	0.25max.
□MK042(01005) □VS042(01005)					

Unit: mm



Type(EIA)	Chip Cavity		Insertion Pitch	Tape Thickness	
	A	B		K	T
□MK105(0402)	0.6	1.1	2.0±0.1	0.6max.	0.2±0.1
□WK107(0306) ※ □MK212(0805) □MF212(0805)	1.0	1.8	4.0±0.1	1.3max.	0.25±0.1
□MK316(1206) □MF316(1206)	2.0	3.6		3.4max.	0.6max.
□MK325(1210) □MF325(1210)	2.8	3.6			

Note: ※ LW Reverse type.

Unit: mm



Type(EIA)	Chip Cavity		Insertion Pitch	Tape Thickness	
	A	B	F	K	T
□MK325(1210)	3.1	4.0	8.0±0.1	4.0max.	0.6max.
□MK432(1812)	3.7	4.9	8.0±0.1	4.0max.	0.6max.

Unit: mm

#### ④Trailer and Leader



#### ⑤Reel size

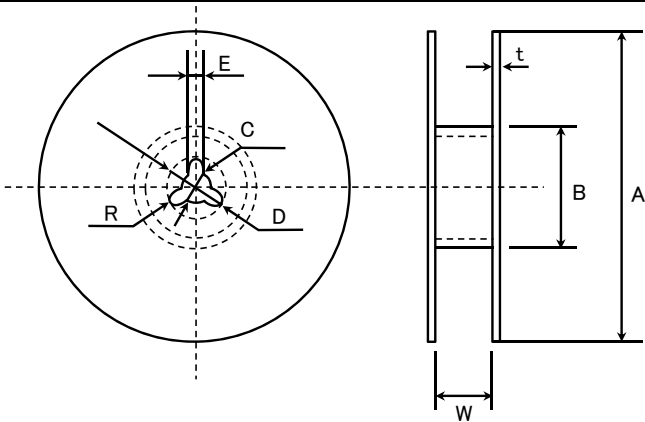

A	B	C	D	E	R
φ178±2.0	φ50min.	φ13.0±0.2	φ21.0±0.8	2.0±0.5	1.0
	T	W			
4mm wide tape	1.5max.	5±1.0			
8mm wide tape	2.5max.	10±1.5			
12mm wide tape	2.5max.	14±1.5			

Unit: mm

#### ⑥Top Tape Strength

The top tape requires a peel-off force of 0.1 to 0.7N in the direction of the arrow as illustrated below.



# Multilayer Ceramic Capacitors

## RELIABILITY DATA

1. Operating Temperature Range																										
Specified Value	Temperature Compensating (Class1)	Standard	-55 to +125°C																							
		High Frequency Type																								
	High Permittivity (Class2)																									
			<table border="1"> <thead> <tr> <th></th> <th>Specification</th> <th>Temperature Range</th> </tr> </thead> <tbody> <tr> <td rowspan="2">BJ</td> <td>B</td> <td>-25 to +85°C</td> </tr> <tr> <td>X5R</td> <td>-55 to +85°C</td> </tr> <tr> <td>B7</td> <td>X7R</td> <td>-55 to +125°C</td> </tr> <tr> <td>C6</td> <td>X6S</td> <td>-55 to +105°C</td> </tr> <tr> <td>C7</td> <td>X7S</td> <td>-55 to +125°C</td> </tr> <tr> <td>D7</td> <td>X7T</td> <td>-55 to +125°C</td> </tr> <tr> <td>LD(※)</td> <td>X5R</td> <td>-55 to +85°C</td> </tr> </tbody> </table>		Specification	Temperature Range	BJ	B	-25 to +85°C	X5R	-55 to +85°C	B7	X7R	-55 to +125°C	C6	X6S	-55 to +105°C	C7	X7S	-55 to +125°C	D7	X7T	-55 to +125°C	LD(※)	X5R	-55 to +85°C
	Specification	Temperature Range																								
BJ	B	-25 to +85°C																								
	X5R	-55 to +85°C																								
B7	X7R	-55 to +125°C																								
C6	X6S	-55 to +105°C																								
C7	X7S	-55 to +125°C																								
D7	X7T	-55 to +125°C																								
LD(※)	X5R	-55 to +85°C																								
			Note: ※LD Low distortion high value multilayer ceramic capacitor																							

2. Storage Conditions																										
Specified Value	Temperature Compensating (Class1)	Standard	-55 to +125°C																							
		High Frequency Type																								
	High Permittivity (Class2)																									
			<table border="1"> <thead> <tr> <th></th> <th>Specification</th> <th>Temperature Range</th> </tr> </thead> <tbody> <tr> <td rowspan="2">BJ</td> <td>B</td> <td>-25 to +85°C</td> </tr> <tr> <td>X5R</td> <td>-55 to +85°C</td> </tr> <tr> <td>B7</td> <td>X7R</td> <td>-55 to +125°C</td> </tr> <tr> <td>C6</td> <td>X6S</td> <td>-55 to +105°C</td> </tr> <tr> <td>C7</td> <td>X7S</td> <td>-55 to +125°C</td> </tr> <tr> <td>D7</td> <td>X7T</td> <td>-55 to +125°C</td> </tr> <tr> <td>LD(※)</td> <td>X5R</td> <td>-55 to +85°C</td> </tr> </tbody> </table>		Specification	Temperature Range	BJ	B	-25 to +85°C	X5R	-55 to +85°C	B7	X7R	-55 to +125°C	C6	X6S	-55 to +105°C	C7	X7S	-55 to +125°C	D7	X7T	-55 to +125°C	LD(※)	X5R	-55 to +85°C
	Specification	Temperature Range																								
BJ	B	-25 to +85°C																								
	X5R	-55 to +85°C																								
B7	X7R	-55 to +125°C																								
C6	X6S	-55 to +105°C																								
C7	X7S	-55 to +125°C																								
D7	X7T	-55 to +125°C																								
LD(※)	X5R	-55 to +85°C																								
			Note: ※LD Low distortion high value multilayer ceramic capacitor																							

3. Rated Voltage			
Specified Value	Temperature Compensating (Class1)	Standard	50VDC, 25VDC
		High Frequency Type	50VDC, 25VDC
	High Permittivity (Class2)		50VDC, 35VDC, 25VDC, 16VDC, 10VDC, 6.3VDC, 4VDC, 2.5VDC

4. Withstanding Voltage (Between terminals)			
Specified Value	Temperature Compensating (Class1)	Standard	No breakdown or damage
		High Frequency Type	
	High Permittivity (Class2)		
Test Methods and Remarks		Class 1	Class 2
	Applied voltage	Rated volta × 3	Rated voltage × 2.5
	Duration	1 to 5 sec.	
	Charge/discharge current	50mA max.	

5. Insulation Resistance			
Specified Value	Temperature Compensating (Class1)	Standard	10000 MΩ min.
		High Frequency Type	
	High Permittivity (Class2) Note 1		C ≤ 0.047 μF : 10000 MΩ min. C > 0.047 μF : 500MΩ · μF
Test Methods and Remarks	Applied voltage	: Rated voltage	
	Duration	: 60 ± 5 sec.	
	Charge/discharge current	: 50mA max.	

▶ This catalog contains the typical specification only due to the limitation of space. When you consider the purchase of our products, please check our specification. For details of each product (characteristics graph, reliability information, precautions for use, and so on), see our Web site (<http://www.ty-top.com/>).

6. Capacitance (Tolerance)					
Specified Value	Temperature Compensating(Class1)	Standard	C□	0.2pF ≤ C ≤ 5pF : ±0.25pF	
			U□	0.2pF ≤ C ≤ 10pF : ±0.5pF	
	SL	C > 10pF : ±5% or ±10%			
High Permittivity (Class2)	High Frequency Type	CH	0.3pF ≤ C ≤ 2pF : ±0.1pF	C > 2pF : ±5%	
	BJ, B7, C6, C7, D7, LD(※) : ±10% or ±20% Note: ※LD Low distortion high value multilayer ceramic capacitor				
Test Methods and Remarks	Class 1		Class 2		
	Standard		High Frequency Type	C ≤ 10 μF	C > 10 μF
	Preconditioning		None		
	Measuring frequency		Thermal treatment (at 150°C for 1hr) Note 2		
	Measuring voltage Note		1MHz ± 10%	1kHz ± 10%	120 ± 10Hz
Bias application		0.5 to 5Vrms	1 ± 0.2Vrms	0.5 ± 0.1rms	
		one			

7. Q or Dissipation Factor					
Specified Value	Temperature Compensating(Class1)	Standard	C < 30pF : Q ≥ 400 + 20C		
			C ≥ 30pF : Q ≥ 1000 (C : Nominal capacitance)		
	High Frequency Type	Refer to detailed specification			
High Permittivity (Class2) Note 1		BJ, B7, C6, C7, D7: 2.5% max.			
Test Methods and Remarks	Class 1		Class 2		
	Standard		High Frequency Type	C ≤ 10 μF	C > 10 μF
	Preconditioning		None		
	Measuring frequency		Thermal treatment (at 150°C for 1hr) Note 2		
	Measuring voltage Note 1		1MHz ± 10%	1GHz	1kHz ± 10%
Bias application		0.5 to 5Vrms	1 ± 0.2Vrms	0.5 ± 0.1Vrms	
High Frequency Type		None			
Measuring equipment		: HP4291A			
Measuring jig		: HP16192A			

8. Temperature Characteristic (Without voltage application)																																										
Specified Value	Temperature Compensating(Class1)	Standard	Temperature Characteristic [ppm/°C]		Tolerance [ppm/°C]																																					
			C□ : 0	CG, CH, C, J, CK	G : ±30																																					
			U□ : -750	UJ, UK	H : ±60																																					
High Permittivity (Class2)	High Frequency Type	CH	Temperature Characteristic [ppm/°C]		Tolerance [ppm/°C]																																					
			C□ : 0	CH	H : ±60																																					
			<table border="1"> <thead> <tr> <th></th> <th>Specification</th> <th>Capacitance change</th> <th>Reference temperature</th> <th>Temperature Range</th> </tr> </thead> <tbody> <tr> <td rowspan="2">BJ</td> <td>B</td> <td>±10%</td> <td>20°C</td> <td>-25 to +85°C</td> </tr> <tr> <td>X5R</td> <td>±15%</td> <td>25°C</td> <td>-55 to +85°C</td> </tr> <tr> <td>B7</td> <td>X7R</td> <td>±15%</td> <td>25°C</td> <td>-55 to +125°C</td> </tr> <tr> <td>C6</td> <td>X6S</td> <td>±22%</td> <td>25°C</td> <td>-55 to +105°C</td> </tr> <tr> <td>C7</td> <td>X7S</td> <td>±22%</td> <td>25°C</td> <td>-55 to +125°C</td> </tr> <tr> <td>D7</td> <td>X7S</td> <td>+22/-33%</td> <td>25°C</td> <td>-55 to +125°C</td> </tr> <tr> <td>LD(※)</td> <td>X5R</td> <td>±15%</td> <td>25°C</td> <td>-55 to +85°C</td> </tr> </tbody> </table>					Specification	Capacitance change	Reference temperature	Temperature Range	BJ	B	±10%	20°C	-25 to +85°C	X5R	±15%	25°C	-55 to +85°C	B7	X7R	±15%	25°C	-55 to +125°C	C6	X6S	±22%	25°C	-55 to +105°C	C7	X7S	±22%	25°C	-55 to +125°C	D7	X7S	+22/-33%	25°C	-55 to +125°C	LD(※)	X5R
	Specification	Capacitance change	Reference temperature	Temperature Range																																						
BJ	B	±10%	20°C	-25 to +85°C																																						
	X5R	±15%	25°C	-55 to +85°C																																						
B7	X7R	±15%	25°C	-55 to +125°C																																						
C6	X6S	±22%	25°C	-55 to +105°C																																						
C7	X7S	±22%	25°C	-55 to +125°C																																						
D7	X7S	+22/-33%	25°C	-55 to +125°C																																						
LD(※)	X5R	±15%	25°C	-55 to +85°C																																						
Note : ※LD Low distortion high value multilayer ceramic capacitor																																										

Test Methods and Remarks	Class 1			
	Capacitance at 20°C and 85°C shall be measured in thermal equilibrium, and the temperature characteristic shall be calculated from the following equation.			
	$\frac{(C_{85} - C_{20})}{C_{20} \times \Delta T} \times 10^6 (\text{ppm}/^\circ\text{C}) \quad \Delta T = 65$			
	Class 2			
	Capacitance at each step shall be measured in thermal equilibrium, and the temperature characteristic shall be calculated from the following equation.			
Step	B	X5R, X7R, X6S, X7S, X7T		
1	Minimum operating temperature			
2	20°C	25°C		
3	Maximum operating temperature			

▶ This catalog contains the typical specification only due to the limitation of space. When you consider the purchase of our products, please check our specification. For details of each product (characteristics graph, reliability information, precautions for use, and so on), see our Web site (<http://www.ty-top.com/>).

	$\frac{(C - C_2)}{C_2} \times 100(\%)$ <p>C : Capacitance in Step 1 or Step 3 C2 : Capacitance in Step 2</p>
--	--

**9. Deflection**

Specified Value	Temperature Compensating(Class1)	Standard	Appearance : No abnormality Capacitance change : Within $\pm 5\%$ or $\pm 0.5$ pF, whichever is larger.
		High Frequency Type	Appearance : No abnormality Capacitance change : Within $\pm 0.5$ pF
	High Permittivity (Class2)		Appearance : No abnormality Capacitance change : Within $\pm 12.5\%$ (BJ, B7, C6, C7, D7, LD(※)) Note: ※LD Low distortion high value multilayer ceramic capacitor

Test Methods and Remarks	<table border="1"> <tr> <th colspan="2">Multilayer Ceramic Capacitors</th> </tr> <tr> <td>042, 063, ※1105 Type</td> <td>The other types</td> </tr> <tr> <th colspan="2">Glass epoxy-resin substrate</th> </tr> <tr> <td>Thickness</td> <td>0.8mm      1.6mm</td> </tr> <tr> <td>Warp</td> <td>1mm (Soft Termination type:3mm)</td> </tr> <tr> <td>Duration</td> <td>10 sec.</td> </tr> </table> <p>※1:105 Type thickness, C: 0.2mm, P: 0.3mm.</p>	Multilayer Ceramic Capacitors		042, 063, ※1105 Type	The other types	Glass epoxy-resin substrate		Thickness	0.8mm      1.6mm	Warp	1mm (Soft Termination type:3mm)	Duration	10 sec.	<p>(Unit: mm)</p> <p>Capacitance measurement shall be conducted with the board bent</p>
	Multilayer Ceramic Capacitors													
042, 063, ※1105 Type	The other types													
Glass epoxy-resin substrate														
Thickness	0.8mm      1.6mm													
Warp	1mm (Soft Termination type:3mm)													
Duration	10 sec.													

**10. Body Strength**

Specified Value	Temperature Compensating(Class1)	Standard	—
		High Frequency Type	No mechanical damage.
	High Permittivity (Class2)		—

Test Methods and Remarks	<p>High Frequency Type Applied force : 5N Duration : 10 sec.</p>
--------------------------	--

**11. Adhesive Strength of Terminal Electrodes**

Specified Value	Temperature Compensating(Class1)	Standard	No terminal separation or its indication.
		High Frequency Type	
	High Permittivity (Class2)		

Test Methods and Remarks	<table border="1"> <tr> <th colspan="2">Multilayer Ceramic Capacitors</th> </tr> <tr> <td>042, 063 Type</td> <td>105 Type or more</td> </tr> <tr> <td>Applied force</td> <td>2N      5N</td> </tr> <tr> <td>Duration</td> <td>30 ± 5 sec.</td> </tr> </table>	Multilayer Ceramic Capacitors		042, 063 Type	105 Type or more	Applied force	2N      5N	Duration	30 ± 5 sec.	
	Multilayer Ceramic Capacitors									
	042, 063 Type	105 Type or more								
Applied force	2N      5N									
Duration	30 ± 5 sec.									

**12. Solderability**

Specified Value	Temperature Compensating(Class1)	Standard	At least 95% of terminal electrode is covered by new solder.
		High Frequency Type	
	High Permittivity (Class2)		

Test Methods and Remarks		Eutectic solder	Lead-free solder
	Solder type	H60A or H63A	Sn-3.0Ag-0.5Cu
	Solder temperature	230 ± 5°C	245 ± 3°C
	Duration	4 ± 1 sec.	

▶ This catalog contains the typical specification only due to the limitation of space. When you consider the purchase of our products, please check our specification. For details of each product (characteristics graph, reliability information, precautions for use, and so on), see our Web site (<http://www.ty-top.com/>).

### 13. Resistance to Soldering

Specified Value	Temperature Compensating(Class1)	Standard	Appearance : No abnormality Capacitance change : Within $\pm 2.5\%$ or $\pm 0.25\text{pF}$ , whichever is larger. Q : Initial value Insulation resistance : Initial value Withstanding voltage (between terminals) : No abnormality
		High Frequency Type	Appearance : No abnormality Capacitance change : Within $\pm 2.5\%$ Q : Initial value Insulation resistance : Initial value Withstanding voltage (between terminals) : No abnormality
	High Permittivity (Class2) Note 1		Appearance : No abnormality Capacitance change : Within $\pm 7.5\%$ (BJ, B7, C6, C7, D7, LD(※)) Dissipation factor : Initial value Insulation resistance : Initial value Withstanding voltage (between terminals): No abnormality Note: ※LD Low distortion high value multilayer ceramic capacitor

Test Methods and Remarks	Class 1	
	042, 063 Type	105 Type
	Preconditioning	None
	Preheating	150°C, 1 to 2 min.      80 to 100°C, 2 to 5 min. 150 to 200°C, 2 to 5 min.
	Solder temp.	270 $\pm$ 5°C
	Duration	3 $\pm$ 0.5 sec.
	Recovery	6 to 24 hrs (Standard condition) Note 5
	Class 2	
	042, 063 Type	105, 107, 212 Type      316, 325 Type
	Preconditioning	Thermal treatment (at 150°C for 1 hr) Note 2
	Preheating	150°C, 1 to 2 min.      80 to 100°C, 2 to 5 min.      80 to 100°C, 5 to 10 min. 150 to 200°C, 2 to 5 min.      150 to 200°C, 5 to 10 min.
	Solder temp.	270 $\pm$ 5°C
	Duration	3 $\pm$ 0.5 sec.
	Recovery	24 $\pm$ 2 hrs (Standard condition) Note 5

### 14. Temperature Cycle (Thermal Shock)

Specified Value	Temperature Compensating(Class1)	Standard	Appearance : No abnormality Capacitance change : Within $\pm 2.5\%$ or $\pm 0.25\text{pF}$ , whichever is larger. Q : Initial value Insulation resistance : Initial value Withstanding voltage (between terminals) : No abnormality
		High Frequency Type	Appearance : No abnormality Capacitance change : Within $\pm 0.25\text{pF}$ Q : Initial value Insulation resistance : Initial value Withstanding voltage (between terminals) : No abnormality
	High Permittivity (Class2) Note 1		Appearance : No abnormality Capacitance change : Within $\pm 7.5\%$ (BJ, B7, C6, C7, D7, LD(※)) Dissipation factor : Initial value Insulation resistance : Initial value Withstanding voltage (between terminals) : No abnormality Note: ※LD Low distortion high value multilayer ceramic capacitor

Test Methods and Remarks	Class 1		Class 2	
	None		Thermal treatment (at 150°C for 1 hr) Note 2	
	1 cycle	Step	Temperature (°C)	Time (min.)
		1	Minimum operating temperature	30 $\pm$ 3
		2	Normal temperature	2 to 3
		3	Maximum operating temperature	30 $\pm$ 3
4	Normal temperature	2 to 3		
Number of cycles	5 times			
Recovery	6 to 24 hrs (Standard condition) Note 5	24 $\pm$ 2 hrs (Standard condition) Note 5		

▶ This catalog contains the typical specification only due to the limitation of space. When you consider the purchase of our products, please check our specification. For details of each product (characteristics graph, reliability information, precautions for use, and so on), see our Web site (<http://www.ty-top.com/>).



15. Humidity (Steady State)

Specified Value	Temperature Compensating(Class1)	Standard	Appearance : No abnormality Capacitance change : Within $\pm 5\%$ or $\pm 0.5\text{pF}$ , whichever is larger. Q : $C < 10\text{pF} : Q \geq 200 + 10C$ $10 \leq C < 30\text{pF} : Q \geq 275 + 2.5C$ $C \geq 30\text{pF} : Q \geq 350$ (C: Nominal capacitance) Insulation resistance : 1000 M $\Omega$ min.		
		High Frequency Type	Appearance : No abnormality Capacitance change : Within $\pm 0.5\text{pF}$ , Insulation resistance : 1000 M $\Omega$ min.		
	High Permittivity (Class2) Note 1		Appearance : No abnormality Capacitance change : Within $\pm 12.5\%$ (BJ, B7, C6, C7, D7, LD(※)) Dissipation factor : 5.0% max. (BJ, B7, C6, C7, D7, LD(※)) Insulation resistance : 50 M $\Omega\mu\text{F}$ or 1000 M $\Omega$ whichever is smaller. Note: ※LD Low distortion high value multilayer ceramic capacitor		
Test Methods and Remarks		Class 1		Class 2	
		Standard	High Frequency Type	All items	
	Preconditioning	None			Thermal treatment ( at 150°C for 1 hr) Note 2
	Temperature	40 $\pm$ 2°C	60 $\pm$ 2°C	40 $\pm$ 2°C	
	Humidity	90 to 95%RH			90 to 95%RH
	Duration	500+24/-0 hrs			500+24/-0 hrs
	Recovery	6 to 24 hrs (Standard condition) Note 5			24 $\pm$ 2 hrs (Standard condition) Note 5

16. Humidity Loading

Specified Value	Temperature Compensating(Class1)	Standard	Appearance : No abnormality Capacitance change : Within $\pm 7.5\%$ or $\pm 0.75\text{pF}$ , whichever is larger. Q : $C < 30\text{pF} : Q \geq 100 + 10C/3$ $C \geq 30\text{pF} : Q \geq 200$ (C: Nominal capacitance) Insulation resistance : 500 M $\Omega$ min.		
		High Frequency Type	Appearance : No abnormality Capacitance change : $C \leq 2\text{pF} : \text{Within } \pm 0.4 \text{ pF}$ $C > 2\text{pF} : \text{Within } \pm 0.75 \text{ pF}$ (C: Nominal capacitance) Insulation resistance : 500 M $\Omega$ min.		
	High Permittivity (Class2) Note 1		Appearance : No abnormality Capacitance change : Within $\pm 12.5\%$ (BJ, B7, C6, C7, D7, LD(※)) Dissipation factor : 5.0% max. (BJ, B7, C6, C7, D7, LD(※)) Insulation resistance : 25 M $\Omega\mu\text{F}$ or 500 M $\Omega$ whichever is smaller. Note: ※LD Low distortion high value multilayer ceramic capacitor		
Test Methods and Remarks		Class 1		Class 2	
		Standard	High Frequency Type	All items	
	Preconditioning	None			Voltage treatment (Rated voltage are applied for 1 hour at 40°C) Note 3
	Temperature	40 $\pm$ 2°C	60 $\pm$ 2°C	40 $\pm$ 2°C	
	Humidity	90 to 95%RH			90 to 95%RH
	Duration	500+24/-0 hrs			500+24/-0 hrs
	Applied voltage	Rated voltage			Rated voltage
	Charge/discharge current	50mA max.			50mA max.
Recovery	6 to 24 hrs (Standard condition) Note 5			24 $\pm$ 2 hrs (Standard condition) Note 5	

► This catalog contains the typical specification only due to the limitation of space. When you consider the purchase of our products, please check our specification.  
For details of each product (characteristics graph, reliability information, precautions for use, and so on), see our Web site (<http://www.ty-top.com/>).

17. High Temperature Loading

Specified Value	Temperature Compensating(Class1)	Standard	Appearance : No abnormality Capacitance change : Within $\pm 3\%$ or $\pm 0.3\text{pF}$ , whichever is larger. Q : $C < 10\text{pF}$ : $Q \geq 200 + 10C$ $10 \leq C < 30\text{pF}$ : $Q \geq 275 + 2.5C$ $C \geq 30\text{pF}$ : $Q \geq 350$ (C: Nominal capacitance) Insulation resistance : 1000 M $\Omega$ min.
		High Frequency Type	Appearance : No abnormality Capacitance change : Within $\pm 3\%$ or $\pm 0.3\text{pF}$ , whichever is larger. Insulation resistance : 1000 M $\Omega$ min.
	High Permittivity (Class2) Note 1		Appearance : No abnormality Capacitance change : Within $\pm 12.5\%$ (BJ, B7, C6, C7, D7, LD(※)) Dissipation factor : 5.0% max. (BJ, B7, C6, C7, D7, LD(※)) Insulation resistance : 50 M $\Omega$ or 1000 M $\Omega$ whichever is smaller. Note: ※LD Low distortion high value multilayer ceramic capacitor

Test Methods and Remarks		Class 1		Class 2		
		Standard	High Frequency Type	BJ, LD(※)	C6	B7, C7, D7
	Preconditioning	None		Voltage treatment (Twice the rated voltage shall be applied for 1 hour at 85°C, 105°C or 125°C) Note 3, 4		
	Temperature	Maximum operating temperature		Maximum operating temperature		
	Duration	1000+48/-0 hrs		1000+48/-0 hrs		
	Applied voltage	Rated voltage $\times 2$		Rated voltage $\times 2$ Note 4		
	Charge/discharge current	50mA max.		50mA max.		
	Recovery	6 to 24hr (Standard condition) Note 5		24 $\pm 2$ hrs (Standard condition) Note 5		
Note: ※LD Low distortion high value multilayer ceramic capacitor						

Note 1 The figures indicate typical specifications. Please refer to individual specifications in detail.

Note 2 Thermal treatment : Initial value shall be measured after test sample is heat-treated at 150+0/-10°C for an hour and kept at room temperature for 24 $\pm 2$ hours.

Note 3 Voltage treatment : Initial value shall be measured after test sample is voltage-treated for an hour at both the temperature and voltage specified in the test conditions, and kept at room temperature for 24 $\pm 2$ hours.

Note 4 150% of rated voltage is applicable to some items. Please refer to their specifications for further information.

Note 5 Standard condition: Temperature: 5 to 35°C, Relative humidity: 45 to 85 % RH, Air pressure: 86 to 106kPa When there are questions concerning measurement results, in order to provide correlation data, the test shall be conducted under the following condition.  
Temperature: 20 $\pm 2$ °C, Relative humidity: 60 to 70 % RH, Air pressure: 86 to 106kPa Unless otherwise specified, all the tests are conducted under the "standard condition".

# Medium-High Voltage Multilayer Ceramic Capacitor

## RELIABILITY DATA

1. Operating Temperature Range	
Specified Value	Temperature Compensating(High Frequency type) CG(C0G) : -55 to +125°C
	High permittivity X7R, X7S : -55 to +125°C X5 : -55 to +85°C B : -25 to +85°C
2. Storage Temperature Range	
Specified Value	Temperature Compensating(High Frequency type) CG(C0G) : -55 to +125°C
	High permittivity X7R, X7S : -55 to +125°C X5R : -55 to +85°C B : -25 to +85°C
3. Rated Voltage	
Specified Value	100VDC(HMK,HMJ), 250VDC(QMK,QMJ,QVS), 630VDC(SMK,SMJ)
4. Withstanding Voltage (Between terminals)	
Specified Value	No breakdown or damage
Test Methods and Remarks	Applied voltage : Rated voltage × 2.5 (HMK,HMJ), Rated voltage × 2 (QMK,QMJ,QVS), Rated voltage × 1.2 (SMK,SMJ) Duration : 1 to 5sec. Charge/discharge current : 50mA max.
5. Insulation Resistance	
Specified Value	Temperature Compensating(High Frequency type) 10000MΩ min
	High permittivity 100MΩμF or 10GΩ whichever is smaller.
Test Methods and Remarks	Applied voltage : Rated voltage (HMK,HMJ, QMK,QMJ,QVS), 500V (SMK,SMJ) Duration : 60±5sec. Charge/discharge current : 50mA max.
6. Capacitance (Tolerance)	
Specified Value	Temperature Compensating(High Frequency type) ±0.1pF (C<5pF) ±0.25pF (C<10pF) ±0.5pF (5pF≤C<10pF) ±2%(C=10pF) ±5%(C≥10pF)
	High permittivity ±10%, ±20%
Test Methods and Remarks	Temperature Compensating(High Frequency type) Measuring frequency : 1MHz±10% Measuring voltage : 0.5 to 5Vrms Bias application : None
	High permittivity Measuring frequency : 1kHz±10% Measuring voltage : 1±0.2Vrms Bias application : None

▶ This catalog contains the typical specification only due to the limitation of space. When you consider the purchase of our products, please check our specification.  
For details of each product (characteristics graph, reliability information, precautions for use, and so on), see our Web site (<http://www.ty-top.com/>).

7. Q or Dissipation Factor	
Specified Value	Temperature Compensating(High Frequency type) $C < 30\text{pF} : Q \geq 800 + 20C$ $C \geq 30\text{pF} : Q \geq 1400$ C:Normal Capacitance(/pF)  High permittivity 3.5%max (HMK,HMJ) 2.5%max (QMK,QMJ, SMK,SMJ)
Test Methods and Remarks	Temperature Compensating(High Frequency type) Measuring frequency       : 1MHz±10% Measuring voltage         : 0.5 to 5Vrms Bas application             : None  High permittivity Measuring frequency       : 1kHz±10% Measuring voltage         : 1±0.2Vrms Bas application             : None

### 8. Temperature Characteristic of Capacitance

Specified Value	Temperature Compensating(High Frequency type) C0G               : ±30ppm(25 to +125°C)  High permittivity B               : ±10% (-25 to +85°C) X5R           : ±15% (-55 to +85°C) X7R           : ±15% (-55 to +125°C) X7S           : ±22% (-55 to +125°C)												
Test Methods and Remarks	Temperature Compensating(High Frequency type) Capacitance at 25°C and 85°C shall be measured in thermal equilibrium, and the temperature characteristic shall be calculated from the following equation. $\frac{(C_{85} - C_{25})}{C_{25} \times \Delta T} \times 10^6 \times [\text{ppm}/^\circ\text{C}]$ High permittivity Capacitance value at each step shall be measured in thermal equilibrium, and the temperature characteristic shall be calculated from the following equation. <table border="1" style="margin: 10px auto;"> <thead> <tr> <th>Step</th> <th>B</th> <th>X5R, X7R, X7S</th> </tr> </thead> <tbody> <tr> <td>1</td> <td colspan="2">Minimum operating temperature</td> </tr> <tr> <td>2</td> <td>20°C</td> <td>25°C</td> </tr> <tr> <td>3</td> <td colspan="2">Maximum operating temperature</td> </tr> </tbody> </table> $\frac{(C - C_2)}{C_2} \times 100 (\%)$ C : Capacitance value in Step 1 or Step 3 C2 : Capacitance value in Step 2	Step	B	X5R, X7R, X7S	1	Minimum operating temperature		2	20°C	25°C	3	Maximum operating temperature	
Step	B	X5R, X7R, X7S											
1	Minimum operating temperature												
2	20°C	25°C											
3	Maximum operating temperature												

### 9. Deflection

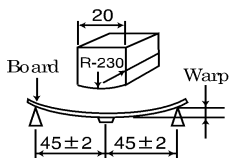
Specified Value	Temperature Compensating(High Frequency type) Appearance               : No abnormality Capacitance change       : ±5% or ±0.5pF, whichever is larger.  High permittivity Appearance               : No abnormality Capacitance change       : Within ±10%
Test Methods and Remarks	Warp               : 1mm (Soft Termination type:3mm) Duration           : 10sec. Test board       : Glass epoxy-resin substrate Thicknss         : 1.6mm   (Unit: mm)  Capacitance measurement shall be conducted with the board bent.

▶ This catalog contains the typical specification only due to the limitation of space. When you consider the purchase of our products, please check our specification. For details of each product (characteristics graph, reliability information, precautions for use, and so on), see our Web site (<http://www.ty-top.com/>).

### 10. Adhesive Strength of Terminal Electrodes

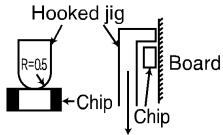
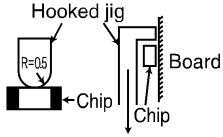
Specified Value	No terminal separation or its indication.
Test Methods and Remarks	Temperature Compensating(High Frequency type) Applied force : 2N Duration : 10±5sec. 
	High permittivity Applied force : 5N Duration : 30±5sec. 

### 11. Solderability

Specified Value	At least 95% of terminal electrode is covered by new solder		
Test Methods and Remarks		Eutectic solder	Lead-free solder
	Solder type	H60A or H63A	Sn-3.0Ag-0.5Cu
	Solder temperature	230±5°C	245±3°C
	Duration	4±1 sec.	

### 12. Resistance to Soldering

Specified Value	Temperature Compensating(High Frequency type) Appearance : No abnormality Capacitance change : C※ ≤ 10pF : ±0.25pF C※ > 10pF : ±2.5% ※Normal capacitance Insulation resistance : Initial value Withstanding voltage (between terminals) : No abnormality
	High permittivity Appearance : No abnormality Capacitance change : Within ±15% (HMK, HMJ), ±10% (QMK, QMJ, SMK, SMJ) Dissipation factor : Initial value Insulation resistance : Initial value Withstanding voltage (between terminals) : No abnormality
Test Methods and Remarks	Preconditioning : Thermal treatment (at 150°C for 1hr) Note1 (Only High permittivity) Solder temperature : 270±5°C Duration : 3±0.5sec. Preheating conditions : 80 to 100°C, 2 to 5 min.      150 to 200°C, 2 to 5 min. Recovery : 24±2hrs under the standard condition Note3

### 13. Temperature Cycle (Thermal Shock)

Specified Value	Temperature Compensating(High Frequency type) Appearance : No abnormality Capacitance change : C※ ≤ 10pF : ±0.25% C※ > 10pF : ±2.5% Insulation resistance : Initial value Withstanding voltage (between terminals) : No abnormality														
	High permittivity Appearance : No abnormality Capacitance change : Within ±15% (HMK, HMJ), ±7.5% (QMK, QMJ, SMK, SMJ) Dissipation factor : Initial value Insulation resistance : Initial value Withstanding voltage (between terminals) : No abnormality														
Test Methods and Remarks	Preconditioning : Thermal treatment (at 150°C for 1hr) Note1 Conditions for 1 cycle														
	<table border="1" data-bbox="287 1780 1125 1921"> <thead> <tr> <th>Step</th> <th>temperature (°C)</th> <th>Time (min.)</th> </tr> </thead> <tbody> <tr> <td>1</td> <td>Minimum operating temperature</td> <td>30±3min.</td> </tr> <tr> <td>2</td> <td>Normal temperature</td> <td>2 to 3min.</td> </tr> <tr> <td>3</td> <td>Maximum operating temperature</td> <td>30±3min.</td> </tr> <tr> <td>4</td> <td>Normal temperature</td> <td>2 to 3min.</td> </tr> </tbody> </table> Number of cycles : 5 times Recovery : 24±2hrs under the standard condition Note3	Step	temperature (°C)	Time (min.)	1	Minimum operating temperature	30±3min.	2	Normal temperature	2 to 3min.	3	Maximum operating temperature	30±3min.	4	Normal temperature
Step	temperature (°C)	Time (min.)													
1	Minimum operating temperature	30±3min.													
2	Normal temperature	2 to 3min.													
3	Maximum operating temperature	30±3min.													
4	Normal temperature	2 to 3min.													

▶ This catalog contains the typical specification only due to the limitation of space. When you consider the purchase of our products, please check our specification. For details of each product (characteristics graph, reliability information, precautions for use, and so on), see our Web site (<http://www.ty-top.com/>).

14. Humidity (Steady state)	
Specified Value	Temperature Compensating(High Frequency type) Appearance : No abnormality Capacitance change : C※ ≤ 10pF : ±0.5pF C※ > 10pF : ±5% ※Normal capacitance Insulation resistance : 1000M Ωmin
	High permittivity Appearance : No abnormality Capacitance change : Within ±15% Dissipation factor : 7%max (HMK, HMJ), 5%max (QMK, QMJ, SMK, SMJ). Insulation resistance : 25M ΩμF or 1000M Ω whichever is smaller.
Test Methods and Remarks	Preconditioning : Thermal treatment (at 150°C for 1hr) Note1 (Only High permittivity) Temperature : 40 ± 2°C Humidity : 90 to 95%RH Duration : 500 +24/ -0 hrs Recovery : 24 ± 2hrs under the standard condition Note3

15. Humidity Loading	
Specified Value	Temperature Compensating(High Frequency type) Appearance : No abnormality Capacitance change : C※ ≤ 2.0pF : ±0.4pF 2.0pF < C ≤ 10pF : ±0.75pF C※ > 10pF : ±7.5% : ※Normal capacitance Insulation resistance : 500M Ωmin
	High permittivity Appearance : No abnormality Capacitance change : Within ±15% Dissipation factor : 7%max (HMK, HMJ), 5%max (QMK, QMJ, SMK, SMJ). Insulation resistance : 10M ΩμF or 500M Ω whichever is smaller.
Test Methods and Remarks	According to JIS 5102 clause 9.9. Preconditioning : Voltage treatment Note2 (Only High permittivity) Temperature : 40 ± 2°C Humidity : 90 to 95%RH Applied voltage : Rated voltage Charge/discharge current : 50mA max. Duration : 500 +24/ -0 hrs Recovery : 24 ± 2hrs under the standard condition Note3

16. High Temperature Loading	
Specified Value	Temperature Compensating(High Frequency type) Appearance : No abnormality Capacitance change : C※ ≤ 10pF : ±0.3pF C※ > 10pF : ±3% Insulation resistance : 1000M Ωmin
	High permittivity Appearance : No abnormality Capacitance change : Within ±15% Dissipation factor : 7%max (HMK, HMJ), 5%max (QMK, QMJ, SMK, SMJ). Insulation resistance : 50M ΩμF or 1000M Ω whichever is smaller.
Test Methods and Remarks	According to JIS 5102 clause 9.10. Preconditioning : Voltage treatment Note2 (Only High permittivity) Temperature : Maximum operating temperature Applied voltage : Rated voltage × 2 (HMK, HMJ, QVS) Rated voltage × 1.5 (QMK, QMJ) Rated voltage × 1.2 (SMK, SMJ) Charge/discharge current : 50mA max. Duration : 1000 +24/ -0 hrs Recovery : 24 ± 2hrs under the standard condition Note3

Note1 Thermal treatment : Initial value shall be measured after test sample is heat-treated at 150+0/ -10°C for an hour and kept at room temperature for 24 ± 2hours.

Note2 Voltage treatment : Initial value shall be measured after test sample is voltage-treated for an hour at both the temperature and voltage specified in the test conditions, and kept at room temperature for 24 ± 2hours.

Note3 Standard condition : Temperature: 5 to 35°C, Relative humidity: 45 to 85 % RH, Air pressure: 86 to 106kPa  
When there are questions concerning measurement results, in order to provide correlation data, the test shall be conducted under the following condition.  
Temperature: 20 ± 2°C, Relative humidity: 60 to 70 % RH, Air pressure: 86 to 106kPa  
Unless otherwise specified, all the tests are conducted under the "standard condition".

# Precautions on the use of Multilayer Ceramic Capacitors

## PRECAUTIONS

### 1. Circuit Design

- Precautions**
- ◆ Verification of operating environment, electrical rating and performance
    1. A malfunction of equipment in fields such as medical, aerospace, nuclear control, etc. may cause serious harm to human life or have severe social ramifications. Therefore, any capacitors to be used in such equipment may require higher safety and reliability, and shall be clearly differentiated from them used in general purpose applications.
  - ◆ Operating Voltage (Verification of Rated voltage)
    1. The operating voltage for capacitors must always be their rated voltage or less.
      - If an AC voltage is loaded on a DC voltage, the sum of the two peak voltages shall be the rated voltage or less.
      - For a circuit where an AC or a pulse voltage may be used, the sum of their peak voltages shall also be the rated voltage or less.
    2. Even if an applied voltage is the rated voltage or less reliability of capacitors may be deteriorated in case that either a high frequency AC voltage or a pulse voltage having rapid rise time is used in a circuit.

### 2. PCB Design

- Precautions**
- ◆ Pattern configurations (Design of Land-patterns)
    1. When capacitors are mounted on PCBs, the amount of solder used (size of fillet) can directly affect the capacitor performance. Therefore, the following items must be carefully considered in the design of land patterns:
      - (1) Excessive solder applied can cause mechanical stresses which lead to chip breaking or cracking. Therefore, please consider appropriate land-patterns for proper amount of solder.
      - (2) When more than one component are jointly soldered onto the same land, each component's soldering point shall be separated by solder-resist.
  - ◆ Pattern configurations (Capacitor layout on PCBs)
 

After capacitors are mounted on boards, they can be subjected to mechanical stresses in subsequent manufacturing processes (PCB cutting, board inspection, mounting of additional parts, assembly into the chassis, wave soldering of the boards, etc.). For this reason, land pattern configurations and positions of capacitors shall be carefully considered to minimize stresses.

- ◆ Pattern configurations (Design of Land-patterns)
 

The following diagrams and tables show some examples of recommended land patterns to prevent excessive solder amounts.

(1) Recommended land dimensions for typical chip capacitors

● Multilayer Ceramic Capacitors : Recommended land dimensions (unit: mm)

Wave-soldering

Type	107	212	316	325	
Size	L	1.6	2.0	3.2	3.2
	W	0.8	1.25	1.6	2.5
A	0.8 to 1.0	1.0 to 1.4	1.8 to 2.5	1.8 to 2.5	
B	0.5 to 0.8	0.8 to 1.5	0.8 to 1.7	0.8 to 1.7	
C	0.6 to 0.8	0.9 to 1.2	1.2 to 1.6	1.8 to 2.5	

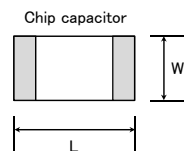
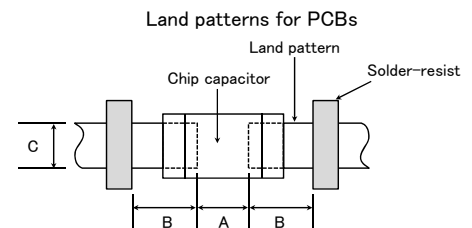

Reflow-soldering

Type	042	063	105	107	212	316	325	432
Size	L	0.4	0.6	1.0	1.6	2.0	3.2	4.5
	W	0.2	0.3	0.5	0.8	1.25	1.6	3.2
A	0.15 to 0.25	0.20 to 0.30	0.45 to 0.55	0.8 to 1.0	0.8 to 1.2	1.8 to 2.5	1.8 to 2.5	2.5 to 3.5
B	0.15 to 0.20	0.20 to 0.30	0.40 to 0.50	0.6 to 0.8	0.8 to 1.2	1.0 to 1.5	1.0 to 1.5	1.5 to 1.8
C	0.15 to 0.30	0.25 to 0.40	0.45 to 0.55	0.6 to 0.8	0.9 to 1.6	1.2 to 2.0	1.8 to 3.2	2.3 to 3.5

Note: Recommended land size might be different according to the allowance of the size of the product.

● LWDC: Recommended land dimensions for reflow-soldering (unit: mm)

Type	105	107	212	
Size	L	0.52	0.8	1.25
	W	1.0	1.6	2.0
A	0.18 to 0.22	0.25 to 0.3	0.5 to 0.7	
B	0.2 to 0.25	0.3 to 0.4	0.4 to 0.5	
C	0.9 to 1.1	1.5 to 1.7	1.9 to 2.1	

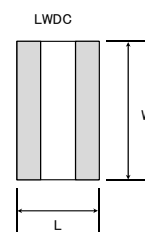

Technical considerations

\* This catalog contains the typical specification only due to the limitation of space. When you consider the purchase of our products, please check our specification. For details of each product (characteristics graph, reliability information, precautions for use, and so on), see our Web site (<http://www.ty-top.com/>).

(2) Examples of good and bad solder application

Items	Not recommended	Recommended
Mixed mounting of SMD and leaded components		
Component placement close to the chassis		
Hand-soldering of leaded components near mounted components		
Horizontal component placement		

◆ Pattern configurations (Capacitor layout on PCBs)

1-1. The following is examples of good and bad capacitor layouts ; capacitors shall be located to minimize any possible mechanical stresses from board warp or deflection.

Items	Not recommended	Recommended
Deflection of board		 Place the product at a right angle to the direction of the anticipated mechanical stress.

1-2. The amount of mechanical stresses given will vary depending on capacitor layout. Please refer to diagram below.

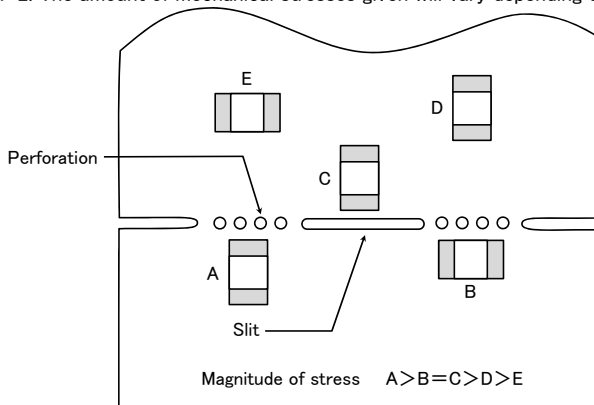

1-3. When PCB is split, the amount of mechanical stress on the capacitors can vary according to the method used. The following methods are listed in order from least stressful to most stressful: push-back, slit, V-grooving, and perforation. Thus, please consider the PCB, split methods as well as chip location.

3. Mounting

Precautions

◆ Adjustment of mounting machine

- When capacitors are mounted on PCB, excessive impact load shall not be imposed on them.
- Maintenance and inspection of mounting machines shall be conducted periodically.

◆ Selection of Adhesives

- When chips are attached on PCBs with adhesives prior to soldering, it may cause capacitor characteristics degradation unless the following factors are appropriately checked : size of land patterns, type of adhesive, amount applied, hardening temperature and hardening period. Therefore, please contact us for further information.



◆ Adjustment of mounting machine

1. When the bottom dead center of a pick-up nozzle is too low, excessive force is imposed on capacitors and causes damages. To avoid this, the following points shall be considerable.
  - (1) The bottom dead center of the pick-up nozzle shall be adjusted to the surface level of PCB without the board deflection.
  - (2) The pressure of nozzle shall be adjusted between 1 and 3 N static loads.
  - (3) To reduce the amount of deflection of the board caused by impact of the pick-up nozzle, supporting pins or back-up pins shall be used on the other side of the PCB. The following diagrams show some typical examples of good and bad pick-up nozzle placement:

Items	Not recommended	Recommended
Single-sided mounting		
Double-sided mounting		

Technical considerations

2. As the alignment pin is worn out, adjustment of the nozzle height can cause chipping or cracking of capacitors because of mechanical impact on the capacitors. To avoid this, the monitoring of the width between the alignment pins in the stopped position, maintenance, check and replacement of the pin shall be conducted periodically.

◆ Selection of Adhesives

Some adhesives may cause IR deterioration. The different shrinkage percentage of between the adhesive and the capacitors may result in stresses on the capacitors and lead to cracking. Moreover, too little or too much adhesive applied to the board may adversely affect components. Therefore, the following precautions shall be noted in the application of adhesives.

- (1) Required adhesive characteristics
  - a. The adhesive shall be strong enough to hold parts on the board during the mounting & solder process.
  - b. The adhesive shall have sufficient strength at high temperatures.
  - c. The adhesive shall have good coating and thickness consistency.
  - d. The adhesive shall be used during its prescribed shelf life.
  - e. The adhesive shall harden rapidly.
  - f. The adhesive shall have corrosion resistance.
  - g. The adhesive shall have excellent insulation characteristics.
  - h. The adhesive shall have no emission of toxic gasses and no effect on the human body.
- (2) The recommended amount of adhesives is as follows;

[Recommended condition]

Figure	212/316 case sizes as examples
a	0.3mm min
b	100 to 120 μm
c	Adhesives shall not contact land

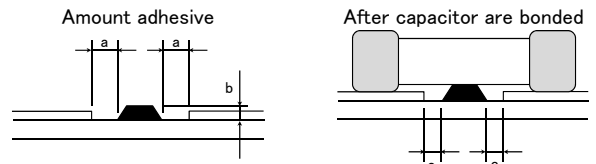

4. Soldering

◆ Selection of Flux

- Since flux may have a significant effect on the performance of capacitors, it is necessary to verify the following conditions prior to use;
- (1) Flux used shall be less than or equal to 0.1 wt% ( in Cl equivalent) of halogenated content. Flux having a strong acidity content shall not be applied.
  - (2) When shall capacitors are soldered on boards, the amount of flux applied shall be controlled at the optimum level.
  - (3) When water-soluble flux is used, special care shall be taken to properly clean the boards.

Precautions

◆ Soldering

Temperature, time, amount of solder, etc. shall be set in accordance with their recommended conditions.  
 Sn-Zn solder paste can adversely affect MLCC reliability.  
 Please contact us prior to usage of Sn-Zn solder.

Technical considerations

◆ Selection of Flux

- 1-1. When too much halogenated substance (Chlorine, etc.) content is used to activate flux, or highly acidic flux is used, it may lead to corrosion of terminal electrodes or degradation of insulation resistance on the surfaces of the capacitors.
- 1-2. Flux is used to increase solderability in wave soldering. However if too much flux is applied, a large amount of flux gas may be emitted and may adversely affect the solderability. To minimize the amount of flux applied, it is recommended to use a flux-bubbling system.
- 1-3. Since the residue of water-soluble flux is easily dissolved in moisture in the air, the residues on the surfaces of capacitors in high humidity conditions may cause a degradation of insulation resistance and reliability of the capacitors. Therefore, the cleaning methods and the capability of the machines used shall also be considered carefully when water-soluble flux is used.

► This catalog contains the typical specification only due to the limitation of space. When you consider the purchase of our products, please check our specification.  
 For details of each product (characteristics graph, reliability information, precautions for use, and so on), see our Web site (<http://www.ty-top.com/>).

◆Soldering

- Ceramic chip capacitors are susceptible to thermal shock when exposed to rapid or concentrated heating or rapid cooling.
- Therefore, the soldering must be conducted with great care so as to prevent malfunction of the components due to excessive thermal shock.
- Preheating : Capacitors shall be preheated sufficiently, and the temperature difference between the capacitors and solder shall be within 100 to 130°C.
- Cooling : The temperature difference between the capacitors and cleaning process shall not be greater than 100°C.

[Reflow soldering]

【Recommended conditions for eutectic soldering】

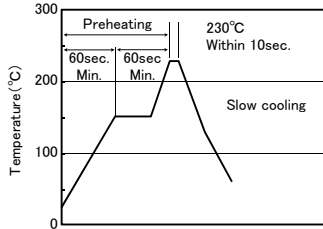

【Recommended condition for Pb-free soldering】

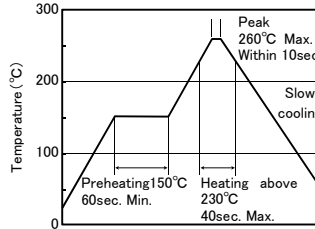

Caution

- ①The ideal condition is to have solder mass (fillet) controlled to 1/2 to 1/3 of the thickness of a capacitor.
- ②Because excessive dwell times can adversely affect solderability, soldering duration shall be kept as close to recommended times as possible.
- ③Allowable number of reflow soldering : 2 times max.

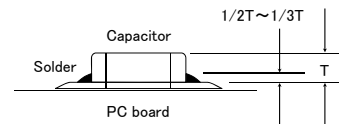

[Wave soldering]

【Recommended conditions for eutectic soldering】

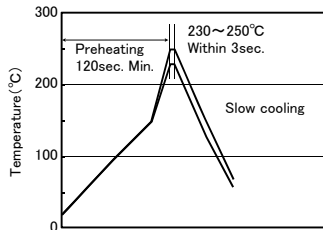

【Recommended condition for Pb-free soldering】

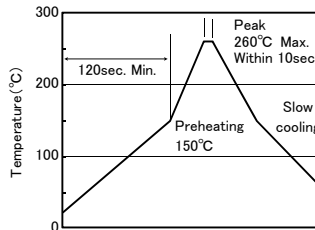

Caution

- ①Wave soldering must not be applied to capacitors designated as for reflow soldering only.
- ②Allowable number of wave soldering : 1 times max.

[Hand soldering]

【Recommended conditions for eutectic soldering】

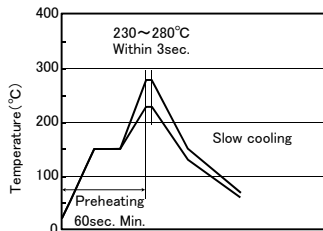

【Recommended condition for Pb-free soldering】

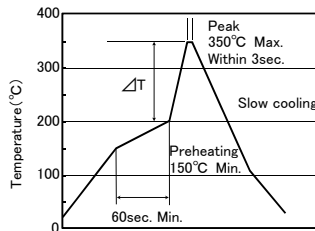

	$\Delta T$
316type or less	$\Delta T \leq 150^\circ\text{C}$

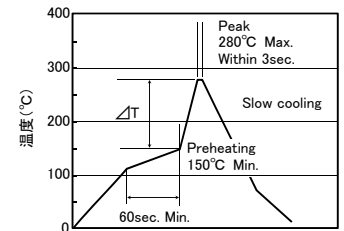

	$\Delta T$
325type or more	$\Delta T \leq 130^\circ\text{C}$

Caution

- ①Use a 50W soldering iron with a maximum tip diameter of 1.0 mm.
- ②The soldering iron shall not directly touch capacitors.
- ③Allowable number of hand soldering : 1 times max.

5. Cleaning	
Precautions	<p>◆Cleaning conditions</p> <ol style="list-style-type: none"> <li>When PCBs are cleaned after capacitors mounting, please select the appropriate cleaning solution in accordance with the intended use of the cleaning. (e.g. to remove soldering flux or other materials from the production process.)</li> <li>Cleaning condition shall be determined after it is verified by using actual cleaning machine that the cleaning process does not affect capacitor's characteristics.</li> </ol>
Technical considerations	<ol style="list-style-type: none"> <li>The use of inappropriate cleaning solutions can cause foreign substances such as flux residue to adhere to capacitors or deteriorate their outer coating, resulting in a degradation of the capacitor's electrical properties (especially insulation resistance).</li> <li>Inappropriate cleaning conditions ( insufficient or excessive cleaning ) may adversely affect the performance of the capacitors. In the case of ultrasonic cleaning, too much power output can cause excessive vibration of PCBs which may lead to the cracking of capacitors or the soldered portion, or decrease the terminal electrodes' strength. Therefore, the following conditions shall be carefully checked:            Ultrasonic output : 20 W/l or less            Ultrasonic frequency : 40 kHz or less            Ultrasonic washing period : 5 min. or less</li> </ol>

6. Resin coating and mold	
Precautions	<ol style="list-style-type: none"> <li>With some type of resins, decomposition gas or chemical reaction vapor may remain inside the resin during the hardening period or while left under normal storage conditions resulting in the deterioration of the capacitor's performance.</li> <li>When a resin's hardening temperature is higher than capacitor's operating temperature, the stresses generated by the excessive heat may lead to damage or destruction of capacitors. The use of such resins, molding materials etc. is not recommended.</li> </ol>

7. Handling	
Precautions	<p>◆Splitting of PCB</p> <ol style="list-style-type: none"> <li>When PCBs are split after components mounting, care shall be taken so as not to give any stresses of deflection or twisting to the board.</li> <li>Board separation shall not be done manually, but by using the appropriate devices.</li> </ol> <p>◆Mechanical considerations</p> <p>Be careful not to subject capacitors to excessive mechanical shocks.</p> <p>(1) If ceramic capacitors are dropped onto a floor or a hard surface, they shall not be used.</p> <p>(2) Please be careful that the mounted components do not come in contact with or bump against other boards or components.</p>

8. Storage conditions	
Precautions	<p>◆Storage</p> <ol style="list-style-type: none"> <li>To maintain the solderability of terminal electrodes and to keep packaging materials in good condition, care must be taken to control temperature and humidity in the storage area. Humidity should especially be kept as low as possible.           <ul style="list-style-type: none"> <li>Recommended conditions               <ul style="list-style-type: none"> <li>Ambient temperature : Below 30°C</li> <li>Humidity : Below 70% RH</li> </ul> </li> </ul>           The ambient temperature must be kept below 40°C. Even under ideal storage conditions, solderability of capacitor is deteriorated as time passes, so capacitors shall be used within 6 months from the time of delivery.           <ul style="list-style-type: none"> <li>Ceramic chip capacitors shall be kept where no chlorine or sulfur exists in the air.</li> </ul> </li> <li>The capacitance values of high dielectric constant capacitors will gradually decrease with the passage of time, so care shall be taken to design circuits. Even if capacitance value decreases as time passes, it will get back to the initial value by a heat treatment at 150°C for 1hour.</li> </ol>
Technical considerations	<p>If capacitors are stored in a high temperature and humidity environment, it might rapidly cause poor solderability due to terminal oxidation and quality loss of taping/packaging materials. For this reason, capacitors shall be used within 6 months from the time of delivery. If exceeding the above period, please check solderability before using the capacitors.</p>

※RCR-2335B (Safety Application Guide for fixed ceramic capacitors for use in electronic equipment) is published by JEITA.  
Please check the guide regarding precautions for deflection test, soldering by spot heat, and so on.

Компания «Океан Электроники» предлагает заключение долгосрочных отношений при поставках импортных электронных компонентов на взаимовыгодных условиях!

Наши преимущества:

- Поставка оригинальных импортных электронных компонентов напрямую с производств Америки, Европы и Азии, а так же с крупнейших складов мира;
- Широкая линейка поставок активных и пассивных импортных электронных компонентов (более 30 млн. наименований);
- Поставка сложных, дефицитных, либо снятых с производства позиций;
- Оперативные сроки поставки под заказ (от 5 рабочих дней);
- Экспресс доставка в любую точку России;
- Помощь Конструкторского Отдела и консультации квалифицированных инженеров;
- Техническая поддержка проекта, помощь в подборе аналогов, поставка прототипов;
- Поставка электронных компонентов под контролем ВП;
- Система менеджмента качества сертифицирована по Международному стандарту ISO 9001;
- При необходимости вся продукция военного и аэрокосмического назначения проходит испытания и сертификацию в лаборатории (по согласованию с заказчиком);
- Поставка специализированных компонентов военного и аэрокосмического уровня качества (Xilinx, Altera, Analog Devices, Intersil, Interpoint, Microsemi, Actel, Aeroflex, Peregrine, VPT, Syfer, Eurofarad, Texas Instruments, MS Kennedy, Miteq, Cobham, E2V, MA-COM, Hittite, Mini-Circuits, General Dynamics и др.);

Компания «Океан Электроники» является официальным дистрибьютором и эксклюзивным представителем в России одного из крупнейших производителей разъемов военного и аэрокосмического назначения «**JONHON**», а так же официальным дистрибьютором и эксклюзивным представителем в России производителя высокотехнологичных и надежных решений для передачи СВЧ сигналов «**FORSTAR**».



## JONHON

«**JONHON**» (основан в 1970 г.)

Разъемы специального, военного и аэрокосмического назначения:

(Применяются в военной, авиационной, аэрокосмической, морской, железнодорожной, горно- и нефтедобывающей отраслях промышленности)

«**FORSTAR**» (основан в 1998 г.)

ВЧ соединители, коаксиальные кабели,  
кабельные сборки и микроволновые компоненты:

(Применяются в телекоммуникациях гражданского и специального назначения, в средствах связи, РЛС, а так же военной, авиационной и аэрокосмической отраслях промышленности).



Телефон: 8 (812) 309-75-97 (многоканальный)

Факс: 8 (812) 320-03-32

Электронная почта: [ocean@oceanchips.ru](mailto:ocean@oceanchips.ru)

Web: <http://oceanchips.ru/>

Адрес: 198099, г. Санкт-Петербург, ул. Калинина, д. 2, корп. 4, лит. А