



TFT LCD Module

Product Specification

DT070BTFT-PTS1
7.0" (1024(RGB) x 600 DOTS) TFT Module
with PCAP

May 23, 2016

Remark:

Contents in this document are subject to change without notice. No part of this document may be reproduced or transmitted in any form or by any means, electronic or mechanical, for any purpose, without the express written permission of Displaytech Ltd.

Displaytech Ltd.

Tel: (852) 2311 2080 ; Fax: (852) 2722 6998 ; Email: sales@displaytech.com.hk

Address: 31E Billion Plaza 2, No. 10 Cheung Yue Street, Cheung Sha Wan, Kowloon,
Hong Kong.

Website: <http://www.displaytech.com.hk>

Revision Record

REV	CHANGES	DATE
0.0 (Ref. 1.0 20150614)	First release	Aug 13, 2015
1.0 (Ref. 1.0 20160218)	<ul style="list-style-type: none"> - In 3. General Information, changed the outline dimension from "166.80 x 102.05 x 4.75" to "164.90 x 100.00 x 4.50", and added "Driver IC of PCAP: FT5426"; - Updated 4. Outline Drawing with the new PCAP; - Updated PCAP signal interface in 5. Interface Signals; - Changed the Luminance from "180 Min." to "170 Min." in 9. Optical Specification; 	Mar 16, 2016
2.0 (Ref. 1.1 20160512)	<ul style="list-style-type: none"> - Increased depth from "4.50" to "4.55" in section 3. General Information; - Changed controller/driver from "EK79001DCGB/EK73217ACGA" to "EK79001ECGA/EK73215BCGA" in section 3. General Information; - Updated drawing in section 4. Outline Drawing; - Added "Recommend connector Part No.: FH12S-40S-0.5SH" in section 5. Interface Signals. 	May 23, 2016

Table of Content

Revision Record	1
1. Scope.....	3
2. Application	3
3. General Information	3
4. Outline Drawing	4
5. Interface Signals	5
6. Absolute Maximum Ratings	6
6.1 Electrical absolute maximum ratings.....	6
6.2 Environment conditions	6
7. Electrical Specifications	7
7.1 Electrical characteristics	7
7.2 LED backlight.....	7
8. Command / AC Timing.....	8
8.1 Timing Characteristics of Input Signals	8
8.2 Timing Sequence (Timing Chart).....	8
8.3 Power ON/Off Sequence	10
9. Optical Specification.....	11
10. Environmental / Reliability Tests	13
11. Precautions for Use of LCD Modules	14
11.1 Safety	14
11.2 Handling	14
11.3 Static electricity	14
11.4 Storage	14
11.5 Cleaning.....	14
11.6 Cautions for installing and assembling	14

1. Scope

This data sheet is to introduce the specification of DT070BTFT-PTS1, active matrix TFT module. It is composed of a color TFT-LCD panel, driver ICs, FPC, capacitive touch panel and a backlight unit. The 7.0" display area contains 1024x3 (RGB) x 600 pixels.

As to basic specification of the driver IC, refer to the IC specification and datasheet.

2. Application

Digital equipment which need color display, mobile navigator/video systems.

3. General Information

Item	Contents	Unit
Size	7.0	inch
Resolution	1024x3(RGB) x 600	/
Interface	LVDS	/
Technology Type	IPS TFT	/
Pixel Configuration	R.G.B. Stripe	
Outline Dimension (W x H x D)	164.90 x 100.00 x 4.55	mm
Active Area	154.21 x 85.92	mm
Backlight Type	LED	/
Controller/ driver	EK79001ECGA/EK73215BCGA	
Driver IC of PCAP	FT5426	
Weight	TBD	g

4. Outline Drawing

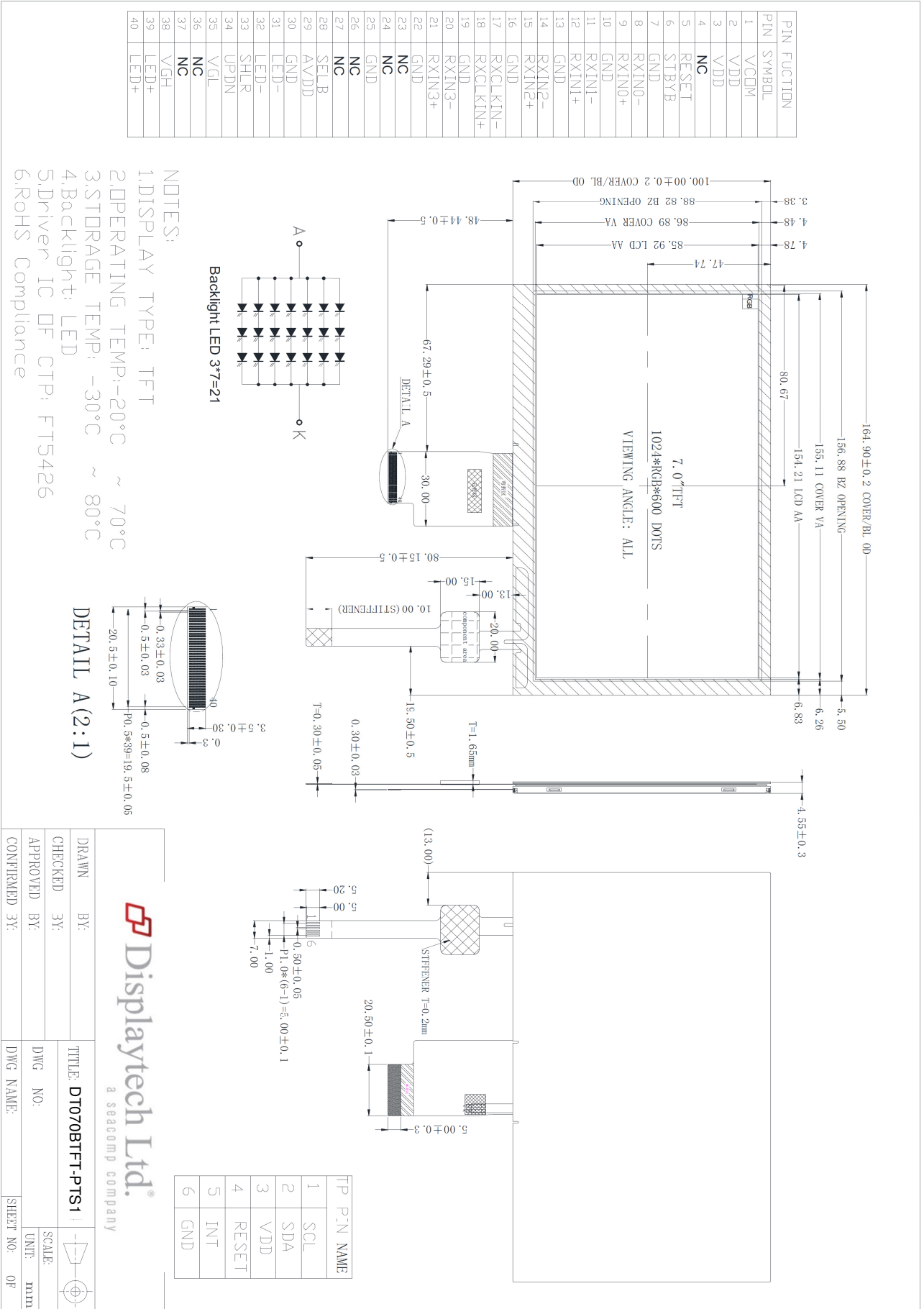

5. Interface Signals

Recommend connector Part No.: FH12S-40S-0.5SH

No	Symbol	Description	Remark
1	VCOM	Common voltage	
2	VDD	Power supply	
3	VDD	Power supply	
4	NC	No connection	
5	RESET	Global reset pin	
6	STBYB	Standby mode	
7	GND	Power Ground	
8	RXIN0-	Differential Data Input, CH0 (Negative)	
9	RXIN0+	Differential Data Input, CH0 (Positive)	
10	GND	Power Ground	
11	RXIN1-	Differential Data Input, CH1 (Negative)	
12	RXIN1+	Differential Data Input, CH1 (Positive)	
13	GND	Power Ground	
14	RXIN2-	Differential Data Input, CH2 (Negative)	
15	RXIN2+	Differential Data Input, CH2 (Positive)	
16	GND	Power Ground	
17	RXCLKIN-	Differential Clock Input (Negative)	
18	RXCLKIN+	Differential Clock Input (Positive)	
19	GND	Power Ground	
20	RXIN3-	Differential Data Input, CH3 (Negative)	
21	RXIN3+	Differential Data Input, CH3 (Positive)	
22	GND	Power Ground	
23	NC	No connection	
24	NC	No connection	
25	GND	Power Ground	
26	NC	No connection	
27	NC	No connection	
28	SELB	In LVDS interface connected HSD to FPC for Pin Setting HSD="L":8 bit ; HSD="H":6 bit	
29	AVDD	Power supply for analog circuits	
30	GND	Power Ground	
31	LED-	Power for LED backlight (Cathode)	
32	LED-	Power for LED backlight (Cathode)	
33	SHLR	Source Right or Left sequence control. Normally pull high.	Note
34	UPDN	Gate Up or Down scan control. Normally pull low	Note
35	VGL	Gate OFF Voltage	
36	NC	No connection	
37	NC	No connection	
38	VGH	Gate ON Voltage	
39	LED+	Power for LED backlight (Anode)	
40	LED+	Power for LED backlight (Anode)	

Note:

UPDN	SHLR	Function
0	1	Normal Display
0	0	Inverse Left and Right
1	1	Inverse Up and Down
1	0	Inverse Left and Right Inverse Up and Down

PCAP signal interface:

Pin	Symbol	Description
1	SCL	I2C clock signal
2	SDA	I2C data signal
3	VDD	Power supply
4	RESET	Reset Pin
5	INT	Interrupt output Pin
6	GND	Power ground

6. Absolute Maximum Ratings

6.1 Electrical absolute maximum ratings

Parameter	Symbol	MIN	MAX	Unit	Remark
Power Supply Voltage	VDD	-0.3	5.0	V	
	AVDD	-0.5	15.0	V	
	VGH	-0.3	40.0	V	
	VGL	-20	0.3	V	
Logic Signal Input / Output Voltage	V _{IOVCC}	-0.3	VDD+0.5	V	
Current of LED	I _{LED}	0	175	mA	

Notes:

1. If the module is above these absolute maximum ratings. It may become permanently damaged. Using the module within the following electrical characteristic conditions are also exceeded, the module will malfunction and cause poor reliability.
2. Please be sure users are grounded when handing LCD Module.

6.2 Environment conditions

Parameter	Symbol	MIN	MAX	Unit	Remark
Operating Temperature	TOPR	-20	+70	°C	
Storage Temperature	TSTG	-30	+80	°C	

Notes:

1. The response time will become lower when operated at low temperature.
2. Background color changes slightly depending on ambient temperature.
The phenomenon is reversible.
3. Ta≤40°C :85%RH MAX.
Ta>=40°C :Absolute humidity must be lower than the humidity of 85%RH at 40°C .

7. Electrical Specifications

7.1 Electrical characteristics

GND=0V, Ta=25°C

Item	Symbol	MIN	TYP	MAX	Unit	Remark
Power Supply	VDD	2.6	3.3	3.6	V	
	VCOM	2.85		3.45	V	
	AVDD	9.4	9.6	9.8	V	
	VGH	17	18	19	V	
	VGL	-6.6	-6.0	-5.4	V	
Input Voltage	H	V _{IH}	0.8VDD	---	VDD	VDD=2.8V
	L	V _{IL}	0	---	0.2VDD	
Current Consumption		I _{VDD}	---	30	45	mA
		I _{AVDD}	---	35	45	mA

7.2 LED backlight

Ta=25°C

Item	Symbol	MIN	TYP	MAX	Unit	Remark
Forward current	I _L	---	140	---	mA	
Forward voltage	V _L	---	9.6	---	V	Note 1
LED life time	---	---	25,000	---	Hr	Note 2

Note 1: The LED Supply Voltage is defined by the number of LED at Ta=25°C and I_L=140mA.

Note 2: The "LED life time" is defined as the module brightness decrease to 50% original brightness at Ta=25°C and I_L=140mA. The LED lifetime could be decreased if operation I_L is larger than 140mA.

Note 3: LED power consumption is around 0.297W.

8. Command / AC Timing

8.1 Timing Characteristics of Input Signals

ITEM			SYMBOL	MIN	TYP	MAX	UNIT
LVDS Input Signal Sequence	CLK Frequency		tclk	45	51.2	57	MHz
LCD Input Signal Sequence (Input LVDS Transmitter)	Horizontal	Horizontal Total Time	t_H	1324	1344	1364	tCLK
		Horizontal Effective Time	t_{HA}	1024			tCLK
		Horizontal Blank Time	t_{HB}	300	320	340	tCLK
	Vertical	Vertical Total Time	t_V	625	635	645	t_H
		Vertical Effective Time	t_{VA}	600			t_H
		Vertical Blank Time	t_{VB}	25	35	45	t_H

8.2 Timing Sequence (Timing Chart)

8.2.1. Horizontal Timing Sequence

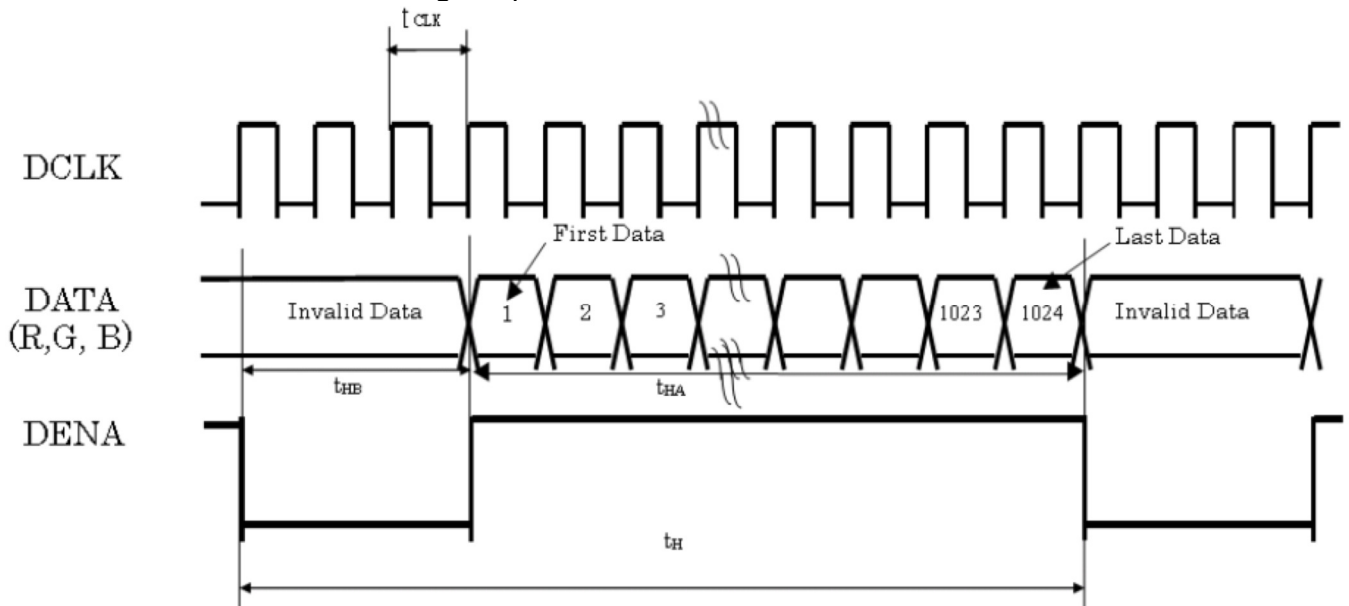

8.2.2 Vertical Timing Sequence

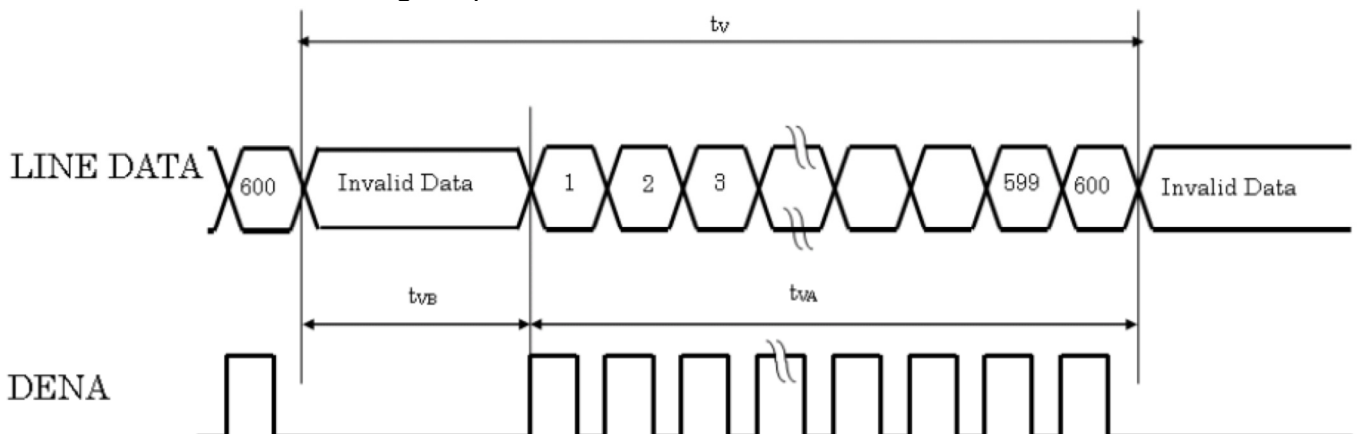

8.2.3 LVDS Input Data Mapping
6bits LVDS Input

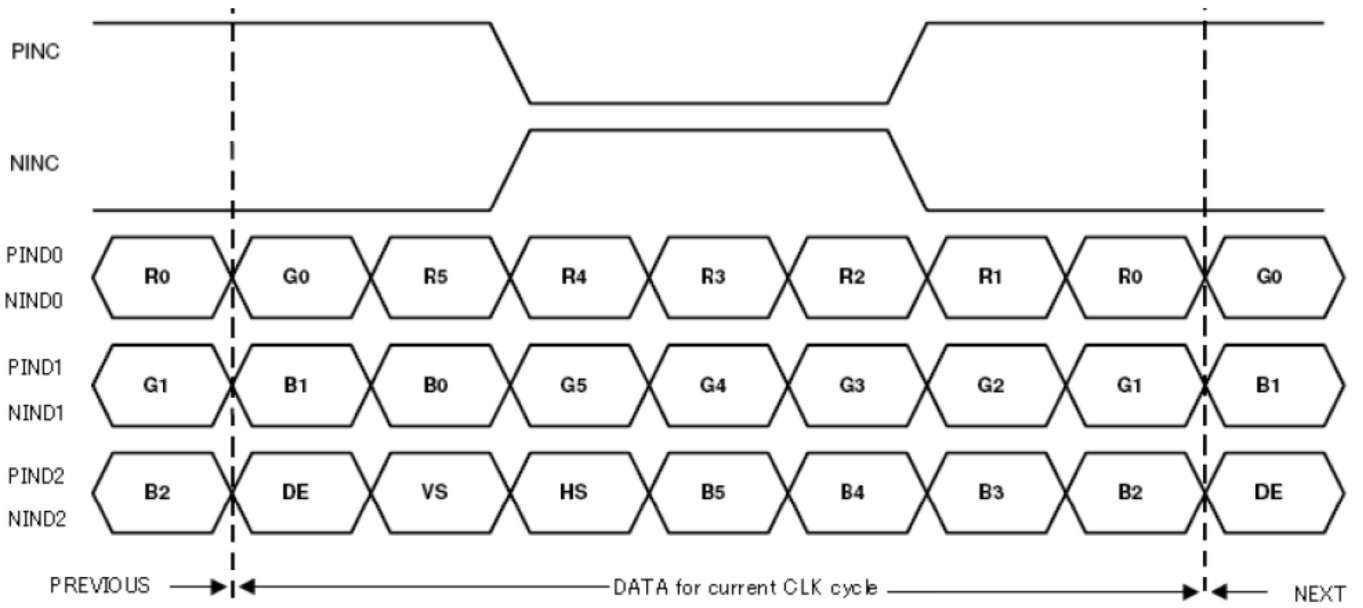

8bits LVDS Input

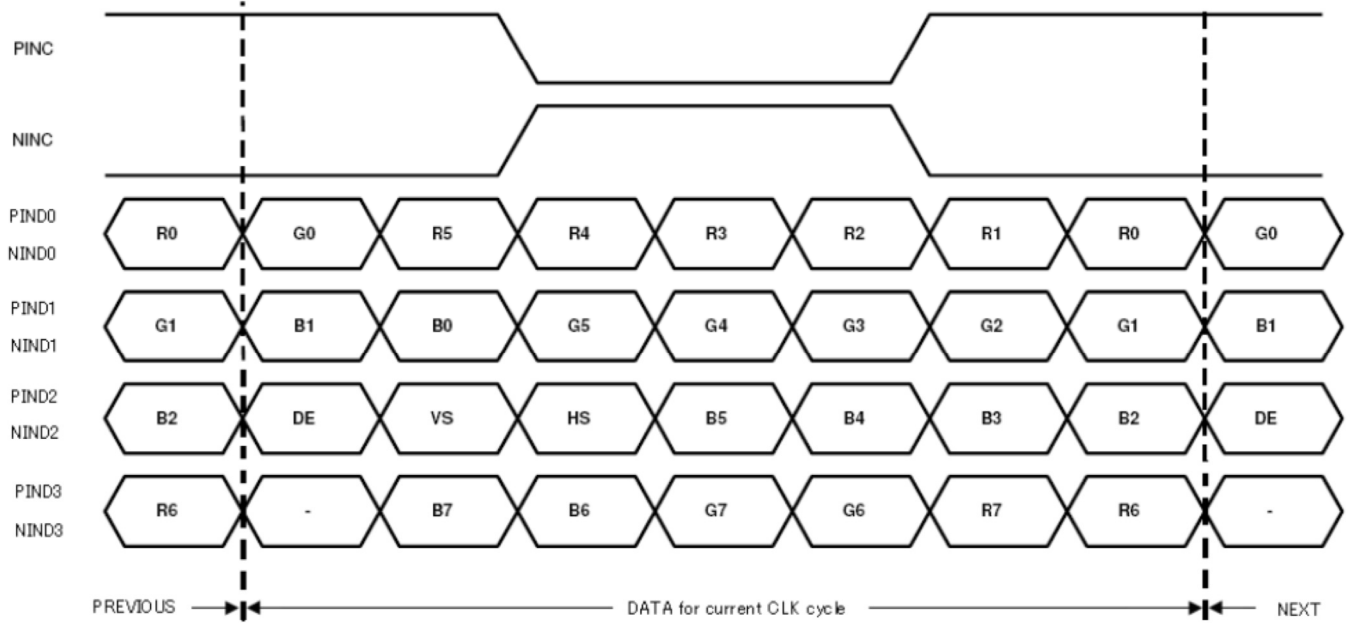

8.3 Power ON/Off Sequence

Power On : DVDD→AVDD/VGL →VGH →Video & Logic Signal→Backlight

Power Off : Backlight→Video & Logic Signal→ VGH→AVDD/VGL→DVDD

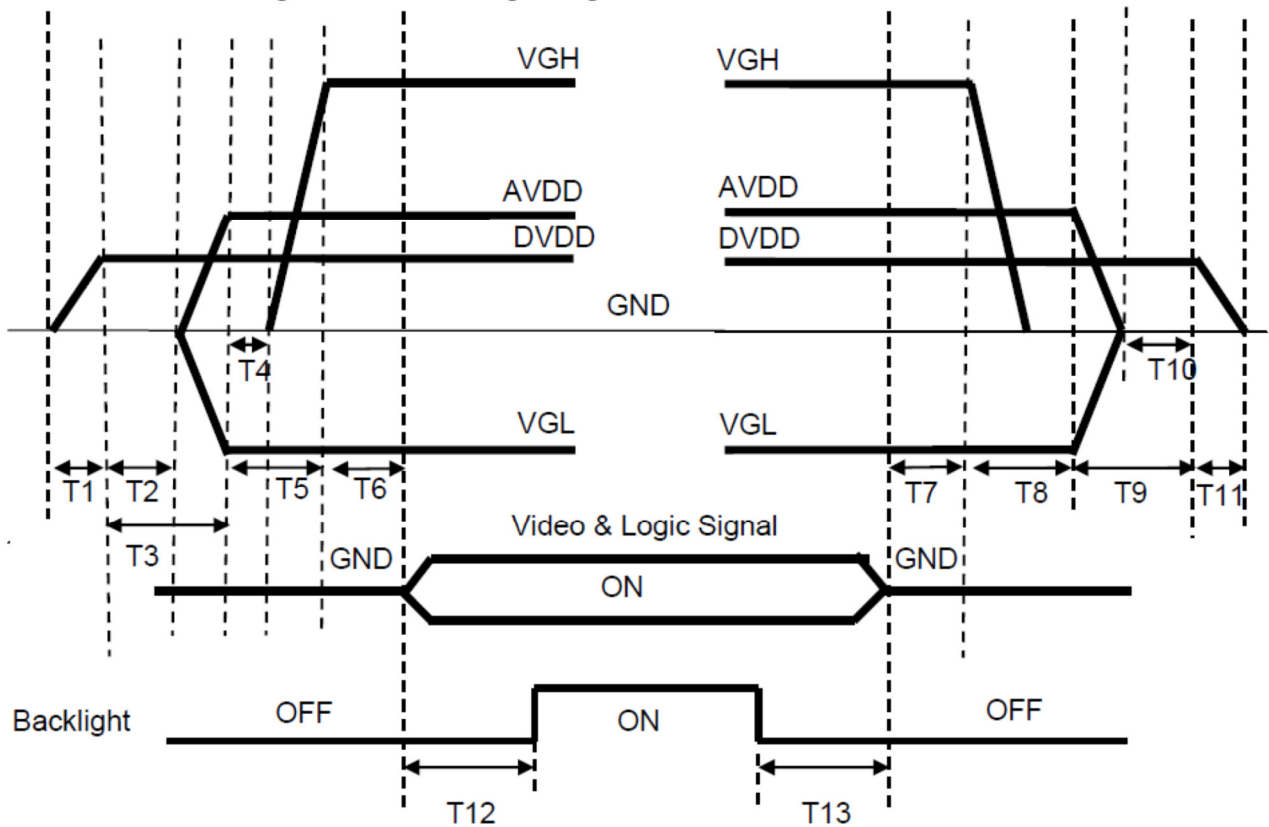

$0 < T1 \leq 10\text{ms}$
 $T2 > 0\text{ms}$
 $T3 > 20\text{ms}$
 $T4 > 0\text{ms}$
 $T5 > 10\text{ms}$
 $0 < T6 \leq 10\text{ms}$
 $T12 \geq 200\text{ms}$

$T7 > 0\text{ms}$
 $T8 > 0\text{ms}$
 $T9 > 0\text{ms}$
 $T10 > 0\text{ms}$
 $0 < T11 \leq 10\text{ms}$
 $T13 \geq 200\text{ms}$

9. Optical Specification

Ta=25°C

Item	Symbol	Condition	MIN	TYP	MAX	Unit	Remark	
Contrast ratio	CR	$\theta=0^\circ$	---	800	---		Note 1, 2	
Response time	Tr+Tf	25°C	---	25	---	ms	Note 1, 3	
View angles	ΘT	$CR \geq 10$	80	85	---	Degree	Note 4	
	ΘB		80	85	---			
	ΘL		80	85	---			
	ΘR		80	85	---			
Chromaticity	White	Brightness is on	Typ - 0.03	0.290	Typ + 0.03		Note 1, 5	
				y				0.331
	Red			x				0.632
				y				0.311
	Green			x				0.297
				y				0.536
	Blue			x				0.140
				y				0.154
Luminance	L		170	210	---	cd/m ²	Note 1, 6	
Uniformity	U		80	90	---	%	Note 1, 7	

Note 1: Definition of optical measurement system.

Temperature = 25°C(±3°C)

LED back-light: ON, Environment brightness < 150 lx

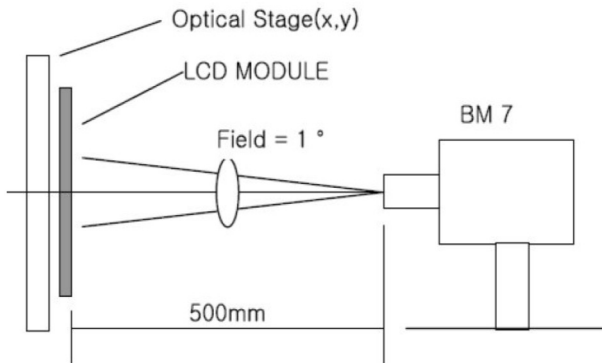

Note 2: Contrast ratio is defined as follow:

$$\text{Contrast Ratio} = \frac{\text{Surface Luminance with all white pixels}}{\text{Surface Luminance with all black pixels}}$$

Note 3: Response time is defined as follow:

Response time is the time required for the display to transition from black to white (Rise time, Tr) and from white to black (Decay Time, Tf).

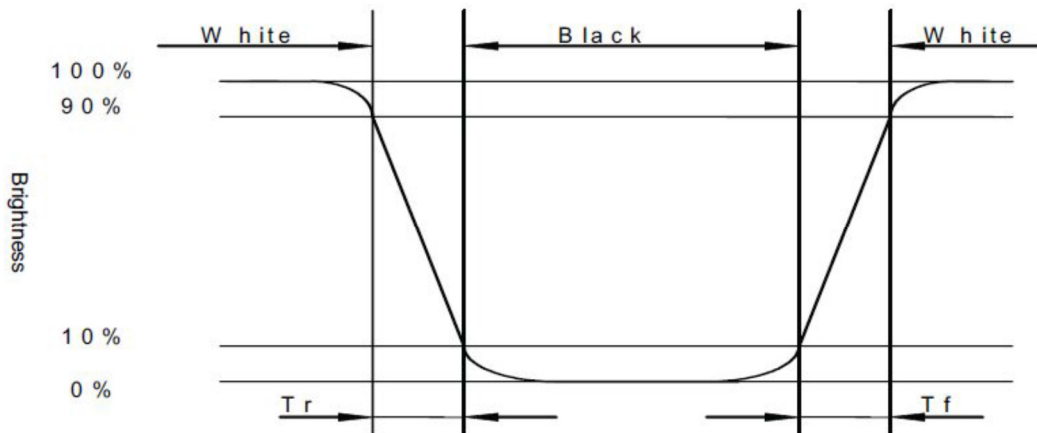

Note 4: Viewing angle range is defined as follow:

Viewing angle is measured at the center point of the LCD.

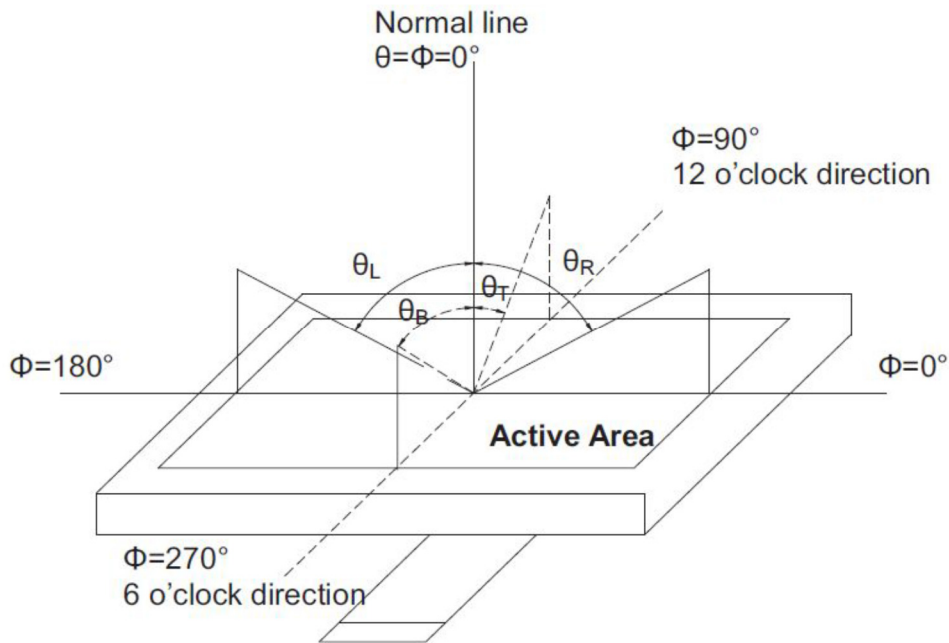

Note 5: Color chromaticity is defined as follow (CIE1931)

Color coordinates measured at center point of LCD.

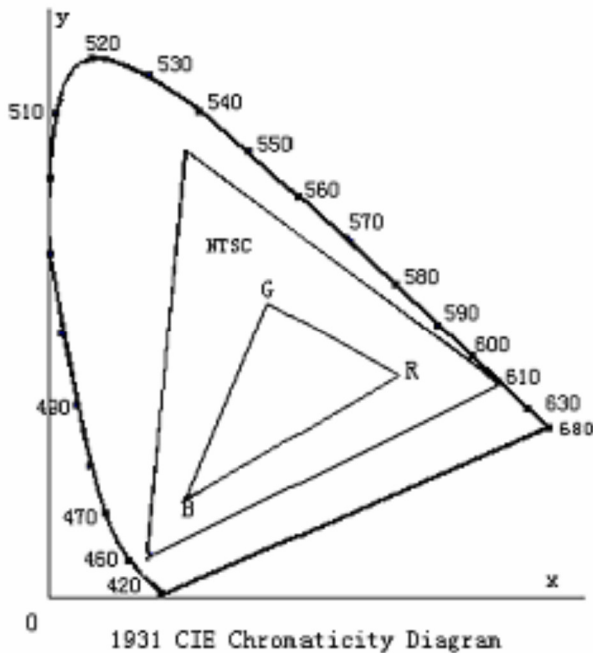

$$S = \frac{\text{area of RGB triangle}}{\text{area of NTSC triangle}} \times 100\%$$

Note 6: Luminance is defined as follow:

Luminance is defined as the brightness of all pixels “White” at the center of display area on optimum contrast.

Note 7: Luminance Uniformity is defined as follow:

Active area is divided into 9 measuring areas (Refer Fig.2). Every measuring point is placed at the center of each measuring area.

$$\text{Uniformity (U)} = \frac{\text{Minimum Luminance(brightness) in 9 points}}{\text{Maximum Luminance(brightness) in 9 points}}$$

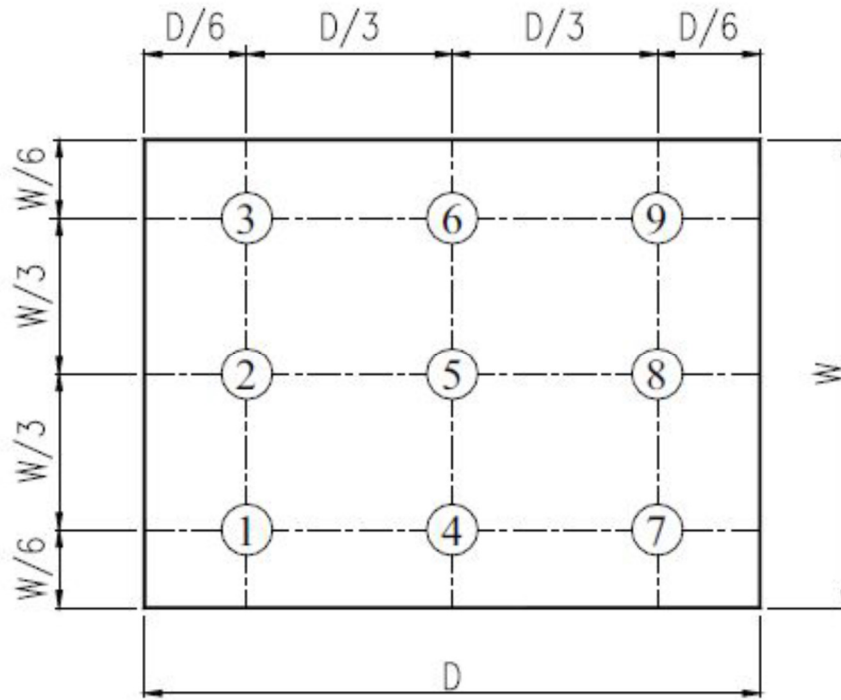

Fig. 2 Definition of uniformity

10. Environmental / Reliability Tests

No	Test Item	Condition	Judgment Criteria
1	High Temp Operation	Ta=+70°C, 96hrs	Per table below
2	Low Temp Operation	Ta=-20°C, 96hrs	Per table below
3	High Temp Storage	Ta=+80°C, 96hrs	Per table below
4	Low Temp Storage	Ta=-30°C, 96hrs	Per table below
5	High Temp & High Humidity Storage	Ta=+60°C, 90% RH, 96hrs	Per table below (polarizer discoloration is excluded)
6	Thermal Shock (Non-operation)	-30°C 30 min ~ +80°C 30 min, Change time: 5 min, 5 cycles	Per table below
7	ESD (Operation)	Air discharge: ±8KV, Contact discharge: ±4KV	Per table below
8	Vibration (Non-operation)	10Hz~150Hz, 100m/s ² , 120min	Per table below
9	Shock (Non-operation)	Half- sine wave, 300m/s ² , 11ms	Per table below
10	Package Drop Test	Height: 80cm, 1 corner, 3 edges, 6 surfaces	Per table below

Inspection	Criterion (after test)
Appearance	No crack on the FPC, on the LCD panel
Alignment of LCD panel	No bubbles in the LCD panel No other defects of alignment in active area
Electrical current	Within device specifications
Function / Display	No broken circuit, no short circuit or no black line No other defects of display

11. Precautions for Use of LCD Modules

11.1 Safety

The liquid crystal in the LCD is poisonous. Do not put it in your mouth. If the liquid crystal touches your skin or clothes, wash it off immediately using soap and water.

11.2 Handling

- The LCD and touch panel is made of plate glass. Do not subject the panel to mechanical shock or to excessive force on its surface.
- Do not handle the product by holding the flexible pattern portion in order to assure the reliability.
- Transparency is an important factor for the touch panel. Please wear clear finger sacks, gloves and mask to protect the touch panel from finger print or stain and also hold the portion outside the view area when handling the touch panel.
- Provide a space so that the panel does not come into contact with other components.
- To protect the product from external force, put a covering lens (acrylic board or similar board) and keep an appropriate gap between them.
- Transparent electrodes may be disconnected if the panel is used under environmental conditions where dew condensation occurs.
- Property of semiconductor devices may be affected when they are exposed to light, possibly resulting in IC malfunctions.
- To prevent such IC malfunctions, your design and mounting layout shall be done in the way that the IC is not exposed to light in actual use.

11.3 Static electricity

- Ground soldering iron tips, tools and testers when they are in operation.
- Ground your body when handling the products.
- Power on the LCD module before applying the voltage to the input terminals.
- Do not apply voltage which exceeds the absolute maximum rating.
- Store the products in an anti-electrostatic bag or container.

11.4 Storage

- Store the products in a dark place at $+25^{\circ}\text{C}\pm 10^{\circ}\text{C}$ with low humidity (40% RH to 60% RH). Don't expose to sunlight or fluorescent light.
- Storage in a clean environment, free from dust, active gas, and solvent.

11.5 Cleaning

- Do not wipe the touch panel with dry cloth, as it may cause scratch.
- Wipe off the stain on the product by using soft cloth moistened with ethanol. Do not allow ethanol to get in between the upper film and the bottom glass. It may cause peeling issue or defective operation. Do not use any organic solvent or detergent other than ethanol.

11.6 Cautions for installing and assembling

Bezel edge must be positioned in the area between the Active area and View area. The bezel may press the touch screen and cause activation if the edge touches the active area. A gap of approximately 0.5mm is needed between the bezel and the top electrode. It may cause unexpected activation if the gap is too narrow. There is a tolerance of 0.2 to 0.3mm for the outside dimensions of the touch panel and tail. A gap must be made to absorb the tolerance in the case and connector.

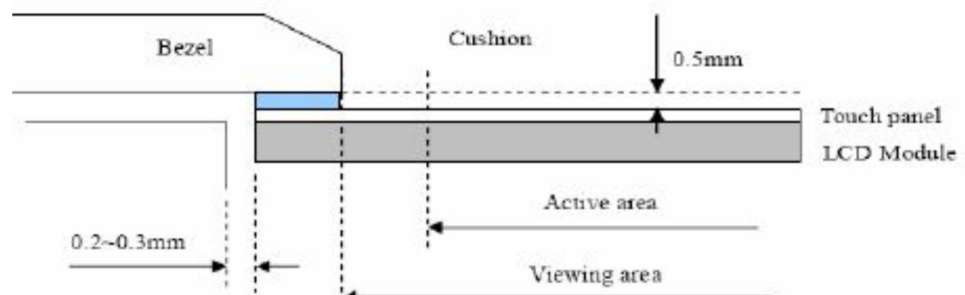

Компания «Океан Электроники» предлагает заключение долгосрочных отношений при поставках импортных электронных компонентов на взаимовыгодных условиях!

Наши преимущества:

- Поставка оригинальных импортных электронных компонентов напрямую с производств Америки, Европы и Азии, а так же с крупнейших складов мира;
- Широкая линейка поставок активных и пассивных импортных электронных компонентов (более 30 млн. наименований);
- Поставка сложных, дефицитных, либо снятых с производства позиций;
- Оперативные сроки поставки под заказ (от 5 рабочих дней);
- Экспресс доставка в любую точку России;
- Помощь Конструкторского Отдела и консультации квалифицированных инженеров;
- Техническая поддержка проекта, помощь в подборе аналогов, поставка прототипов;
- Поставка электронных компонентов под контролем ВП;
- Система менеджмента качества сертифицирована по Международному стандарту ISO 9001;
- При необходимости вся продукция военного и аэрокосмического назначения проходит испытания и сертификацию в лаборатории (по согласованию с заказчиком);
- Поставка специализированных компонентов военного и аэрокосмического уровня качества (Xilinx, Altera, Analog Devices, Intersil, Interpoint, Microsemi, Actel, Aeroflex, Peregrine, VPT, Syfer, Eurofarad, Texas Instruments, MS Kennedy, Miteq, Cobham, E2V, MA-COM, Hittite, Mini-Circuits, General Dynamics и др.);

Компания «Океан Электроники» является официальным дистрибьютором и эксклюзивным представителем в России одного из крупнейших производителей разъемов военного и аэрокосмического назначения «JONHON», а так же официальным дистрибьютором и эксклюзивным представителем в России производителя высокотехнологичных и надежных решений для передачи СВЧ сигналов «FORSTAR».



JONHON

«JONHON» (основан в 1970 г.)

Разъемы специального, военного и аэрокосмического назначения:

(Применяются в военной, авиационной, аэрокосмической, морской, железнодорожной, горно- и нефтедобывающей отраслях промышленности)

«FORSTAR» (основан в 1998 г.)

ВЧ соединители, коаксиальные кабели,
кабельные сборки и микроволновые компоненты:

(Применяются в телекоммуникациях гражданского и специального назначения, в средствах связи, РЛС, а так же военной, авиационной и аэрокосмической отраслях промышленности).



Телефон: 8 (812) 309-75-97 (многоканальный)

Факс: 8 (812) 320-03-32

Электронная почта: ocean@oceanchips.ru

Web: <http://oceanchips.ru/>

Адрес: 198099, г. Санкт-Петербург, ул. Калинина, д. 2, корп. 4, лит. А