

# MAX96705/MAX96711 Evaluation Kit

# Evaluates: MAX96705/MAX96711 with Coax or STP Cable

## General Description

The MAX96705/MAX96711 coax evaluation kit (EV kit) provides a proven design to evaluate the MAX96705 and MAX96711 high-bandwidth gigabit multimedia serial link (GMSL) serializers with spread spectrum and full-duplex control channel, through the use of a standard FAKRA coax or STP cable. The EV kit also includes Windows Vista®- and Windows 7-compatible software that provides a simple graphical user interface (GUI) for exercising features of the device. The EV kit comes with either a MAX96705GTJ+ or MAX96711GTJ+ IC installed.

For complete GMSL evaluation using a standard FAKRA coax cable, order the MAX96705 or MAX96711 EV kit and a companion deserializer board (the MAX96706 or MAX96708 EV kit are referenced in this document). For testing with STP cable, also order the MAXCOAX2STP-HSD adapter kit and refer to its data sheet. Only one adapter kit is required per link (connecting the serializer and deserializer boards).

**Note:** In the following sections, MAX96705/11 and the term “serializer” refer to the MAX96705 or MAX96711 ICs and MAX96706/08 and the term “deserializer” refer to the MAX96706 or MAX96708 ICs.

**Note:** This document applies to both coax and STP EV kits. This document covers coax cables, but the information provided applies equally to STP cables.

**Ordering Information** appears at end of data sheet.

## Features

- Accepts 16-Bit Parallel Input Data and Outputs GMSL Serial Data through FAKRA Connectors
- Windows Vista-, and Windows 7-Compatible Software
- USB-Controlled Interface (Cable Included)
- USB Powered
- Proven PCB Layout
- Fully Assembled and Tested

## Items Included in the EV Kit Package

DESCRIPTION	QTY
MAX96705 or MAX96711 coax EV kit board	1
USB cable	1

## MAX96705/MAX96711 EV Kit Files

FILE	DESCRIPTION
MAXSerDesEV-N_Vxxxx_Install.EXE	Installs the EV kit files on your computer
MAXSerDesEV-N.EXE	Graphical user interface (GUI) program
CDM20600.EXE	Installs the USB device driver
USB_Driver_Help_200.PDF	USB driver installation help file

*Windows and Windows Vista are registered trademarks and registered service marks of Microsoft Corporation.*



# MAX96705/MAX96711 Evaluation Kit

# Evaluates: MAX96705/MAX96711 with Coax or STP Cable

## Quick Start

### Required Equipment

- MAX96705 or MAX96711 serializer EV kit
- MAX96706 or MAX96708 deserializer EV kit
- 2m FAKRA cable assembly (included with the deserializer EV kit)
- > 20MHz function generator
- PC with Windows Vista or Windows 7 and a spare USB port (direct 500mA connection required; do not use a bus-powered hub)
- 5V DC, 500mA power supply

**Note:** In the following sections, software-related items are identified by bolding. Text in **bold** refers to items from the EV kit software. Text in **bold and underlined** refers to items from the Windows operating system.

### Procedure

The EV kit is fully assembled and tested. Follow the steps below to verify board operation:

- 1) Visit [www.maximintegrated.com/EVkitsoftware](http://www.maximintegrated.com/EVkitsoftware) to download and install the latest version of the EV kit software:
  - Search for MAX9288. Then select **MAX9288 | Design Resources | Software | GMSL SerDes Evaluation Kit Software-Nuvoton**.
  - The installation application will try to download and install the USB driver for the Nuvoton microcontroller. If the USB driver installation was not successful, install the appropriate USB driver for your PC available from the link below, and refer to the USB\_Driver\_Help\_200.PDF file, if needed: [www.ftdichip.com/Drivers/VCP.htm](http://www.ftdichip.com/Drivers/VCP.htm).
- 2) Verify that jumpers on the serializer board are in their default positions, as shown in [Figure 14](#).
- 3) Verify that jumpers on the deserializer board are in their default positions, as shown in [Figure 15](#).
- 4) Set up the system, as shown in [Figure 1](#).
- 5) Connect the FAKRA cable from the OUT+ terminal on the serializer board to the IN0+ terminal on the deserializer board. Both the serializer and deserializer evaluation boards have power-over-coax (POC) circuitry that is active by default, configured such that the deserializer board is the source of the power for the serializer board.
- 6) Connect the USB cable between the PC and USB port on the Nuvoton microcontroller daughter board on the serializer board.
- 7) Verify that LED\_PWR on the deserializer board lights up, indicating that the deserializer board has power.
- 8) Verify that LED\_PWR on the serializer board lights up, indicating that the serializer board has power. Both serializer and deserializer have a power-over-coax (POC) circuit that is active by default.
- 9) Verify that LOCK\_LED on the deserializer board lights up, indicating that the link has been successfully established. If the LOCK\_LED is off, or ERR\_LED is on, go to the [Troubleshooting](#) section and fix the problem before continuing. **Note:** If you are working with an earlier version of the deserializer IC, you must write value of 0xA6 to register address 0x9b at slave address 0x90 to enable the control channel. In the current revision of the IC, this step is no longer needed.
- 10) Start the EV kit software by selecting **Start | Programs | Maxim Integrated | MAXSerDesEV-N | MAXSerDesEV-N**.
- 11) The **Configuration Settings** window opens (see [Figure 2](#)) and the GUI automatically searches for any active listener in both I<sup>2</sup>C and UART mode and identifies a valid GMSL product. Once a valid device is identified, the corresponding configuration jumpers are displayed to help users configure the serializer and deserializer.
- 12) In case an operating evaluation board with a Nuvoton microcontroller is not found, a window appears ([Figure 3](#)) warning as such. Press **OK** to continue and start the GUI anyway, or press **Cancel** to terminate the application. See the [Troubleshooting](#) section at the end of this document and fix the problem before continuing.
- 13) When an operating Nuvoton microcontroller is found, the GUI checks the firmware version in the microcontroller and prompts the user to update ([Figure 4](#)).
- 14) While the **Configuration Settings** window is open, press the **Identify Devices** button to search for the devices connected.
- 15) Only **Link Type** and **Device Address** selections on the **Configuration Settings** window affects the EV kit operation. Other items are for user reference only.
- 16) Press the **Connect** button to open the **Evaluation Kit** window and the devices under test (DUT) register maps ([Figure 5](#)). The GUI will read all internal registers of the serializer and deserializer and update the corresponding tabs.

MAX96705/MAX96711  
Evaluation Kit

Evaluates: MAX96705/MAX96711  
with Coax or STP Cable

- 17) Press the **Read All MAX96705** button in the **Serializer** group box to read all the serializer registers.
- 18) Press the **MAX96705 Des** tab (Figure 6) and then press the **Read All MAX96706** button in the **Deserializer** group box to read all the deserializer registers.
- 19) Select any of the other tabs to evaluate other serializer/deserializer (SerDes) functions.

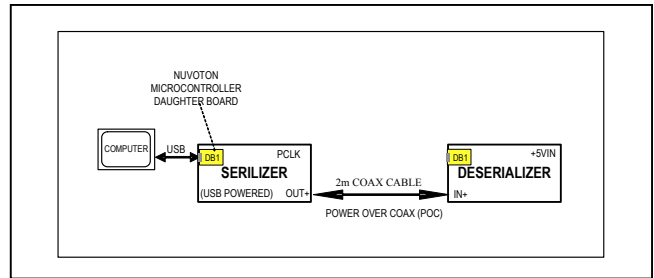

Figure 1. Serializer Test Setup Block Diagram

Table 1. Jumper Description\*

JUMPER	SIGNAL	SHUNT POSITION	FUNCTION
J1	+12V	—	+12V AC adapter input
J2	+5VIN	—	+5V power-supply input positive terminal
J3	GND	—	+5V power-supply input negative terminal
J4	OUT+	—	GMSL OUT+ FAKRA connector
J5	OUT-	—	GMSL OUT- FAKRA connector
J6	EXT_UC	—	4-pin header to apply user microcontroller
J11	U15 ch3	Open**	VLC3 = U15 level shifter, channel 3 low side VLC4 = U15 level shifter, channel 4 low side
J13	U15 ch4	Open**	VHC3 = U15 level shifter, channel 3 high side VHC4 = U15 level shifter, channel 4 high side
J23	GPIO5/LMN1	L	Connected to GND
		H	Connected to IOVDD
		Open**	Not connected
J25	U4_SCL	Short**	μC connected to U4 oscillator
		Open	μC not connected to U4 oscillator
J26	IDT_OE	L	U4 oscillator output not enabled
		H**	U4 oscillator output enabled
		Open	U4 oscillator OE pin not connected
J27	FSEL0	L**	U4 oscillator FSEL0 pin pulled low
		H	U4 oscillator FSEL0 pin pulled high
		Open	U4 oscillator FSEL0 pin not connected (internal low)
J28	FSEL1	L**	U4 oscillator FSEL1 pin pulled low
		H	U4 oscillator FSEL1 pin pulled high
		Open	U4 oscillator FSEL1 pin not connected (internal low)
J29	UC_RX/SDA	RX	U1 RX/SDA pin connected to μC RX pin
		SDA**	U1 RX/SDA pin connected to μC SDA pin
		Open	U1 RX/SDA pin left open

**Table 1. Jumper Description\* (continued)**

JUMPER	SIGNAL	SHUNT POSITION	FUNCTION
J30	GPIO2	Short	Shorted to IOVDD
		Open**	Shorted to GND
J32	GPIO3	Short	Shorted to IOVDD
		Open**	Shorted to GND
J33	GPIO4/LMN0	L	Connected to GND
		H	Connected to IOVDD
		Open**	Not connected
J35	U4_SDA	Short**	μC connected to U4 oscillator
		Open	μC not connected to U4 oscillator
J38	PCLK_IN	IDT**	U1 PCLKIN connected to U4 output
		SMA	U1 PCLKIN connected to PCLK_SMA connector
		GND	GND terminal for externally applied PCLK to J38.1
		Open	U1 PCLKIN pin not connected
J39	UC_TX/SCL	TX	U1 TX/SCL pin connected to μC RX pin
		SCL**	U1 TX/SCL pin connected to μC SDA pin
		Open	U1 TX/SCL pin left open
J40	GPIO1/BWS	L**	Connected to GND
		H	Connected to IOVDD
		Open	Not connected
J41	LCCN	L	Connected to GND
		H**	Connected to IOVDD
		Open	Not connected
J42	CONF0	L**	Connected to GND
		H	Connected to IOVDD
		Open	Not connected
J43	CONF1	L**	Connected to GND
		H	Connected to IOVDD
		Open	Not connected
J44	HIM_HI	Short	U1 GPO/HIM pin pulled up to IOVDD
		Open**	U1 GPO/HIM state depends on J45
J45	GPO_LOW	Short	U1 GPO/HIM pin connected to IOVDD
		Open**	U1 GPO/HIM state depends on J44
J46	IOVDD_DUT	Short**	U1 GPO/HIM pin connected to IOVDD
		Open	Apply ammeter to measure current drawn by U1 IOVDD

**Table 1. Jumper Description\* (continued)**

JUMPER	SIGNAL	SHUNT POSITION	FUNCTION
J47	MS/HVEN	L	Connected to GND
		H	Connected to IOVDD
		Open**	Not connected
J48	PWDN	L	U1 powered down
		H**	U1 powered up
J50	TX/SCL/DBL	DBL-L	U1 TX/SCL/DBL pin connected to GND
		U15_TC/SCL	U1 TX/SCL/DBL pin is connected to U15_TX/SCL
		DBL-H	U1 TX/SCL/DBL pin is connected to IOVDD
		Open	No POC
J51	POC+	POC5VOUT	5V POC is sourced by the serializer
		POC5VIN**	5V POC is expected from the deserializer
		POC12V	12V POC can be applied by either the serializer or deserializer
		Open	No POC
J52	POC-	POC5VOUT	5V POC is sourced by the serializer
		POC5VIN**	5V POC is expected from the deserializer
		POC12V	12V POC can be applied by either the serializer or deserializer
		Open	No POC
J53	VDD_REF	+3.3V**	Reference voltage for external $\mu$ C signals set to +3.3V
		+5V	Reference voltage for external $\mu$ C signals set to +5V
		Open	Reference voltage for external $\mu$ C signals applied to J6.VDD_REF
J54	EXSDAPU	Short**	On-board pullup applied on external $\mu$ C SDA signal
		Open	External $\mu$ C SDA signal must be pulled up externally
J55	EXSCLPU	Short**	On-board pullup applied on external $\mu$ C SCL signal
		Open	External $\mu$ C SCL signal must be pulled up externally
J56	LFR+	Short**	Line fault can be monitored by the remote device on the OUT+ terminal (LFAVDD must be short and LFR-, LFL+, LFL- must be open)
		Open	Line fault monitored by local device or OUT- terminal
J57	LFR-	Short	Line fault can be monitored by the remote device on the OUT- terminal (LFAVDD must be short and LFR+, LFL+, LFL- must be open)
		Open**	Line fault monitored by local device or OUT+ terminal
J58	LFL+	Short	Line fault can be monitored by the local device on the OUT+ terminal (LFAVDD must be short and LFR+, LFR-, LFL- must be open)
		Open**	Line fault monitored by remote device or OUT- terminal
J59	LFL-	Short	Line fault can be monitored by the local device on the OUT- terminal (LFAVDD must be short and LFR+, LFR-, LFL+ must be open)
		Open**	Line fault monitored by remote device or OUT+ terminal

**Table 1. Jumper Description\* (continued)**

JUMPER	SIGNAL	SHUNT POSITION	FUNCTION
J60	LFAVDD	Short**	Line-fault circuit powered, connected to AVDD
		Open	Line fault is powered, nonfunctional
JU2	IOVDD	+3.3V**	U1 IOVDD set to on-board 3.3V
		EXT	U1 IOVDD supplied through EXT-IOVDD terminal (J20)
		+1.8V	U1 IOVDD set to on-board 1.8V
JU3	DVDD	INT**	U1 DVDD supplied from internal source
		EXT	U1 DVDD supplied through EXT-DVDD terminal (J19)
JU4	AVDD	INT**	U1 AVDD supplied from internal source
		EXT	U1 AVDD supplied through EXT-AVDD terminal (J18)

\*Jumper selections in the **Serializer/Deserializer** group boxes on the **Configurations Settings** window are for reference only and do not affect software operation.

\*\*Default position.

## Detailed Description of Software

To start the serializer evaluation kit GUI, select **Start | All Programs | Maxim Integrated | MAXSerDesEV-N | MAXSerDesEV-N**.

### Configuration Settings Window

The **Configuration Settings** window is the first window that opens after successful program launch. It allows the user to specify serializer and deserializer board setup and mode of operation (Figure 2).

### Controller Group Box

In the **Controller** group box, select **Coax** or **STP** from the **Link Type** drop-down list, **I2C** or **UART** from the **Bus** drop-down list, and whether the **Serializer** or **Deserializer** should be connected to the USB controller. Upon changing any of these parameters, conflicting jumper settings will be highlighted, guiding the user to check and make the corresponding changes to the evaluation boards. Only the **Link Type** and **Device Address** selections on the **Configuration Settings** window affect EV kit operation. Other items, including jumper selection, are for user reference only.

### Serializer and Deserializer Jumper Selection Blocks

The **Serializer** and **Deserializer Jumper Selection** blocks list jumpers on the evaluation boards of the selected Device ID and displays the correct shunt positions based on the conditions selected in the **Controller** block.

### Identify Devices Button

The **Identify Devices** button causes the GUI to scan the system and hunt for slave addresses on the bus. Upon successful communication, it reads the **Device ID** register from the DUTs and displays the corresponding jumper lists on the **Serializer** and **Deserializer Jumper Selection** blocks. It is also possible to select a device from the **Device ID** drop-down list and manually change the slave address in the **Device Address** edit box. It is a good practice to utilize the **Identify Devices** button and verify communication with the DUTs before attempting to **Connect**.

Figure 14 shows jumper settings on the serializer PCB for coax cable and I<sup>2</sup>C communication with a USB cable connected to the serializer board. Refer to the respective SerDes IC data sheets for detailed configuration information. See Table 1 for the serializer jumper descriptions.

### Connect Button

The **Connect** button opens the **Evaluation Kit** window. The GUI reads the SerDes registers and updates the register maps for both. Successful register map updates are indicated by green LED indicators. In case of a communication problem, the LED indicators turn red.

### Cancel - Do not Connect Button

The **Cancel- Do Not Connect** button opens the **Evaluation Kit** main window without attempting to connect to the microcontroller. Although there is no communication with the microcontroller, all functions and tabs corresponding to the selected **Device IDs** on the **Evaluation Kit** window become active once there.

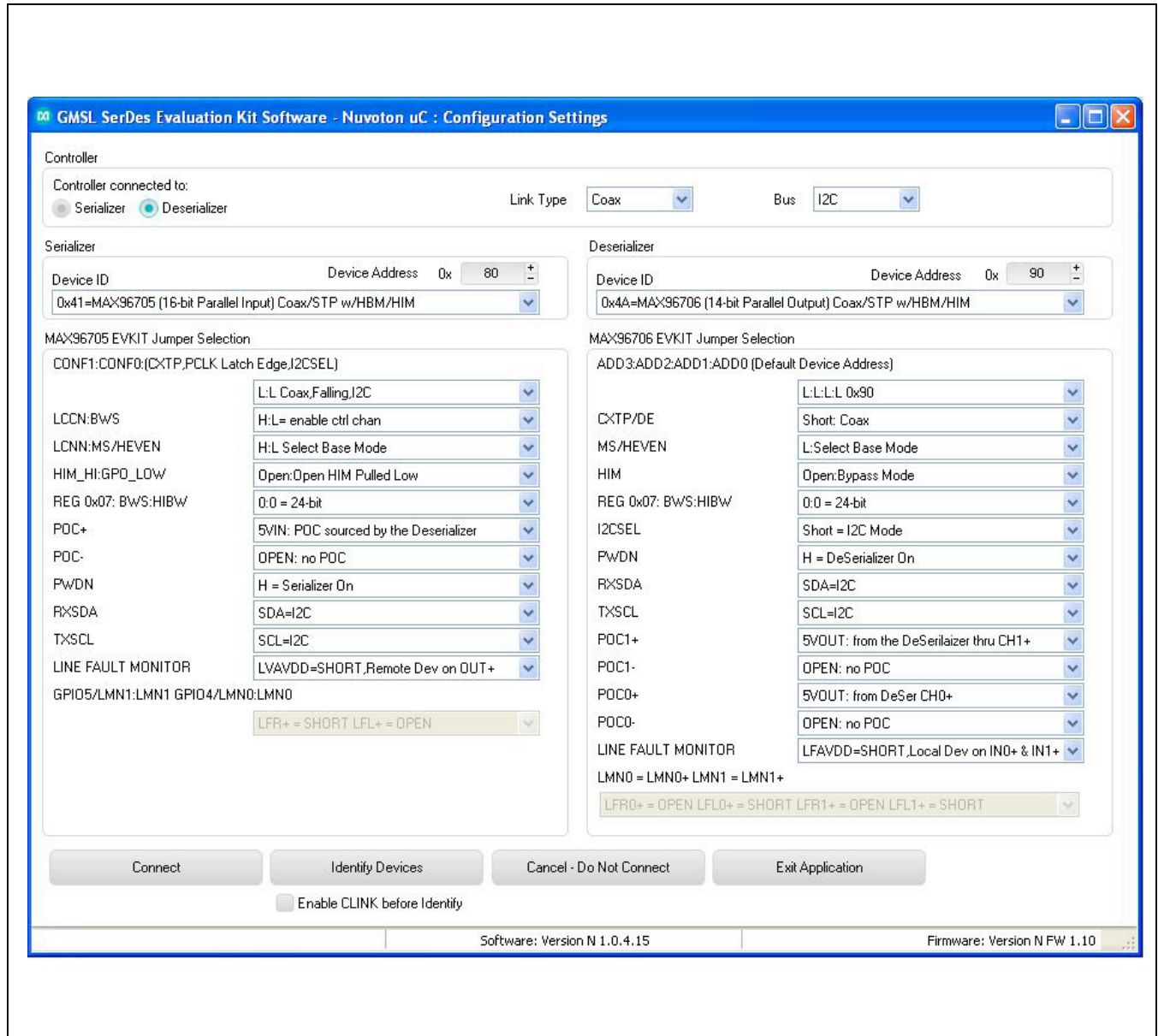

Figure 2. MAXSerDesEV-N EV Kit Software: Configuration Settings Window (shown with MAX96705 and MAX96706 EV Kits Connected)

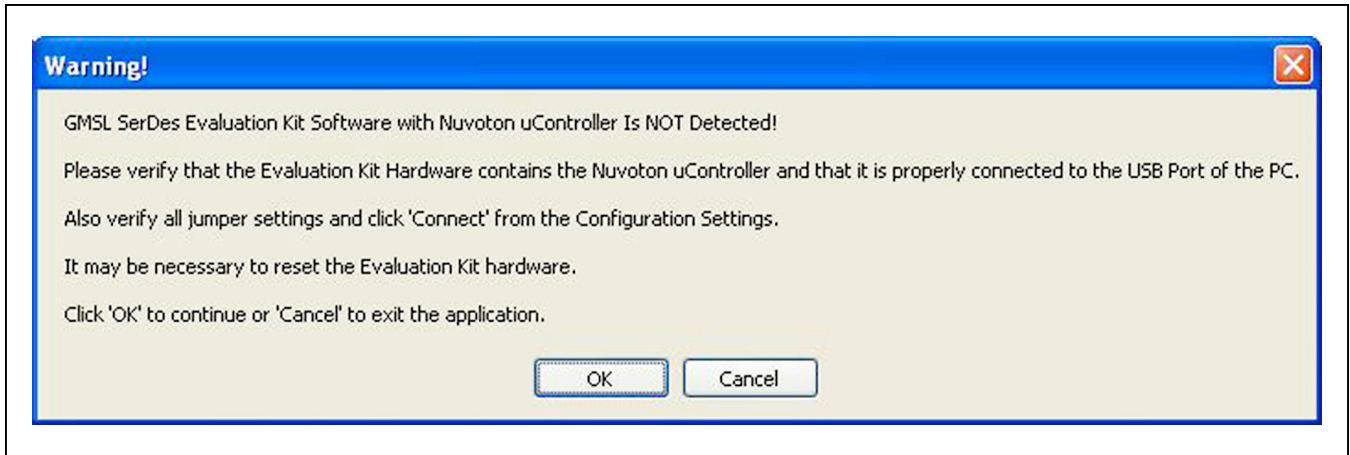

Figure 3. MAXSerDesEV-N EV Kit Software: Warning! (Nuvoton  $\mu$ Controller is NOT Detected!)

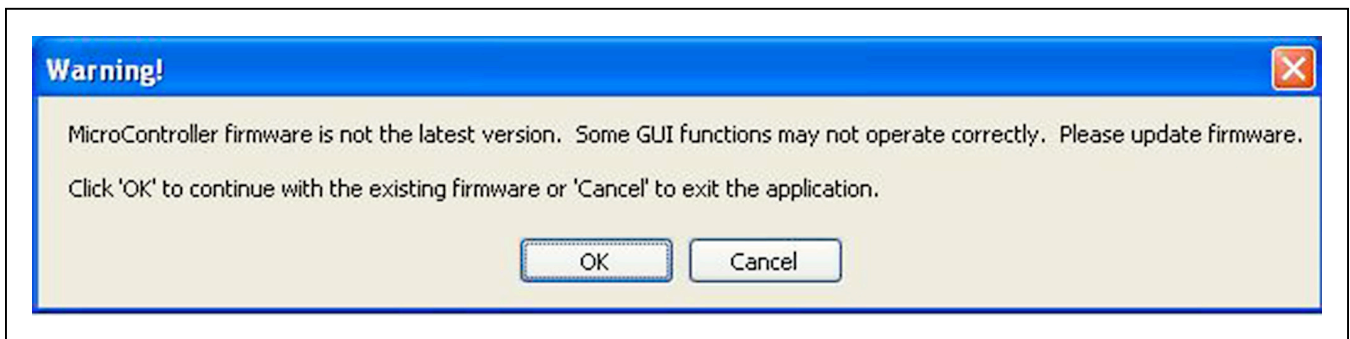

Figure 4. MAXSerDesEV-N EV Kit Software: Warning! (Microcontroller Firmware is Not the Latest Version)

### Evaluation Kit Window

The **Evaluation Kit** window shown in [Figure 5](#) provides access to all internal registers and functions of the DUTs by means of reading and writing registers through different tabs, thus enabling the user to evaluate various functions of the serializer and deserializer.

The **Read All** button updates the SerDes register maps by reading the DUT's internal registers.

The **Serializer** group box provides pushbuttons to update the serializer's register map from the DUT using the **Read All MAX96705** button. The **Load** button reads and

updates from a previously saved file and the **Save** button saves the existing register values into a new file.

The **Deserializer** group box provides pushbuttons to update the deserializer's register map from the DUT using the **Read All MAX96706** button. The **Load** button reads and updates from a previously saved file and the **Save** button saves the existing register values into a new file.

The **Wake Up** button applies the register write sequence described in the IC data sheets to wake the DUTs from sleep mode.

The **Open Configuration** button returns to the **Configuration Settings** window.



**MAX96705 Ser Tab**

The **MAX96705 Ser** tab (Figure 5) lists the serializer's register bitmaps. The **Read** and **Write** buttons in each register group box allows access to each bit or group of bits that specify a function or condition, as defined in the respective serializer IC data sheet. The color of the small LED indicator next to the **Read/Write** buttons indicates the communication status. Green indicates successful communication and red indicates failed communication.

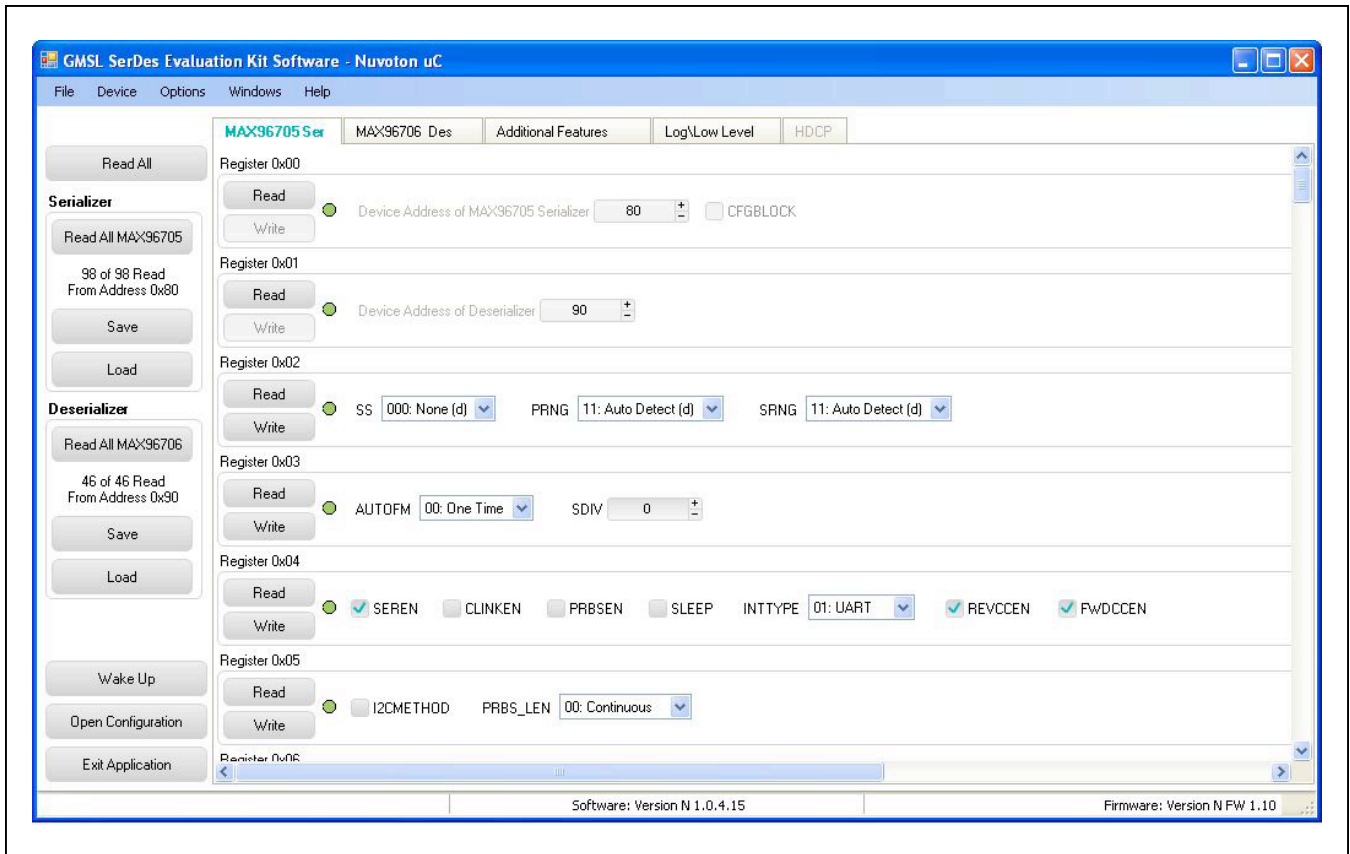

Figure 5. MAXSerDesEV-N EV Kit Software: Evaluation Kit Window (MAX96705 Ser Tab (Serializer))

### MAX96706 Des Tab

The **MAX96706 Des** tab (Figure 6) lists the deserializer's register bitmaps. The **Read** and **Write** buttons in each register group box allows access to each bit or group of bits that specify a function or condition, as defined in the respective deserializer data sheet. The color of the small LED indicator next to the **Read/Write** buttons indicates the communication status. Green indicates successful communication and red indicates failed communication.

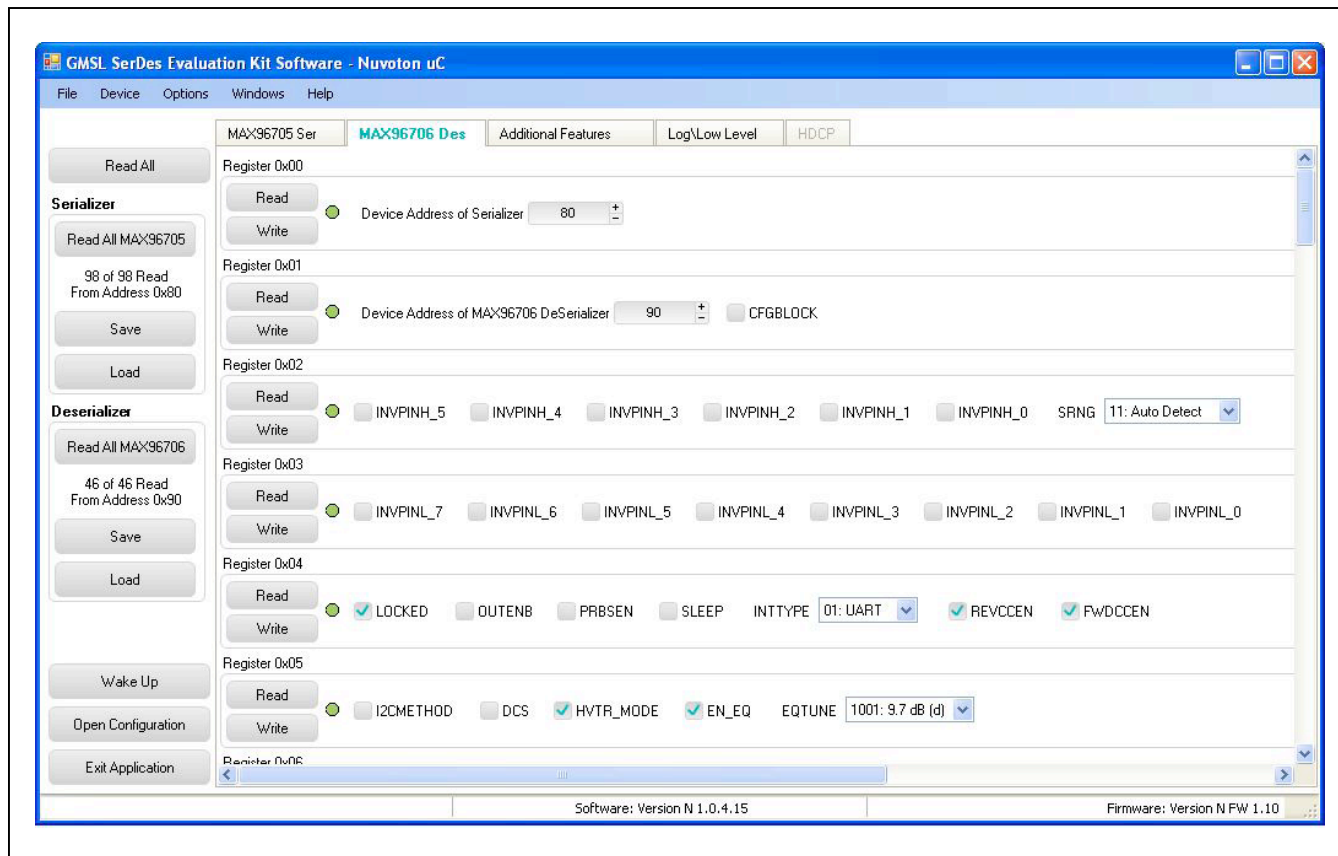

Figure 6. MAXSerDesEV-N EV Kit Software: Evaluation Kit Window (MAX96706 Des Tab (Deserializer))

**Additional Features Tab**

The **Additional Features** tab (Figure 7) provides pushbuttons for specific functions that connected devices can perform. By pressing a button, a new window pops up, launching the specific function selected. Function buttons not supported by the selected device are grayed out.

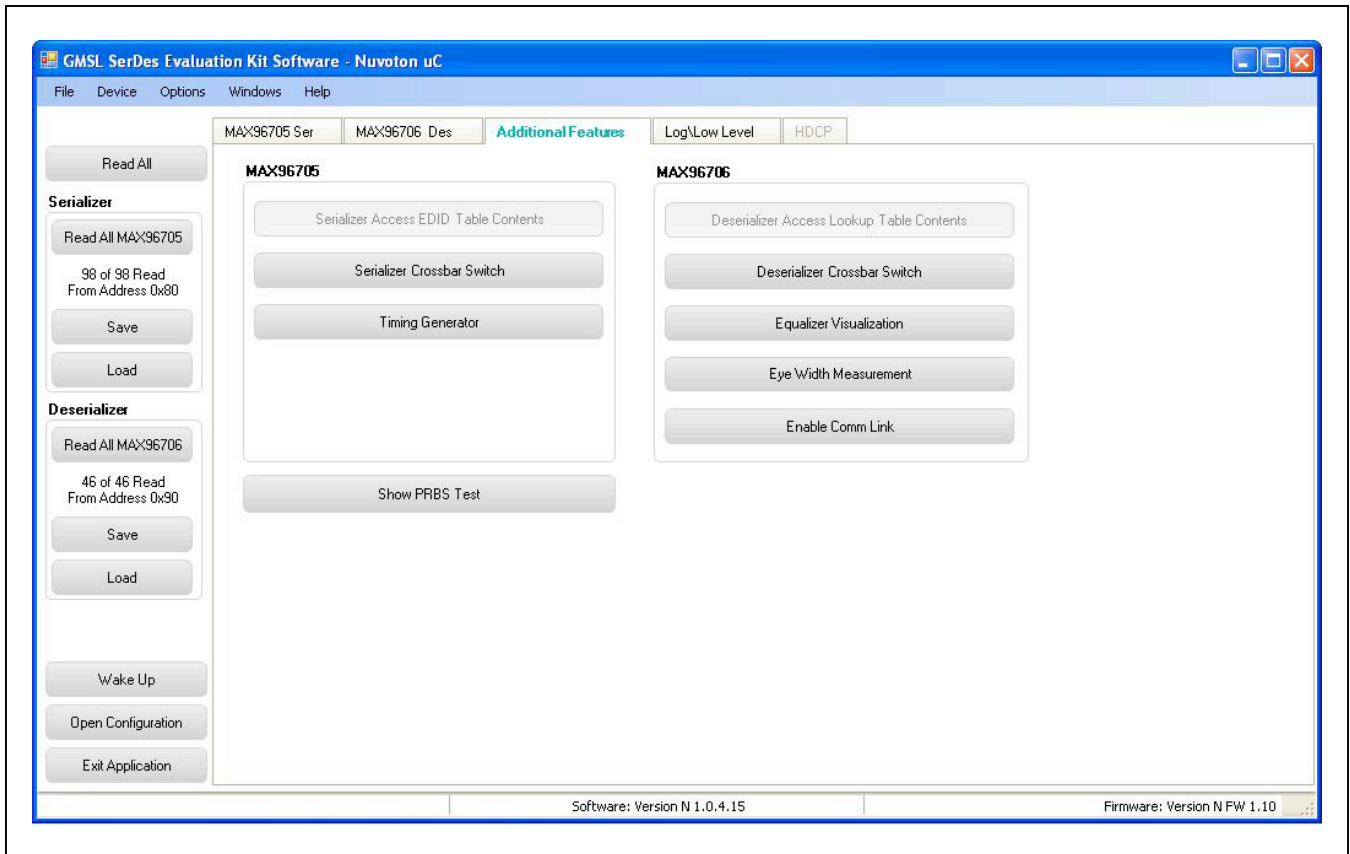

Figure 7. MAXSerDesEV-N EV Kit Software: Evaluation Kit Window (Additional Features Tab)

On the **Additional Features** tab, press the **Serializer Crossbar Switch** button to launch the **Serializer Crossbar Switch Configuration** function (Figure 8). This capability allows the rerouting of data between the parallel input/output by the serializer. Refer to the respective IC data sheet for a detailed description and operation on the embedded crossbar switches.

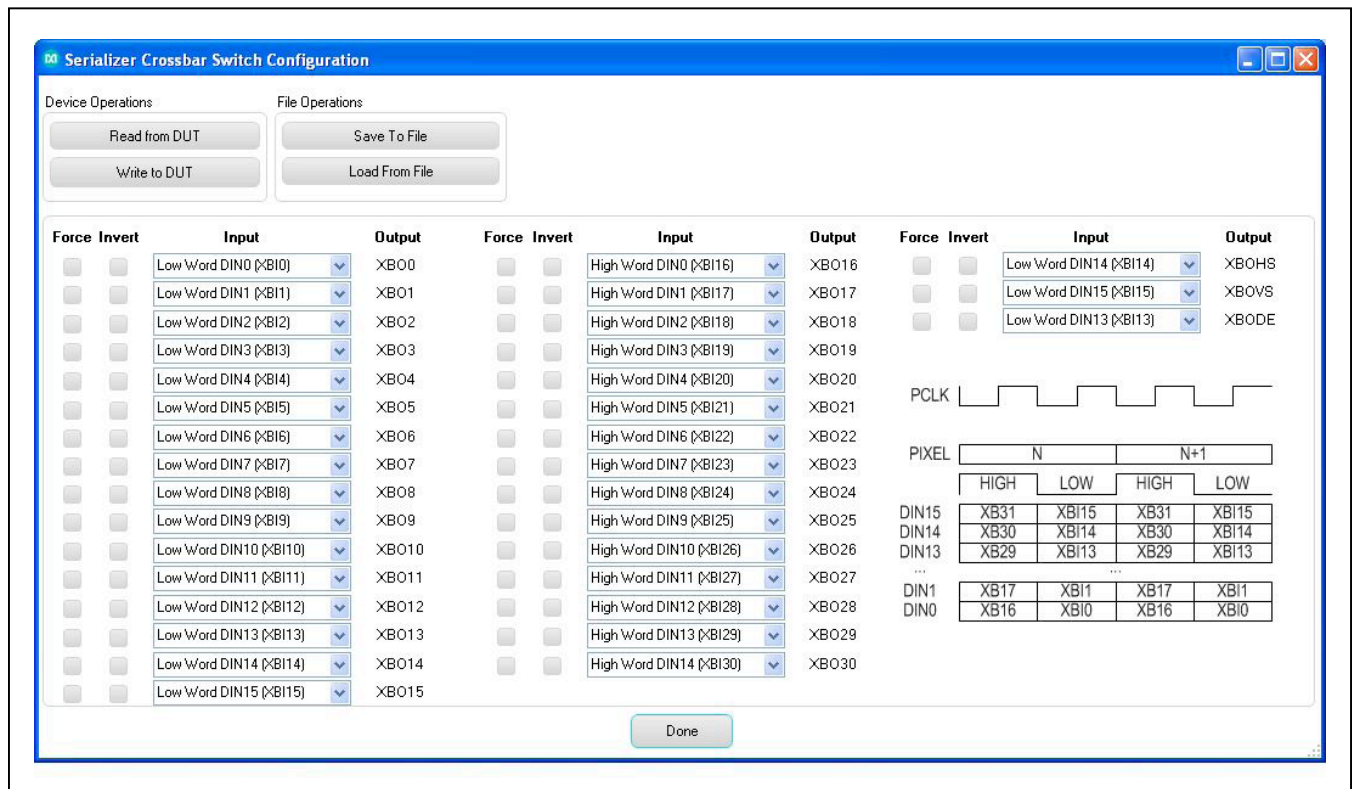

Figure 8. MAXSerDesEV-N EV Kit Software: Evaluation Kit Window (Serializer Crossbar Switch Configuration Window)

On the **Additional Features** tab, press the **Deserializer Crossbar Switch** button to launch the **Deserializer Crossbar Switch Configuration** function for the deserializer (Figure 9). This capability enables rerouting data between the parallel input/output by the deserializer. Refer to the respective IC data sheet for a detailed description and operation on the embedded crossbar switches.

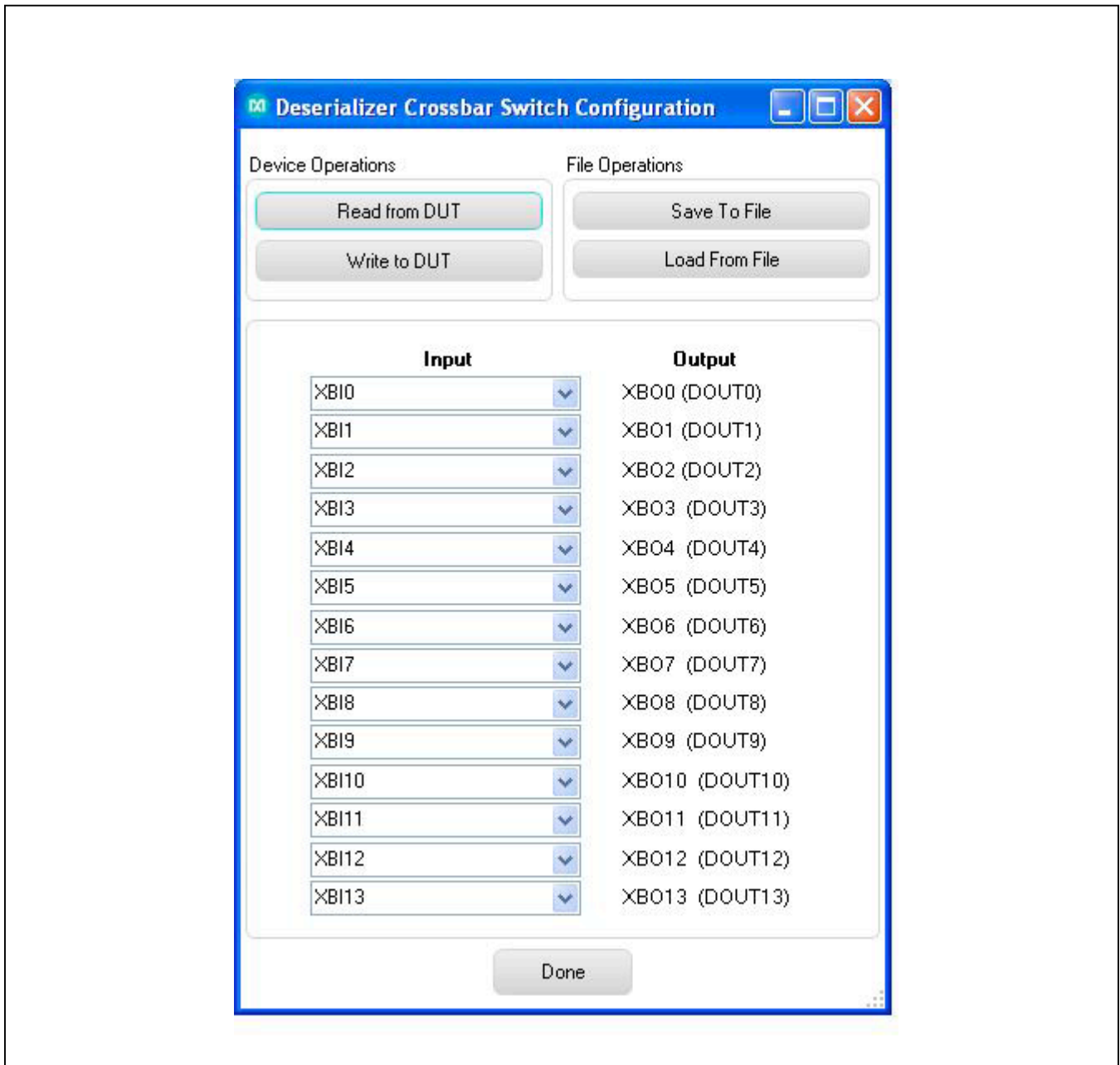

Figure 9. MAXSerDesEV-N EV Kit Software: Evaluation Kit Window (Deserializer Crossbar Switch Configuration Window)

On the **Additional Features** tab, press the **Timing Generator** button to launch this function (Figure 10), which allows the user to utilize the programmable video timing generator to generate/retime the input sync signals. Refer to the respective IC data sheet for a detailed description.

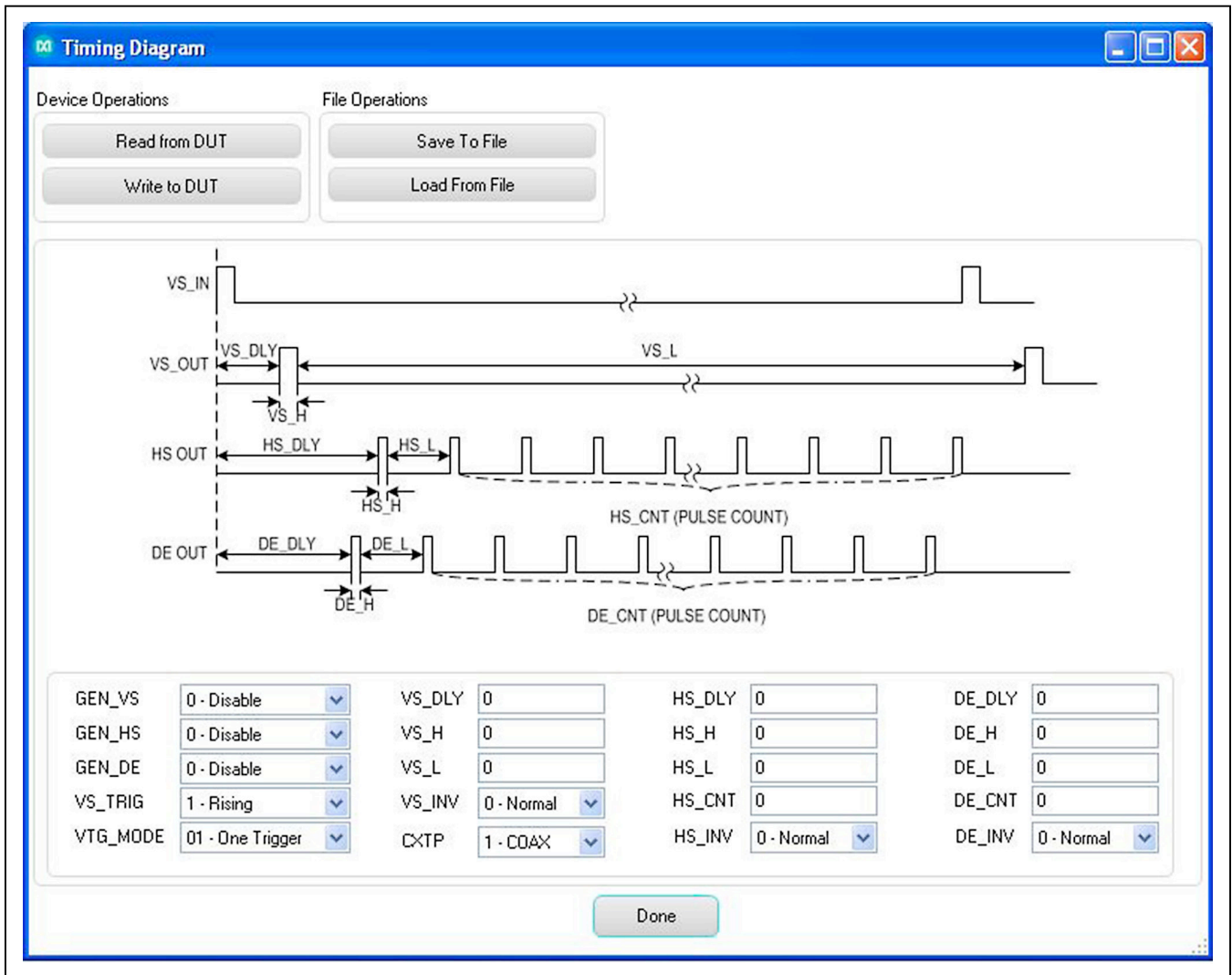

Figure 10. MAXSerDesEV-N EV Kit Software: Evaluation Kit Window (Timing Generator Window)

On the **Additional Features** tab, press the **Equalizer Visualization** button to launch this function (Figure 11), which allows compensating for higher cable attenuation and higher frequencies. Refer to the respective IC data sheet for a detailed description.

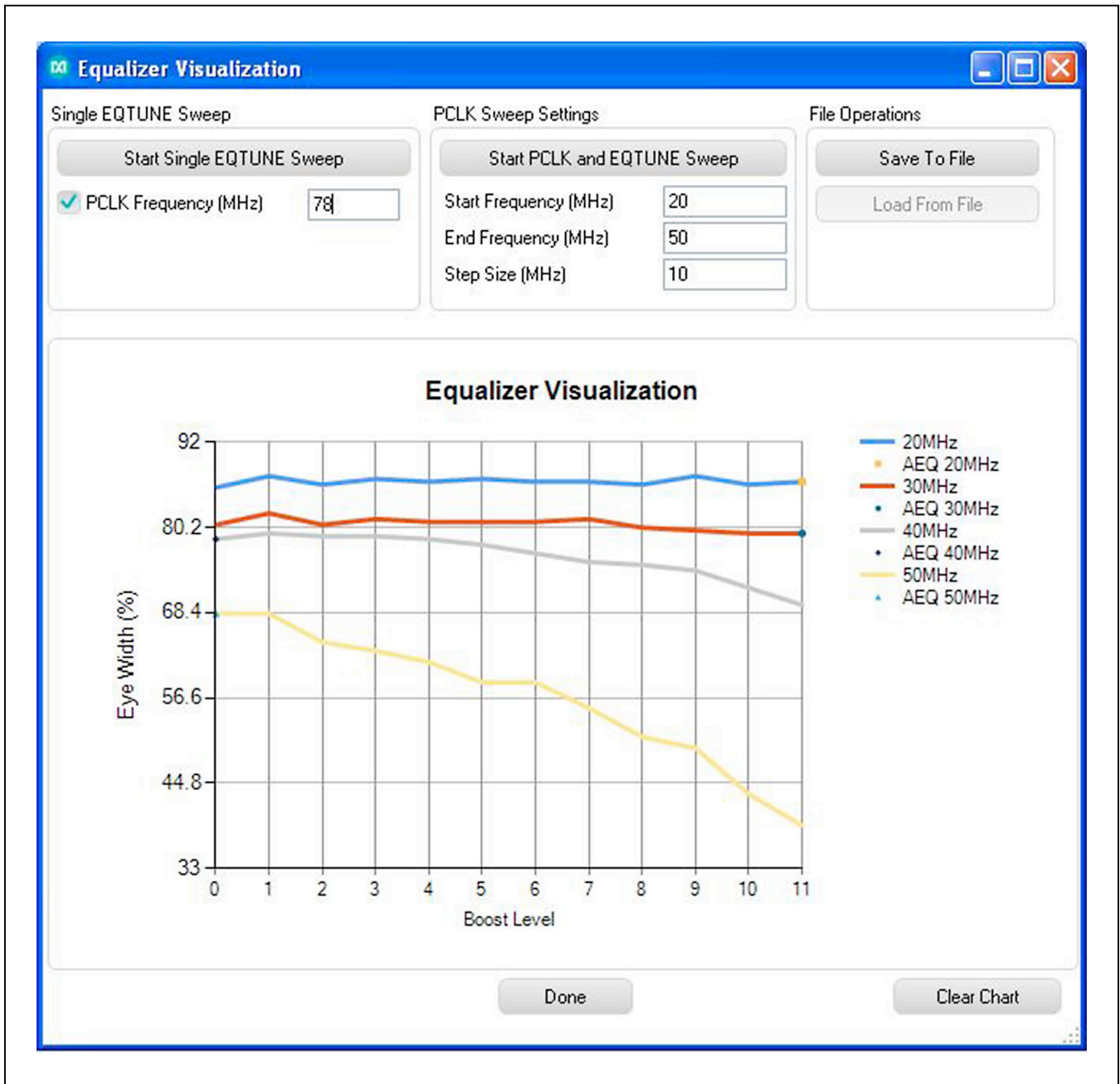

Figure 11. MAXSerDesEV-N EV Kit Software: Evaluation Kit Window (Equalizer Visualization Window)

On the **Additional Features** tab, press the **Show PRBS Test** button to perform a PRBS test (Figure 12). Enter test duration (maximum 32,767s = 9.1hrs) in the **Duration** edit box and press **Start** to start the test. At test completion, the number of bit errors are read from the PRBSERR register, and displayed in the **PRBS Error Counter** box.

### Log\Low Level Tab

The **Log\Low Level** tab (Figure 13) logs all activities between the GUI and DUTs.

The **Register Access** group box allows reads or writes of the specified slave and register addresses. Use the **Send String to EVKIT** button to communicate with non-register-based devices (such as the MAX7324). The **SerDes Baud Rate** drop-down list sets the communications baud rate. Note that the baud rate should be changed in small increments/decrements (one step change is forced by the GUI).

### Detailed Description of Firmware

The Nuvoton microcontroller on the daughter board runs a custom firmware that ensures reliable communication between the PC and DUTs. The firmware records 9-bit even-parity data received from the USB interface while RTS is set, and plays back the 9-bit data with 1.5 stop bits timing when RTS is cleared. Data received from the DUTs is immediately relayed to the USB port.

### Detailed Description of Hardware

The MAX96705/MAX96711 coax EV kit provides a proven design and layout for the MAX96705 and MAX96711 GMSL serializers, which was designed to be reliable with ease of use, flexibility, parallel input, and FAKRA coaxial cable serialized output. On-board level translators and easy-to-use USB-PC connections are included on the EV kit.

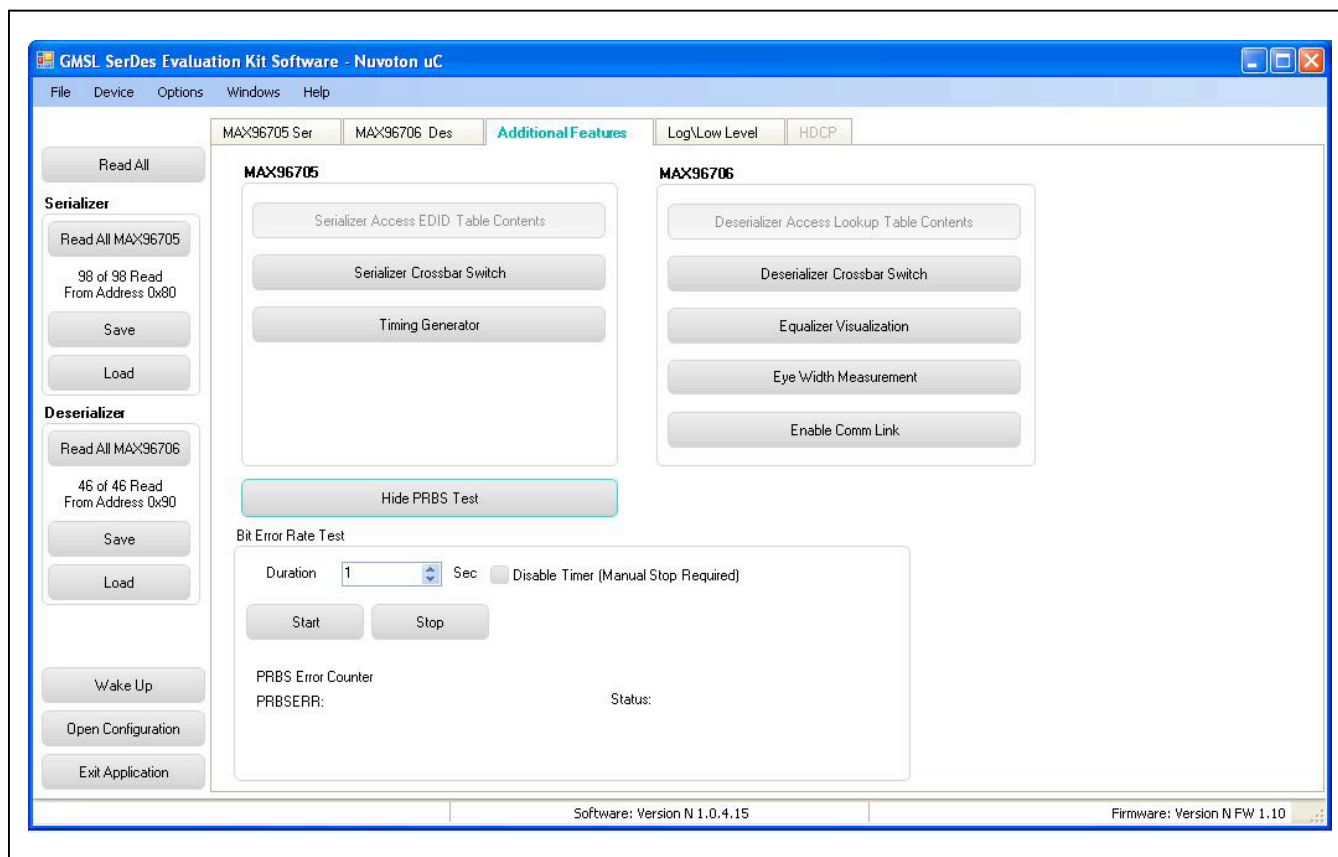

Figure 12. MAXSerDesEV-N EV Kit Software: Evaluation Kit Window (Show PRBS Test Window, Expanded)



# MAX96705/MAX96711 Evaluation Kit

Evaluates: MAX96705/MAX96711  
with Coax or STP Cable

The MAX96705/MAX96711 coax EV kit board consists of four principal functional blocks:

- 1) Microcontroller daughter board
- 2) MAX96705/MAX96711 application circuit block
- 3) Power-supply block
- 4) Oscillator (PCLK) circuit block

## Microcontroller Daughter Board

The Nuvoton-based microcontroller daughter board provides UART and I<sup>2</sup>C interfaces that communicate with both serializer and deserializer boards when they are powered on and properly configured. The Nuvoton microcontroller is programmed with the latest firmware at the time of manufacturing.

To use the EV kit with an externally applied controller, remove the Nuvoton microcontroller board from the EV kit board (DB1 position) and apply the RX/SDA, TX/SCL, VDD, and GND signals from the user microcontroller to the corresponding signals on J6 of the serializer board. Use one of the logic levels from the VDD\_REF, J53 header, or apply externally.

## Application Circuit

The application circuit block includes the serializer and all other components and circuits suggested in the respective IC data sheet, and test points and provisions to provide access to internal functions of the serializer for evaluation of the product.

## Power Supplies

On-board LDO regulators U2, U3, and U12 generate various voltage levels required to operate the EV kit board. There are four options to power the board:

- 1) USB port (default)
- 2) 12V AC adapter
- 3) 5V power supply applied power over coax cable
- 4) Power jumper (JU1 selects from the four power sources)

To operate the EV kits with voltage levels different from what are generated by on-board regulators, move desired IOVDD (JU2), DVDD (JU3), and AVDD (JU4) shunt from INT to EXT positions and apply the external voltage to the corresponding wire-loop terminal.

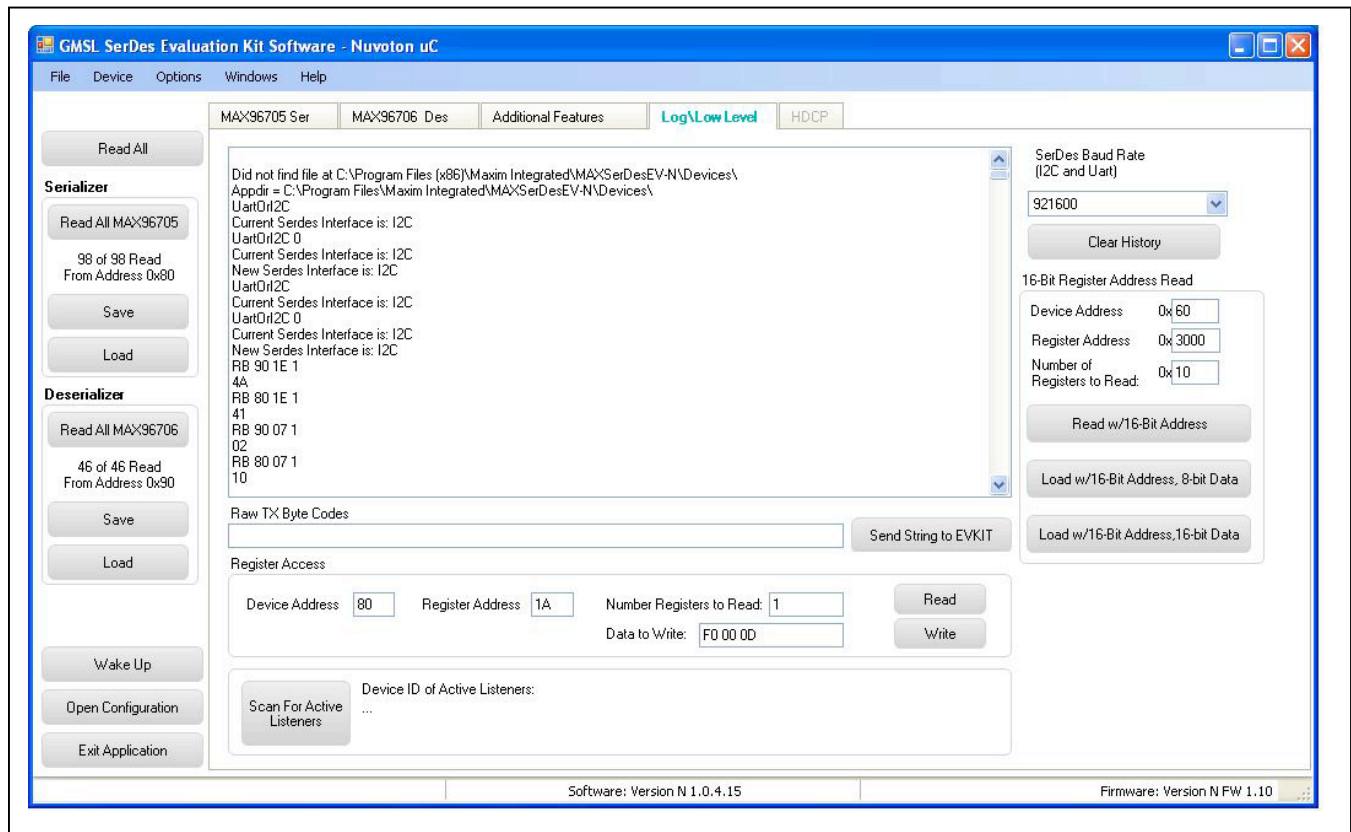

Figure 13. MAXSerDesEV-N EV Kit Software: Evaluation Kit Window (Log/Low Level Tab)

# MAX96705/MAX96711 Evaluation Kit

Evaluates: MAX96705/MAX96711  
with Coax or STP Cable

## Oscillator (PCLK) Circuit Block

An on-board custom oscillator (U4) to supply PCLK is provided to facilitate the serializer/deserializer evaluation. This is an I<sup>2</sup>C-programmable oscillator with four custom preprogrammed and jumper-selectable frequencies. FSEL0 and FSEL1 jumpers positions select one of the preprogrammed frequencies per list below:

### FSEL1 FSEL0 PCLK (MHz)

L	L	25.0
L	H	37.0
H	L	78.0
H	H	104.0

Place jumper IDT\_EN (J26) in the “L” position to disable the oscillator output. To operate the the oscillator at a frequency other than the four preprogrammed frequencies, refer to the oscillator data sheet available at [www.idt.com/products/clocks-timing/quartz-crystal-oscillator-ics-xo-crystal-clock-oscillators-and-low-power-oscillator-circuits/8n0q001-quad-frequency-programmable-xo-0](http://www.idt.com/products/clocks-timing/quartz-crystal-oscillator-ics-xo-crystal-clock-oscillators-and-low-power-oscillator-circuits/8n0q001-quad-frequency-programmable-xo-0), or contact the manufacturer.

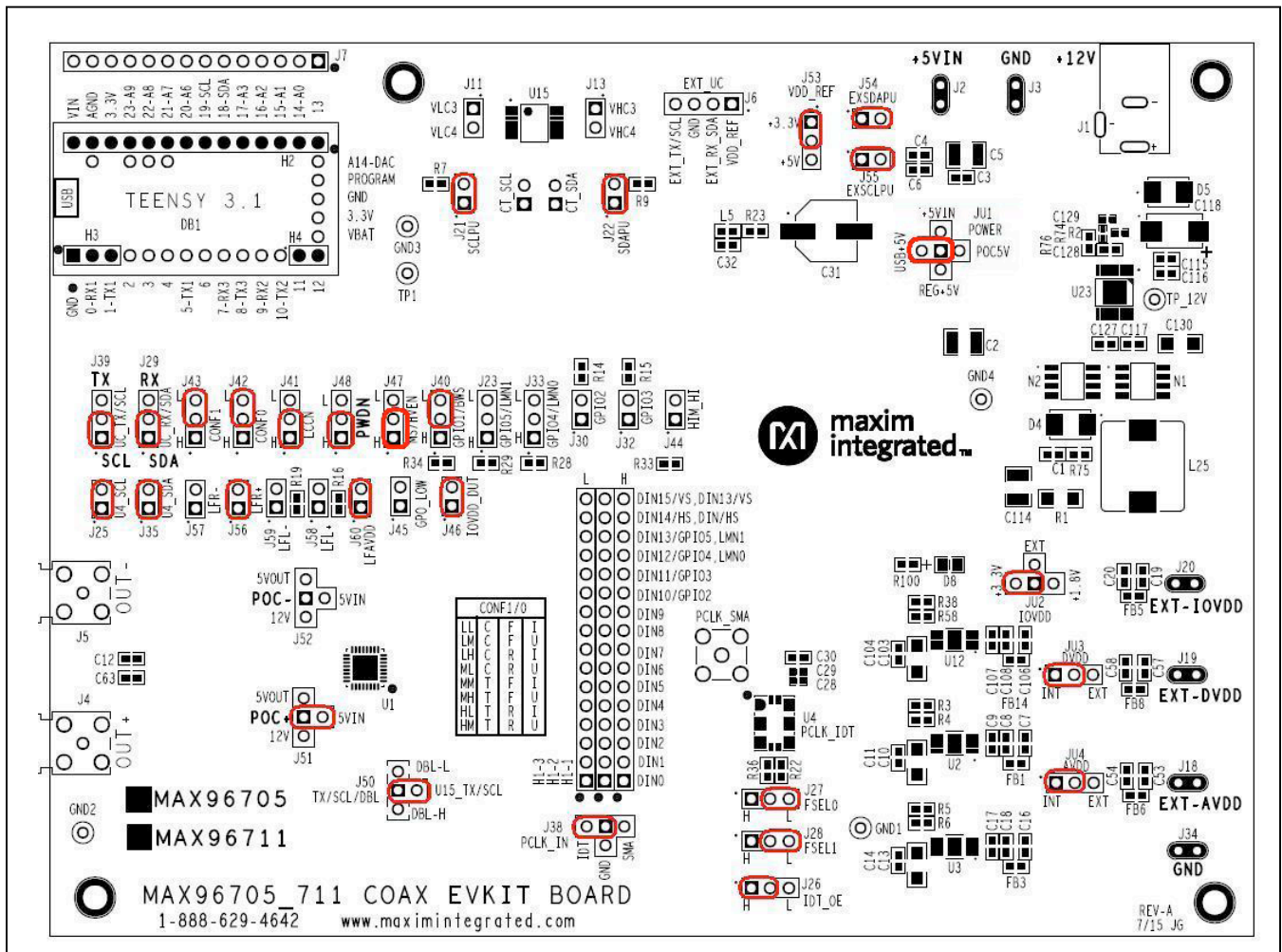

Figure 14. MAX96705/MAX96711 Coax EV Kit Jumper Settings for Coax Link and I<sup>2</sup>C Communication

# MAX96705/MAX96711 Evaluation Kit

Evaluates: MAX96705/MAX96711  
with Coax or STP Cable

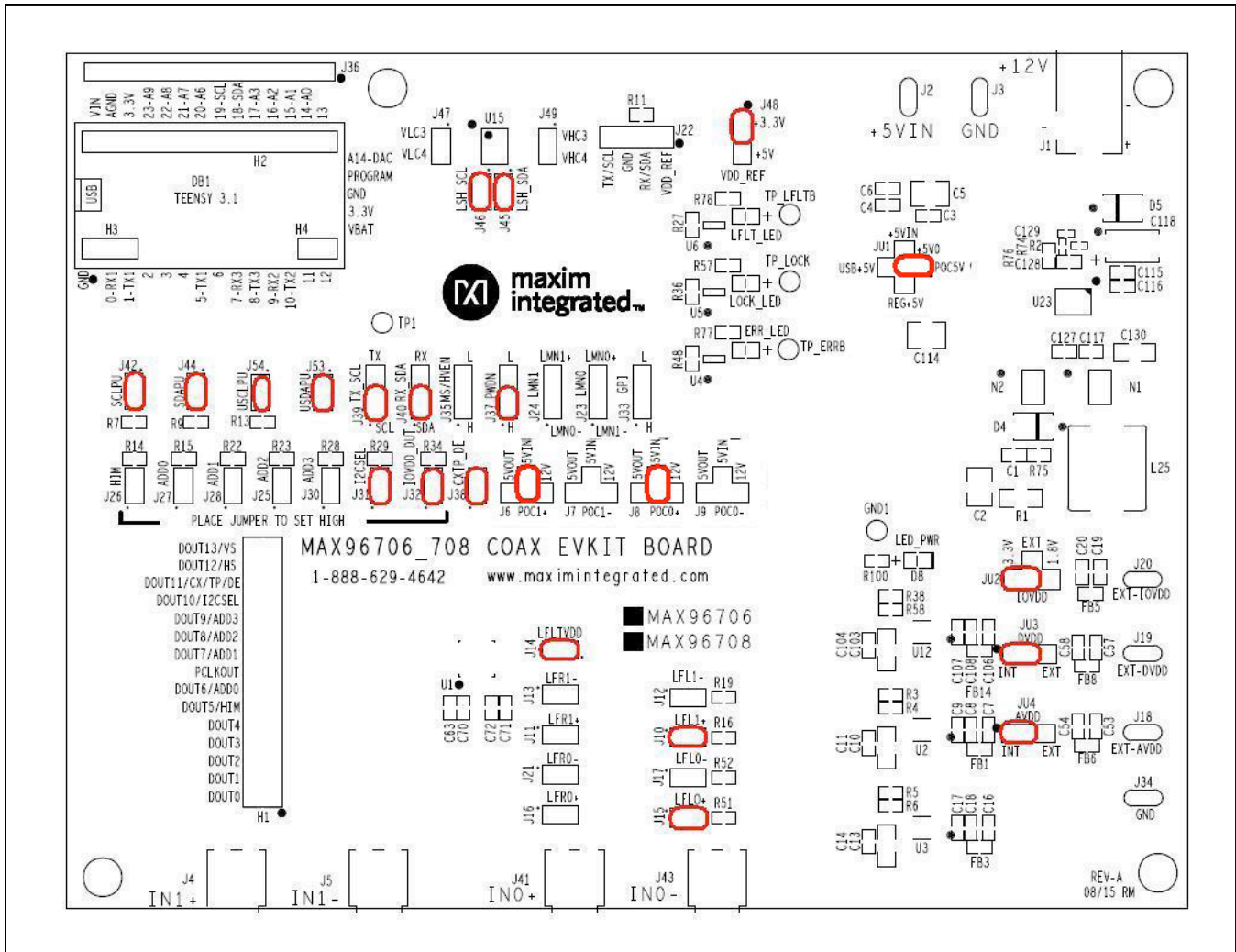

Figure 15. MAX96706/MAX96708 Coax EV Kit Jumper Settings for Coax Link and I2C Communication

## Troubleshooting

Possible causes of board test failure:

- 1) Coax cable not properly connected between the serializer OUT+ to the deserializer IN+.
- 2) PCLKIN not applied (e.g., FG output is disabled): Verify signal at the pins on the board.
- 3) PCLKIN and function generator output are not correct: Verify signal at the pins on the board.
- 4) Incorrect jumper setting on the deserializer board: Reverify.
- 5) Incorrect jumper setting on the serializer board:
  - 6) Bus selection on the GUI is not consistent with jumpers' position on the boards: Check and verify that USB cable is properly connected.
  - 7) USB port has locked: Exit application GUI, remove USB cable from the board, reinsert and relaunch the GUI.
  - 8) Nuvoton µC is not communicating: Exit application GUI, remove USB cable from the board, reinsert and relaunch the GUI.
  - 9) Deserializer board is faulty: Try a different board (if available).
  - 10) Serializer board is faulty: Try a different board (if available).

# MAX96705/MAX96711 Evaluation Kit

Evaluates: MAX96705/MAX96711  
with Coax or STP Cable

## Component Suppliers

SUPPLIER	PHONE	WEBSITE
Amphenol RF	800-627-7100	www.amphenolrf.com
Hong Kong X'tals Ltd.	852-35112388	www.hongkongcrystal.com
Integrated Device Technology (IDT)	908-766-4941	www.idt.com
Murata Americas	770-436-1300	www.murataamericas.com
ON Semiconductor	602-244-6600	www.onsemi.com
Rosenberger Hochfrequenztechnik GmbH	011-49-86 84-18-0	www.rosenberger.de
TDK Corp.	847-803-6100	www.component.tdk.com

**Note:** Indicate that you are using the MAX96705 or MAX96711 when contacting these component suppliers.

## Component List

Click on the links below for component information, schematics, and PCB layout diagrams:

- [MAX96705/MAX96711 EV Kit BOM](#)
- [MAX96705/MAX96711 EV Kit Schematics](#)
- [MAX96705/MAX96711 EV Kit PCB Layout](#)

## Ordering Information

PART	TYPE
MAX96705COAXEVKIT#	EV Kit
MAX96711COAXEVKIT#*	EV Kit
MAXCOAX2STP-HSD#	Adapter Kit

#Denotes RoHS compliant.

\*Future product—contact factory for availability.

**Note:** The MAX96705 and MAX96711 coax EV kits are normally ordered with a companion board:

- MAX96706 coax EV kit (MAX96706COAXEVKIT#)
- MAX96708 coax EV kit (MAX96708COAXEVKIT#)\*

MAX96705/MAX96711  
Evaluation Kit

Evaluates: MAX96705/MAX96711  
with Coax or STP Cable

## Revision History

REVISION NUMBER	REVISION DATE	DESCRIPTION	PAGES CHANGED
0	12/15	Initial release	—

For pricing, delivery, and ordering information, please contact Maxim Direct at 1-888-629-4642, or visit Maxim Integrated's website at [www.maximintegrated.com](http://www.maximintegrated.com).

*Maxim Integrated cannot assume responsibility for use of any circuitry other than circuitry entirely embodied in a Maxim Integrated product. No circuit patent licenses are implied. Maxim Integrated reserves the right to change the circuitry and specifications without notice at any time.*

TITLE: Bill of Materials

DATE: 12/2015

DESIGN: max96705\_711\_evkit\_a

**NOTE:** DNI = DO NOT INSTALL ; DNP = DO NOT PROCURE

REF_DES	DNI/DNP	QTY	VALUE	DESCRIPTION	MFG PART #	MANUFACTURER
C1	-	1	1500PF	CAPACITOR; SMT (0603); CERAMIC CHIP; 1500PF; 50V; TOL=10%; MODEL=C SERIES; HIGH TEMPERATURE; TG=-55 DEGC TO +150 DEGC; TC=X8R	C1608X8R1H152K080	TDK
C2	-	1	10UF	CAPACITOR; SMT (1210); CERAMIC CHIP; 10UF; 16V; TOL=20%; MODEL=; TG=-55 DEGC TO +125 DEGC; TC=X7R	C1210C106M4RAC; C3225X7R1C106M200AB	KEMET/TDK
C3, C8, C18, C30, C32, C108, C115, C127	-	8	10UF	CAPACITOR; SMT (0603); CERAMIC CHIP; 10UF; 16V; TOL=20%; TG=-25 DEGC TO +85 DEGC; TC=JB	C1608JB1C106M080AB	TDK
C4, C6, C7, C9, C16, C17, C106, C107, C116, C117	-	10	0.1UF	CAPACITOR; SMT (0603); CERAMIC CHIP; 0.1UF; 25V; TOL=10%; MODEL=C SERIES; TG=-55 DEGC TO +125 DEGC; TC=X7R	C1608X7R1E104K080AA	TDK
C5, C34, C64, C114	-	4	100UF	CAPACITOR; SMT (1210); CERAMIC CHIP; 100UF; 10V; TOL=20%; MODEL=CL SERIES; TG=-55 DEGC TO +85 DEGC; TC=X5R	CL32A107MPVNNN	SAMSUNG ELECTRONICS
C10, C13, C103, C130	-	4	10UF	CAPACITOR; SMT (1206); CERAMIC CHIP; 10UF; 10V; TOL=20%; MODEL=C SERIES; TG=-55 DEGC TO +85 DEGC; TC=X5R	C3216X5R1A106M160	TDK
C11, C14, C19, C20, C53, C54, C57, C58, C104	-	9	4.7UF	CAPACITOR; SMT (0603); CERAMIC; 4.7UF; 6.3V; TOL=20%; MODEL=C SERIES; TG=-55 DEGC TO +85 DEGC; TC=X5R	C1608X5R0J475M080AB; GRM188R60J475ME19; JMK107BJ475MA-T	TDK/MURATA/TAIYO YUDEN
C12, C33, C62, C63	-	4	0.22UF	CAPACITOR; SMT (0603); CERAMIC CHIP; 0.22UF; 50V; TOL=10%; MODEL=C SERIES; TG=-55 DEGC TO +125 DEGC; TC=X7R	C1608X7R1H224K080	TDK
C15, C21, C22, C27, C28, C35, C61	-	7	0.1UF	CAPACITOR; SMT (0402); CERAMIC CHIP; 0.1UF; 16V; TOL=10%; TG=-55 DEGC TO +125 DEGC; TC=X7R;	C0402X7R160-104KNE; CL05B104KO5NNNC; GRM155R71C104KA88; C1005X7R1C104K; CC0402KRX7R7BB104; EMK105B7104KV	VENKEL LTD./SAMSUNG ELECTRONICS/MURATA/TDK/YAGEO PHICOMP/TAIYO YUDEN

REF_DES	DNI/DNP	QTY	VALUE	DESCRIPTION	MFG PART #	MANUFACTURER
C23-C26, C36, C60, C97	-	7	1000PF	CAPACITOR; SMT (0402); CERAMIC CHIP; 1000PF; 50V; TOL=10%; MODEL=C SERIES; TG=-55 DEGC TO +125 DEGC; TC=X7R	C1005X7R1H102K050BA	TDK
C29, C85, C96, C99, C100	-	5	0.1UF	CAPACITOR; SMT (0402); CERAMIC; 0.1UF; 16V; TOL=10%; MODEL=GRM SERIES; TG=-55 DEGC to +85 DEGC; TC=X5R	GRM155R61C104KA88	MURATA
C31	-	1	470UF	CAPACITOR; SMT (CASE_F); ALUMINUM-ELECTROLYTIC; 470UF; 16V; TOL=20%; MODEL=CR SERIES; TG=-55 DEGC TO +105 DEGC	PCR1C471MCL6	NICHICON
C118	-	1	100UF	CAPACITOR; SMT (7343); TANTALUM CHIP; 100UF; 16V; TOL=20%; MODEL=TQC SERIES	16TQC100MYF	PANASONIC
C129	-	1	2200PF	CAPACITOR; SMT (0402); CERAMIC CHIP; 2200PF; 50V; TOL=10%; MODEL=C SERIES; TG=-55 DEGC TO +125 DEGC; TC=X7R	C1005X7R1H222K050BA	TDK
D4, D5	-	2	B360B-13-F	DIODE; SCH; SCHOTTKY BARRIER DIODE; SMB; PIV=60V; Io=3A; -55 DEGC TO +125 DEGC	B360B-13-F	DIODES INCORPORATED
D8	-	1	SML-210VTT86	DIODE; LED; SML-21 SERIES; RED; SMT (0805); PIV=2V; IF=0.02A	SML-210VTT86	ROHM
L4, L5, FB1, FB3, FB5, FB6, FB8, FB14	-	8	120	INDUCTOR; SMT (0603); FERRITE-BEAD; 120; TOL=+/-25%; 3A	BLM18SG121TN1	MURATA
TP1, GND1-GND4, TP_12V	-	6	N/A	TEST POINT; PIN DIA=0.1IN; TOTAL LENGTH=0.3IN; BOARD HOLE=0.04IN; RED; PHOSPHOR BRONZE WIRE SILVER PLATE FINISH;	5000	KEYSTONE
H1-1-H1-3	-	3	PBC16SAAN	CONNECTOR; MALE; THROUGH HOLE; BREAKAWAY; STRAIGHT; 16PINS; -65 DEGC TO +125 DEGC	PBC16SAAN	SULLINS ELECTRONICS CORP.
H2	-	1	PPPC141LFBN-RC	CONNECTOR; FEMALE; THROUGH HOLE; LFB SERIES; 2.54MM CONTACT CENTER; STRAIGHT; 14PINS	PPPC141LFBN-RC	SULLINS ELECTRONICS CORP
H3	-	1	PPTC031LFBN-RC	CONNECTOR; FEMALE; THROUGH HOLE; HEADER; STRAIGHT THROUGH; 3PINS; -40 DEGC TO +105 DEGC	PPTC031LFBN-RC	SULLINS
H4	-	1	PPPC021LFBN-RC	CONNECTOR; FEMALE; THROUGH HOLE; LFB SERIES; 2.54MM CONTACT CENTER; STRAIGHT; 2PINS	PPPC021LFBN-RC	SULLINS ELECTRONICS CORP

REF_DES	DNI/DNP	QTY	VALUE	DESCRIPTION	MFG PART #	MANUFACTURER
J1	-	1	PJ-202BH	CONNECTOR; MALE; THROUGH HOLE; PJ-202BH; DC POWER JACK; RIGHT ANGLE; RIGHT ANGLE; 3PINS	PJ-202BH	CUI INC.
J2, J3, J18-J20, J34	-	6	MAXIMPAD	EVK KIT PARTS; MAXIM PAD; WIRE; NATURAL; SOLID; WEICO WIRE; SOFT DRAWN BUS TYPE-S; 20AWG	9020 BUSS	WEICO WIRE
J4, J5	-	2	59S2AX-400A5-Z	CONNECTOR; MALE; THROUGH HOLE; RIGHT ANGLE PLUG FOR PCB; RIGHT ANGLE; 5PINS	59S2AX-400A5-Z	ROSENBERGER
J6	-	1	PEC04SAAN	CONNECTOR; MALE; THROUGH HOLE; BREAKAWAY; STRAIGHT; 4PINS	PEC04SAAN	SULLINS ELECTRONICS CORP.
J7	-	1	PBC14SAAN	CONNECTOR; MALE; THROUGH HOLE; BREAKAWAY; STRAIGHT; 14PINS; -65 DEGC TO +125 DEGC	PBC14SAAN	SULLINS ELECTRONICS CORP.
J11, J13, J21, J22, J25, J30, J32, J35, J44-J46, J54, J55	-	13	PCC02SAAN	CONNECTOR; MALE; THROUGH HOLE; BREAKAWAY; STRAIGHT THROUGH; 2PINS; -65 DEGC TO +125 DEGC	PCC02SAAN	SULLINS
J23, J26-J29, J33, J39-J43, J47, J48, J53	-	14	PCC03SAAN	CONNECTOR; MALE; THROUGH HOLE; BREAKAWAY; STRAIGHT THROUGH; 3PINS; -65 DEGC TO +125 DEGC	PCC03SAAN	SULLINS
J38, J50-J52, JU2	-	5	PEC04SAAN	CONNECTOR; MALE; THROUGH HOLE; BREAKAWAY; STRAIGHT; 4PINS	PEC04SAAN	SULLINS ELECTRONICS CORP.
J56-J60	-	5	PEC02SAAN	CONNECTOR; MALE; THROUGH HOLE; BREAKAWAY; STRAIGHT; 2PINS	PEC02SAAN	SULLINS
JU1	-	1	PBC05SAAN	CONNECTOR; MALE; THROUGH HOLE; BREAKAWAY; STRAIGHT; 5PINS; -65 DEGC TO +125 DEGC	PBC05SAAN	SULLINS ELECTRONICS CORP.
JU3, JU4	-	2	PEC03SAAN	CONNECTOR; MALE; THROUGH HOLE; BREAKAWAY; STRAIGHT; 3PINS	PEC03SAAN	SULLINS
L1, L8	-	2	330NH	INDUCTOR; SMT (0603); FERRITE CORE; 330NH; TOL=+/-5%; 0.63A	LQW18CNR33J00	MURATA
L2, L7	-	2	6.8UH	INDUCTOR; SMT (1210); WIREWOUND CHIP; 6.8UH; TOL=20%; 0.62A	LBC3225T6R8MR	TAIYO YUDEN
L3, L6	-	2	100UH	INDUCTOR; SMT (2424); WIREWOUND CHIP; 100UH; TOL=20%; 0.92A	LQH6PPN101M43L	MURATA
L25	-	1	1.5UH	INDUCTOR; SMT; FERRITE-BEAD; 1.5UH; TOL=+/-20%; 27A	7443330150	WURTH ELECTRONICS INC.
MECH1-MECH4	-	4	1902B	STANDOFF; FEMALE-THREADED; HEX; 4-40IN; 3/8IN; NYLON	1902B	GENERIC PART



REF_DES	DNI/DNP	QTY	VALUE	DESCRIPTION	MFG PART #	MANUFACTURER
MISC2	-	1	MAXEVCNTR-NUV#	EVKIT PART-NUVOTON MICRO CONTROLLER	MAXEVCNTR-NUV#	MAXIM
N1, N2	-	2	FDS8449	TRAN; N-CHANNEL POWER TRENCH MOSFET; NCH; NSOIC8 ; PD-(2.5W); I-(7.6A); V-(40V)	FDS8449	FAIRCHILD SEMICONDUCTOR
PCLK_SMA	-	1	5-1814832-1	CONNECTOR; FEMALE; THROUGH HOLE; CONN SOCKET SMA STR DIE CAST PCB; STRAIGHT; 5PINS	5-1814832-1	TYCO
R1	-	1	0.015	RESISTOR; 1206; 0.015 OHM; 5%; 200PPM; 1W; THICK FILM	ERJ-8BJR015V	PANASONIC
R2	-	1	14.3K	RESISTOR, 0402, 14.3K OHM, 1%, 100PPM, 0.0625W, THICK FILM	CRCW040214K3FK	VISHAY DALE
R3, R5, R38	-	3	24.9K	RESISTOR; 0603; 24.9K OHM; 1%; 100PPM; 0.10W; THICK FILM	CRCW060324K9FK	VISHAY DALE
R4	-	1	41.2K	RESISTOR; 0603; 41.2K OHM; 1%; 100PPM; 0.10W; METAL FILM	CRCW060341K2FK	VISHAY DALE
R6, R58	-	2	11K	RESISTOR; 0603; 11K OHM; 1%; 100PPM; 0.10W; THICK FILM	CR0603-FX-1102ELF	BOURNS
R7, R9, R11, R13-R15, R28, R29, R34	-	9	2.2K	RESISTOR, 0603, 2.2K OHM, 1%, 100PPM, 0.10W, THICK FILM	CRCW06032K20FK	VISHAY DALE
R12, R27, R37, R39	-	4	0	RESISTOR; 0402; 0 OHM; 0%; JUMPER; 0.063W; THICK FILM	CRCW04020000ZS	VISHAY DALE
R16, R19	-	2	45.3K	RESISTOR; 0603; 45.3KOHM; 1%; 100PPM; 0.10W; THICK FILM	CRCW060345K3FK; ERJ-3EKF4532V	VISHAY DALE/PANASONIC
R17, R20	-	2	4.99K	RESISTOR; 0201; 4.99K OHM; 1%; 100PPM; 0.05W ; THICK FILM	CRCW02014K99FK	VISHAY DALE
R18, R21	-	2	49.9K	RESISTOR; 0201; 49.9K OHM; 1%; 100PPM; 0.05W ; THICK FILM	CRCW020149K9FK	VISHAY DALE
R22, R36	-	2	1K	RESISTOR; 0603; 1K; 1%; 100PPM; 0.10W; THICK FILM	CRCW06031001FK; ERJ-3EKF1001V	VISHAY DALE; PANASONIC
R23	-	1	2	RESISTOR, 0603, 2 OHM, 1%, 100PPM, 0.10W, THICK FILM	CRCW06032R00FN	VISHAY DALE
R24, R25, R30, R31	-	4	2K	RESISTOR, 0603, 2K OHM, 1%, 100PPM, 0.10W, THICK FILM	CRCW06032K0FK; ERJ-3EKF2001V	VISHAY DALE/PANASONIC
R26, R32	-	2	2K	RESISTOR; 0201; 2K OHM; 1%; 200PPM; 0.05W; THICK FILM	ERJ-1GEF2001C	PANASONIC
R33	-	1	30K	RESISTOR; 0603; 30K OHM; 1%; 100PPM; 0.10W; THICK FILM	CRCW060330K0FK	VISHAY DALE

REF_DES	DNI/DNP	QTY	VALUE	DESCRIPTION	MFG PART #	MANUFACTURER
R74	-	1	30K	RESISTOR; 0402; 30K OHM; 1%; 100PPM; 0.063W; THICK FILM	RC0402FR-0730KL	YAGEO PHICOMP
R75, R76	-	2	0	RESISTOR; 0603; 0 OHM; 5%; JUMPER; 0.10W; THICK FILM	RC1608J000CS; CR0603-J/-000ELF;RC0603JR-070RL	SAMSUNG ELECTRONICS/BOURNS/YAGEO PH
R100	-	1	1K	RESISTOR; 0603; 1K OHM; 1%; 100PPM; 0.10W; THICK FILM	CR0603-FX-1001ELF	BOURNS
SCREW1-SCREW4	-	4	P440.375	MACHINE SCREW; SLOTTED; PAN; 4-40IN; 3/8IN; NYLON	P440.375	GENERIC PART
SU1-SU25	-	25	STC02SYAN	TEST POINT; JUMPER; STR; TOTAL LENGTH=0.256IN; BLACK; INSULATION=PBT CONTACT=PHOSPHOR BRONZE; COPPER PLATED TIN OVERALL	STC02SYAN	SULLINS ELECTRONICS CORP.
U1	-	1	MAX96705GTJ	IC; HS81 PRELIMINARY; PACKAGE OUTLINE 32 TQFN; 0.50MM PITCH; 21-0140/T3255-8; MAX96705	MAX96705GTJ	MAXIM
U2,U3,U12	-	3	MAX1792EUA33	IC; VREG; LOW-DROPOUT LINEAR REGULATOR; UMAX8	MAX1792EUA33	MAXIM
U4	-	1	IDT8N0Q001	EVKIT PART; IC; IDT8N0Q001; CD10 PACKAGE OUTLINE 7X5 BODY; 2.54MM PITCH; CUSTOM PART ONLY	IDT8N0Q001	IDT
U15	-	1	MAX3378EEUD+	IC; TRANS; +/-15KV ESD-PROTECTED, 1UA, 16MBPS, QUAD LOW-VOLTAGE LEVEL TRANSLATOR; TSSOP14	MAX3378EEUD+	MAXIM
U23	-	1	MAX16952AUE/V+	IC; CTRL; STEP-DOWN CONTROLLER WITH LOW OPERATING CURRENT; TSSOP16-EP	MAX16952AUE/V+	MAXIM
MISC1	DNI	1	AK67421-1-R	CONNECTOR; MALE; USB; USB2.0 MICRO CONNECTION CABLE; USB B MICRO MALE TO USB A MALE; STRAIGHT; 5PINS-4PINS	AK67421-1-R	ASSMANN
C37, C59, C128	DNP	3	OPEN	PACKAGE OUTLINE 0603 NON-POLAR CAPACITOR	N/A	N/A
DB1	DNP	1	TEENSY 3.1	EVKIT PART; MODULE; CTRL; TEENSY USB DEVELOPMENT BOARD; TH-37; CUSTOM PART ONLY	TEENSY 3.1	PJRC

TOTAL 234

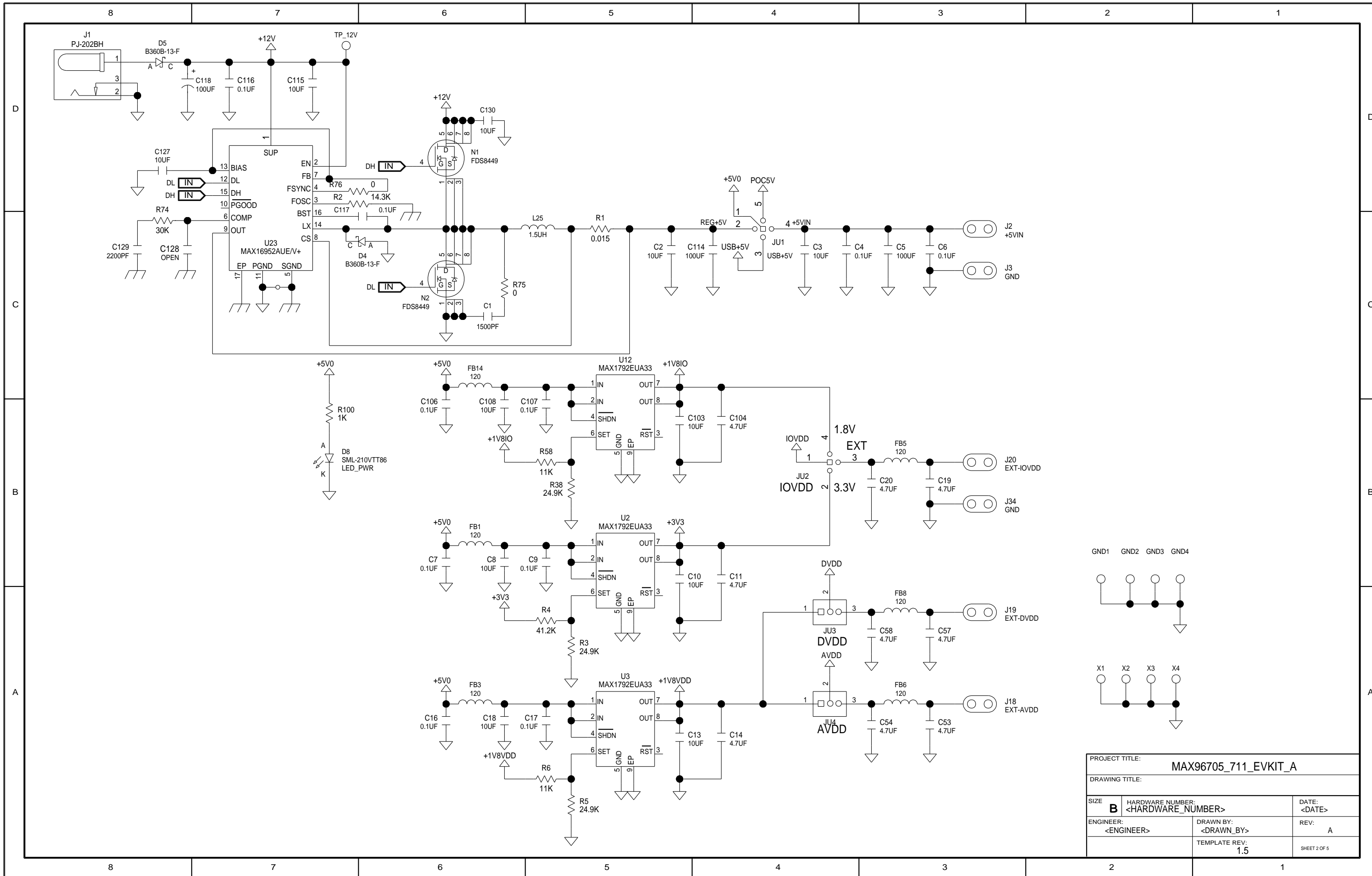

PROJECT TITLE:		
MAX96705_711_EVKIT_A		
DRAWING TITLE:		
SIZE	HARDWARE NUMBER:	DATE:
<b>B</b>	<HARDWARE_NUMBER>	<DATE>
ENGINEER:	DRAWN BY:	REV:
<ENGINEER>	<DRAWN_BY>	A
TEMPLATE REV:		SHEET 2 OF 5
1.5		

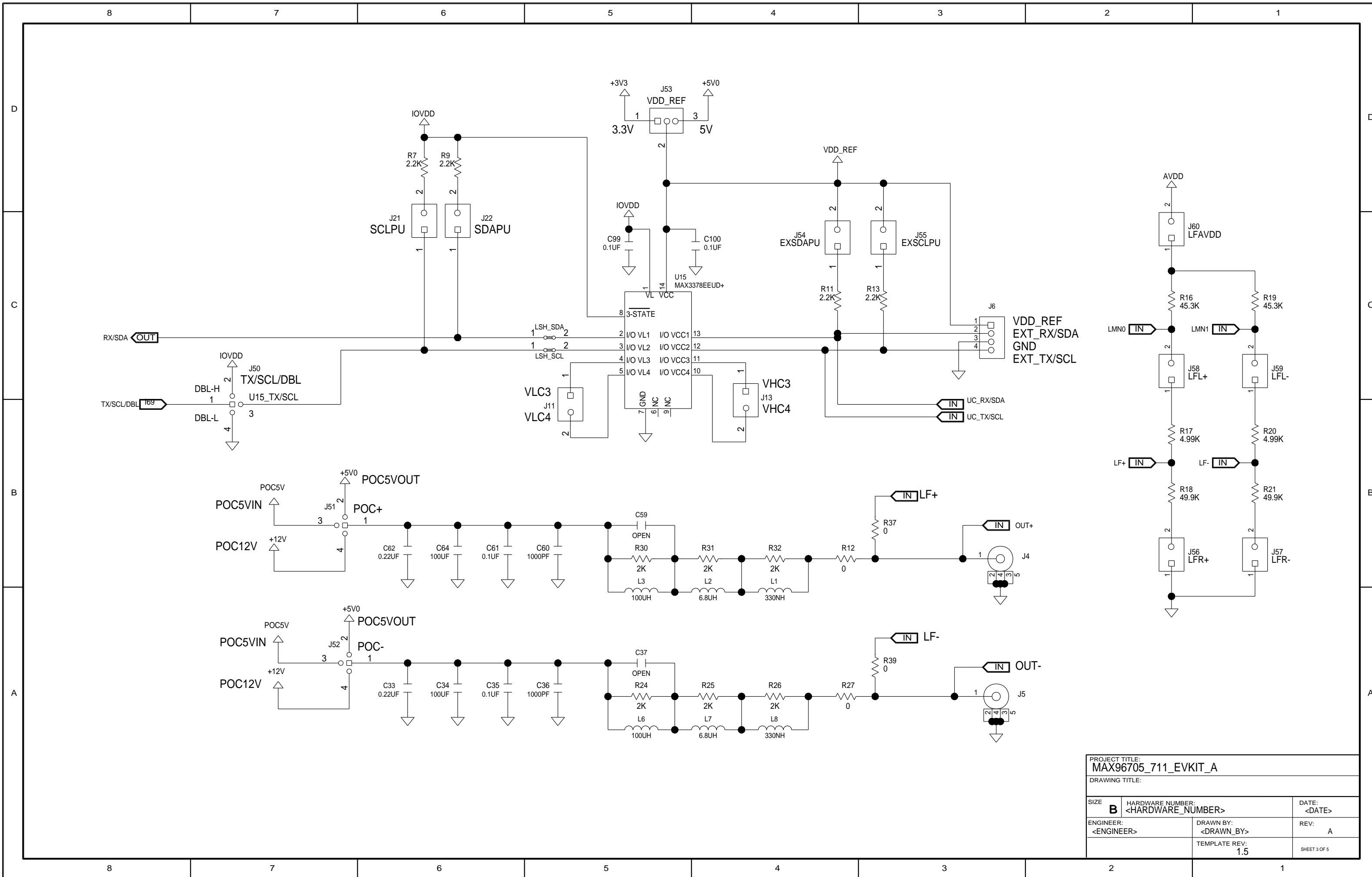

PROJECT TITLE: MAX96705_711_EVKIT_A		
DRAWING TITLE:		
SIZE <b>B</b>	HARDWARE NUMBER: <HARDWARE_NUMBER>	DATE: <DATE>
ENGINEER: <ENGINEER>	DRAWN BY: <DRAWN_BY>	REV: A
TEMPLATE REV: 1.5		SHEET 3 OF 5

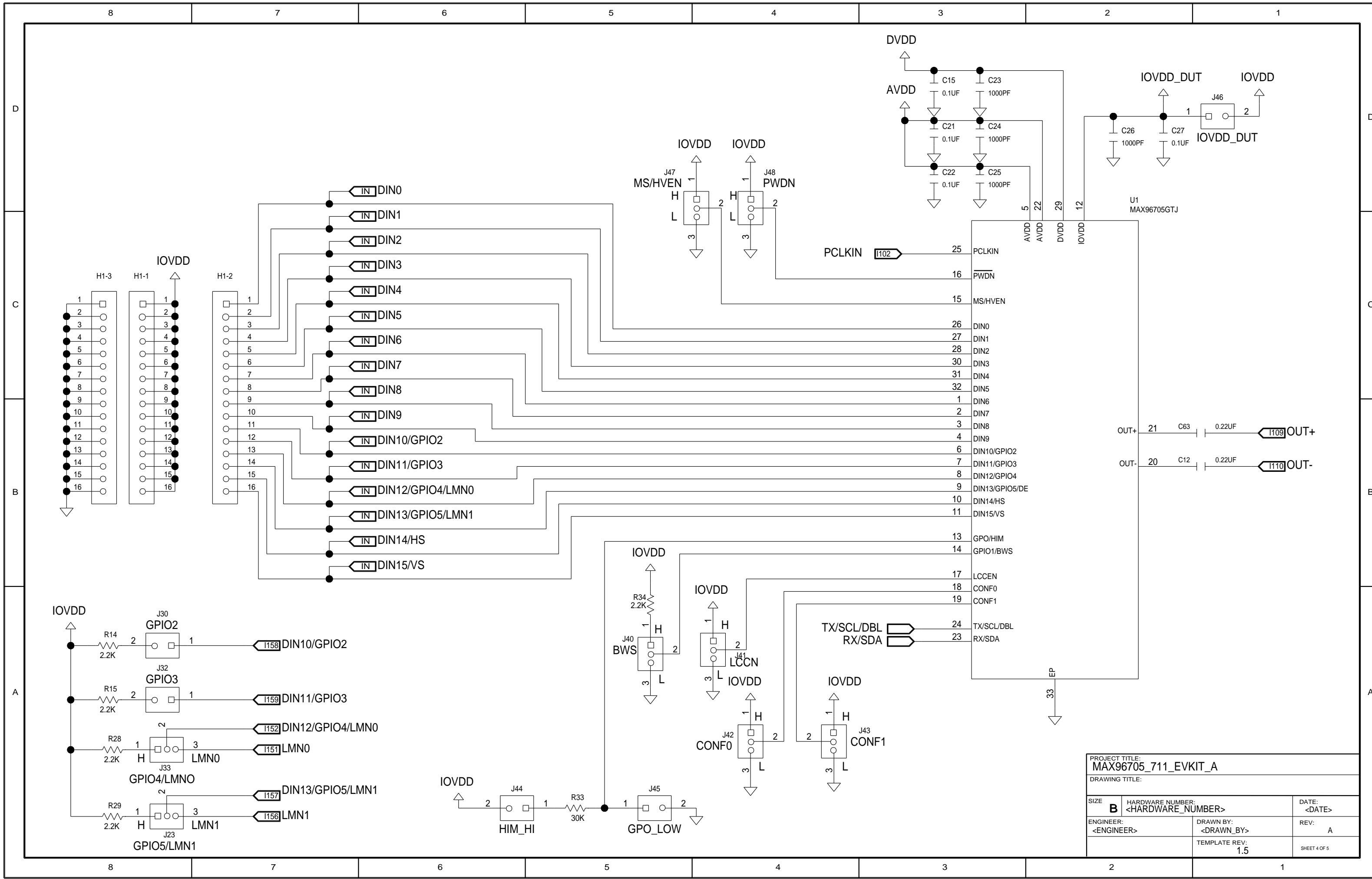

PROJECT TITLE: MAX96705_711_EVKIT_A		
DRAWING TITLE:		
SIZE <b>B</b>	HARDWARE NUMBER: <HARDWARE_NUMBER>	DATE: <DATE>
ENGINEER: <ENGINEER>	DRAWN BY: <DRAWN_BY>	REV: A
TEMPLATE REV: 1.5		SHEET 4 OF 5

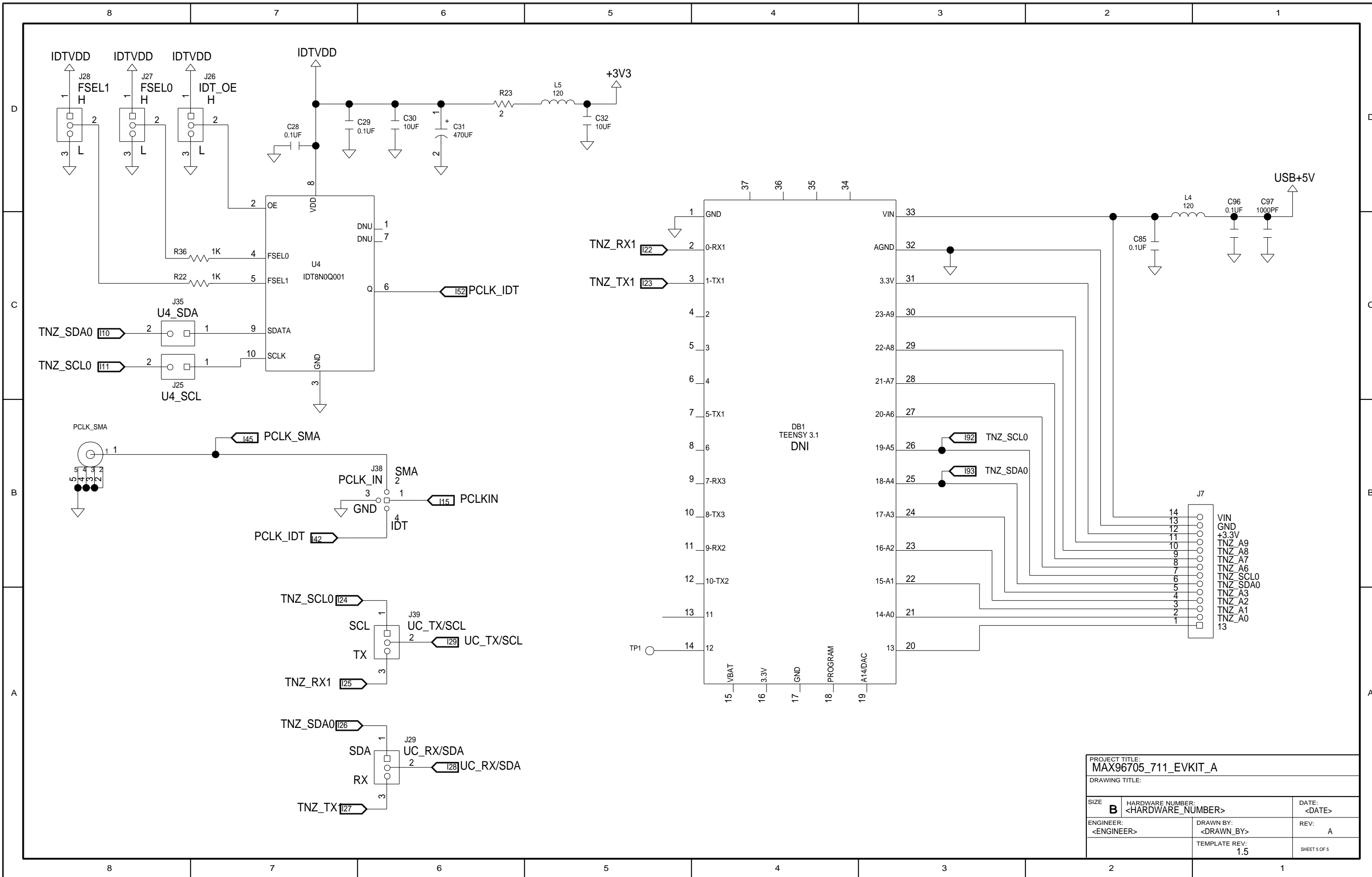

PROJECT TITLE: MAX96705_711_EVKIT_A		
DRAWING TITLE:		
SIZE <b>B</b>	HARDWARE NUMBER: <HARDWARE_NUMBER>	DATE: <DATE>
ENGINEER: <ENGINEER>	DRAWN BY: <DRAWN_BY>	REV: A
TEMPLATE REV: 1.5		SHEET 5 OF 5



This document contains information considered proprietary, and shall not be reproduced wholly or in part, nor disclosed to others without specific written permission.

HARDWARE NAME: MAX96705\_711\_EVKIT\_A

HARDWARE NUMBER:

ENGINEER:

DESIGNER:

DATE: 07/29/2015

ODB++/GERBER: SILK\_TOP

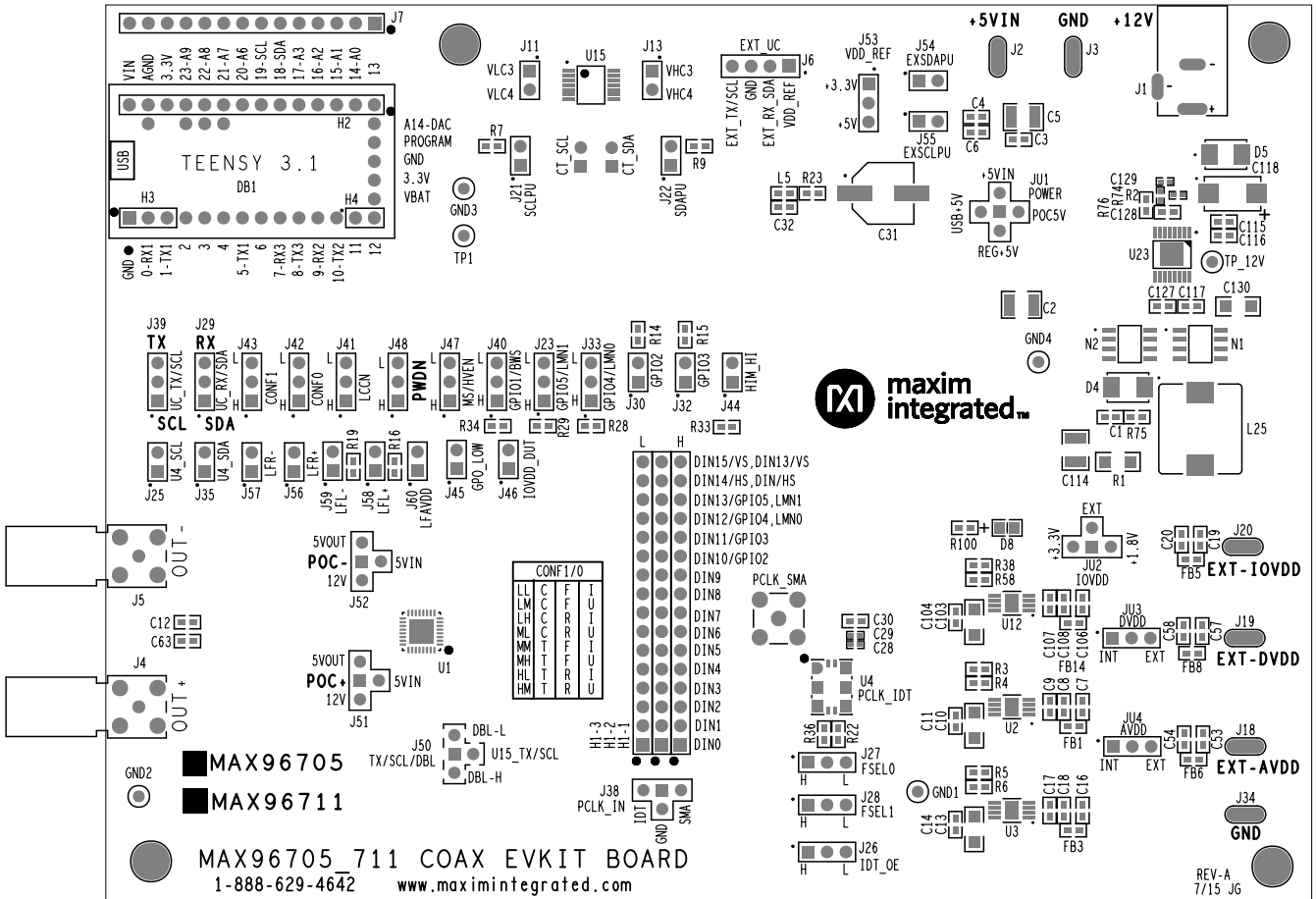



This document contains information considered proprietary, and shall not be reproduced wholly or in part, nor disclosed to others without specific written permission.

HARDWARE NAME: MAX96705\_711\_EVKIT\_A

HARDWARE NUMBER:

ENGINEER:

DESIGNER:

DATE: 07/29/2015

ODB++/GERBER: TOP

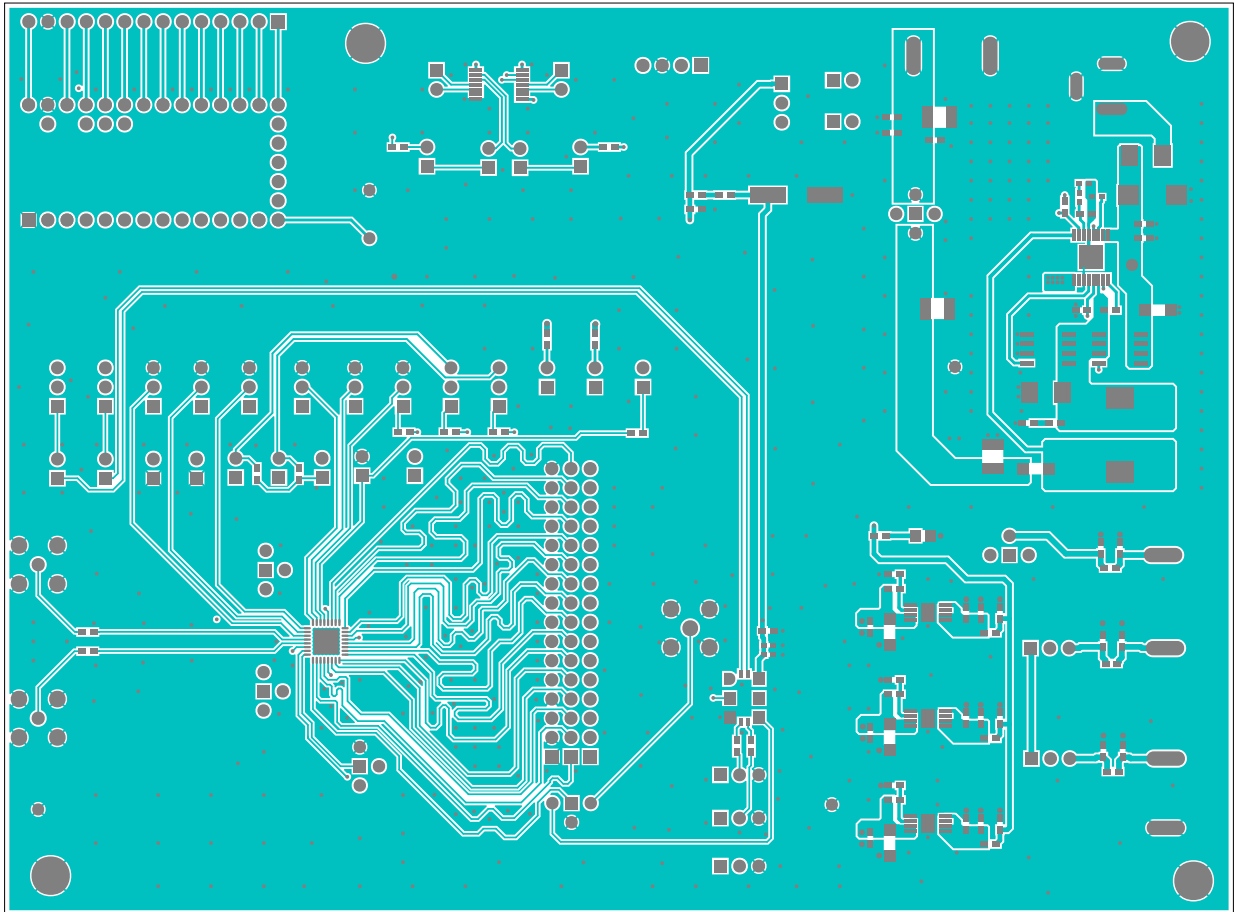





This document contains information considered proprietary, and shall not be reproduced wholly or in part, nor disclosed to others without specific written permission.

HARDWARE NAME: MAX96705\_711\_EVKIT\_A

HARDWARE NUMBER:

ENGINEER: DESIGNER:

DATE: 07/29/2015

ODB++/GERBER: **INNER\_LAYER2**

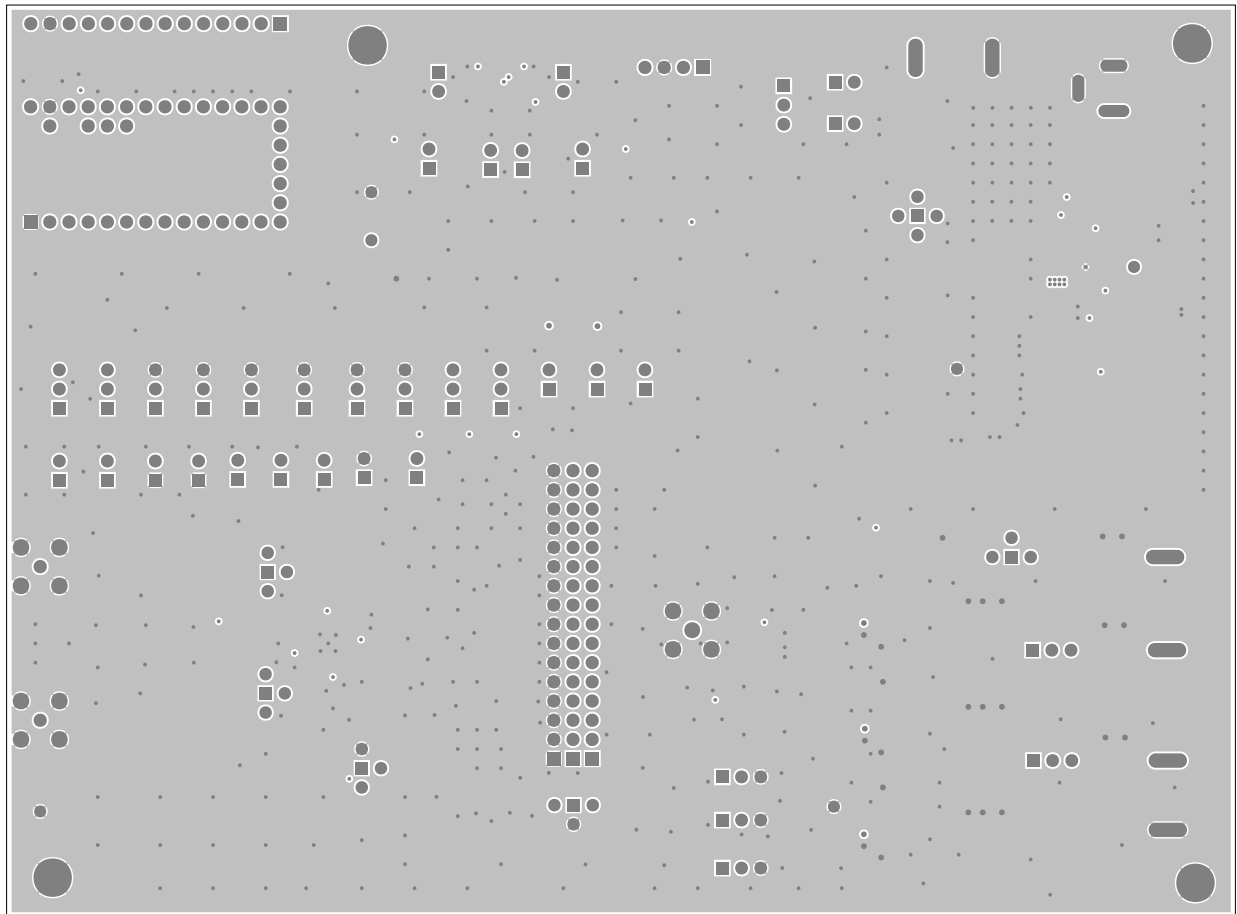



This document contains information considered proprietary, and shall not be reproduced wholly or in part, nor disclosed to others without specific written permission.

HARDWARE NAME: MAX96705\_711\_EVKIT\_A

HARDWARE NUMBER:

ENGINEER:

DESIGNER:

DATE: 07/29/2015

ODB++/GERBER: **INNER\_LAYER3**

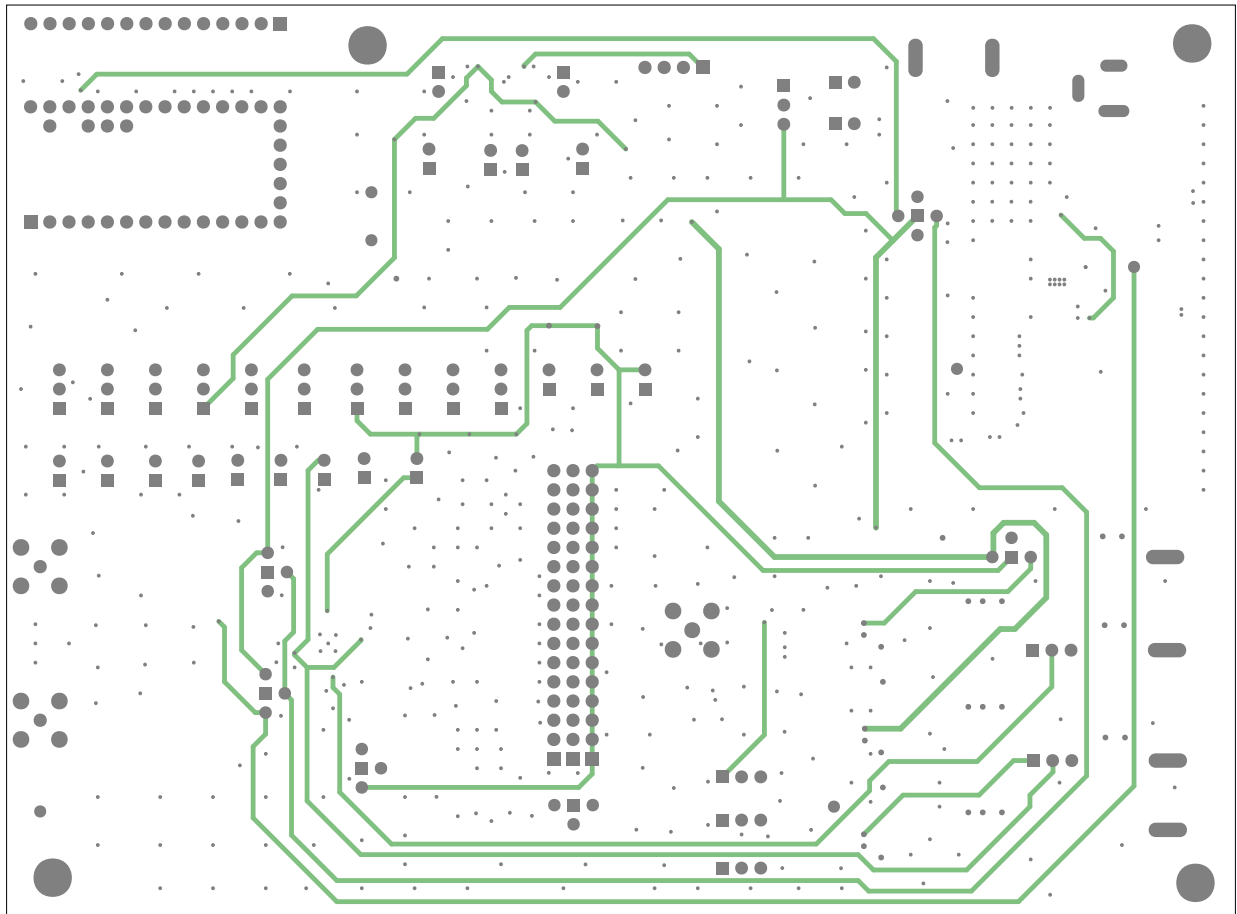



This document contains information considered proprietary, and shall not be reproduced wholly or in part, nor disclosed to others without specific written permission.

HARDWARE NAME: MAX96705\_711\_EVKIT\_A

HARDWARE NUMBER:

ENGINEER:

DESIGNER:

DATE: 07/29/2015

ODB++/GERBER: **BOTTOM**

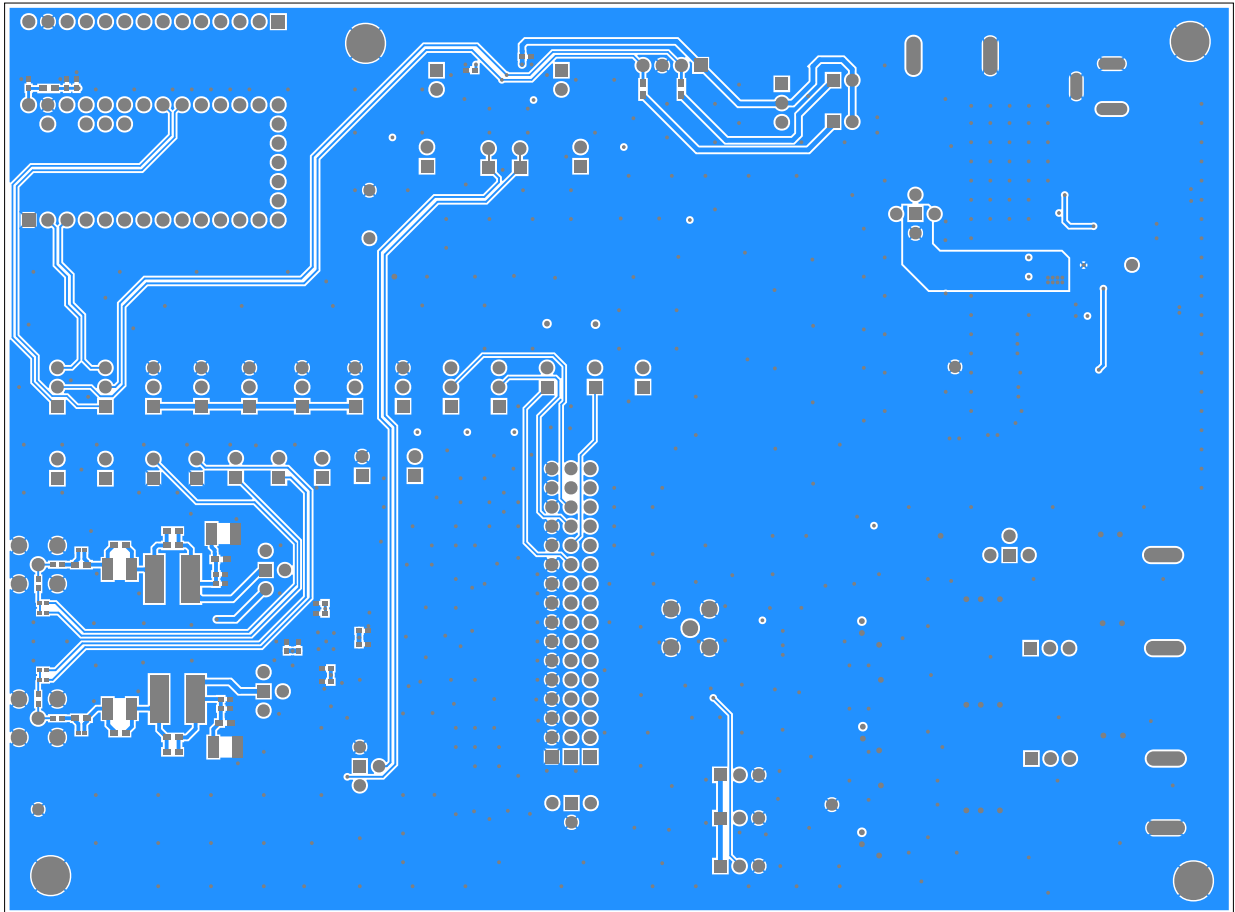



This document contains information considered proprietary, and shall not be reproduced wholly or in part, nor disclosed to others without specific written permission.

HARDWARE NAME: MAX96705\_711\_EVKIT\_A

HARDWARE NUMBER:

ENGINEER:

DESIGNER:

DATE: 07/29/2015

ODB++/GERBER: SILK\_BOT

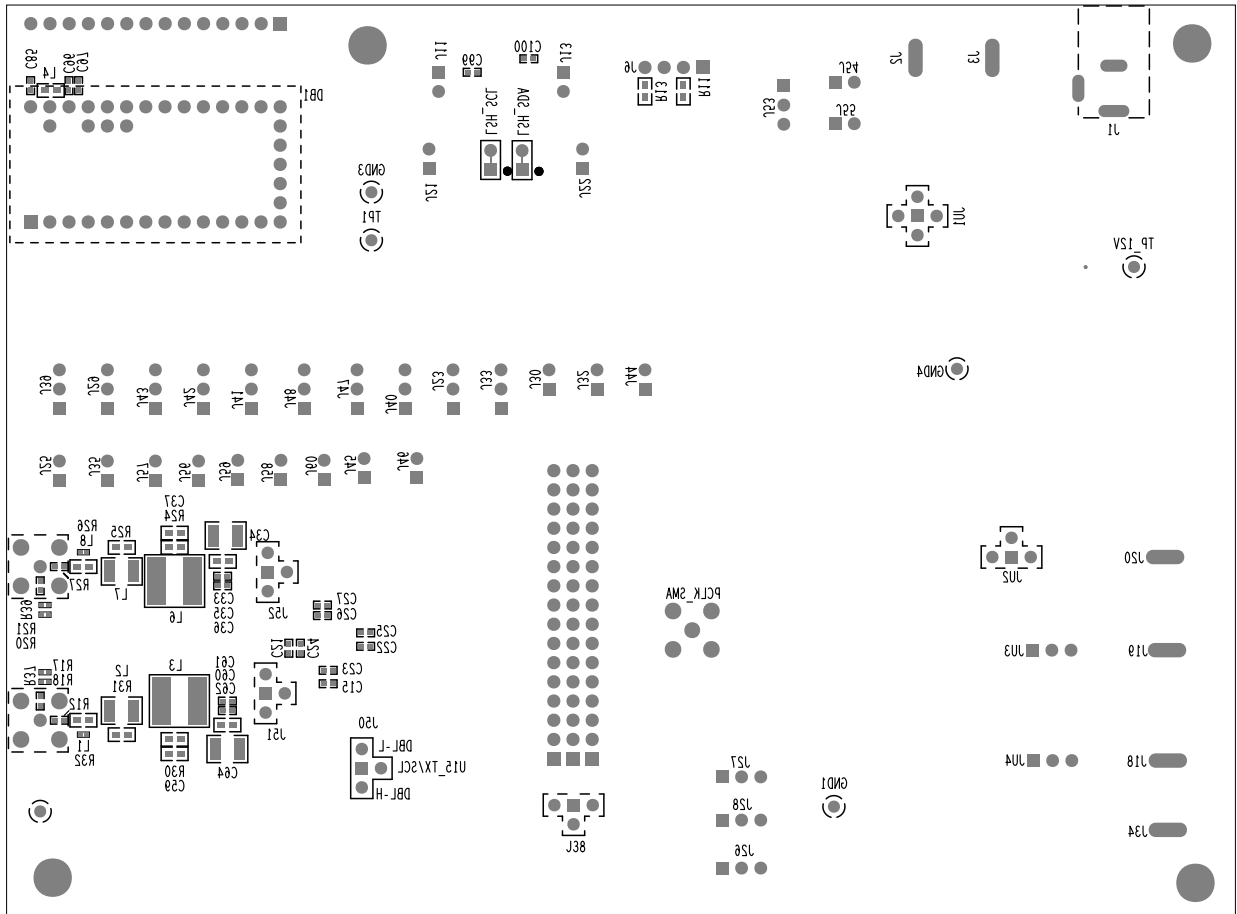

Компания «Океан Электроники» предлагает заключение долгосрочных отношений при поставках импортных электронных компонентов на взаимовыгодных условиях!

Наши преимущества:

- Поставка оригинальных импортных электронных компонентов напрямую с производств Америки, Европы и Азии, а так же с крупнейших складов мира;
- Широкая линейка поставок активных и пассивных импортных электронных компонентов (более 30 млн. наименований);
- Поставка сложных, дефицитных, либо снятых с производства позиций;
- Оперативные сроки поставки под заказ (от 5 рабочих дней);
- Экспресс доставка в любую точку России;
- Помощь Конструкторского Отдела и консультации квалифицированных инженеров;
- Техническая поддержка проекта, помощь в подборе аналогов, поставка прототипов;
- Поставка электронных компонентов под контролем ВП;
- Система менеджмента качества сертифицирована по Международному стандарту ISO 9001;
- При необходимости вся продукция военного и аэрокосмического назначения проходит испытания и сертификацию в лаборатории (по согласованию с заказчиком);
- Поставка специализированных компонентов военного и аэрокосмического уровня качества (Xilinx, Altera, Analog Devices, Intersil, Interpoint, Microsemi, Actel, Aeroflex, Peregrine, VPT, Syfer, Eurofarad, Texas Instruments, MS Kennedy, Miteq, Cobham, E2V, MA-COM, Hittite, Mini-Circuits, General Dynamics и др.);

Компания «Океан Электроники» является официальным дистрибьютором и эксклюзивным представителем в России одного из крупнейших производителей разъемов военного и аэрокосмического назначения «JONHON», а так же официальным дистрибьютором и эксклюзивным представителем в России производителя высокотехнологичных и надежных решений для передачи СВЧ сигналов «FORSTAR».



## JONHON

«JONHON» (основан в 1970 г.)

Разъемы специального, военного и аэрокосмического назначения:

(Применяются в военной, авиационной, аэрокосмической, морской, железнодорожной, горно- и нефтедобывающей отраслях промышленности)

«FORSTAR» (основан в 1998 г.)

ВЧ соединители, коаксиальные кабели, кабельные сборки и микроволновые компоненты:

(Применяются в телекоммуникациях гражданского и специального назначения, в средствах связи, РЛС, а так же военной, авиационной и аэрокосмической отраслях промышленности).



Телефон: 8 (812) 309-75-97 (многоканальный)

Факс: 8 (812) 320-03-32

Электронная почта: [ocean@oceanchips.ru](mailto:ocean@oceanchips.ru)

Web: <http://oceanchips.ru/>

Адрес: 198099, г. Санкт-Петербург, ул. Калинина, д. 2, корп. 4, лит. А