

1 x 45 W class D digital input automotive power amplifier with I_{Load} current monitoring, wide voltage operation range for car audio and telematic

Datasheet - production data

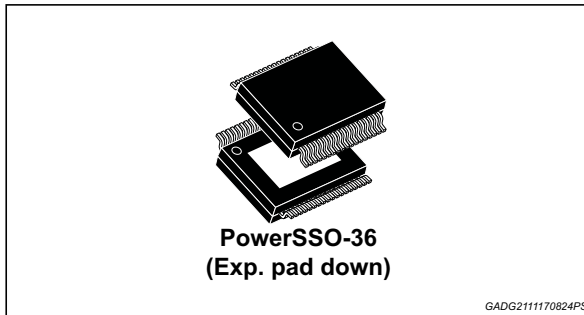

Features



- AEC-Q100 qualified
- Integrated 108 dB D/A conversion
- I²S and TDM digital input (4/8/16CH TDM)
- Input sampling frequency: 44.1 kHz, 48 kHz, 96 kHz, 192 kHz
- Full I²C bus driving (3.3/1.8 V)
- CISPR 25 - Class V (Fourth edition)
- Very low quiescent current
- Output lowpass filter included in the feedback allowing outstanding audio performances
- Wide operating supply range from 3.3 to 18 V, suitable for car radio, telematics and e-call
- MOSFET power outputs allowing high output power capability
 - 1 x 25 W /4 Ω @ 14.4 V, 1 kHz THD = 1%
 - 1 x 30 W /4 Ω @ 14.4 V, 1 kHz THD = 10%

- 2 Ω loads driving
- Power limiting function (configurable through I²C)
- I²C bus diagnostics:
 - Short to V_{CC}/GND
 - Short load and open load detection (also in play mode)
 - Four thermal warnings
- DC offset detector (also in play) and 'hot spot' detection
- Clipping detector
- Integrated thermal protection
- Legacy mode ('no I²C' mode), 4 configurable settings
- Short circuit and ESD integrated protections
- Package: PowerSSO-36 exposed pad down

Table 1. Device summary

Order code	Package	Packing
FDA903D-EHT	PowerSSO-36	Tape & reel
FDA903D-EHX	(exposed pad down)	Tube

Contents

1	Description	8
2	Block diagram	9
3	Pins description	10
4	Application diagram	12
5	Electrical specifications	13
	5.1 Absolute maximum ratings	13
	5.2 Thermal data	13
	5.3 Electrical characteristics	14
	5.4 Typical curves of the main electrical parameters	17
6	General information	23
	6.1 LC filter design	23
	6.2 Load possibilities	23
7	Finite state machine	24
	7.1 Device state and address selection	25
	7.2 Standby state	26
	7.3 Diagnostic Vcc-Gnd state	26
	7.4 ECO-mode state	26
	7.5 MUTE-PLAY and diagnostic states	27
	7.6 Operation compatibility vs battery	28
8	Muting function architecture	29
	8.1 Command dependence	29
	8.2 Analog-Mute	30
	8.3 Digital-Mute	30
	8.4 Mixed mute advantages	31
9	Hardware mute pin	33
10	Power limiter function	34

10.1	Power limiter control	35
11	Diagnostic	36
11.1	DC diagnostic	36
11.1.1	Diagnostic control	36
11.1.2	Relation with short circuit protection activation	37
11.1.3	Load range	37
11.2	Short to Vcc / GND diagnostic	38
11.3	Diagnostic time-line diagrams	38
11.4	Open load in play detector	41
11.4.1	Open load in play detector operation overview	41
11.4.2	Processing bandwidth range	41
11.4.3	Audio signal evaluation	42
11.4.4	Impedance threshold	42
11.4.5	I ² C control and timing	43
11.5	Input offset detector	43
11.6	Output voltage offset detector	44
11.7	Output current offset detector	45
11.7.1	Output current offset detector operation principle	45
11.7.2	Result communication and I ² C control	45
11.7.3	Hot spot detection	45
11.8	PWM pulse skipping detector	46
11.9	Thermal protection	47
11.10	Watch-dog	48
11.11	Error frame check	48
12	Additional features	49
12.1	AM operation mode	49
12.2	Noise gating	50
12.3	Dither PWM	50
12.4	Real time load current monitoring	51
12.4.1	Result communication and I ² C control	51
12.4.2	Current sensing limitations	52
13	I²S bus interface	53
13.1	I ² S standard mode description	54

13.2	TDM 4CH mode description	54
13.3	TDM 8CH mode description	55
13.4	TDM 16CH mode description	56
13.5	Timing requirements	57
13.6	Group delay	58
14	I²C bus interface	59
14.1	Writing procedure	60
14.2	Reading procedure	60
14.3	Data validity	61
14.4	Start and stop conditions	61
14.5	Byte format	61
14.6	Acknowledge	61
14.7	I ² C timing	62
14.8	I ² S, I ² C and Enable relationship	63
15	I²C register	64
15.1	Instruction bytes- "100xxxxx"	64
15.2	Data bytes - "101xxxxx"	73
16	Package information	77
16.1	PowerSSO-36 (exposed pad) package information	77
16.2	Package marking information	80
17	Revision history	81

List of tables

Table 1.	Device summary	1
Table 2.	Pins list function	10
Table 3.	Absolute maximum ratings	13
Table 4.	Thermal data - PowerSSO36 slug-down package	13
Table 5.	Electrical characteristics	14
Table 6.	Operation mode	25
Table 7.	Command dependence.	29
Table 8.	Power limiter function	34
Table 9.	Open load in play detector impedance and validity thresholds.	42
Table 10.	I ² S Interface timings	57
Table 11.	Group delay dependency from input sampling frequency.	58
Table 12.	I ² C bus interface timing.	62
Table 13.	IB0-ADDR: "I0000000"	64
Table 14.	IB1-ADDR: "I0000001"	65
Table 15.	IB2-ADDR: "I0000010"	66
Table 16.	IB3-ADDR: "I0000011"	67
Table 17.	IB4-ADDR: "I0000100" - CDDiag pin configuration.	67
Table 18.	IB5-ADDR: "I0000101" - CDDiag pin configuration.	68
Table 19.	IB6-ADDR: "I0000110"	68
Table 20.	IB7-ADDR: "I0000111"	69
Table 21.	IB8-ADDR: "I0001000" - CHANNEL CONTROLS	70
Table 22.	IB9-ADDR: "I0001001"	70
Table 23.	IB10-ADDR: "I0001010"	71
Table 24.	IB11-ADDR: "I0001011"	71
Table 25.	IB12-ADDR: "I0001100"	71
Table 26.	IB13-ADDR: "I0001101"	72
Table 27.	IB14-ADDR: "I0001110"	72
Table 28.	DB0-ADDR: "I0100000"	73
Table 29.	DB1-ADDR: "I0100001"	74
Table 30.	DB2-ADDR: "I0100010"	74
Table 31.	DB3-ADDR: "I0100011" DC Diagnostic Error code	75
Table 32.	DB4-ADDR: "I0100100" - Current Sensing data (10-8)	75
Table 33.	DB5-ADDR: "I0100101" - Current Sensing data (7-0)	75
Table 34.	DB6-ADDR: "I0100110"	76
Table 35.	PowerSSO-36 exposed pad (D1 and E2 use the option variation B) package mechanical data	78
Table 36.	Document revision history.	81

List of figures

Figure 1.	Block diagram	9
Figure 2.	Pins connection diagram.	10
Figure 3.	Application diagram	12
Figure 4.	Efficiency and power dissipation ($V_S = 14.4\text{ V}$, $R_L = 1 \times 4\ \Omega$, $f = 1\text{ kHz sine wave}$)	17
Figure 5.	Efficiency and power dissipation ($V_S = 14.4\text{ V}$, $R_L = 1 \times 4\ \Omega$, $f = 1\text{ kHz pink noise}$)	17
Figure 6.	Efficiency and power dissipation ($V_S = 14.4\text{ V}$, $R_L = 1 \times 2\ \Omega$, $f = 1\text{ kHz sine wave}$)	17
Figure 7.	Efficiency and power dissipation ($V_S = 14.4\text{ V}$, $R_L = 1 \times 2\ \Omega$, $f = 1\text{ kHz pink noise}$)	17
Figure 8.	Efficiency and power dissipation ($V_S = 14.4\text{ V}$, $R_L = 1 \times 8\ \Omega$, $f = 1\text{ kHz sine wave}$)	17
Figure 9.	Efficiency and power dissipation ($V_S = 14.4\text{ V}$, $R_L = 1 \times 8\ \Omega$, $f = 1\text{ kHz pink noise}$)	17
Figure 10.	Efficiency and power dissipation ($V_S = 18\text{ V}$, $R_L = 1 \times 4\ \Omega$, $f = 1\text{ kHz sine wave}$)	18
Figure 11.	Efficiency and power dissipation ($V_S = 18\text{ V}$, $R_L = 1 \times 4\ \Omega$, $f = 1\text{ kHz pink noise}$)	18
Figure 12.	Efficiency and power dissipation ($V_S = 16\text{ V}$, $R_L = 1 \times 2\ \Omega$, $f = 1\text{ kHz sine wave}$)	18
Figure 13.	Efficiency and power dissipation ($V_S = 16\text{ V}$, $R_L = 1 \times 2\ \Omega$, $f = 1\text{ kHz pink noise}$)	18
Figure 14.	Efficiency and power dissipation ($V_S = 18\text{ V}$, $R_L = 1 \times 8\ \Omega$, $f = 1\text{ kHz sine wave}$)	18
Figure 15.	Efficiency and power dissipation ($V_S = 18\text{ V}$, $R_L = 1 \times 8\ \Omega$, $f = 1\text{ kHz pink noise}$)	18
Figure 16.	Efficiency and power dissipation ($V_S = 3.3\text{ V}$, $R_L = 1 \times 4\ \Omega$, $f = 1\text{ kHz sine wave}$)	19
Figure 17.	Efficiency and power dissipation ($V_S = 3.3\text{ V}$, $R_L = 1 \times 4\ \Omega$, $f = 1\text{ kHz pink noise}$)	19
Figure 18.	Efficiency and power dissipation ($V_S = 3.3\text{ V}$, $R_L = 1 \times 2\ \Omega$, $f = 1\text{ kHz sine wave}$)	19
Figure 19.	Efficiency and power dissipation ($V_S = 3.3\text{ V}$, $R_L = 1 \times 2\ \Omega$, $f = 1\text{ kHz pink noise}$)	19
Figure 20.	Efficiency and power dissipation ($V_S = 3.3\text{ V}$, $R_L = 1 \times 8\ \Omega$, $f = 1\text{ kHz sine wave}$)	19
Figure 21.	Efficiency and power dissipation ($V_S = 3.3\text{ V}$, $R_L = 1 \times 8\ \Omega$, $f = 1\text{ kHz pink noise}$)	19
Figure 22.	Output power vs. supply voltage ($R_L = 4\ \Omega$, sine wave)	20
Figure 23.	Output power vs. supply voltage ($R_L = 2\ \Omega$, sine wave)	20
Figure 24.	Output power vs. supply voltage ($R_L = 8\ \Omega$, sine wave)	20
Figure 25.	THD vs. output power ($V_S = 14.4\text{ V}$, $R_L = 4\ \Omega$)	20
Figure 26.	THD vs. output power ($V_S = 14.4\text{ V}$, $R_L = 2\ \Omega$)	20
Figure 27.	THD vs. output power ($V_S = 14.4\text{ V}$, $R_L = 8\ \Omega$)	20
Figure 28.	THD vs. frequency ($V_S = 14.4\text{ V}$, $R_L = 4\ \Omega$, $P_O = 1\text{ W}$)	21
Figure 29.	THD vs. frequency ($V_S = 14.4\text{ V}$, $R_L = 2\ \Omega$, $P_O = 1\text{ W}$)	21
Figure 30.	THD vs. frequency ($V_S = 14.4\text{ V}$, $R_L = 8\ \Omega$, $P_O = 1\text{ W}$)	21
Figure 31.	Frequency response (1 W , $R_L = 4\ \Omega$, $f = 1\text{ kHz}$)	21
Figure 32.	Frequency response (1 W , $R_L = 2\ \Omega$, $f = 1\text{ kHz}$)	21
Figure 33.	Frequency response (1 W , $R_L = 8\ \Omega$, $f = 1\text{ kHz}$)	21
Figure 34.	PSRR vs. frequency	22
Figure 35.	Quiescent current vs. supply voltage	22
Figure 36.	Dynamic range	22
Figure 37.	FFT - Output spectrum (-60 dBFS input signal)	22
Figure 38.	Finite state machine diagram	24
Figure 39.	Operation vs. battery charge.	28
Figure 40.	Analog-Mute diagram	30
Figure 41.	Digital-Mute diagram.	31
Figure 42.	Mixed mute diagram	31
Figure 43.	Analog-Mute vs. Mixed-Mute	32
Figure 44.	HWMute pin schematic.	33
Figure 45.	Response obtained with a limitation corresponding to 80% of the full-scale	35
Figure 46.	Load range detection configured properly setting IB5 d7-d6	37
Figure 47.	DC diagnostic before turn on	38
Figure 48.	Short to VCC at device turn on	39

Figure 49.	DC Diagnostic in Mute	39
Figure 50.	Short circuit protection activation - Short to VCC	40
Figure 51.	Short Circuit Protection activation due to short across load, short to Vcc/Gnd not present	40
Figure 52.	Open load in play detector guaranteed thresholds with standard gain setting	42
Figure 53.	Open load in play detector guaranteed thresholds with low gain setting	42
Figure 54.	Open load in play detector timing	43
Figure 55.	Output voltage offset detector operation	44
Figure 56.	Current offset measurement	45
Figure 57.	Hot spot detection	46
Figure 58.	PWM pulse skipping detector operation	46
Figure 59.	Thermal attenuation curve	47
Figure 60.	PWM switching frequency selection	49
Figure 61.	LRF effect on PWM output	49
Figure 62.	Dither PWM effect on output PWM	50
Figure 63.	Current sensing path	51
Figure 64.	I ² S standard mode	54
Figure 65.	TDM4 mode	54
Figure 66.	TDM8 mode	55
Figure 67.	TDM16 mode	56
Figure 68.	I ² S Interface timings	57
Figure 69.	I ² S clock transition timings	57
Figure 70.	I ² C bus protocol description	59
Figure 71.	Reading procedure	60
Figure 72.	Without/with auto-increment reading procedure	61
Figure 73.	I ² C bus interface timing	62
Figure 74.	PowerSSO-36 (exposed pad) package outline	77
Figure 75.	PowerSSO-36 (exp. pad) marking information	80

1 Description

The FDA903D is a single bridge class D amplifier, designed in the most advanced BCD technology, intended for any automotive audio application (car radio, telematics and e-call, noise and tone generators, etc).

The FDA903D integrates a high performance D/A converter together with powerful MOSFET outputs in class D, so it is very compact and powerful, moreover reaches outstanding efficiency performances (90%).

It has a very wide operating range: it can be operated both with standard car battery levels (5.5-18 V operating, compatible to load dump pulse) and with external step-down generated voltages or emergency battery (since it is compatible to minimum 3.3 V operative).

The feedback loop is including the output L-C low-pass filter, allowing superior frequency response linearity and lower distortion.

FDA903D is configurable through I²C bus interface and is integrating a complete diagnostics array specially intended for automotive applications including innovative open load and DC offset detection in play mode.

Thanks to the solutions implemented to solve the EMI problems, the device is intended to be used in the standard single DIN car-radio box together with the tuner.

Moreover FDA903D features a configurable power limiting function, and can be optionally operated under no I²C mode ('legacy mode').

2 Block diagram

Figure 1. Block diagram

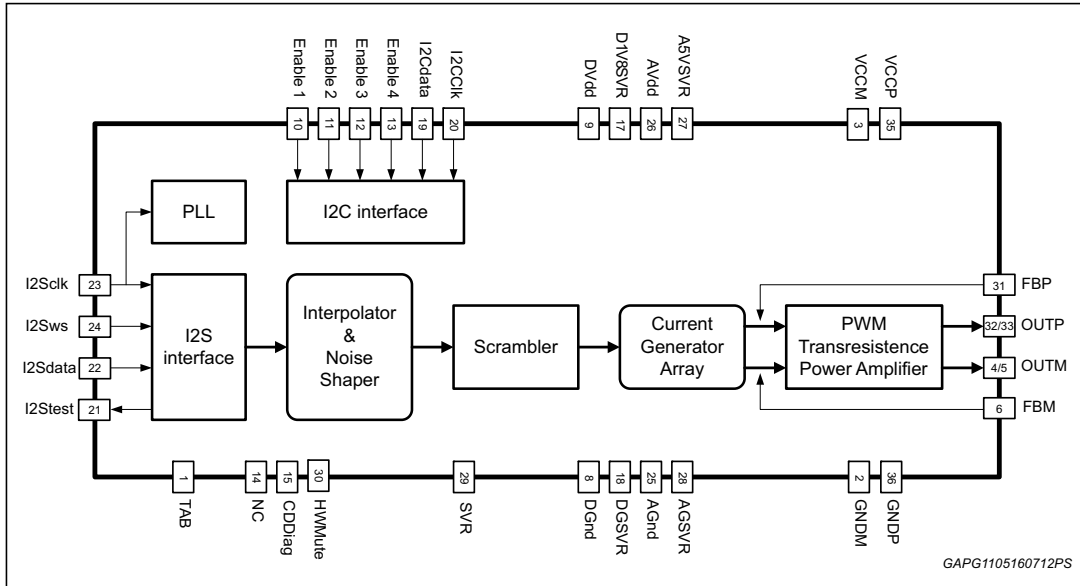

3 Pins description

Figure 2. Pins connection diagram

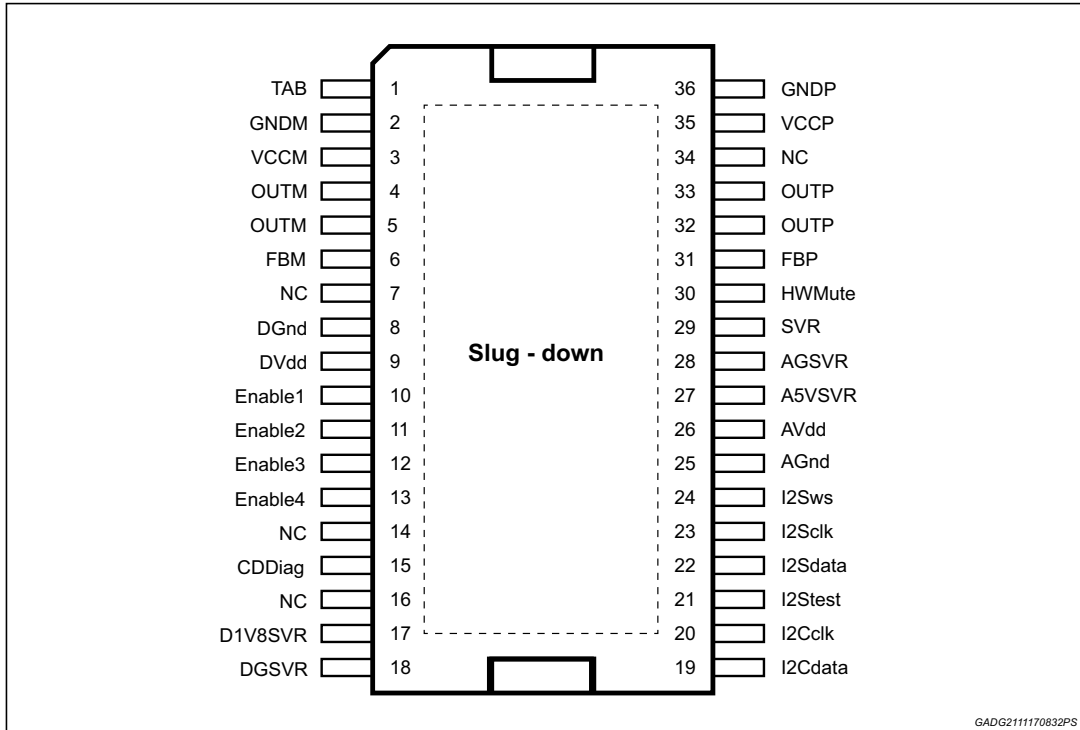

GADG2111170832PS

Table 2. Pins list function

Pin #	Pin name	Function
1	TAB	Device slug connection
2	GNDM	Channel half bridge minus, Power Ground
3	VCCM	Channel half bridge minus, Power Supply
4	OUTM	Channel half bridge minus, Output
5	OUTM	Channel half bridge minus, Output
6	FBM	Channel half bridge minus, Feedback
7	NC	Not connected
8	DGnd	Digital ground
9	DVdd	Digital supply
10	Enable1	Enable 1
11	Enable2	Enable 2
12	Enable3	Enable 3
13	Enable4	Enable 4
14	NC	Not connected
15	CDDiag	Clipping detector and diagnostic output pin

Table 2. Pins list function

Pin #	Pin name	Function
16	NC	Not connected
17	D1V8SVR	Positive digital supply V(SVR)+0.9V (Internally generated)
18	DGSVR	Negative digital supply V(SVR)-0.9V (Internally generated)
19	I2Cdata	I2C Data
20	I2Cclk	I2C Clock
21	I2Stest	test pin, left open
22	I2Sdata	I2S/TDM data
23	I2Sclk	I2S/TDM Clock input
24	I2Sws	I2S/TDM Sync input /Word Select input
25	AGnd	Analog ground
26	AVdd	Analog supply
27	A5VSVR	Positive Analog Supply V(SVR)+2.5V (Internally generated)
28	AGSVR	Negative Analog Supply V(SVR)-2.5V (Internally generated)
29	SVR	Supply Voltage Ripple Rejection Capacitor
30	HWMute	Hardware mute pin
31	FBP	Channel half bridge plus, Feedback
32	OUTP	Channel half bridge plus, Output
33	OUTP	Channel half bridge plus, Output
34	NC	Not connected
35	VCCP	Channel half bridge plus, Power Supply
36	GNDP	Channel half bridge plus, Power Ground

4 Application diagram

Figure 3. Application diagram

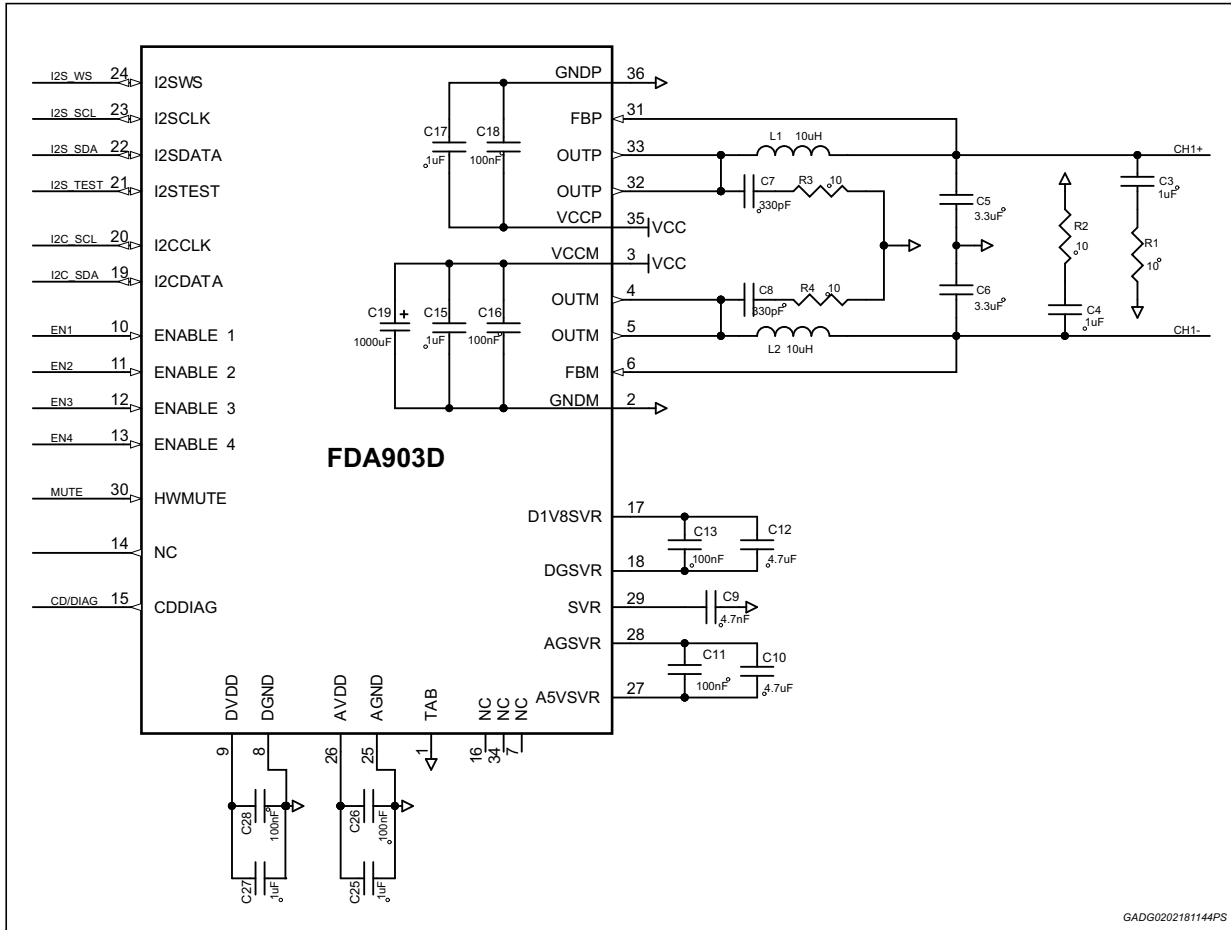

GADG0202181144PS

5 Electrical specifications

5.1 Absolute maximum ratings

Table 3. Absolute maximum ratings

Symbol	Parameter	Value	Unit
V_{CC} [V_{CCP} , V_{CCM} , A_{VDD} , D_{VDD}]	DC supply voltage	-0.3 to 28	V
	Transient supply voltage for $t = 100 \text{ ms}^{(1)}$	-0.3 to 40	V
GND_{max} [D_{GND} , A_{GND} , $GNDP$, $GNDM$]	Ground pin voltage difference	-0.3 to 0.3	V
I^2C_{data} , I^2C_{clk}	I^2C bus pins voltage	-0.3 to 5.5	V
I^2S_{test} , I^2S_{data} , I^2S_{clk} , I^2S_{ws}	I^2S bus pins voltage	-0.3 to 5.5	V
Enable _{1,2,3,4}	Enables	-0.3 to 5.5	V
HWMute	Hardware mute	-0.3 to 7	V
CDDiag	Clip detection	-0.3 to 5.5	V
I_o	Output current (repetitive $f > 10 \text{ Hz}$)	Internally limited	A
T_{amb}	Ambient operating temperature	-40 to 125	°C
T_{stg} , T_j	Storage and junction temperature	-55 to 150	°C
ESDHBM	ESD protection HBM	2000	V
ESDCDM	ESD protection CDM	500	V

1. $V_{CC} = 35 \text{ V}$ for $t < 400 \text{ ms}$ as per ISO16750-2 load dump with centralized load dump suppression.

5.2 Thermal data

Table 4. Thermal data - PowerSSO36 slug-down package

Symbol	Parameter	Value	Unit
$R_{th \text{ j-a-2s}}$	Thermal resistance junction-to-ambient (2s board)	56	°C/W
$R_{th \text{ j-a-2s2p}}$	Thermal resistance junction-to-ambient (2s2p board)	31	°C/W
$R_{th \text{ j-a-2s2pv}}$	Thermal resistance junction-to-ambient (2s2p+vias)	26	°C/W

5.3 Electrical characteristics

$V_{CC} = 14.4\text{ V}$; $R_L = 4\ \Omega$; $f = 1\text{ kHz}$; $T_{amb} = 25\text{ }^\circ\text{C}$; I²C defaults, unless otherwise specified. LC filter: $L = 10\ \mu\text{H}$, $C = 3.3\ \mu\text{F}$. PWM in In-phase modulation, feedback connected after the filter.

Table 5. Electrical characteristics

Symbol	Parameter	Test condition	Min	Typ	Max	Unit
V_{CC}	Supply voltage range	$R_L = 4\ \Omega$	3.3	-	18	V
		$R_L = 2\ \Omega$ ⁽¹⁾	3.3	-	16	
I_{VCC}	Quiescent current	Device in Standby	-	1	5	μA
		Device on (MUTE state)	-	35	-	mA
		ECO MODE	-	22	-	mA
V_{os}	Offset voltage	Mute & Play	-10	-	+10	mV
D_{VDD}	Digital supply voltage range	-	3.3	-	18	V
A_{VDD}	Analog supply voltage range	-	3.3	-	18	V
I_{op}	Overcurrent protection	IB11 D5-4 = 00	9.5	11	12.5	A
		IB11 D5-4 = 01	6.7	8	9.3	A
		IB11 D5-4 = 10	5	6	7	A
		IB11 D5-4 = 11	3	4	5	A
I_{AVDD}	Analog current	Device on (MUTE state)	-	9	20	mA
I_{DVDD}	Digital current	Device on (MUTE state)	-	13	20	mA
-	Overvoltage shutdown	Attenuation = 0.5 dB ⁽²⁾	18.5	19.5	20.5	V
V_{lowM}	V_{CC} low supply mute threshold	Attenuation <0.5 dB Low voltage mode (IB0D0=1)	2.7	2.9	3.3	V
		Attenuation <0.5 dB Standard mode (IB0D0=0)	4.5	4.7	5	V
V_{highM}	V_{CC} high voltage mute ⁽²⁾	-	18	18.9	20.3	V
$UVLO_{VCC}$	V_{CC} supply UVLO threshold	Standard mode (IB0D0=0)	4.4	4.6	4.8	V
		Low voltage mode (IB0D0=1)	2.55	2.7	2.85	V
T_{sh}	Thermal shutdown	-	165	175	185	$^\circ\text{C}$
T_{pl}	Thermal protection junction temperature	Attenuation = 0.5 dB	150	160	170	$^\circ\text{C}$
T_{w1}	Thermal warning junction temperature ⁽³⁾	-	-	Tpl-5	-	$^\circ\text{C}$
T_{w2}		-	-	Tpl-15	-	$^\circ\text{C}$
T_{w3}		-	-	Tpl-35	-	$^\circ\text{C}$
T_{w4}		-	-	Tpl-50	-	$^\circ\text{C}$

Table 5. Electrical characteristics (continued)

Symbol	Parameter	Test condition	Min	Typ	Max	Unit
Audio performances						
P _O	Output power	THD = 10 %	-	30	-	W
		THD = 1 %	-	25	-	W
		Max power; V _{CC} = 15.2 V	-	50	-	W
		R _L = 2 Ω THD = 10% ⁽¹⁾	-	55	-	W
		R _L = 2 Ω THD = 1% ⁽¹⁾	-	45	-	W
		R _L = 2 Ω, max power ⁽¹⁾	-	80	-	W
P _O	Output power	THD = 10% V _{CC} = 5 V	-	3.8	-	W
		THD = 10% V _{CC} = 3.3 V	-	1.6	-	W
PSRR	Power supply rejection ratio	f = 1 kHz; Vr = 1Vpk;	70	80	-	-
THD	Total harmonic distortion	P _O = 1 W, f = 1 kHz	-	0.01	0.05	%
Gain	Standard gain	at Amplitude = -10 dBFs	5.5	5.9	6.3	Vp
	Low gain ⁽⁴⁾		3.3	3.6	3.9	Vp
DR	Dynamic range	A-wtd and brickwall 20 kHz filter	102	107.5	-	dB
SNR	Signal to noise ratio	A-wtd and brickwall 20 kHz filter	107	112	-	dB
Eout1	Output noise	A-wtd and brickwall 20 kHz filter used, no output signal;	-	35	55	μV
Eout2	Output noise	CCIR 468 filtered	-	84	130	μV
ΔV _{OITU}	ITU Pop filter output voltage	Standby to Mute and Mute to Standby transition	-7.5	-	+7.5	mV
Mute						
V _{Mth} ⁽⁵⁾	Mute pin voltage threshold	Attenuation <0.5 dB, and digital mute disabled	2.3	-	-	V
		Attenuation ≥60 dB, and digital mute disabled	-	-	1	
I _M	Mute pin source current	-	9	11	13	μA
V _{Mcl}	Mute pin internal clamp voltage	-	5.5	6	6.5	V
I _{feed}	Peak current flowing in the feedback pins	Standby condition, all feedbacks forced to V _{CC} , output floating	-	110	130	μA
I²C bus interface						
f _{SCL}	Clock frequency	-	-	-	400	kHz
V _{IL}	I2C pins low voltage	-	-	-	0.8	V
V _{IH}	I2C pins high voltage	-	1.3	-	-	V
V _{OLMAX}	Maximum I2C data pin low voltage when current I _{sink} is sinked	I _{sink} = 4 mA	-	0.12	0.5	V
I _{LIMAX}	Maximum input leakage current	V = 3.6 V	-	-	1	μA

Table 5. Electrical characteristics (continued)

Symbol	Parameter	Test condition	Min	Typ	Max	Unit
I²S bus interface						
V _{IL-I2S}	I2S pins low voltage	-	-	-	0.8	V
I _L	Input logic current, low	V _I = 0 V	-	-	500	nA
V _{IH-I2S}	I2S pins high voltage	-	1.3	-	-	V
I _H	Input logic current, high	V _I = TBD	-	-	500	nA
Control pins characteristics						
V _{ENL}	Enable pins low voltage	-	-	-	0.9	V
V _{ENH}	Enable pins high voltage	-	2.4	-	-	V
Clipping and offset detector						
CD _{THD}	Clip det THD ⁽⁶⁾	THD @ 100 Hz with average V _{clipdet} = 2 V	5	7	9	%
CDSAT	Clip det sat. voltage	CD on; I _{CD} = 1 mA	-	150	300	mV
CD _{LK}	Clip det leakage current	CD pin at 3.6 V	-	-	15	μA
V _{offin}	Input DC offset detection threshold	Theshold at which an offset present at inputs is detected	-	-18	-	dB
V _{offout}	Output DC offset detection threshold ⁽⁷⁾	Input high pass filter disable	±1.4	±2	±2.6	V

1. If outphase modulation selected, slow slope configuration must be used (IB11,D3)
2. Parameter values based on bench measurements (guaranteed by correlation with overvoltage shutdown).
3. The thermal warnings are always in tracking.
4. When selecting the low gain, also the thresholds for "DC diagnostic" function and "Open load in play detector" function scale of the same factor with respect to standard gain configuration.
5. See [Chapter 8: Muting function architecture](#) for more details.
6. Guaranteed by correlation.
7. Measured at bench during product validation.

5.4 Typical curves of the main electrical parameters

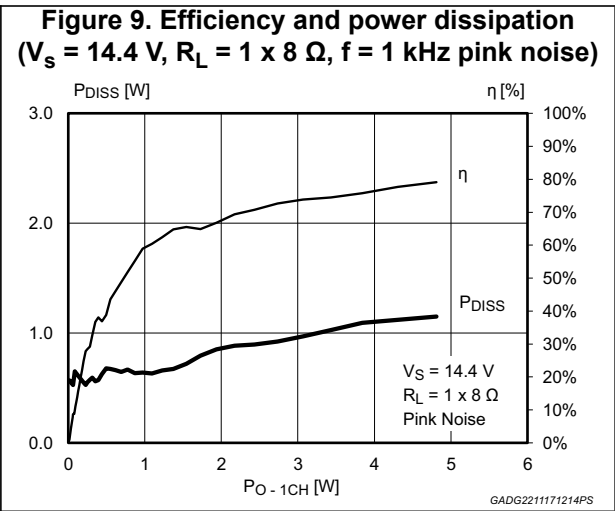
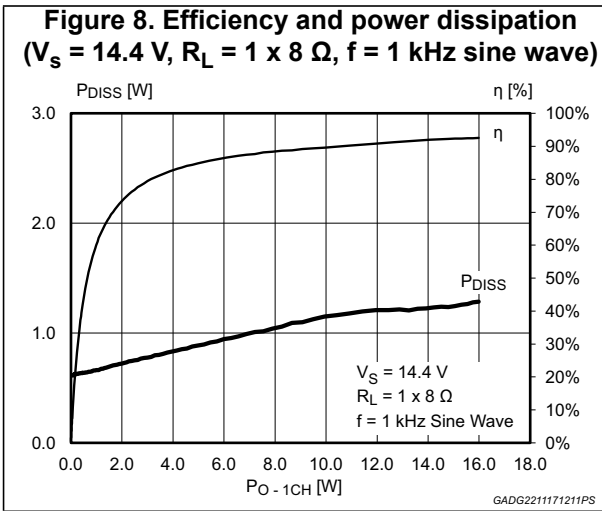
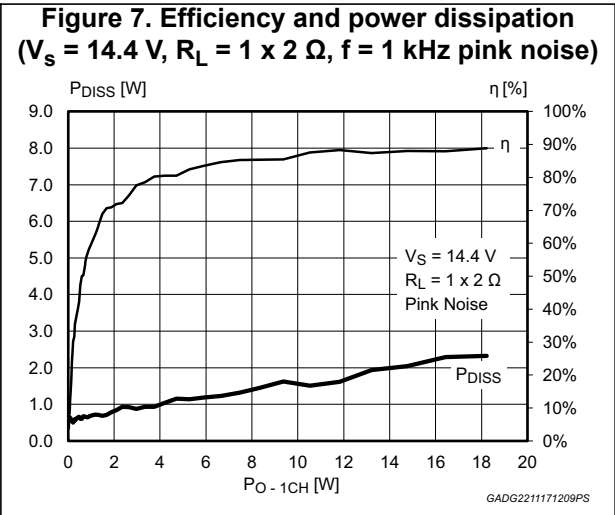
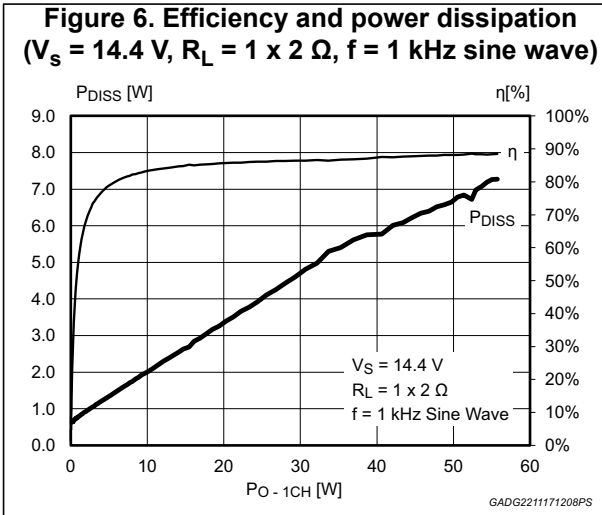
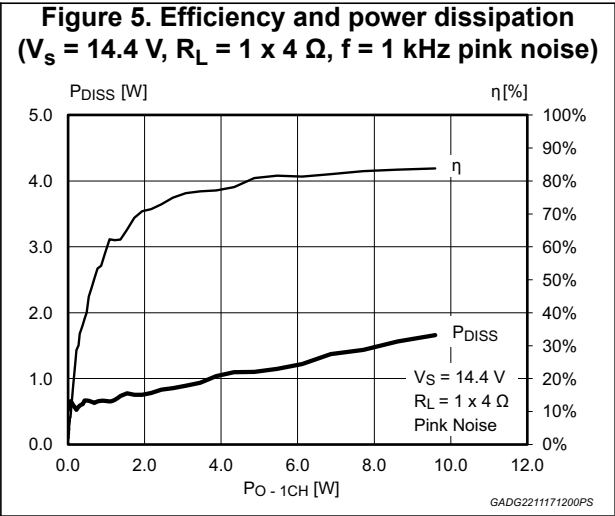
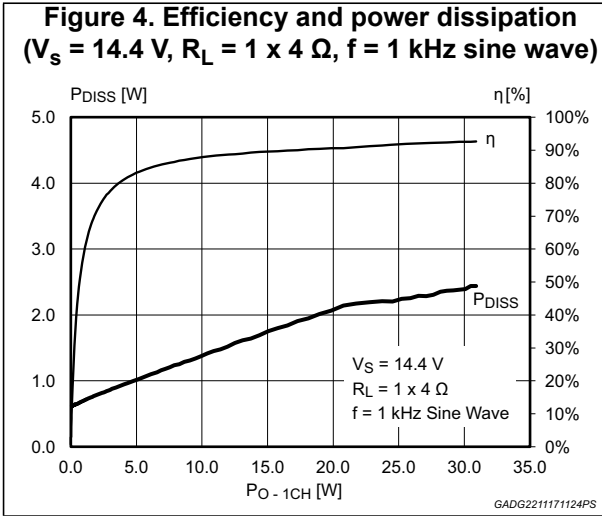
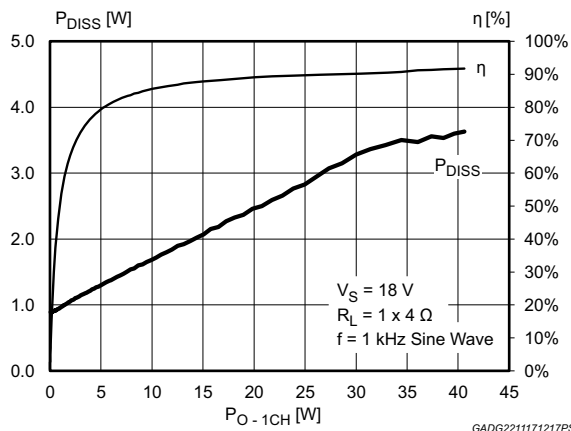
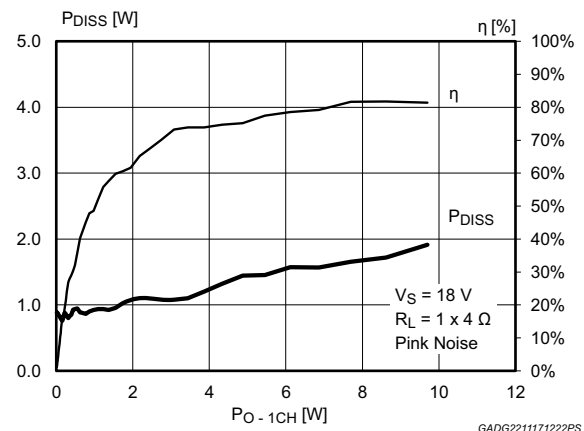

Figure 10. Efficiency and power dissipation ($V_S = 18\text{ V}$, $R_L = 1 \times 4\ \Omega$, $f = 1\text{ kHz}$ sine wave)



GADG2211171217PS

Figure 11. Efficiency and power dissipation ($V_S = 18\text{ V}$, $R_L = 1 \times 4\ \Omega$, $f = 1\text{ kHz}$ pink noise)



GADG2211171222PS

Figure 12. Efficiency and power dissipation ($V_S = 16\text{ V}$, $R_L = 1 \times 2\ \Omega$, $f = 1\text{ kHz}$ sine wave)

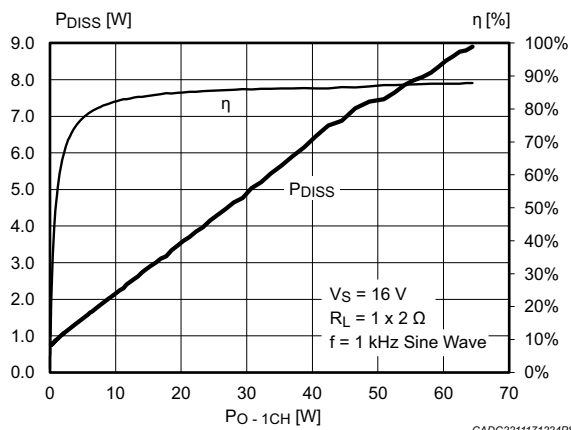

GADG2211171224PS

Figure 13. Efficiency and power dissipation ($V_S = 16\text{ V}$, $R_L = 1 \times 2\ \Omega$, $f = 1\text{ kHz}$ pink noise)

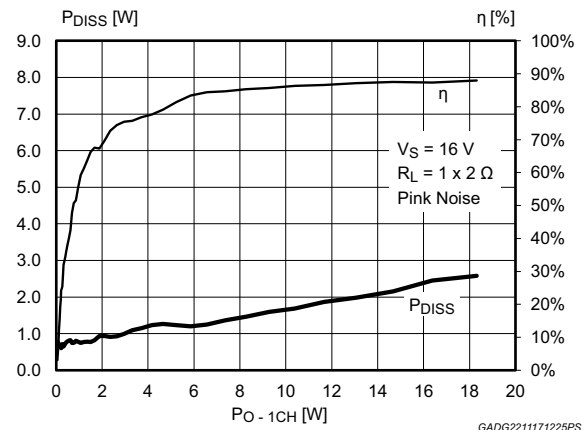

GADG2211171225PS

Figure 14. Efficiency and power dissipation ($V_S = 18\text{ V}$, $R_L = 1 \times 8\ \Omega$, $f = 1\text{ kHz}$ sine wave)

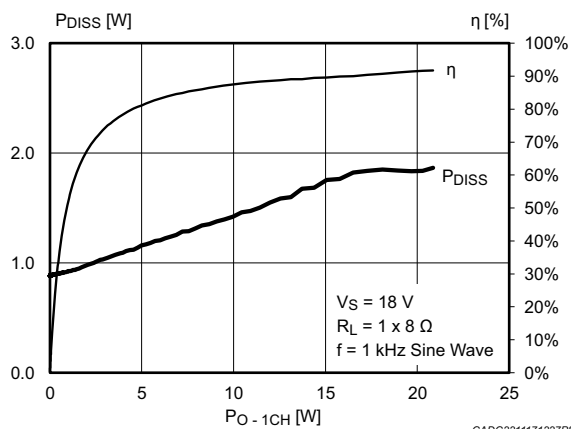

GADG2211171227PS

Figure 15. Efficiency and power dissipation ($V_S = 18\text{ V}$, $R_L = 1 \times 8\ \Omega$, $f = 1\text{ kHz}$ pink noise)

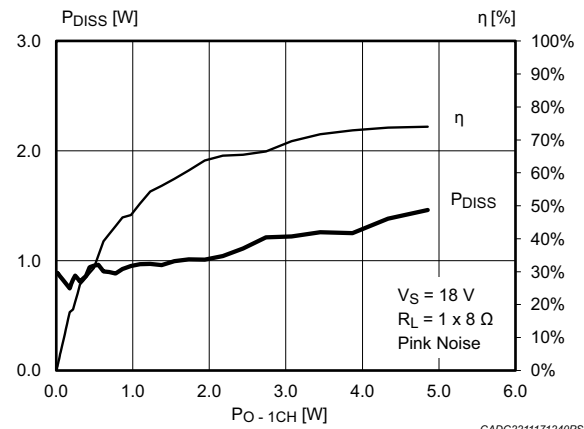

GADG2211171240PS

Figure 16. Efficiency and power dissipation ($V_S = 3.3\text{ V}$, $R_L = 1 \times 4\ \Omega$, $f = 1\text{ kHz}$ sine wave)

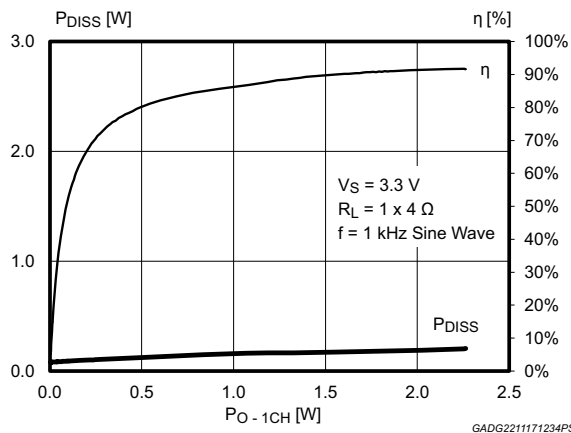

GADG2211171234PS

Figure 17. Efficiency and power dissipation ($V_S = 3.3\text{ V}$, $R_L = 1 \times 4\ \Omega$, $f = 1\text{ kHz}$ pink noise)

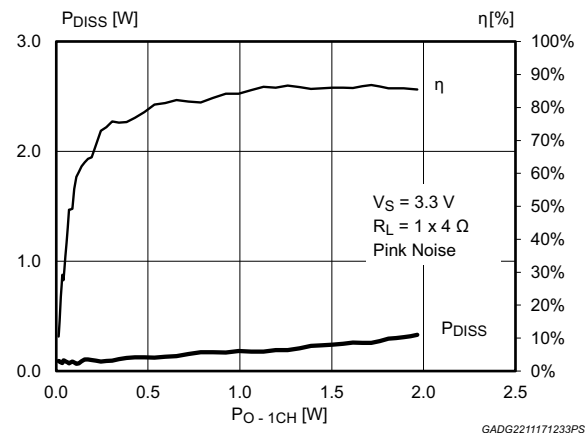

GADG2211171233PS

Figure 18. Efficiency and power dissipation ($V_S = 3.3\text{ V}$, $R_L = 1 \times 2\ \Omega$, $f = 1\text{ kHz}$ sine wave)

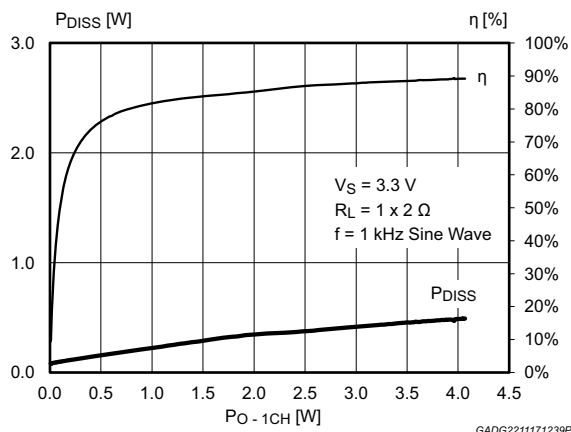

GADG2211171239PS

Figure 19. Efficiency and power dissipation ($V_S = 3.3\text{ V}$, $R_L = 1 \times 2\ \Omega$, $f = 1\text{ kHz}$ pink noise)

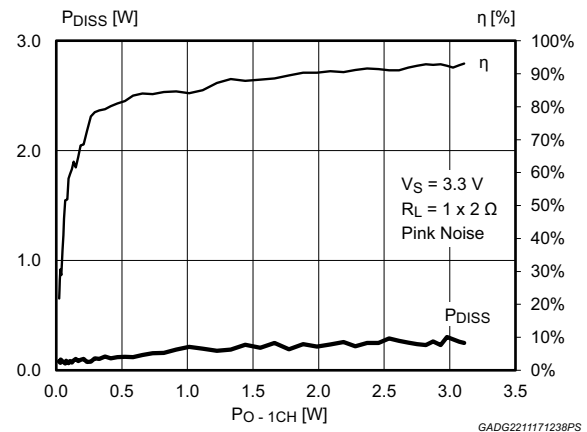

GADG2211171238PS

Figure 20. Efficiency and power dissipation ($V_S = 3.3\text{ V}$, $R_L = 1 \times 8\ \Omega$, $f = 1\text{ kHz}$ sine wave)

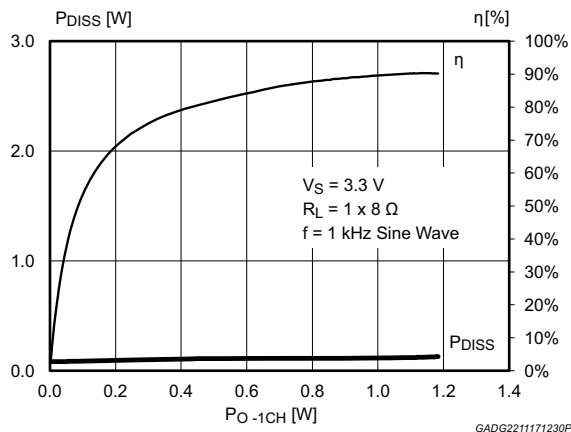

GADG2211171230PS

Figure 21. Efficiency and power dissipation ($V_S = 3.3\text{ V}$, $R_L = 1 \times 8\ \Omega$, $f = 1\text{ kHz}$ pink noise)

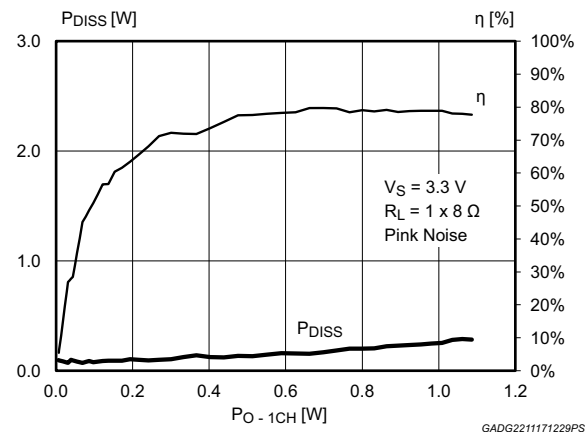

GADG2211171229PS

Figure 22. Output power vs. supply voltage
($R_L = 4 \Omega$, sine wave)

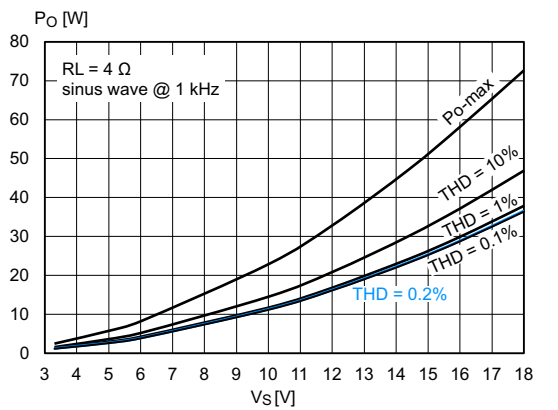

GADG2311171333PS

Figure 23. Output power vs. supply voltage
($R_L = 2 \Omega$, sine wave)

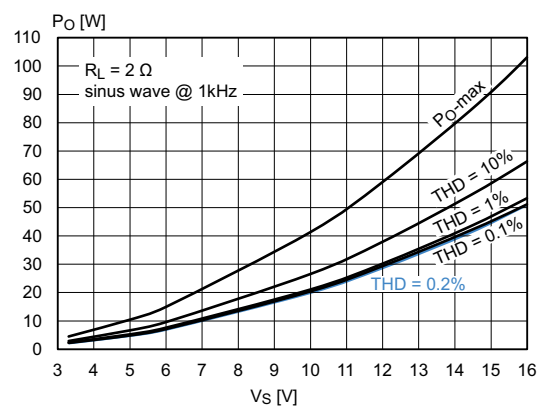

GADG2311171519PS

Figure 24. Output power vs. supply voltage
($R_L = 8 \Omega$, sine wave)

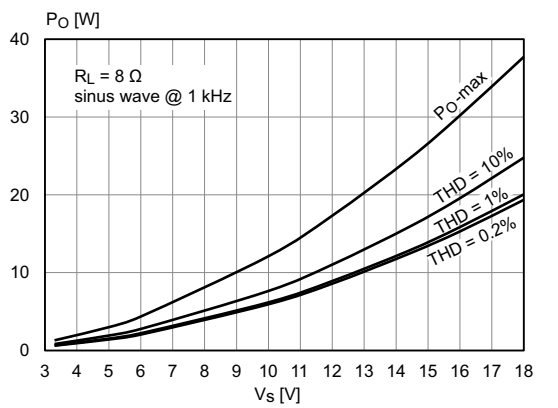

GADG2311171306PS

Figure 25. THD vs. output power
($V_S = 14.4 V$, $R_L = 4 \Omega$)

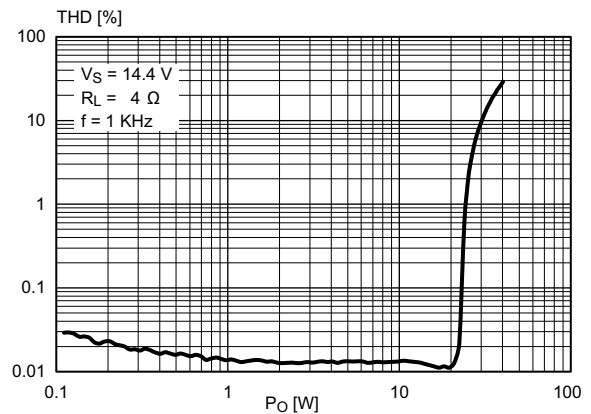

GADG2311171307PS

Figure 26. THD vs. output power
($V_S = 14.4 V$, $R_L = 2 \Omega$)

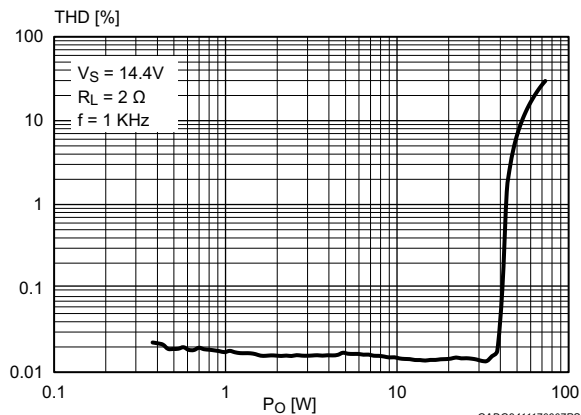

GADG2411170907PS

Figure 27. THD vs. output power
($V_S = 14.4 V$, $R_L = 8 \Omega$)

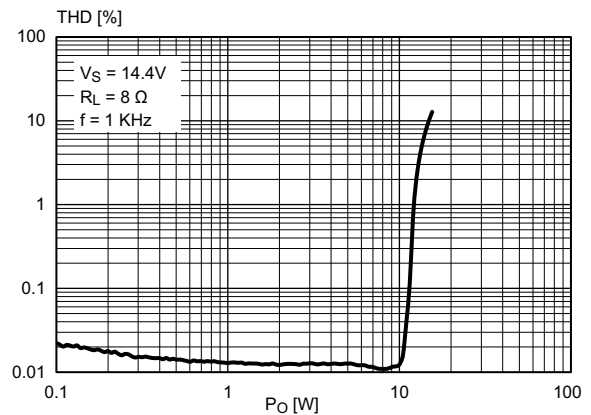

GADG0612171044PS

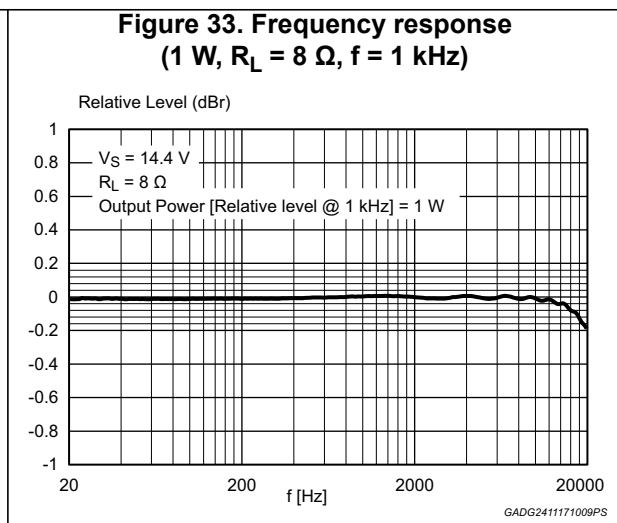
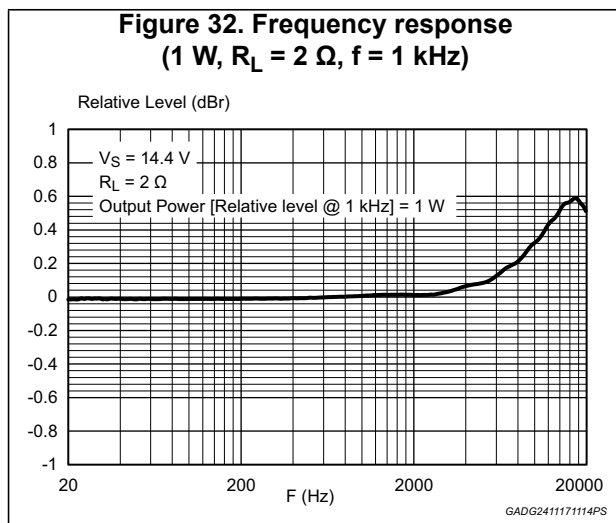
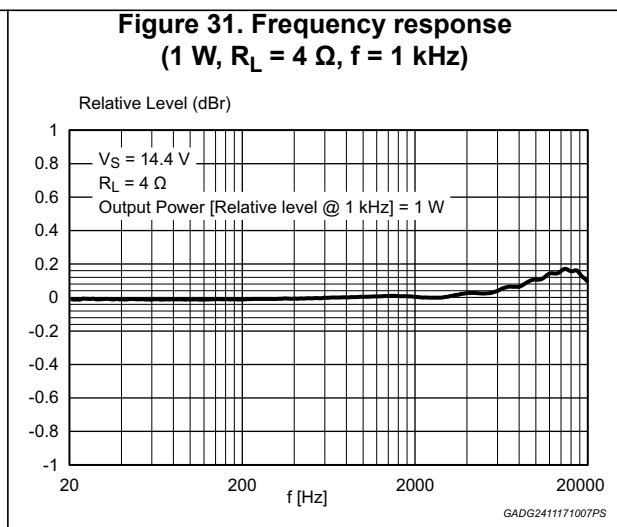
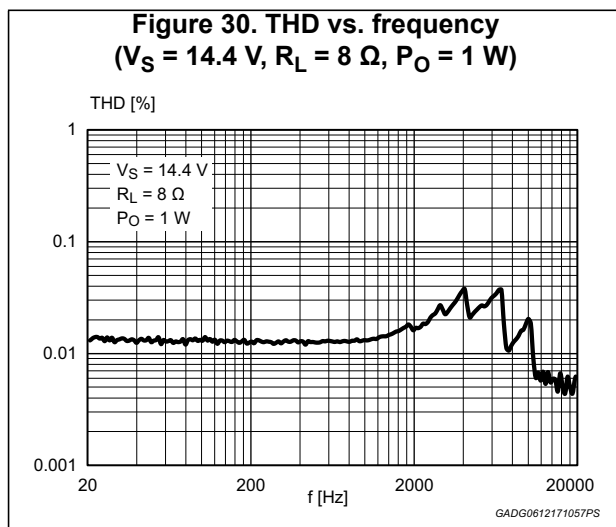
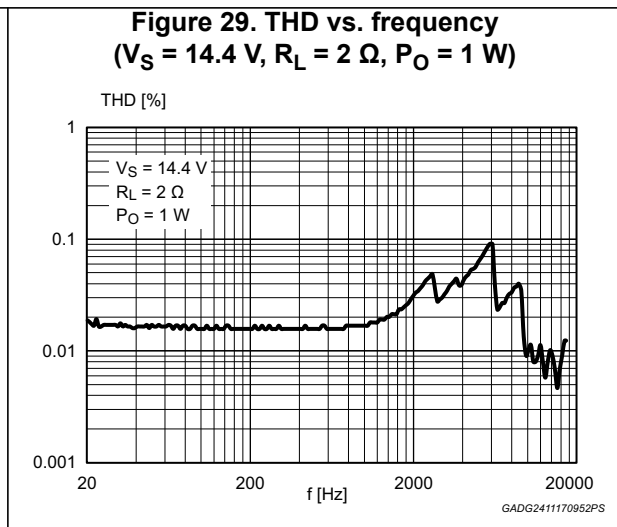
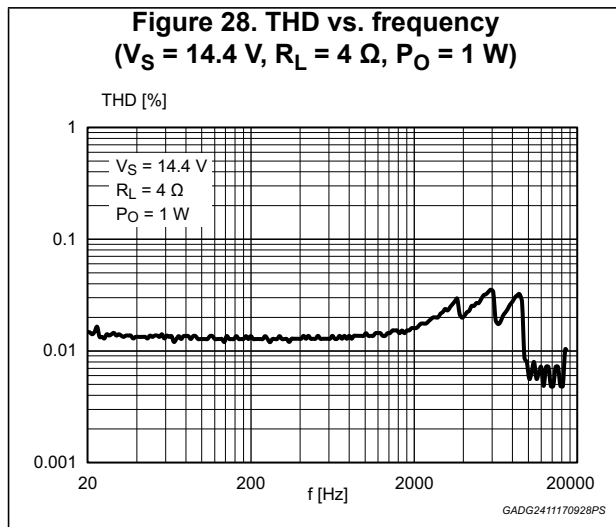

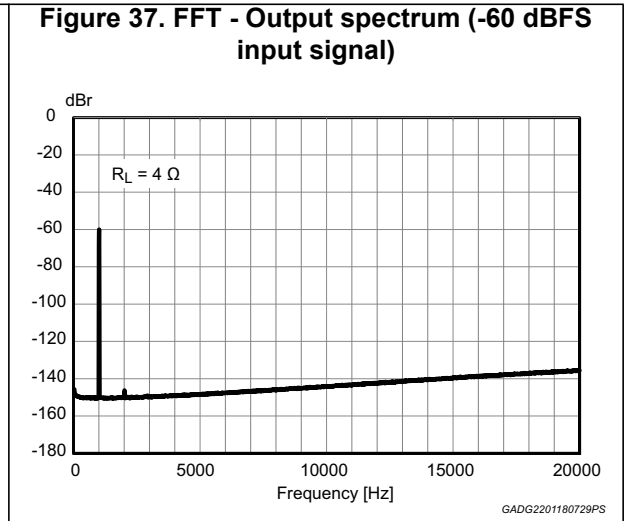
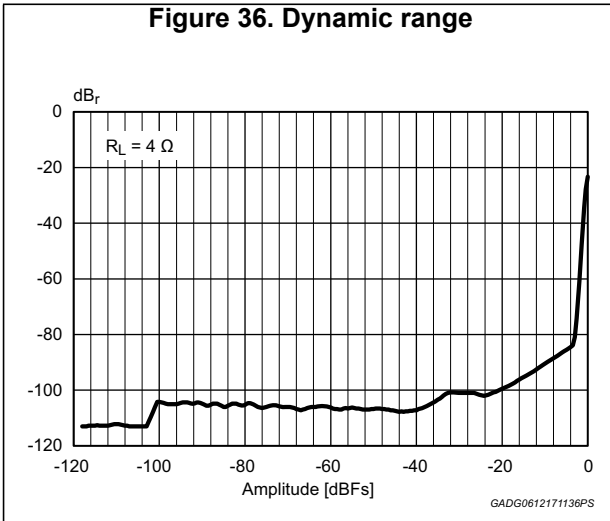
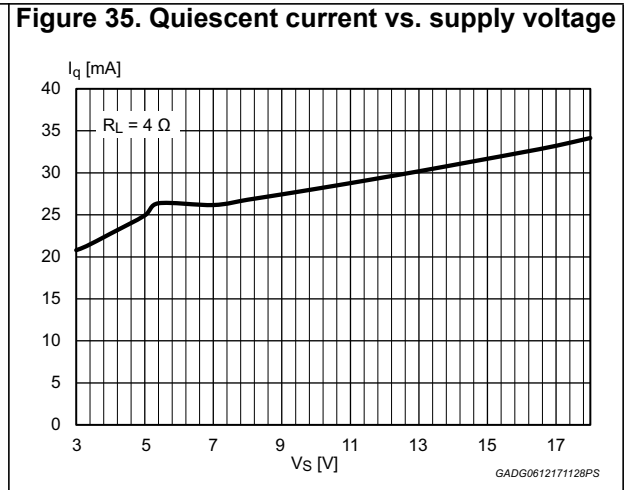
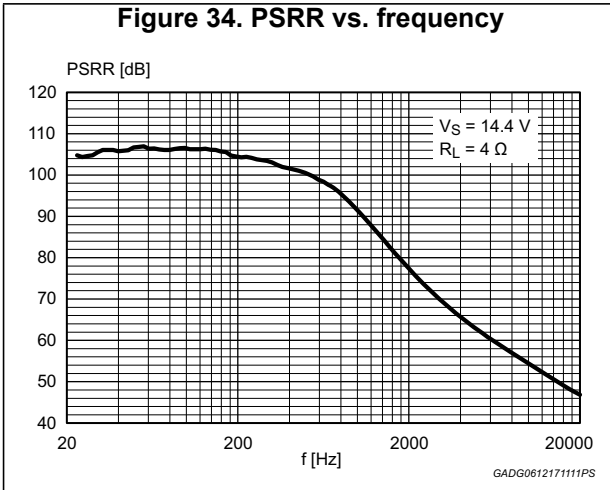

6 General information

6.1 LC filter design

The audio performance of a Class D amplifier are heavily influenced by the characteristics of the output LC filter. The choice of its components is quite critical because a lot of constraints have to be fulfilled at the same time: size, cost, filter for EMI suppression, efficiency. In particular, both the inductor and the capacitor exhibit a non linear behavior: the value of the inductance is a function of the instantaneous current in it and similarly the value of the capacitor is a function of the voltage across it.

In the classical approach, where the feedback loop is closed right at the output of the power stage, the LC filter is placed outside the loop and these nonlinearities cause the Total Harmonic Distortion (THD) to increase. The only way to avoid this phenomenon would be to use components which are highly linear, but this means they are also bigger and/or more expensive.

Furthermore, when the LC filter is outside the loop, its frequency response heavily depends on the impedance of the loudspeaker; this is one of the most critical aspects of Class-D amplifiers. In standard class D this can be mitigated, but not solved, by means of additional damping networks, increasing cost, space and power dissipation. FDA903D, instead, provides a very flat frequency response over audio-band which can not be achieved by standard class D without feedback after LC filter.

Since the demodulator group is now in the feedback path, some constraints regarding the inductor and capacitor choice are still present but of course less stringent than in the case of a typical switching application.

Moreover FDA903D can be used with the 'classical' configuration of feedback on output (before LC filter), through I²C configuration, allowing the maximum flexibility. The choice depends mainly on EMI target /requirements and could slightly affect other performances (like damping factor, or THD).

6.2 Load possibilities

FDA903D supports several load possibilities, driving 2 Ω , 4 Ω and higher ohmic loads.

Possible channel configurations are:

- 1 x 4 ohm (or higher) (up to 18 V)
- 1 x 2 ohm (up to 16 V)

7 Finite state machine

FDA903D has a finite state machine which manages amplifier functionality, reacting to user and system inputs

Figure 38. Finite state machine diagram

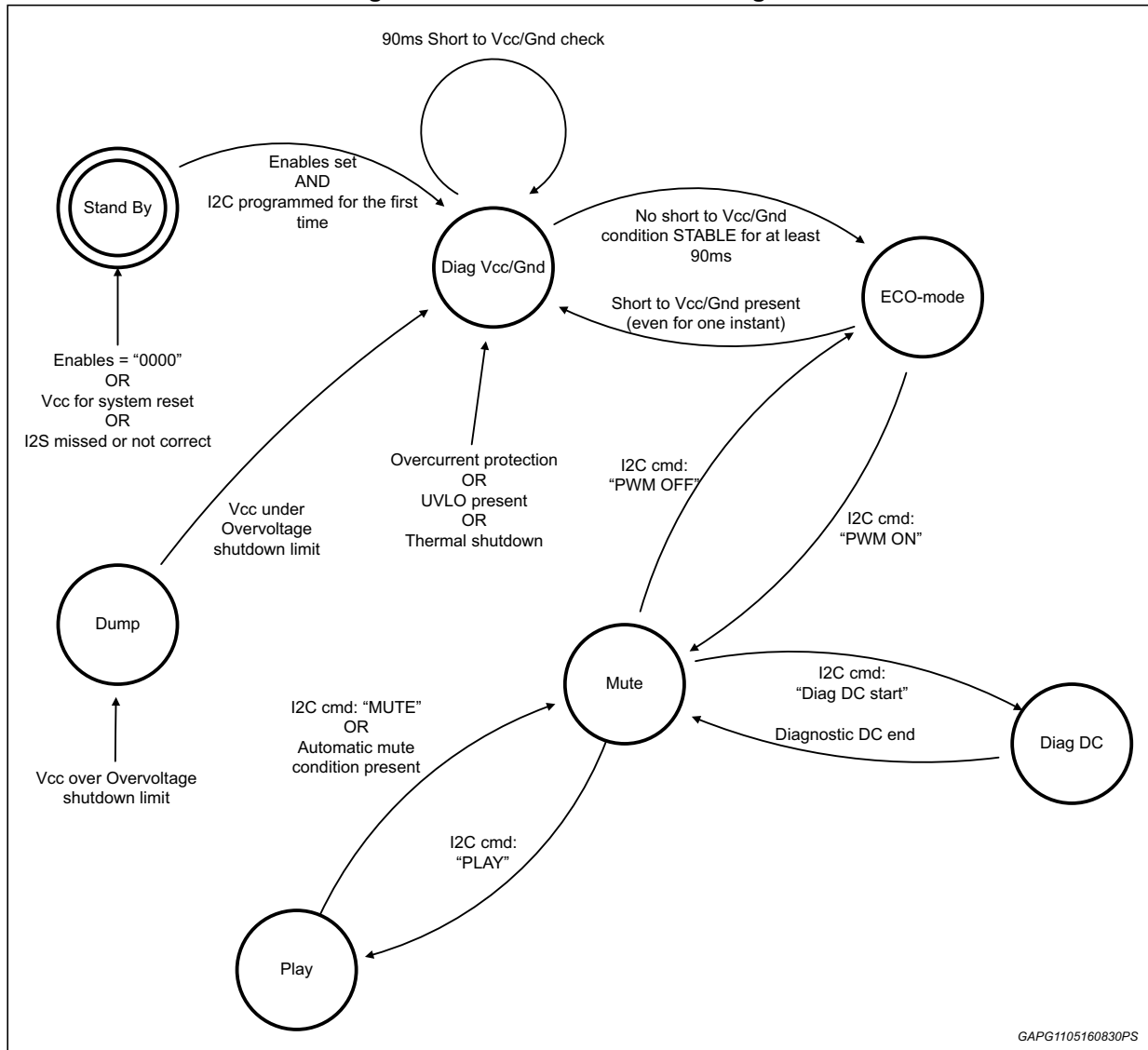

7.1 Device state and address selection

Through Enable pins configuration it is possible to select different I²C addresses (up to 8) or to configure the device in 4 different legacy ('no I²C' modes) according to table 6.

Table 6. Operation mode

	Enable 1	Enable 2	Enable 3	Enable 4
Stand By	0	0	0	0
Amplifier ON address 1 = '1110000'	0	1	0	0
Amplifier ON address 2 = '1110001'	1	1	0	0
Amplifier ON address 3 = '1110010'	0	0	1	0
Amplifier ON address 4 = '1110011'	0	1	1	0
Amplifier ON address 5 = '1110100'	0	1	0	1
Amplifier ON address 6 = '1110101'	1	1	0	1
Amplifier ON address 7 = '1110110'	0	0	1	1
Amplifier ON address 8 = '1110111'	0	1	1	1
Legacy mode: low voltage mode; in-phase	1	1	1	0
Legacy mode: low voltage mode; out-phase	1	1	1	1
Legacy mode: standard voltage mode; in-phase	1	0	0	0
Legacy mode: standard voltage mode; out-phase	1	0	0	1

In this way, up to 8 devices can be easily used in the same application with a single I²C bus. Moreover it is possible to work without I²C configuring the voltage range and switching mode to be used.

When a valid combination of Enable 1/2/3/4 is recognized the device turns on all the internal supply voltages and outputs are biased to V_{cc}/2.

The internal I²C registers are pre-settled in "default condition", waiting for the I²C next instruction.

The return in the Standby condition, (all enable pins at 0), will cause the reset of the amplifier. As defined in the finite state machine, The same event will happen if PLL is not locked, I²S is missing or not correct, V_{cc} for system reset.

FDA903D can work only in I²C slave mode.

7.2 Standby state

ENABLE1, ENABLE2, ENABLE3, ENABLE4 pins have a double function: set of I²C addresses and start-up of the system.

If ENABLE1/2/3/4 are all low, ("000"), then the FDA903D is off, the outputs remain biased to ground and the current consumption is limited to I_{sb}. In this case the FSM is in "Standby" state.

7.3 Diagnostic Vcc-Gnd state

After exiting from Stand-By state the device passes through Diagnostic Vcc/Gnd state.

In this state the amplifier checks the presence of the following faults:

- Shorts to ground or to Vcc;
- Under-voltage (UVLO_{VCC});
- Thermal shutdown

FDA903D will then move to the next state (Eco-mode) only if there isn't any of these faults for at least 90ms, thus avoiding any danger for the amplifier and the user system.

Meanwhile, if a stable fault is present, it will be communicated to the user via I²C after 90 ms, in order to provide always only stable information about the system. In this case the device will not move to Eco-mode, waiting for the fault cause removal

While the amplifier is in Diagnostic Vcc-Gnd state it can receive all the I²C commands, but it will turn-on the PWM only when it enters in the next state: ECO-mode. This procedure prevents wrong or unwanted I²C communication to bring the amplifier into dangerous situation (if a short to Vcc or Gnd is present).

Following conditions will move the amplifier in Diagnostic Vcc-Gnd state from any other functional state:

- Over current protection trigger
- UVLO_{VCC}
- Over voltage (through DUMP condition)
- Thermal shutdown

7.4 ECO-mode state

In ECO-mode state the amplifier is fully operative from a communication point of view and can receive and actuate all the commands given by the user.

In ECO-mode the output switching is disabled, thus allowing low quiescent current consumption and therefore low power dissipation. The device is also able to move from ECO-mode state to MUTE state, turning on the output switching, within about 1 ms - without experiencing POP-noise.

This allows a very fast transition from ECO-mode to PLAY.

7.5 MUTE-PLAY and diagnostic states

The amplifier can move from ECO-mode state to MUTE state selecting "PWM-ON" via I²C. This operation turns-on the output PWM.

FDA903D can move to PLAY state (from MUTE state) via "PLAY" I²C command and returns to MUTE state from PLAY state acting on the same bit.

Transition time between mute and play states could be selected via I²C.

Some external conditions could lead the amplifier in mute state automatically:

- Low battery mute
- High battery mute
- Thermal mute
- Hardware pin mute

Once mute condition is no more present the FDA903D will return automatically in PLAY state, following I²C register program set.

Of course the user can decide to change the amplifier programming in the meanwhile, thus avoiding the automatic return in PLAY.

From MUTE state the user can also select to enter DC diagnostic state.

7.6 Operation compatibility vs battery

The FDA903D operation compatibility vs the battery value is reported in the figure below.

Figure 39. Operation vs. battery charge

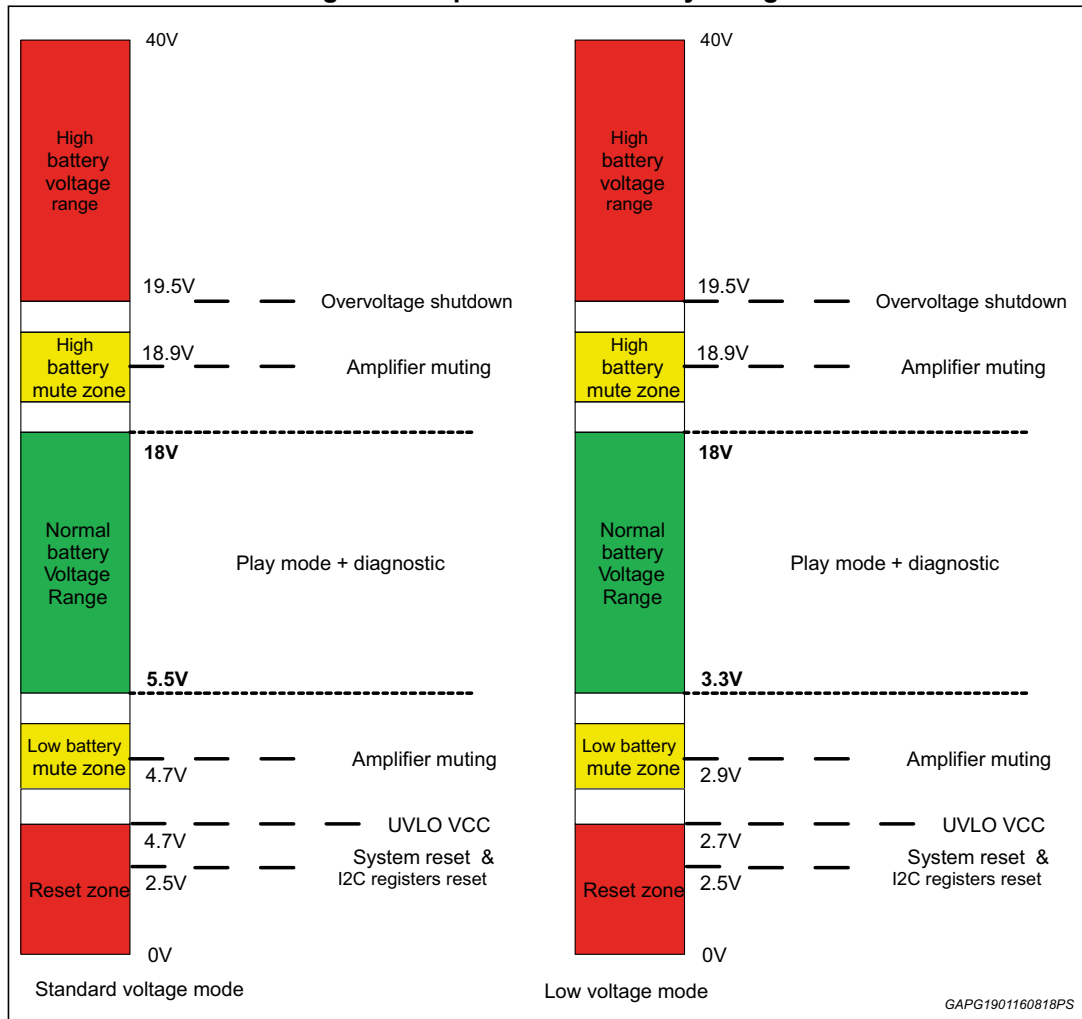

Note: When Overvoltage Shutdown is reached, I²S interface is switched off and relative I/O are maintained in HighZ.

8 Muting function architecture

FDA903D uses a mixed signal approach for muting function.

Muting function is activated by different "mute command signal":

- “High voltage mute”: active when Vcc enters in a voltage window over the max voltage; the window is specified in the electrical parameters table.
- “Low Battery mute”: active when Vcc enters in a voltage window under the min voltage; the window is specified in the electrical parameters table.
- “Hardware mute”: active when HWMute pin enters in the voltage window specified in the electrical parameters table.
- Thermal mute”: active when temperature enters in the temperature window over the max temperature; the window is specified in the electrical parameters table.
- “I²C Mute”: active user select mute/play I²C bits.

The mute is achieved by the combination of two separated actuators, “Analog-mute” and “Digital-mute”.

8.1 Command dependence

Analog and digital mute actuators activation could be different based on the mute command signal. This is described in the following table:

Table 7. Command dependence

Command signal	When?	Mute	Unmute
Low Battery mute	When Vcc enters inside the low battery mute window	Mixed mute. Analog & Digital, at the same time ⁽¹⁾	Digital ⁽¹⁾
High Voltage mute	When Vcc enters inside the high voltage mute window	Mixed mute. Analog & Digital, at the same time ⁽¹⁾	Digital ⁽¹⁾
Thermal Mute	When temperature enters inside thermal mute window	Analog	Analog
Hardware Mute	When hardware pin voltage enters inside its mute window	Mixed mute. Analog & Digital, at the same time ⁽¹⁾	Digital ⁽¹⁾
I ² C Mute	When I ² C mute bits are selected	Digital	Digital

1. User can decide to disable Digital-Mute/Unmute using bit IB13-d6; in this case in all the conditions, (except I²C Mute), the Mute/Unmute will be purely Analog.

8.2 Analog-Mute

Analog-Mute senses when the mute command signal transits across the muting window, and attenuates the output signal proportionally to the command signal level inside the muting window.

Figure 40. Analog-Mute diagram

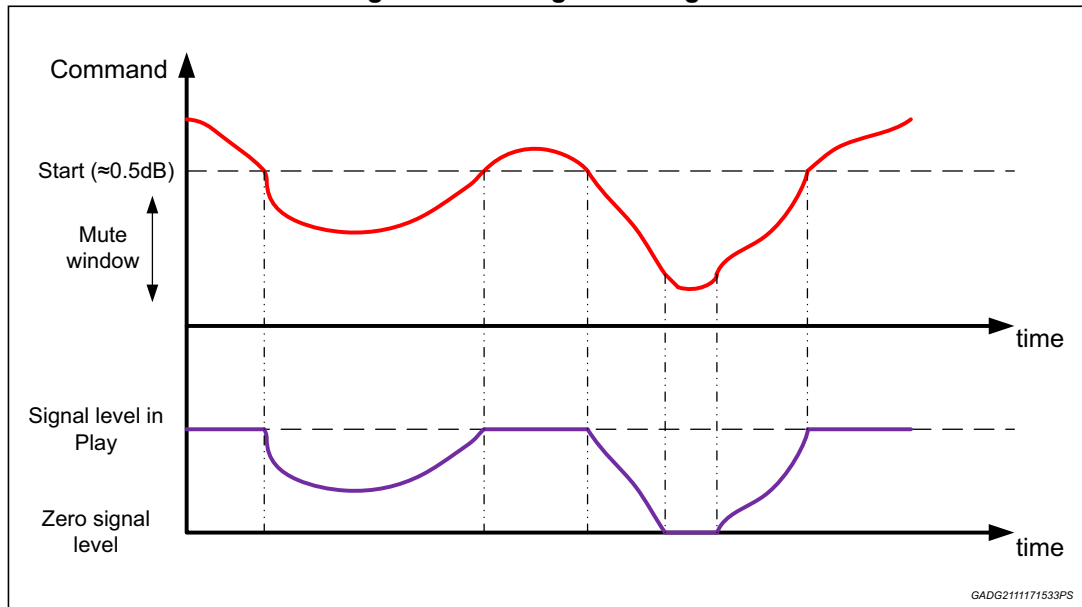

8.3 Digital-Mute

Digital-Mute acts on the digitally elaborated output signal attenuating it gradually to zero with digital steps in a pre-defined time frame (t_{mute}). The muting time, (t_{mute}), can be selected by I²C, (IB6 d7-d6). There are two different actions performed by digital-mute function:

Mute: it starts when any mute command signal, marked as Mixed Mute in [Table 7](#), enters in the muting window. This event rises the Start-Analog-Mute signal, communicated on DB6[4]. The muting ends after t_{mute} , selectable through IB6[7-6]. The Start-Analog-Mute signal is ignored until the muting ramp has ended.

Approximately, the corresponding analog mute attenuation at the beginning of the muting window is 0.5dB.

UnMute: it starts when all the mute commands, marked with Mixed Mute in [Table 7](#), exit from the muting window. This event resets the Start-Analog-Mute signal, communicated on DB6[4]. The unmuting ends after t_{mute} , selectable through IB6[7-6]. The Start-Analog-Mute signal is ignored until the unmuting ramp has ended.

Figure 41. Digital-Mute diagram

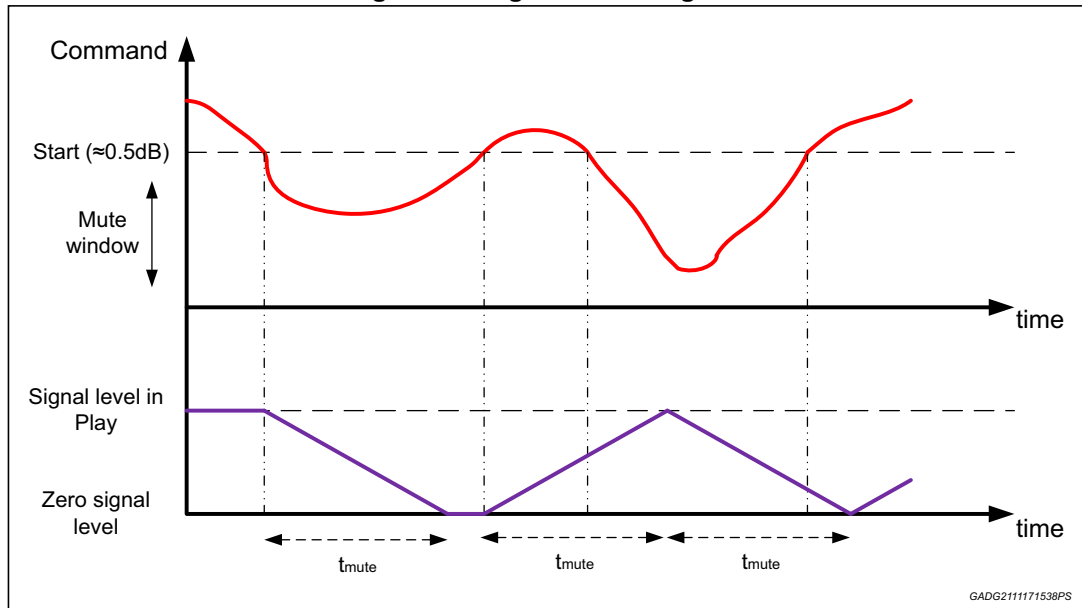

Note: *in case of I²C mute the Digital-mute actuation does not follow Analog-mute level but only the I²C command.*

8.4 Mixed mute advantages

The mixed mute approach is the superposition of the two mute actuators, Analog-Mute and Digital-mute, at the same time.

Here below the example of previous pages with mixed mute:

Figure 42. Mixed mute diagram

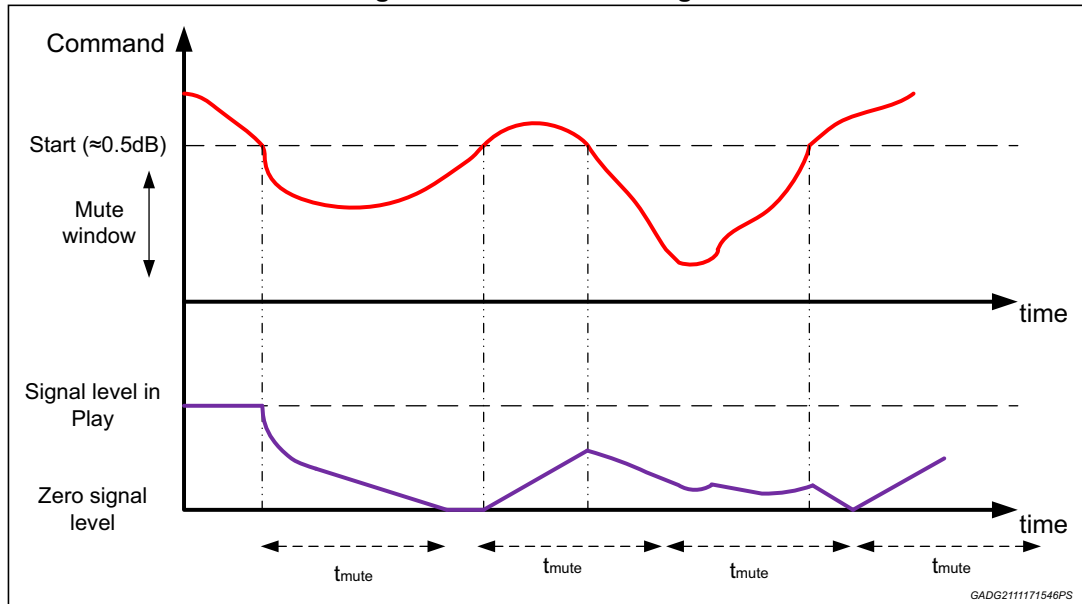

The Mixed-Mute approach is more robust than Analog-Mute only approach. The effects are visible when the command signal variations inside the muting window last longer than the muting/unmuting time. An example is depicted in the figure below:

Figure 43. Analog-Mute vs. Mixed-Mute

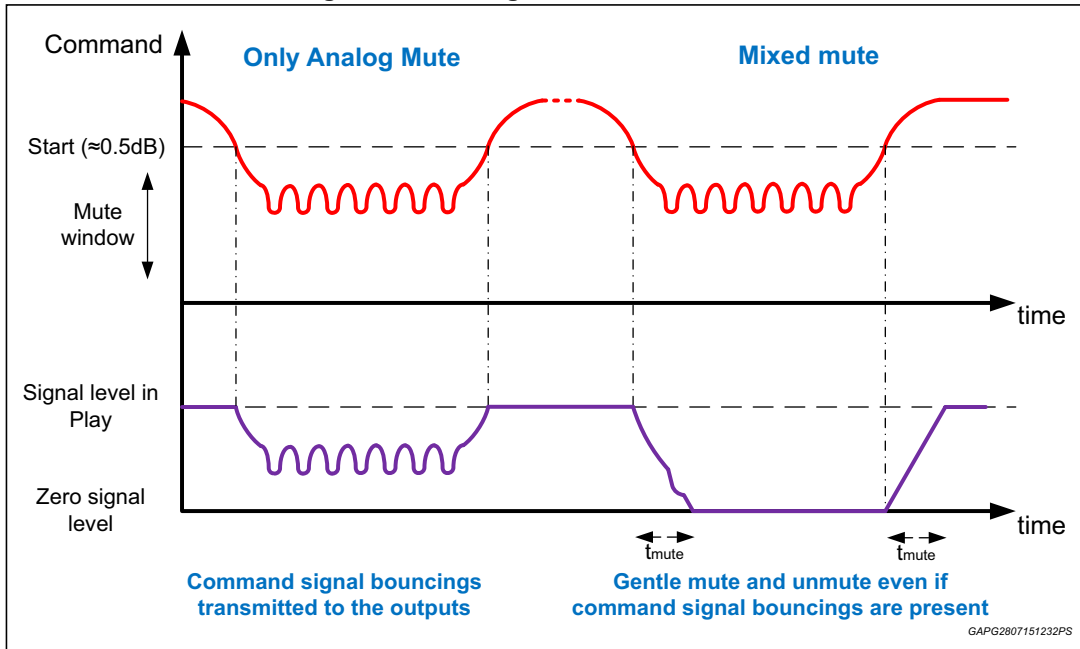

In any moment the user can disable the Digital-mute, acting on I²C bit IB13-d6, obtaining the standard Analog-mute function.

9 Hardware mute pin

The pin "HWMute" (pin 30) acts as mute command for the channel. The device is muted when this pin is low, while it is in play when this pin is high (low/high threshold in [Table 5: Electrical characteristics](#)).

Inside the device, connected to this pin a pull-up current generator puts the device in play if left floating. An internal clamp limits the Mute pin voltage. If not used, this pin should remain floating.

To drive the Mute pin to get a hardware mute an external pull-down open drain is needed. (See [Figure 44](#)), RMute must be < 60 kΩ

Figure 44. HWMute pin schematic

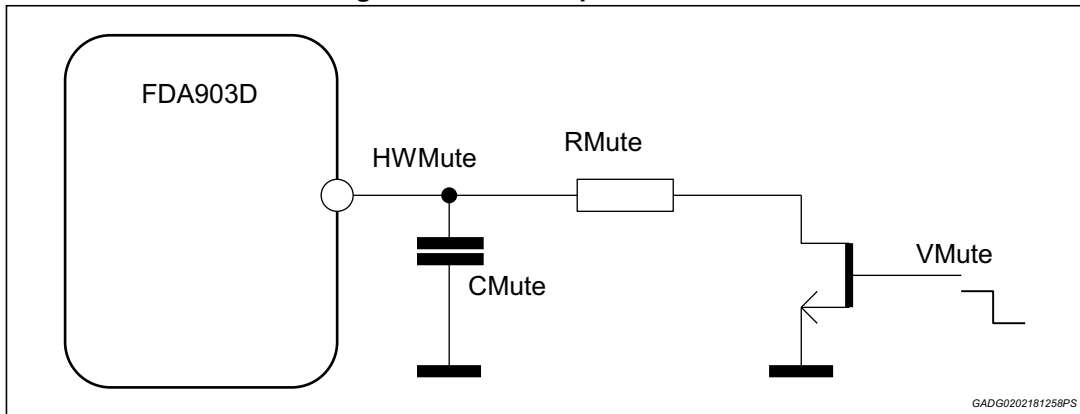

10 Power limiter function

An adjustable power limiting function has been integrated to protect "small speakers" applications: thanks to this feature, it's possible to limit by configuration the max power delivered to the load.

Taking advantage of digital input architecture, the output power limitation is obtained through the management of the input signal. It's important to underline that the limitation is implemented independently of the supply voltage value.

The intervention thresholds, configurable through I²C are listed in the table below

Table 8. Power limiter function

I ² C IB2[3-0]	Full-Scale Voltage limit	Output Voltage limit [V]	
		Standard gain setting	Low gain setting
0000	100% (Disabled)	19 ⁽¹⁾	11.4
1011	80%	15.2	9.12
1010	70%	13.3	7.98
1001	60%	11.4	6.84
1000	50%	9.5	5.7
0111	45%	8.55	5.13
0110	40%	7.6	4.56
0101	35%	6.65	3.99
0100	30%	5.7	3.42
0011	25%	4.75	2.85
0010	20%	3.8	2.28
0001	15%	2.85	1.71

1. 19 V is only a reference level, coherently with "standard gain" value in [Section 5.3](#), to deduce the power limiter thresholds. The reference level is unreachable due to the maximum supply voltage range, equal to 18 V.

The limitation is gradual in order to have no impact on the acoustic performance. Depending on the signal amplitude and the desired attenuation, different gains are applied to the signal itself.

Here an example of the response obtained with a limitation corresponding to 80% of the full-scale: the blue line represents the signal when the power limiter is not employed, while the red line is the result of the applied attenuation.

Figure 45. Response obtained with a limitation corresponding to 80% of the full-scale

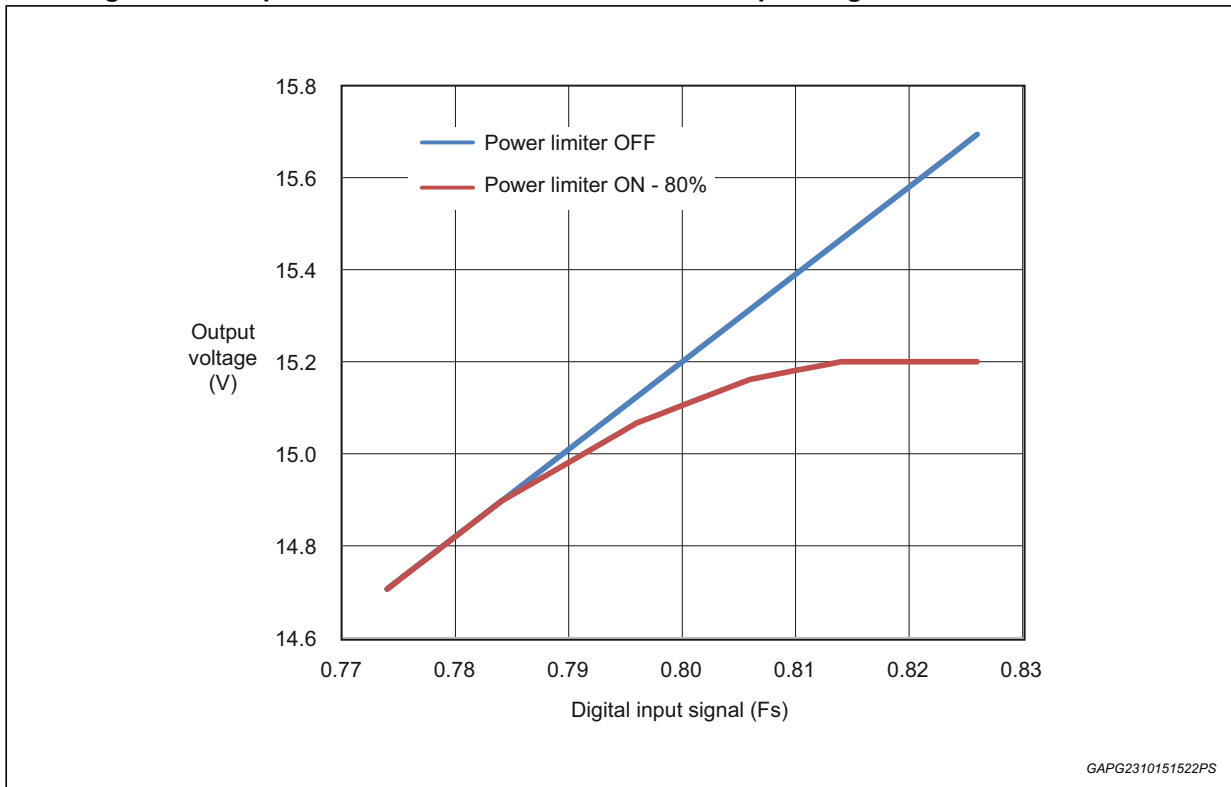

10.1 Power limiter control

The function can be controlled with I²C bus, properly settings the bits IB2[3-0].

The configuration of the power limiter threshold and the enable/disable are available only in MUTE state.

11 Diagnostic

The FDA amplifiers family provides diagnostic function for detecting several possible faults conditions.

Any warning information will be stored in the I²C interface and kept until the first I²C bus reading operation. Some fault events can be sent to CDDiag pin as trigger for an interrupt process.

Here reported the faults detectable taking advantage of FDA903D's diagnostic features:

- Short to VCC/GND;
- Short or open load (with DC diagnostic);
- Open load during play;
- Under/over voltage events;
- Chip over temperature;
- Digital input offset;
- Output voltage offset;
- Output current offset;
- Output clipping;
- Over current.

The fault events are managed with different actions depending on their severity.

It is important, for a correct diagnostic result collection, to clean diagnosis related I²C register and the DB6, to clean eventual Start Analog Mute flag, through a read operation.

11.1 DC diagnostic

The DC diagnostic is a routine performed to detect the load connection status.

FDA amplifiers family provides a highly reliable and noise immune load diagnostic algorithm, in order to prevent false detections induced by supply voltage variations or mechanical stress on the speaker (e.g. car door closing). The algorithm includes the internal generation of a properly calibrated and pop-free test signal.

For an extensive description of the DC diagnostic feature, please refer to the DC Diagnostic user manual.

11.1.1 Diagnostic control

DC diagnostic can be run setting via I²C "Start Diag DC".

Diagnostic signal is generated and test is performed only when all the following conditions are true:

1. Channel is in MUTE state.
2. DC test enable bit is set from '0' to '1'.
3. The channel has power stage ON
4. Device is NOT kept in mute by means of the dedicated hardware pin

At the end of the diagnostic cycle the "Start Diag DC" instruction bit is reset to '0' by the device itself, and the "open load" or "short load" messages respectively will be displayed on I²C data bits.

If "Start Diag DC" bit is set to '1' while the channel is not in "MUTE" state, (for example: "PLAY" state or "Eco-mode" state), the channel will perform the diagnostic as soon as it enters in "MUTE" state.

If the amplifier channel is in "Eco-mode" and I²C instructions for PWM ON + DIAG DC + PLAY are given at the same time the channel will perform the following sequence automatically:

1. turn on power stage
2. perform DC diagnostic
3. enter PLAY mode

DC diagnostic must be performed only with PWM "In phase" modulation, in order to avoid pop noise. "Out phase" modulation, if desired, must be selected after DC diagnostic execution.

11.1.2 Relation with short circuit protection activation

After a short circuit protection intervention amplifier is set automatically in a protected status during which "Short to Vcc/Gnd" diagnostic is performed.

At the end of "Short to Vcc/Gnd" diagnostic, if no shorts to Vcc/Gnd are present on the outputs, the amplifier will run DC diagnostic only if the corresponding "Start Diag DC" bit is set to "1". Otherwise the amplifier will go back to the state preceding the short circuit protection intervention without performing diagnostic cycles.

After the diagnostic completion "Start Diag DC" bit is set back to "0" by the amplifier.

11.1.3 Load range

The thresholds for short load detection and open load detection can be configured through IB10[7,6]. Including the tolerance, the impedance values to be considered are reported in [Figure 46](#).

Figure 46. Load range detection configured properly setting IB5 d7-d6

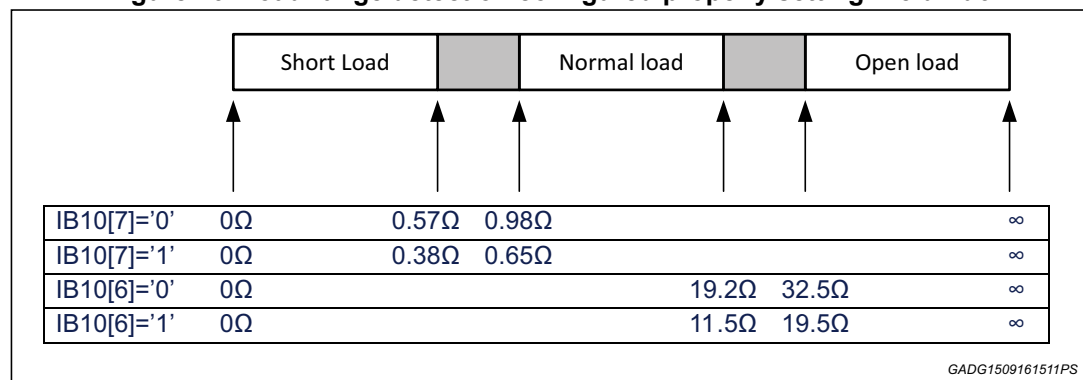

The DC diagnostic pulse has a configurable time duration: for detailed timings definition, please refer to the DC Diagnostic user manual.

The DC diagnostic result is provided on I²C register DB2.

11.2 Short to Vcc / GND diagnostic

The short to Vcc/GND diagnostic performs the detection of:

- "Hard" and "soft" short to Vcc
- "Hard" and "soft" short to Gnd

Timing

Short to Vcc/Gnd diagnostic cycle duration is 90 ms^(*).

If a short to Vcc/Gnd is not stable during diagnostic cycle the channel will remain in "Diag. Vcc/Gnd" state until a fault or non-fault condition is stable for at least 90 ms^(*).

This special function avoids wrong detections in case of disturbs caused by mechanical stresses applied to the speaker (e.g. car door closing).

The short to Vcc/Gnd diagnostic starts automatically following the logic shown in [Figure 38](#).

Results communication and I²C control

After performing Short to Vcc/Gnd diagnostic for 90 ms^(*) with a stable fault/non-fault condition, there are two different scenarios:

1. Fault present: the device is communicating the fault condition setting the I²C bit DB2[3] (in case of short to Vcc) or DB2[2] (in case of short to Gnd). The amplifier is remaining in "Diag. Vcc/Gnd" state until the short is removed
2. Fault not present: Short to Vcc/Gnd diagnostic ends and the state machine can evolve following the I²C commands.

Note: (*) Time when default I²C parameters settings are used

11.3 Diagnostic time-line diagrams

Figure 47. DC diagnostic before turn on

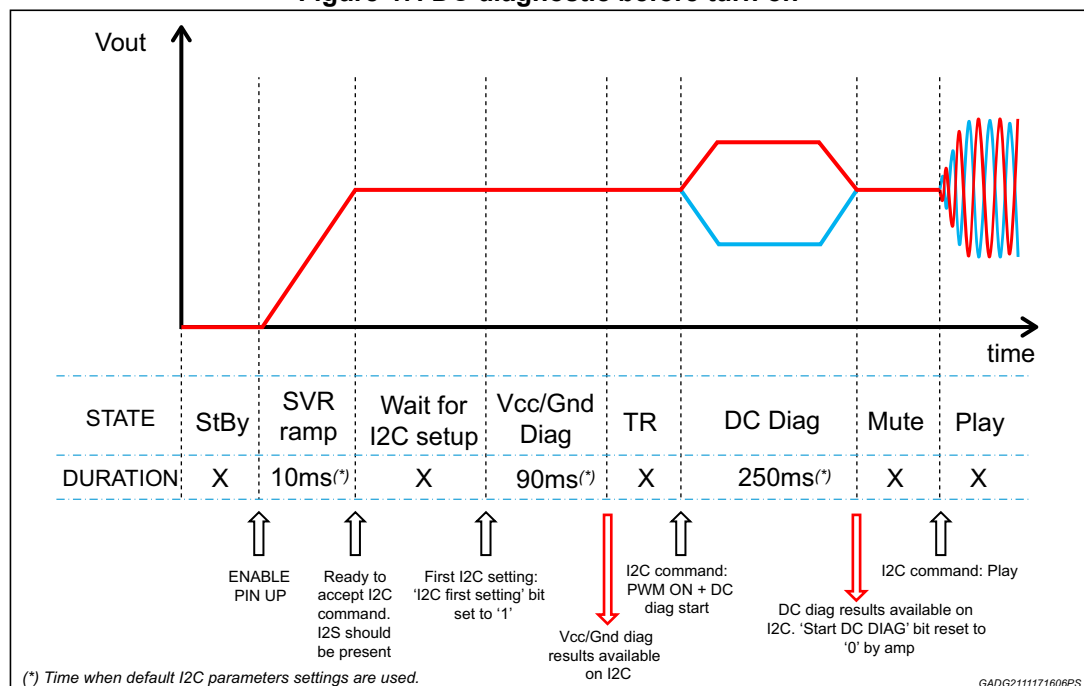

Figure 48. Short to VCC at device turn on

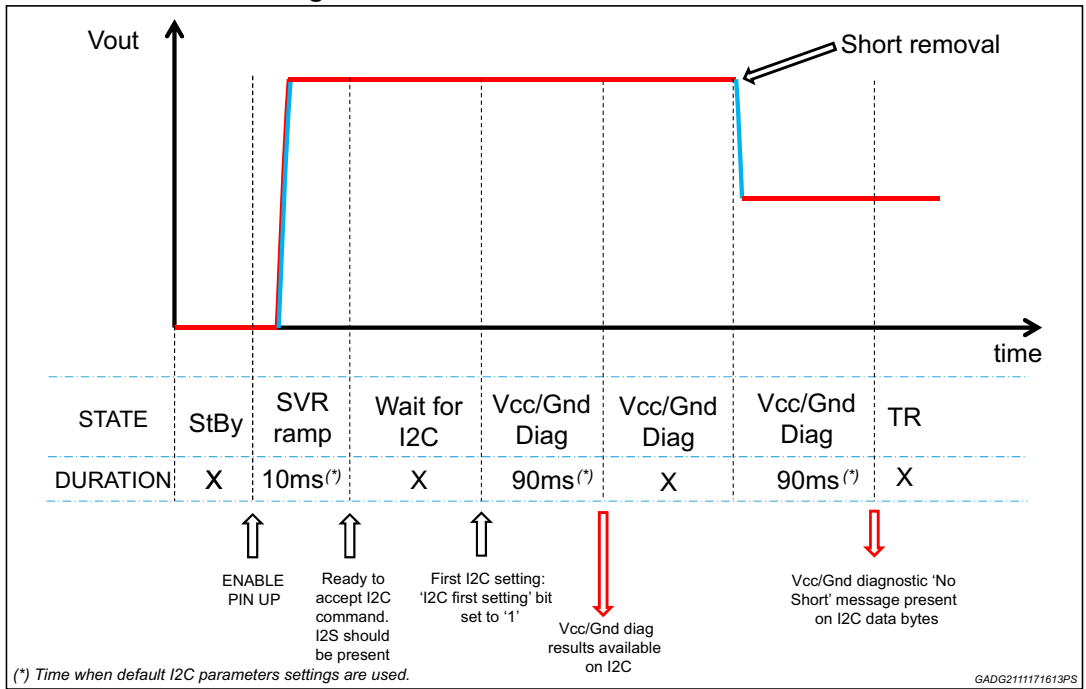

Figure 49. DC Diagnostic in Mute

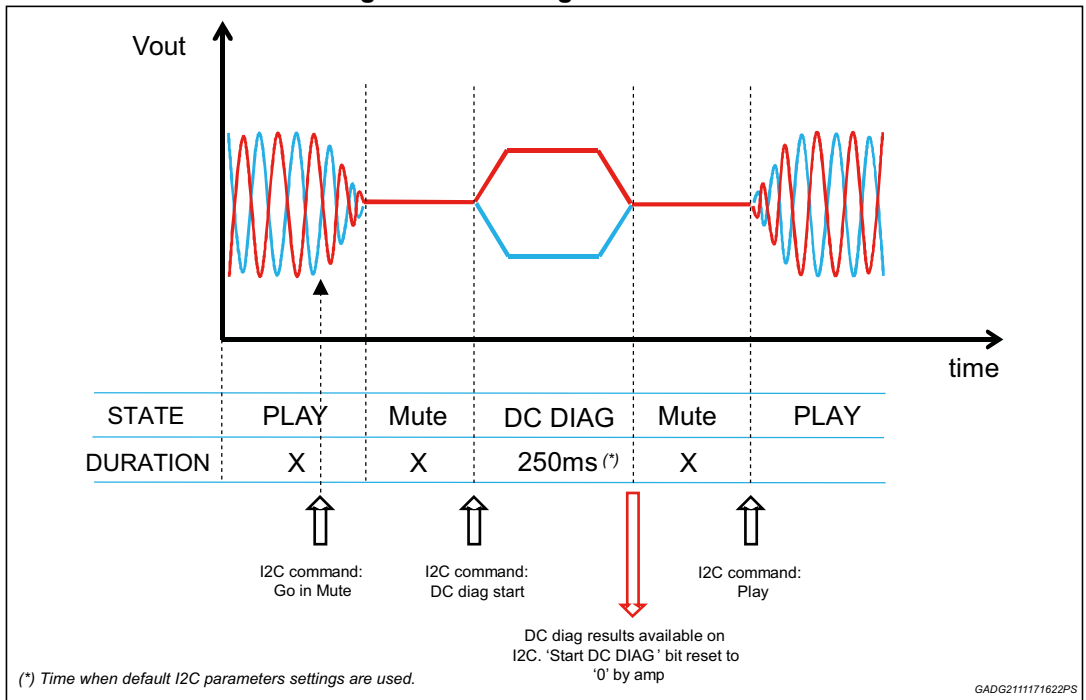

Figure 50. Short circuit protection activation - Short to VCC

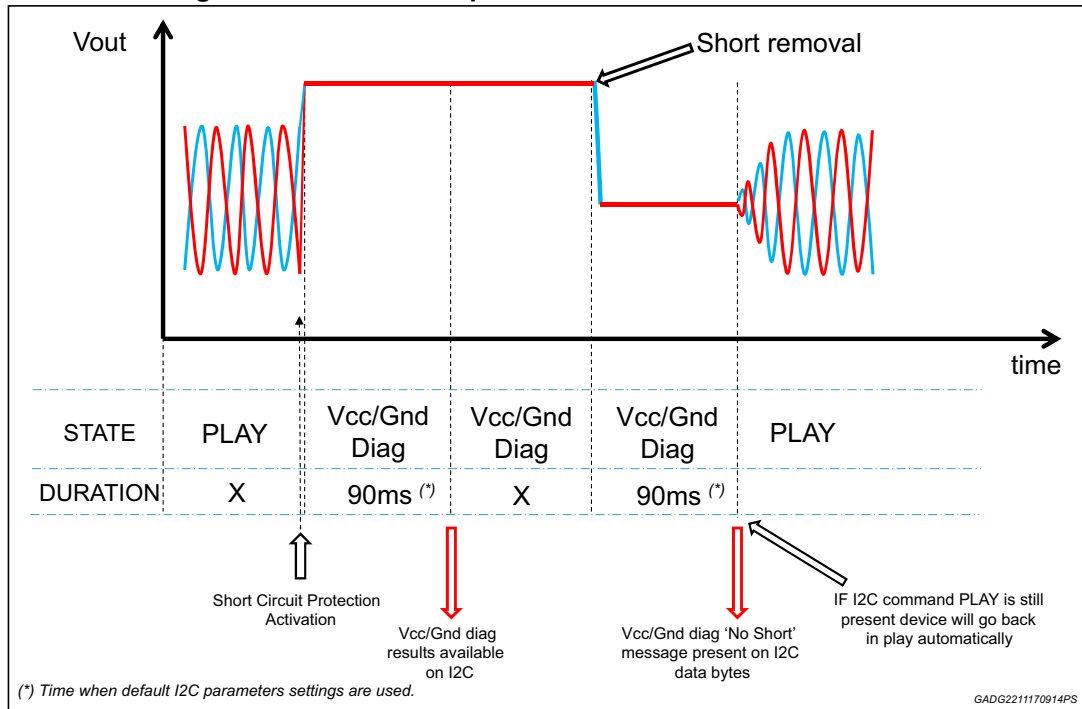
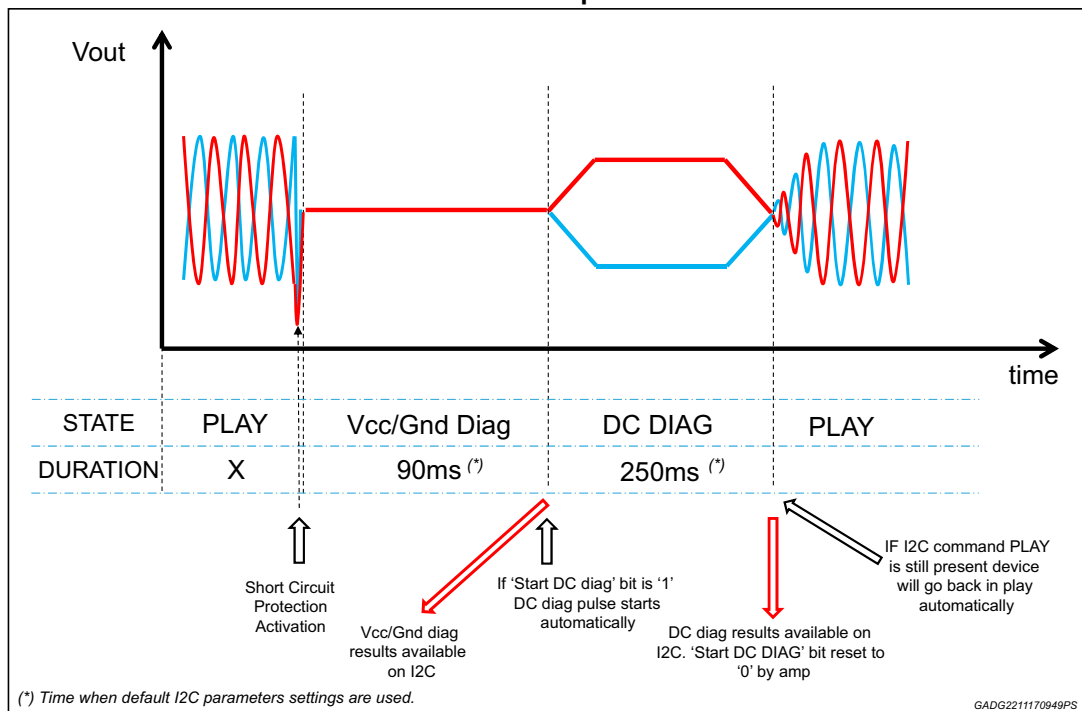

Figure 51. Short Circuit Protection activation due to short across load, short to Vcc/Gnd not present



11.4 Open load in play detector

Open load in play detector aim is to detect the possible speaker detachment during PLAY state.

The innovative internal architecture allows to detect an open load condition taking advantage of the audio signal itself, guaranteeing high detection reliability without requiring a dedicated test signal.

11.4.1 Open load in play detector operation overview

The open load in play detection consists in one single shot test, which can be repeated according to user need.

The test firstly checks the audio signal characteristics. If the audio signal is judged good enough to provide a reliable result, the test result is valid. Otherwise, if the audio signal doesn't allow to perform a reliable detection, the test result is not valid and the user needs to repeat the test.

During the same evaluation time window, an internal circuit measures the differential current flowing through the pins OOTP and OOTM. The test consequently evaluates both the digital input signal and the output current, monitoring the average load impedance over time.

If the test result is valid and the average load impedance exceeds the chosen impedance threshold, the device communicates that the load is not connected. Otherwise, if the test result is valid and the average load impedance is lower than the chosen threshold, the device communicates that the load is connected.

11.4.2 Processing bandwidth range

The feature requires an accurate measurement of the current flowing through the speaker.

The filter capacitors behave like an undesired load connected in parallel with the speaker, altering the current measurement. However, this undesired contribution is significant only in the high frequency range of the audio bandwidth.

On the other side, the most of the audio signal energy is distributed in the middle-low frequency range of the audio bandwidth.

Due to the mentioned reasons, Open Load in Play Detector processes the audio bandwidth up to 2kHz approximately, in order to guarantee a highly reliable solution without affecting the rate of valid tests.

Please note that the processing bandwidth limitation does not affect the main signal path from digital input signal to output voltage on FBP and FBM pins.

11.4.3 Audio signal evaluation

The audio signal is considered a good test signal if its amplitude allows the internal circuits to perform accurate measurements. In particular, Open Load in Play Detector processes the audio signal only if its amplitude exceeds the values expressed in [Table 9](#):

Table 9. Open load in play detector impedance and validity thresholds

Open load impedance threshold	Digital input signal amplitude threshold
25 Ω (IB10[6]='0')	67 mFs
15 Ω (IB10[6]='1')	40 mFs

The audio signal is unknown and not stationary, while the speaker has a complex impedance. Open Load in Play Detector evaluates the audio signal for a time window lasting up to 1s in order to properly average the data over time. The detection is considered valid if, during the evaluation time window, the input audio signal exceeds for 300ms the thresholds reported in [Table 9](#).

11.4.4 Impedance threshold

Open Load in Play Detector includes two different impedance thresholds which can be configured through IB10[6] and which depend also on gain setting through IB6[4]. Their value has been calibrated in the following conditions:

- ideal sinusoidal signal,
- absence of external disturbances.

The uncertainty on audio signal characteristics and on external disturbances requires to keep proper tolerances. The guaranteed thresholds are reported in [Figure 52](#) and in [Figure 53](#):

Figure 52. Open load in play detector guaranteed thresholds with standard gain setting

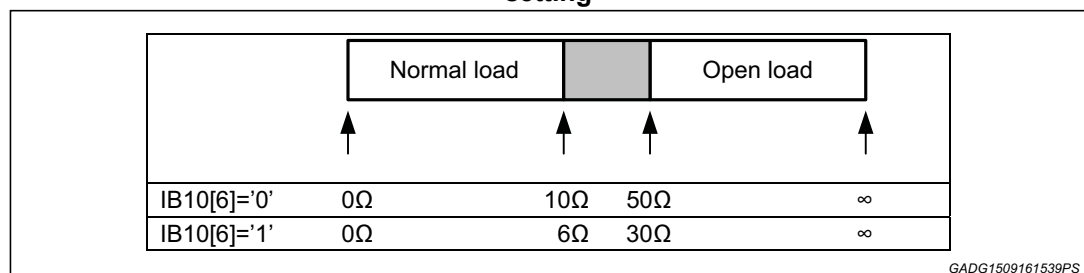
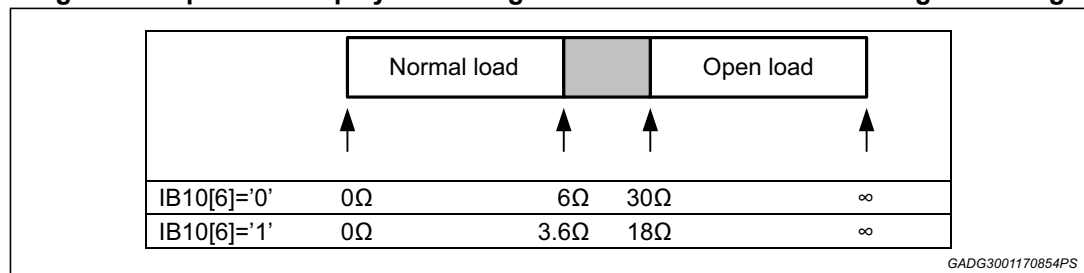

Figure 53. Open load in play detector guaranteed thresholds with low gain setting



Please note that an exact value of impedance can be defined only in case of an ideal sinusoid at a fixed frequency. In case of a generic audio signal, the overall complex impedance vs frequency characteristic of the speaker is involved.

11.4.5 I²C control and timing

The user must set IB3[0] in order to start the open load in play detection.

Once the test is started, the internal circuits required for the detection are turned on, requiring a settling time lasting approximately 500 ms.

When the internal circuits are ready to work, both digital input signal and output current measurement start being evaluated, following the impedance threshold set through IB10[6]. Depending on the audio signal characteristics, the evaluation can last from 300 ms to 1 s approximately.

At the end of the evaluation, the device:

- Sets DB0[2]='1' to communicate that the test ended successfully, and resets IB3[0] allowing the user to perform another test afterwards
- Sets DB0[1]='1' to communicate that the test result is valid, otherwise sets DB0[1]='0' to communicate that the test result is not valid.
- Sets DB0[0]='1' to communicate that an open load has been detected, otherwise sets DB0[0]='0' to communicate that an open load has not been detected.

Please note that the value on DB0[0] is significant only if the test result is valid.

If the test ends successfully but the result is not valid, the user must repeat the test. This condition happens when the audio signal is not good enough for a reliable detection.

The detection timings are represented in *Figure 54*:

Figure 54. Open load in play detector timing

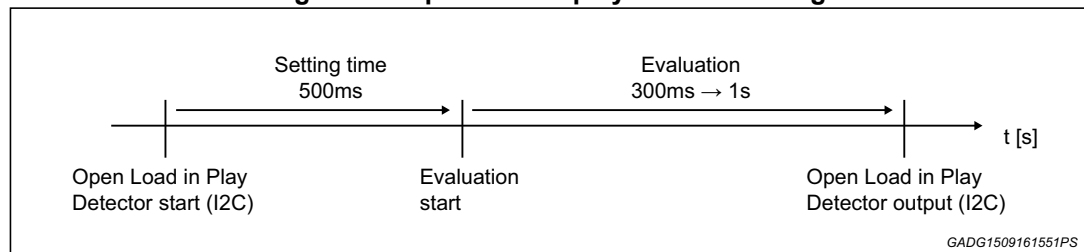

If the device FSM moves from PLAY to another state during the open load in play detection routine, the test ends unsuccessfully by keeping the flag DB0[2] clear. The device automatically resets IB3[0] allowing the user to repeat the test.

11.5 Input offset detector

Input offset detector aim is to detect an offset coming from the audio signal source through I²S/TDM input stream.

For this purpose, the feature evaluates the input offset through a low-pass filter, which is compared with a threshold equal to -18dBFs. If the measured offset exceeds the threshold, Input Offset Detector sets the flag DB0[7] to '1'.

Moreover, if the high-pass filter function is enabled through IB3[2], the input offset is eliminated, guaranteeing a complete robustness in case of any malfunction coming from the audio signal source.

11.6 Output voltage offset detector

Output voltage offset detector aim is to detect a voltage offset on the output.

For this purpose, an internal circuit detects when the voltage value on FBP pin or on FBM pin exceeds 1V difference with respect to $V_{CC}/2$ value, generating a fault condition. If the fault condition persists for 90ms consecutively, the circuit sets the flag on I²C bit DB0[3]. As soon as the fault condition is removed, both the flag DB0[3] and the 90ms counter are reset. The implemented logic avoids false detections in case of very low signal frequency.

The feature operation is showed in *Figure 55*:

Figure 55. Output voltage offset detector operation

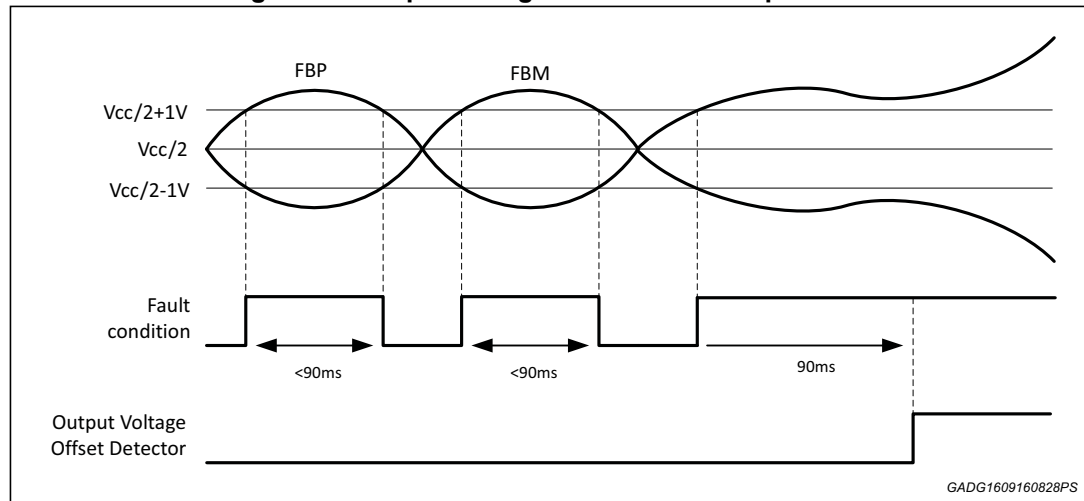

When enabled, the feature is active both in MUTE and in PLAY states.

Please note that the Output Voltage Offset Detector must not be enabled when FBP and FBM pins are shorted with OUTP and OUTM pins, i.e. for feedback before filter configuration: the full-swing PWM outputs don't allow the fault condition persisting for more than 90ms even in case of offset. A valid and robust alternative is provided by the Output Current Offset Detector.

The offset detector output is provided in two forms:

- Enables the pull down on CDDiag pin, if IB4[7]='1'
- Sets the flag DB0[3]='1'

11.7 Output current offset detector

Output current offset detector aim is to detect a current offset on the output.

11.7.1 Output current offset detector operation principle

The device senses the differential DC current flowing through the output pins OUTP and OUTM. In particular, in reference to [Figure 56](#), the measured current offset is:

$$I_{\text{OFFSET}} = |I_{\text{OUTP}} - I_{\text{OUTM}}|/2.$$

Figure 56. Current offset measurement

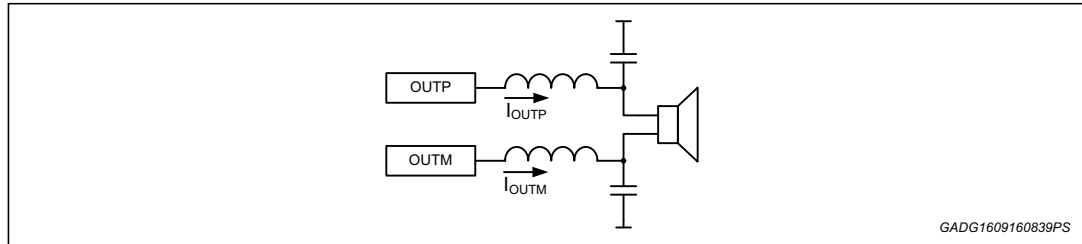

The measured current offset is then compared with a current threshold, which can be set by means of I²C bits IB10[4,3]: if it exceeds the chosen threshold, the device communicate that an output current offset has been detected.

11.7.2 Result communication and I²C control

The output current offset detection consists in one single-shot test. The feature is controlled through I²C commands.

In order to start the detection, the user must set IB3[3]='1'.

At the end of the test, the internal control logic performs the following operations:

- Sets DB0[6]='1' to communicate that the test is ended and the result is valid
- Sets DB0[5]='1' if an offset has been detected, or DB0[5]='0' if no offset has been detected
- Sets IB3[3]='0', allowing the user to perform another test afterwards

The detection can be start in MUTE state or in PLAY state. If the user sets IB3[3]='1' while the device FSM state is different, the test starts as soon as the device FSM enters in MUTE or PLAY state.

11.7.3 Hot spot detection

The output current offset detector enables the possibility to detect a soft short to Vcc or to Gnd occurring when the PWM is already turned on, guaranteeing improved robustness against hot spot formation.

The operation principle is shown in [Figure 57](#):

Figure 57. Hot spot detection

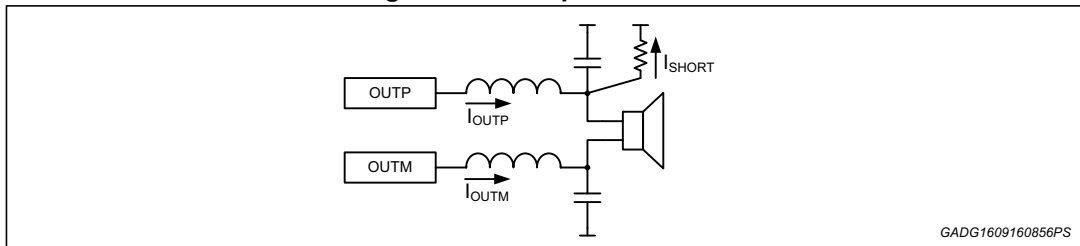

In standard operative condition, the DC value of I_{OUTP} and I_{OUTM} is zero, therefore the measured output current offset is zero.

When a soft short is connected between one output and Vcc or Gnd, the corresponding output drives an additional current I_{SHORT} . The device interprets half of the mentioned current as offset: $I_{OFFSET} = |I_{OUTP} - I_{OUTM}| / 2 = |I_{SHORT}| / 2$.

In conclusion, if half of the DC current flowing in the short circuit exceeds the threshold selected through IB10[4,3], Output Current Offset Detector communicates an offset detection.

11.8 PWM pulse skipping detector

Pulse skipping detector aim is to detect the PWM stage saturation.

The feature detects pulse skipping when, for each output, at least two consecutive PWM commutations have been skipped. The operation is shown in [Figure 58](#):

Figure 58. PWM pulse skipping detector operation

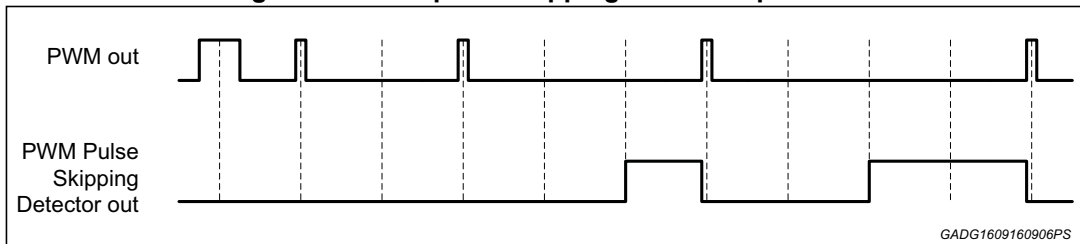

In order to enable the PWM pulse skipping detector, the user must set IB5[5,4]='01'.

When detecting pulse skipping, the feature provides the output in two forms:

- Enables the pull down on CDDiag pin
- Sets the flag DB1[0]='1'

As soon as the pulse skipping condition is removed, both the outputs are reset.

The suggested utilization for this function is to connect a low-pass filter to CDDiag pin, therefore comparing the output with a voltage threshold. The lower is the CDDiag pin average voltage, the higher is the distortion.

11.9 Thermal protection

The device integrates different protection levels against over-temperature conditions.

The first protection level consists only in communicating if the temperature exceeds four different thresholds, from TW4 to TW1. The result is provided in two ways:

- Setting DB1[7-4];
- Pulling down the CDDiag pin, coherently with the setting of IB4[6-4].

If needed, the user is in charge of taking proper actions to counteract the temperature rising.

The second protection level consists in the output signal attenuation as a function of the temperature, in order to reduce the power dissipation. The thermal attenuation occurs in the temperature range between Tpl and Tph, as shown in *Figure 59*.

The third level protection consists in switching off the power stage when the temperature overpasses the Tsh value. As shown in *Figure 2*, after thermal shutdown triggering, the device FSM enters in "Short to Vcc / Gnd diagnostic state", preventing subsequent power stage turn on in case of shorts to battery or ground.

The temperature values TW4, TW3, TW2, TW1, Tpl, Tph, Tsh are always in tracking, independently of the parameters spread. If the user sets the I²C bit IB12[7], all the mentioned thresholds are reduced of 15°C.

Figure 59. Thermal attenuation curve

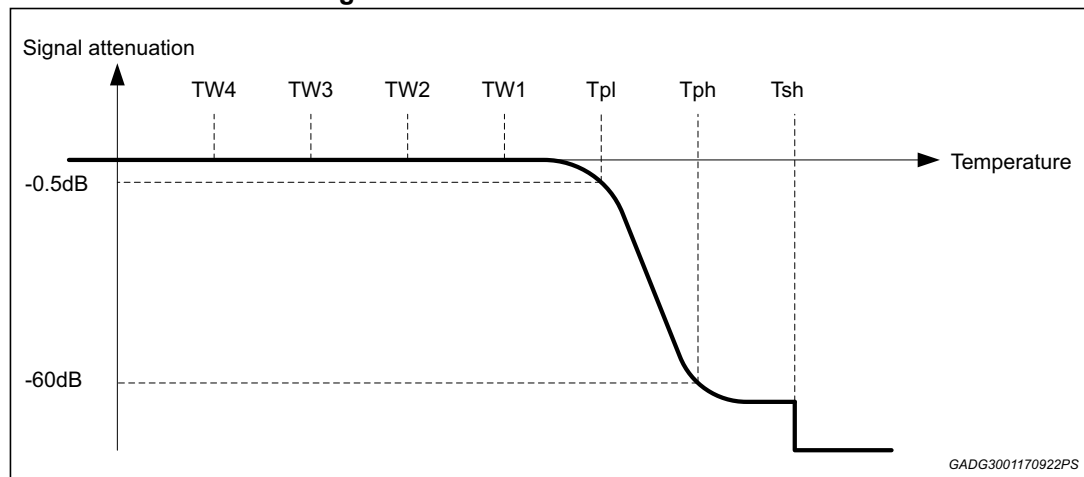

11.10 Watch-dog

The user can enable an internal watch-dog, setting I²C IB9[4]='1'.

The function is based on a timer which is reset at each Word Select line rising edge, and which reaches the timeout in:

- 2.9 ms if fs = 44.1 kHz;
- 2.7 ms if fs = 48 kHz, 96 kHz, 192 kHz.

When the timer reaches the timeout, the function performs two operations:

- Sends a muting command to the amplifier
- Sets a flag on DB6[2]

In case of timeout, the muting command is released as soon as the timer is reset by a new Word Select line edge.

11.11 Error frame check

The device integrates a function called "Error frame check", which is permanently enabled.

The function counts the number of rising edges received on the Clock line, starting from each rising edge of Word Select line. At the end of the data frame, marked by the subsequent rising edge on Word Select line, the function checks that the reached count is coherent with the I²C configuration of the I²S protocol.

In case the function detects an error, the device sets a flag on DB6[1].

12 Additional features

12.1 AM operation mode

The device provides special functions in order to avoid EM interferences when the radio is tuned on an AM station.

The first function consists in allowing the user to select a proper PWM switching frequency through I²C interface, depending on the AM station selected by the tuner. The PWM switching frequency selection is available only in case the I²S frame clock is 44.1 kHz or 48 kHz, as shown in *Figure 60*.

Figure 60. PWM switching frequency selection

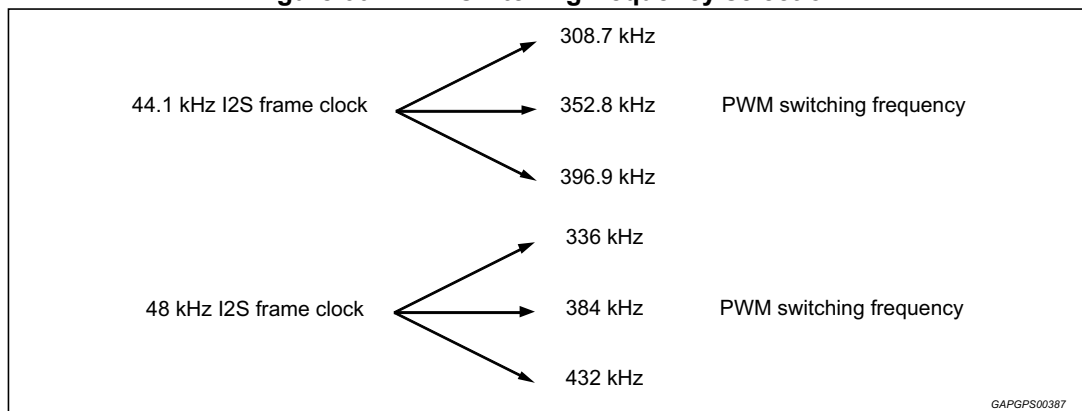

Actually, the PWM spectrum of the output square wave can be controlled in AM band just in case it is possible to fix the switching frequency, in other words without skipping any power stage commutation (typical phenomenon for a class D amplifier close to the clipping). The device provides an additional function called LRF (Low Radiation Function). This I²C option assures a minimum duty cycle for the PWM output square wave avoiding any missing pulses.

Figure 61. LRF effect on PWM output

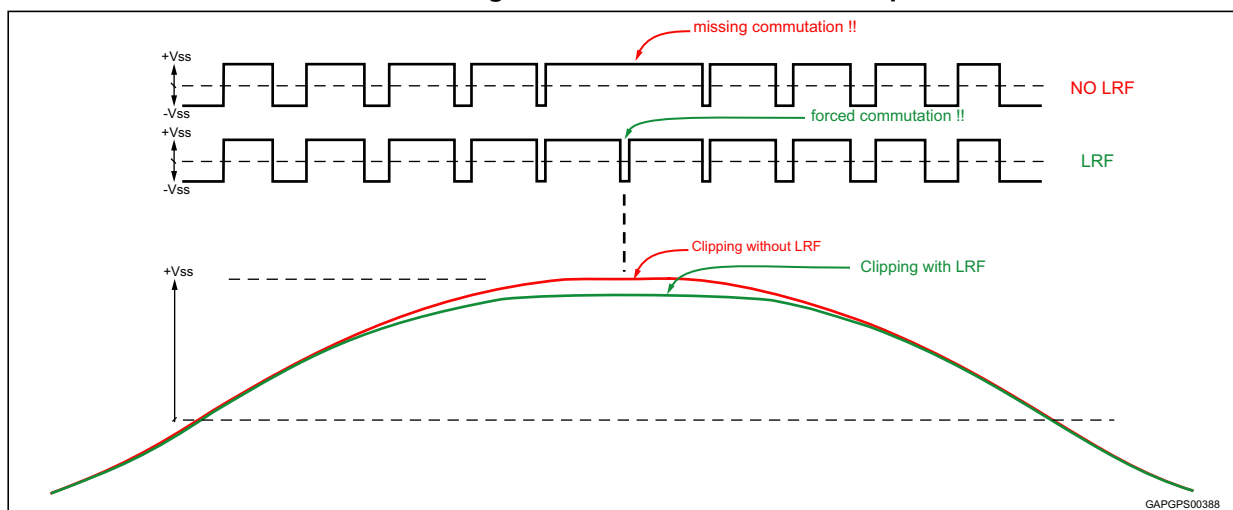

Please note that, by limiting the PWM duty cycle, a limitation of the output power occurs: the output power in case of usage of LRF function decreases about 10 % @ 1 % THD.

12.2 Noise gating

Noise gating is an automatic noise reduction feature that activates when output signal reaches not audible levels.

When input signal levels falls below -109 dBFs, the system activity is automatically optimized in order to exploit very low noise level on the output speakers.

The noise gating process has a 500 ms watching time before turning on, in order to avoid spurious activations.

The feature is enabled by default and can be disabled selecting IB3[1].

12.3 Dither PWM

The device implements a function, Dither PWM, which can be enabled through I²C bus by setting IB1[2].

The main target of this feature is to improve the EMC performances in the range [10 – 30 MHz], especially in MUTE condition.

The function consists in modulating the period of the output PWM. The function doesn't affect the average PWM frequency.

The modulation pattern is repeated every 8 PWM clock cycles, in order to avoid introducing significant noise in the audio bandwidth.

A qualitative example of the function operation is depicted in [Figure 62](#).

Figure 62. Dither PWM effect on output PWM

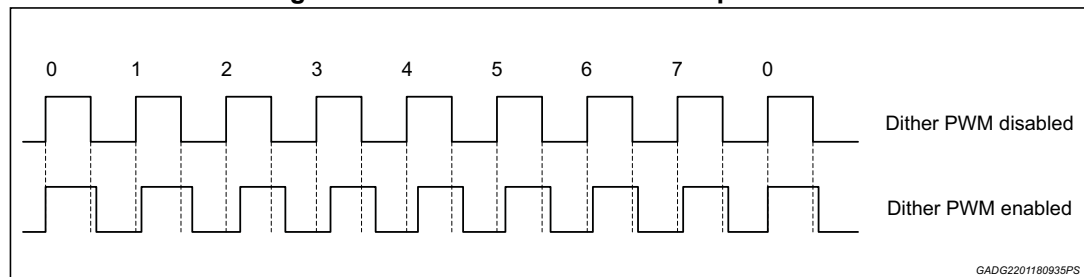

Note: The use of this function is suggested only with In Phase modulation.

12.4 Real time load current monitoring

FDA903D provides the current sensing function, an innovative feature for real time load monitoring. The continuous load monitoring enables many applications that could check, control and optimize the speakers operation for their entire life.

The current sensing circuit is the basis for the following diagnostic features: DC Diagnostic, Open Load in Play Detector and Output Current Offset Detector.

When the user enables the real time load current monitoring, the data collected by the current sensing circuit is also properly processed and directly provided to the user through I²S bus.

The overall current sensing path is shown in *Figure 63*:

Figure 63. Current sensing path

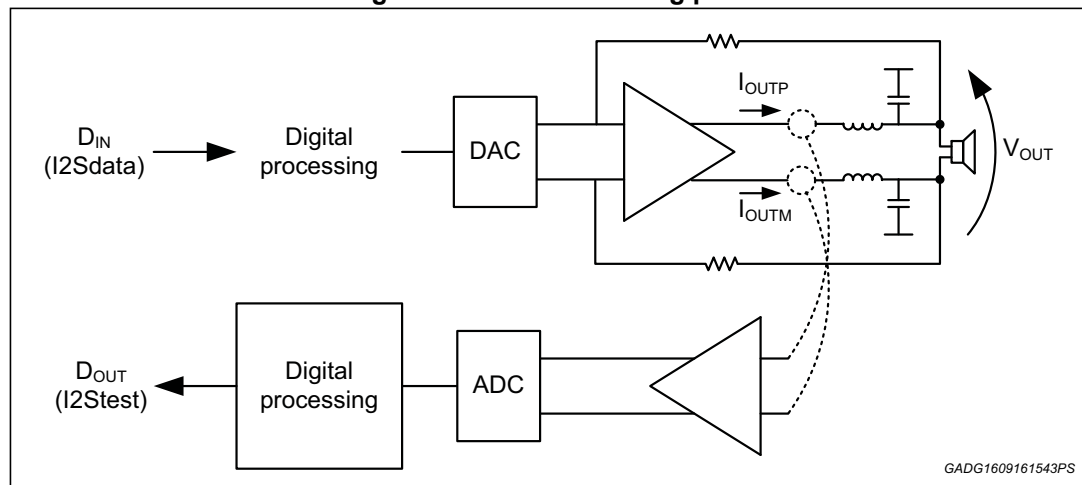

In particular, the output data represents the following current: $I_{CS}=(I_{OUTP}-I_{OUTM})/2$.

12.4.1 Result communication and I²C control

In order to enable the real time load current monitoring, the user must set $IB8[3-1]='011'$.

The default current sensing full scale is 8 A, but it can be configured through $IB8[7,6]$.

The current sensing stream is provided on I²S_{test} pin according to the following instructions:

- The data stream matches the same timings of I²S clock and I²S word select, according to the configuration set trough $IB0[5-1]$ and $IB1[7-5]$. The feature is available both in I²S and in TDM mode, guaranteeing the maximum flexibility.
- The I²S_{test} pin data could be generated on the I²S clock rising or on falling edge. The selection is possible properly setting $IB7[1]$, thus adapting to user system requirements.
- Each word is composed of 15 significant bits, placed in the 15 MSB of the 32-bits word marked by I²S word select slot. The words are coded with two's complement notation.

- The current sensing full scale set through IB8[7,6] corresponds to the following 15-bit digital word read on I2Stest:
 - 437.5 mFs if WS = 44.1 kHz or 48 kHz, IB1[4,3]='00'
 - 500 mFs if WS = 44.1 kHz or 48 kHz, IB1[4,3]='01'
 - 562.5 mFs if WS = 44.1 kHz or 48 kHz, IB1[4,3]='10'
 - 250 mFs if WS = 96 kHz
 - 125 mFs if WS = 192 kHz

The function provides the current information only in MUTE and PLAY states.

12.4.2 Current sensing limitations

The maximum current sensing full scale is 8 A, even if the device can drive up to 11 A typically.

The default full scale is 8 A. The user can choose a lower full scale in order to increase the resolution. However, setting a lower full scale is not suggested when enabling the Open Load in Play Detector or Output Current Offset Detector.

As depicted in [Figure 63](#), the current sensing provides the measured differential current flowing through OUPM and OUTM, which is different from the current flowing through the speaker due to the external filter capacitors. This mentioned contribution could be significant at high frequency. Moreover, the current sensing circuit comprehends a low-pass filter attenuating signals over 20 kHz frequency.

13 I²S bus interface

The device receives the audio signal through I²S bus.

The I²S bus is composed of three lines:

- Clock line (I2Sclk pin);
- Word Select line (I2Sws pin);
- Serial Data line (I2Sdata pin).

The Word Select line frequency must be always equal to the audio sampling frequency f_s . According to the I²C setting of IB1[7-5], the device supports the following standards for sampling frequency:

- 44.1 kHz;
- 48 kHz;
- 96 kHz;
- 192 kHz.

According to the I²C setting of IB0[6-5], the user can send the audio signal with the following data formats:

- I²S standard (max f_s = 192 kHz);
- TDM - 4CHs (max f_s = 192 kHz);
- TDM - 8CHs (max f_s = 96 kHz);
- TDM - 16CHs (max f_s = 48 kHz).

For all the mentioned data formats, the user must provide the data word following two's complement representation, starting from the MSB. The data word is composed of 32 bits: the device processes only the first 24 most significant bits, while it does not care the least significant 8 bits.

The internal PLL locks on the Clock line signal: when the I²S clock is missing or corrupted, the PLL consequently unlocks and the device forces the finite state machine in standby state. Furthermore, since the Clock line frequency is dependent on I²S bus configuration, it is strictly necessary to configure the I²C bits IB0[6-5] and IB1[7-5] accordingly.

13.1 I²S standard mode description

The I²S standard format is shown in *Figure 64*.

The Clock line frequency is equal to 64 fs.

With a proper I²C configuration, the user can select the channel containing the data to be processed:

- Right channel - IB0[4-1]='0000'
- Left channel - IB0[4-1]='0001'

Figure 64. I²S standard mode

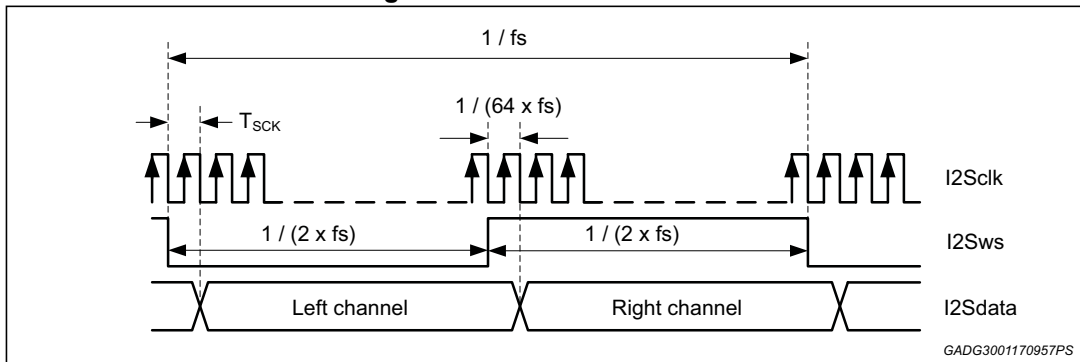

13.2 TDM 4CH mode description

The TDM4 format is shown in *Figure 65*.

The clock line frequency is equal to 128 fs.

With a proper I²C configuration, the user can select the slot containing the data to be processed:

- Slot 0 - IB0[4-1]='0000''
- Slot 1 - IB0[4-1]='0001''
- Slot 2 - IB0[4-1]='0010''
- Slot 3 - IB0[4-1]='0011'.

Figure 65. TDM4 mode

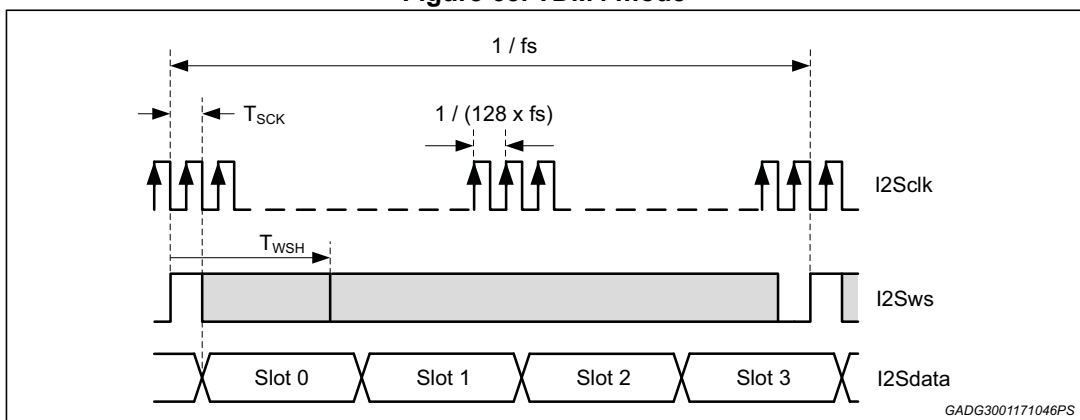

13.3 TDM 8CH mode description

The TDM8 format is shown in *Figure 66*.

The clock line frequency is equal to 256 fs.

With a proper I²C configuration, the user can select the slot containing the data to be processed:

- Slot 0 - IB0[4-1]='0000',
- Slot 1 - IB0[4-1]='0001',
- Slot 2 - IB0[4-1]='0010',
- Slot 3 - IB0[4-1]='0011',
- Slot 4 - IB0[4-1]='0100',
- Slot 5 - IB0[4-1]='0101',
- Slot 6 - IB0[4-1]='0110',
- Slot 7 - IB0[4-1]='0111'.

Figure 66. TDM8 mode

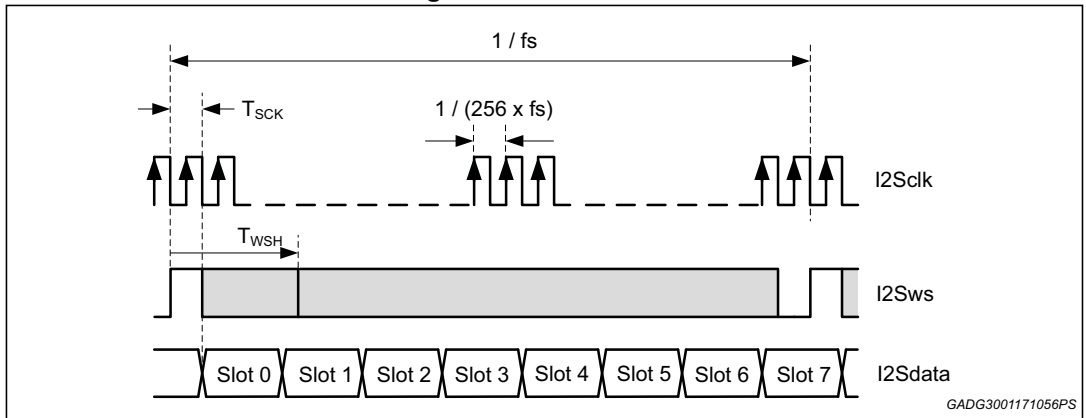

13.4 TDM 16CH mode description

The TDM8 format is shown in [Figure 67](#).

The clock line frequency is equal to 512 fs.

With a proper I²C configuration, the user can select the slot containing the data to be processed:

- Slot 0 - IB0[4-1]='0000',
- Slot 1 - IB0[4-1]='0001',
- Slot 2 - IB0[4-1]='0010',
- Slot 3 - IB0[4-1]='0011',
- Slot 4 - IB0[4-1]='0100',
- Slot 5 - IB0[4-1]='0101',
- Slot 6 - IB0[4-1]='0110',
- Slot 7 - IB0[4-1]='0111',
- Slot 8 - IB0[4-1]='1000',
- Slot 9 - IB0[4-1]='1001',
- Slot 10 - IB0[4-1]='1010',
- Slot 11 - IB0[4-1]='1011',
- Slot 12 - IB0[4-1]='1100',
- Slot 13 - IB0[4-1]='1101',
- Slot 14 - IB0[4-1]='1110',
- Slot 15 - IB0[4-1]='1111'.

Figure 67. TDM16 mode

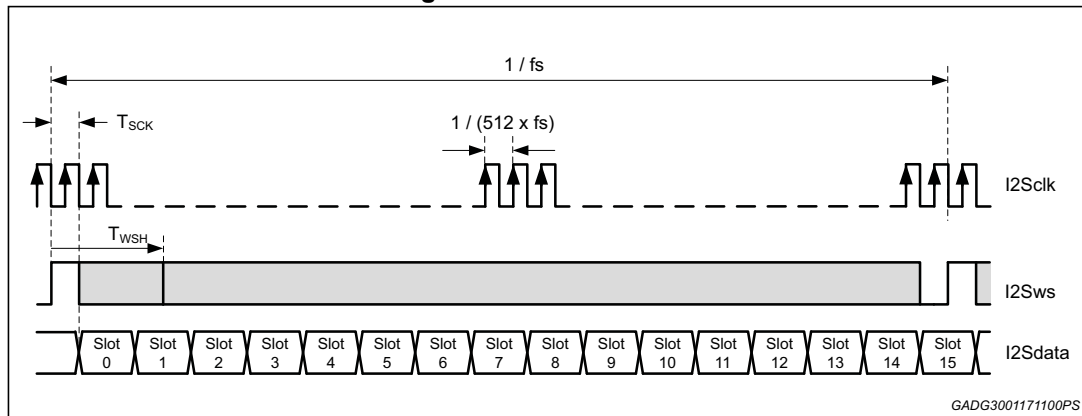

13.5 Timing requirements

Figure 68. I²S Interface timings

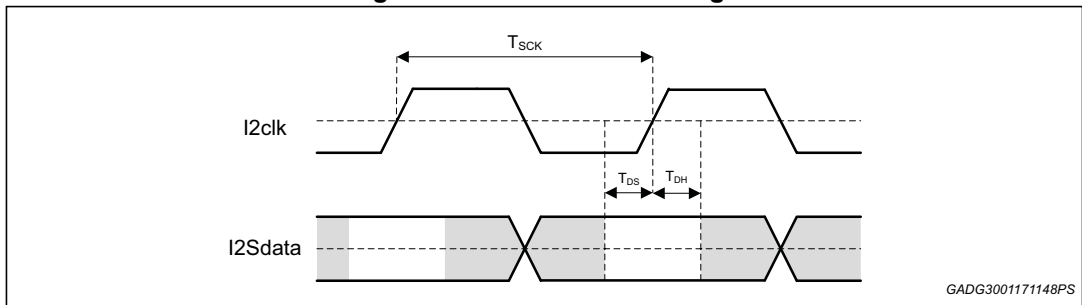

Figure 69. I²S clock transition timings

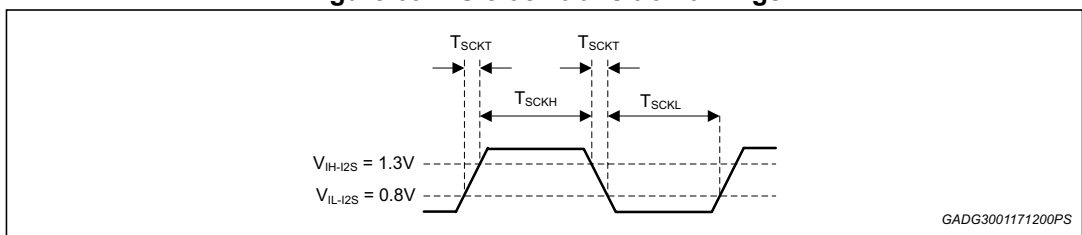

Table 10. I²S Interface timings

Symbol	Parameter	Note	Min	Max	Unit
T _{SCK}	I2S clock period		40.69		ns
	I2S clock period tolerance		0.9 x T _{SCK}	1.1 x T _{SCK}	
	I2S clock duty cycle		40	60	%
T _{SCKH}	I2S clock high time		15		ns
T _{SCKL}	I2S clock low time		15		ns
T _{SCKT}	I2S clock transition time			6	ns
T _{DS}	I2S data (and word select) setup time (before I2S clock rising edge)		8		ns
T _{DH}	I2S data (and word select) hold time (after I2S clock rising edge)		8		ns
T _{WSH}	I2S word select high time	I2S standard	32 x T _{SCK}		
		TDM4 format	1 x T _{SCK}	127 x T _{SCK}	
		TDM8 format	1 x T _{SCK}	255 x T _{SCK}	
		TDM16 format	1 x T _{SCK}	511 x T _{SCK}	

13.6 Group delay

The group delay depends on the sampling frequency f_s , properly configured with I2C bits IB1[7-5]. The typical value for all the configurations is reported in [Table 11](#):

Table 11. Group delay dependency from input sampling frequency

Input sampling frequency f_s	Group delay
44.1 kHz	465 μ s
48 kHz	430 μ s
96 kHz	50 μ s
192 kHz	30 μ s

14 I²C bus interface

Data transmission from microprocessor to the FDA903D and viceversa takes place through the 2 wires I²C bus interface, consisting of the two lines SDA and SCL (pull-up resistors to positive supply voltage must be connected).

When I²C bus is active any operating mode of the IC may be modified and the diagnostic may be controlled and results read back.

The protocol used for the bus is depicted in *Figure 70* and comprises:

- a start condition (S)
- a chip address byte (the LSB bit determines read/write transmission)
- a subaddress byte
- a sequence of data (N-bytes + acknowledge)
- a stop condition (P)

Figure 70. I²C bus protocol description

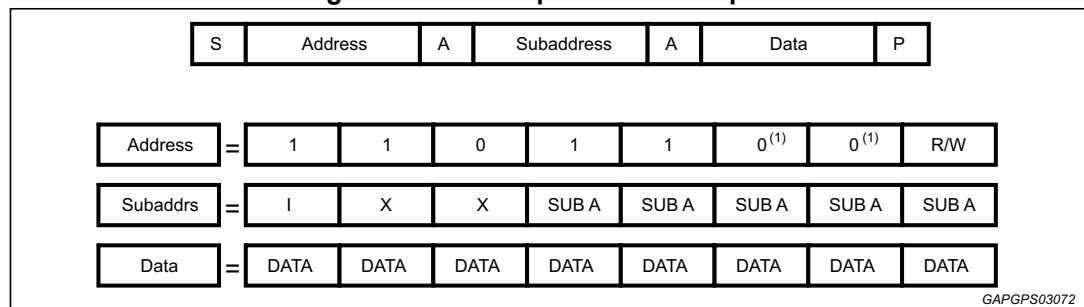

1. The I²C addresses are:
 Address 1 = 1110000
 Address 2 = 1110001
 Address 3 = 1110010
 Address 4 = 1110011
 Address 5 = 1110100
 Address 6 = 1110101
 Address 7 = 1110110
 Address 8 = 1110111

Description:

- S = Start
- R/W = '0' => Receive-Mode (Chip could be programmed by μP)
- I = Auto increment; when 1, the address is automatically incremented for each byte transferred
- X: not used
- A = Acknowledge
- P = Stop
- MAX CLOCK SPEED 400kbit/sec

14.1 Writing procedure

There are two possible procedures:

1. without increment: the I bit is set to 0 and the register is addressed by the subaddress. Only this register is written by the data following the subaddress byte.
2. with increment: the I bit is set to 1 and the first register write is the one addressed by subaddress. The registers are written from this address up to stop bit or the reaching of last register.

14.2 Reading procedure

The reading procedure is made up only by the device address (sent by master) and the data (sent by slave) as reported in *Figure 71* (a). In particular when a reading procedure is performed the first register read is the last addressed in a previous access to I²C peripheral.

Hence, to read a particular register also a sort of write action (a write interrupted after the sub-address is sent) is needed to specify which register has to be read. *Figure 71* (b) shows the complete procedure to read a specific register where:

- the master performs a write action by sending just the device address and the subaddress; the transmission must be interrupted with the stop condition when the subaddress is sent.
- now, the read procedure can be performed: the master starts a new communication and sends the device address; then the slave (FDA903D) will respond by sending the data bits.
- the read communication is ended by the master which sends a stop condition preceded by a not-acknowledge.

Instead, performing a start immediately after the stop condition could be possible for generating the repeated start condition (Sr) which also keeps busy the I²C bus until the stop is reached (*Figure 71* (c)).

Figure 71. Reading procedure

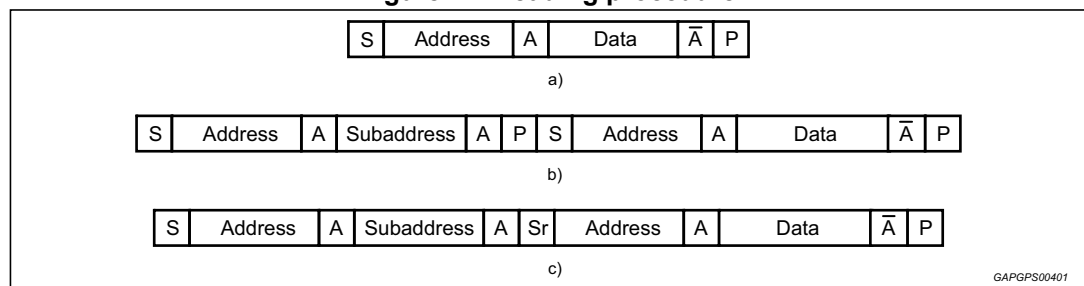

There are two possible reading procedures:

1. without auto-increment (*Figure 72* (a)) if the "I" bit of the last I²C writing procedure has been set to 0: in this case only the register addressed by the sub-address sent in the previous writing procedure is read;
2. with auto-increment (*Figure 72* (b)) if the "I" bit of the last I²C write procedure has been set to 1: in this case the first register read is the one addressed by sub-address sent in the previous writing procedure. Only the registers from this address up to the stop bit are read.

Figure 72. Without/with auto-increment reading procedure

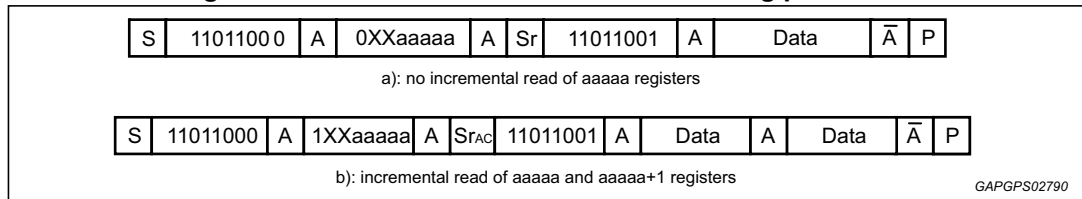

If a microcontroller tries to read an undefined register, FDA903D will return a "0xFF" data; for more details refer directly to I²C specification.

14.3 Data validity

The data on the SDA line must be stable during the high period of the clock. The HIGH and LOW state of the data line can only change when the clock signal on the SCL line is LOW.

14.4 Start and stop conditions

A start condition is a HIGH to LOW transition of the SDA line while SCL is HIGH. The stop condition is a LOW to HIGH transition of the SDA line while SCL is HIGH.

14.5 Byte format

Every byte transferred to the SDA line must contain 8 bits. Each byte must be followed by an acknowledge bit. The MSB is transferred first.

14.6 Acknowledge

The transmitter* puts a resistive HIGH level on the SDA line during the acknowledge clock pulse. The receiver** has to pull-down (LOW) the SDA line during the acknowledge clock pulse, so that the SDA line is stable LOW during this clock pulse.

* Transmitter

- = master (μP) when it writes an address to the FDA903D
- = slave (FDA903D) when the μP reads a data byte from FDA903D

** Receiver

- = slave (FDA903D) when the μP writes an address to the FDA903D
- = master (μP) when it reads a data byte from FDA903D

14.7 I²C timing

This paragraph describes more in detail the I²C bus protocol used and its timings.

Please refer to [Table 12](#) and [Figure 73](#) below.

Figure 73. I²C bus interface timing

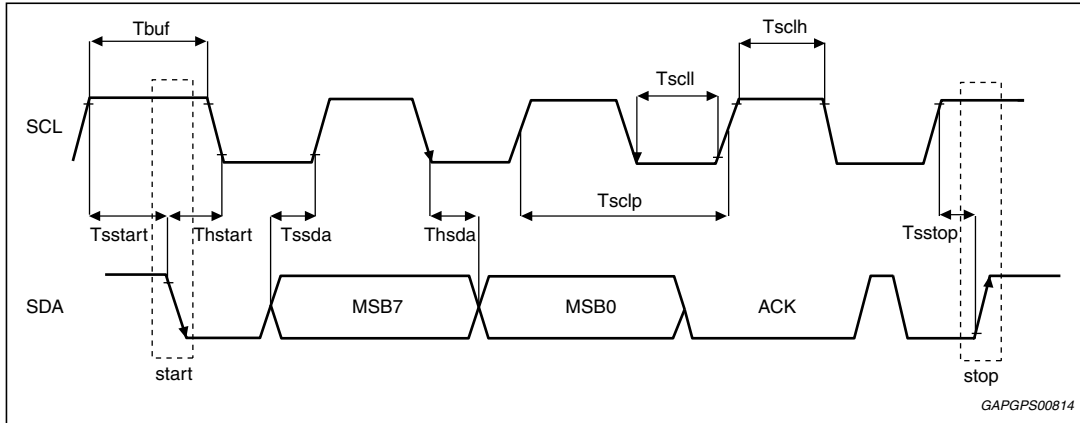

Table 12. I²C bus interface timing

Symbol	Parameter	Min	Max	Unit
Fscl	SCL (clock line) frequency	-	400	kHz
Tscl	SCL period	2500	-	ns
Tscelh	SCL high time	0.6	-	µs
Tscll	SCL low time	1.3	-	µs
Tsstart	Setup time for start condition	0.6	-	µs
Thstart	Hold time for start condition	0.6	-	µs
Tsstop	Setup time for stop condition	0.6	-	µs
Tbuf	Bus free time between a stop and a start condition	1.3	-	µs
Tssda	Setup time for data line	100	-	ns
Thsda	Hold time for data line	0 ⁽¹⁾	-	ns
Tf	Fall time for SCL and SDA	-	300	ns

1. Device must internally provide a hold time of at least 300 ns for the SDA signal to bridge the undefined region of the falling edge of SCL.

14.8 I²S, I²C and Enable relationship

FDA903D provides both I²C and I²S communication by means of two different digital interfaces but connected to each other interfaces and clock domains.

To program the I²C interface the I²S clock must be present, and at least 10 ms should have passed from the Enable pins setting event.

In FDA903D the digital part has different clock domains:

- The I²C programming block clock is the I²C clock
- The I²S receiver clock which is the I²S clock
- The system clock which is generated by an internal PLL.

The I²C commands are not effective if I²S clock is not present. However they will remain memorized inside I²C registers.

If I²S clock is lost the digital machine goes in standby.

I²S clock (SCK) should be given to device before enabling it (Enable pins set to 'out of standby').

15 I²C register

15.1 Instruction bytes- “I00xxxxx”

Table 13. IB0-ADDR: “I0000000”

Data bit	Default value	Definition
D7	0	Lock bit: 0 - Write on IBs is enable 1 - Write on IBs is disable
D6	00	Digital input settings: D6-D5 Input setting 00 I ² S standard 01 TDM – 4 CHs 10 TDM – 8 CHs 11 TDM – 16 CHs
D5		
D4-D1	0000	4 bits for channel position selection for I ² S standard, TDM4, 8 and 16: D4-D1 Position selection 0000 slot 0 (TDM mode) - right ch. (I2S mode) 0001 slot 1 (TDM mode) - left ch. (I2S mode) 0010 slot 2 (TDM mode) 0011 slot 3 (TDM mode) 0100 slot 4 (TDM 8 and 16 mode) 0101 slot 5 (TDM 8 and 16 mode) 0110 slot 6 (TDM 8 and 16 mode) 0111 slot 7 (TDM 8 and 16 mode) 1000 slot 8 (TDM 16 mode) 1001 slot 9 (TDM 16 mode) 1010 slot 10 (TDM 16 mode) 1011 slot 11 (TDM 16 mode) 1100 slot 12 (TDM 16 mode) 1101 slot 13 (TDM 16 only) 1110 slot 14 (TDM 16 only) 1111 slot 15 (TDM 16 only)
D0	0	0 - Standard voltage mode 1 - Low voltage mode

Table 14. IB1-ADDR: "I0000001"

Data bit	Default value	Definition																									
D7 - D6	00	Digital input frame sync frequency (Fs): D7-D6 Frame sync (WS) frequency 00 44.1 kHz 01 48 kHz 10 96 kHz 11 192 kHz																									
D5	0	Reserved																									
D4 - D3	00	Switching frequency expressed in kHz. D4-D3 I²S frame sync frequencies (WS) [kHz] <table border="1" data-bbox="584 680 1412 857"> <thead> <tr> <th></th> <th>44.1</th> <th>48</th> <th>96</th> <th>192</th> </tr> </thead> <tbody> <tr> <td>00</td> <td>308.7</td> <td>336</td> <td>384</td> <td>384</td> </tr> <tr> <td>01</td> <td>352.8</td> <td>384</td> <td>384</td> <td>384</td> </tr> <tr> <td>10</td> <td>396.9</td> <td>432</td> <td>384</td> <td>384</td> </tr> <tr> <td>11</td> <td>Reserved</td> <td>Reserved</td> <td>Reserved</td> <td>Reserved</td> </tr> </tbody> </table>		44.1	48	96	192	00	308.7	336	384	384	01	352.8	384	384	384	10	396.9	432	384	384	11	Reserved	Reserved	Reserved	Reserved
	44.1	48	96	192																							
00	308.7	336	384	384																							
01	352.8	384	384	384																							
10	396.9	432	384	384																							
11	Reserved	Reserved	Reserved	Reserved																							
D2	0	0 - PWM amplifier clock not dithered 1 - PWM amplifier clock dithered																									
D1	0	Reserved																									
D0	0	0 - PWM in phase 1 - PWM out of phase																									

Table 15. IB2-ADDR: "I0000010"

Data bit	Default value	Definition
D7-D6	00	"DiagShort2Supply" timing selection: D7-D6 Timing 00 90 ms 01 70 ms 10 45 ms 11 20 ms
D5	0	Reserved
D4	0	0 - Low radiation function OFF 1 - Low radiation function ON
D3 - D0	0000	Power limiting Function configuration D3-D0 Power limiting Config 0000 Power limiter disabled 0001 Power limited with maximum voltage scale at 15% 0010 Power limited with maximum voltage scale at 20% 0011 Power limited with maximum voltage scale at 25% 0100 Power limited with maximum voltage scale at 30% 0101 Power limited with maximum voltage scale at 35% 0110 Power limited with maximum voltage scale at 40% 0111 Power limited with maximum voltage scale at 45% 1000 Power limited with maximum voltage scale at 50% 1001 Power limited with maximum voltage scale at 60% 1010 Power limited with maximum voltage scale at 70% 1011 Power limited with maximum voltage scale at 80% 1100 Reserved 1101 Reserved 1110 Reserved 1111 Reserved

Table 16. IB3-ADDR: “I0000011”

Data bit	Default value	Definition
D7 - D7	0	Reserved
D5	0	0 - Output Voltage offset detector disable 1 - Output Voltage offset detector enable
D4	0	0 - Input offset detector disable 1 - Input offset detector enable
D3	0	0 - Output Current offset / hot spot detector disable 1 - Output Current offset / hot spot detector enable
D2	0	0 - No Highpass in the DAC 1 - Highpass in the DAC
D1	0	0 - Noise gating enable 1 - Noise gating disable
D0	0	0 - Open Load detection in play disable 1 - Open Load detection in play enable

Table 17. IB4-ADDR: “I0000100” - CDDiag pin configuration

Data bit	Default value	Definition
D7	0	0 - No Output Voltage offset information on CDDiag pin 1 - Output Voltage offset information on CDDiag pin
D6-D4	00	Temperature warning information on CD/DIAG pin: D6-D4 CDDiag configuration 000 No thermal warning 001 TW1 010 TW2 011 TW3 100 TW4 101 Reserved 110 Reserved 111 Reserved
D3	0	0 - No Overcurrent information on CD/DIAG pin 1 - Overcurrent information on CD/DIAG pin
D2	0	0 - No Input Offset information on CD/DIAG pin 1 - Input Offset information on CD/DIAG pin
D1	0	0 - No Short to Vcc / Short to GND information on CD/DIAG pin 1 - Short to Vcc / Short to GND information on CD/DIAG pin
D0	0	0 - No High Voltage Mute information on CD/Diag pin 1 - High Voltage Mute information on CD/Diag pin

Table 18. IB5-ADDR: "10000101" - CDDiag pin configuration

Data bit	Default value	Definition
D7	0	0 - No UVLOVCC information on CDDiag pin 1 - UVLOVCC information on CDDiag pin
D6	0	0 - No Thermal shutdown information on CDDiag pin 1 - Thermal shutdown information on CDDiag pin
D5-D4	00	Clipping information on CDDiag pin: D5-D4 CDDiag configuration 00 No clipping information 01 PWM Pulse Skipping detector 10 Reserved 11 Reserved
D3-D0	0000	Reserved

Table 19. IB6-ADDR: "10000110"

Data bit	Default value	Definition
D7-D6	00	Mute timing setup, (values with fsample = 44.1 kHz): D7-D6 Type of mute Mute time Unit 00 Very Fast 3 ms 01 Fast 45 ms 10 Slow 90 ms 11 Very Slow 185 ms
D5	0	Audio signal gain control: 0 - standard digital audio gain 1 - +6 db digital audio gain
D4	0	0 - standard gain 1 - low gain
D3-D0	0000	Reserved

Table 20. IB7-ADDR: “10000111”

Data bit	Default value	Definition
D7-D6	00	Diagnostic ramp time selection: D7-D6 Timing 00 Normal 01 x2 10 x4 11 /2
D5-D4	00	Diagnostic Hold Time selection: D5-D4 Timing 00 Normal 01 x2 10 x4 11 /2
D3-D2	00	Reserved
D1	0	Current sensing data communication 0 - data out generated on I2S clock falling edge 1 - data out generated on I2S clock rising edge
D0	0	Current sensing protocol configuration: 0 - Force I2Stest at '0' on other slots 1 - Set transmitter in HiZ state on other slots

Table 21. IB8-ADDR: "10001000" - CHANNEL CONTROLS

Data bit	Default value	Definition
D7-D6	11	Current Sensing Full scale setting: D7-D6 I_{max} 00 1 A 01 2 A 10 4 A 11 8 A
D5	0	0 - Channel in TRISTATE (PWM OFF) 1 - Channel with PWM ON
D4	0	0 - Channel DC Diag disable 1 - Channel DC Diag start
D3-D1	000	I2Stest pin configuration: D3-D1 Function 000 High impedance configuration 001 Reserved 010 Reserved 011 Output: Current sensing enable 100 Reserved 101 Output: PWM synchronization signal 110 Reserved 111 Reserved
D0	0	0 - Channel in MUTE 1 - Channel in PLAY

Table 22. IB9-ADDR: "10001001"

Data bit	Default value	Definition
D7-D5	000	Reserved
D4	0	0 - watch-dog for word select managing 1 - no watch-dog for word select managing
D3-D0	0000	Reserved

Table 23. IB10-ADDR: "I0001010"

Data bit	Default value	Definition
D7	0	Short load impedance threshold (DC Diagnostic): 0 - 0.75 Ω 1 - 0.5 Ω
D6	0	Open load impedance threshold (DC Diagnostic & Open load in play detector): 0 - 25 Ω 1 - 15 Ω
D5	0	Reserved
D4-D3	10	Output Current Offset Detector threshold configuration D3-D2 Offset Detector threshold 00 Reserved 01 0.25 A (i.e. 2 V with 8 Ω load) 10 0.5 A (i.e. 2 V with 4 Ω load) 11 1.0 A (i.e. 2 V with 2 Ω load)
D2-D0	000	Reserved

Table 24. IB11-ADDR: "I0001011"

Data bit	Default value	Definition
D7-D6	00	Reserved
D5-D4	0	Over current protection level selection: D5 D4 Iprot VDD>5.4V Iprot VDD<5.4V 0 0 11A 6A 0 1 8A 6A 1 0 6A 4A 1 1 4A 4A
D3	0	0 - Deafult 1 - PWM Slow Slope
D2-D0	000	Reserved

Table 25. IB12-ADDR: "I0001100"

Data bit	Default value	Definition
D7	0	0 - Standard thermal warning 1 - Thermal warning shift -15 °C
D6-D0	0001000	Reserved

Table 26. IB13-ADDR: "I0001101"

Data bit	Default value	Definition
D7	0	Reserved
D6	0	0 - Digital mute enabled in PLAY when StartAnalogMute without Thermal Warning 1 occurs 1 - Digital mute disabled in PLAY when StartAnalogMute without Thermal Warning 1 occurs
D5-D0	100000	Reserved

Table 27. IB14-ADDR: "I0001110"

Data bit	Default value	Definition																		
D7-D5	000	Reserved																		
D4	0	0 - feedback on LC filter 1 - feedback on Out Pin																		
D3	100	LC filter setup: <table border="0" style="margin-left: 20px;"> <thead> <tr> <th style="text-align: left;">d3-d2-d1</th> <th style="text-align: left;">LC filter</th> </tr> </thead> <tbody> <tr> <td>000</td> <td>Reserved</td> </tr> <tr> <td>001</td> <td>10 μH + 2.2 μF Out Phase</td> </tr> <tr> <td>010</td> <td>10 μH + 2.2 μF In Phase</td> </tr> <tr> <td>011</td> <td>10 μH + 3.3 μF Out Phase</td> </tr> <tr> <td>100</td> <td>10 μH + 3.3 μF In Phase</td> </tr> <tr> <td>101</td> <td>10 μH + 4.7 μF Out Phase</td> </tr> <tr> <td>110</td> <td>10 μH + 4.7 μF In Phase</td> </tr> <tr> <td>111</td> <td>Reserved</td> </tr> </tbody> </table>	d3-d2-d1	LC filter	000	Reserved	001	10 μH + 2.2 μF Out Phase	010	10 μH + 2.2 μF In Phase	011	10 μH + 3.3 μF Out Phase	100	10 μH + 3.3 μF In Phase	101	10 μH + 4.7 μF Out Phase	110	10 μH + 4.7 μF In Phase	111	Reserved
d3-d2-d1			LC filter																	
000			Reserved																	
001			10 μH + 2.2 μF Out Phase																	
010	10 μH + 2.2 μF In Phase																			
011	10 μH + 3.3 μF Out Phase																			
100	10 μH + 3.3 μF In Phase																			
101	10 μH + 4.7 μF Out Phase																			
110	10 μH + 4.7 μF In Phase																			
111	Reserved																			
D2																				
D1																				
D0	0	0 – FIRST setup not programmed via I ² C 1 – FIRST setup programmed – ready to work																		

15.2 Data bytes - “I01xxxx”

Legend:

- Type "S/C": the hardware can only set the flag. An I²C reading operation clears the flag.
- Type "SR/C": the hardware can set or reset the flag. An I²C reading operation clears the flag.
- Type "SR": the hardware can both set or reset the flag. An I²C reading operation doesn't affect the flag.

Table 28. DB0-ADDR: “I0100000”

Data bit	Type	Definition
D7	S/C	0 – Offset at input not present 1 – Offset at input present
D6	SR/C	0 – Output Current offset not valid 1 – Output Current offset valid
D5	SR/C	0 – Output Current offset not present 1 – Output Current offset present
D4	S/C	Reserved
D3	S/C	0 – Output Voltage offset not present 1 – Output Voltage offset present
D2	SR/C	0 – Open Load in Play test not ended 1 – Open Load in Play test ended
D1	SR/C	0 – Open Load in Play test input signal not valid 1 – Open Load in Play test input signal valid
D0	SR/C	0 – Open Load in Play not detected 1 – Open Load in Play detected

Table 29. DB1-ADDR: "I0100001"

Data bit	Type	Definition
D7	SR/C	0 – Thermal warning 1 not active 1 – Thermal warning 1 active
D6	SR/C	0 – Thermal warning 2 not active 1 – Thermal warning 2 active
D5	SR/C	0 – Thermal warning 3 not active 1 – Thermal warning 3 active
D4	SR/C	0 – Thermal warning 4 not active 1 – Thermal warning 4 active
D3	SR/C	0 - PLL not locked 1 - PLL locked
D2	S/C	0 - UVLOALL not detected 1 - UVLOALL detected (NOTE: after turn-on, the first reading of this flag will be always 1)
D1	S/C	0 - No Overvoltage Shutdown detected 1 - Overvoltage Shutdown detected
D0	S/C	0 - PWM pulse skipping not detected 1 - PWM pulse skipping detected

Table 30. DB2-ADDR: "I0100010"

Data bit	Type	Definition
D7	SR/C	0 – Channel DC diagnostic pulse not ended 1 – Channel DC diagnostic pulse ended
D6	SR/C	0 – Channel DC diagnostic data not valid 1 – Channel DC diagnostic data valid
D5	S/C	0 – Channel Over current not detected 1 – Channel Over current protection triggered
D4	SR/C	0 – No Short Load on Channel 1 – Short Load on Channel
D3	SR	0 – No Short to Vcc on Channel 1 – Short to Vcc on Channel
D2	SR	0 – No short to Gnd on Channel 1 – Short to Gnd on Channel
D1	SR/C	0 – No Open Load on Channel 1 – Open Load on Channel
D0	SR/C	0 – Channel in mute 1 – Channel in play

Table 31. DB3-ADDR: "I0100011" DC Diagnostic Error code

Data bit	Type	Definition
D7	SR/C	DC Diagnostic Error code
D6		
D5		
D4		
D3		
D2		
D1		
D0		

Table 32. DB4-ADDR:"I0100100" - Current Sensing data (10-8)

Data bit	Type	Definition
D7-D3	SR	Reserved
D2	SR	Channel Current Sensing (10-8)
D1		
D0		

Table 33. DB5-ADDR:"I0100101" - Current Sensing data (7-0)

Data bit	Type	Definition
D7	SR	Channel Current Sensing (7-0)
D6		
D5		
D4		
D3		
D2		
D1		
D0		

Table 34. DB6-ADDR:"I0100110"

Data bit	Type	Definition
D7	S/C	0 – High Voltage Mute not Started 1 – High Voltage Mute Started
D6	S/C	0 – UVLO _{VCC} not detected 1 – UVLO _{VCC} detected
D5	S/C	0 – Thermal shutdown not detected 1 – Thermal shutdown detected
D4	S/C	0 – No analog mute started 1 – Start analog mute (-0.5 dB attenuation reached)
D3	S/C	Reserved
D2	SR/C	0 – watch-dog for word select not occurred 1 – watch-dog for word select occurred
D1	S/C	0 – no error frame checked 1 – error frame checked
D0	S/C	Reserved

Table 35. PowerSSO-36 exposed pad (D1 and E2 use the option variation B) package mechanical data

Ref	Dimensions					
	Millimeters			Inches ⁽¹⁾		
	Min.	Typ.	Max.	Min.	Typ.	Max.
θ	0°	-	8°	0°	-	8°
θ1	5°	-	10°	5°	-	10°
θ2	0°	-	-	0°	-	-
A	2.15	-	2.45	0.0846	-	0.0965
A1	0.0	-	0.1	0.0	-	0.0039
A2	2.15	-	2.35	0.0846	-	0.0925
b	0.18	-	0.32	0.0071	-	0.0126
b1	0.13	0.25	0.3	0.0051	0.0098	0.0118
c	0.23	-	0.32	0.0091	-	0.0126
c1	0.2	0.2	0.3	0.0079	0.0079	0.0118
D ⁽²⁾	10.30 BSC			0.4055 BSC		
D1	VARIATION					
D2	-	3.65	-	-	0.1437	-
D3	-	4.3	-	-	0.1693	-
e	0.50 BSC			0.0197 BSC		
E	10.30 BSC			0.4055 BSC		
E1 ⁽²⁾	7.50 BSC			0.2953 BSC		
E2	VARIATION					
E3	-	2.3	-	-	0.0906	-
E4	-	2.9	-	-	0.1142	-
G1	-	1.2	-	-	0.0472	-
G2	-	1	-	-	0.0394	-
G3	-	0.8	-	-	0.0315	-
h	0.3	-	0.4	0.0118	-	0.0157
L	0.55	0.7	0.85	0.0217	-	0.0335
L1	1.40 REF			0.0551 REF		
L2	0.25 BSC			0.0098 BSC		
N	36			1.4173		
R	0.3	-	-	0.0118	-	-
R1	0.2	-	-	0.0079	-	-
S	0.25	-	-	0.0098	-	-

Table 35. PowerSSO-36 exposed pad (D1 and E2 use the option variation B) package mechanical data (continued)

Ref	Dimensions					
	Millimeters			Inches ⁽¹⁾		
	Min.	Typ.	Max.	Min.	Typ.	Max.
Tolerance of form and position						
aaa	0.2			0.0079		
bbb	0.2			0.0079		
ccc	0.1			0.0039		
ddd	0.2			0.0079		
eee	0.1			0.0039		
fff	0.2			0.0079		
ggg	0.15			0.0059		
VARIATIONS						
Option A						
D1	6.5	-	7.1	0.2559	-	0.2795
E2	4.1	-	4.7	0.1614	-	0.1850
Option B						
D1	4.9	-	5.5	0.1929	-	0.2165
E2	4.1	-	4.7	0.1614	-	0.1850
Option C						
D1	6.9	-	7.5	0.2717	-	0.2953
E2	4.3	-	5.2	0.1693	-	0.2047

1. Values in inches are converted from mm and rounded to 4 decimal digits.
2. Dimensions D and E1 do not include mold flash or protrusions. Allowable mold flash or protrusions is '0.25 mm' per side D and '0.15 mm' per side E1. D and E1 are Maximum plastic body size dimensions including mold mismatch.

16.2 Package marking information

Figure 75. PowerSSO-36 (exp. pad) marking information

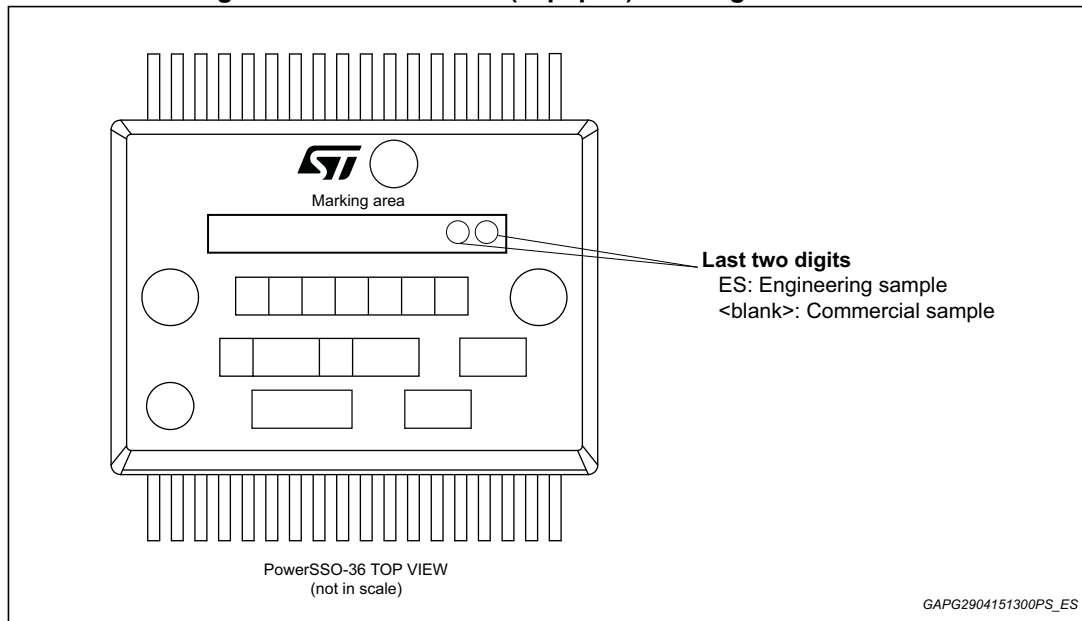

Note: *Engineering Samples: these samples are clearly identified by last two digits 'ES' in the marking of each unit. These samples are intended to be used for electrical compatibility evaluation only; usage for any other purpose may be agreed only upon written authorization by ST. ST is not liable for any customer usage in production and/or in reliability qualification trials.*

Commercial Samples: Fully qualified parts from ST standard production with no usage restrictions.

17 Revision history

Table 36. Document revision history

Date	Revision	Changes
26-Feb-2018	1	Initial release.
03-May-2018	2	Datasheet changed from Confidentiality level to Public.

IMPORTANT NOTICE – PLEASE READ CAREFULLY

STMicroelectronics NV and its subsidiaries ("ST") reserve the right to make changes, corrections, enhancements, modifications, and improvements to ST products and/or to this document at any time without notice. Purchasers should obtain the latest relevant information on ST products before placing orders. ST products are sold pursuant to ST's terms and conditions of sale in place at the time of order acknowledgement.

Purchasers are solely responsible for the choice, selection, and use of ST products and ST assumes no liability for application assistance or the design of Purchasers' products.

No license, express or implied, to any intellectual property right is granted by ST herein.

Resale of ST products with provisions different from the information set forth herein shall void any warranty granted by ST for such product.

ST and the ST logo are trademarks of ST. All other product or service names are the property of their respective owners.

Information in this document supersedes and replaces information previously supplied in any prior versions of this document.

© 2018 STMicroelectronics – All rights reserved

Компания «Океан Электроники» предлагает заключение долгосрочных отношений при поставках импортных электронных компонентов на взаимовыгодных условиях!

Наши преимущества:

- Поставка оригинальных импортных электронных компонентов напрямую с производств Америки, Европы и Азии, а так же с крупнейших складов мира;
- Широкая линейка поставок активных и пассивных импортных электронных компонентов (более 30 млн. наименований);
- Поставка сложных, дефицитных, либо снятых с производства позиций;
- Оперативные сроки поставки под заказ (от 5 рабочих дней);
- Экспресс доставка в любую точку России;
- Помощь Конструкторского Отдела и консультации квалифицированных инженеров;
- Техническая поддержка проекта, помощь в подборе аналогов, поставка прототипов;
- Поставка электронных компонентов под контролем ВП;
- Система менеджмента качества сертифицирована по Международному стандарту ISO 9001;
- При необходимости вся продукция военного и аэрокосмического назначения проходит испытания и сертификацию в лаборатории (по согласованию с заказчиком);
- Поставка специализированных компонентов военного и аэрокосмического уровня качества (Xilinx, Altera, Analog Devices, Intersil, Interpoint, Microsemi, Actel, Aeroflex, Peregrine, VPT, Syfer, Eurofarad, Texas Instruments, MS Kennedy, Miteq, Cobham, E2V, MA-COM, Hittite, Mini-Circuits, General Dynamics и др.);

Компания «Океан Электроники» является официальным дистрибьютором и эксклюзивным представителем в России одного из крупнейших производителей разъемов военного и аэрокосмического назначения «JONHON», а так же официальным дистрибьютором и эксклюзивным представителем в России производителя высокотехнологичных и надежных решений для передачи СВЧ сигналов «FORSTAR».



JONHON

«JONHON» (основан в 1970 г.)

Разъемы специального, военного и аэрокосмического назначения:

(Применяются в военной, авиационной, аэрокосмической, морской, железнодорожной, горно- и нефтедобывающей отраслях промышленности)

«FORSTAR» (основан в 1998 г.)

ВЧ соединители, коаксиальные кабели, кабельные сборки и микроволновые компоненты:

(Применяются в телекоммуникациях гражданского и специального назначения, в средствах связи, РЛС, а так же военной, авиационной и аэрокосмической отраслях промышленности).



Телефон: 8 (812) 309-75-97 (многоканальный)

Факс: 8 (812) 320-03-32

Электронная почта: ocean@oceanchips.ru

Web: <http://oceanchips.ru/>

Адрес: 198099, г. Санкт-Петербург, ул. Калинина, д. 2, корп. 4, лит. А