

SDN-C Compact DIN Rail Series

The SDN-C DIN rail power supplies are the next generation of the popular SDN series. These models combine high efficiency and compact size with new visual diagnostic LEDs to offer the most performance available from SolaHD. Essential industrial features such as Sag Immunity, Power Factor Correction, and universal voltage input have been retained in this series. Wide temperature operating range and parallel operation capability make the new SDN-C units suitable to a variety of industrial applications.

Applications

- Industrial Machine Control and Process Control
- Conveying Equipment
- Material Handling
- Vending Machines
- Packaging Equipment and Amusement Park Equipment
- Semiconductor Fabrication Equipment
- DeviceNet™

Features



- Compact packaging to save space on the DIN rail
- Visual diagnostic LEDs for input and output status at a glance
- High MTBF means high reliability and long life
- Higher efficiency saves energy and lowers amount of heat generated in panel
- PowerBoost™ overload capability to start high inrush loads
- Accepts Universal voltage 85-264 Vac, 50/60 Hz input
- Active Power Factor Correction
- Patented DIN rail mounting clip
- User Adjustable output voltage accessible via front face
- Parallel capability standard
- Large, rugged, accessible screw terminals
- Industrial grade design
 - -25°C to 60°C operation without derating
- Fully tested and burned-in at factory
- Highly efficient switching technology
- Five year limited warranty

Certifications and Compliances *

All Models

-  Listed, Ind. Control Equipment, E61379
 - UL 508, CSA C22.2 No. 107.1





-  UL Recognized Component, ITE, E137632
 - UL 60950-1/CSA C22.2 No. 60950-1, 2nd Edition
-  - Low Voltage Directive
 - IEC/EN60950-1, 2nd Edition
- Sag Immunity: SEMI F47
- RoHS Compliant

Models SDN 20-24-100C, SDN 20-24-480CC, SDN 40-24-480C

-  UL Recognized Component, Haz. Loc., E234790
 - ISA 12.12.01, CSA C22.2 No. 213
 - Class I, Division 2, Groups A, B, C, D

Models SDN 5-24-100C, SDN 10-24-100C, SDN 40-24-100C, SDN 5-24-480C, SDN 10-24-480C

-  UL Recognized Component, Haz. Loc., E234790
 - UL 60079-15/CSA E60079-15
 - Class I, Zone 2, AEx nC IIC, Ex nC IIC
-  ATEX Directive
 - EN60079-0, EN60079-15
 -  II 3 G, Ex nC IIC Gc

Related Products

- SDN-P series
- SDP™ series
- SCP series
- SDU UPS

Accessories

- Chassis Mount Bracket (SDN-PMBRK2)

* Refer to user manual for installation requirements when used in hazardous locations.

The SolaHD Difference

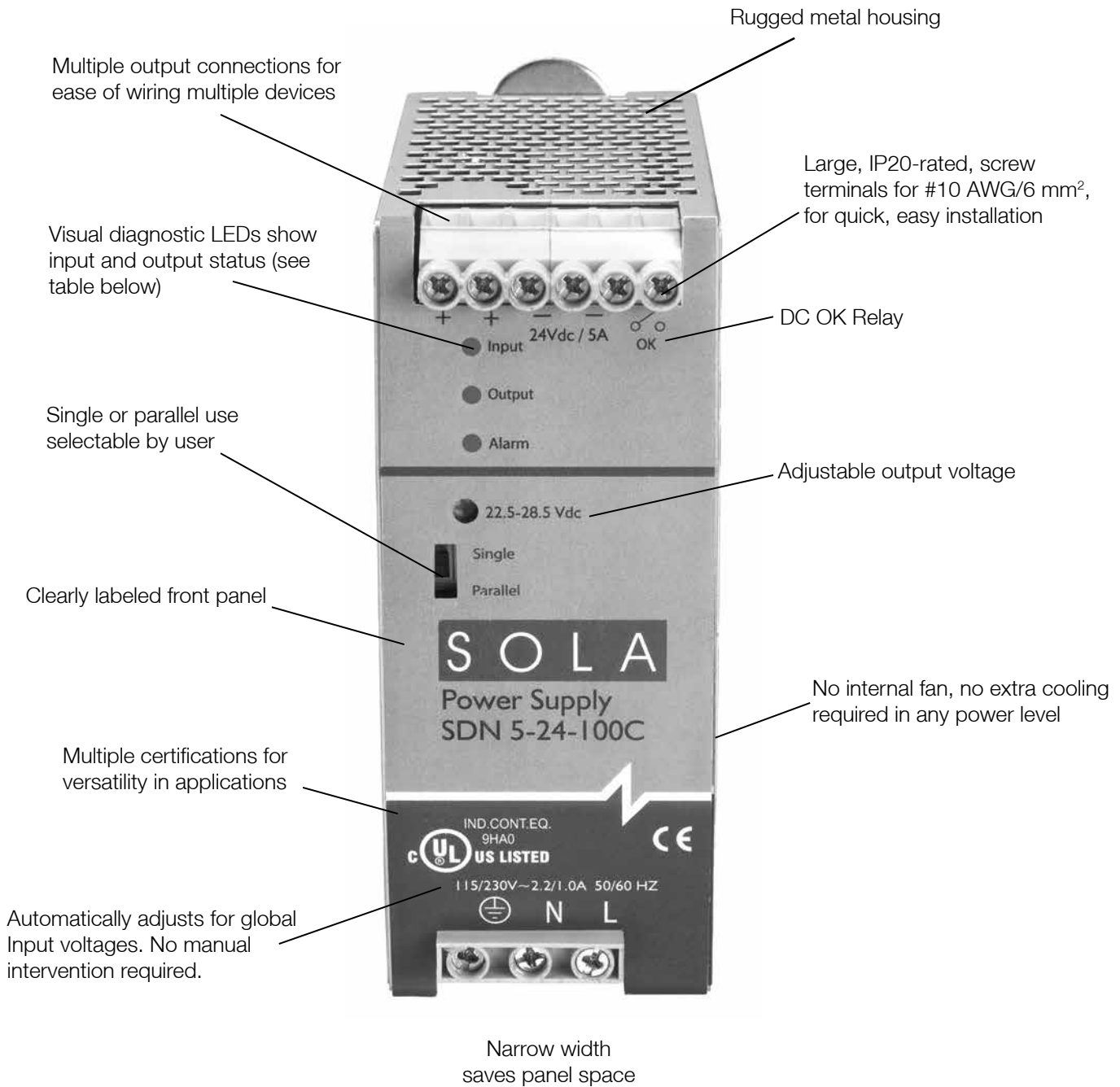

LED Light Status Conditions

	Normal	AC Power Loss	AC Input Low	No DC	High Load	Overload	Hot	Too Hot
Input	Green	-	Yellow	Green	Green	Green	Green	Green
Output	Green	-	Green	-	Yellow	Yellow	Green	-
Alarm	-	-	-	Red	Yellow	Red	Yellow	Yellow

SDN-C Specifications (Single Phase)

Description	Catalog Number	
	SDN 5-24-100C	SDN 10-24-100C
Input		
Nominal Voltage	115 - 230 Vac	
-AC Range	85 - 264 Vac	
-DC Range ¹	90 - 375 Vdc	
-Frequency	43 - 67 Hz	
Nominal Current ²	1.65 - 0.55 A	3.2 - 1.0 A
-Inrush current max.	Typ. < 15 A	Typ. < 30 A
Efficiency (Losses ³)	> 88% typ. (14 W)	> 90% typ. (24 W)
Power Factor Correction	Active power factor correction to better than 0.92	
Output		
Nominal Voltage ⁴	24 V (23.5~28.5 Vdc Adj.)	
-Tolerance	< ±2 % overall (combination Line, load, time and temperature related changes)	
Initial Voltage Setting	24.5 V ± 1%	
-Ripple ⁵	< 50 mVpp	
PARD	PARD (Periodic and Random Deviation) = 100 mV peak-peak max	
Overvoltage Protection	> 30.5 but < 33 Vdc, auto recovery	
Power Back Immunity	< 35 V	
Nominal Current	5 A (120 W)	10 A (240 W)
-Peak Current ⁶	1.5 x Nominal Current for 4 seconds minimum while holding voltage > 20 Vdc	
-Short Circuit Current	1.5 x Nominal Current at near zero volts at short circuit condition	
-Current Limit	PowerBoost™	
Parallel Operation	Switch selectable single unit or parallel unit operation. Units will not be damaged by parallel operation (regardless of switch position setting).	
Holdup Time	>20 ms (Full load, 100 Vac Input @ T _{amb} = +25°C) to 95% output voltage	
Voltage Fall Time	<150 mS from 95% to 10% rated voltage @ full load (T _{amb} = +25°C)	
Line and Load Regulation	< 0.5%	
General		
EMC: -Emissions	EN61000-6-2:2001, EN61000-6-3:2001, Class B EN55011, EN55022 Radiated and Conducted including Annex. A, EN61000-3-2	
-Immunity	EN61000-6-1:2001, EN61000-6-2:2001, EN61000-4-2 Level 4, EN61000-4-3 Level 3, EN61000-4-6 Level 3, EN61000-4-4 Level 4 input and level 3 output. EN61000-4-5 Isolation class 4, EN61000-4-11, IEC 61000-4-34 voltage dip immunity standard	
Temperature ⁷	Storage: -40°C to + 85°C, Operation -25°C to +60°C full power, with linear derating to half power from 60 to 70°C (Convection cooling, no forced air required). Operation up to 50% load permissible with sideways or front side up mounting orientation.	
MTBF ⁸	> 550,000 hrs	
Warranty	5 Year Limited Warranty	
General Protection/ Safety	Protected against continuous short -circuit, continuous overload, continuous open circuit. Protection Class 1 (IEC536), degree of protection IP20 (IEC60529) Safe low voltage: SELV (acc. IEC60950-1)	
Status Indicators	Visual: 3 status LEDs (Input, Output, Alarm) Relay: N.O. contact rated 200ma/50 Vdc	
Installation		
Fusing -Input	Internally fused	
-Output	Outputs are capable of providing high currents for short periods of time for inductive load startup or switching. Fusing may be required for wire/loads if 2x Nominal O/P current rating cannot be tolerated. Continuous current overload allows for reliable fuse tripping.	
Mounting	Simple snap-on to DIN TS35/7.5 or TS35/15 rail system.	
Connections	Input: Screw terminals, connector size range: 16-10 AWG (1.5-6 mm ²) for solid conductors. Screw torque: 4.4 lb-inch (~ 50 N-cm). Output: Two terminals per output, connector size range: 16-10 AWG (1.5-6 mm ²) for solid conductors. Screw torque: 7 lb-inch (~ 80 N-cm).	
Case	Fully enclosed metal housing with fine ventilation grid to keep out small parts.	
-Free Space	25 mm above and below, 10 mm left and right, 15 mm in front	
H x W x D inches in (mm)	4.85 x 1.97 x 4.36 (123.0 x 50.0 x 110.0)	4.85 x 2.36 x 4.36 (123.0 x 60.0 x 110.0)
Weight lbs (kg)	1.1 (0.50)	1.7 (0.80)

- Not UL listed for DC input.
- Input current ratings are conservatively specified with low input, worst case efficiency and power factor.
- Losses are heat dissipation in watts at full load, nominal input line.
- 24-28 Vdc adjustable guaranteed at full load.

- Ripple/noise is stated as typical values when measured with a 20 MHz, bandwidth scope and 50 Ohm resistor.
- Peak current is calculated at 24 Volt levels.
- Contact tech support for operation at -25°C.
- Demonstrated through extended life test.

SDN-C Specifications (Single Phase)

Description	Catalog Number	
	SDN 20-24-100C	SDN 40-24-100C
Input		
Nominal Voltage	115 - 230 Vac	
-AC Range	85 - 264 Vac	
-DC Range ¹	90 - 375 Vdc	
-Frequency	43 - 67 Hz	
Nominal Current ²	6 - 3 A	12 - 4 A
-Inrush current max.	< 40 A	Typ. <60 A
Efficiency (Losses ³)	> 92% (38 W)	> 93 % (67 W)
Power Factor Correction	Active power factor correction to better than 0.92	
Output		
Nominal Voltage ⁴	24 V (23.5~28.5 Vdc Adj.)	
-Tolerance	< ±2 % overall (combination Line, load, time and temperature related changes)	
Initial Voltage Setting	24.5 V ± 1%	
-Ripple ⁵	<100 mVpp	< 100 mVpp
PARAD	PARAD (Periodic and Random Deviation) = 100 mV peak-peak max	
Overvoltage Protection	> 30.5 but < 33 Vdc, auto recovery	
Power Back Immunity	< 35 V	
Nominal Current	20 A (480 W)	40 A (960 W)
-Peak Current ⁶	1.5 x Nominal Current for 4 seconds minimum while holding voltage > 20 Vdc	
-Short Circuit Current	1.5 x Nominal Current at near zero volts at short circuit condition	1.8 x Nominal Current at or near zero volts at short circuit condition
-Current Limit	PowerBoost™	
Parallel Operation ⁷	Switch selectable single unit or parallel unit operation. Units will not be damaged by parallel operation (regardless of switch position setting).	Active Paralleling
Holdup Time	>20 mS (Full load, 100 Vac Input @ T _{amb} = +25°C) to 95% output voltage	
Voltage Fall Time	<150 mS from 95% to 10% rated voltage @ full load (T _{amb} = +25°C)	
Line and Load Regulation	< 0.5%	
General		
EMC: -Emissions	EN61000-6-2:2001, EN61000-6-3:2001, Class B EN55011, EN55022 Radiated and Conducted including Annex. A, EN61000-3-2	EN61000-6-3, EN61000-6-4, Class B EN55011, EN55022 Radiated and Conducted including Annex A, EN61000-3-2, EN61000-3-3
-Immunity	EN61000-6-1:2001, EN61000-6-2:2001, EN61000-4-2 Level 4, EN61000-4-3 Level 3, EN61000-4-6 Level 3, EN61000-4-4 Level 4 input and level 3 output. EN61000-4-5 Isolation class 4, EN61000-4-11, IEC 61000-4-34 voltage dip immunity standard	EN61000-6-1, EN61000-6-2, EN61000-4-2 Level 4, EN61000-4-3 Level 3, EN61000-4-4 Level 4 input and Level 3 output, EN61000-4-5 Installation Class 4, EN61000-4-6 Level 3, EN61000-4-8, EN61000-4-11, SEMI F47 Sag Immunity, Transient protection according to VDE 0160/W2 over entire load range.
Temperature ⁸	Storage: -40°C to + 85°C, Operation -25°C to +60°C full power, with linear derating to half power from 60 to 70°C (Convection cooling, no forced air required). Operation up to 50% load permissible with sideways or front side up mounting orientation.	
MTBF ⁹	> 450,000 hrs	> 500,000 hours demonstrated
Warranty	5 Year Limited Warranty	
General Protection/Safety	Protected against continuous short -circuit, continuous overload, continuous open circuit. Protection Class 1 (IEC536), degree of protection IP20 (IEC60529) Safe low voltage: SELV (acc. IEC60950-1)	
Status Indicators	Visual: 3 status LEDs (Input, Output, Alarm) Relay: N.O. contact rated 200ma/50 Vdc	
Installation		
Fusing -Input	Internally fused	
-Output	Outputs are capable of providing high currents for short periods of time for inductive load startup or switching. Fusing may be required for wire/loads if 2x Nominal O/P current rating cannot be tolerated. Continuous current overload allows for reliable fuse tripping.	
Mounting	Simple snap-on to DIN TS35/7.5 or TS35/15 rail system.	
Connections ¹⁰	Input: Screw terminals, connector size range: 16-10 AWG (1.5-6 mm ²) for solid conductors. Screw Torque: 4.4 lb-in (~ 50 N-cm). Output: Two terminals per output, connector size range: 16-10 AWG (1.5-6 mm ²) for solid conductors. Screw Torque: 7 lb-inch (~ 80 N-cm)	Input: Screw terminals, connector size range: 16-10 AWG (1.5-6 mm ²) for solid conductors. Screw Torque: 4.4 lb-inch (~ 50 N-cm). Output: Two terminals per output, connector size range: 10-6 AWG (6-14 mm ²) for solid conductors. Screw Torque: 15.6 lb-inch (~ 176 N-cm)
Case	Fully enclosed metal housing with fine ventilation grid to keep out small parts.	
-Free Space	25 - 40 mm above and below, 10 mm left and right, 15 mm in front	
H x W x D inches in (mm)	4.85 x 3.42 x 4.98 (123.0 x 87.0 x 127.0)	4.85 x 7.09 x 4.81 (123.0 x 180.0 x 122.0)
Weight lbs (kg)	2.6 (1.20)	6.0 (2.75)

1. Not UL listed for DC input.

2. Input current ratings are conservatively specified with low input, worst case efficiency and power factor.

3. Losses are heat dissipation in watts at full load, nominal input line.

4. 24-28 Vdc adjustable guaranteed at full load.

5. Ripple/noise is stated as typical values when measured with a 20 MHz, bandwidth scope and 50 Ohm resistor.

6. Peak current is calculated at 24 Volt levels.

7. All models except the 40amp unit are capable of parallel operation by use of a jumper pin, accessible by the end user. 40 amp unit will have active current sharing signal.

8. Contact tech support for operation at -25°C.

9. Demonstrated through extended life test.

10. SDN 40-24-100C only = Output signaling terminal block features (Shut down, Power Good, Current Monitor, Current Balance, signal GND).

SDN-C Specifications (Three Phase)

Description	Catalog Number			
	SDN 5-24-480C	SDN 10-24-480C	SDN 20-24-480CC	SDN 40-24-480C
Input				
Nominal Voltage	380 - 480 Vac			
Two – phase input	Yes ¹			
–AC Range ²	320 - 540 Vac			
–DC Range	450 - 760 Vdc	450 - 760 Vdc	450 - 760 Vdc ¹⁰	N/A
–Frequency	50/60 Hz			
Nominal Current ³	3 x 0.5 or 2 x 0.7 A	3 x 0.8 or 2 x 1.2 A	3 x 0.9 or 2 x 1.3 A	3 x 1.6 A
–Inrush current max.	Typ. <25 A		Negligible	Negligible
Efficiency (Losses ⁴)	> 85% (18 W)	91.2% (23.6 W)	93% (42 W)	94% (78 W)
Power Factor Correction	Power factor correction to meet EN61000-3-2 Class A		Active Power Factor Correction	
Output				
Turn on time	Typ. 1s			
Voltage Rise Time	ca. 5-20 ms		<100 ms full resistive load (T _{amb} = +25°C)	
Power Back Immunity	<35 V			
Overvoltage Protection	>30.5 but <33 Vdc auto recovery			
Nominal Voltage ⁵	24 V (23.5–28.5 Vdc Adj.)			
Voltage Regulation	< ±2 % overall			
Initial Voltage Setting	24.5 V ± 1%			
–Ripple ⁶	<100 mVpp			
PARD	PARD = 100 mV peak-peak max		PARD = 200 mV peak-peak max	
Nominal Current	5 A (120 W)	10 A (240 W)	20 A (480 W) (constant power, not constant current)	40 A (960 W)
–Peak Current ⁷	6A, 2xNominal Current <2sec	12A, 2xNominal Current <2sec	1.5xNominal Current for 4 sec minimum while holding voltage > 20Vdc	
–Current Limit	PowerBoost™			
Derating	typ. 6 W/°C	typ. 12 W/°C	typ. 24 W/°C	typ. 48 W/°C
Holdup Time	>20 ms		>15 ms	
Voltage Fall Time	<150 ms from 95% to 10% rated voltage @ full load (T _{amb} = +25°C)		<50 ms from 95% to 10% rated voltage @ full load (T _{amb} = +25°C)	
Parallel Operation ⁸	Single or Parallel operation selectable via front switch. For redundant operation, use of external diode module is preferred			Active Paralleling
General				
Case	Fully enclosed metal housing with fine ventilation grid to keep out small parts.			
Min. Required	25mm above and below or 15mm in front	25mm above and below or 10mm in front	70mm above and below or 25mm in front and 25mm left & right	70mm above and below, 15mm in front, 25mm left & right
Free Space				
HxWxD inches (mm)	4.85 x 1.97 x 4.36 (123.0 x 50.0 x 111.0)	4.85 x 2.36 x 4.36 (123.0 x 60.0 x 111.0)	4.85 x 3.35 x 4.68 (123.0 x 85.0 x 119.0)	4.85 x 7.09 x 4.66 (123.0 x 180.0 x 119.0)
Weight lbs (kg)	1.2 (.52)	1.5 (0.70)	2.9 (1.30)	5.3 (2.40)
EMC: –Emissions	EN61000-6-3:2001, Class B EN55011, EN55022 Radiated and Conducted including Annex. A, EN61000-3-2			
–Immunity	EN61000-6-1:2001, EN61000-6-2:2001, EN61000-4-2 Level 4, EN61000-4-3 Level 3, EN61000-4-6 Level 3, EN61000-4-4 Level 4 input and level 3 output, EN61000-4-5 Isolation class 4, EN61000-4-11			
Temperature	Storage : -40 to + 85°C, Operation -25 to +60°C full power, with linear derating to half power from 60 to 70°C (Convection cooling, no forced air required). Operation up to 50% load permissible with sideways or front side up mounting orientation.			
Humidity	< 90% RH, noncondensing; IEC 60068-2-2, 68-2-3			
Altitude	0 to 3000 meters (0 to 10,000 feet)			
Vibration	2.5(g) RMS, 10-2000 Hz (random); three axes for 20 minutes each - IEC 60068-2-6			
Shock	3(g) peak, three axes, 11mseconds for each axis - IEC 60068-2-27			
Warranty	5 Year Limited Warranty			
MTBF	>500,000 hrs MTBF (Nominal voltage, full load, T _{amb} = 25°C)			
General Protection/Safety	Protected against short -circuit, overload, open circuit. Protection class 1 (IEC536), degree of protection IP20 (IEC 529) Safe low voltage: SELV (acc. EN60950)			
Over-temperature protection	LED Alarm, Output shutdown with automatic restart			
Status Indicators	Visual: 3 status LEDs (Input, Output, Alarm) Relay: SSR or dry relay contact, signal active when V _{out} = 18.5 Vdc = +/-5%			
Installation				
Fusing: –Input	Externally fused			
–Output	Not fused. Output is capable of providing high currents (PowerBoost) for motor load startup.			
Mounting	Simple snap-on to DIN TS35/7.5 or TS35/15 rail system. Unit should handle normal shock and vibration of industrial use and transportation without falling off the rail.			

1. SDN 20 will operate at 75% load; SDN 40 will operate at 50% load under loss of 1 phase; SDN 5 and SDN 10 will operate with single phase input power at 100% of load. Unit will shut down if thermal threshold is exceeded under this condition.
 2. Unit passed input voltage overstress test at 600 Vac without failure.
 3. Input current ratings are specified with low input, line conditions, worst case efficiency values and power factor spikes. Input current at nominal input settings will typically be half these values.
 4. Losses are heat dissipation in watts at full load, nominal line.
 5. 24-28 Vdc adjustable guaranteed at full load.
 6. Ripple/noise is stated as typical values when measured with a 20 MHz, bandwidth

scope and 50 Ohm resistor.
 7. SDN 20 and 40 unit will go to HICCUP mode. SDN 5 and 10 will maintain min 4 secs to deliver 150% load then drops to almost zero V_{out}. The output voltage will immediately drop to almost zero when load rises above 150%.
 8. All models except the 40amp unit are capable of parallel operation by use of a jumper pin, accessible by the end user. 40 amp unit will have active current sharing signal.
 9. SDN 40-24-100C only = Output signaling terminal block features (Shut down, Power Good, Current Monitor, Current Balance, signal GND).
 10. 70% maximum rated load.

SDN-C Series Dimensions

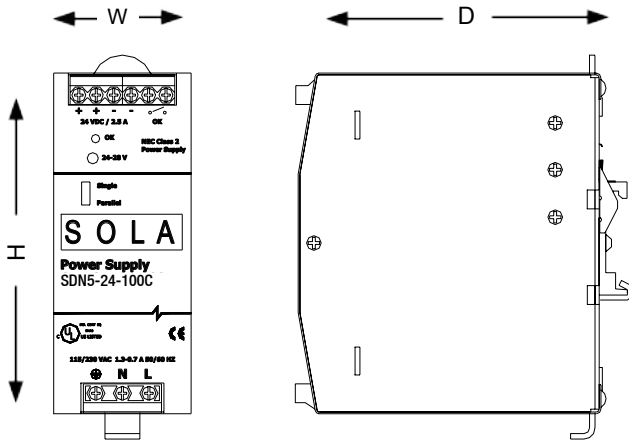

Catalog Number	Dimensions – inches (mm)		
	H	W	D
SDN 5–24–100C	4.85 (123.0)	1.97 (50.0)	4.36 (111.0)
SDN 10–24–100C	4.85 (123.0)	2.36 (60.0)	4.36 (111.0)
SDN 20–24–100C	4.85 (123.0)	3.42 (87.0)	4.98 (127.0)
SDN 5–24–480C	4.85 (123.0)	1.97 (50.0)	4.36 (111.0)
SDN 10–24–480C	4.85 (123.0)	2.36 (60.0)	4.36 (111.0)
SDN 20–24–480CC	4.85 (123.0)	3.35 (85.0)	4.68 (119.0)

SDN 40-24-100C and SDN 40-24-480C Dimensions

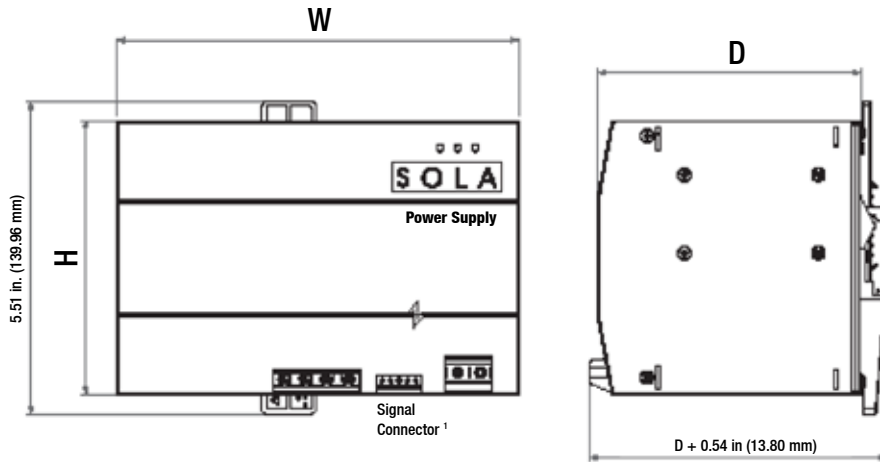

Catalog Number	Dimensions – inches (mm)		
	H	W	D
SDN 40–24–100C	4.85 (123.0)	7.09 (180.0)	4.66 (118.0)
SDN 40–24–480C	4.85 (123.0)	7.09 (180.0)	4.81 (122.0)

1. SDN 40-24-100C and SDN 40-24-480C output signaling terminal block features: Shut Down, Power Good, Current Monitor, Current Balance, GND, and active current sharing through I_SHARE connectors (See Signals Manual for connection information).

SDN-C Series Mounting

Chassis Mounting

Instead of snapping a SolaHD SDN™ unit on the DIN Rail, you can also attach it using the screw mounting set SDN-PMBRK2.

This set consists of two metal brackets, which replace the existing two aluminum profiles.

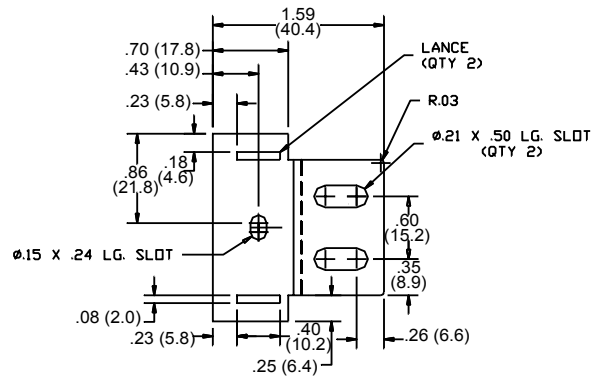

Dimensional Diagram - in (mm)

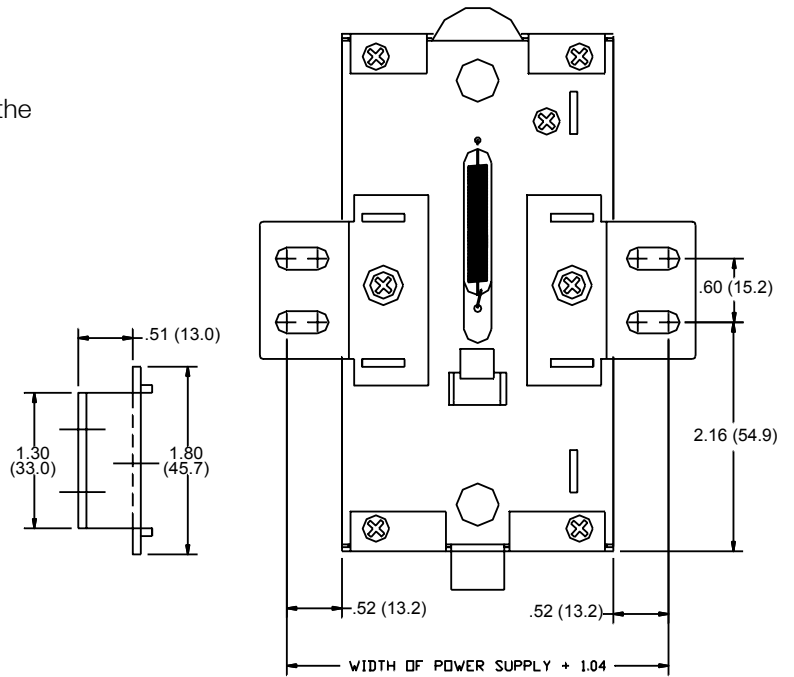

DIN Rail Mounting

Snap on the DIN Rail:

1. Tilt unit slightly backwards
2. Put it onto the DIN Rail
3. Push downwards until stopped
4. Push at the lower front edge to lock
5. Shake the unit slightly to ensure that the retainer has locked

Alternative Panel Mount: Using the optional SDN-PMBRK2 accessory, the unit can be screw mounted to a panel.

Detachment from DIN Rail:

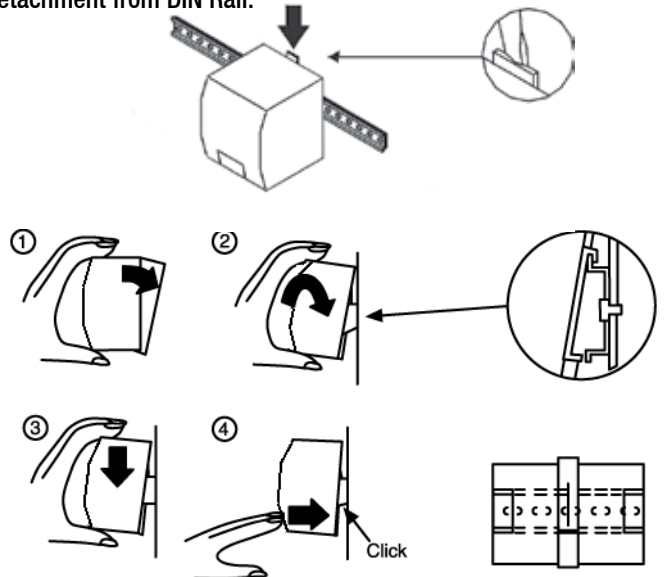



SDN 40-24-100C Competitive Comparison

	SolaHD	Phoenix	Siemens	PULS	Allen Bradley
Part Number	SDN 40-24-100C	QUINT-PS/ 1AC/24DC/40	6EP1 337-3BA00	QS40.241	1606-XLS960EE
# of Conditions	8	4	3	3	2
Diagnostics	Normal, AC Power Loss, AC Input Law, No DC, High Load, Overload, Hot, Too Hot	IOUT < IN, IOUT > IN, VOUT < 0.9x VN, VOUT > 0.9x VN	Normal, Yellow LED, for Overload, RED LED for latching shutdown	Normal, Overload, No DC output	DC ON, DC OFF
Nominal Input Voltage	100-240Vac	100-240Vac	set by jumpers 85-132V/176-264V	100-240Vac	200-240Vac
AC Input Range	85-264Vac	85-264Vac	90-264Vac	90-264Vac	90-264Vac
Output Voltage	24 Vdc	24 Vdc	24 Vdc	24Vdc	24Vdc
Output Current	@ 40amps	@ 40amps	@ 40amps	@ 40Amps	@ 40Amps
Output Voltage Adjustment Range	23.5-28.5 Vdc adjustable	18-29.5 Vdc (> 24V constant capacity)	24-28.8 Vdc adjustable	24-28 Vdc adjustable	24-28 Vdc
Efficiency	> 93% (67 W)	>92 % (for 230Vac and nominal values)	approx 88% (131 W)	> 93.2%	Typ. 94.6%
Mains Frequency	50 – 60 Hz	45 – 65 Hz	47 – 63 Hz	50 – 60 Hz +/-6%	50 – 60 Hz +/-6%
Reliability (MTBF)	> 500,000 hrs	> 500 000 h in acc. with IEC 61709 (SN 29500)	Not published	> 274,000 hr acc. to SN 29500, IEC 61709 at full load current and 40°C	> 274,000 hr acc. to SN 29500, IEC 61709 at full load current and 40°C
Size (cm3)	2712.1	5050.8	3750.3	1968.5	1968.5
Width along the DIN rail inch (mm)	7.09in (180mm)	7.09 in (180mm)	9.45 in (240mm)	4.92 in (125mm)	4.92 in (125mm)
Installation Clearance Required	25 mm above and below, 25 mm left and right, 15 mm in front. Do not obstruct air flow	50 mm vertically to ensure sufficient convection; 15 mm laterally required when installed next to other active components.	50 mm above and below	40mm on top, 20mm on the bottom, 15 mm left and right, Do not obstruct air flow	40mm on top, 20mm on the bottom, 15 mm left and right, Do not obstruct air flow
Full Power Ambient	-25°C to +60°C	-25°C to + 60°C	0°C to + 70°C	-25°C to + 70°C	-25°C to + 70°C
Hazardous Location Rating	Class I, Division 2 Class I, Zone 2	No rating	No rating	Class 1, Div 2 Pending	Class I, Division 2
ATEX Rating	Yes	No rating	Yes	Pending	No rating
Weight lb/kg	6.0lb (2.75kg)	7.2lb (3.3kg)	6.33lb (2.9kg)	4.2lb (1.9kg)	4.2lb (1.9kg)
Warranty	5 years	5 years	Not published	3 years	1 year

SolaHD SDN-C Series DIN Rail Power Supplies

Reliable delivery of power in a compact footprint
for single- or three-phase input

SOLAHD



SDN-C SERIES: SINGLE- AND THREE-PHASE POWER SUPPLIES

Maximize uptime and lower energy costs.

The SolaHD SDN-C Series delivers:

Higher efficiency.

Improved visual diagnostics.

Greater reliability.

Compact size.

**Meet all your bulk power supply needs
with a complete product line:**

24 Vdc, DIN rail-mounted power supplies.

Single- and three-phase models.

New 40 Amp single-phase model.



HIGHER EFFICIENCY

Advanced SolaHD technology eliminates the need for an input inductor and provides more efficient AC/DC conversion.

Lower energy consumption. A more efficient design helps reduce energy costs.

Lower cooling costs. With no input inductor, less energy is wasted in the form of dissipated heat – with no need for additional cooling fans in the panel.

Longer life. Less heat inside the panel enclosure means SDN-C power supplies and other components perform longer and more reliably.

IMPROVED VISUAL DIAGNOSTICS

Multicolored LEDs show the status of input power, output power and alarm conditions at a glance.

	Normal	AC Power Loss	AC Input Loss	NO DC	High Load	Overload	Hot*	Too Hot*
Input	Green	-----	Yellow	Green	Green	Green	Green	Green
Output	Green	-----	Green	-----	Yellow	Yellow	Green	-----
Alarm	-----	-----	-----	Red	Yellow	Red	Yellow	Yellow

* Hot and Too Hot indicate the unit is about to shut down due to high temperature or has shut down. Not intended to be used as a thermostat or to monitor temperature.

- **Reduce downtime.** Troubleshoot power supply problems quickly and confidently.
- **Diagnostic key.** Affix the included sticker to the power supply or panel door to provide a handy diagnostic reference.



GREATER RELIABILITY

Count on an improved design and SolaHD manufacturing quality for dependable performance.

- **Reduced parts count.** Fewer components provide lower failure rates compared to more complex power supplies.
- **Less heat.** With no input inductor, the SDN-C Series is less prone to heat buildup that can damage components.
- **Smarter component layout.** Heat-sensitive components are placed near cool air intakes and away from heat-producing components.

COMPACT SIZE

SDN-C Series power supplies are smaller and more compact, so they are easier to work with and let you do more in the available space.

- **More room to work.** SDN-C power supplies save space on the DIN rail and in the electrical enclosure, so it's easier to terminate wires and configure components.
- **Better heat dissipation.** With more space around individual components, air circulates more freely.
- **Increased enclosure capacity.** Add more components to increase the capacity and efficiency of your operations, while avoiding the need to add a new enclosure.



NEW: 40 AMP POWER SUPPLY WITH SINGLE-PHASE INPUT

For industries located in buildings with single-phase power, there is no need to let power supply capacity limit what you can do.

Our newest single-phase SDN-C model delivers the same 40 Amp capacity as our largest three-phase model.

The power you need today.

Run large industrial loads – such as sorting, conveying and packaging equipment, using the single-phase power available in any commercial building.

The power you need tomorrow.

Add new equipment to your operation and get the power you need within your existing power structure – with little or no retrofitting required.

NEW: 40 AMP POWER SUPPLY WITH SINGLE-PHASE INPUT

Single-phase power is by far the most commonly available. Even when industries require three-phase service to run large industrial motors, many branch circuits are likely to be on a single phase.

Our new 40 Amp, single-phase SDN-C transformer is a perfect fit for powering large DC loads on a standard, single-phase AC circuit.

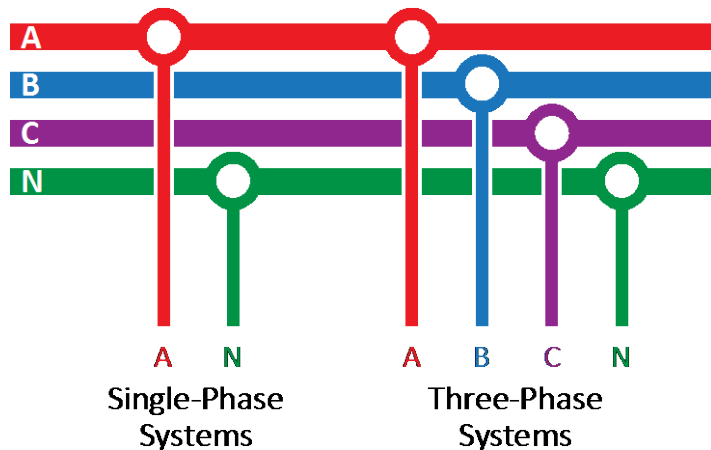

SPECIFICATIONS/CERTIFICATIONS

Listed, Industrial Control Equipment, E61379

- UL508, CSA C22.2 No. 107.1

UL Recognized Component, ITE, E137632

- UL 60950-1/CSA C22.2 No. 60950-1, 2nd Edition

UL Recognized Component, Haz. Loc., E234790

- UL 60079-15/CSA E60079-15
- Class I, Zone 2, AEx nC IIC, Ex nC IIC

Low Voltage Directive

- IEC/ EN60950-1, 2nd Edition

Directive

- EN60079-0, EN60079-15
- II 3 G, Ex nC IIC Gc

Sag Immunity: SEMI F47

CATALOG INFORMATION

Product offering

Single-Phase		
Catalog Number	Watts	Amps
SDN 5-24-100C	120	5
SDN 10-24-100C	240	10
SDN 20-24-100C	480	20
SDN 40-24-100C	960	40

Three-Phase		
Catalog Number	Watts	Amps
SDN 5-24-480C	120	5
SDN 10-24-480C	240	10
SDN 20-24-480CC	480	20
SDN 40-24-480C	960	40

**For more information and to order your SDN-C power supply,
contact your SolaHD representative.**

WHY SOLAHD?

Since 1915 in the most demanding environments, SolaHD has supplied total power-quality solutions to keep production lines moving and people, equipment and information safe.

Turn to SolaHD for industrial-grade power conversion and power quality products to ensure reliable operation across your entire production environment.

Компания «Океан Электроники» предлагает заключение долгосрочных отношений при поставках импортных электронных компонентов на взаимовыгодных условиях!

Наши преимущества:

- Поставка оригинальных импортных электронных компонентов напрямую с производств Америки, Европы и Азии, а так же с крупнейших складов мира;
- Широкая линейка поставок активных и пассивных импортных электронных компонентов (более 30 млн. наименований);
- Поставка сложных, дефицитных, либо снятых с производства позиций;
- Оперативные сроки поставки под заказ (от 5 рабочих дней);
- Экспресс доставка в любую точку России;
- Помощь Конструкторского Отдела и консультации квалифицированных инженеров;
- Техническая поддержка проекта, помощь в подборе аналогов, поставка прототипов;
- Поставка электронных компонентов под контролем ВП;
- Система менеджмента качества сертифицирована по Международному стандарту ISO 9001;
- При необходимости вся продукция военного и аэрокосмического назначения проходит испытания и сертификацию в лаборатории (по согласованию с заказчиком);
- Поставка специализированных компонентов военного и аэрокосмического уровня качества (Xilinx, Altera, Analog Devices, Intersil, Interpoint, Microsemi, Actel, Aeroflex, Peregrine, VPT, Syfer, Eurofarad, Texas Instruments, MS Kennedy, Miteq, Cobham, E2V, MA-COM, Hittite, Mini-Circuits, General Dynamics и др.);

Компания «Океан Электроники» является официальным дистрибьютором и эксклюзивным представителем в России одного из крупнейших производителей разъемов военного и аэрокосмического назначения «JONHON», а так же официальным дистрибьютором и эксклюзивным представителем в России производителя высокотехнологичных и надежных решений для передачи СВЧ сигналов «FORSTAR».



JONHON

«JONHON» (основан в 1970 г.)

Разъемы специального, военного и аэрокосмического назначения:

(Применяются в военной, авиационной, аэрокосмической, морской, железнодорожной, горно- и нефтедобывающей отраслях промышленности)

«FORSTAR» (основан в 1998 г.)

ВЧ соединители, коаксиальные кабели, кабельные сборки и микроволновые компоненты:

(Применяются в телекоммуникациях гражданского и специального назначения, в средствах связи, РЛС, а так же военной, авиационной и аэрокосмической отраслях промышленности).



Телефон: 8 (812) 309-75-97 (многоканальный)

Факс: 8 (812) 320-03-32

Электронная почта: ocean@oceanchips.ru

Web: <http://oceanchips.ru/>

Адрес: 198099, г. Санкт-Петербург, ул. Калинина, д. 2, корп. 4, лит. А