

5 V AGC AMPLIFIER + VIDEO AMPLIFIER

FEATURES

- **ON-CHIP LOW DISTORTION AMPLIFIER:**
IIP₃ = -4 dBm at minimum gain
- **WIDE AGC DYNAMIC RANGE:**
GCR = 53 dB TYP
- **ON-CHIP VIDEO AMPLIFIER:**
V_{OUT} = 1.25 V_{P-P} at single-ended output
- **SUPPLY VOLTAGE:**
V_{CC} = 5 V
- **PACKAGED IN 8 PIN SSOP SUITABLE FOR SURFACE MOUNTING**

DESCRIPTION

The UPC3217GV and UPC3218GV are Silicon Monolithic ICs designed for use as AGC amplifiers for digital CATV, cable modems and IP telephony systems. These ICs consist of a two stage gain control amplifier and a fixed video gain amplifier. The devices provide a differential input and differential output for noise performance, which eliminates shielding requirements.

The package is 8-pin SSOP (Shrink Small Outline Package) suitable for surface mount.

These ICs are manufactured using the 10 GHz ft NESAT™ II AL silicon bipolar process. This process uses silicon nitride passivation film. This material can protect chip surface from external pollution and prevent corrosion/migration. Thus, these ICs have excellent performance, uniformity and reliability.

Stringent quality assurance and test procedures ensure the highest reliability and performance.

ELECTRICAL CHARACTERISTICS

(T_A = 25°C, V_{CC} = 5 V, Z_S = 1 K Ω, Z_L = 240 Ω, f_{IN} = 45 MHz, Unless otherwise specified)

PART NUMBER PACKAGE OUTLINE		UPC3217GV S08			UPC3218GV S08			
SYMBOLS	PARAMETERS AND CONDITIONS	UNITS	MIN	TYP	MAX	MIN	TYP	MAX
DC Characteristics								
I _{CC}	Circuit Current (no input signal)	mA	15	23	34	15	23	34
RF Characteristics								
BW	Frequency Bandwidth, V _{AGC} * = 4.5 V ¹	MHz		100			100	
G _{MAX}	Maximum Gain, V _{AGC} * = 4.5 V	dB	50	53	56	60	63	66
G _{MIN}	Minimum Gain, V _{AGC} * = 0.5 V	dB	-4.5	0	3.5	4.5	10	13.5
GCR	Gain Control Range, V _{AGC} * = 0.5 to 4.5 V	dB	46.5	53		46.5	53	
N _{FAGC}	Noise Figure, V _{AGC} * = 4.5 V at MAX Gain	dB		6.5	8.0		3.5	4.5
V _{OUT}	Output Voltage, Single Ended Output	V _{P-P}		1.25			1.25	
IM ₃	Third Order Intermodulation Distortion, f _{IN1} = 44 MHz, f _{IN2} = 45 MHz, V _{IN} = 30 dBmV per tone ²	dBc		55			55	

Note:

1. -3dB with respect to 10 MHz gain
2. V_{AGC} is adjusted to establish V_{OUT} = 1.25 V_{P-P} per tone

* V_{AGC} shown as applied in the evaluation circuit (see page 5) through a resistive bridge (voltage divider).
Actual voltage range on the pin of the IC is 0 to 3 V.

VOLTAGE GAIN vs.
AUTOMATIC GAIN CONTROL VOLTAGE*

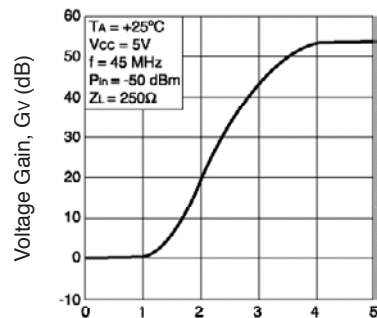

UPC3217GV

Automatic Gain Control Voltage, V_{AGC}* (V)

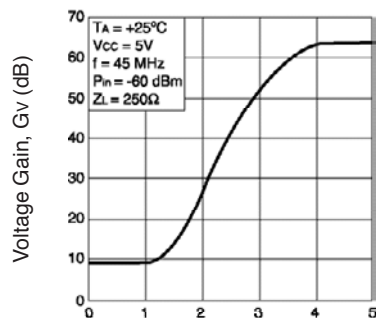

UPC3218GV

Automatic Gain Control Voltage, V_{AGC}* (V)

APPLICATIONS

- Digital CATV
- Cable modem receivers
- IP Telephony Receivers

UPC3217GV, UPC3218GV

ABSOLUTE MAXIMUM RATINGS¹

(T_A = 25°C, unless otherwise specified)

SYMBOLS	PARAMETERS	UNITS	RATINGS
V _{CC}	Supply Voltage	V	6.0
P _D	Power Dissipation ² , T _A = 85°C	mW	250
T _{OP1}	Operating Ambient Temp.	°C	-40 to +85
T _{STG}	Storage Temperature	°C	-50 to +150

Notes:

1. Operation in excess of any one of these parameters may result

in permanent damage.

2. Mounted on a 50 x 50 x 1.6 mm epoxy glass PWB, with copper patterning on both sides.

RECOMMENDED OPERATING CONDITIONS

SYMBOL	PARAMETER	UNITS	MIN	TYP	MAX
V _{CC}	Supply Voltage	V	4.5	5.0	5.5
T _A	Operating Ambient Temp. ¹	°C	-40	+25	+85
V _{AGC} ²	Gain Control Voltage Range	V	0	–	3.0
V _{IN}	Video Input Signal Range	dBmV	8		30

Note:

1. V_{CC} = 4.5 to 5.5 V

2. AGC range at pin 4 of the IC

ORDERING INFORMATION

PART NUMBER	QUANTITY
UPC3217GV-E1-A	1 kp/Reel
UPC3218GV-E1-A	1 kp/Reel

Note:

Embossed tape 8 mm wide. Pin 1 indicates pull-out direction of tape.

TYPICAL PERFORMANCE CURVES (T_A = 25°C, unless otherwise specified)

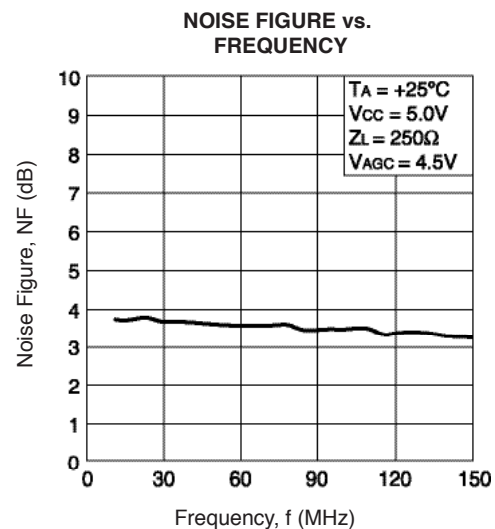
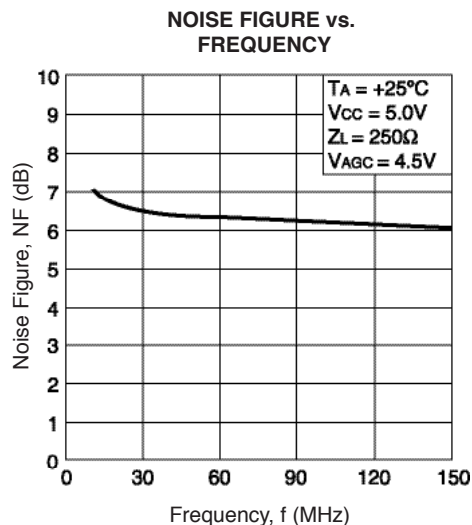
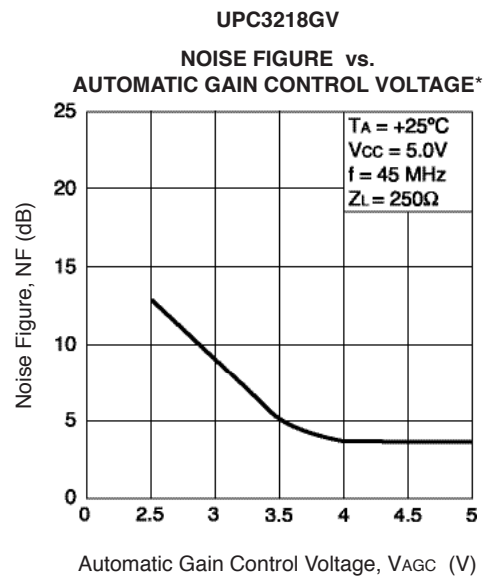
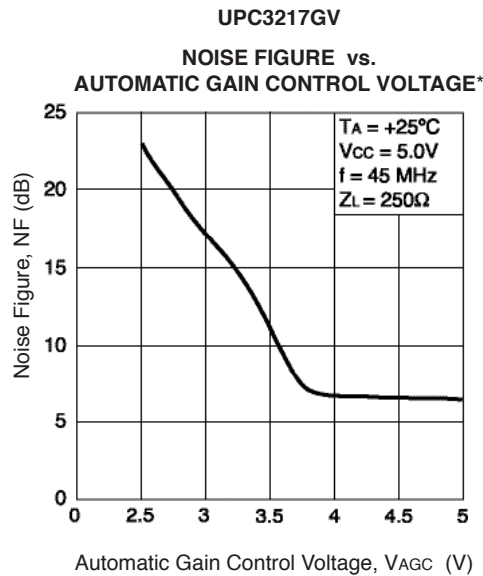

* V_{AGC} shown as applied in the evaluation circuit (see page 5) through a resistive bridge (voltage divider). Actual voltage range on the pin of the IC is 0 to 3 V.

TYPICAL PERFORMANCE CURVES ($T_A = 25^\circ\text{C}$, unless otherwise specified)

UPC3217GV

CIRCUIT CURRENT vs. SUPPLY VOLTAGE

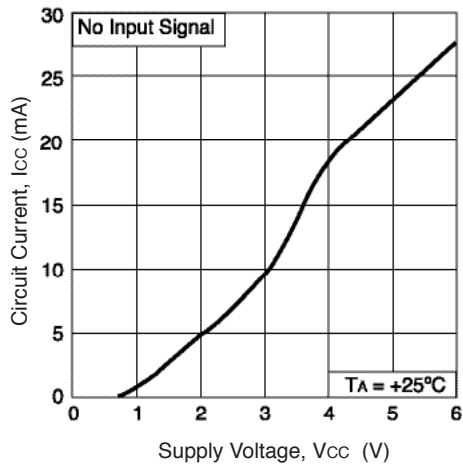

UPC3218GV

CIRCUIT CURRENT vs. SUPPLY VOLTAGE

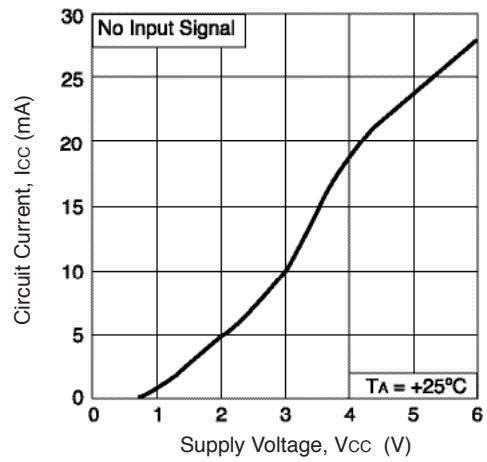

VOLTAGE GAIN vs. FREQUENCY

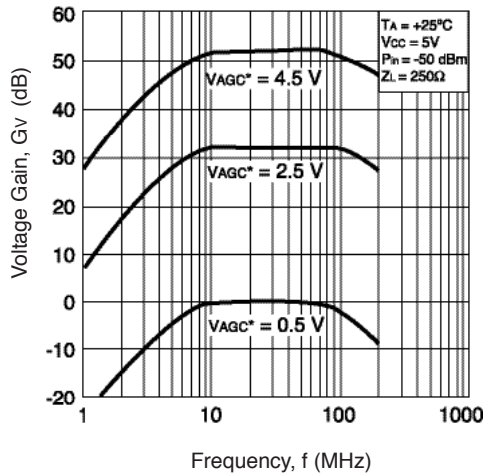

VOLTAGE GAIN vs. FREQUENCY

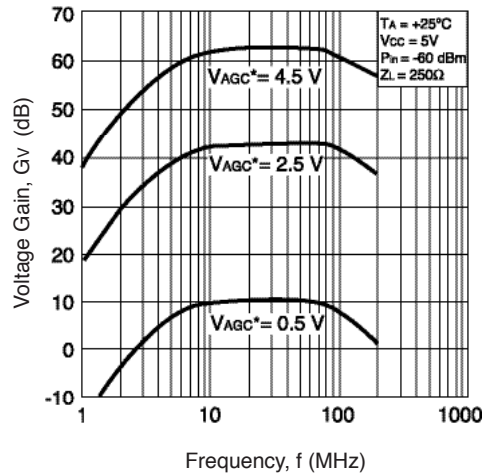

VOLTAGE GAIN vs. AUTOMATIC GAIN CONTROL VOLTAGE*

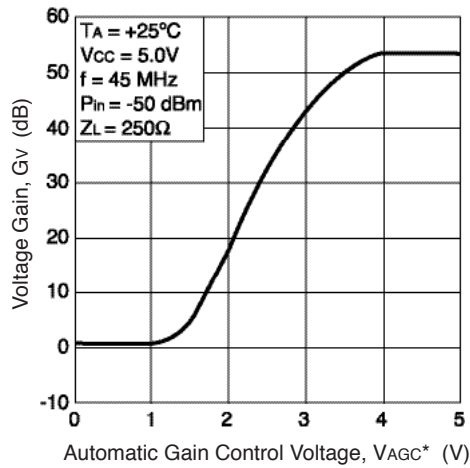

VOLTAGE GAIN vs. AUTOMATIC GAIN CONTROL VOLTAGE*

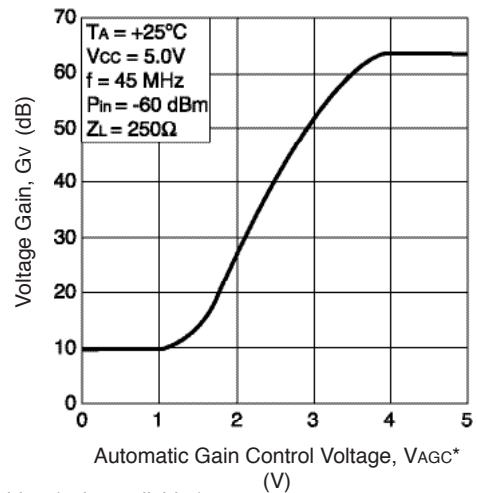

* V_{AGC} shown as applied in the evaluation circuit (see page 5) through a resistive bridge (voltage divider). Actual voltage range on the pin of the IC is 0 to 3 V.

TYPICAL PERFORMANCE CURVES, cont. (TA = 25°C, unless otherwise specified)

UPC3217GV

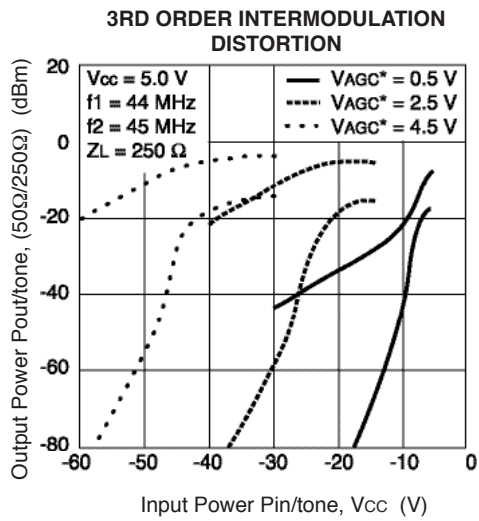

UPC3218GV

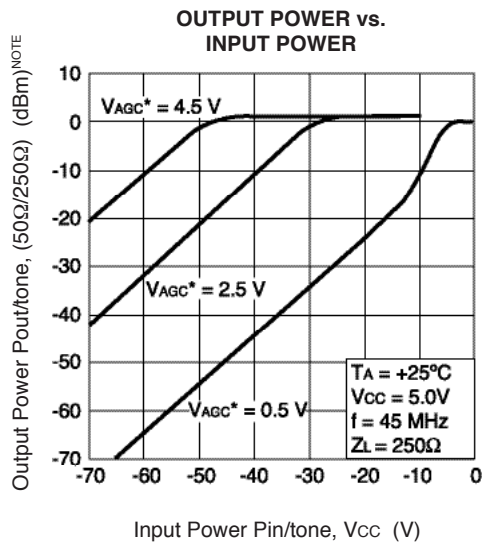
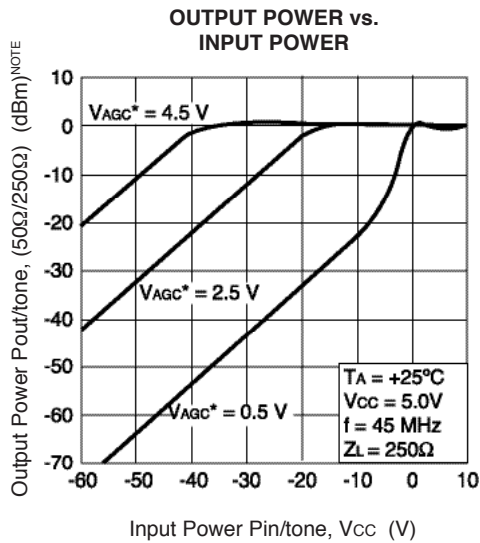
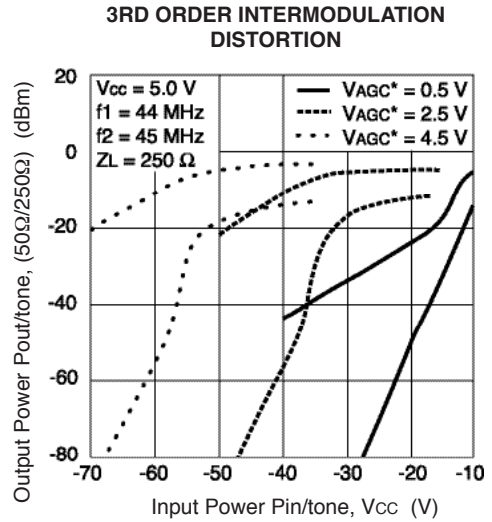

NOTE: Measurement value with spectrum analyzer.

* VAGC shown as applied in the evaluation circuit (see page 5) through a resistive bridge (voltage divider). Actual voltage range on the pin of the IC is 0 to 3 V.

TYPICAL SCATTERING PARAMETERS

S11-FREQUENCY

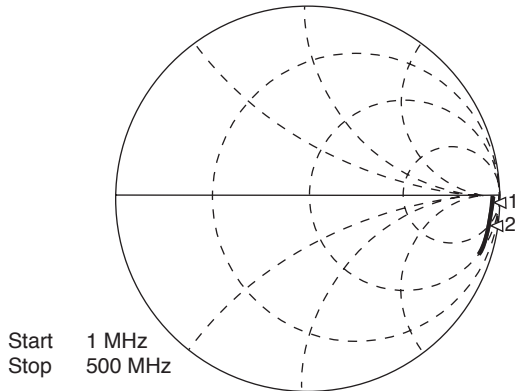

Start 1 MHz
Stop 500 MHz

Marker 1: UPC3217GV 1.339k-j 1.556 kΩ
Marker 2: UPC3218GV 1.024k-j 1.124 kΩ

S22-FREQUENCY

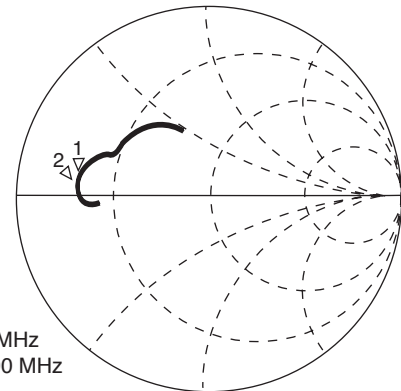

Start 1 MHz
Stop 500 MHz

Marker 1: UPC3217GV 9.511 + j 3.869 Ω
Marker 2: UPC3218GV 9.493 + j 4.317 Ω

SYSTEM APPLICATION EXAMPLE

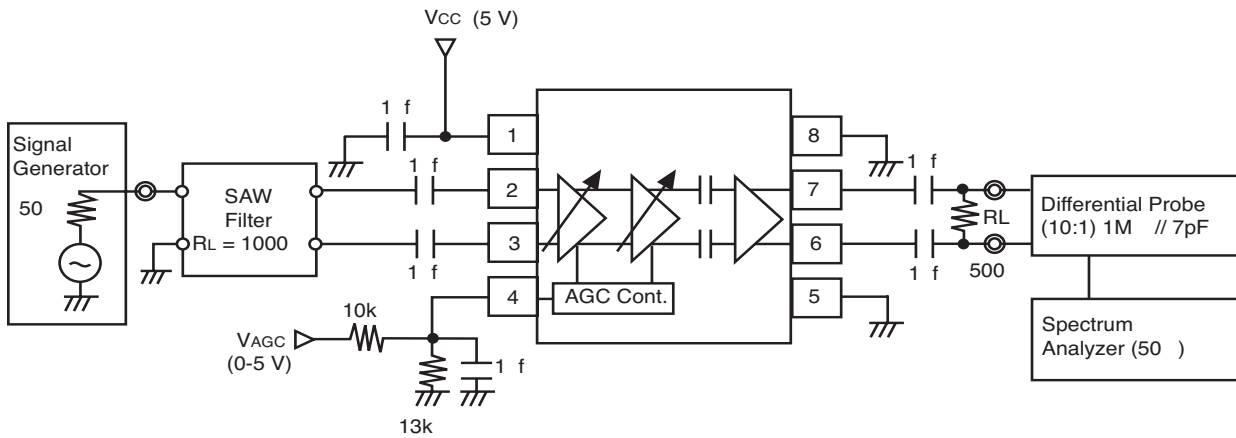

EVALUATION BOARD SCHEMATIC AND TEST

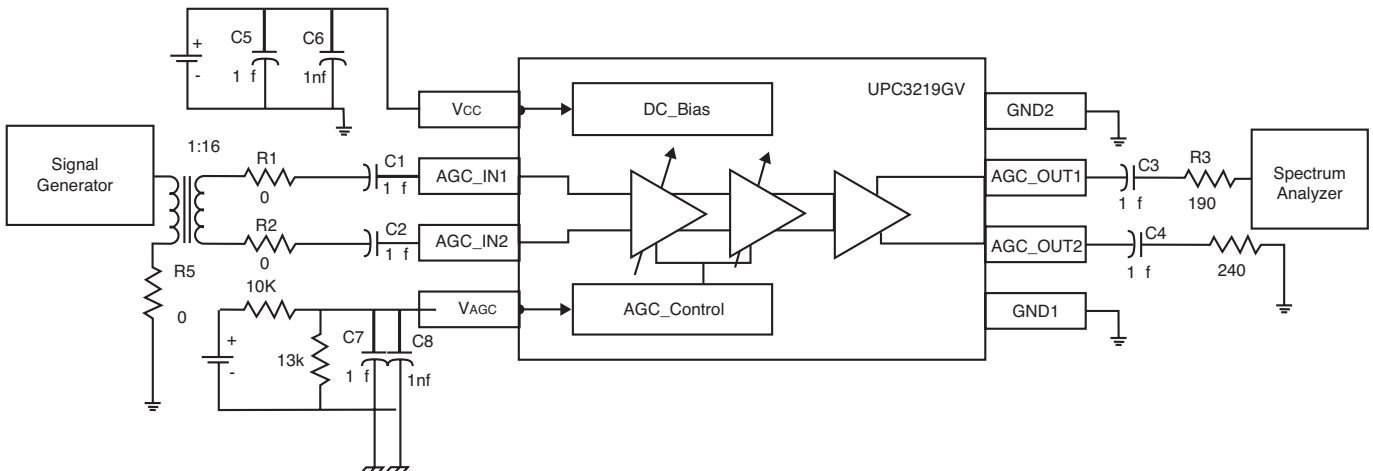

UPC3217GV, UPC3218GV

PIN EXPLANATIONS (UPC3217GV, UPC3218GV common)

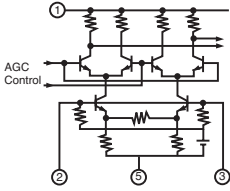
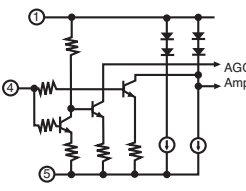
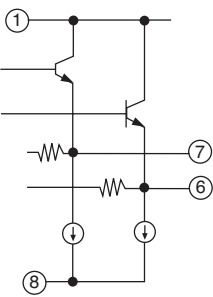
Pin No.	Name	Applied Voltage (v)	Pin Voltage (v) ¹	Description	Internal Equivalent Circuit
1	Vcc	4.5 to 5.5		Power supply pin. This pin should be externally equipped with bypass capacitor to minimize ground impedance.	
2	INPUT1		1.45	Signal input pins of AGC amplifier.	
3	INPUT2		1.45		
4	VAGC	0 to 3.0 Vcc		Gain control pin. This pin's bias govern the AGC output level. Minimum Gain at V _{AGC} = 0.5 V Maximum Gain at V _{AGC} = 4.5 V Recommended to use a 0 to 5 V AGC range for the system and divide this voltage through a resistive bridge (see evaluation board). This helps make the AGC slope less steep.	
5	GND 2	0		Ground pin. This pin should be connected to system ground with minimum inductance. Ground pattern on the board should be formed as wide as possible.	
6	OUTPUT2		2.2	Signal output pins of video amplifier	
7	OUTPUT1		2.2		
8	GND 1	0		Ground pin. This pin should be connected to system ground with minimum inductance. Ground pattern on the board should be formed as wide as possible. All ground pins must be connected together with wide ground pattern to decrease impedance difference.	

Note:

1. Pin is measured at V_{cc} = 5 V

OUTLINE DIMENSIONS (Units in mm)

PACKAGE OUTLINE S08

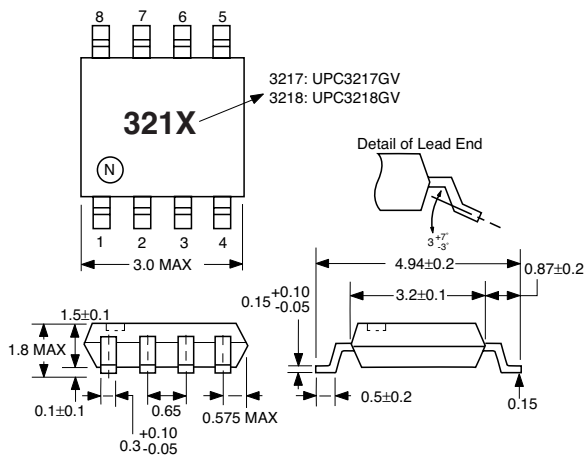

All dimensions are typical unless specified otherwise.

EVALUATION BOARD

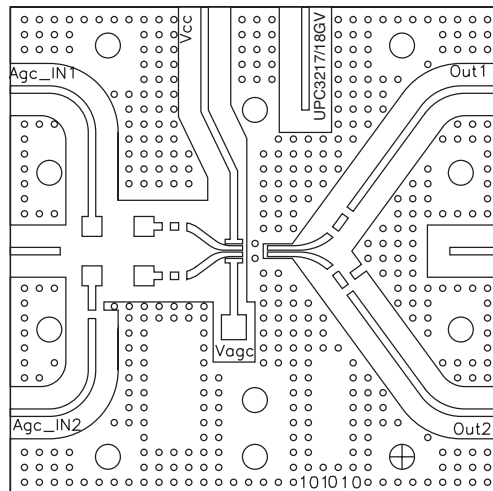

EVALUATION BOARD ASSEMBLY

INTERNAL BLOCK DIAGRAM

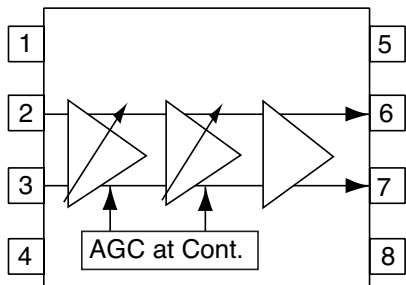

T1	Transformer 4:1 Coilcraft
R7	0603 10K OHM RES ROHM
R6	0603 13K OHM RES ROHM
R4	0603 240 OHM RES ROHM
R3	0603 191 OHM RES ROHM
R1,R2,R5	0603 0 OHM RES ROHM
C6, C8	0603 1000pF CAP ROHM
C1-C5, C7	0805 1uF CAP ROHM
U1	IC, UPC3217/18GV IC

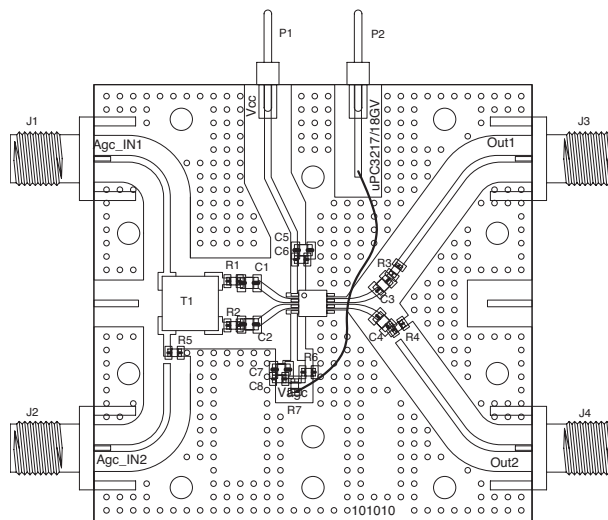

Компания «Океан Электроники» предлагает заключение долгосрочных отношений при поставках импортных электронных компонентов на взаимовыгодных условиях!

Наши преимущества:

- Поставка оригинальных импортных электронных компонентов напрямую с производств Америки, Европы и Азии, а так же с крупнейших складов мира;
- Широкая линейка поставок активных и пассивных импортных электронных компонентов (более 30 млн. наименований);
- Поставка сложных, дефицитных, либо снятых с производства позиций;
- Оперативные сроки поставки под заказ (от 5 рабочих дней);
- Экспресс доставка в любую точку России;
- Помощь Конструкторского Отдела и консультации квалифицированных инженеров;
- Техническая поддержка проекта, помощь в подборе аналогов, поставка прототипов;
- Поставка электронных компонентов под контролем ВП;
- Система менеджмента качества сертифицирована по Международному стандарту ISO 9001;
- При необходимости вся продукция военного и аэрокосмического назначения проходит испытания и сертификацию в лаборатории (по согласованию с заказчиком);
- Поставка специализированных компонентов военного и аэрокосмического уровня качества (Xilinx, Altera, Analog Devices, Intersil, Interpoint, Microsemi, Actel, Aeroflex, Peregrine, VPT, Syfer, Eurofarad, Texas Instruments, MS Kennedy, Miteq, Cobham, E2V, MA-COM, Hittite, Mini-Circuits, General Dynamics и др.);

Компания «Океан Электроники» является официальным дистрибьютором и эксклюзивным представителем в России одного из крупнейших производителей разъемов военного и аэрокосмического назначения «JONHON», а так же официальным дистрибьютором и эксклюзивным представителем в России производителя высокотехнологичных и надежных решений для передачи СВЧ сигналов «FORSTAR».



JONHON

«JONHON» (основан в 1970 г.)

Разъемы специального, военного и аэрокосмического назначения:

(Применяются в военной, авиационной, аэрокосмической, морской, железнодорожной, горно- и нефтедобывающей отраслях промышленности)

«FORSTAR» (основан в 1998 г.)

ВЧ соединители, коаксиальные кабели,
кабельные сборки и микроволновые компоненты:

(Применяются в телекоммуникациях гражданского и специального назначения, в средствах связи, РЛС, а так же военной, авиационной и аэрокосмической отраслях промышленности).



Телефон: 8 (812) 309-75-97 (многоканальный)

Факс: 8 (812) 320-03-32

Электронная почта: ocean@oceanchips.ru

Web: <http://oceanchips.ru/>

Адрес: 198099, г. Санкт-Петербург, ул. Калинина, д. 2, корп. 4, лит. А