

AD8505/AD8506/AD8508

FEATURES

- PSRR: 100 dB minimum
- CMRR: 105 dB typical
- Very low supply current: 20 μ A per amplifier maximum
- 1.8 V to 5 V single supply or ± 0.9 V to ± 2.5 V dual supply
- Rail-to-rail input/output
- Low noise: 45 nV/ $\sqrt{\text{Hz}}$ at 1 kHz
- 2.5 mV offset voltage maximum
- Very low input bias current: 1 pA typical

APPLICATIONS

- Pressure and position sensors
- Remote security
- Bio sensors
- IR thermometers
- Battery-powered consumer equipment
- Hazard detectors

GENERAL DESCRIPTION

The AD8505/AD8506/AD8508 are single, dual, and quad micro-power amplifiers featuring rail-to-rail input/output swings while operating from a single 1.8 V to 5 V power supply or from dual ± 0.9 V to ± 2.5 V power supplies. Using a new circuit technology, these amplifiers offer zero input crossover distortion (excellent PSRR and CMRR performance) and low bias current while operating with a supply current of less than 20 μ A per amplifier. This amplifier family offers the lowest noise in its power class.

This combination of features makes the AD8505/AD8506/AD8508 amplifiers ideal choices for battery-powered applications because they minimize errors due to power supply voltage variations over the lifetime of the battery and maintain high CMRR even for a rail-to-rail input op amp. Remote battery-powered sensors, handheld instrumentation, consumer equipment, hazard detection (for example, smoke, fire, and gas), and patient monitors can benefit from the features of the AD8505/AD8506/AD8508 amplifiers.

The AD8505/AD8506/AD8508 are specified for both the industrial temperature range of -40°C to $+85^{\circ}\text{C}$ and the extended industrial temperature range of -40°C to $+125^{\circ}\text{C}$. The AD8505 single amplifier is available in a tiny 5-lead SOT-23 and a 6-ball WLCSP packages. The AD8506 dual amplifier is available in 8-lead MSOP and 8-ball WLCSP packages. The AD8508 quad amplifier is available in 14-lead TSSOP and 14-ball WLCSP packages. The AD8505/AD8506/AD8508 are members of a growing series of zero crossover distortion op amps offered by Analog Devices, Inc., including the [ADA4505-1/ADA4505-2/ADA4505-4](#), that operate from a single 1.8 V to 5 V supply or from dual ± 0.9 V to ± 2.5 V power supplies.

Rev. E

Information furnished by Analog Devices is believed to be accurate and reliable. However, no responsibility is assumed by Analog Devices for its use, nor for any infringements of patents or other rights of third parties that may result from its use. Specifications subject to change without notice. No license is granted by implication or otherwise under any patent or patent rights of Analog Devices. Trademarks and registered trademarks are the property of their respective owners.

PIN CONFIGURATIONS



Figure 1. 5-Lead SOT-23 (RJ-5)



AD8505
TOP VIEW
(BALL SIDE DOWN)
Not to Scale
NC = NO CONNECT

Figure 2. 6-Ball WLCSP (CB-6-7)

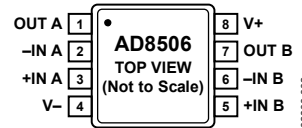
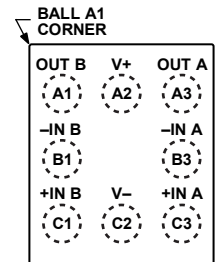

Figure 3. 8-Lead MSOP (RM-8)



AD8506
TOP VIEW
(BALL SIDE DOWN)
Not to Scale

Figure 4. 8-Ball WLCSP (CB-8-2)

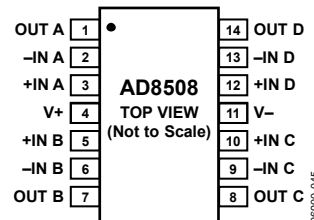
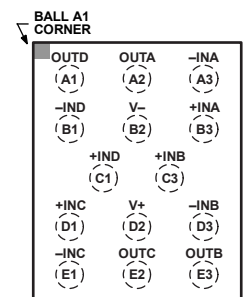

Figure 5. 14-Lead TSSOP (RU-14)



AD8508
TOP VIEW
(BALL SIDE DOWN)
Not to Scale

Figure 6. 14-Ball WLCSP (CB-14-1)

TABLE OF CONTENTS

Features	1
Applications	1
General Description	1
Pin Configurations	1
Revision History	2
Specifications	3
Electrical Characteristics—1.8 V Operation	3
Electrical Characteristics—5 V Operation	4
Absolute Maximum Ratings	5
Thermal Resistance	5

REVISION HISTORY

5/10—Rev. D to Rev. E

Added AD8505, 6-Ball WLCSP Package	Universal
Changes to Large-Signal Voltage Gain Parameter (Table 1)	4
Changes to Large-Signal Voltage Gain Parameter (Table 2)	5
Changes to Table 4	6
Updated Outline Dimensions	19
Changes to Ordering Guide	21

10/09—Rev. C to Rev. D

Added AD8505, 5-Lead SOT-23 Package	Universal
Changes to General Description, Added Figure 1	1
Moved Electrical Characteristics—1.8 V Operation Section, Changes to Supply Current per Amplifier Parameter, Table 1	3
Moved Electrical Characteristics—5 V Operation Section, Changes to Supply Current per Amplifier Parameter, Table 2	4
Changes to Thermal Resistance Section and Table 4	5
Changes to Figure 20 and Figure 23	8
Updated Outline Dimensions	16
Changes to Ordering Guide	17

3/09—Rev. B to Rev. C

Added AD8508, 14-Ball WLCSP Package	Universal
Updated Outline Dimensions	17
Changes to Ordering Guide	18

10/08—Rev. A to Rev. B

Added WLCSP Package	Universal
Added Figure 2; Renumbered Sequentially	1
Added Input Resistance Parameter	3
Changes to Input Capacitance Differential Mode Parameter Symbol and Input Capacitance Common Mode Parameter Symbol	3
Added Input Resistance Parameter	4
Changes to Input Capacitance Differential Mode Parameter Symbol and Input Capacitance Common Mode Parameter Symbol	4

ESD Caution	5
Typical Performance Characteristics	6
Theory of Operation	13
Applications Information	15
Pulse Oximeter Current Source	15
Four-Pole, Low-Pass Butterworth Filter for Glucose Monitor	16
Outline Dimensions	17
Ordering Guide	20

Changes to Table 4	5
Changes to Figure 46	16
Updated Outline Dimensions	17
Added Figure 49	17
Changes to Ordering Guide	18

7/08—Rev. 0 to Rev. A

Added AD8508	Universal
Added TSSOP Package	Universal
Changes to Features Section and General Description Section ..	1
Added Figure 2; Renumbered Sequentially	1
Changed Electrical Characteristics Heading to Electrical Characteristics—5 V Operation	3
Changes to Table 1	3
Added Electrical Characteristics—1.8 V Operation Heading	4
Changes to Table 2	4
Changes to Table 3, Thermal Resistance Section, and Table 4	5
Added $T_A = 25^\circ\text{C}$ Condition to Typical Performance Characteristics Section	6
Changes to Figure 3, Figure 4, Figure 6, and Figure 7	6
Added Figure 11 and Figure 14	7
Changes to Figure 17 Through Figure 20	8
Changes to Figure 21 Through Figure 26	9
Changes to Figure 27, Figure 28, Figure 30, and Figure 31	10
Changes to Figure 34, Figure 37, and Figure 38	11
Added Figure 39 and Figure 40	12
Added Theory of Operation Section, Figure 41, and Figure 42	13
Added Figure 43 and Figure 44	14
Added Applications Information Section and Figure 45	15
Added Figure 46	16
Updated Outline Dimensions	17
Added Figure 48	17
Changes to Ordering Guide	17

11/07—Revision 0: Initial Version

SPECIFICATIONS

ELECTRICAL CHARACTERISTICS—1.8 V OPERATION

$V_{SY} = 1.8\text{ V}$, $V_{CM} = V_{SY}/2$, $T_A = 25^\circ\text{C}$, $R_L = 100\text{ k}\Omega$ to GND, unless otherwise noted.

Table 1.

Parameter	Symbol	Conditions	Min	Typ	Max	Unit
INPUT CHARACTERISTICS						
Offset Voltage	V_{OS}	$0\text{ V} \leq V_{CM} \leq 1.8\text{ V}$ $-40^\circ\text{C} \leq T_A \leq +125^\circ\text{C}$		0.5	2.5	mV
Input Bias Current	I_B	$-40^\circ\text{C} \leq T_A \leq +85^\circ\text{C}$ $-40^\circ\text{C} \leq T_A \leq +125^\circ\text{C}$		1	10	pA
					100	pA
Input Offset Current	I_{OS}	$-40^\circ\text{C} \leq T_A \leq +85^\circ\text{C}$ $-40^\circ\text{C} \leq T_A \leq +125^\circ\text{C}$		0.5	5	pA
					50	pA
					100	pA
Input Voltage Range		$-40^\circ\text{C} \leq T_A \leq +125^\circ\text{C}$	0		1.8	V
Common-Mode Rejection Ratio	CMRR	$0\text{ V} \leq V_{CM} \leq 1.8\text{ V}$ $-40^\circ\text{C} \leq T_A \leq +85^\circ\text{C}$ $-40^\circ\text{C} \leq T_A \leq +125^\circ\text{C}$	85	100		dB
			85			dB
			80			dB
Large-Signal Voltage Gain	A_{VO}	$0.05\text{ V} \leq V_{OUT} \leq 1.75\text{ V}$, $R_L = 100\text{ k}\Omega$ to V_{CM} $-40^\circ\text{C} \leq T_A \leq +125^\circ\text{C}$	95	115		dB
			95			dB
Offset Voltage Drift	$\Delta V_{OS}/\Delta T$	$-40^\circ\text{C} \leq T_A \leq +125^\circ\text{C}$		2.5		$\mu\text{V}/^\circ\text{C}$
Input Resistance	R_{IN}			220		G Ω
Input Capacitance, Differential Mode	C_{INDM}			3		pF
Input Capacitance, Common Mode	C_{INCM}			4.2		pF
OUTPUT CHARACTERISTICS						
Output Voltage High	V_{OH}	$R_L = 100\text{ k}\Omega$ to GND $-40^\circ\text{C} \leq T_A \leq +125^\circ\text{C}$	1.78	1.79		V
			1.78			V
			1.65	1.75		V
			1.65			V
Output Voltage Low	V_{OL}	$R_L = 100\text{ k}\Omega$ to V_{SY} $-40^\circ\text{C} \leq T_A \leq +125^\circ\text{C}$		2	5	mV
					5	mV
				12	25	mV
					25	mV
Short-Circuit Limit	I_{SC}	$V_{OUT} = V_{SY}$ or GND		± 4.5		mA
POWER SUPPLY						
Power Supply Rejection Ratio	PSRR	$V_{SY} = 1.8\text{ V}$ to 5 V $-40^\circ\text{C} \leq T_A \leq +85^\circ\text{C}$ $-40^\circ\text{C} \leq T_A \leq +125^\circ\text{C}$	100	110		dB
			100			dB
			95			dB
Supply Current per Amplifier AD8506/AD8508	I_{SY}	$V_{OUT} = V_{SY}/2$ $-40^\circ\text{C} \leq T_A \leq +125^\circ\text{C}$		16.5	20	μA
					25	μA
				16.5	24	μA
					27.5	μA
AD8505	I_{SY}	$V_{OUT} = V_{SY}/2$ $-40^\circ\text{C} \leq T_A \leq +125^\circ\text{C}$		16.5	24	μA
					27.5	μA
						μA
DYNAMIC PERFORMANCE						
Slew Rate	SR	$R_L = 100\text{ k}\Omega$, $C_L = 10\text{ pF}$, $G = 1$		13		mV/ μs
Gain Bandwidth Product	GBP	$R_L = 1\text{ M}\Omega$, $C_L = 20\text{ pF}$, $G = 1$		95		kHz
Phase Margin	Φ_M	$R_L = 1\text{ M}\Omega$, $C_L = 20\text{ pF}$, $G = 1$		60		Degrees
NOISE PERFORMANCE						
Voltage Noise	e_n p-p	$f = 0.1\text{ Hz}$ to 10 Hz		2.8		μV p-p
Voltage Noise Density	e_n	$f = 1\text{ kHz}$		45		nV/ $\sqrt{\text{Hz}}$
Current Noise Density	i_n	$f = 1\text{ kHz}$		15		fA/ $\sqrt{\text{Hz}}$

AD8505/AD8506/AD8508

ELECTRICAL CHARACTERISTICS—5 V OPERATION

$V_{SY} = 5\text{ V}$, $V_{CM} = V_{SY}/2$, $T_A = 25^\circ\text{C}$, $R_L = 100\text{ k}\Omega$ to GND, unless otherwise noted.

Table 2.

Parameter	Symbol	Conditions	Min	Typ	Max	Unit
INPUT CHARACTERISTICS						
Offset Voltage	V_{OS}	$0\text{ V} \leq V_{CM} \leq 5\text{ V}$ $-40^\circ\text{C} \leq T_A \leq +125^\circ\text{C}$		0.5	2.5	mV
Input Bias Current	I_B	$-40^\circ\text{C} \leq T_A \leq +85^\circ\text{C}$		1	10	pA
		$-40^\circ\text{C} \leq T_A \leq +125^\circ\text{C}$			100	pA
Input Offset Current	I_{OS}	$-40^\circ\text{C} \leq T_A \leq +125^\circ\text{C}$			600	pA
		$-40^\circ\text{C} \leq T_A \leq +85^\circ\text{C}$		0.5	5	pA
		$-40^\circ\text{C} \leq T_A \leq +125^\circ\text{C}$				50
Input Voltage Range		$-40^\circ\text{C} \leq T_A \leq +125^\circ\text{C}$	0		130	pA
Common-Mode Rejection Ratio	CMRR	$0\text{ V} \leq V_{CM} \leq 5\text{ V}$	90	105		dB
		$-40^\circ\text{C} \leq T_A \leq +85^\circ\text{C}$	90			dB
		$-40^\circ\text{C} \leq T_A \leq +125^\circ\text{C}$	85			dB
Large-Signal Voltage Gain	A_{VO}	$0.05\text{ V} \leq V_{OUT} \leq 4.95\text{ V}$, $R_L = 100\text{ k}\Omega$ to V_{CM}	105	120		dB
		$-40^\circ\text{C} \leq T_A \leq +125^\circ\text{C}$	100			dB
Offset Voltage Drift	$\Delta V_{OS}/\Delta T$	$-40^\circ\text{C} \leq T_A \leq +125^\circ\text{C}$		2		$\mu\text{V}/^\circ\text{C}$
Input Resistance	R_{IN}			220		G Ω
Input Capacitance, Differential Mode	C_{INDM}			3		pF
Input Capacitance, Common Mode	C_{INCM}			4.2		pF
OUTPUT CHARACTERISTICS						
Output Voltage High	V_{OH}	$R_L = 100\text{ k}\Omega$ to GND	4.98	4.99		V
		$-40^\circ\text{C} \leq T_A \leq +125^\circ\text{C}$	4.98			V
		$R_L = 10\text{ k}\Omega$ to GND	4.9	4.95		V
		$-40^\circ\text{C} \leq T_A \leq +125^\circ\text{C}$	4.9			V
Output Voltage Low	V_{OL}	$R_L = 100\text{ k}\Omega$ to V_{SY}		2	5	mV
		$-40^\circ\text{C} \leq T_A \leq +125^\circ\text{C}$			5	mV
		$R_L = 10\text{ k}\Omega$ to V_{SY}		10	25	mV
		$-40^\circ\text{C} \leq T_A \leq +125^\circ\text{C}$			30	mV
Short-Circuit Limit	I_{SC}	$V_{OUT} = V_{SY}$ or GND		± 45		mA
POWER SUPPLY						
Power Supply Rejection Ratio	PSRR	$V_{SY} = 1.8\text{ V}$ to 5 V	100	110		dB
		$-40^\circ\text{C} \leq T_A \leq +85^\circ\text{C}$	100			dB
		$-40^\circ\text{C} \leq T_A \leq +125^\circ\text{C}$	95			dB
Supply Current per Amplifier AD8506/AD8508	I_{SY}	$V_{OUT} = V_{SY}/2$		15	20	μA
		$-40^\circ\text{C} \leq T_A \leq +125^\circ\text{C}$			25	μA
		$-40^\circ\text{C} \leq T_A \leq +125^\circ\text{C}$			25.5	μA
DYNAMIC PERFORMANCE						
Slew Rate	SR	$R_L = 100\text{ k}\Omega$, $C_L = 10\text{ pF}$, $G = 1$		13		mV/ μs
Gain Bandwidth Product	GBP	$R_L = 1\text{ M}\Omega$, $C_L = 20\text{ pF}$, $G = 1$		95		kHz
Phase Margin	Φ_M	$R_L = 1\text{ M}\Omega$, $C_L = 20\text{ pF}$, $G = 1$		60		Degrees
NOISE PERFORMANCE						
Voltage Noise	e_n p-p	$f = 0.1\text{ Hz}$ to 10 Hz		2.8		μV p-p
Voltage Noise Density	e_n	$f = 1\text{ kHz}$		45		nV/ $\sqrt{\text{Hz}}$
Current Noise Density	i_n	$f = 1\text{ kHz}$		15		fA/ $\sqrt{\text{Hz}}$

ABSOLUTE MAXIMUM RATINGS

Table 3.

Parameter	Rating
Supply Voltage	5.5 V
Input Voltage	$\pm V_{SY} \pm 0.1$ V
Input Current ¹	± 10 mA
Differential Input Voltage ²	$\pm V_{SY}$
Output Short-Circuit Duration to GND	Indefinite
Storage Temperature Range	-65°C to +150°C
Operating Temperature Range	-40°C to +125°C
Junction Temperature Range	-65°C to +150°C
Lead Temperature (Soldering, 60 sec)	300°C

¹ Input pins have clamp diodes to the supply pins. The input current should be limited to 10 mA or less whenever the input signal exceeds the power supply rail by 0.5 V.

² The differential input voltage is limited to 5 V or the supply voltage, whichever is less.

Stresses above those listed under Absolute Maximum Ratings may cause permanent damage to the device. This is a stress rating only; functional operation of the device at these or any other conditions above those indicated in the operational section of this specification is not implied. Exposure to absolute maximum rating conditions for extended periods may affect device reliability.

THERMAL RESISTANCE

θ_{JA} is specified for the worst-case conditions, that is, a device soldered in a circuit board for surface-mount packages with its exposed paddle soldered to a pad, if applicable. Table 4 shows simulated thermal values for a 4-layer (2S2P) JEDEC standard thermal test board, unless otherwise specified.

Table 4.

Package Type	θ_{JA}	θ_{JC}	Unit
5-Lead SOT-23 (RJ-5)	190	92	°C/W
6-Ball WLCSP (CB-6-7)	105	N/A	°C/W
8-Lead MSOP (RM-8)	142	45	°C/W
8-Ball WLCSP (CB-8-2)	82	N/A	°C/W
14-Lead TSSOP (RU-14)	112	35	°C/W
14-Ball WLCSP (CB-14-1)	64	N/A	°C/W

ESD CAUTION



ESD (electrostatic discharge) sensitive device. Charged devices and circuit boards can discharge without detection. Although this product features patented or proprietary protection circuitry, damage may occur on devices subjected to high energy ESD. Therefore, proper ESD precautions should be taken to avoid performance degradation or loss of functionality.

TYPICAL PERFORMANCE CHARACTERISTICS

$T_A = 25^\circ\text{C}$, unless otherwise noted.

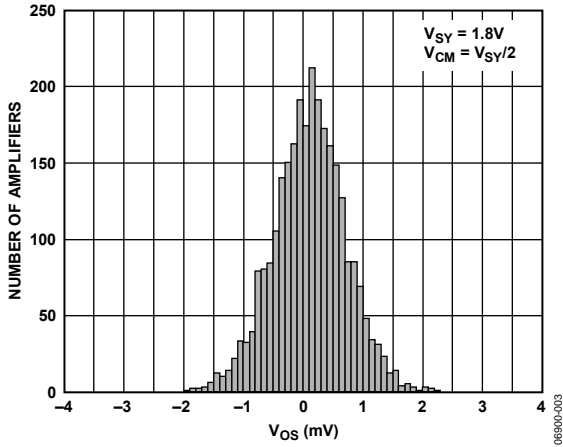

Figure 7. Input Offset Voltage Distribution

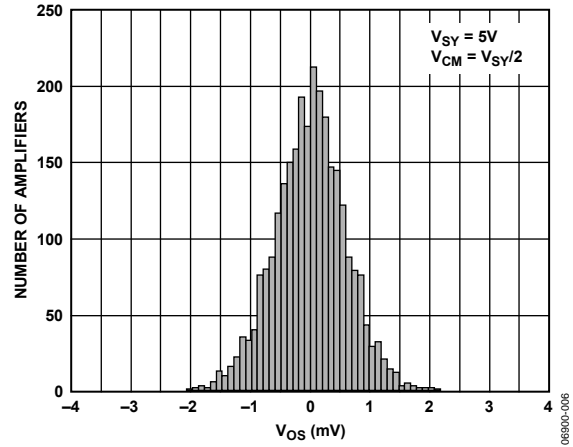

Figure 10. Input Offset Voltage Distribution

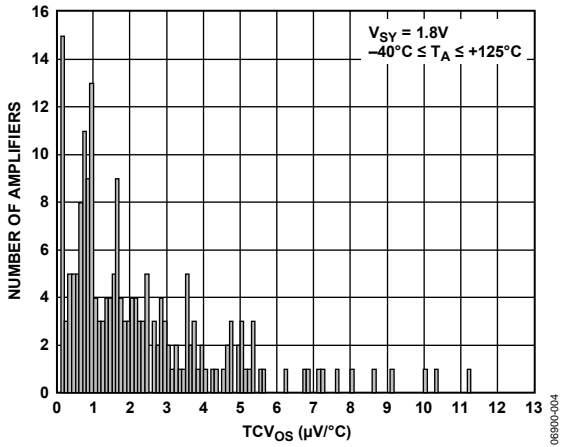

Figure 8. Input Offset Voltage Drift Distribution

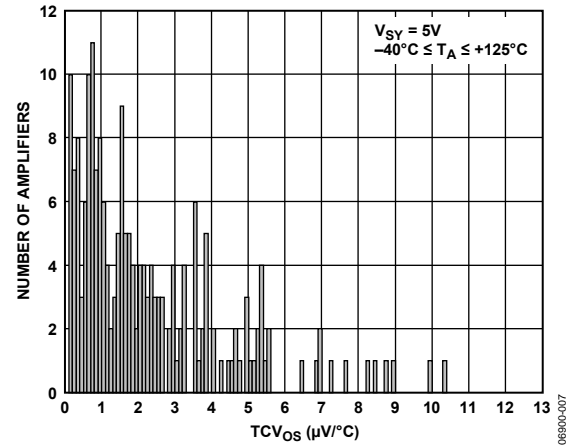

Figure 11. Input Offset Voltage Drift Distribution



Figure 9. Input Offset Voltage vs. Input Common-Mode Voltage

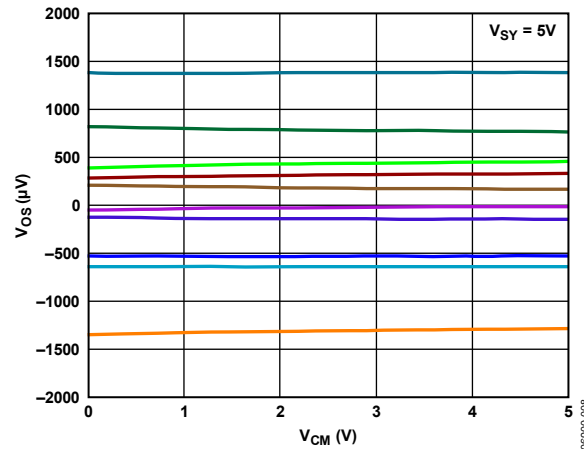

Figure 12. Input Offset Voltage vs. Input Common-Mode Voltage

$T_A = 25^\circ\text{C}$, unless otherwise noted.

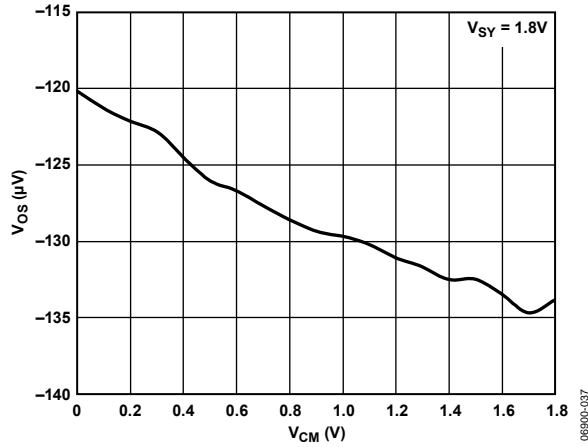

Figure 13. Input Offset Voltage vs. Input Common-Mode Voltage

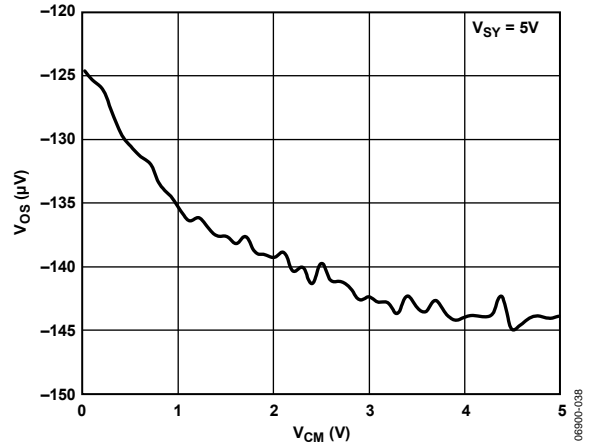

Figure 16. Input Offset Voltage vs. Input Common-Mode Voltage

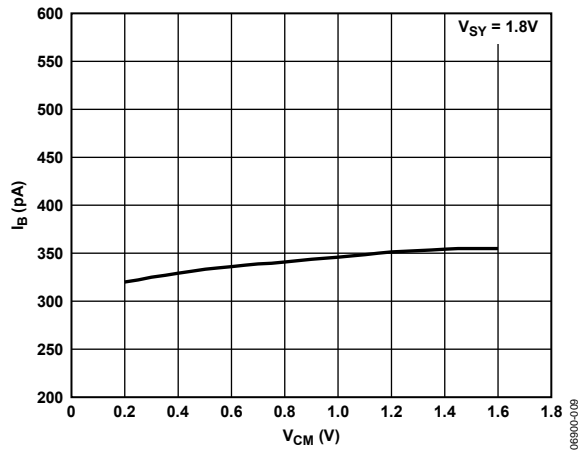

Figure 14. Input Bias Current vs. Input Common-Mode Voltage at 125°C



Figure 17. Input Bias Current vs. Input Common-Mode Voltage at 125°C



Figure 15. Input Bias Current vs. Temperature



Figure 18. Input Bias Current vs. Temperature

AD8505/AD8506/AD8508

$T_A = 25^\circ\text{C}$, unless otherwise noted.

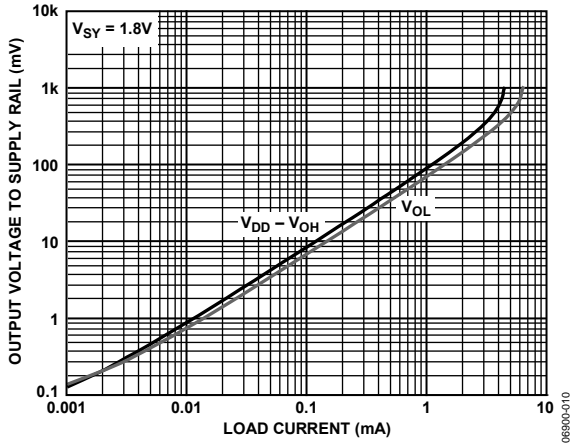

Figure 19. Output Voltage to Supply Rail vs. Load Current

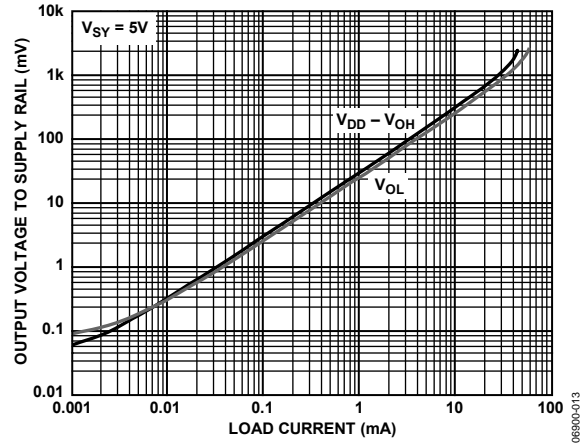

Figure 22. Output Voltage to Supply Rail vs. Load Current



Figure 20. Output Voltage to Supply Rail vs. Temperature



Figure 23. Output Voltage to Supply Rail vs. Temperature

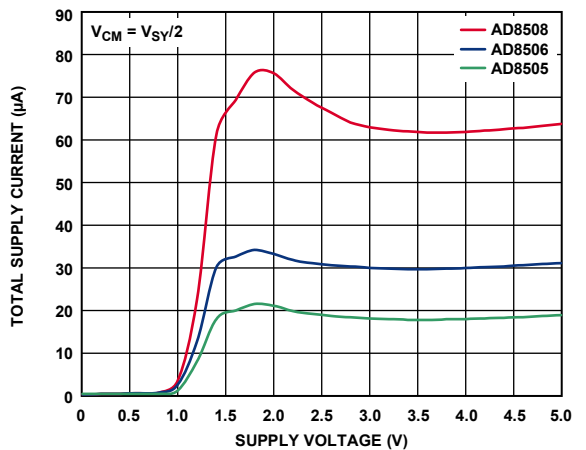

Figure 21. Total Supply Current vs. Supply Voltage

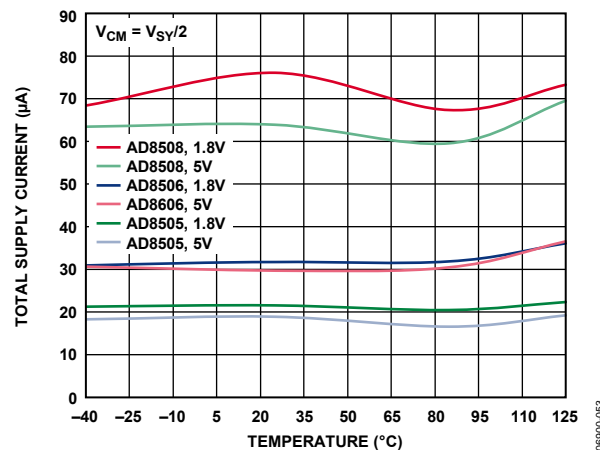

Figure 24. Total Supply Current vs. Temperature

$T_A = 25^\circ\text{C}$, unless otherwise noted.



Figure 25. Open-Loop Gain and Phase vs. Frequency



Figure 28. Open-Loop Gain and Phase vs. Frequency



Figure 26. Closed-Loop Gain vs. Frequency



Figure 29. Closed-Loop Gain vs. Frequency



Figure 27. Z_{OUT} vs. Frequency



Figure 30. Z_{OUT} vs. Frequency

AD8505/AD8506/AD8508

$T_A = 25^\circ\text{C}$, unless otherwise noted.



Figure 31. CMRR vs. Frequency



Figure 34. CMRR vs. Frequency



Figure 32. PSRR vs. Frequency



Figure 35. PSRR vs. Frequency



Figure 33. Small-Signal Overshoot vs. Load Capacitance



Figure 36. Small-Signal Overshoot vs. Load Capacitance

$T_A = 25^\circ\text{C}$, unless otherwise noted.



Figure 37. Large-Signal Transient Response



Figure 40. Large-Signal Transient Response



Figure 38. Small-Signal Transient Response



Figure 41. Small-Signal Transient Response



Figure 39. Input Voltage Noise 0.1 Hz to 10 Hz

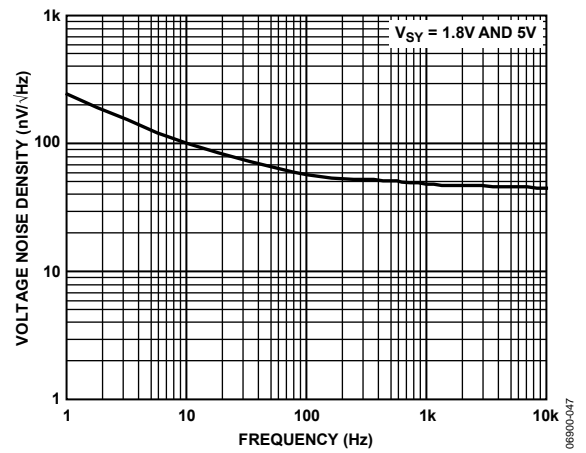

Figure 42. Voltage Noise Density vs. Frequency

AD8505/AD8506/AD8508

$T_A = 25^\circ\text{C}$, unless otherwise noted.



Figure 43. Channel Separation vs. Frequency



Figure 44. Channel Separation vs. Frequency

THEORY OF OPERATION

The AD8505/AD8506/AD8508 are unity-gain, stable, CMOS, rail-to-rail input/output operational amplifiers designed to optimize performance in current consumption, PSRR, CMRR, and zero crossover distortion, all embedded in a small package. The typical offset voltage is 500 μV , with a low peak-to-peak voltage noise of 2.8 μV from 0.1 Hz to 10 Hz and a voltage noise density of 45 $\text{nV}/\sqrt{\text{Hz}}$ at 1 kHz.

The AD8505/AD8506/AD8508 amplifiers are designed to solve two key problems in low voltage battery-powered applications: the battery voltage decrease over time and the rail-to-rail input stage distortion.

In battery-powered applications, the supply voltage available to the IC is the voltage of the battery. Unfortunately, the voltage of a battery decreases as it discharges itself through the load. This voltage drop over the lifetime of the battery causes an error in the output of the op amps. Some applications requiring precision measurements during the entire lifetime of the battery use voltage regulators to power up the op amps as a solution. If a design uses standard battery cells, the op amps experience a supply voltage change from roughly 3.2 V to 1.8 V during the lifetime of the battery. This means that for a PSRR of 70 dB minimum in a typical op amp, the input-referred offset error is approximately 440 μV . If the same application uses the AD8505/AD8506/AD8508 amplifiers with a 100 dB minimum PSRR, the error is only 14 μV . It is possible to calibrate out this error or to use an external voltage regulator to power the op amp, but these solutions can increase system cost and complexity. The AD8505/AD8506/AD8508 amplifiers solve the impasse with no additional cost or error-nullifying circuitry.

The second problem with battery-powered applications is the distortion caused by the standard rail-to-rail input stage. Using a CMOS non-rail-to-rail input stage (that is, a single differential pair) limits the input voltage to approximately one V_{GS} (gate-source voltage) away from one of the supply lines. Because V_{GS} for normal operation is commonly over 1 V, a single differential pair input stage op amp greatly restricts the allowable input voltage range when using a low supply voltage. This limitation restricts the number of applications where the non-rail-to-rail input op amp was originally intended to be used. To solve this problem, a dual differential pair input stage is usually implemented (see Figure 45); however, this technique has its own drawbacks.

One differential pair amplifies the input signal when the common-mode voltage is on the high end, whereas the other pair amplifies the input signal when the common-mode voltage is on the low end. This method also requires control circuitry to operate the two differential pairs appropriately. Unfortunately, this topology leads to a very noticeable and undesirable problem: if the signal level moves through the range where one input stage turns off and the other one turns on, noticeable distortion occurs (see Figure 46).

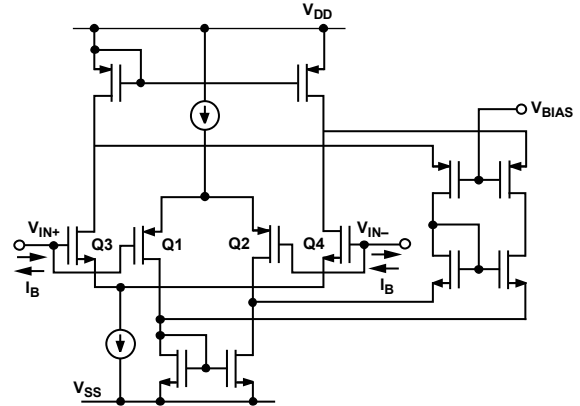

Figure 45. A Typical Dual Differential Pair Input Stage Op Amp (Dual PMOS Q1 and Q2 Transistors Form the Lower End of the Input Voltage Range, Whereas Dual NMOS Q3 and Q4 Compose the Upper End)



Figure 46. Typical Input Offset Voltage vs. Common-Mode Voltage Response in a Dual Differential Pair Input Stage Op Amp (Powered by 5 V Supply; Results of Approximately 100 Units per Graph Are Displayed)

This distortion forces the designer to devise impractical ways to avoid the crossover distortion areas, therefore narrowing the common-mode dynamic range of the operational amplifier. The AD8505/AD8506/AD8508 amplifiers solve this crossover distortion problem by using an on-chip charge pump to power the input differential pair. The charge pump creates a supply voltage higher than the voltage of the battery, allowing the input stage to handle a wide range of input signal voltages without using a second differential pair. With this solution, the input voltage can vary from one supply extreme to the other with no distortion, thereby restoring the full common-mode dynamic range of the op amp.

AD8505/AD8506/AD8508

The charge pump has been carefully designed so that switching noise components at any frequency, both within and beyond the amplifier bandwidth, are much lower than the thermal noise floor. Therefore, the spurious-free dynamic range (SFDR) is limited only by the input signal and the thermal or flicker noise. There is no intermodulation between the input signal and the switching noise.

Figure 47 displays a typical front-end section of an operational amplifier with an on-chip charge pump.



Figure 47. Typical Front-End Section of an Op Amp with Embedded Charge Pump

Figure 48, the input offset voltage vs. input common-mode voltage response, shows the typical response of 12 devices. Figure 48 is expanded to make it easier to compare with Figure 46, the typical input offset voltage vs. common-mode voltage response in a dual differential pair input stage op amp.



Figure 48. Input Offset Voltage vs. Input Common-Mode Voltage Response (Powered by a 5 V Supply; Results of 12 Units Are Displayed)

This solution improves the CMRR performance tremendously. For instance, if the input varies from rail to rail on a 2.5 V supply rail, using a part with a CMRR of 70 dB minimum, an input-referred error of 790 μ V is introduced. Another part with a CMRR of 52 dB minimum generates a 6.3 mV error. The AD8505/AD8506/AD8508 CMRR of 90 dB minimum causes only a 79 μ V error. As with the PSRR error, there are complex ways to minimize this error, but the AD8505/AD8506/AD8508 amplifiers solve this problem without incurring unnecessary circuitry complexity or increased cost.

APPLICATIONS INFORMATION

PULSE OXIMETER CURRENT SOURCE

A pulse oximeter is a noninvasive medical device used for continuously measuring the percentage of hemoglobin (Hb) saturated with oxygen and the pulse rate of a patient. Hemoglobin that is carrying oxygen (oxyhemoglobin) absorbs light in the infrared (IR) region of the spectrum; hemoglobin that is not carrying oxygen (deoxyhemoglobin) absorbs visible red (R) light. In pulse oximetry, a clip containing two LEDs (sometimes more, depending on the complexity of the measurement algorithm) and the light sensor (photodiode) is placed on the finger or earlobe of the patient. One LED emits red light (600 nm to 700 nm) and the other emits light in the near IR (800 nm to 900 nm) region. The clip is connected by a cable to a processor unit. The LEDs are rapidly and sequentially excited by two current sources (one for each LED), whose dc levels depend on the LED being driven, based on manufacturer requirements, and the detector is synchronized to capture the light from each LED as it is transmitted through the tissue.

An example design of a dc current source driving the red and infrared LEDs is shown in Figure 49. These dc current sources allow 62.5 mA and 101 mA to flow through the red and infrared LEDs, respectively. First, to prolong battery life, the LEDs are driven only when needed. One-third of the ADG733 SPDT analog switch is used to disconnect or connect the 1.25 V voltage reference from or to each current circuit. When driving the LEDs, the ADR1581 1.25 V voltage reference is buffered by half of the AD8506; the presence of this voltage on the noninverting input forces the output of the op amp (due to the negative feedback) to maintain a level that causes its inverting input to track the noninverting pin. Therefore, the 1.25 V appears in parallel with the 20 Ω R1 or 12.4 Ω R5 current source resistor, creating the flow of 62.5 mA or 101 mA current through the red or infrared LED as the output of the op amp turns on the Q1 or Q2 N-MOSFET IRLMS2002.

The maximum total quiescent currents for the AD8506 (that is, half of the AD8506), ADR1581, and ADG733 are 25 μA, 70 μA, and 1 μA, respectively, resulting in a total of 96 μA current consumption (480 μW power consumption) per circuit, which is good for a system powered by a battery. If the accuracy and temperature

drift of the total design need to be improved, then a more accurate and low temperature coefficient drift voltage reference and current source resistor should be utilized. C3 and C4 are used to improve stabilization of U1; R3 and R7 are used to provide some current limit into the U1 inverting pin; and R2 and R6 are used to slow down the rise time of the N-MOSFET when it turns on. These elements may not be needed, or some bench adjustments may be required.

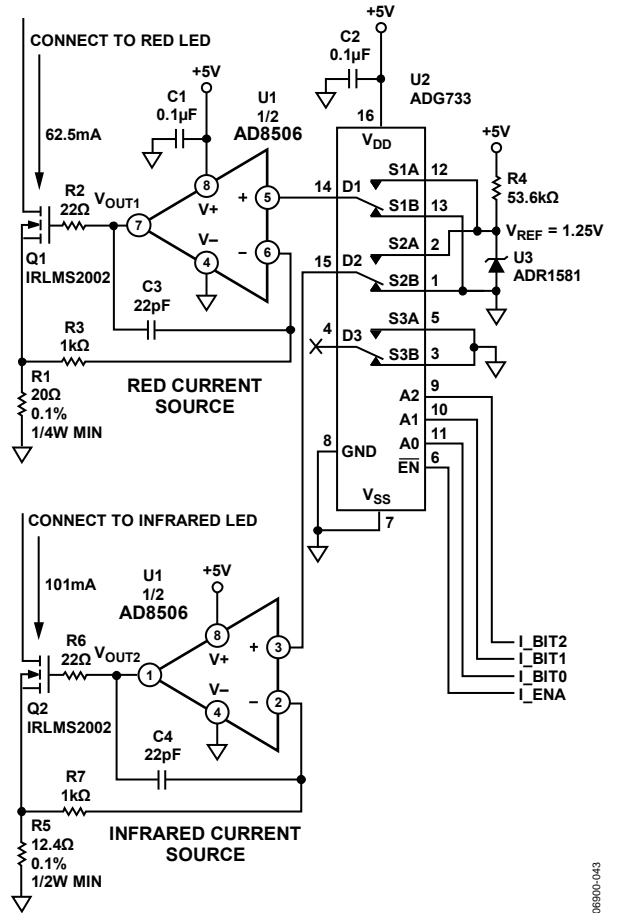

Figure 49. Pulse Oximeter Red and Infrared Current Sources Using the AD8506 as a Buffer to the Voltage Reference Device

06800-043

AD8505/AD8506/AD8508

FOUR-POLE, LOW-PASS BUTTERWORTH FILTER FOR GLUCOSE MONITOR

There are several methods of glucose monitoring: spectroscopic absorption of infrared light in the 2 μm to 2.5 μm range, reflectance spectrophotometry, and the amperometric type using electrochemical strips with glucose oxidase enzymes. The amperometric type generally uses three electrodes: a reference electrode, a control electrode, and a working electrode. Although this is a well established and widely used technique, signal-to-noise ratio and repeatability can be improved using the AD8505/AD8506/AD8508 amplifiers with their low peak-to-peak voltage noise of 2.8 μV from 0.1 Hz to 10 Hz and voltage noise density of 45 nV/ $\sqrt{\text{Hz}}$ at 1 kHz.

Another consideration is operation from a 3.3 V battery. Glucose signal currents are usually less than 3 μA full scale; therefore,

the I-to-V converter requires low input bias current. The AD8505/AD8506/AD8508 are excellent choices because these amplifiers provide 1 pA typical and 10 pA maximum of input bias current at ambient temperature.

A low-pass filter with a cutoff frequency of 80 Hz to 100 Hz is desirable in a glucose meter device to remove extraneous noise; this can be a simple two-pole or four-pole Butterworth filter. Low power op amps with bandwidths of 50 kHz to 500 kHz should be adequate. The AD8505/AD8506/AD8508 amplifiers with their 95 kHz GBP and 15 μA typical current consumption meet these requirements. A circuit design of a four-pole Butterworth filter (preceded by a one-pole, low-pass filter) is shown in Figure 50. With a 3.3 V battery, the total power consumption of this design is 297 μW typical at ambient temperature.



Figure 50. A Four-Pole Butterworth Filter That Can Be Used in a Glucose Meter

06890-044

OUTLINE DIMENSIONS



COMPLIANT TO JEDEC STANDARDS MO-178-AA

Figure 51. 5-Lead Small Outline Transistor Package [SOT-23] (RJ-5)

Dimensions shown in millimeters

121608-A



Figure 52. 6-Ball Wafer Level Chip Scale Package [WLCSP] (CB-6-7)

Dimensions shown in millimeters

081709-A

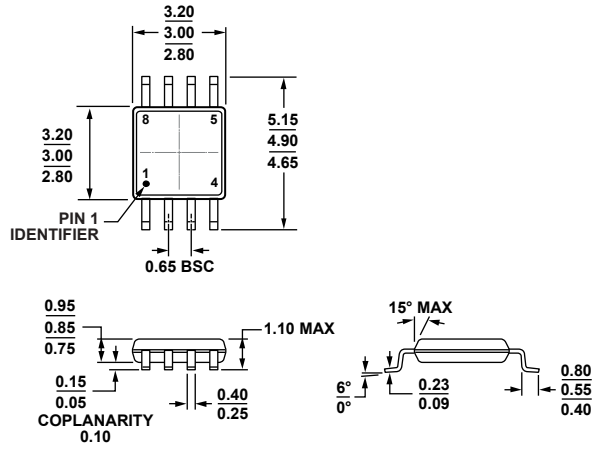

COMPLIANT TO JEDEC STANDARDS MO-187-AA

Figure 53. 8-Lead Mini Small Outline Package [MSOP] (RM-8)

Dimensions shown in millimeters

100709-B

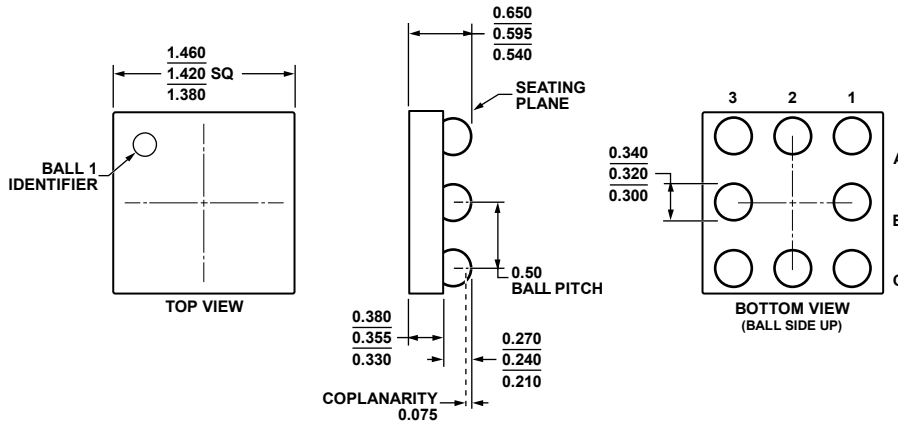

Figure 54. 8-Ball Wafer Level Chip Scale Package [WLCSP] (CB-8-2)

Dimensions shown in millimeters

0110019-B



COMPLIANT TO JEDEC STANDARDS MO-153-AB-1

Figure 55. 14-Lead Thin Shrink Small Outline Package [TSSOP] (RU-14)

Dimensions shown in millimeters

061908-A

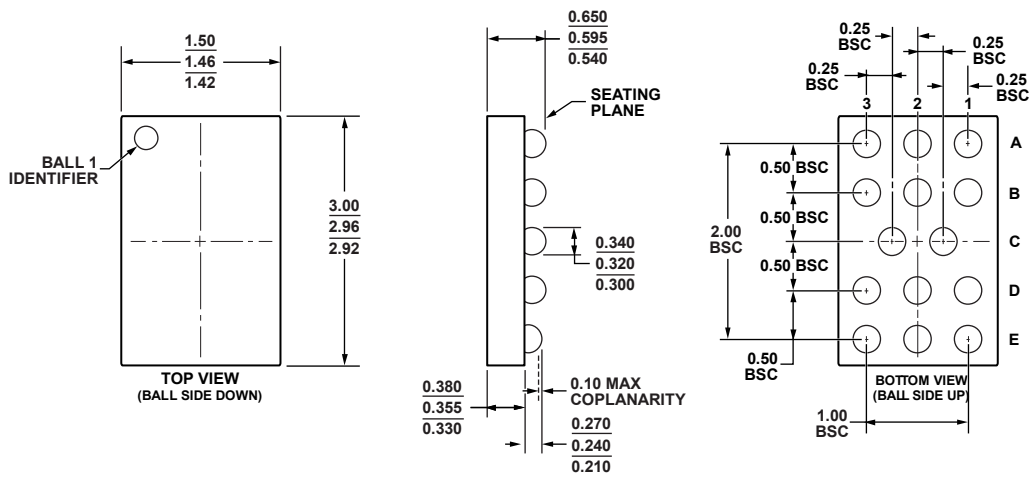

Figure 56. 14-Ball Wafer Level Chip Scale Package [WLCSP] (CB-14-1)

Dimensions shown in millimeters

061208-A

AD8505/AD8506/AD8508

ORDERING GUIDE

Model ¹	Temperature Range	Package Description	Package Option	Branding
AD8505ARJZ-R2	-40°C to +125°C	5-Lead Small Outline Transistor Package [SOT-23]	RJ-5	A2E
AD8505ARJZ-R7	-40°C to +125°C	5-Lead Small Outline Transistor Package [SOT-23]	RJ-5	A2E
AD8505ARJZ-RL	-40°C to +125°C	5-Lead Small Outline Transistor Package [SOT-23]	RJ-5	A2E
AD8505ACBZ-R7	-40°C to +125°C	6-Ball Wafer Level Chip Scale Package [WLCSP]	CB-6-7	A2H
AD8505ACBZ-RL	-40°C to +125°C	6-Ball Wafer Level Chip Scale Package [WLCSP]	CB-6-7	A2H
AD8506ACBZ-REEL	-40°C to +125°C	8-Ball Wafer Level Chip Scale Package [WLCSP]	CB-8-2	A1X
AD8506ACBZ-REEL7	-40°C to +125°C	8-Ball Wafer Level Chip Scale Package [WLCSP]	CB-8-2	A1X
AD8506ARMZ	-40°C to +125°C	8-Lead Mini Small Outline Package [MSOP]	RM-8	A1X
AD8506ARMZ-R7	-40°C to +125°C	8-Lead Mini Small Outline Package [MSOP]	RM-8	A1X
AD8506ARMZ-REEL	-40°C to +125°C	8-Lead Mini Small Outline Package [MSOP]	RM-8	A1X
AD8508ARUZ	-40°C to +125°C	14-Lead Thin Shrink Small Outline Package [TSSOP]	RU-14	
AD8508ARUZ-REEL	-40°C to +125°C	14-Lead Thin Shrink Small Outline Package [TSSOP]	RU-14	
AD8508ACBZ-REEL	-40°C to +125°C	14-Ball Wafer Level Chip Scale Package [WLCSP]	CB-14-1	A27
AD8508ACBZ-REEL7	-40°C to +125°C	14-Ball Wafer Level Chip Scale Package [WLCSP]	CB-14-1	A27

¹ Z = RoHS Compliant Part.

Компания «Океан Электроники» предлагает заключение долгосрочных отношений при поставках импортных электронных компонентов на взаимовыгодных условиях!

Наши преимущества:

- Поставка оригинальных импортных электронных компонентов напрямую с производств Америки, Европы и Азии, а так же с крупнейших складов мира;
- Широкая линейка поставок активных и пассивных импортных электронных компонентов (более 30 млн. наименований);
- Поставка сложных, дефицитных, либо снятых с производства позиций;
- Оперативные сроки поставки под заказ (от 5 рабочих дней);
- Экспресс доставка в любую точку России;
- Помощь Конструкторского Отдела и консультации квалифицированных инженеров;
- Техническая поддержка проекта, помощь в подборе аналогов, поставка прототипов;
- Поставка электронных компонентов под контролем ВП;
- Система менеджмента качества сертифицирована по Международному стандарту ISO 9001;
- При необходимости вся продукция военного и аэрокосмического назначения проходит испытания и сертификацию в лаборатории (по согласованию с заказчиком);
- Поставка специализированных компонентов военного и аэрокосмического уровня качества (Xilinx, Altera, Analog Devices, Intersil, Interpoint, Microsemi, Actel, Aeroflex, Peregrine, VPT, Syfer, Eurofarad, Texas Instruments, MS Kennedy, Miteq, Cobham, E2V, MA-COM, Hittite, Mini-Circuits, General Dynamics и др.);

Компания «Океан Электроники» является официальным дистрибьютором и эксклюзивным представителем в России одного из крупнейших производителей разъемов военного и аэрокосмического назначения «JONHON», а так же официальным дистрибьютором и эксклюзивным представителем в России производителя высокотехнологичных и надежных решений для передачи СВЧ сигналов «FORSTAR».



JONHON

«JONHON» (основан в 1970 г.)

Разъемы специального, военного и аэрокосмического назначения:

(Применяются в военной, авиационной, аэрокосмической, морской, железнодорожной, горно- и нефтедобывающей отраслях промышленности)

«FORSTAR» (основан в 1998 г.)

ВЧ соединители, коаксиальные кабели, кабельные сборки и микроволновые компоненты:

(Применяются в телекоммуникациях гражданского и специального назначения, в средствах связи, РЛС, а так же военной, авиационной и аэрокосмической отраслях промышленности).



Телефон: 8 (812) 309-75-97 (многоканальный)

Факс: 8 (812) 320-03-32

Электронная почта: ocean@oceanchips.ru

Web: <http://oceanchips.ru/>

Адрес: 198099, г. Санкт-Петербург, ул. Калинина, д. 2, корп. 4, лит. А