

RF Power LDMOS Transistors

N-Channel Enhancement-Mode Lateral MOSFETs

These high ruggedness devices are designed for use in high VSWR military, industrial (including laser and plasma exciters), broadcast (analog and digital), and radio/land mobile applications. They are unmatched input and output designs allowing wide frequency range utilization between 1.8 and 600 MHz.

- Typical Performance: $V_{DD} = 50$ Vdc, $I_{DQ} = 100$ mA

Signal Type	P_{out} (W)	f (MHz)	G_{ps} (dB)	η_D (%)	IRL (dB)
Pulse (100 μ sec, 20% Duty Cycle)	300 Peak	230	26.5	74.0	-16
CW	300 Avg.	130	25.0	80.0	-15

- Capable of Handling a Load Mismatch of 65:1 VSWR @ 50 Vdc, 230 MHz, at all Phase Angles
 - 300 W CW Output Power
 - 300 W Pulse Peak Power, 20% Duty Cycle, 100 μ sec
- Capable of 300 W CW Operation

Features

- Unmatched Input and Output Allowing Wide Frequency Range Utilization
- Device can be used Single-Ended or in a Push-Pull Configuration
- Qualified Up to a Maximum of 50 V_{DD} Operation
- Characterized from 30 V to 50 V for Extended Power Range
- Suitable for Linear Application with Appropriate Biasing
- Integrated ESD Protection
- Greater Negative Gate-Source Voltage Range for Improved Class C Operation
- Characterized with Series Equivalent Large-Signal Impedance Parameters
- NI-780H-4L in Tape and Reel. R5 Suffix = 50 Units, 56 mm Tape Width, 13-inch Reel.
- NI-780S-4L in Tape and Reel. R5 Suffix = 50 Units, 32 mm Tape Width, 13-inch Reel.

Table 1. Maximum Ratings

Rating	Symbol	Value	Unit
Drain-Source Voltage	V_{DSS}	-0.5, +133	Vdc
Gate-Source Voltage	V_{GS}	-6.0, +10	Vdc
Storage Temperature Range	T_{stg}	-65 to +150	$^{\circ}$ C
Case Operating Temperature	T_C	150	$^{\circ}$ C
Total Device Dissipation @ $T_C = 25^{\circ}$ C Derate above 25 $^{\circ}$ C	P_D	1050 5.26	W W/ $^{\circ}$ C
Operating Junction Temperature (1,2)	T_J	225	$^{\circ}$ C

Table 2. Thermal Characteristics

Characteristic	Symbol	Value (2,3)	Unit
Thermal Resistance, Junction to Case (4) Pulse: Case Temperature 75 $^{\circ}$ C, 300 W Peak, 100 μ sec Pulse Width, 20% Duty Cycle, 50 Vdc, $I_{DQ} = 100$ mA, 230 MHz CW: Case Temperature 87 $^{\circ}$ C, 300 W CW, 50 Vdc, $I_{DQ} = 1100$ mA, 230 MHz	$Z_{\theta JC}$ $R_{\theta JC}$	0.05 0.19	$^{\circ}$ C/W

- Continuous use at maximum temperature will affect MTTF.
- MTTF calculator available at <http://www.freescale.com/rf>. Select Software & Tools/Development Tools/Calculators to access MTTF calculators by product.
- Refer to AN1955, *Thermal Measurement Methodology of RF Power Amplifiers*. Go to <http://www.freescale.com/rf>. Select Documentation/Application Notes - AN1955.
- Same test circuit is used for both pulsed and CW.

MMRF1310HR5 MMRF1310HSR5

1.8-600 MHz, 300 W CW, 50 V
BROADBAND
RF POWER MOSFETs

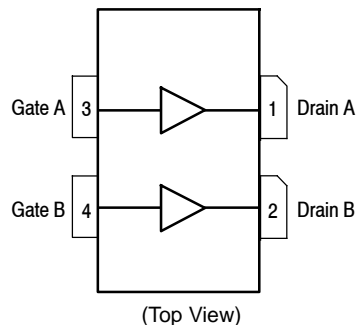
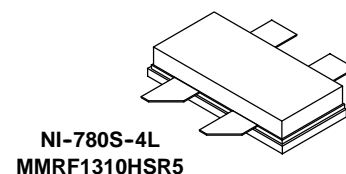
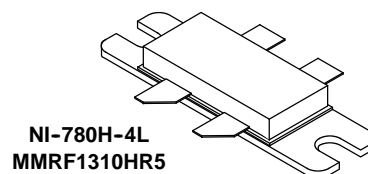

Note: The backside of the package is the source terminal for the transistors.

Figure 1. Pin Connections

Table 3. ESD Protection Characteristics

Test Methodology	Class
Human Body Model (per JESD22-A114)	2
Machine Model (per EIA/JESD22-A115)	B
Charge Device Model (per JESD22-C101)	IV

Table 4. Electrical Characteristics ($T_A = 25^\circ\text{C}$ unless otherwise noted)

Characteristic	Symbol	Min	Typ	Max	Unit
----------------	--------	-----	-----	-----	------

Off Characteristics (1)

Gate-Source Leakage Current ($V_{GS} = 5\text{ Vdc}$, $V_{DS} = 0\text{ Vdc}$)	I_{GSS}	—	—	1	μA
Drain-Source Breakdown Voltage ($V_{GS} = 0\text{ Vdc}$, $I_D = 50\text{ mA}$)	$V_{(BR)DSS}$	133	—	—	Vdc
Zero Gate Voltage Drain Leakage Current ($V_{DS} = 50\text{ Vdc}$, $V_{GS} = 0\text{ Vdc}$)	I_{DSS}	—	—	5	μA
Zero Gate Voltage Drain Leakage Current ($V_{DS} = 100\text{ Vdc}$, $V_{GS} = 0\text{ Vdc}$)	I_{DSS}	—	—	10	μA

On Characteristics

Gate Threshold Voltage (1) ($V_{DS} = 10\text{ Vdc}$, $I_D = 480\ \mu\text{A}$)	$V_{GS(th)}$	1.7	2.2	2.7	Vdc
Gate Quiescent Voltage ($V_{DD} = 50\text{ Vdc}$, $I_D = 100\text{ mA}$, Measured in Functional Test)	$V_{GS(Q)}$	2.0	2.5	3.0	Vdc
Drain-Source On-Voltage (1) ($V_{GS} = 10\text{ Vdc}$, $I_D = 1\text{ A}$)	$V_{DS(on)}$	—	0.25	—	Vdc

Dynamic Characteristics (1)

Reverse Transfer Capacitance ($V_{DS} = 50\text{ Vdc} \pm 30\text{ mV(rms)}$ ac @ 1 MHz, $V_{GS} = 0\text{ Vdc}$)	C_{rss}	—	0.8	—	pF
Output Capacitance ($V_{DS} = 50\text{ Vdc} \pm 30\text{ mV(rms)}$ ac @ 1 MHz, $V_{GS} = 0\text{ Vdc}$)	C_{oss}	—	76	—	pF
Input Capacitance ($V_{DS} = 50\text{ Vdc}$, $V_{GS} = 0\text{ Vdc} \pm 30\text{ mV(rms)}$ ac @ 1 MHz)	C_{iss}	—	188	—	pF

Functional Tests (In Freescale Test Fixture, 50 ohm system) $V_{DD} = 50\text{ Vdc}$, $I_{DQ} = 100\text{ mA}$, $P_{out} = 300\text{ W Peak}$ (60 W Avg.), $f = 230\text{ MHz}$, 100 μsec Pulse Width, 20% Duty Cycle

Power Gain	G_{ps}	25.0	26.5	28.0	dB
Drain Efficiency	η_D	72.0	74.0	—	%
Input Return Loss	IRL	—	-16	-9	dB

Load Mismatch (In Freescale Application Test Fixture, 50 ohm system) $V_{DD} = 50\text{ Vdc}$, $I_{DQ} = 100\text{ mA}$

VSWR 65:1 at all Phase Angles Pulse: $P_{out} = 300\text{ W Peak}$ (60 W Avg.), $f = 230\text{ MHz}$, 100 μsec Pulse Width, 20% Duty Cycle CW: $P_{out} = 300\text{ W Avg.}$, $f = 130\text{ MHz}$	Ψ	No Degradation in Output Power			
--	--------	--------------------------------	--	--	--

1. Each side of device measured separately.

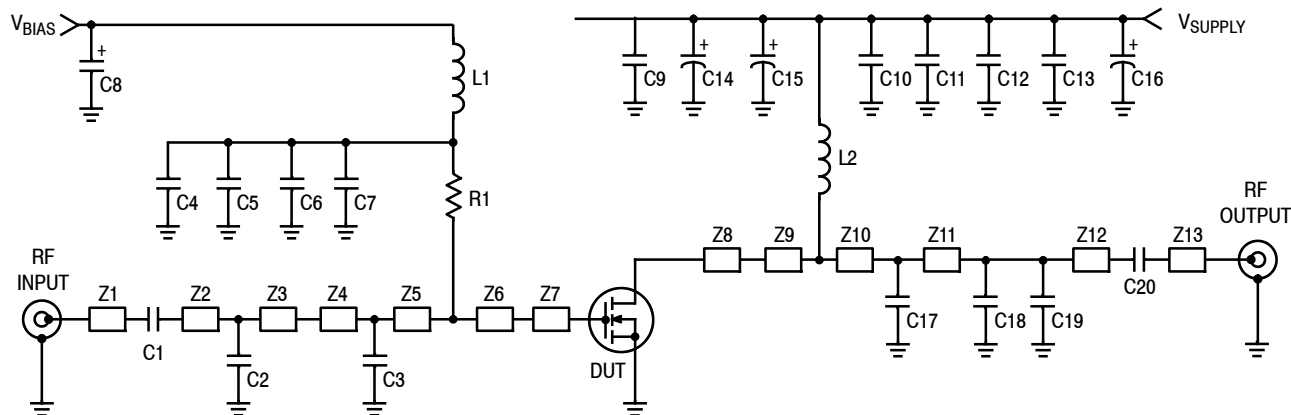

Z1	0.352" x 0.080" Microstrip	Z9	0.192" x 0.170" Microstrip
Z2*	1.780" x 0.080" Microstrip	Z10*	0.366" x 0.170" Microstrip
Z3*	0.576" x 0.080" Microstrip	Z11*	2.195" x 0.170" Microstrip
Z4	0.220" x 0.220" Microstrip	Z12*	0.614" x 0.170" Microstrip
Z5	0.322" x 0.220" Microstrip	Z13	0.243" x 0.080" Microstrip
Z6	0.168" x 0.220" Microstrip		
Z7, Z8	0.282" x 0.630" Microstrip		

* Line length includes microstrip bends

Note: Same test circuit is used for both pulsed and CW.

Figure 2. MMRF1310HR5(HSR5) Test Circuit Schematic

Table 5. MMRF1310HR5(HSR5) Test Circuit Component Designations and Values

Part	Description	Part Number	Manufacturer
C1, C20	15 pF Chip Capacitors	ATC100B150JT500XT	ATC
C2	82 pF Chip Capacitor	ATC100B820JT500XT	ATC
C3, C17	91 pF Chip Capacitors	ATC100B910JT500XT	ATC
C4, C10	1000 pF Chip Capacitors	ATC100B102JT50XT	ATC
C5, C11	10K pF Chip Capacitors	ATC200B103KT50XT	ATC
C6	0.1 μ F, 50 V Chip Capacitor	CDR33BX104AKWS	AVX
C7	2.2 μ F, 100 V Chip Capacitor	HMK432B7225KM-T	Taiyo Yuden
C8	10 μ F, 35 V Tantalum Capacitor	T491D106K035AT	Kemet
C9	2.2 μ F, 100 V Chip Capacitor	G2225X7R225KT3AB	ATC
C12	0.1 μ F, 100 V Chip Capacitor	C1812F104K1RAC	Kemet
C13	0.01 μ F, 100 V Chip Capacitor	C1825C103K1GAC	Kemet
C14, C15, C16	220 μ F, 100 V Electrolytic Capacitors	MCGPR100V227M16X26-RH	Multicomp
C18, C19	18 pF Chip Capacitors	ATC100B180JT500XT	ATC
L1	120 nH Inductor	1812SMS-R12JLC	Coilcraft
L2	17.5 nH Inductor	GA3095-ALC	Coilcraft
R1	1000 Ω , 1/2 W Chip Resistor	CRCW20101K00FKEF	Vishay
PCB	0.030", $\epsilon_r = 2.55$	AD255A	Arlon

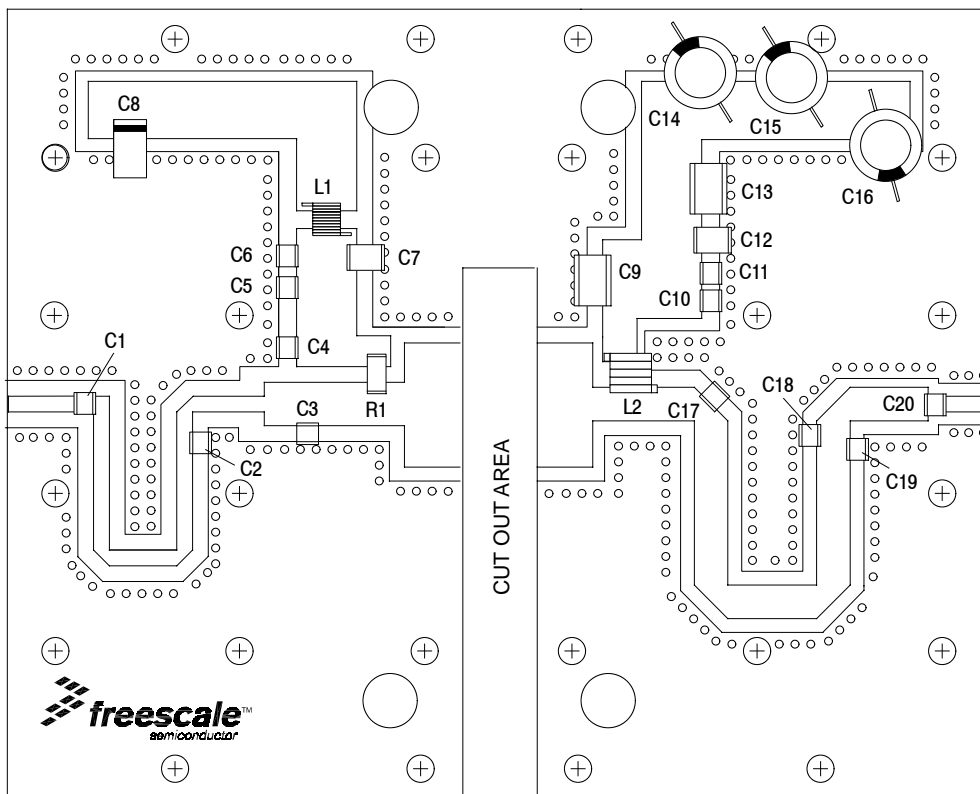
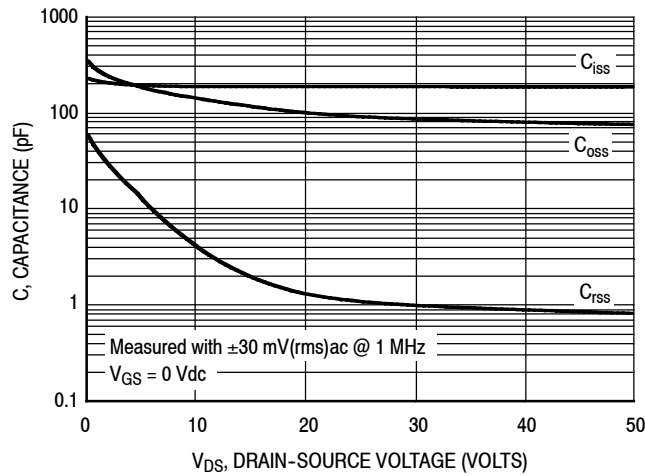

Figure 3. MMRF1310HR5(HSR5) Test Circuit Component Layout

TYPICAL CHARACTERISTICS — PULSED



Note: Each side of device measured separately.

Figure 4. Capacitance versus Drain-Source Voltage

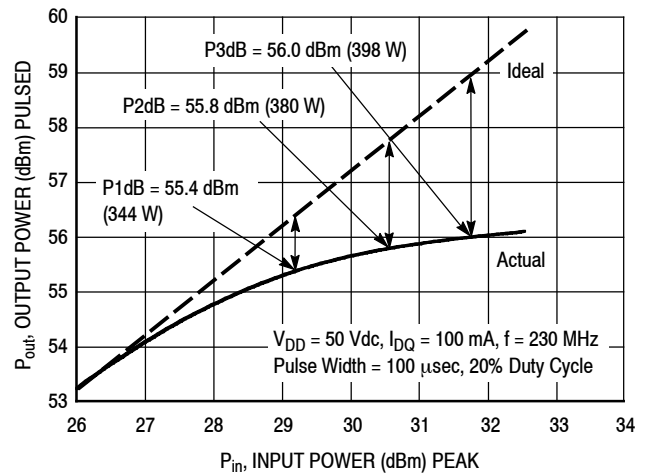

Figure 5. Output Power versus Input Power

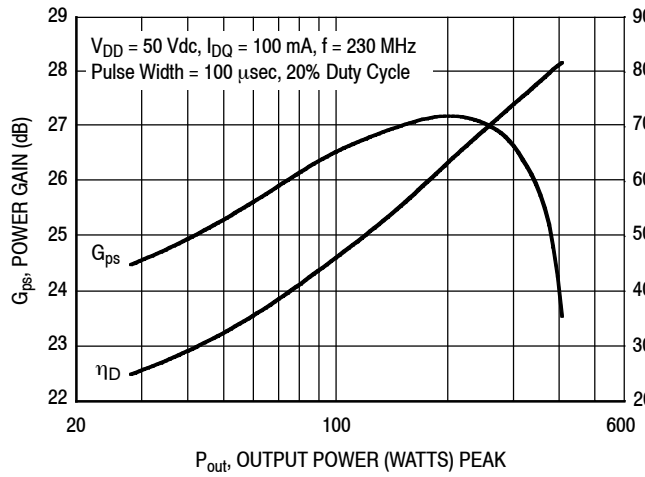

Figure 6. Power Gain and Drain Efficiency versus Output Power

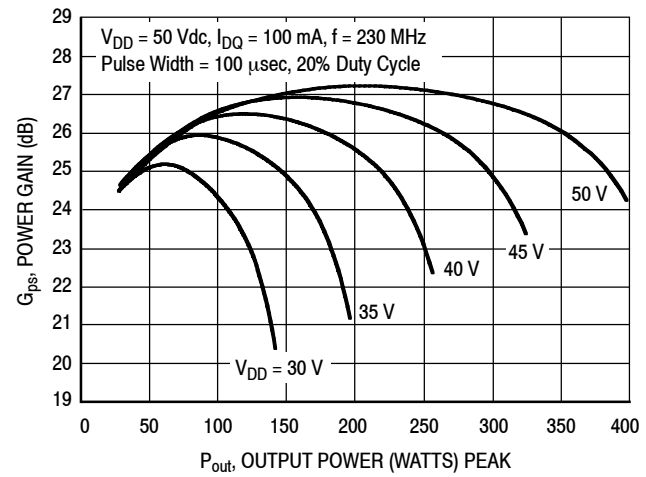

Figure 7. Power Gain versus Output Power

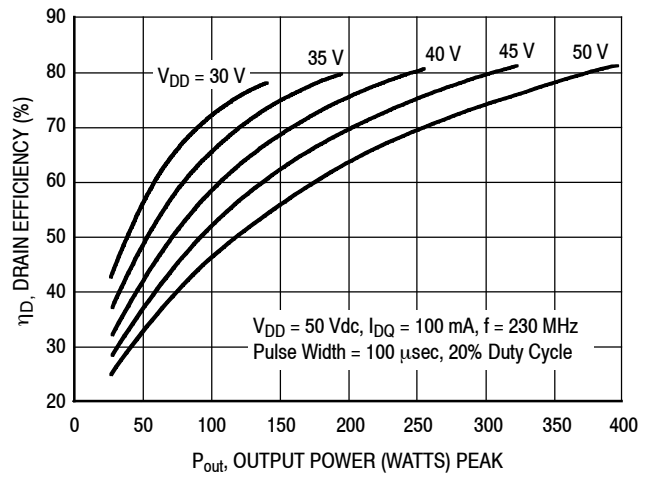

Figure 8. Drain Efficiency versus Output Power

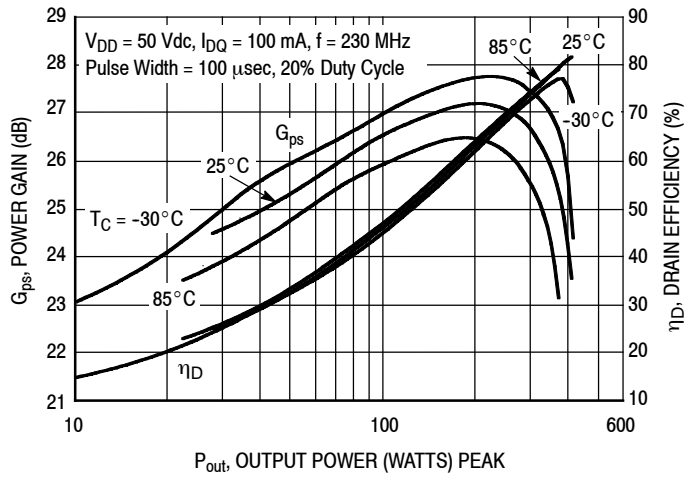

Figure 9. Power Gain and Drain Efficiency versus Output Power

TYPICAL CHARACTERISTICS — TWO-TONE (1)

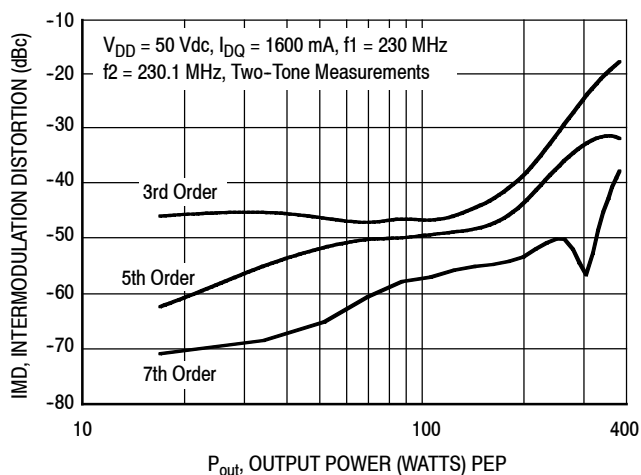

Figure 10. Intermodulation Distortion Products versus Output Power

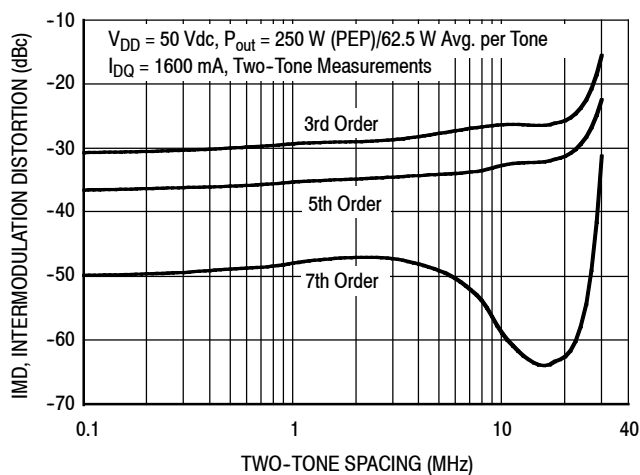

Figure 11. Intermodulation Distortion Products versus Two-Tone Spacing

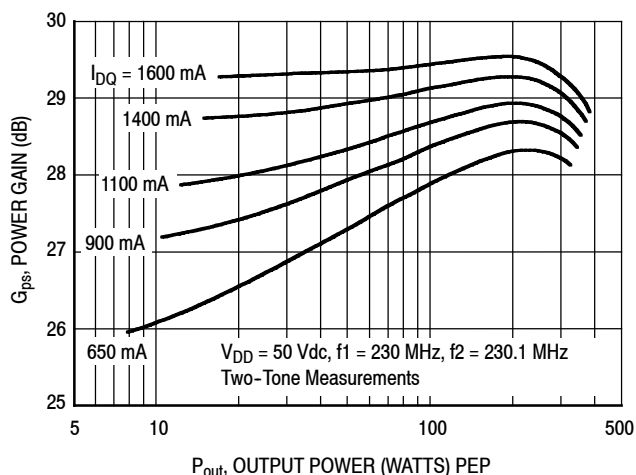

Figure 12. Two-Tone Power Gain versus Output Power

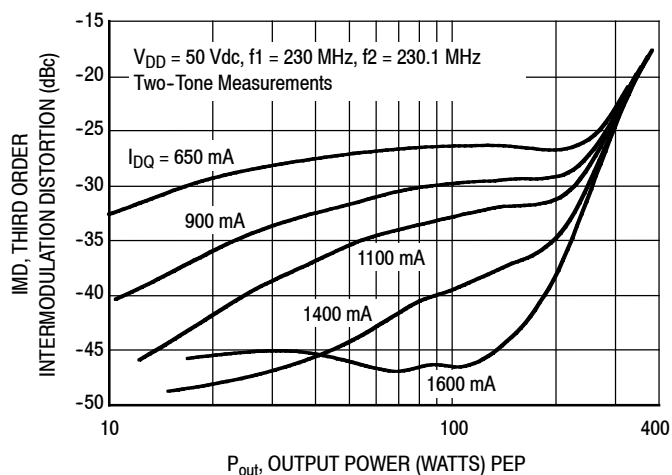
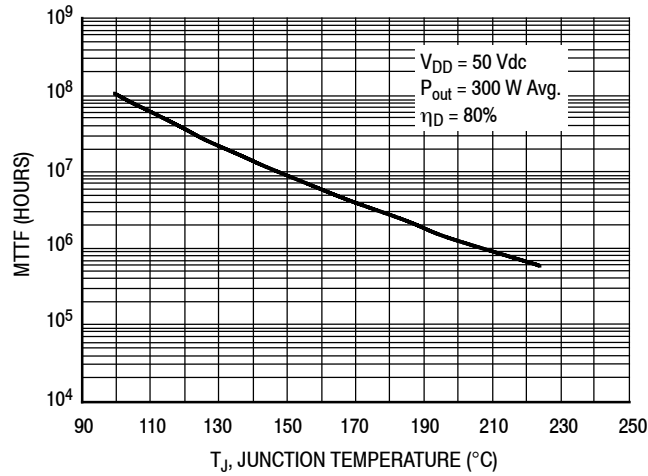

Figure 13. Third Order Intermodulation Distortion versus Output Power

1. The distortion products are referenced to one of the two tones and the peak envelope power (PEP) is 6 dB above the power in a single tone.

TYPICAL CHARACTERISTICS



MTTF calculator available at <http://www.freescale.com/rf>. Select Software & Tools/Development Tools/Calculators to access MTTF calculators by product.

Figure 14. MTTF versus Junction Temperature — CW

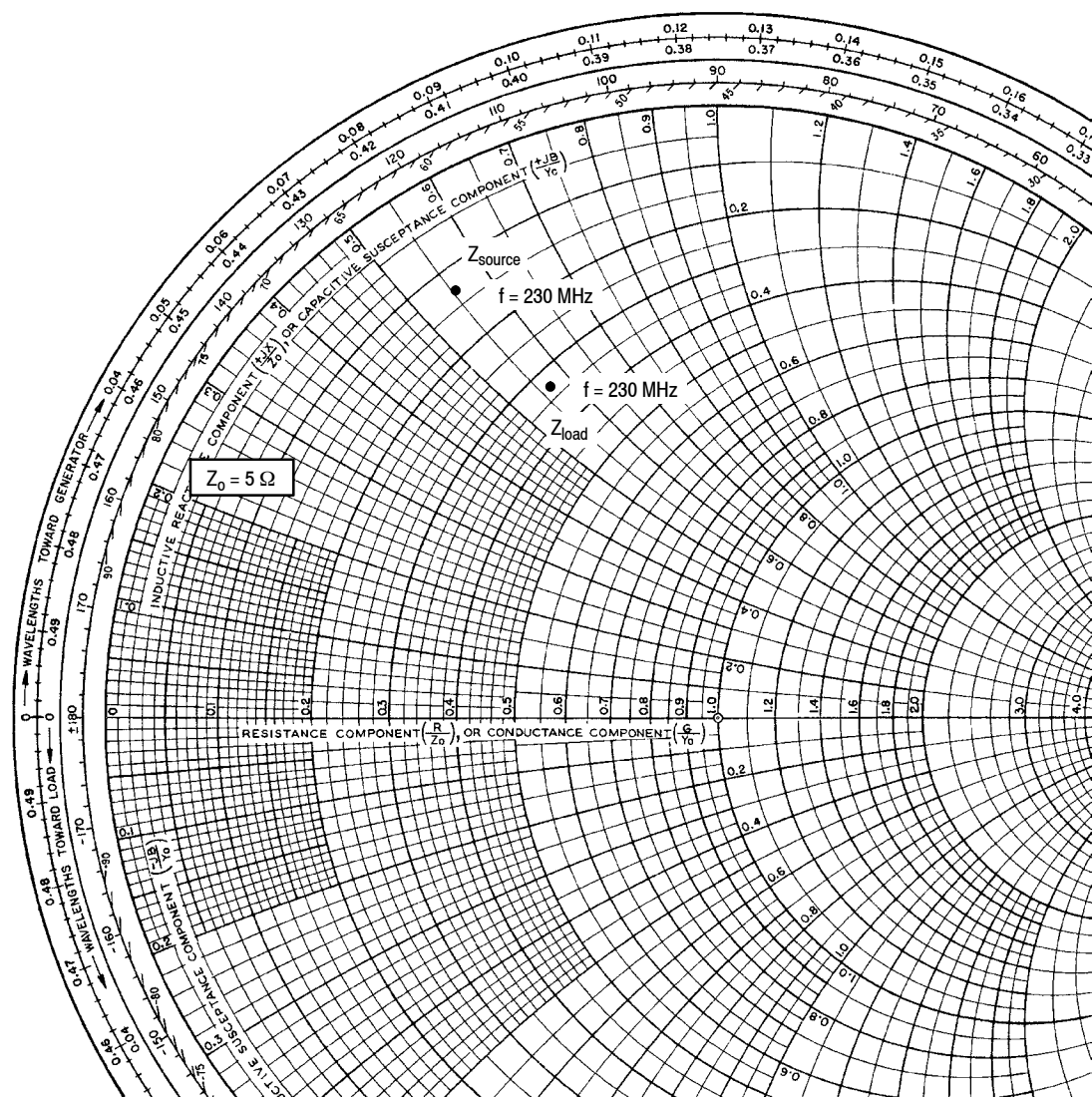

$V_{DD} = 50 \text{ Vdc}$, $I_{DQ} = 100 \text{ mA}$, $P_{out} = 300 \text{ W Peak}$

f MHz	Z_{source} Ω	Z_{load} Ω
230	$0.65 + j2.79$	$1.64 + j2.85$

Z_{source} = Test circuit impedance as measured from gate to ground.

Z_{load} = Test circuit impedance as measured from drain to ground.

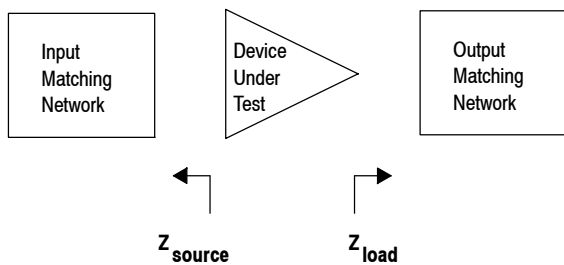

Figure 15. Series Equivalent Source and Load Impedance

$V_{DD} = 50 \text{ Vdc}$, $I_{DQ} = 100 \text{ mA}$

f MHz	Z_{source} Ω	Z_{load} Ω
10	$36.0 + j128$	$12.0 + j8.80$
25	$20.0 + j64.0$	$12.4 + j6.40$
50	$16.0 + j41.6$	$11.6 + j14.4$
100	$8.00 + j24.8$	$9.00 + j9.80$
200	$3.00 + j12.8$	$7.20 + j6.40$
300	$1.52 + j7.92$	$6.00 + j5.00$
400	$1.08 + j5.04$	$4.20 + j4.00$
500	$1.04 + j3.16$	$3.32 + j2.72$
600	$0.88 + j1.76$	$2.72 + j1.68$

1. Simulated performance at 1 dB gain compression.

Z_{source} = Source impedance presented from gate to gate.

Z_{load} = Load impedance presented from drain to drain.

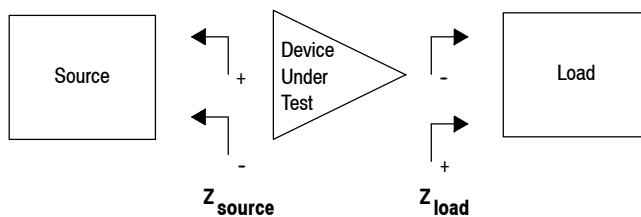
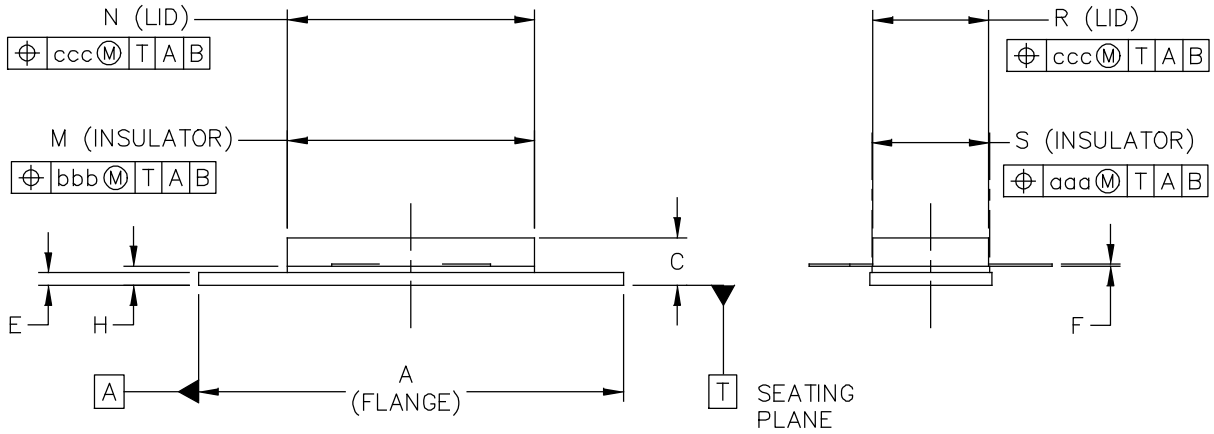
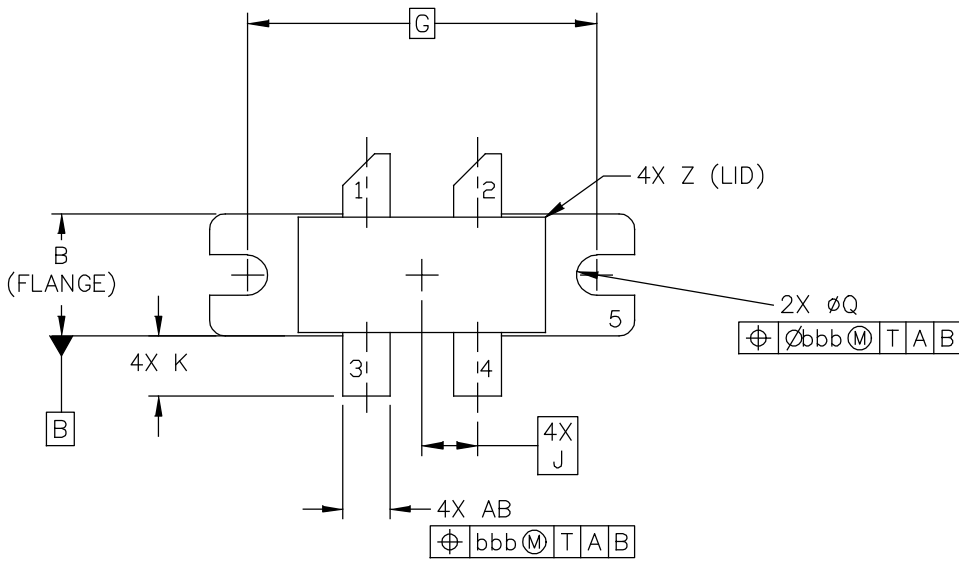

Figure 16. Simulated Source and Load Impedances Optimized for IRL, Output Power and Drain Efficiency — Push-Pull

PACKAGE DIMENSIONS



© FREESCALE SEMICONDUCTOR, INC. ALL RIGHTS RESERVED.	MECHANICAL OUTLINE	PRINT VERSION NOT TO SCALE	
TITLE: NI 780-4	DOCUMENT NO: 98ASA10793D	REV: 0	
	CASE NUMBER: 465M-01	27 MAR 2007	
	STANDARD: NON-JEDEC		

NOTES:

1. DIMENSIONING AND TOLERANCING PER ANSI Y14.5M-1994.
2. CONTROLLING DIMENSION: INCH.
3. DIMENSION H IS MEASURED .030 (0.762) AWAY FROM PACKAGE BODY.

STYLE 1:

- PIN 1. DRAIN
 2. DRAIN
 3. GATE
 4. GATE
 5. SOURCE

DIM	INCH		MILLIMETER		DIM	INCH		MILLIMETER	
	MIN	MAX	MIN	MAX		MIN	MAX	MIN	MAX
A	1.335	1.345	33.91	34.16	R	.365	.375	9.27	9.53
B	.380	.390	9.65	9.91	S	.365	.375	9.27	9.52
C	.125	.170	3.18	4.32	U		.040		1.02
E	.035	.045	0.89	1.14	Z		.030		0.76
F	.003	.006	0.08	0.15	AB	.145	.155	3.68	3.94
G	1.100 BSC		27.94 BSC						
H	.057	.067	1.45	1.7	aaa		.005		0.127
J	.175 BSC		4.44 BSC		bbb		.010		0.254
K	.170	.210	4.32	5.33	ccc		.015		0.381
M	.774	.786	19.61	20.02					
N	.772	.788	19.61	20.02					
Q	ø.118	ø.138	ø3	ø3.51					
© FREESCALE SEMICONDUCTOR, INC. ALL RIGHTS RESERVED.			MECHANICAL OUTLINE			PRINT VERSION NOT TO SCALE			
TITLE: NI 780-4					DOCUMENT NO: 98ASA10793D			REV: 0	
					CASE NUMBER: 465M-01			27 MAR 2007	
					STANDARD: NON-JEDEC				

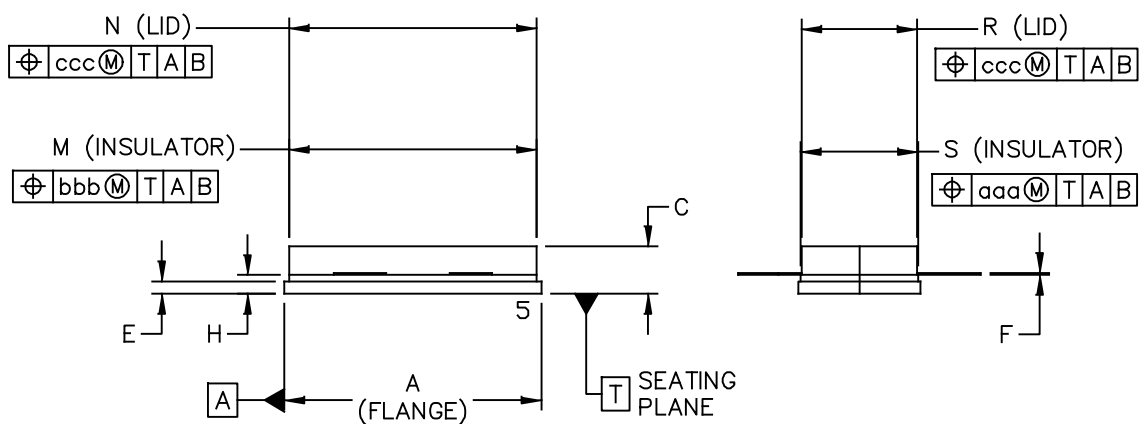
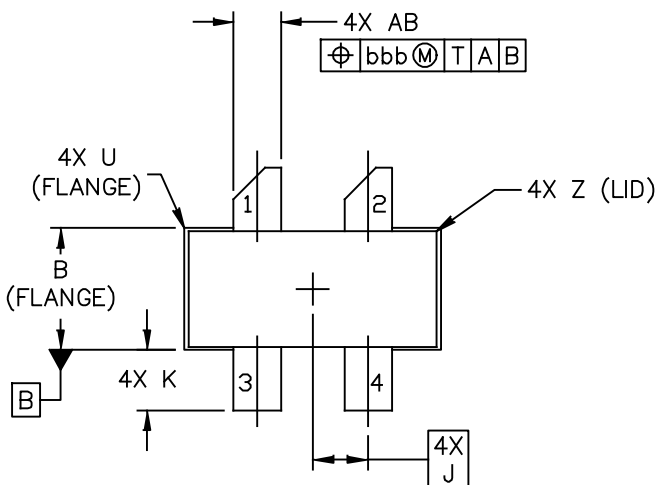

© FREESCALE SEMICONDUCTOR, INC. ALL RIGHTS RESERVED.	MECHANICAL OUTLINE	PRINT VERSION NOT TO SCALE	
TITLE: NI 780S-4	DOCUMENT NO: 98ASA10718D	REV: A	
	CASE NUMBER: 465H-02	27 MAR 2007	
	STANDARD: NON-JEDEC		

NOTES:

1. DIMENSIONING AND TOLERANCING PER ANSI Y14.5M-1994.
2. CONTROLLING DIMENSION: INCH.
3. DELETED
4. DIMENSION H IS MEASURED .030 (0.762) AWAY FROM PACKAGE BODY.

STYLE 1:

- PIN 1. DRAIN
- 2. DRAIN
- 3. GATE
- 4. GATE
- 5. SOURCE

DIM	INCH		MILLIMETER		DIM	INCH		MILLIMETER	
	MIN	MAX	MIN	MAX		MIN	MAX	MIN	MAX
A	.805	.815	20.45	20.7	U		.040		1.02
B	.380	.390	9.65	9.91	Z		.030		0.76
C	.125	.170	3.18	4.32	AB	.145	.155	3.68	– 3.94
E	.035	.045	0.89	1.14					
F	.003	.006	0.08	0.15	aaa		.005		0.127
H	.057	.067	1.45	1.7	bbb		.010		0.254
J	.175 BSC		4.44 BSC		ccc		.015		0.381
K	.170	.210	4.32	5.33					
M	.774	.786	19.61	20.02					
N	.772	.788	19.61	20.02					
R	.365	.375	9.27	9.53					
S	.365	.375	9.27	9.52					
© FREESCALE SEMICONDUCTOR, INC. ALL RIGHTS RESERVED.			MECHANICAL OUTLINE			PRINT VERSION NOT TO SCALE			
TITLE: NI 780S-4					DOCUMENT NO: 98ASA10718D			REV: A	
					CASE NUMBER: 465H-02			27 MAR 2007	
					STANDARD: NON-JEDEC				

PRODUCT DOCUMENTATION AND SOFTWARE

Refer to the following resources to aid your design process.

Application Notes

- AN1955: Thermal Measurement Methodology of RF Power Amplifiers

Engineering Bulletins

- EB212: Using Data Sheet Impedances for RF LDMOS Devices

Software

- Electromigration MTTF Calculator

For Software, do a Part Number search at <http://www.freescale.com>, and select the “Part Number” link. Go to the Software & Tools tab on the part’s Product Summary page to download the respective tool.

REVISION HISTORY

The following table summarizes revisions to this document.

Revision	Date	Description
0	July 2014	• Initial Release of Data Sheet

How to Reach Us:

Home Page:
freescale.com

Web Support:
freescale.com/support

Information in this document is provided solely to enable system and software implementers to use Freescale products. There are no express or implied copyright licenses granted hereunder to design or fabricate any integrated circuits based on the information in this document.

Freescale reserves the right to make changes without further notice to any products herein. Freescale makes no warranty, representation, or guarantee regarding the suitability of its products for any particular purpose, nor does Freescale assume any liability arising out of the application or use of any product or circuit, and specifically disclaims any and all liability, including without limitation consequential or incidental damages. "Typical" parameters that may be provided in Freescale data sheets and/or specifications can and do vary in different applications, and actual performance may vary over time. All operating parameters, including "typicals," must be validated for each customer application by customer's technical experts. Freescale does not convey any license under its patent rights nor the rights of others. Freescale sells products pursuant to standard terms and conditions of sale, which can be found at the following address: freescale.com/SalesTermsandConditions.

Freescale and the Freescale logo are trademarks of Freescale Semiconductor, Inc., Reg. U.S. Pat. & Tm. Off. All other product or service names are the property of their respective owners.

© 2014 Freescale Semiconductor, Inc.

Компания «Океан Электроники» предлагает заключение долгосрочных отношений при поставках импортных электронных компонентов на взаимовыгодных условиях!

Наши преимущества:

- Поставка оригинальных импортных электронных компонентов напрямую с производств Америки, Европы и Азии, а так же с крупнейших складов мира;
- Широкая линейка поставок активных и пассивных импортных электронных компонентов (более 30 млн. наименований);
- Поставка сложных, дефицитных, либо снятых с производства позиций;
- Оперативные сроки поставки под заказ (от 5 рабочих дней);
- Экспресс доставка в любую точку России;
- Помощь Конструкторского Отдела и консультации квалифицированных инженеров;
- Техническая поддержка проекта, помощь в подборе аналогов, поставка прототипов;
- Поставка электронных компонентов под контролем ВП;
- Система менеджмента качества сертифицирована по Международному стандарту ISO 9001;
- При необходимости вся продукция военного и аэрокосмического назначения проходит испытания и сертификацию в лаборатории (по согласованию с заказчиком);
- Поставка специализированных компонентов военного и аэрокосмического уровня качества (Xilinx, Altera, Analog Devices, Intersil, Interpoint, Microsemi, Actel, Aeroflex, Peregrine, VPT, Syfer, Eurofarad, Texas Instruments, MS Kennedy, Miteq, Cobham, E2V, MA-COM, Hittite, Mini-Circuits, General Dynamics и др.);

Компания «Океан Электроники» является официальным дистрибьютором и эксклюзивным представителем в России одного из крупнейших производителей разъемов военного и аэрокосмического назначения «JONHON», а так же официальным дистрибьютором и эксклюзивным представителем в России производителя высокотехнологичных и надежных решений для передачи СВЧ сигналов «FORSTAR».



JONHON

«JONHON» (основан в 1970 г.)

Разъемы специального, военного и аэрокосмического назначения:

(Применяются в военной, авиационной, аэрокосмической, морской, железнодорожной, горно- и нефтедобывающей отраслях промышленности)

«FORSTAR» (основан в 1998 г.)

ВЧ соединители, коаксиальные кабели, кабельные сборки и микроволновые компоненты:

(Применяются в телекоммуникациях гражданского и специального назначения, в средствах связи, РЛС, а так же военной, авиационной и аэрокосмической отраслях промышленности).



Телефон: 8 (812) 309-75-97 (многоканальный)

Факс: 8 (812) 320-03-32

Электронная почта: ocean@oceanchips.ru

Web: <http://oceanchips.ru/>

Адрес: 198099, г. Санкт-Петербург, ул. Калинина, д. 2, корп. 4, лит. А