

Generation 1

HortiLum COB LED Series

COB Arrays Optimized for Plant Growth

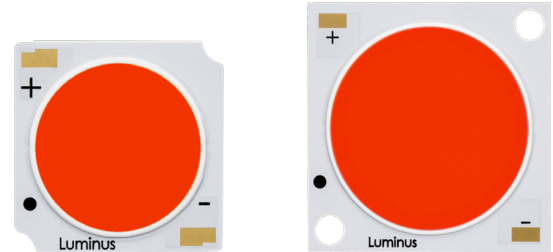

Table of Contents

Technology Overview2

Test Specifications2

Product Ordering & Shipping
Part Numbers3

Product Typical PPF Range. 4

Operating Characteristics ..5

Optical and Electrical Charac-
teristics7

Spectra9

Mechanical Dimensions .. 10

Packaging Information ... 10

Handing notes 12

Features:

- Optimized spectrum for maximum Photosynthetic Photon Flux (PPF)
- Cost-effective HPS lamp replacement
- Industry-leading PPF/W leveraging Luminus Generation 3 COB series for Illumination
- 10,000 hours $L_{90}B_{50}$ at $T_c=105^{\circ}C$ and maximum drive current operation
- Available in 14mm and 22mm Light Emitting Surface (LES) with input power from 25W to 100W
- Excellent optical emission uniformity and color over angle consistency
- Exceptional long term color stability
- Package thermal conductivity better than the industry average
- Environmentally friendly: RoHS and REACH compliant
- UL Recognized, File # E465703



Applications

- Greenhouse Lighting
- Indoor/Outdoor Lighting
- HPS Lamp replacement

Technology Overview

Luminus Chip-on-Board (COB) LED series offers a complete HortiLum COB lighting class solution designed for high performance illumination applications. The HortiLum COB LED series has been specially design for optimized plant growth where enhanced red and blue coloring delivers the highest PPF values available. The selection covers a wide PPF range from less than 45 μ mol/s for a 14mm LES light source to over 100 μ mol/s for a 22mm LES. These breakthroughs allow HortiLum COB engineers and designers to deliver maximum PPF lit spaces without sacrificing efficacy, brightness and overall quality.

Reliability

Designed from the ground up, the Luminus COB LED is one of the most reliable light sources in the world today. Having passed a rigorous suite of environmental and mechanical stress tests, including mechanical shock, vibration, temperature cycling and humidity. Only then are the devices qualified for use in a wide range of lighting application including some of the most demanding commercial applications. Luminus COB LEDs are ready for the toughest challenges.

UL Recognized Compliance

Luminus COB arrays are tested in accordance with ANSI/UL 8750 to ensure safe operation for their intended applications.

REACH & RoHS Compliance

All LED products manufactured by Luminus are REACH and RoHS compliant and free of hazardous materials, including lead and mercury.

Understanding Luminus COB LED Test Specifications

Every Luminus LED is fully tested to ensure it meets the high quality standards customers have come to expect from Luminus' products.

Traceability

Each Luminus COB LED is marked with a 2D bar code that contains a unique serial number. With this serial number, Luminus has the ability to provide customers with actual test data measurements for a specific LED. In addition, the 2D bar code is linked to manufacturing date codes that enables traceability of production processes and materials.

Testing Temperature

Luminus COB products are measured at temperatures typical for the LED operating in the fixture. Each device is tested at 85°C junction temperature eliminating the need to scale data sheet specifications to real world situations.

Product Ordering and Shipping Part Number Nomenclature

All HortiLum COB LED products are packaged and labeled with part numbers as outlined in the table on page 4. When shipped, each package will contain only a single PPF bin. The part number designation is as follows:

CXM — **XX** — **H<P>** — **YY** — **ZZ** — **QQPP**

Product Family	Light Emitting Surface Diameter ¹	Product Type ²	Spectrum Type ³	Voltage (typical)	Package Configurator ⁴
CLM/CXM: Chip on Board	XX: LES Approximate Diameter (mm)	H: HortiLum Horticulture series P : phosphor type: S: Single M: Multiple	YY	36: 36V 54: 54V	AC30 (Basic package)

Note 1: *XX nomenclature corresponds to the following:*

14 = 14.3 mm

22 = 22 mm

Note 2: *Product Type Nomenclature corresponds to the following*

HS: Horticulture Single Phosphor

HM: Horticulture Multiple Phosphor

Note 3: *YY Spectrum Type Nomenclature corresponds to the following*

11 corresponds to a phosphor-converted Deep Red spectrum with 1:1 Blue: Deep Red intensity ratio

12 corresponds to a phosphor-converted Deep Red spectrum with 1:2 Blue: Deep Red intensity ratio

Other spectrum types to be released in the future

Note 4: *AC30 is the Standard package configurator*

Note: Luminus part numbers may be accompanied by prefixes or suffixes. The most common is the "Rev01" suffix indicating a part is fully released and carries a full warranty. These additional characters may appear on shipping labels, packing slips and invoices. In all cases the basic part number described above will always be included.

HortiLum COB LED Series Part Numbers

The following tables describe products with typical PPF and minimum PPF measured at typical currents and specified at 85°C. All products are measured and specified at 85°C junction temperature.

Output PPF ($\mu\text{mol/s}$)		LES Diameter (mm)	Typ. Current (mA)	Ordering Part Number
Typ. (85°C)	Min. (85°C)			
45	41	14.3	720	CXM-14-HS-11-36-AC30
43	39			CXM-14-HS-12-36-AC30
73	66	22	1,100	CLM-22-HS-11-36-AC30
68	62			CLM-22-HS-12-36-AC30
105	95	22	1,100	CXM-22-HS-11-54-AC30
98	89			CXM-22-HS-12-54-AC30

*Note: Luminus maintains a +/- 6% tolerance on PPF measurements.

CXM-14 Operating Characteristics¹
Optical and Electrical Characteristics

Parameter	Symbol	Minimum	Typical	Maximum	Unit
Forward Current ²	I_f		720	1,440	mA
Forward Voltage ³	V_f	31	34	37	V
Power			24.5	54	W
Operating Case Temperature	T_c			105	°C
Light Emitting Surface Diameter	LES		14.3		mm
Thermal Resistance (junction-to-case)	Θ_{jc}		0.27		°C/W
Junction Temperature	T_j			140	°C
Viewing Angle			120		Degree

CLM-22 Operating Characteristics¹
Optical and Electrical Characteristics

Parameter	Symbol	Minimum	Typical	Maximum	Unit
Forward Current ²	I_f		1,100	2,200	mA
Forward Voltage ³	V_f	31	34.7	38	V
Power			38	82	W
Operating Case Temperature	T_c			105	°C
Light Emitting Surface Diameter	LES		22		mm
Thermal Resistance (junction-to-case)	Θ_{jc}		0.19		°C/W
Junction Temperature	T_j			140	°C
Viewing Angle			120		Degree

CXM-22 Operating Characteristics¹
Optical and Electrical Characteristics

Parameter	Symbol	Minimum	Typical	Maximum	Unit
Forward Current ²	I_f		1,100	2,200	mA
Forward Voltage ³	V_f	48	51.5	55	V
Power			56	125	W
Operating Case Temperature	T_c			105	°C
Light Emitting Surface Diameter	LES		22		mm
Thermal Resistance (junction-to-case)	Θ_{jc}		0.17		°C/W
Junction Temperature	T_j			140	°C
Viewing Angle			120		Degree

Operating Characteristics Notes

Note 1: Ratings are based on operation at a constant junction temperature $T_j = 85^\circ\text{C}$.

Note 2: To prevent damage refer to operating conditions and derating curves for appropriate maximum operating conditions

Note 3: Forward voltage is rated at typical forward current. For voltage at different forward currents, refer to the voltage versus current performance graphs.

Note 4: COB LEDs are designed for operation to a minimum of 20% of the typical forward current value. Operation at currents lower than this value will not harm the device but may result in uneven light emission across the LES surface.

Note 5: Luminus may change any specifications without prior notice. Please refer to the company web site for the latest data sheet revision

Note 6: Caution must be taken not to stare at the light emitted from these LEDs. Under special circumstances, the high intensity could damage the eye.

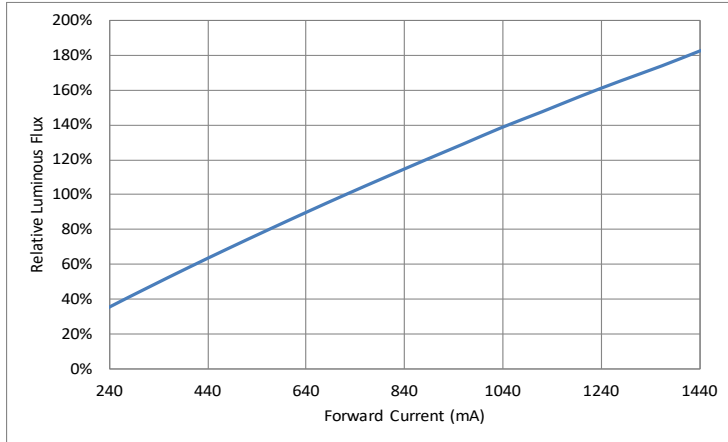
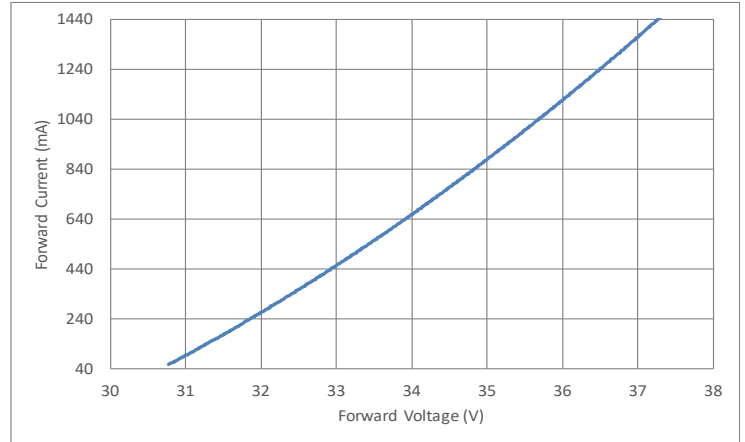
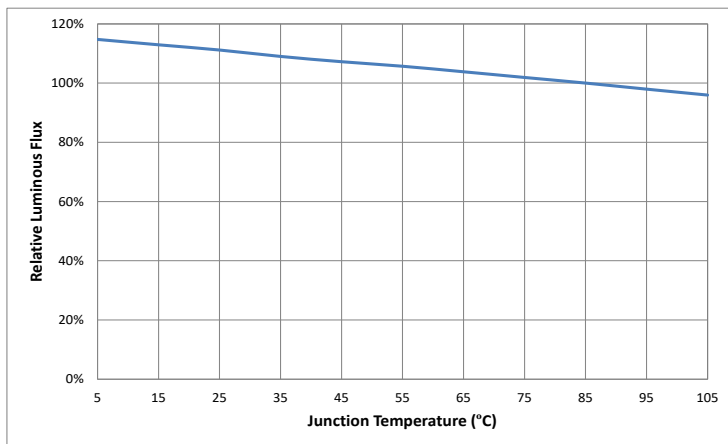
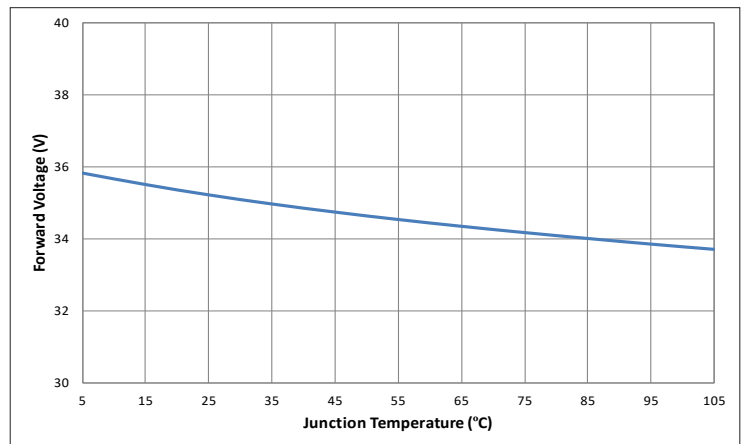
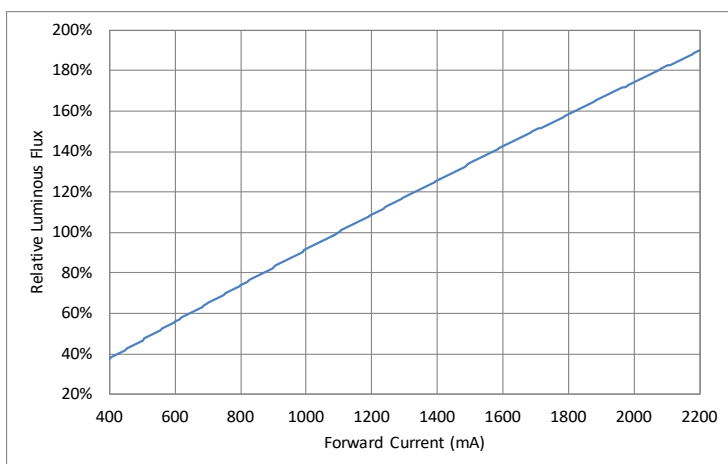
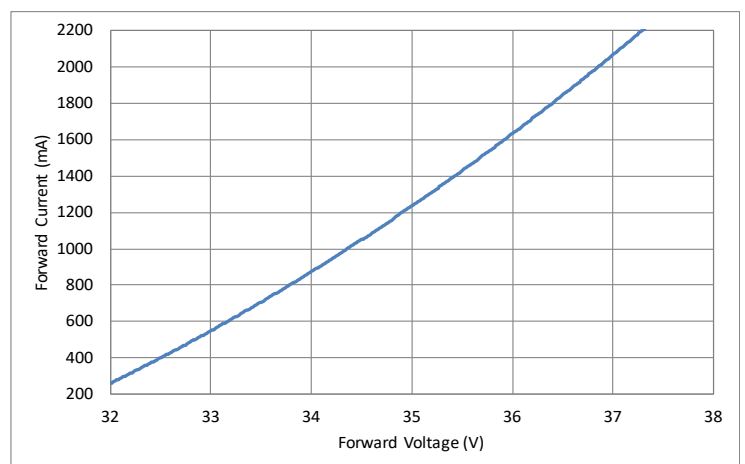
CXM-14 Optical & Electrical Characteristics
Relative Output Flux vs. Forward Current @ 85°C

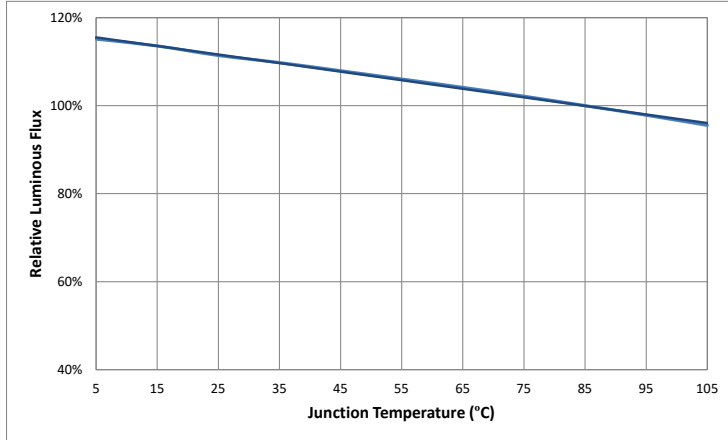
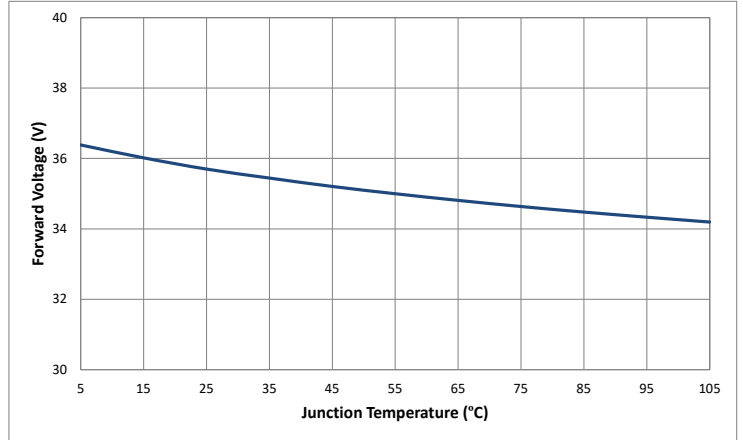
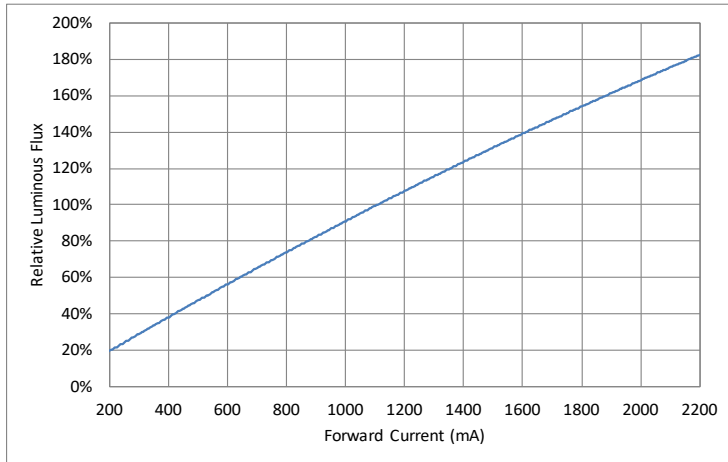
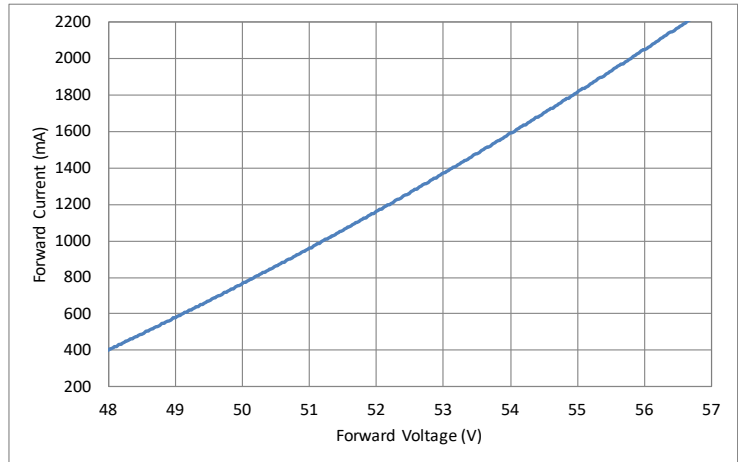
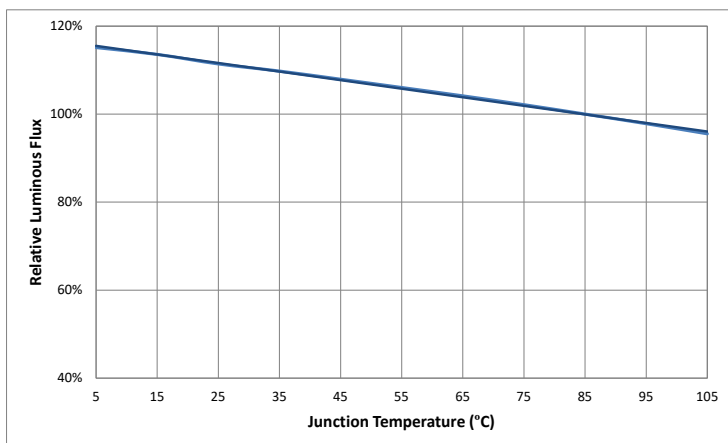
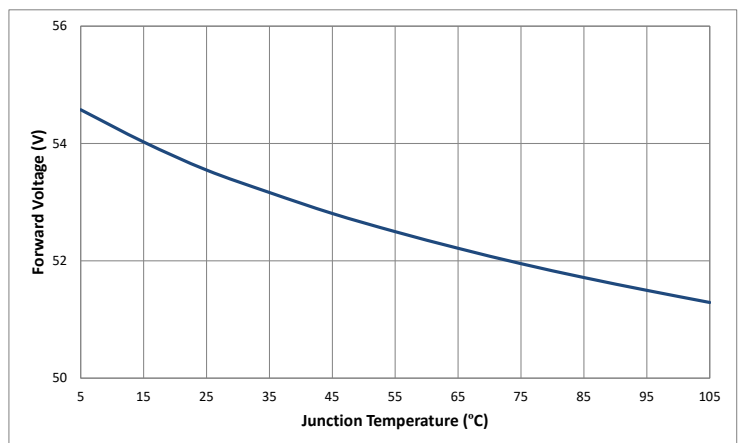
Forward Current vs. Forward Voltage @ 85°C

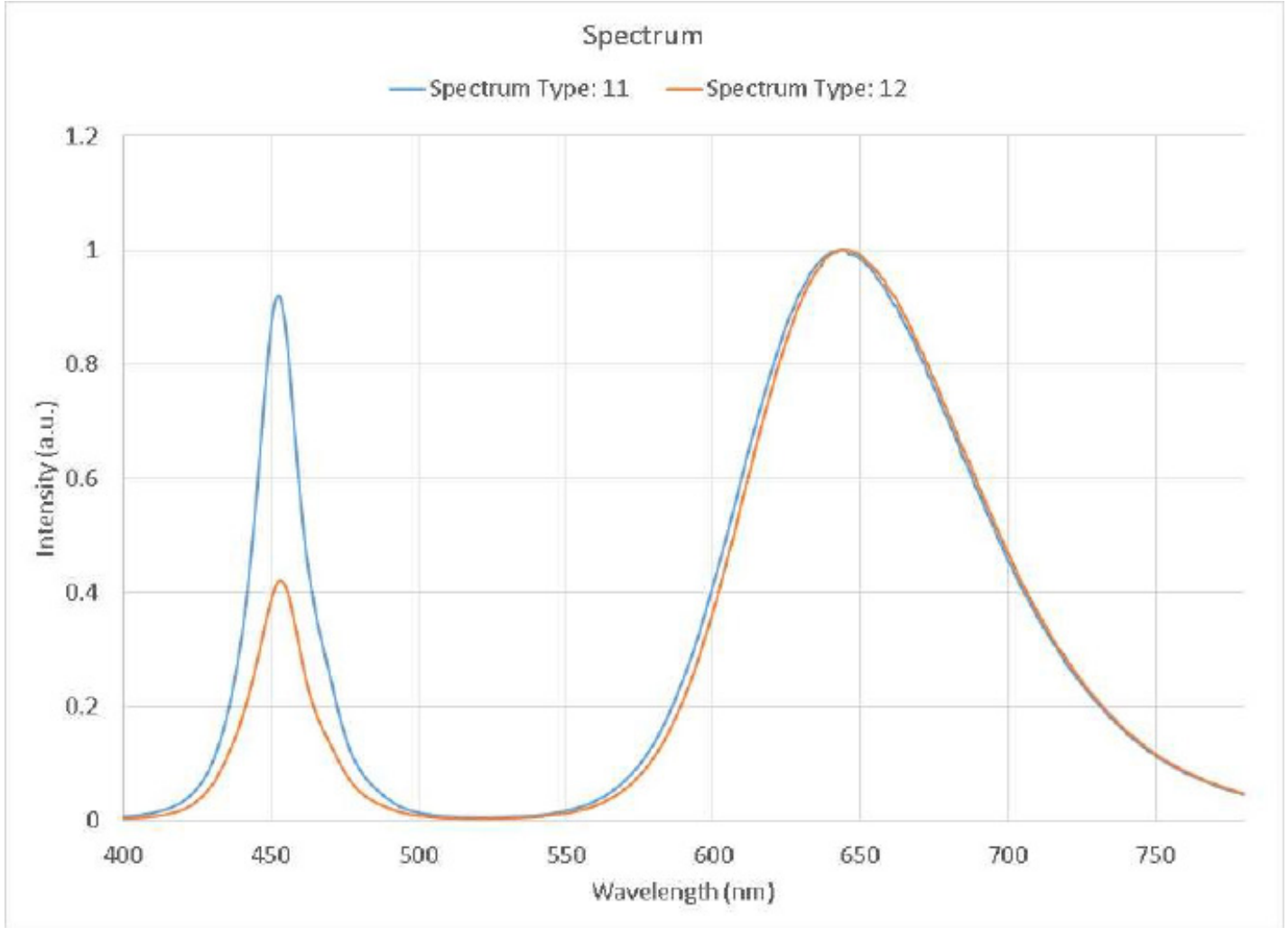
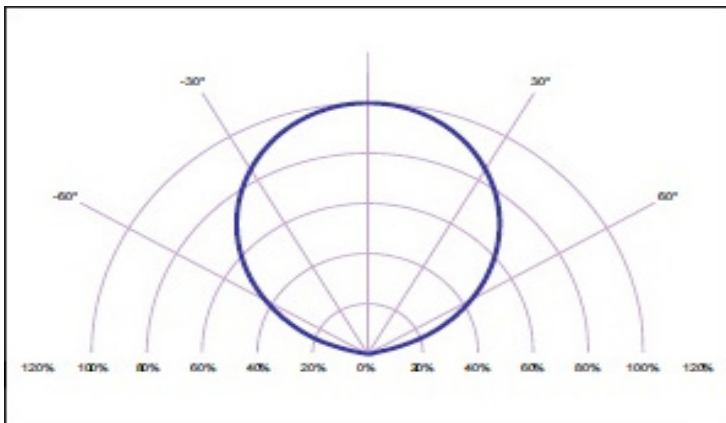
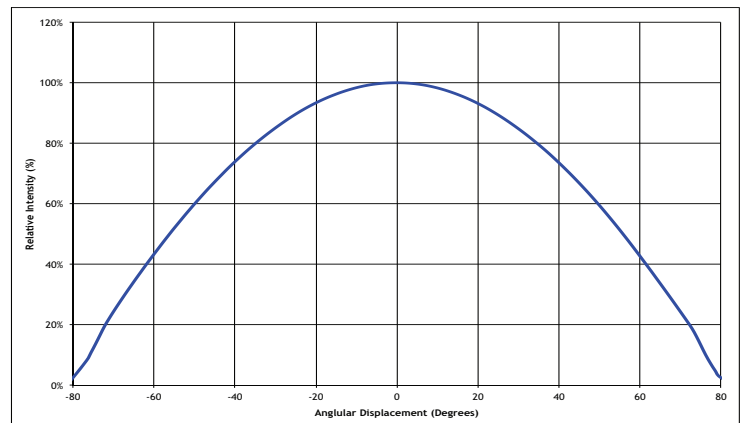
Relative Output Flux vs. Junction Temperature

Change in Voltage vs. Junction Temperature

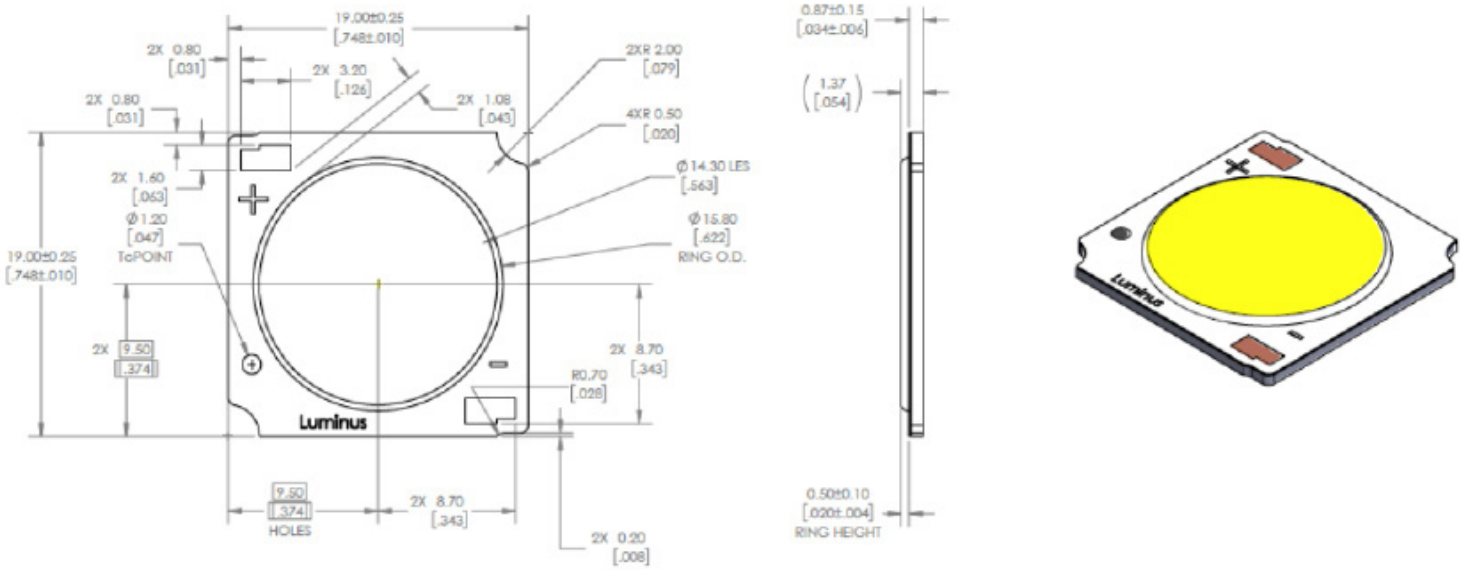
CLM-22 Optical & Electrical Characteristics
Relative Output Flux vs. Forward Current @ 85°C

Forward Current vs. Forward Voltage @ 85°C

CLM-22 Optical & Electrical Characteristics
Relative Output Flux vs. Junction Temperature

Change in Voltage vs. Junction Temperature

CXM-22 Optical & Electrical Characteristics
Relative Output Flux vs. Forward Current @ 85°C

Forward Current vs. Forward Voltage @ 85°C

Relative Output Flux vs. Junction Temperature

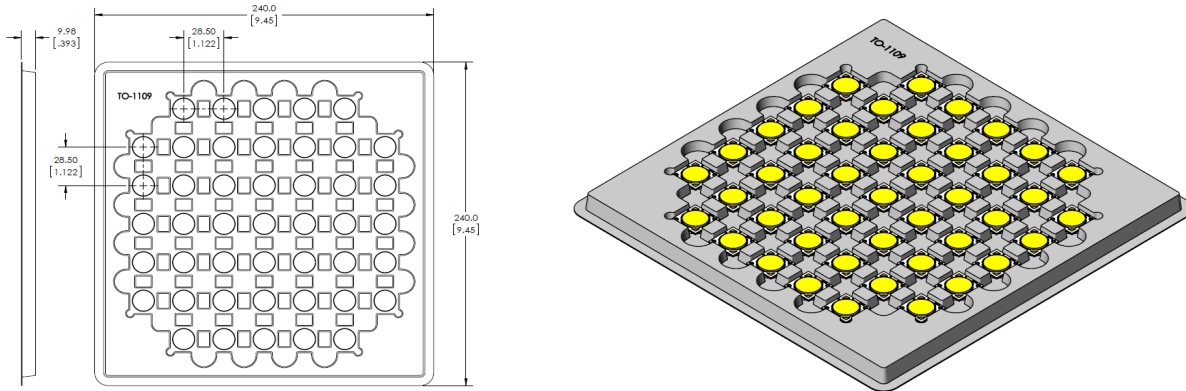
Change in Voltage vs. Junction Temperature

Optical & Electrical Characteristics
Typical Spectrum

Typical Polar Radiation Pattern

Typical Angular Radiation Pattern

Mechanical Dimensions (CXM-14 AC)



Shipping Container (CXM-14)



225 pcs per box
Each bag is boxed for easier storage/ stacking

Trays are sealed in an anti-static bag

45 pcs per tray
5 trays are stacked together with separate cover

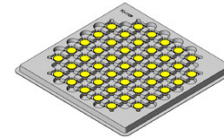
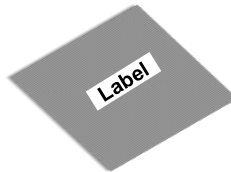

Luminus Label Model:

	LUMINUS	Luminus Devices Inc	
XXXXXX-XX-XX (Manufacturer Part Number & Bin Kits)	Rev XX		RoHS Compliant
Bar code	Bar code		
XXX-XX-XX-XX-XX-XXXX-XX-X (Customer Part Number)			
XXXXXXXXXXXXXXXX (Box ID)	Qty: XX		
Bar code	Bar code		

Mechanical Dimensions (CLM/CXM-22)

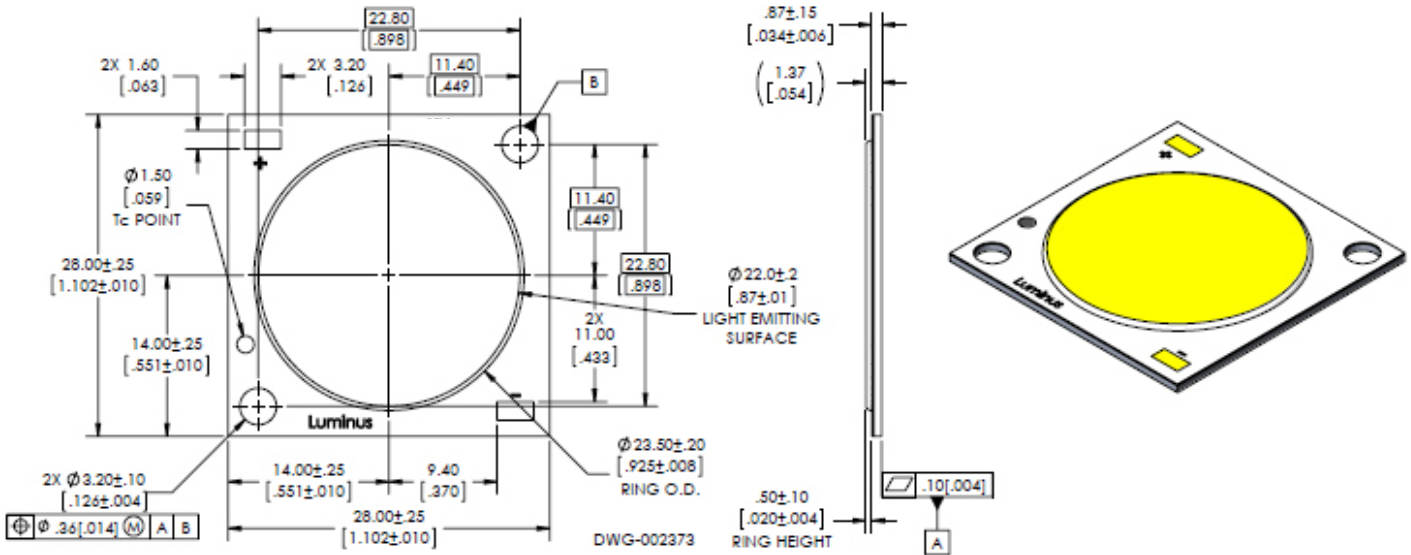

Shipping Container (CLM/CXM-22)

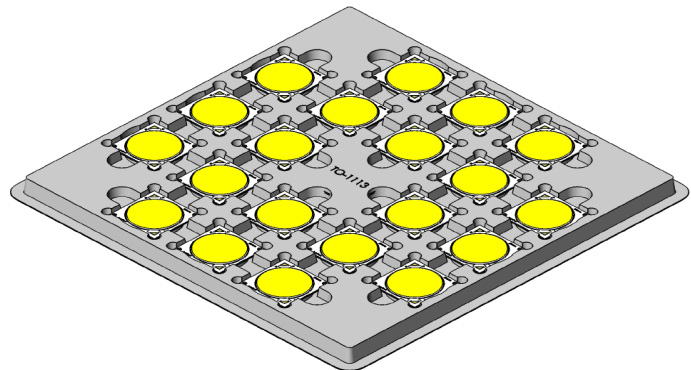
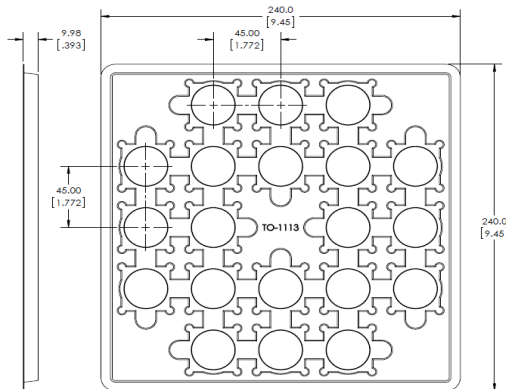

100 pcs per box
Each bag is boxed for easier storage/ stacking

Trays are sealed in an anti-static bag

20 pcs per tray
5 trays are stacked together with separate cover

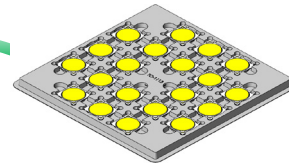
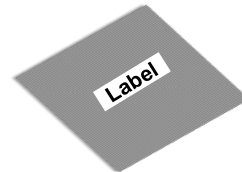

Luminus Label Model:

	Luminus Devices Inc	RoHS Compliant
XXXXXX-XX-XX (Manufacturer Part Number & Bin Kits)	Rev XX	
Bar code	Bar code	
XXX-XX-XX-XX-XX-XXXX-XX-X (Customer Part Number)	Qty: XX	
XXXXXXXXXXXXXXXX (Box ID)	Bar code	

Handling Notes for Luminus COBs

Luminus products are designed for robust performance in general lighting application. However, care must be taken when handling and assembling the LEDs into their fixtures. To avoid damaging Luminus COBs please follow these guide lines.

The following is an overview of the application notes detailing some of the practices to follow when working with these devices. More detailed information is available on the Luminus web site at www.luminus.com.

General Handling

Devices are made to be lifted or carried with tweezers on two adjacent corners opposite the contact pads. At no time should the devices be handled by or should anything come in contact with the light emitting surface (LES) area. This area includes the yellow colored circular area and the ring surrounding it. There are electrical connections under the LES which if damaged will cause the device to fail.

In addition, the ring frame itself should not be used for moving, lifting or carrying the device. Also do not attach any optics or mechanical holders to the ring as it is not capable to handle the mechanical stress.

Static Electricity

Luminus COBs are electronic devices which can be damaged by electrostatic discharge (ESD). Please use appropriate measures to assure the devices do not experience ESD during their handling and or storage. ESD protection guidelines should be used at all times when working with Luminus COBs.

Storage: Luminus products are delivered in ESD shielded bags and should be stored in these bags until used.

Assembly: Individuals handling Luminus COBs during assembly should be trained in ESD protection practices. Assemblers should maintain constant conductive contact with a path to ground by means of a wrist strap, ankle straps, mat or other ESD protection system.

Transporting: When transporting the devices from one assembly area to another, ESD shielded carts and carriers should be used.

Electrical Contact

Luminus COBs are designed with contact pads on their top surface. These pads are clearly marked with + and – polarity. Wires can be soldered to the contact pads for electrical connections or other solderless connector products are available.

If wires are being soldered to the COB product, we recommend attaching these wires prior to mounting the devices to a heat sink. Please contact Luminus for specific recommendations on how to solder wires if not familiar with the standard practice. Luminus can also offer design recommendations for jigs to allow easily soldering multiple products in rapid succession.

Chemical Compatibility

The resin material used to form the LES can get hydrocarbons from the surrounding environment. As a result, certain chemical compounds are not recommended for use with the Luminus products. Use of these compounds can cause damage to the light output of the device and may permanently damage the device. Please refer to www.luminus.com for a list of the compounds not recommended for use with the Luminus COB products.

Thermal Interface Material (TIM)

Proper thermal management is critical for successful operation of any LED system. Excess operating temperature can reduce the light output of the device. And excessive heating can cause permanent damage to the device. Proper TIM material is a crucial component for effective heat transfer away from the LED during normal operation. Please refer to www.luminus.com for specific recommendations for TIM solutions.

Компания «Океан Электроники» предлагает заключение долгосрочных отношений при поставках импортных электронных компонентов на взаимовыгодных условиях!

Наши преимущества:

- Поставка оригинальных импортных электронных компонентов напрямую с производств Америки, Европы и Азии, а так же с крупнейших складов мира;
- Широкая линейка поставок активных и пассивных импортных электронных компонентов (более 30 млн. наименований);
- Поставка сложных, дефицитных, либо снятых с производства позиций;
- Оперативные сроки поставки под заказ (от 5 рабочих дней);
- Экспресс доставка в любую точку России;
- Помощь Конструкторского Отдела и консультации квалифицированных инженеров;
- Техническая поддержка проекта, помощь в подборе аналогов, поставка прототипов;
- Поставка электронных компонентов под контролем ВП;
- Система менеджмента качества сертифицирована по Международному стандарту ISO 9001;
- При необходимости вся продукция военного и аэрокосмического назначения проходит испытания и сертификацию в лаборатории (по согласованию с заказчиком);
- Поставка специализированных компонентов военного и аэрокосмического уровня качества (Xilinx, Altera, Analog Devices, Intersil, Interpoint, Microsemi, Actel, Aeroflex, Peregrine, VPT, Syfer, Eurofarad, Texas Instruments, MS Kennedy, Miteq, Cobham, E2V, MA-COM, Hittite, Mini-Circuits, General Dynamics и др.);

Компания «Океан Электроники» является официальным дистрибьютором и эксклюзивным представителем в России одного из крупнейших производителей разъемов военного и аэрокосмического назначения «JONHON», а так же официальным дистрибьютором и эксклюзивным представителем в России производителя высокотехнологичных и надежных решений для передачи СВЧ сигналов «FORSTAR».



JONHON

«JONHON» (основан в 1970 г.)

Разъемы специального, военного и аэрокосмического назначения:

(Применяются в военной, авиационной, аэрокосмической, морской, железнодорожной, горно- и нефтедобывающей отраслях промышленности)

«FORSTAR» (основан в 1998 г.)

ВЧ соединители, коаксиальные кабели, кабельные сборки и микроволновые компоненты:

(Применяются в телекоммуникациях гражданского и специального назначения, в средствах связи, РЛС, а так же военной, авиационной и аэрокосмической отраслях промышленности).



Телефон: 8 (812) 309-75-97 (многоканальный)

Факс: 8 (812) 320-03-32

Электронная почта: ocean@oceanchips.ru

Web: <http://oceanchips.ru/>

Адрес: 198099, г. Санкт-Петербург, ул. Калинина, д. 2, корп. 4, лит. А