

FEATURES

- **80C32-Compatible**
  - 8051 Pin and Instruction Set Compatible
  - Four 8-Bit I/O Ports
  - Three 16-Bit Timer/Counters
  - 256 Bytes Scratchpad RAM
  - Addresses 64kB ROM and 64kB RAM
- **High-Speed Architecture**
  - 4 Clocks/Machine Cycle (8032 = 12)
  - DC to 33MHz (DS80C320)
  - DC to 18MHz (DS80C323)
  - Single-Cycle Instruction in 121ns
  - Uses Less Power for Equivalent Work
  - Dual Data Pointer
  - Optional Variable Length MOVX to Access Fast/Slow RAM/Peripherals
- **High-Integration Controller Includes:**
  - Power-Fail Reset
  - Programmable Watchdog Timer
  - Early Warning Power-Fail Interrupt
- **Two Full-Duplex Hardware Serial Ports**
- **13 Total Interrupt Sources with Six External**
- **Available in 40-Pin DIP, 44-Pin PLCC, and 44-Pin TQFP**

The *High-Speed Microcontroller User's Guide* must be used in conjunction with this data sheet. **Download it at:** [www.maxim-ic.com/microcontrollers](http://www.maxim-ic.com/microcontrollers).

Data sheets contain pin descriptions, feature overviews, and electrical specifications, whereas the user's guide contains detailed information about device features and operation.

PIN CONFIGURATIONS



**Note:** Some revisions of this device may incorporate deviations from published specifications known as errata. Multiple revisions of any device may be simultaneously available through various sales channels. For information about device errata, click here: [www.maxim-ic.com/errata](http://www.maxim-ic.com/errata).

## DETAILED DESCRIPTION

The DS80C320/DS80C323 are fast 80C31/80C32-compatible microcontrollers. Wasted clock and memory cycles have been removed using a redesigned processor core. As a result, every 8051 instruction is executed between 1.5 and 3 times faster than the original for the same crystal speed. Typical applications see a speed improvement of 2.5 times using the same code and same crystal. The DS80C320 offers a maximum crystal rate of 33MHz, resulting in apparent execution speeds of 82.5MHz (approximately 2.5X).

The DS80C320/DS80C323 are pin compatible with all three packages of the standard 80C32 and offer the same timer/counters, serial port, and I/O ports. In short, the devices are extremely familiar to 8051 users, but provide the speed of a 16-bit processor.

The DS80C320 provides several extras in addition to greater speed. These include a second full hardware serial port, seven additional interrupts, programmable watchdog timer, power-fail interrupt and reset. The device also provides dual data pointers (DPTRs) to speed block data memory moves. It can also adjust the speed of off-chip data memory access to between two and nine machine cycles for flexibility in selecting memory and peripherals.

The DS80C320 operating voltage ranges from 4.25V to 5.5V, making it ideal as a high-performance upgrade to existing 5V systems. For applications in which power consumption is critical, the DS80C323 offers the same feature set as the DS80C320, but with 2.7V to 5.5V operation.

Designers must have two documents to fully use all the features of this device: this data sheet and the *High-Speed Microcontroller User's Guide*, available on our website at [www.maxim-ic.com/microcontrollers](http://www.maxim-ic.com/microcontrollers). Data sheets contain pin descriptions, feature overviews, and electrical specifications, whereas our user's guides contain detailed information about device features and operation.

## ORDERING INFORMATION

PART	Pb-FREE/RoHS-COMPLIANT	TEMP RANGE	MAX CLOCK SPEED (MHz)	PIN-PACKAGE
DS80C320-MCG	DS80C320-MCG+	0°C to +70°C	25	40 Plastic DIP
DS80C320-QCG	DS80C320-QCG+	0°C to +70°C	25	44 PLCC
DS80C320-ECG	DS80C320-ECG+	0°C to +70°C	25	44 TQFP
DS80C320-MNG	DS80C320-MNG+	-40°C to +85°C	25	40 Plastic DIP
DS80C320-QNG	DS80C320-QNG+	-40°C to +85°C	25	44 PLCC
DS80C320-ENG	DS80C320-ENG+	-40°C to +85°C	25	44 TQFP
DS80C320-MCL	DS80C320-MCL+	0°C to +70°C	33	40 Plastic DIP
DS80C320-QCL	DS80C320-QCL+	0°C to +70°C	33	44 PLCC
DS80C320-ECL	DS80C320-ECL+	0°C to +70°C	33	44 TQFP
DS80C320-MNL	DS80C320-MNL+	-40°C to +85°C	33	40 Plastic DIP
DS80C320-QNL	DS80C320-QNL+	-40°C to +85°C	33	44 PLCC
DS80C320-ENL	DS80C320-ENL+	-40°C to +85°C	33	44 TQFP
DS80C323-MCD	DS80C323-MCD+	0°C to +70°C	18	40 Plastic DIP
DS80C323-QCD	DS80C323-QCD+	0°C to +70°C	18	44 PLCC
DS80C323-ECD	DS80C323-ECD+	0°C to +70°C	18	44 TQFP
DS80C323-QND	DS80C323-QND+	-40°C to +85°C	18	44 PLCC
DS80C323-END	DS80C323-END+	-40°C to +85°C	18	44 TQFP

+ Denotes a lead(Pb)-free/RoHS-compliant device.

Figure 1. Block Diagram



PIN DESCRIPTION

PIN			NAME	FUNCTION
DIP	PLCC	TQFP		
40	44	38	V <sub>CC</sub>	+5V (+3V for DS80C323)
20	22, 23	16, 17	GND	Digital Circuit Ground
9	10	4	RST	<b>Reset Input.</b> The RST input pin contains a Schmitt voltage input to recognize external active-high reset inputs. The pin also employs an internal pulldown resistor to allow for a combination of wired OR external reset sources. An RC is <i>not</i> required for power-up, as the device provides this function internally.
18	20	14	XTAL2	<b>Crystal Oscillator Pins.</b> XTAL1 and XTAL2 provide support for parallel-resonant, AT-cut crystals. XTAL1 acts also as an input in the event that an external clock source is used in place of a crystal. XTAL2 serves as the output of the crystal amplifier.
19	21	15	XTAL1	
29	32	26	$\overline{\text{PSEN}}$	<b>Program Store-Enable Output, Active Low.</b> This signal is commonly connected to external ROM memory as a chip enable. $\overline{\text{PSEN}}$ provides an active-low pulse width of 2.25 XTAL1 cycles with a period of four XTAL1 cycles. $\overline{\text{PSEN}}$ is driven high when data memory (RAM) is being accessed through the bus and during a reset condition.

**PIN DESCRIPTION (continued)**

PIN			NAME	FUNCTION					
DIP	PLCC	TQFP							
30	33	27	ALE	<b>Address Latch-Enable Output.</b> This pin functions as a clock to latch the external address LSB from the multiplexed address/data bus. This signal is commonly connected to the latch enable of an external 373 family transparent latch. ALE has a pulse width of 1.5 XTAL1 cycles and a period of four XTAL1 cycles. ALE is forced high when the device is in a reset condition.					
39	43	37	AD0	<b>Port 0, Input/Output.</b> Port 0 is the multiplexed address/data bus. During the time when ALE is high, the LSB of a memory address is presented. When ALE falls, the port transitions to a bidirectional data bus. This bus is used to read external ROM and read/write external RAM memory or peripherals. The Port 0 has no true port latch and cannot be written directly by software. The reset condition of Port 0 is high. No pullup resistors are needed.					
38	42	36	AD1						
37	41	35	AD2						
36	40	34	AD3						
35	39	33	AD4						
34	38	32	AD5						
33	37	31	AD6						
32	36	30	AD7						
1–8	2–9	40–44, 1–3	P1.0–P1.7	<b>Port 1, I/O.</b> Port 1 functions as both an 8-bit, bidirectional I/O port and an alternate functional interface for Timer 2 I/O, new External Interrupts, and new Serial Port 1. The reset condition of Port 1 is with all bits at logic 1. In this state, a weak pullup holds the port high. This condition also serves as an input mode, since any external circuit that writes to the port will overcome the weak pullup. When software writes a 0 to any port pin, the device will activate a strong pulldown that remains on until either a 1 is written or a reset occurs. Writing a 1 after the port has been at 0 will cause a strong transition driver to turn on, followed by a weaker sustaining pullup. Once the momentary strong driver turns off, the port once again becomes the output high (and input) state. The alternate modes of Port 1 are outlined as follows:					
				PIN			PORT	ALTERNATE	FUNCTION
				DIP	PLCC	TQFP			
				1	2	40	P1.0	T2	External I/O for Timer/Counter 2
				2	3	41	P1.1	T2EX	Timer/Counter 2 Capture/Reload Trigger
				3	4	42	P1.2	RXD1	Serial Port 1 Input
				4	5	43	P1.3	TXD1	Serial Port 1 Output
				5	6	44	P1.4	INT2	External Interrupt 2 (Positive-Edge Detect)
				6	7	1	P1.5	$\overline{\text{INT3}}$	External Interrupt 3 (Negative-Edge Detect)
				7	8	2	P1.6	INT4	External Interrupt 4 (Positive-Edge Detect)
8	9	3	P1.7	$\overline{\text{INT5}}$	External Interrupt 5 (Negative-Edge Detect)				

**PIN DESCRIPTION (continued)**

PIN			NAME	FUNCTION									
DIP	PLCC	TQFP											
21	24	18	A8 (P2.0)	<b>Port 2, Output.</b> Port 2 serves as the MSB for external addressing. P2.7 is A15 and P2.0 is A8. The device will automatically place the MSB of an address on P2 for external ROM and RAM access. Although Port 2 can be accessed like an ordinary I/O port, the value stored on the Port 2 latch will never be seen on the pins (due to memory access). Therefore, writing to Port 2 in software is only useful for the instructions MOVX A, @Ri or MOVX @Ri, A. These instructions use the Port 2 internal latch to supply the external address MSB. In this case, the Port 2 latch value will be supplied as the address information.									
22	25	19	A9 (P2.1)										
23	26	20	A10 (P2.2)										
24	27	21	A11 (P2.3)										
25	28	22	A12 (P2.4)										
26	29	23	A13 (P2.5)										
27	30	24	A14 (P2.6)										
28	31	25	A15 (P2.7)										
10–17	11, 13–19	5, 7–13	P3.0–P3.7	<b>Port 3, Input/Output.</b> Port 3 functions as both an 8-bit, bidirectional I/O port and an alternate functional interface for External Interrupts, Serial Port 0, Timer 0 & 1 Inputs, $\overline{RD}$ and $\overline{WR}$ strobes. The reset condition of Port 3 is with all bits at logic 1. In this state, a weak pullup holds the port high. This condition also serves as an input mode, since any external circuit that writes to the port will overcome the weak pullup. When software writes a 0 to any port pin, the device will activate a strong pulldown that remains on until either a 1 is written or a reset occurs. Writing a 1 after the port has been at 0 will cause a strong transition driver to turn on, followed by a weaker sustaining pullup. Once the momentary strong driver turns off, the port once again becomes both the output high and input state. The alternate modes of Port 3 are outlined below:									
				PIN			PORT	ALTERNATE	MODE				
				DIP	PLCC	TQFP							
								10	11	5	P3.0	RXD0	Serial Port 0 Input
								11	13	7	P3.1	TXD0	Serial Port 0 Output
								12	14	8	P3.2	$\overline{INT0}$	External Interrupt 0
								13	15	9	P3.3	$\overline{INT1}$	External Interrupt 1
								14	16	10	P3.4	T0	Timer 0 External Input
								15	17	11	P3.5	T1	Timer 1 External Input
								16	18	12	P3.6	$\overline{WR}$	External Data Memory Write Strobe
				17	19	13	P3.7	$\overline{RD}$	External Data Memory Read Strobe				
31	35	29	$\overline{EA}$	<b>External Access, Active-Low Input.</b> This pin must be connected to ground for proper operation.									
—	12, 34, 1*	6, 28, 39*	N.C.	<b>No Connection (Reserved).</b> These pins should not be connected. They are reserved for use with future devices in this family. <i>*These pins are reserved for additional ground pins on future products.</i>									

## 80C32 COMPATIBILITY

The DS80C320/DS80C323 are CMOS 80C32-compatible microcontrollers designed for high performance. In most cases, the devices will drop into an existing 80C32 design to significantly improve the operation. Every effort has been made to keep the devices familiar to 8032 users, yet they have many new features. In general, software written for existing 80C32-based systems will work on the DS80C320 and DS80C323. The exception is critical timing, because the high-speed microcontroller performs its instructions much faster than the original. It may be necessary to use memories with faster access times if the same crystal frequency is used.

*Application Note 57: DS80C320 Memory Interface Timing* is a useful tool to help the embedded system designer select the proper memories for her or his application.

The DS80C320/DS80C323 run the standard 8051 instruction set and is pin compatible with an 80C32 in any of three standard packages. They also provide the same timer/counter resources, full-duplex serial port, 256 bytes of scratchpad RAM, and I/O ports as the standard 80C32. Timers will default to a 12 clock-per-cycle operation to keep timing compatible with original 8051 systems. However, they can be programmed to run at the new 4 clocks per cycle if desired.

New hardware features are accessed using special-function registers that do not overlap with standard 80C32 locations. A summary of these SFRs is provided below.

The DS80C320/DS80C323 address memory in an identical fashion to the standard 80C32. Electrical timing appears different due to the high-speed nature of the product. However, the signals are essentially the same. Detailed timing diagrams are provided in the *Electrical Specifications* section.

This data sheet assumes the user is familiar with the basic features of the standard 80C32. In addition to these standard features, the DS80C320/DS80C323 include many new functions. This data sheet provides only a summary and overview. Detailed descriptions are available in the *High-Speed Microcontroller User's Guide*.

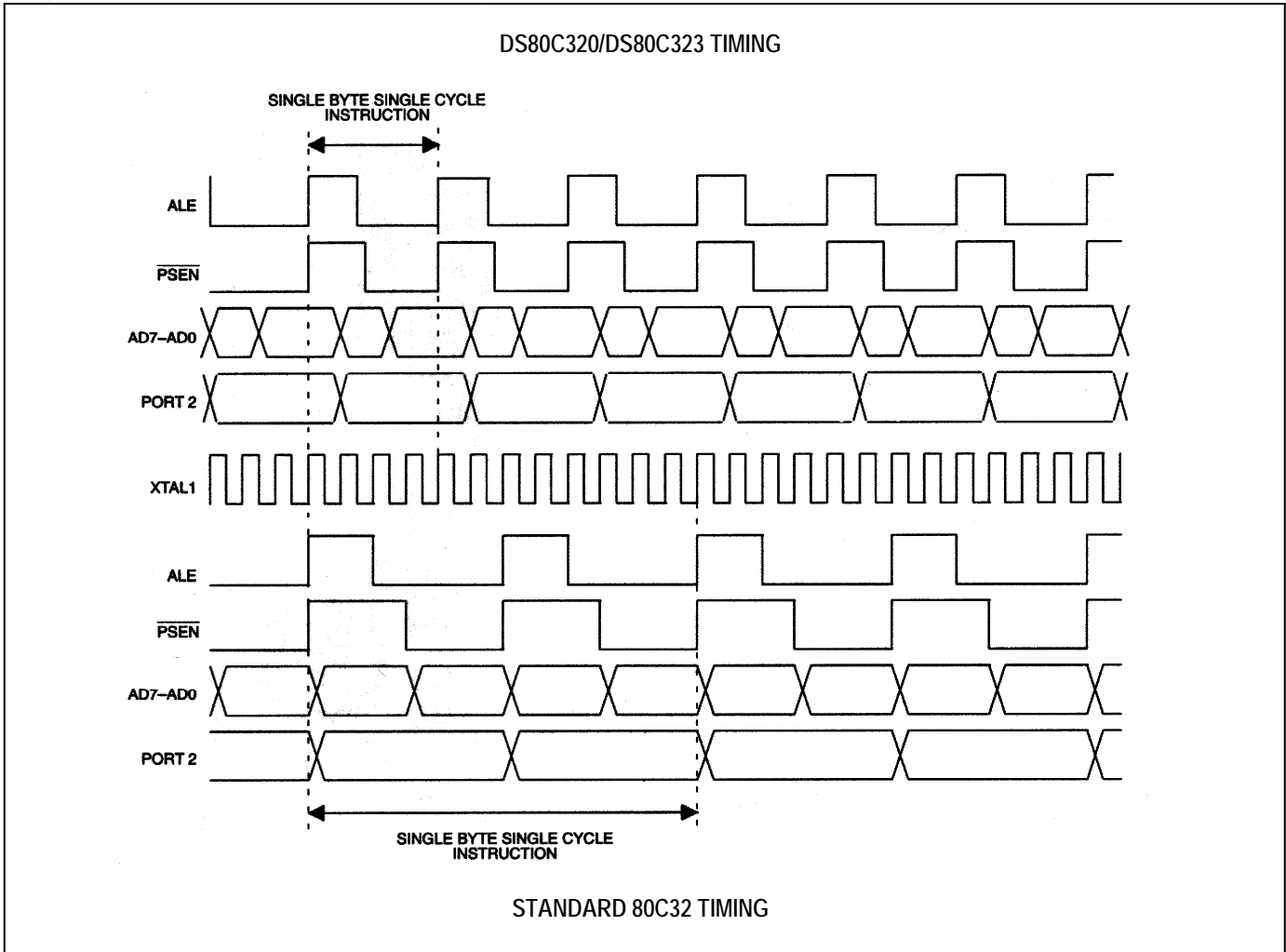
**Figure 2. Comparative Timing of the DS80C320/DS80C323 and 80C32**

## HIGH-SPEED OPERATION

The DS80C320/DS80C323 are built around a high-speed, 80C32-compatible core. Higher speed comes not just from increasing the clock frequency but also from a newer, more efficient design.

In this updated core, dummy memory cycles have been eliminated. In a conventional 80C32, machine cycles are generated by dividing the clock frequency by 12. In the DS80C320/DS80C323, the same machine cycle is performed in 4 clocks. Thus the fastest instruction, one machine cycle, is executed three times faster for the same crystal frequency. Note that these are identical instructions. Figure 2 shows a comparison of the timing differences. The majority of instructions will see the full 3-to-1 speed improvement. Some instructions will get between 1.5X and 2.4X improvement. Note that all instructions are faster than the original 80C51. Table 1 shows a summary of the instruction set, including the speed.

The numerical average of all op codes is approximately a 2.5-to-1 speed improvement. Individual programs are affected differently, depending on the actual instructions used. Speed-sensitive applications would make the most use of instructions that are three times faster. However, the sheer number of 3-to-1 improved op codes makes dramatic speed improvements likely for any code. The Dual Data Pointer feature also allows the user to eliminate wasted instructions when moving blocks of memory.

## INSTRUCTION SET SUMMARY

All instructions in the DS80C320/DS80C323 perform the same functions as their 80C32 counterparts. Their effect on bits, flags, and other status functions is identical. However, the timing of each instruction is different. This applies both in absolute and relative number of clocks.

For absolute timing of real-time events, the timing of software loops will need to be calculated using the Table 1. However, counter/timers default to run at the older 12 clocks per increment. Therefore, while software runs at higher speed, timer-based events need no modification to operate as before. Timers can be set to run at 4 clocks per increment cycle to take advantage of higher speed operation.

The relative time of two instructions might be different in the new architecture than it was previously. For example, in the original architecture, the “MOVX A, @DPTR” instruction and the “MOV direct, direct” instruction used two machine cycles or 24 oscillator cycles. Therefore, they required the same amount of time. In the DS80C320/DS80C323, the MOVX instruction can be done in two machine cycles or eight oscillator cycles, but the “MOV direct, direct” uses three machine cycles or 12 oscillator cycles. While both are faster than their original counterparts, they now have different execution times from each other. This is because in most cases, the DS80C320/DS80C323 use one cycle for each byte. The user concerned with precise program timing should examine the timing of each instruction for familiarity with the changes. Note that a machine cycle now requires just four clocks, and provides one ALE pulse per cycle. Many instructions require only one cycle, but some require five. In the original architecture, all were one or two cycles except for MUL and DIV.



**Table 1. Instruction Set Summary**

SYMBOL	FUNCTION
A	Accumulator
Rn	Register R7 to R0
direct	Internal Register Address
@Ri	Internal Register pointed to by R0 or R1 (except MOVX)
rel	Two's Complement Offset Byte

SYMBOL	FUNCTION
bit	direct bit-address
#data	8-bit constant
#data 16	16-bit constant
addr 16	16-bit destination address
addr 11	11-bit destination address

INSTRUCTION	BYTE	OSCILLATOR CYCLES	INSTRUCTION	BYTE	OSCILLATOR CYCLES
<b>ARITHMETIC INSTRUCTIONS</b>					
ADD A, Rn	1	4	INC A	1	4
ADD A, direct	2	8	INC Rn	1	4
ADD A, @Ri	1	4	INC direct	2	8
ADD A, #data	2	8	INC @Ri	1	4
ADDC A, Rn	1	4	INC DPTR	1	12
ADDC A, direct	2	8	DEC A	1	4
ADDC A, @Ri	1	4	DEC Rn	1	4
ADDC A, #data	2	8	DEC direct	2	8
SUBB A, Rn	1	4	DEC @Ri	1	4
SUBB A, direct	2	8	MUL AB	1	20
SUBB A, @Ri	1	4	DIV AB	1	20
SUBB A, #data	2	8	DA A	1	4
<b>LOGICAL INSTRUCTIONS</b>					
ANL A, Rn	1	4	XRL A, Rn	1	4
ANL A, direct	2	8	XRL A, direct	2	8
ANL A, @Ri	1	4	XRL A, @Ri	1	4
ANL A, #data	2	8	XRL A, #data	2	8
ANL direct, A	2	8	XRL direct, A	2	8
ANL direct, #data	3	12	XRL direct, #data	3	12
ORL A, Rn	1	4	CLR A	1	4
ORL A, direct	2	8	CPL A	1	4
ORL A, @Ri	1	4	RL A	1	4
ORL A, #data	2	8	RLC A	1	4
ORL direct, A	2	8	RR A	1	4
ORL direct, #data	3	12	RRC A	1	4

**Table 1. Instruction Set Summary (continued)**

INSTRUCTION	BYTE	OSCILLATOR CYCLES	INSTRUCTION	BYTE	OSCILLATOR CYCLES
<b>DATA TRANSFER INSTRUCTIONS</b>					
MOV A, Rn	1	4	MOVC A, @A+DPTR	1	12
MOV A, direct	2	8	MOVC A, @A+PC	1	12
MOV A, @Ri	1	4	MOVX A, @Ri	1	8–36*
MOV A, #data	2	8	MOVX A, @DPTR	1	8–36*
MOV Rn, A	1	4	MOVX @Ri, A	1	8–36*
MOV Rn, direct	2	8	MOVX @DPTR, A	1	8–36*
MOV Rn, #data	2	8	PUSH direct	2	8
MOV direct, A	2	8	POP direct	2	8
MOV direct, Rn	2	8	XCH A, Rn	1	4
MOV direct1, direct2	3	12	XCH A, direct	2	8
MOV direct, @Ri	2	8	XCH A, @Ri	1	4
MOV direct, #data	3	12	XCHD A, @Ri	1	4
MOV @Ri, A	1	4			
MOV @Ri, direct	2	8			
MOV @Ri, #data	2	8			
MOV DPTR, #data 16	3	12			
<b>BIT MANIPULATION INSTRUCTIONS</b>					
CLR C	1	4	ANL C, bit	2	8
CLR bit	2	8	ANL C, $\overline{\text{bit}}$	2	8
SETB C	1	4	ORL C, bit	2	8
SETB bit	2	8	ORL C, $\overline{\text{bit}}$	2	8
CPL C	1	4	MOV C, bit	2	8
CPL bit	2	8	MOV bit, C	2	8
<b>PROGRAM BRANCHING INSTRUCTIONS</b>					
ACALL addr 11	2	12	CJNE A, direct, rel	3	16
LCALL addr 16	3	16	CJNE A, #data, rel	3	16
RET	1	16	CJNE Rn, #data, rel	3	16
RETI	1	16	CJNE Ri, #data, rel	3	16
AJMP addr 11	2	12	NOP	1	4
LJMP addr 16	3	16	JC rel	2	12
SJMP rel	2	12	JNC rel	2	12
JMP @A+DPTR	1	12	JB bit, rel	3	16
JZ rel	2	12	JNB bit, rel	3	16
JNZ rel	2	12	JBC bit, rel	3	16
DJNZ Rn, rel	2	12			
DJNZ direct, rel	3	16			

\*User selectable.

Table 1 shows the speed for each class of instruction. Note that many of the instructions have multiple op codes. There are 255 op codes for 111 instructions. Of the 255 op codes, 159 are three times faster than the original 80C32. While a system that emphasizes those instructions will see the most improvement, the large total number that receive a 3 to 1 improvement assure a dramatic speed increase for any system. The speed improvement summary is provided below.

**SPEED ADVANTAGE SUMMARY**

#OP CODES	SPEED IMPROVEMENT
159	3.0 x
51	1.5 x
43	2.0 x
2	2.4 x
255	Average: 2.5

**MEMORY ACCESS**

The DS80C320/DS80C323 do not contain on-chip ROM and 256 bytes of scratchpad RAM. Off-chip memory is accessed using the multiplexed address/data bus on P0 and the MSB address on P2. Figure 3 shows a typical memory connection. Timing diagrams are provided in the *Electrical Specifications* section. Program memory (ROM) is accessed at a fixed rate determined by the crystal frequency and the actual instructions. As previously mentioned, an instruction cycle requires 4 clocks. Data memory (RAM) is accessed according to a variable-speed MOVX instruction as described below.

**Figure 3. Typical Memory Connection**



## STRETCH MEMORY CYCLE

The DS80C320/DS80C323 allow the application software to adjust the speed of data memory access. The microcontroller is capable of performing the MOVX in as little as two instruction cycles. However, this value can be stretched as needed so that both fast memory and slow memory or peripherals can be accessed with no glue logic. Even in high-speed systems, it may not be necessary or desirable to perform data memory access at full speed. In addition, there are a variety of memory-mapped peripherals such as LCD displays or UARTs that are not fast.

The Stretch MOVX is controlled by the Clock Control Register at SFR location 8Eh as described below. This allows the user to select a stretch value between 0 and 7. A Stretch of 0 will result in a two-machine cycle MOVX. A Stretch of 7 will result in a MOVX of nine machine cycles. Software can dynamically change this value depending on the particular memory or peripheral.

On reset, the Stretch value will default to 1, resulting in a three-cycle MOVX. Therefore, RAM access will not be performed at full speed. This is a convenience to existing designs that may not have fast RAM in place. When maximum speed is desired, the software should select a Stretch value of 0. When using very slow RAM or peripherals, a larger stretch value can be selected. Note that this affects data memory only and the only way to slow program memory (ROM) access is to use a slower crystal.

Using a Stretch value between 1 and 7 causes the microcontroller to stretch the read/write strobe and all related timing. This results in a wider read/write strobe allowing more time for memory/peripherals to respond. The timing of the variable speed MOVX is shown in the *Electrical Specifications* section. Note that full speed access is not the reset default case. Table 2 shows the resulting strobe widths for each Stretch value. The memory stretch is implemented using the Clock Control special-function register at SFR location 8Eh. The stretch value is selected using bits CKCON.2–0. In the table, these bits are referred to as M2 through M0. The first stretch (default) allows the use of common 120ns or 150ns RAMs without dramatically lengthening the memory access.

**Table 2. Data Memory Cycle Stretch Values**

CKCON.2–0			MEMORY CYCLES	$\overline{\text{RD}}$ or $\overline{\text{WR}}$ STROBE WIDTH IN CLOCKS	STROBE WIDTH TIME AT 25MHz (ns)
MD2	MD1	MD0			
0	0	0	2	2	80
0	0	1	3 (default)	4	160
0	1	0	4	8	320
0	1	1	5	12	480
1	0	0	6	16	640
1	0	1	7	20	800
1	1	0	8	24	960
1	1	1	9	28	1120

## DUAL DATA POINTER

Data memory block moves can be accelerated using the Dual Data Pointer (DPTR). The standard 8032 DPTR is a 16-bit value that is used to address off-chip data RAM or peripherals. In the DS80C320/DS80C323, the standard 16-bit data pointer is called DPTR0 and is located at SFR addresses 82h and 83h. These are the standard locations. The new DPTR is located at SFR 84h and 85h and is called DPTR1. The DPTR Select bit (DPS) chooses the active pointer and is located at the LSB of the SFR location 86h. No other bits in register 86h have any effect and are set to 0. The user switches between data pointers by toggling the LSB of register 86h. The increment (INC) instruction is the fastest way to accomplish this. All DPTR-related instructions use the currently selected DPTR for any activity. Therefore only one instruction is required to switch from a source to a destination address. Using the Dual-Data Pointer saves code from needing to save source and destination addresses when doing a block move. Once loaded, the software simply switches between DPTR and 1. The relevant register locations are as follows.

DPL	82h	Low byte original DPTR
DPH	83h	High byte original DPTR
DPL1	84h	Low byte new DPTR
DPH1	85h	High byte new DPTR
DPS	86h	DPTR Select (LSB)

Sample code listed below illustrates the saving from using the dual DPTR. The example program was original code written for an 8051 and requires a total of 1869 DS80C320/DS80C323 machine cycles. This takes 299 $\mu$ s to execute at 25MHz. The new code using the Dual DPTR requires only 1097 machine cycles taking 175.5 $\mu$ s. The Dual DPTR saves 772 machine cycles or 123.5 $\mu$ s for a 64-byte block move. Since each pass through the loop saves 12 machine cycles when compared to the single DPTR approach, larger blocks gain more efficiency using this feature.

### 64-Byte Block Move without Dual Data Pointer

; SH and SL are high and low byte source address.

; DH and DL are high and low byte of destination address.

			# CYCLES
MOV	R5, #64d	; NUMBER OF BYTES TO MOVE	2
MOV	DPTR, #SHSL	; LOAD SOURCE ADDRESS	3
MOV	R1, #SL	; SAVE LOW BYTE OF SOURCE	2
MOV	R2, #SH	; SAVE HIGH BYTE OF SOURCE	2
MOV	R3, #DL	; SAVE LOW BYTE OF DESTINATION	2
MOV	R4, #DH	; SAVE HIGH BYTE OF DESTINATION	2
MOVE:			
; THIS LOOP IS PERFORMED THE NUMBER OF TIMES LOADED INTO R5, IN THIS EXAMPLE 64			
MOVX	A, @DPTR	; READ SOURCE DATA BYTE	2
MOV	R1, DPL	; SAVE NEW SOURCE POINTER	2
MOV	R2, DPH	;	2
MOV	DPL, R3	; LOAD NEW DESTINATION	2
MOV	DPH, R4	;	2
MOVX	@DPTR, A	; WRITE DATA TO DESTINATION	2
INC	DPTR	; NEXT DESTINATION ADDRESS	3
MOV	R3, DPL	; SAVE NEW DESTINATION POINTER	2
MOV	R4, DPH	;	2
MOV	DPL, R1	; GET NEW SOURCE POINTER	2
MOV	DPH, R2	;	2
INC	DPTR	; NEXT SOURCE ADDRESS	3
DJNZ	R5, MOVE	; FINISHED WITH TABLE?	3

## 64-Byte Block Move with Dual Data Pointer

```

; SH and SL are high and low byte source address.
; DH and DL are high and low byte of destination address.
; DPS is the data pointer select. Reset condition is DPS=0, DPTR0 is selected.
                                # CYCLES
EQU      DPS, #86h                ; TELL ASSEMBLER ABOUT DPS
MOV      R5, #64                  ; NUMBER OF BYTES TO MOVE                2
MOV      DPTR, #DHDL              ; LOAD DESTINATION ADDRESS                3
INC      DPS                      ; CHANGE ACTIVE DPTR                    2
MOV      DPTR, #SHSL              ; LOAD SOURCE ADDRESS                    2

MOVE:
; THIS LOOP IS PERFORMED THE NUMBER OF TIMES LOADED INTO R5, IN THIS EXAMPLE 64

MOVX     A, @DPTR                 ; READ SOURCE DATA BYTE                2
INC      DPS                      ; CHANGE DPTR TO DESTINATION            2
MOVX     @DPTR, A                 ; WRITE DATA TO DESTINATION            2
INC      DPTR                    ; NEXT DESTINATION ADDRESS                3
INC      DPS                      ; CHANGE DATA POINTER TO SOURCE        2
INC      DPTR                    ; NEXT SOURCE ADDRESS                    3
DJNZ     R5, MOVE                 ; FINISHED WITH TABLE?                3

```

## PERIPHERAL OVERVIEW

Peripherals in the DS80C320/DS80C323 are accessed using the SFRs. The devices provide several of the most commonly needed peripheral functions in microcomputer-based systems. These functions are new to the 80C32 family and include a second serial port, power-fail reset, power-fail interrupt, and a programmable watchdog timer. These are briefly described in the following paragraphs. More details are available in the *High-Speed Microcontroller User's Guide*.

## SERIAL PORTS

The DS80C320/DS80C323 provide a serial port (UART) that is identical to the 80C32. Many applications require serial communication with multiple devices. Therefore, a second hardware serial port is provided that is a full duplicate of the standard one. It optionally uses pins P1.2 (RXD1) and P1.3 (TXD1). This port has duplicate control functions included in new SFR locations. The second serial port operates in a comparable manner with the first. Both can operate simultaneously but can be at different baud rates.

The second serial port has similar control registers (SCON1 at C0h, SBUF1 at C1h) to the original. One difference is that for timer-based baud rates, the original serial port can use Timer 1 or Timer 2 to generate baud rates. This is selected via SFR bits. The new serial port can only use Timer 1.

## TIMER-RATE CONTROL

One important difference exists between the DS80C320/DS80C323 and 80C32 regarding timers. The original 80C32 used a 12 clock-per-cycle scheme for timers and consequently for some serial baud rates (depending on the mode). The DS80C320/DS80C323 architecture normally runs using 4 clocks per cycle. However, in the area of timers, it will default to a 12 clock-per-cycle scheme on a reset. This allows existing code with real-time dependencies such as baud rates to operate properly. If an application needs higher speed timers or serial baud rates, the timers can be set to run at the 4-clock rate.

The Clock Control register (CKCON - 8Eh) determines these timer speeds. When the relevant CKCON bit is a logic 1, the device uses 4 clocks per cycle to generate timer speeds. When the control bit is set to a 0, the device uses 12 clocks for timer speeds. The reset condition is a 0. CKCON.5 selects the speed of Timer 2. CKCON.4 selects Timer 1 and CKCON.3 selects Timer 0. Note that unless a user desires very fast timing, it is unnecessary to alter these bits. Note that the timer controls are independent.

## POWER-FAIL RESET

The DS80C320/DS80C323 incorporate a precision bandgap voltage reference to determine when  $V_{CC}$  is out of tolerance. While powering up, internal circuits will hold the device in a reset state until  $V_{CC}$  rises above the  $V_{RST}$  reset threshold. Once  $V_{CC}$  is above this level, the oscillator will begin running. An internal reset circuit will then count 65,536 clocks to allow time for power and the oscillator to stabilize. The microcontroller will then exit the reset condition. No external components are needed to generate a power on reset. During power-down or during a severe power glitch, as  $V_{CC}$  falls below  $V_{RST}$ , the microcontroller will also generate its own reset. It will hold the reset condition as long as power remains below the threshold. This reset will occur automatically, needing no action from the user or from the software. See the *Electrical Specifications* section for the exact value of  $V_{RST}$ .

## POWER-FAIL INTERRUPT

The same reference that generates a precision reset threshold can also generate an optional early warning Power-fail Interrupt (PFI). When enabled by the application software, this interrupt always has the highest priority. On detecting that the  $V_{CC}$  has dropped below  $V_{PFW}$  and that the PFI is enabled, the processor will vector to ROM address 0033h. The PFI enable is located in the Watchdog Control SFR (WDCON to D8h). Setting WDCON.5 to logic 1 will enable the PFI. The application software can also read a flag at WDCON.4. This bit is set when a PFI condition has occurred. The flag is independent of the interrupt enable and software must manually clear it.

## WATCHDOG TIMER

For applications that cannot afford to run out of control, the DS80C320/DS80C323 incorporate a programmable watchdog timer circuit. The watchdog timer circuit resets the microcontroller if software fails to reset the watchdog before the selected time interval has elapsed. The user selects one of four timeout values. After enabling the watchdog, software must reset the timer prior to expiration of the interval, or the CPU will be reset. Both the Watchdog Enable and the Watchdog Reset bits are protected by a “Timed Access” circuit. This prevents accidentally clearing the watchdog. Timeout values are precise since they are related to the crystal frequency as shown in Table 3. For reference, the time periods at 25MHz are also shown.

The watchdog timer also provides a useful option for systems that may not require a reset. If enabled, then 512 clocks before giving a reset, the watchdog will give an interrupt. The interrupt can also serve as a convenient time-base generator, or be used to wake-up the processor from Idle mode. The watchdog function is controlled in the Clock Control (CKCON to 8Eh), Watchdog Control (WDCON to D8h), and Extended Interrupt Enable (EIE to E8h) SFRs. CKCON.7 and CKCON.6 are called WD1 and WD0, respectively, and are used to select the watchdog timeout period as shown in Table 3.

**Table 3. Watchdog Timeout Values**

WD1	WD0	INTERRUPT TIMEOUT	TIME (at 25MHz)	RESET TIMEOUT	TIME (at 25MHz)
0	0	$2^{17}$ clocks	5.243ms	$2^{17} + 512$ clocks	5.263ms
0	1	$2^{20}$ clocks	41.94ms	$2^{20} + 512$ clocks	41.96ms
1	0	$2^{23}$ clocks	335.54ms	$2^{23} + 512$ clocks	335.56ms
1	1	$2^{26}$ clocks	2684.35ms	$2^{26} + 512$ clocks	2684.38ms

As Table 3 shows, the watchdog timer uses the crystal frequency as a time base. A user selects one of four counter values to determine the timeout. These clock counter lengths are  $2^{17} = 131,072$  clocks;  $2^{20} = 1,048,576$ ;  $2^{23} = 8,388,608$  clocks; or  $2^{26} = 67,108,864$  clocks. The times shown in Table 4 are with

a 25MHz crystal frequency. Note that once the counter chain has reached a conclusion, the optional interrupt is generated. Regardless of whether the user enables this interrupt, there are then 512 clocks left until a reset occurs. There are 5 control bits in special function registers that affect the Watchdog Timer and two status flags that report to the user. The Reset Watchdog Timer bit (WDCON.0) should be asserted prior to modifying the Watchdog Timer Mode Select bits (WD1, WD0) to avoid corruption of the watchdog count.

WDIF (WDCON.3) is the interrupt flag that is set when there are 512 clocks remaining until a reset occurs. WTRF (WDCON.2) is the flag that is set when a Watchdog reset has occurred. This allows the application software to determine the source of a reset.

Setting the EWT (WDCON.1) bit enables the Watchdog Timer. The bit is protected by timed access. Setting the RWT (WDCON.0) bit restarts the Watchdog Timer for another full interval. Application software must set this bit prior to the timeout. As mentioned previously, WD1 and 0 (CKCON .7 and 6) select the timeout. Finally, the Watchdog Interrupt is enabled using EWDI (EIE.4).

## INTERRUPTS

The DS80C320/DS80C323 provide 13 sources of interrupt with three priority levels. The Power-fail Interrupt (PFI), if enabled, always has the highest priority. There are two remaining user-selectable priorities: high and low. If two interrupts that have the same priority occur simultaneously, the natural precedence given in Table 4 determines which is acted upon. Except for the PFI, all interrupts that are new to the 8051 family have a lower natural priority than the originals.

**Table 4. Interrupt Priority**

NAME	FUNCTION	VECTOR	NATURAL PRIORITY	OLD/NEW
PFI	Power-Fail Interrupt	33h	1	New
$\overline{\text{INT0}}$	External Interrupt 0	03h	2	Old
TF0	Timer 0	0Bh	3	Old
$\overline{\text{INT1}}$	External Interrupt 1	13h	4	Old
TF1	Timer 1	1Bh	5	Old
SCON0	TI0 or RI0 from Serial Port 0	23h	6	Old
TF2	Timer 2	2Bh	7	Old
SCON1	TI1 or RI1 from Serial Port 1	3Bh	8	New
INT2	External Interrupt 2	43h	9	New
$\overline{\text{INT3}}$	External Interrupt 3	4Bh	10	New
INT4	External Interrupt 4	53h	11	New
$\overline{\text{INT5}}$	External Interrupt 5	5Bh	12	New
WDTI	Watchdog Timeout Interrupt	63h	13	New



## POWER MANAGEMENT

The DS80C320/DS80C323 provide the standard Idle and power-down (Stop) modes that are available on the standard 80C32. However, the device has enhancements that make these modes more useful, and allow more power saving.

The Idle mode is invoked by setting the LSB of the Power Control register (PCON to 87h). Idle will leave internal clocks, serial port and timer running. No memory access will be performed so power is dramatically reduced. Since clocks are running, the Idle power consumption is related to crystal frequency. It should be approximately one-half the operational power. The CPU can exit the Idle state with any interrupt or a reset.

The power-down or Stop mode is invoked by setting the PCON.1 bit. Stop mode is a lower power state than Idle since it turns off all internal clocking. The  $I_{CC}$  of a standard Stop mode is approximately 1  $\mu$ A but is specified in the *Electrical Specifications* section. The CPU will exit Stop mode from an external interrupt or a reset condition.

Note that internally generated interrupts (timer, serial port, watchdog) are not useful in Idle or Stop since they require clocking activity.

## IDLE MODE ENHANCEMENTS

A simple enhancement to Idle mode makes it substantially more useful. The innovation involves not the Idle mode itself, but the watchdog timer. As mentioned above, the Watchdog Timer provides an optional interrupt capability. This interrupt can provide a periodic interval timer to bring the DS80C320/DS80C323 out of Idle mode. This can be useful even if the Watchdog is not normally used. By enabling the Watchdog Timer and its interrupt prior to invoking Idle, a user can periodically come out of Idle perform an operation, then return to Idle until the next operation. This will lower the overall power consumption. When using the Watchdog Interrupt to cancel the Idle state, make sure to restart the Watchdog Timer or it will cause a reset.

## STOP MODE ENHANCEMENTS

The DS80C320/DS80C323 provide two enhancements to the Stop mode. As documented above, the device provides a bandgap reference to determine Power-fail Interrupt and Reset thresholds. The default state is that the bandgap reference is off when Stop mode is invoked. This allows the extremely low power state mentioned above. A user can optionally choose to have the bandgap enabled during Stop mode. This means that PFI and power-fail reset will be activated and are valid means for leaving Stop mode.

In Stop mode with the bandgap on,  $I_{CC}$  will be approximately 50 $\mu$ A compared with 1 $\mu$ A with the bandgap off. If a user does not require a Power-fail Reset or Interrupt while in Stop mode, the bandgap can remain turned off. Note that only the most power sensitive applications should turn off the bandgap, as this results in an uncontrolled power-down condition.

The control of the bandgap reference is located in the Extended Interrupt Flag register (EXIF to 91h). Setting BGS (EXIF.0) to a 1 will leave the bandgap reference enabled during Stop mode. The default or reset condition is with the bit at a logic 0. This results in the bandgap being turned off during Stop mode. Note that this bit has no control of the reference during full power or Idle modes. Be aware that the DS80C320 and DS80C323 require that the reset watchdog timer bit (RWT;WDCON.0) be set

immediately preceding the setting of the Stop bit to guarantee a correct power-on delay when exiting Stop mode.

The second feature allows an additional power saving option. This is the ability to start instantly when exiting Stop mode. It is accomplished using an internal ring oscillator that can be used when exiting Stop mode in response to an interrupt. The benefit of the ring oscillator is as follows.

Using Stop mode turns off the crystal oscillator and all internal clocks to save power. This requires that the oscillator be restarted when exiting Stop mode. Actual start-up time is crystal dependent, but is normally at least 4ms. A common recommendation is 10ms. In an application that will wakeup, perform a short operation, then return to sleep, the crystal startup can be longer than the real transaction. However, the ring oscillator will start instantly. The user can perform a simple operation and return to sleep before the crystal has even stabilized. If the ring is used to start and the processor remains running, hardware will automatically switch to the crystal once a power-on reset interval (65,536 clocks) has expired. This value is used to guarantee stability even though power is not being cycled.

If the user returns to Stop mode prior to switching of crystal, then all clocks will be turned off again. The ring oscillator runs at approximately 3MHz (1.5MHz at 3V) but will not be a precision value. No real-time precision operations (including serial communication) should be conducted during this ring period. Figure 4 shows how the operation would compare when using the ring, and when starting up normally. The default state is to come out of Stop mode without using the ring oscillator.

This function is controlled using the RGSL - Ring Select bit at EXIF.1 (EXIF to 91h). When EXIF.1 is set, the ring oscillator will be used to come out of Stop mode quickly. As mentioned above, the processor will automatically switch from the ring (if enabled) to the crystal after a delay of 65,536 crystal clocks. For a 3.57MHz crystal, this is approximately 18ms. The processor sets a flag called RGMD - Ring Mode to tell software that the ring is being used. This bit at EXIF.2 will be logic 1 when the ring is in use. No serial communication or precision timing should be attempted while this bit is set, since the operating frequency is not precise.

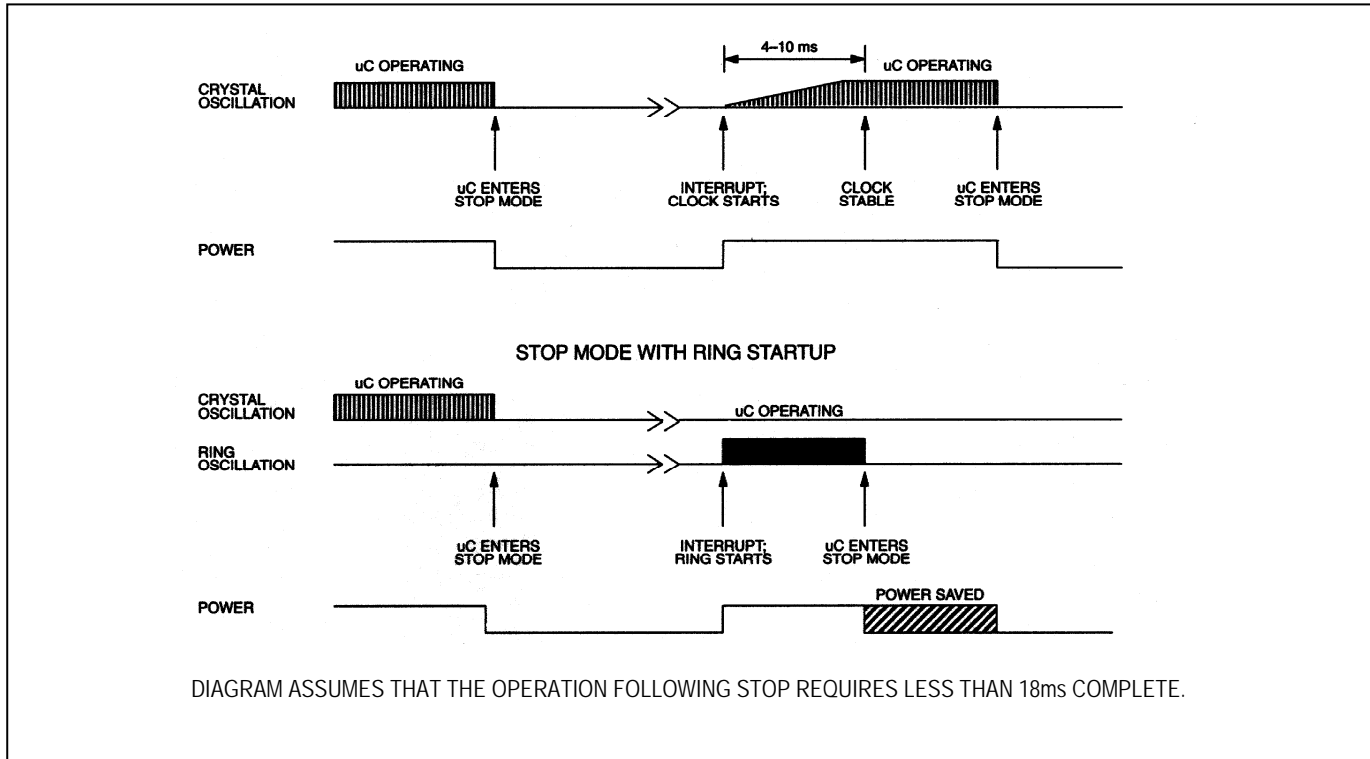
**Figure 4. Ring Oscillator Startup**

## TIMED ACCESS PROTECTION

Selected SFR bits are critical to operation, making it desirable to protect against an accidental write operation. The Timed Access procedure prevents an errant CPU from accidentally altering a bit that would cause difficulty. The Timed Access procedure requires that the write of a protected bit be preceded by the following instructions:

```
MOV    0C7h, #0AAh
MOV    0C7h, #55h
```

By writing an AAh followed by a 55h to the Timed Access register (location C7h), the hardware opens a three-cycle window that allows software to modify one of the protected bits. If the instruction that seeks to modify the protected bit is not immediately preceded by these instructions, the write will not take effect. The protected bits are:

EXIF.0	BGS Bandgap Select
WDCON.6	POR Power-on Reset flag
WDCON.1	EWT Enable Watchdog
WDCON.0	RWT Reset Watchdog
WDCON.3	WDIF Watchdog Interrupt Flag

## SPECIAL-FUNCTION REGISTERS

Most special features of the DS80C320/DS80C323 or 80C32 are controlled by bits in the SFRs, allowing the devices to add many features but use the same instruction set. When writing software to use a new feature, the SFR must be defined to an assembler or compiler using an equate statement. This is the only change needed to access the new function. The DS80C320/DS80C323 duplicate the SFRs that are contained in the standard 80C32. Table 5 shows the register addresses and bit locations. Many are standard 80C32 registers. The *High-Speed Microcontroller User's Guide* describes all SFRs.

**Table 5. Special-Function Register Locations**

REGISTER	BIT 7	BIT 6	BIT 5	BIT 4	BIT 3	BIT 2	BIT 1	BIT 0	ADDRESS
SP									81h
DPL									82h
DPH									83h
<b>DPL1</b>									84h
<b>DPH1</b>									85h
<b>DPS</b>	<b>0</b>	<b>0</b>	<b>0</b>	<b>0</b>	<b>0</b>	<b>0</b>	<b>0</b>	<b>SEL</b>	86h
PCON	SMOD_0	<b>SMOD0</b>	—	—	GF1	GF0	STOP	IDLE	87h
TCON	TF1	TR1	TF0	TR0	IE1	IT1	IE0	IT0	88h
TMOD	GATE	C/ $\bar{T}$	M1	M0	GATE	C/ $\bar{T}$	M1	M0	89h
TL0									8Ah
TL1									8Bh
TH0									8Ch
TH1									8Dh
<b>CKCON</b>	<b>WD1</b>	<b>WD0</b>	<b>T2M</b>	<b>T1M</b>	<b>T0M</b>	<b>MD2</b>	<b>MD1</b>	<b>MD0</b>	8Eh
P1	P1.7	P1.6	P1.5	P1.4	P1.3	P1.2	P1.1	P1.0	90h
<b>EXIF</b>	<b>IE5</b>	<b>IE4</b>	<b>IE3</b>	<b>IE2</b>	—	<b>RGMD</b>	<b>RGSL</b>	<b>BGS</b>	91h
SCON0	SM0/FE_0	SM1_0	SM2_0	REN_0	TB8_0	RB8_0	TI_0	RI_0	98h
SBUF0									99h
P2	P2.0	P2.6	P2.5	P2.4	P2.3	P2.2	P2.1	P2.0	A0h
IE	EA	ES1	ET2	ES0	ET1	EX1	ET0	EX0	A8h
SADDR0									A9h
SADDR1									AAh
P3	P3.7	P3.6	P3.5	P3.4	P3.3	P3.2	P3.1	P3.0	B0h
IP	—	PS1	PT2	PS0	PT1	PX1	PT0	PX0	B8h
SADEN0									B9h
SADEN1									BAh
<b>SCON1</b>	<b>SM0/FE_0</b>	<b>SM1_0</b>	<b>SM2_0</b>	<b>REN_0</b>	<b>TB8_0</b>	<b>RB8_0</b>	<b>TI_0</b>	<b>RI_0</b>	C0h
<b>SBUF1</b>									C1h
STATUS	PIP	HIP	LIP	1	1	1	1	1	C5h
<b>TA</b>									C7h
T2CON	TF2	EXF2	RCLK	TCLK	EXEN2	TR2	C/ $\bar{T}2$	CP/ $\bar{R}L2$	C8h
T2MOD	—	—	—	—	—	—	T2OE	DCEN	C9h
RCAP2L									CAh
RCAP2H									CBh
TL2									CCh
TH2									CDh
PSW	CY	AC	F0	RS1	RS0	OV	FL	P	D0h
<b>WDCON</b>	<b>SMOD_1</b>	<b>POR</b>	<b>EPFI</b>	<b>PFI</b>	<b>WDIF</b>	<b>WTRF</b>	<b>EWT</b>	<b>RWT</b>	D8h
ACC									E0h
<b>EIE</b>	—	—	—	<b>EWDI</b>	<b>EX5</b>	<b>EX4</b>	<b>EX3</b>	<b>EX2</b>	E8h
B									F0h
<b>EIP</b>	—	—	—	<b>PWDI</b>	<b>PX5</b>	<b>PX4</b>	<b>PX3</b>	<b>PX2</b>	F8h

## ELECTRICAL SPECIFICATIONS

### ABSOLUTE MAXIMUM RATINGS

Voltage Range on Any Pin Relative to Ground.....	-0.3V to ( $V_{CC} + 0.5V$ )
Voltage Range on $V_{CC}$ Relative to Ground.....	-0.3V to +6.0V
Operating Temperature Range.....	-40°C to +85°C
Storage Temperature Range.....	-55°C to +125°C
Soldering Temperature.....	See IPC/JEDEC J-STD-020 Specification

*This is a stress rating only and functional operation of the device at these or any other conditions above those indicated in the operation sections of this specification is not implied. Exposure to absolute maximum rating conditions for extended periods of time may affect reliability.*

### DC ELECTRICAL CHARACTERISTICS—DS80C320

( $V_{CC} = 4.5V$  to  $5.5V$ ,  $T_A = -40°C$  to  $+85°C$ .)

PARAMETER	SYMBOL	MIN	TYP	MAX	UNITS	NOTES
Operating Supply Voltage	$V_{CC}$	4.5	5.0	5.5	V	1
Power-Fail Warning Voltage	$V_{PFW}$	4.25	4.38	4.55	V	1
Minimum Operating Voltage	$V_{RST}$	4.0	4.1	4.25	V	1, 12
Supply Current Active Mode at 25MHz	$I_{CC}$		30	45	mA	2
Supply Current Idle Mode at 25MHz	$I_{IDLE}$		15	25	mA	3
Supply Current Active Mode at 33MHz	$I_{CC}$		35		mA	2
Supply Current Idle Mode at 33MHz	$I_{IDLE}$		20		mA	3
Supply Current Stop Mode, Bandgap Reference Disabled	$I_{STOP}$		0.01	1	$\mu A$	4
Supply Current Stop Mode, Bandgap Reference Enabled	$I_{SPBG}$		50	80	$\mu A$	4, 10
Input Low Level	$V_{IL}$	-0.3		+0.8	V	1
Input High Level (Except XTAL1 and RST)	$V_{IH1}$	2.0		$V_{CC} + 0.3$	V	1
Input High Level XTAL1 and RST	$V_{IH2}$	3.5		$V_{CC} + 0.3$	V	1
Output-Low Voltage Ports 1, 3 at $I_{OL} = 1.6mA$	$V_{OL1}$			0.45	V	1
Output-Low Voltage Ports 0, 2, ALE, $\overline{PSEN}$ at $I_{OL} = 3.2mA$	$V_{OL2}$			0.45	V	1, 5
Output-High Voltage Ports 1, 3, ALE, $\overline{PSEN}$ at $I_{OH} = -50\mu A$	$V_{OH1}$	2.4			V	1, 6
Output High Voltage Ports 1, 3 at $I_{OH} = -1.5mA$	$V_{OH2}$	2.4			V	1, 7
Output-High Voltage Ports 0, 2, ALE, $\overline{PSEN}$ at $I_{OH} = -8mA$	$V_{OH3}$	2.4			V	1, 5
Input Low Current Ports 1, 3 at 0.45V	$I_{IL}$			-55	$\mu A$	11
Transition Current from 1 to 0 Ports 1, 3 at 2V	$I_{TL}$			-650	$\mu A$	8
Input Leakage Port 0, Bus Mode	$I_L$	-300		+300	$\mu A$	9
RST Pulldown Resistance	$R_{RST}$	50		170	k $\Omega$	

## NOTES FOR DS80C320 DC ELECTRICAL CHARACTERISTICS

All parameters apply to both commercial and industrial temperature operation unless otherwise noted. Specifications to  $-40^{\circ}\text{C}$  are guaranteed by design and are not production tested.

- All voltages are referenced to ground.
- Active current is measured with a 25MHz clock source driving XTAL1,  $V_{CC} = RST = 5.5\text{V}$ , all other pins disconnected.
- Idle mode current is measured with a 25MHz clock source driving XTAL1,  $V_{CC} = 5.5\text{V}$ , RST at ground, all other pins disconnected.
- Stop mode current measured with XTAL1 and RST grounded,  $V_{CC} = 5.5\text{V}$ , all other pins disconnected.
- When addressing external memory. This specification only applies to the first clock cycle following transition.
- $RST = V_{CC}$ . This condition mimics operation of pins in I/O mode.
- During a 0-to-1 transition, a one-shot drives the ports hard for two clock cycles. This measurement reflects port in transition mode.
- Ports 1 and 3 source transition current when being pulled down externally. It reaches its maximum at approximately 2V.
- $0.45 < V_{IN} < V_{CC}$ . Not a high-impedance input. This port is a weak address holding latch because Port 0 is dedicated as an address bus on the DS80C320. Peak current occurs near the input transition point of the latch, approximately 2V.
- Over the industrial temperature range, this specification has a maximum value of  $200\mu\text{A}$ .
- This is the current required from an external circuit to hold a logic low level on an I/O pin while the corresponding port latch bit is set to 1. This is only the current required to *hold* the low level; transitions from 1 to 0 on an I/O pin will also have to overcome the transition current.
- Device operating range is 4.5V to 5.5V; however, device is tested to 4.0V to ensure proper operation at minimum  $V_{RST}$ .

### TYPICAL $I_{CC}$ vs. FREQUENCY

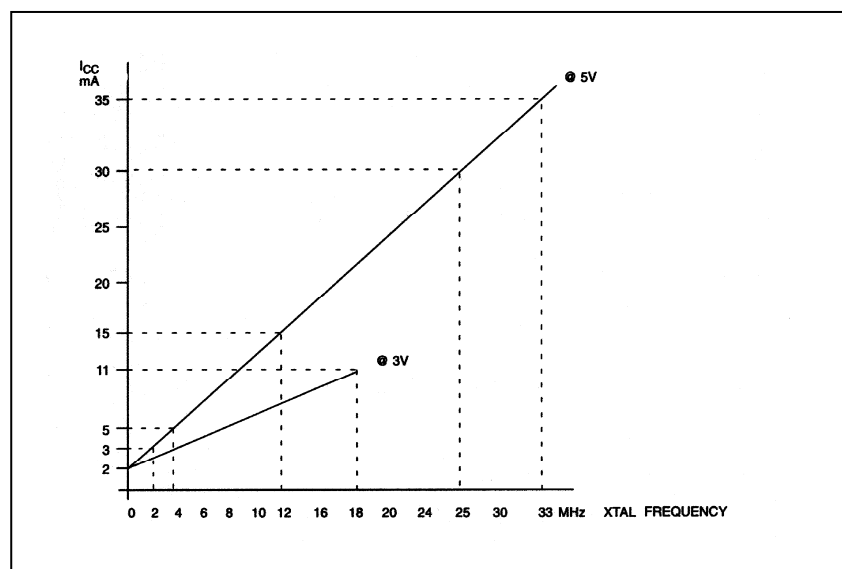

**AC CHARACTERISTICS—DS80C320**

PARAMETER		SYMBOL	33MHz		VARIABLE CLOCK		UNITS
			MIN	MAX	MIN	MAX	
Oscillator Frequency	External Oscillator	$1/t_{CLCL}$	0	33	0	33	MHz
	External Crystal		1	33	1	33	
ALE Pulse Width		$t_{LHLL}$	34		$1.5t_{CLCL}-11$		ns
Port 0 Address Valid to ALE Low		$t_{AVLL}$	4		$0.5t_{CLCL}-11$		ns
Address Hold After ALE Low		$t_{LLAX1}$	2	(Note 5)	$0.25t_{CLCL}-5$	(Note 5)	ns
Address Hold After ALE Low for MOVX $\overline{WR}$		$t_{LLAX2}$	6		$0.5t_{CLCL}-9$		ns
ALE Low to Valid Instruction In		$t_{LLIV}$		49		$2.5t_{CLCL}-27$	ns
ALE Low to $\overline{PSEN}$ Low		$t_{LLPL}$	0.5		$0.25t_{CLCL}-7$		ns
$\overline{PSEN}$ Pulse Width		$t_{PLPH}$	61		$2.25t_{CLCL}-7$		ns
$\overline{PSEN}$ Low to Valid Instruction In		$t_{PLIV}$		48		$2.25t_{CLCL}-21$	ns
Input Instruction Hold After $\overline{PSEN}$		$t_{PXIX}$	0		0		ns
Input Instruction Float After $\overline{PSEN}$		$t_{PXIZ}$		25		$t_{CLCL}-5$	ns
Port 0 Address to Valid Instruction In		$t_{AVIV1}$		64		$3t_{CLCL}-27$	ns
Port 2 Address to Valid Instruction In		$t_{AVIV2}$		73		$3.5t_{CLCL}-33$	ns
$\overline{PSEN}$ Low to Address Float		$t_{PLAZ}$		(Note 5)		(Note 5)	ns

**NOTES FOR DS80C320 AC ELECTRICAL CHARACTERISTICS**

All parameters apply to both commercial and industrial temperature operation unless otherwise noted. Specifications to  $-40^{\circ}\text{C}$  are guaranteed by design and are not production tested. AC electrical characteristics assume 50% duty cycle for the oscillator, oscillator frequency > 16MHz, and are not 100% tested, but are guaranteed by design.

1. All signals rated over operating temperature at 33MHz.
2. All signals characterized with load capacitance of 80pF except Port 0, ALE,  $\overline{PSEN}$ ,  $\overline{RD}$  and  $\overline{WR}$  at 100pF. Note that loading should be approximately equal for valid timing.
3. Interfacing to memory devices with float times (turn off times) over 30ns may cause contention. This will not damage the parts but will cause an increase in operating current.
4. Specifications assume a 50% duty cycle for the oscillator. Port 2 timing will change with the duty cycle variations.
5. Address is held in a weak latch until over driven by external memory.

**MOVX CHARACTERISTICS—DS80C320**

PARAMETER	SYMBOL	VARIABLE CLOCK		UNITS	STRETCH
		MIN	MAX		
$\overline{\text{RD}}$ Pulse Width	$t_{\text{RLRH}}$	$2t_{\text{CLCL}}-11$		ns	$t_{\text{MCS}}=0$
		$t_{\text{MCS}}-11$			$t_{\text{MCS}}>0$
$\overline{\text{WR}}$ Pulse Width	$t_{\text{WLWH}}$	$2t_{\text{CLCL}}-11$		ns	$t_{\text{MCS}}=0$
		$t_{\text{MCS}}-11$			$t_{\text{MCS}}>0$
$\overline{\text{RD}}$ Low to Valid Data In	$t_{\text{RLDV}}$		$2t_{\text{CLCL}}-25$	ns	$t_{\text{MCS}}=0$
			$t_{\text{MCS}}-25$		$t_{\text{MCS}}>0$
Data Hold After Read	$t_{\text{RHDX}}$	0		ns	
Data Float After Read	$t_{\text{RHDZ}}$		$t_{\text{CLCL}}-5$	ns	$t_{\text{MCS}}=0$
			$2t_{\text{CLCL}}-5$		$t_{\text{MCS}}>0$
ALE Low to Valid Data In	$t_{\text{LLDV}}$		$2.5t_{\text{CLCL}}-27$	ns	$t_{\text{MCS}}=0$
			$1.5t_{\text{CLCL}}-28+t_{\text{MCS}}$		$t_{\text{MCS}}>0$
Port 0 Address to Valid Data In	$t_{\text{AVDV1}}$		$3t_{\text{CLCL}}-27$	ns	$t_{\text{MCS}}=0$
			$2t_{\text{CLCL}}-31+t_{\text{MCS}}$		$t_{\text{MCS}}>0$
Port 2 Address to Valid Data In	$t_{\text{AVDV2}}$		$3.5t_{\text{CLCL}}-32$	ns	$t_{\text{MCS}}=0$
			$2.5t_{\text{CLCL}}-34+t_{\text{MCS}}$		$t_{\text{MCS}}>0$
ALE Low to $\overline{\text{RD}}$ or $\overline{\text{WR}}$ Low	$t_{\text{LLWL}}$	$0.5t_{\text{CLCL}}-8$	$0.5t_{\text{CLCL}}+6$	ns	$t_{\text{MCS}}=0$
		$1.5t_{\text{CLCL}}-7$	$1.5t_{\text{CLCL}}+8$		$t_{\text{MCS}}>0$
Port 0 Address Valid to $\overline{\text{RD}}$ or $\overline{\text{WR}}$ Low	$t_{\text{AVWL1}}$		$t_{\text{CLCL}}-11$	ns	$t_{\text{MCS}}=0$
			$2t_{\text{CLCL}}-10$		$t_{\text{MCS}}>0$
Port 2 Address Valid to $\overline{\text{RD}}$ or $\overline{\text{WR}}$ Low	$t_{\text{AVWL2}}$		$1.5t_{\text{CLCL}}-9$	ns	$t_{\text{MCS}}=0$
			$2.5t_{\text{CLCL}}-13$		$t_{\text{MCS}}>0$
Data Valid to $\overline{\text{WR}}$ Transition	$t_{\text{QVWX}}$		-9	ns	$t_{\text{MCS}}=0$
			$t_{\text{CLCL}}-10$		$t_{\text{MCS}}>0$
Data Hold After Write	$t_{\text{WHQX}}$		$t_{\text{CLCL}}-12$	ns	$t_{\text{MCS}}=0$
			$2t_{\text{CLCL}}-7$		$t_{\text{MCS}}>0$
$\overline{\text{RD}}$ Low to Address Float	$t_{\text{RLAZ}}$		(Note 5)	ns	
$\overline{\text{RD}}$ or $\overline{\text{WR}}$ High to ALE High	$t_{\text{WHLH}}$	0	10	ns	$t_{\text{MCS}}=0$
		$t_{\text{CLCL}}-5$	$t_{\text{CLCL}}+11$		$t_{\text{MCS}}>0$

**Note:**  $t_{\text{MCS}}$  is a time period related to the Stretch memory cycle selection. The following table shows the value of  $t_{\text{MCS}}$  for each Stretch selection.

M2	M1	M0	MOVX CYCLES	$t_{\text{MCS}}$
0	0	0	2 machine cycles	0
0	0	1	3 machine cycles (default)	$4 t_{\text{CLCL}}$
0	1	0	4 machine cycles	$8 t_{\text{CLCL}}$
0	1	1	5 machine cycles	$12 t_{\text{CLCL}}$
1	0	0	6 machine cycles	$16 t_{\text{CLCL}}$
1	0	1	7 machine cycles	$20 t_{\text{CLCL}}$
1	1	0	8 machine cycles	$24 t_{\text{CLCL}}$
1	1	1	9 machine cycles	$28 t_{\text{CLCL}}$



**DC ELECTRICAL CHARACTERISTICS—DS80C323**

PARAMETER	SYMBOL	MIN	TYP	MAX	UNITS	NOTES
Operating Supply Voltage	$V_{CC}$	2.7	3.0	5.5	V	1
Power-Fail Warning Voltage	$V_{PFW}$	2.6	2.7	2.8	V	1
Minimum Operating Voltage	$V_{RST}$	2.5	2.6	2.7	V	1, 12
Supply Current Active Mode at 18MHz	$I_{CC}$		10		mA	2
Supply Current Idle Mode at 18MHz	$I_{IDLE}$		6		mA	3
Supply Current Stop Mode, Bandgap Reference Disabled	$I_{STOP}$		0.1		$\mu$ A	2
Supply Current Stop Mode, Bandgap Reference Enabled	$I_{SPBG}$		40		$\mu$ A	4, 10
Input Low Level	$V_{IL}$	-0.3		$+0.2 \times V_{CC}$	V	1
Input High Level (Except XTAL1 and RST)	$V_{IH1}$	$0.7 \times V_{CC}$		$V_{CC}+0.3$	V	1
Input High Level XTAL1 and RST	$V_{IH2}$	$0.7 \times V_{CC}$ $+0.25V$		$V_{CC}+0.3$	V	1
Output Low Voltage Ports 1, 3 at $I_{OL} = 1.6mA$	$V_{OL1}$			0.4	V	1
Output Low Voltage Ports 0, 2, PSEN /ALE at $I_{OL} = 3.2mA$	$V_{OL2}$			0.4	V	1, 5
Output High Voltage Ports 1, 3, PSEN /ALE at $I_{OH} = -15\mu A$	$V_{OH1}$	$V_{DD}$ -0.4V			V	1, 6
Output High Voltage Ports 1, 3 at $I_{OH} = -1.5mA$	$V_{OH2}$	$V_{DD}$ -0.4V			V	1, 7
Output High Voltage Ports 0, 2, PSEN /ALE at $I_{OH} = -2mA$	$V_{OH3}$	$V_{DD}$ -0.4V			V	1, 5
Input Low Current Ports 1, 3 at 0.45V	$I_{IL}$			-30	$\mu$ A	11
Transition Current from 1 $\geq$ 0, Ports 1, 3 at 2V	$I_{TL}$			-400	$\mu$ A	8
Input Leakage Port 0, Bus Mode	$I_L$	-300		+300	$\mu$ A	9
RST Pulldown Resistance	$R_{RST}$	50		170	k $\Omega$	

**NOTES FOR DS80C323 DC ELECTRICAL CHARACTERISTICS**

All parameters apply to both commercial and industrial temperature operation unless otherwise noted. Specifications to  $-40^{\circ}C$  are guaranteed by design and are not production tested. Device operating range is 2.7V to 5.5V. DC electrical specifications are for operation 2.7V to 3.3V.

1. All voltages are referenced to ground.
2. Active mode current is measured with an 18MHz clock source driving XTAL1,  $V_{CC} = RST = 3.3V$ , all other pins disconnected.
3. Idle mode current is measured with an 18MHz clock source driving XTAL1,  $V_{CC} = 3.3V$ , all other pins disconnected.
4. Stop mode current measured with XTAL1 and RST grounded,  $V_{CC} = 3.3V$ , all other pins disconnected.
5. When addressing external memory. This specification only applies to the first clock cycle following the transition.

**NOTES FOR DS80C323 DC ELECTRICAL CHARACTERISTICS (continued)**

*All parameters apply to both commercial and industrial temperature operation unless otherwise noted. Specifications to -40°C are guaranteed by design and are not production tested. Device operating range is 2.7V to 5.5V. DC electrical specifications are for operation 2.7V to 3.3V.*

6.  $V_{RST} = V_{CC}$ . This condition mimics operation of pins in I/O mode.
7. During a 0-to-1 transition, a one-shot drives the ports hard for two clock cycles. This measurement reflects port in transition mode.
8. Ports 1, 2, and 3 source transition current when being pulled down externally. It reaches its maximum at approximately 2V.
9.  $V_{IN}$  between ground and  $V_{CC} - 0.3V$ . Not a high-impedance input. This port is a weak address latch because Port 0 is dedicated as an address bus on the DS80C323. Peak current occurs near the input transition point of the latch, approximately 2V.
10. Over the industrial temperature range, this specification has a maximum value of 200 $\mu$ A.
11. This is the current from an external circuit to hold a logic low level on an I/O pin while the corresponding port latch bit is set to 1. This is only the current required to *hold* the low level; transitions from 1 to 0 on an I/O pin will also have to overcome the transition current.
12. Device operating range is 2.7V to 5.5V, however device is tested to 2.5V to ensure proper operation at minimum  $V_{RST}$ .

**AC ELECTRICAL CHARACTERISTICS—DS80C323**

PARAMETER		SYMBOL	18 MHz		VARIABLE CLOCK		UNITS
			MIN	MAX	MIN	MAX	
Oscillator Frequency	External Oscillator	$1/t_{CLCL}$	0	18	0	18	MHz
	External Crystal		1	18	1	18	
ALE Pulse Width		$t_{LHLL}$	68		$1.5t_{CLCL}-15$		ns
Port 0 Address Valid to ALE Low		$t_{AVLL}$	16		$0.5t_{CLCL}-11$		ns
Address Hold After ALE Low		$t_{LLAX1}$	6	(Note 5)	$0.25t_{CLCL}-8$	(Note 5)	ns
Address Hold After ALE Low for MOVX $\overline{WR}$		$t_{LLAX2}$	14		$0.5t_{CLCL}-13$		ns
ALE Low to Valid Instruction In		$t_{LLIV}$		93		$2.5t_{CLCL}-46$	ns
ALE Low to $\overline{PSEN}$ Low		$t_{LLPL}$	4		$0.25t_{CLCL}-10$		ns
$\overline{PSEN}$ Pulse Width		$t_{PLPH}$	118		$2.25t_{CLCL}-7$		ns
$\overline{PSEN}$ Low to Valid Instruction In		$t_{PLIV}$		87		$2.25t_{CLCL}-38$	ns
Input Instruction Hold After $\overline{PSEN}$		$t_{PXIX}$	0		0		ns
Input Instruction Float After $\overline{PSEN}$		$t_{PXIZ}$		51		$t_{CLCL}-5$	ns
Port 0 Address to Valid Instruction In		$t_{AVIV1}$		128		$3t_{CLCL}-39$	ns
Port 2 Address to Valid Instruction In		$t_{AVIV2}$		139		$3.5t_{CLCL}-56$	ns
$\overline{PSEN}$ Low to Address Float		$t_{PLAZ}$		(Note 5)		(Note 5)	ns

**NOTES FOR DS80C323 AC ELECTRICAL CHARACTERISTICS**

All parameters apply to both commercial and industrial temperature operation unless otherwise noted. Specifications to  $-40^{\circ}\text{C}$  are guaranteed by design and are not production tested. AC electrical characteristics assume 50% duty cycle for the oscillator, oscillator frequency > 16MHz, and are not 100% production tested, but are guaranteed by design.

1. All signals rated over operating temperature at 18MHz.
2. All signals characterized with load capacitance of 80pF except Port 0, ALE,  $\overline{PSEN}$ ,  $\overline{RD}$ , and  $\overline{WR}$  at 100pF. Note that loading should be approximately equal for valid timing.
3. Interfacing to memory devices with float times (turn off times) over 35ns may cause contention. This will not damage the parts, but will cause an increase in operating current.
4. Specifications assume a 50% duty cycle for the oscillator. Port 2 timing will change with the duty cycle variations.
5. Address is held in a weak latch until over-driven by external memory.

**MOVX CHARACTERISTICS—DS80C323**

PARAMETER	SYMBOL	VARIABLE CLOCK		UNITS	STRETCH
		MIN	MAX		
$\overline{\text{RD}}$ Pulse Width	$t_{\text{RLRH}}$	$2t_{\text{CLCL}}-11$		ns	$t_{\text{MCS}}=0$
		$t_{\text{MCS}}-11$			$t_{\text{MCS}}>0$
$\overline{\text{WR}}$ Pulse Width	$t_{\text{WLWH}}$	$2t_{\text{CLCL}}-11$		ns	$t_{\text{MCS}}=0$
		$t_{\text{MCS}}-11$			$t_{\text{MCS}}>0$
$\overline{\text{RD}}$ Low to Valid Data In	$t_{\text{RLDV}}$		$2t_{\text{CLCL}}-32$	ns	$t_{\text{MCS}}=0$
			$t_{\text{MCS}}-36$		$t_{\text{MCS}}>0$
Data Hold After Read	$t_{\text{RHDX}}$	0		ns	
Data Float After Read	$t_{\text{RHDZ}}$		$t_{\text{CLCL}}-5$	ns	$t_{\text{MCS}}=0$
			$2t_{\text{CLCL}}-7$		$t_{\text{MCS}}>0$
ALE Low to Valid Data In	$t_{\text{LLDV}}$		$2.5t_{\text{CLCL}}-43$	ns	$t_{\text{MCS}}=0$
			$1.5t_{\text{CLCL}}-45+t_{\text{MCS}}$		$t_{\text{MCS}}>0$
Port 0 Address to Valid Data In	$t_{\text{AVDV1}}$		$3t_{\text{CLCL}}-40$	ns	$t_{\text{MCS}}=0$
			$2t_{\text{CLCL}}-42+t_{\text{MCS}}$		$t_{\text{MCS}}>0$
Port 2 Address to Valid Data In	$t_{\text{AVDV2}}$		$3.5t_{\text{CLCL}}-58$	ns	$t_{\text{MCS}}=0$
			$2.5t_{\text{CLCL}}-59+t_{\text{MCS}}$		$t_{\text{MCS}}>0$
ALE Low to $\overline{\text{RD}}$ or $\overline{\text{WR}}$ Low	$t_{\text{LLWL}}$	$0.5t_{\text{CLCL}}-18$	$0.5t_{\text{CLCL}}+7$	ns	$t_{\text{MCS}}=0$
		$1.5t_{\text{CLCL}}-11$	$1.5t_{\text{CLCL}}+8$		$t_{\text{MCS}}>0$
Port 0 Address Valid to $\overline{\text{RD}}$ or $\overline{\text{WR}}$ Low	$t_{\text{AVWL1}}$	$t_{\text{CLCL}}-10$		ns	$t_{\text{MCS}}=0$
		$2t_{\text{CLCL}}-10$			$t_{\text{MCS}}>0$
Port 2 Address Valid to $\overline{\text{RD}}$ or $\overline{\text{WR}}$ Low	$t_{\text{AVWL2}}$	$1.5t_{\text{CLCL}}-27$		ns	$t_{\text{MCS}}=0$
		$2.5t_{\text{CLCL}}-25$			$t_{\text{MCS}}>0$
Data Valid to $\overline{\text{WR}}$ Transition	$t_{\text{QVWX}}$	-14		ns	$t_{\text{MCS}}=0$
		$t_{\text{CLCL}}-13$			$t_{\text{MCS}}>0$
Data Hold After Write	$t_{\text{WHQX}}$	$t_{\text{CLCL}}-15$		ns	$t_{\text{MCS}}=0$
		$2t_{\text{CLCL}}-13$			$t_{\text{MCS}}>0$
$\overline{\text{RD}}$ Low to Address Float	$t_{\text{RLAZ}}$		(Note 5)	ns	
$\overline{\text{RD}}$ or $\overline{\text{WR}}$ High to ALE High	$t_{\text{WHLH}}$	-1	14	ns	$t_{\text{MCS}}=0$
		$t_{\text{CLCL}}-5$	$t_{\text{CLCL}}+16$		$t_{\text{MCS}}>0$

**Note:**  $t_{\text{MCS}}$  is a time period related to the Stretch memory cycle selection. The following table shows the value of  $t_{\text{MCS}}$  for each Stretch selection.

M2	M1	M0	MOVX CYCLES	$t_{\text{MCS}}$
0	0	0	2 machine cycles	0
0	0	1	3 machine cycles (default)	$4 t_{\text{CLCL}}$
0	1	0	4 machine cycles	$8 t_{\text{CLCL}}$
0	1	1	5 machine cycles	$12 t_{\text{CLCL}}$
1	0	0	6 machine cycles	$16 t_{\text{CLCL}}$
1	0	1	7 machine cycles	$20 t_{\text{CLCL}}$
1	1	0	8 machine cycles	$24 t_{\text{CLCL}}$
1	1	1	9 machine cycles	$28 t_{\text{CLCL}}$

**EXTERNAL CLOCK CHARACTERISTICS**

PARAMETER	SYMBOL	MIN	TYP	MAX	UNITS
Clock High Time	$t_{CHCX}$	10			ns
Clock Low Time	$t_{CLCX}$	10			ns
Clock Rise Time	$t_{CLCH}$			5	ns
Clock Fall Time	$t_{CHCL}$			5	ns

**SERIAL PORT MODE 0 TIMING CHARACTERISTICS**

PARAMETER	SYMBOL	CONDITIONS	MIN	TYP	MAX	UNITS
Serial Port Clock Cycle Time	$t_{XLXL}$	SM2 = 0; 12 clocks per cycle		$12t_{CLCL}$		ns
		SM2 = 1; 4 clocks per cycle		$4t_{CLCL}$		
Output Data Setup to Clock Rising Edge	$t_{QVXH}$	SM2 = 0 12 clocks per cycle		$10t_{CLCL}$		ns
		SM2 = 1; 4 clocks per cycle		$3t_{CLCL}$		
Output Data Hold from Clock Rising	$t_{XHQX}$	SM2 = 0 12 clocks per cycle		$2t_{CLCL}$		ns
		SM2 = 1; 4 clocks per cycle		$t_{CLCL}$		
Input Data Hold After Clock Rising	$t_{XHDX}$	SM2 = 0; 12 clocks per cycle		$t_{CLCL}$		ns
		SM2 = 1; 4 clocks per cycle		$t_{CLCL}$		
Clock Rising Edge to Input Data Valid	$t_{XHdv}$	SM2 = 0; 12 clocks per cycle		$11t_{CLCL}$		ns
		SM2 = 1 4 clocks per cycle		$2t_{CLCL}$		

**EXPLANATION OF AC SYMBOLS**

In an effort to remain compatible with the original 8051 family, this device specifies the same parameter as such devices, using the same symbols. For completeness, the following is an explanation of the symbols.

t	Time	Q	Output data
A	Address	R	$\overline{RD}$ signal
C	Clock	V	Valid
D	Input data	W	$\overline{WR}$ signal
H	Logic level high	X	No longer a valid logic level
L	Logic level low	Z	Tri-state
I	Instruction		
P	$\overline{PSEN}$		

### POWER-CYCLE TIMING CHARACTERISTICS

PARAMETER	SYMBOL	MIN	TYP	MAX	UNITS	NOTES
Crystal Startup Time	$t_{CSU}$		1.8		ms	1
Power-On Reset Delay	$t_{POR}$			65,536	$t_{CLCL}$	2

### NOTES FOR POWER CYCLE TIMING CHARACTERISTICS

- Startup time for crystals varies with load capacitance and manufacturer. Time shown is for an 11.0592MHz crystal manufactured by Fox crystal.
- Reset delay is a synchronous counter of crystal oscillations after crystal startup. Counting begins when the level on the XTAL1 input meets the  $V_{IH2}$  criteria. At 25MHz, this time is 2.62ms.

### PROGRAM MEMORY READ CYCLE



### DATA MEMORY READ CYCLE



### DATA MEMORY WRITE CYCLE

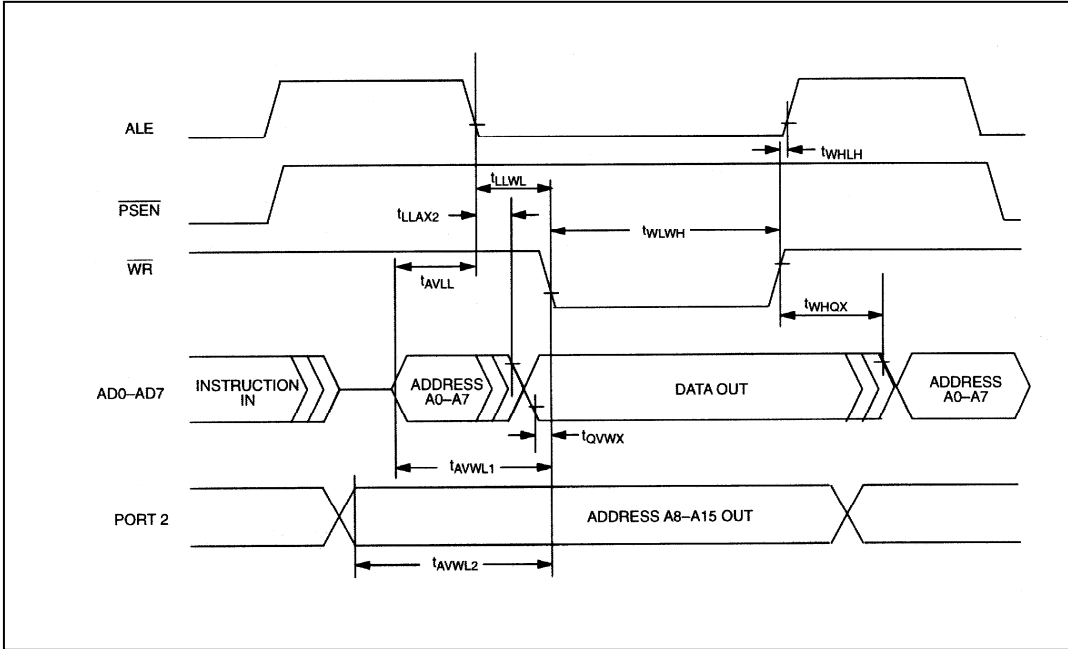

### DATA MEMORY WRITE WITH STRETCH = 1

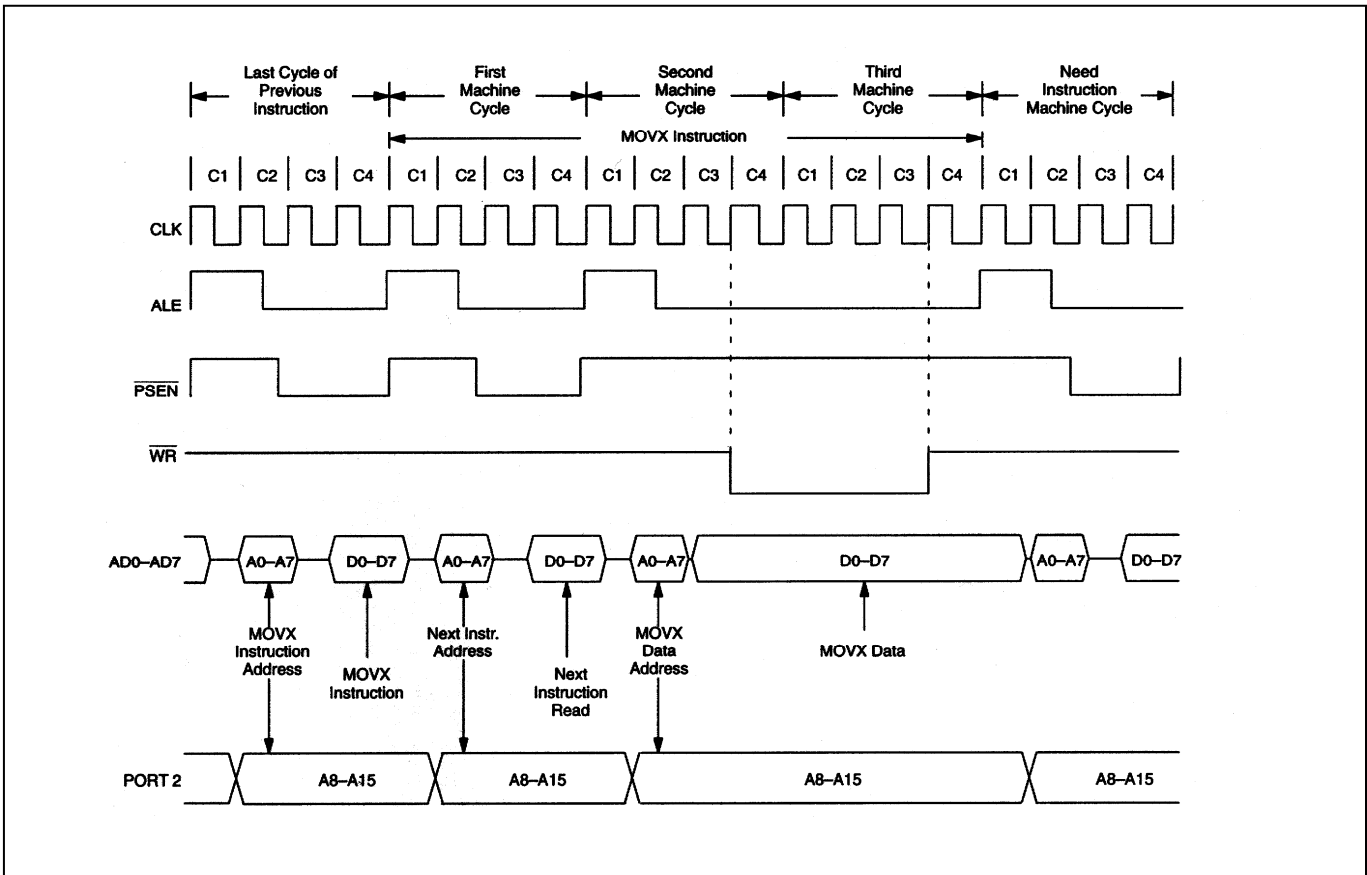



**DATA MEMORY WRITE WITH STRETCH = 2**



**EXTERNAL CLOCK DRIVE**



### SERIAL PORT MODE 0 TIMING

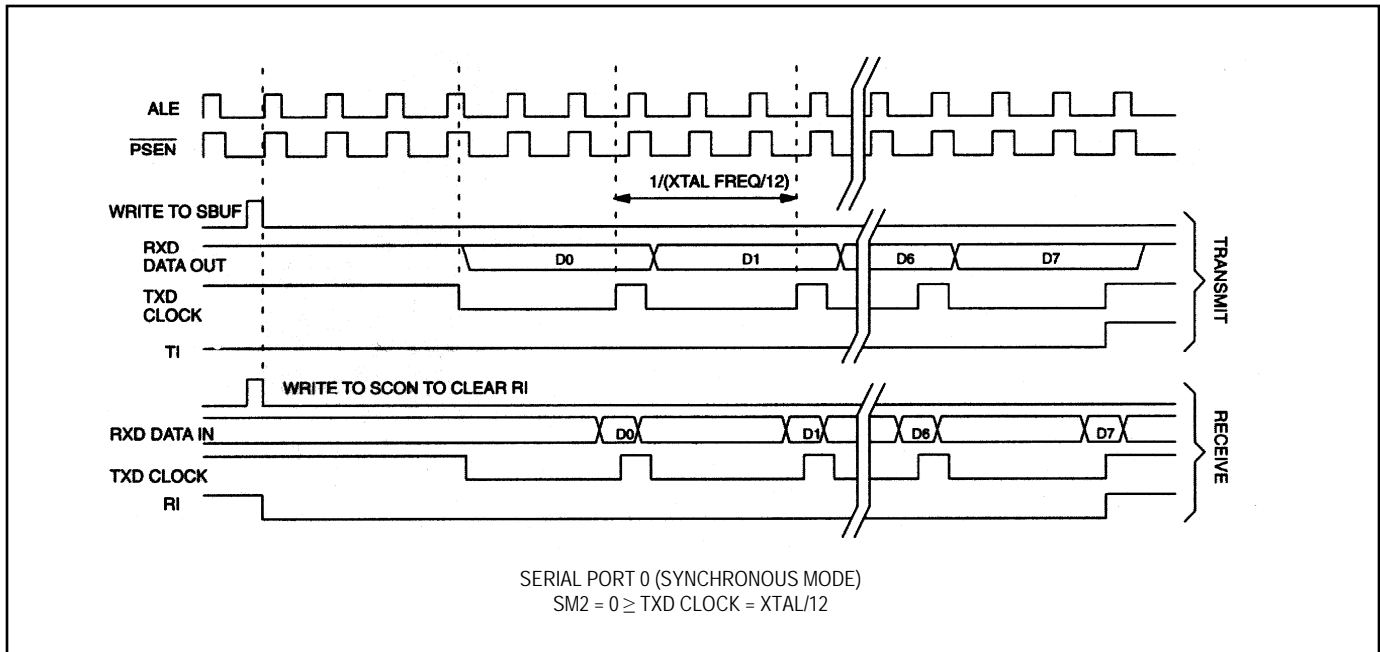
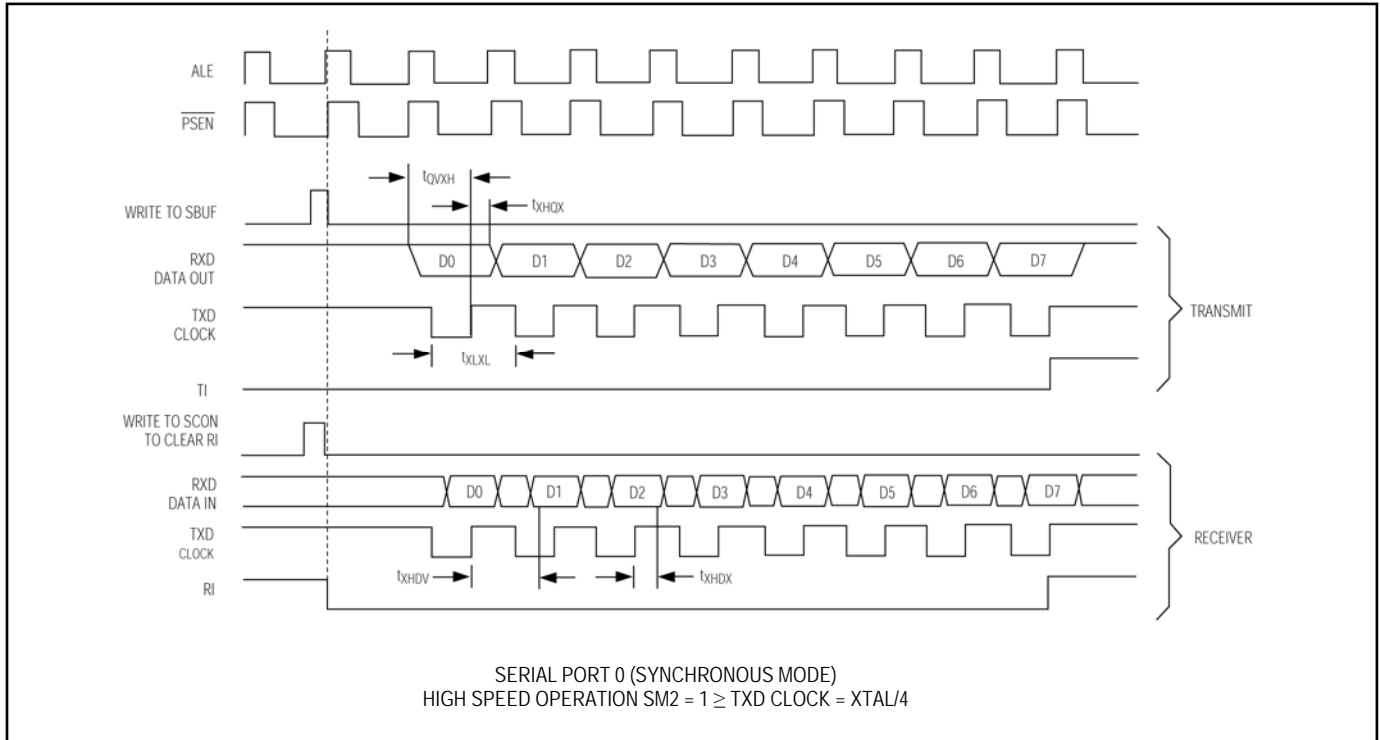

### POWER-CYCLE TIMING



## PACKAGE INFORMATION

For the latest package outline information and land patterns, go to [www.maxim-ic.com/packages](http://www.maxim-ic.com/packages).

PACKAGE TYPE	PACKAGE CODE	DOCUMENT NO.
44 TQFP	C44+2	<a href="#">21-0293</a>
44 MQFP	M44+10	<a href="#">21-0269</a>
44 MQFP	M44+5	<a href="#">21-0826</a>
40 PDIP	P40+1	<a href="#">21-0044</a>
44 PLCC	Q44+1	<a href="#">21-0049</a>

## DATA SHEET REVISION SUMMARY

*The following represent the key differences between the 101006 and 070505 version of the DS80C320/DS80C323 data sheet. Please review this summary carefully.*

1. Deleted DS80C323-MND from Ordering Information table (page 2). Device was never manufactured.

*The following represent the key differences between the 070505 and 051804 version of the DS80C320/DS80C323 data sheet. Please review this summary carefully.*

2. Added Pb-free/RoHS-compliant part numbers to Ordering Information table.
3. Deleted the “A” from the IPC/JEDEC J-STD-020 specification in the Absolute Maximum Ratings.

*The following represent the key differences between the 051804 and the 112299 version of the DS80C320/DS80C323 data sheet. Please review this summary carefully.*

1. Removed “Preliminary” status as a result of final characterization.
2. Added industrial temperature DS80C323 devices to ordering information.
3. Updated soldering temperature specification to reflect JEDEC standards.
4. Updated the following DS80C323 AC timing parameters with final characterization data:  $t_{LHLL}$ ,  $t_{LLAX1}$ ,  $t_{LLAX2}$ ,  $t_{LLAX2}$ ,  $t_{LLIV}$ ,  $t_{LLPL}$ ,  $t_{PLIV}$ ,  $t_{AVIV1}$ ,  $t_{RLDV}$ ,  $t_{RHDZ}$ ,  $t_{LLDV}$ ,  $t_{AVDV1}$ ,  $t_{AVDV2}$ ,  $t_{LLWL}$ ,  $t_{AVWL1}$ ,  $t_{AVWL2}$ ,  $t_{QVWX}$ ,  $t_{WHQX}$ ,  $t_{WHLH}$ .
5. Updated the following DS80C320 AC timing parameters with final characterization data:  $t_{WHQX}$ ,  $t_{LHLL}$ ,  $t_{LLAX2}$ ,  $t_{LLDV}$ ,  $t_{AVDV1}$ ,  $t_{LLWL}$ ,  $t_{AVWL1}$ ,  $t_{AVWL2}$ .
6. Added note advising the need to reset watchdog timer before setting the Stop bit.
7. Added note clarifying drive strength of P0, P2, ALE, PSEN.
8. Obsoleted DS80C320 25MHz AC timing tables; merged into 33MHz AC timing tables.
9. Corrected Serial Port Mode 0 Timing diagrams to show correct order of D6, D7.

*The following represent the key differences between the 041896 and the 052799 version of the DS80C320 data sheet. Please review this summary carefully.*

1. Corrected  $V_{CC}$  pin description to show DS80C323 operation at +3V.
2. Corrected Timed Access description to show three-cycle window.
3. Modified absolute Maximum Ratings for any pin relative to around,  $V_{CC}$  relative to ground.
4. Changed minimum oscillator frequency to 1MHz when using external crystal.
5. Clarified that  $t_{POR}$  begins when XTAL1 reaches  $V_{IH2}$ .

*The following represent the key differences between the 103196 and the 041896 version of the DS80C320 data sheet. Please review this summary carefully.*

1. Updated DS80C320 25MHz AC Characteristics.

*The following represent the key differences between the 041895 and the 031096 version of the DS80C320 data sheet. Please review this summary carefully.*

1. Remove Port 0, Port 2 from  $V_{OH1}$  specification (PCN B60802).
2.  $V_{OH1}$  test specification clarified (RST =  $V_{CC}$ ).
3. Add  $t_{AVWL2}$  marking to External Memory Read Cycle figure.
4. Correct TQFP drawing to read 44-pin TQFP.
5. Rotate page 1 TQFP illustration to match assembly specifications.

*The following represent the key differences between the 031096 and the 052296 version of the DS80C320 data sheet. Please review this summary carefully.*

1. Added *Data Sheet Revision Summary* section.

*The following represent the key differences between 05/23/96 and 05/22/96 version of the DS80C320 data sheet and between 05/23/96 and 03/27/95 version of the DS80C323 data sheet. Please review this summary carefully.*

### DS80C320:

1. Add DS80C323 Characteristics.
2. Change DS80C320  $V_{PFW}$  specification from 4.5V to 4.55V (PCN E62802).
3. Update DS80C320 33MHz AC Characteristics.

### DS80C323:

1. Delete Data Sheet. Contents moved to DS80C320/DS80C323.

## DATA SHEET REVISION SUMMARY (continued)

*The following represent the key differences between the 05/22/96 and the 10/21/97 version of the DS80C320 data sheet. Please review this summary carefully.*

### DS80C320

1. Added note to clarify  $I_{IL}$  specification.
2. Added note to clarify AC timing conditions.
3. Corrected erroneous  $t_{QVXL}$  label on figure “Serial Port Mode 0 Timing” to read  $t_{QVXH}$ .
4. Added note to prevent accidental corruption of Watchdog Timer count while changing counter length.

### DS80C323

1. Added note to clarify  $I_{IL}$  specification.
2. Remove port 2 from  $V_{OH1}$  specification, add port 3.
3.  $I_{OH}$  for  $V_{OH3}$  specification changed from -3mA to -2mA.
4. Added note to clarify AC timing conditions.

Компания «Океан Электроники» предлагает заключение долгосрочных отношений при поставках импортных электронных компонентов на взаимовыгодных условиях!

Наши преимущества:

- Поставка оригинальных импортных электронных компонентов напрямую с производств Америки, Европы и Азии, а так же с крупнейших складов мира;
- Широкая линейка поставок активных и пассивных импортных электронных компонентов (более 30 млн. наименований);
- Поставка сложных, дефицитных, либо снятых с производства позиций;
- Оперативные сроки поставки под заказ (от 5 рабочих дней);
- Экспресс доставка в любую точку России;
- Помощь Конструкторского Отдела и консультации квалифицированных инженеров;
- Техническая поддержка проекта, помощь в подборе аналогов, поставка прототипов;
- Поставка электронных компонентов под контролем ВП;
- Система менеджмента качества сертифицирована по Международному стандарту ISO 9001;
- При необходимости вся продукция военного и аэрокосмического назначения проходит испытания и сертификацию в лаборатории (по согласованию с заказчиком);
- Поставка специализированных компонентов военного и аэрокосмического уровня качества (Xilinx, Altera, Analog Devices, Intersil, Interpoint, Microsemi, Actel, Aeroflex, Peregrine, VPT, Syfer, Eurofarad, Texas Instruments, MS Kennedy, Miteq, Cobham, E2V, MA-COM, Hittite, Mini-Circuits, General Dynamics и др.);

Компания «Океан Электроники» является официальным дистрибьютором и эксклюзивным представителем в России одного из крупнейших производителей разъемов военного и аэрокосмического назначения «JONHON», а так же официальным дистрибьютором и эксклюзивным представителем в России производителя высокотехнологичных и надежных решений для передачи СВЧ сигналов «FORSTAR».



## JONHON

«JONHON» (основан в 1970 г.)

Разъемы специального, военного и аэрокосмического назначения:

(Применяются в военной, авиационной, аэрокосмической, морской, железнодорожной, горно- и нефтедобывающей отраслях промышленности)

«FORSTAR» (основан в 1998 г.)

ВЧ соединители, коаксиальные кабели,  
кабельные сборки и микроволновые компоненты:

(Применяются в телекоммуникациях гражданского и специального назначения, в средствах связи, РЛС, а так же военной, авиационной и аэрокосмической отраслях промышленности).



Телефон: 8 (812) 309-75-97 (многоканальный)

Факс: 8 (812) 320-03-32

Электронная почта: [ocean@oceanchips.ru](mailto:ocean@oceanchips.ru)

Web: <http://oceanchips.ru/>

Адрес: 198099, г. Санкт-Петербург, ул. Калинина, д. 2, корп. 4, лит. А