

CUSTOMER DRAWING



**FREE CONNECTOR
(HELIOS H4 ASSEMBLED)**



**FIXED CONNECTOR
(HELIOS H4 BULKHEAD - M12)**



**FIXED CONNECTOR
(HELIOS H4 BULKHEAD - M14)**

3. SPECIFICATIONS:

CONTACT SIZE	1.5mm ² /16AWG	2.5mm ² /14AWG	4mm ² /12AWG	6mm ² /10AWG	10mm ² /8AWG
RATED CURRENT	35A (UL)				
	N/A	32A (TUV)	40A (TUV)	44A (TUV)	65A (TUV)
RATED SYSTEM VOLTAGE	600V/1000V DC(UL) 1000V DC(TUV)				
CONTACT RESISTANCE	0.25mΩ TYP.				
DEGREE OF PROTECTION, MATED	IP68(1m, 1h)				
PIN CONTACT MATERIAL	COPPER, TIN PLATED				
INSULATION MATERIAL	THERMOPLASTIC, UL94 V-0				
AMBIENT TEMPERATURE RANGE	-40°C TO +85°C				
STRIP LENGTH	7.0 mm				
CABLE JACKET DIAMETER	4.5 TO 7.8mm FOR TUV 1000V RATING				
	5.25 TO 7.7mm FOR UL 1000V RATING				
	5.25 TO 7.95mm FOR UL 600V RATING				

2. USE ONLY CRIMP TOOL AMPHENOL H4TC0002 TO CRIMP CONTACTS

1. THIS ASSEMBLY SHALL BE CERTIFIED RoHS COMPLIANT TO THE EUROPEAN UNION DIRECTIVE 2002/95/EC AS AMENDED PER 2005/618/EC.

NOTES:

THE USE OF THIS DOCUMENT IS UNLIMITED. HOWEVER, DOCUMENTS REFERENCED HEREON MAY CONTAIN LIMITED RIGHTS DATA.

N/A	PRO/ENGINEER INFORMATION
N/A	Pro/e Model Used: CPV-090508-M-ASSEM
N/A	Drawing Name: PV-1005X-000-SF-CUS
N/A	NEXT ASSEMBLY

UNLESS OTHERWISE SPECIFIED	SPECIFICATIONS	POS	QTY	PART NUMBER	DESCRIPTION	NOTE																																					
LINEAR DIMENSIONS ARE IN: MILLIMETERS TOLERANCES: ANGLES = ±2°	MATERIAL SPEC.	PARTS LIST																																									
	N/A	<table border="1"> <tr> <td colspan="2">APPROVALS</td> <td>DATE</td> <td colspan="3" rowspan="4"> AMPHENOL CORPORATION 40-60 DELAWARE AVENUE SYDNEY, N.Y. 13838 </td> </tr> <tr> <td>PREPARED BY</td> <td>LEON LI</td> </tr> <tr> <td>ENGINEER IN CHARGE</td> <td></td> </tr> <tr> <td>DESIGN MANAGER</td> <td>2012-05-23</td> </tr> <tr> <td colspan="2">PROCESS SPEC.</td> <td colspan="3">THIRD ANGLE PROJECTION</td> <td colspan="2" rowspan="2"> HELIOS H4 1000V/600V CONNECTOR ASSEMBLY </td> </tr> <tr> <td>N/A</td> <td colspan="3"> <table border="1"> <tr> <td>SIZE</td> <td>CAGE CODE</td> <td>DOCUMENT NO.</td> <td>REV.</td> </tr> <tr> <td>C</td> <td>77820</td> <td>H4C-()</td> <td>E</td> </tr> </table> </td> </tr> <tr> <td colspan="2">LEGENDS: △ = FLAG NOTE CALL OUT REFERENCE ONLY</td> <td colspan="5">SCALE: 1.0 REF: - SHEET 1 OF 4</td> </tr> </table>					APPROVALS		DATE	AMPHENOL CORPORATION 40-60 DELAWARE AVENUE SYDNEY, N.Y. 13838			PREPARED BY	LEON LI	ENGINEER IN CHARGE		DESIGN MANAGER	2012-05-23	PROCESS SPEC.		THIRD ANGLE PROJECTION			HELIOS H4 1000V/600V CONNECTOR ASSEMBLY		N/A	<table border="1"> <tr> <td>SIZE</td> <td>CAGE CODE</td> <td>DOCUMENT NO.</td> <td>REV.</td> </tr> <tr> <td>C</td> <td>77820</td> <td>H4C-()</td> <td>E</td> </tr> </table>			SIZE	CAGE CODE	DOCUMENT NO.	REV.	C	77820	H4C-()	E	LEGENDS: △ = FLAG NOTE CALL OUT REFERENCE ONLY		SCALE: 1.0 REF: - SHEET 1 OF 4			
APPROVALS		DATE	AMPHENOL CORPORATION 40-60 DELAWARE AVENUE SYDNEY, N.Y. 13838																																								
PREPARED BY	LEON LI																																										
ENGINEER IN CHARGE																																											
DESIGN MANAGER	2012-05-23																																										
PROCESS SPEC.		THIRD ANGLE PROJECTION			HELIOS H4 1000V/600V CONNECTOR ASSEMBLY																																						
N/A	<table border="1"> <tr> <td>SIZE</td> <td>CAGE CODE</td> <td>DOCUMENT NO.</td> <td>REV.</td> </tr> <tr> <td>C</td> <td>77820</td> <td>H4C-()</td> <td>E</td> </tr> </table>			SIZE			CAGE CODE	DOCUMENT NO.	REV.	C	77820	H4C-()	E																														
SIZE	CAGE CODE	DOCUMENT NO.	REV.																																								
C	77820	H4C-()	E																																								
LEGENDS: △ = FLAG NOTE CALL OUT REFERENCE ONLY		SCALE: 1.0 REF: - SHEET 1 OF 4																																									

**ORDER P/N:
H4CFC2DMS**

- (BLANK): COLD FORGING CONTACT
- S: STAMPING FORM CONTACT
- I: INDIVIDUAL PACKING WITH PE BAG (800PCS PER BOX)
- C: BULK PACK 100PCS WITH PE BAG (1000PCS PER BOX)
- M: BULK PACK 500PCS PER PE BAG (1000PCS PER BOX)
- D: TUV & UL APPROVAL
- 2: FOR 2.5mm²/14AWG CABLE (FOR C&F,
AND ALSO FOR 1.5 & 2.5mm²/16 & 14AWG S&F)
- 4: FOR 4.0mm²/12AWG CABLE (FOR C&F,
AND ALSO FOR 4.0 & 6.0mm²/12 & 10AWG S&F)
- 6: FOR 6.0mm²/10AWG CABLE (FOR C&F ONLY)
- 8: FOR 10.0mm²/8AWG CABLE (FOR C&F ONLY)
- C: CABLE GLAND (FREE CONN)
- M: BULKHEAD M12
- N: BULKHEAD M14
- F: FEMALE
- M: MALE

REVISIONS		
LTR	DESCRIPTION	DATE
A	INITIAL RELEASE	2011-04-18
B	MODIFY THE TOLERANCE	2011-12-05
C	ADD THE INTERFACE DIMENSION	2011-12-14
D	UPGRADE TO 1000V UL RATING	2012-03-20
E	UPDATE TUV MARK	2012-05-23

DOCUMENT NO. H4C-() SHEET 1 OF 4 REV. E

DOCUMENT NO. H4C-() SHEET 1 OF 4 REV. E

DOCUMENT NO. H4C-() SHEET 1 OF 4 REV. E

FREE CONNECTOR (HELIOS H4 ASSEMBLED)



FIXED CONNECTOR (HELIOS H4 BULKHEAD - M12)



FIXED CONNECTOR (HELIOS H4 BULKHEAD - M14)



- 5. THE MARK OF LETTERS JUST THE VERSION OF THE PLASTIC PARTS FOR AMPHENOL'S MANUFACTURE PROCEDURE, WHEN THE CUSTOMER INSPECT THE PRODUCT, THEY CAN IGNORE THESE NUMBERS.
- 4. FLAT GASKET AND NUT SHOULD NOT BE ASSEMBLED TO THE BODY . SOCKET AND PIN SHOWN INSTALLED FOR REFERENCE ONLY.

THE USE OF THIS DOCUMENT IS UNLIMITED. HOWEVER, DOCUMENTS REFERENCED HEREON MAY CONTAIN LIMITED RIGHTS DATA.

SIZE C	CAGE CODE 77820	DOCUMENT NO. H4C-()	REV. E
SCALE: 1.0	REF: -	SHEET 2 OF 4	

DOCUMENT NO. H4C-() REV. SHEET 2 OF 4

DOCUMENT NO. H4C-() REV. SHEET 2 OF 4

STAMPING & FORM CONTACT



SOCKET (FEMALE)



	A (mm)
1.5 & 2.5mm ²	4.8
4.0 & 6.0mm ²	5.8



PIN (MALE)



ORDER P/N FOR CONTACTS REEL & PACKING INFO

H4FF4R

- R: 2000PCS PER REEL
- 2: CABLE SIZE: 1.5 & 2.5mm²/16 & 14AWG
- 4: CABLE SIZE: 4.0 & 6.0mm²/12 & 10AWG
- F: FOR FEMALE
- M: FOR MALE
- F: STAMPING FORM CONTACTS

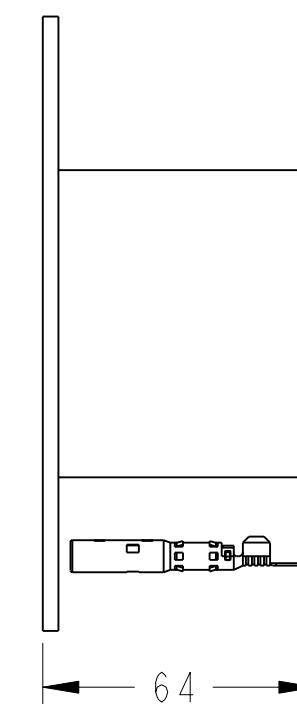
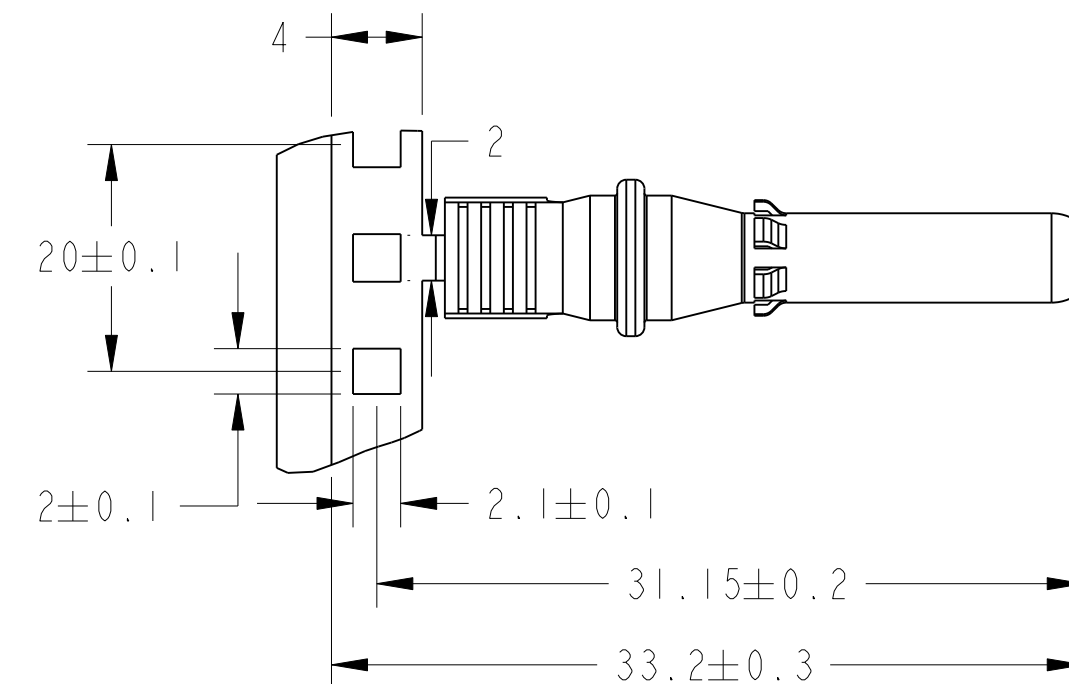
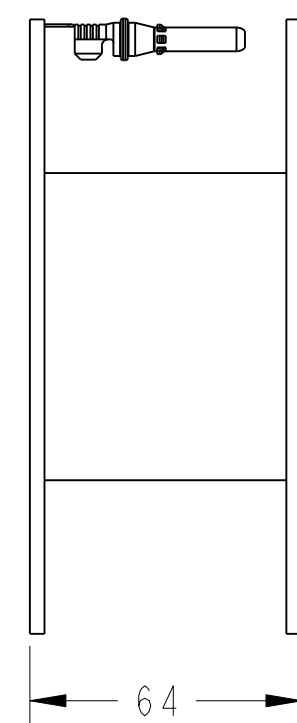

THE USE OF THIS DOCUMENT IS UNLIMITED. HOWEVER, DOCUMENTS REFERENCED HEREON MAY CONTAIN LIMITED RIGHTS DATA.

SIZE C	CAGE CODE 77820	DOCUMENT NO. H4C-()	REV. E
SCALE: 1.0	REF: -	SHEET 3 OF 4	

COLD FORGING CONTACT

DOCUMENT NO. H4C-()
SHEET 4 OF 4
REV. E

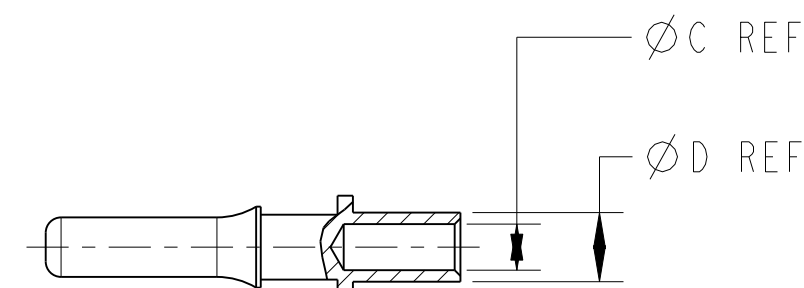
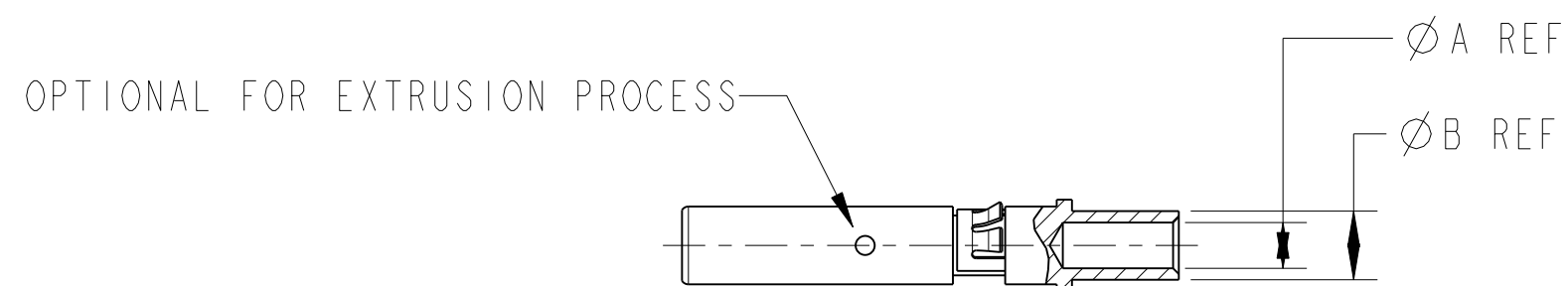
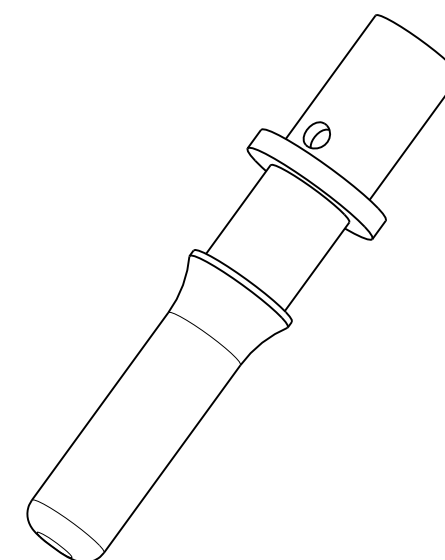
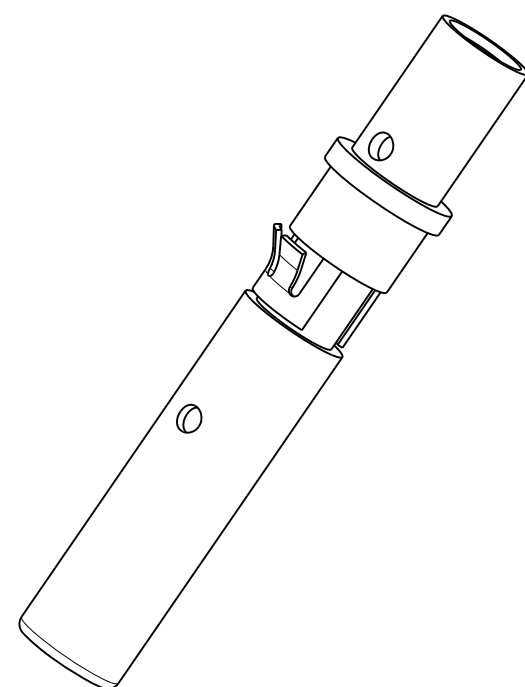

SOCKET (FEMALE)

PIN (MALE)

ACCEPT WIRE CONDUCTOR SIZE mm ² (AWG)	"A"	"B"
2.5 (14)	2.30	3.51
4.0 (12)	3.05	4.57
6.0 (10)	3.76	6.00
10.0(8)	4.50	6.00

ACCEPT WIRE CONDUCTOR SIZE mm ² (AWG)	"C"	"D"
2.5 (14)	2.30	3.51
4.0 (12)	3.05	4.57
6.0 (10)	3.76	6.00
10.0(8)	4.50	6.00

THE USE OF THIS DOCUMENT IS UNLIMITED.
HOWEVER, DOCUMENTS REFERENCED HEREON
MAY CONTAIN LIMITED RIGHTS DATA.

SIZE C	CAGE CODE 77820	DOCUMENT NO. H4C-()	REV. E
SCALE: 1.0	REF: -	SHEET 4 OF 4	

D
C
B
A
REV. E
SHEET 4 OF 4
DOCUMENT NO. H4C-()

Компания «Океан Электроники» предлагает заключение долгосрочных отношений при поставках импортных электронных компонентов на взаимовыгодных условиях!

Наши преимущества:

- Поставка оригинальных импортных электронных компонентов напрямую с производств Америки, Европы и Азии, а так же с крупнейших складов мира;
- Широкая линейка поставок активных и пассивных импортных электронных компонентов (более 30 млн. наименований);
- Поставка сложных, дефицитных, либо снятых с производства позиций;
- Оперативные сроки поставки под заказ (от 5 рабочих дней);
- Экспресс доставка в любую точку России;
- Помощь Конструкторского Отдела и консультации квалифицированных инженеров;
- Техническая поддержка проекта, помощь в подборе аналогов, поставка прототипов;
- Поставка электронных компонентов под контролем ВП;
- Система менеджмента качества сертифицирована по Международному стандарту ISO 9001;
- При необходимости вся продукция военного и аэрокосмического назначения проходит испытания и сертификацию в лаборатории (по согласованию с заказчиком);
- Поставка специализированных компонентов военного и аэрокосмического уровня качества (Xilinx, Altera, Analog Devices, Intersil, Interpoint, Microsemi, Actel, Aeroflex, Peregrine, VPT, Syfer, Eurofarad, Texas Instruments, MS Kennedy, Miteq, Cobham, E2V, MA-COM, Hittite, Mini-Circuits, General Dynamics и др.);

Компания «Океан Электроники» является официальным дистрибьютором и эксклюзивным представителем в России одного из крупнейших производителей разъемов военного и аэрокосмического назначения «JONHON», а так же официальным дистрибьютором и эксклюзивным представителем в России производителя высокотехнологичных и надежных решений для передачи СВЧ сигналов «FORSTAR».



JONHON

«JONHON» (основан в 1970 г.)

Разъемы специального, военного и аэрокосмического назначения:

(Применяются в военной, авиационной, аэрокосмической, морской, железнодорожной, горно- и нефтедобывающей отраслях промышленности)

«FORSTAR» (основан в 1998 г.)

ВЧ соединители, коаксиальные кабели, кабельные сборки и микроволновые компоненты:

(Применяются в телекоммуникациях гражданского и специального назначения, в средствах связи, РЛС, а так же военной, авиационной и аэрокосмической отраслях промышленности).



Телефон: 8 (812) 309-75-97 (многоканальный)

Факс: 8 (812) 320-03-32

Электронная почта: ocean@oceanchips.ru

Web: <http://oceanchips.ru/>

Адрес: 198099, г. Санкт-Петербург, ул. Калинина, д. 2, корп. 4, лит. А