

LW P473 binning FK0PN0

PointLED®

With a diameter of just 2 mm, the PointLED is one of the smallest packages in its class and achieves high luminous efficacies.

Due to its round and flat package, measuring only 0.775 mm high, it is ideal for application where space is a sensitive issue.



Applications

- Cluster, Button Backlighting
- Electronic Equipment
- Gaming, Amusement, Gambling
- Interior Illumination (e.g. Ambient Map)
- Transportation, Plane, Ship
- White Goods

Features:

- Package: white SMT package, colored diffused resin
- Chip technology: InGaN
- Typ. Radiation: 120° (Lambertian emitter)
- Color: Cx = 0.33, Cy = 0.33 acc. to CIE 1931 (• white)
- Corrosion Robustness Class: 3B
- ESD: 2 kV acc. to ANSI/ESDA/JEDEC JS-001 (HBM, Class 2)

Ordering Information

| Type | Luminous Intensity ¹⁾ $I_F = 10 \text{ mA}$ I_v | Mounting methode | Ordering Code |
|----------------------------|--|------------------|---------------|
| LW P473-Q2S1-FK0PN0-3B5A-F | 90 ... 224 mcd | Top | Q65112A1442 |
| LW P473-Q2S1-FK0PN0-3B5A | 90 ... 224 mcd | Reverse | Q65112A1443 |

Maximum Ratings

| Parameter | Symbol | | Values |
|--|-----------|------|--------|
| Operating Temperature | T_{op} | min. | -40 °C |
| | | max. | 100 °C |
| Storage Temperature | T_{stg} | min. | -40 °C |
| | | max. | 100 °C |
| Junction Temperature | T_j | max. | 110 °C |
| Forward Current $T_s = 25\text{ °C}$ | I_F | max. | 20 mA |
| Surge Current $t \leq 10\ \mu\text{s}$; $D = 0.005$; $T_s = 25\text{ °C}$ | I_{FS} | max. | 200 mA |
| Reverse voltage ²⁾ $T_s = 25\text{ °C}$ | V_R | max. | 5 V |
| ESD withstand voltage acc. to ANSI/ESDA/JEDEC JS-001 (HBM, Class 2) | V_{ESD} | | 2 kV |

Characteristics

$I_F = 10 \text{ mA}$; $T_s = 25 \text{ °C}$

| Parameter | Symbol | | Values |
|--|-------------------------|------|--------------------|
| Chromaticity Coordinate ³⁾ | C_x | typ. | 0.33 |
| | C_y | typ. | 0.33 |
| Viewing angle at 50 % I_v | 2ϕ | typ. | 120 ° |
| Forward Voltage ⁴⁾ $I_F = 10 \text{ mA}$ | V_F | min. | 2.70 V |
| | | typ. | 3.10 V |
| | | max. | 3.40 V |
| Reverse current ²⁾ $V_R = 5 \text{ V}$ | I_R | typ. | 0.01 μA |
| | | max. | 10 μA |
| Real thermal resistance junction/ambient ^{5), 6)} | $R_{thJA \text{ real}}$ | max. | 480 K / W |
| Real thermal resistance junction/solderpoint ⁵⁾ | $R_{thJS \text{ real}}$ | max. | 230 K / W |

Brightness Groups

| Group | Luminous Intensity ¹⁾ $I_F = 10 \text{ mA}$ min. I_v | Luminous Intensity ¹⁾ $I_F = 10 \text{ mA}$ max. I_v | Luminous Flux ⁷⁾ $I_F = 10 \text{ mA}$ typ. Φ_v |
|-------|--|--|--|
| Q2 | 90 mcd | 112 mcd | 303 mlm |
| R1 | 112 mcd | 140 mcd | 378 mlm |
| R2 | 140 mcd | 180 mcd | 480 mlm |
| S1 | 180 mcd | 224 mcd | 606 mlm |

Forward Voltage Groups

| Group | Forward Voltage ⁴⁾ $I_F = 10 \text{ mA}$ min. V_F | Forward Voltage ⁴⁾ $I_F = 10 \text{ mA}$ max. V_F |
|-------|---|---|
| 3B | 2.70 V | 2.90 V |
| 4A | 2.90 V | 3.05 V |
| 4B | 3.05 V | 3.20 V |
| 5A | 3.20 V | 3.40 V |

Chromaticity Coordinate Groups

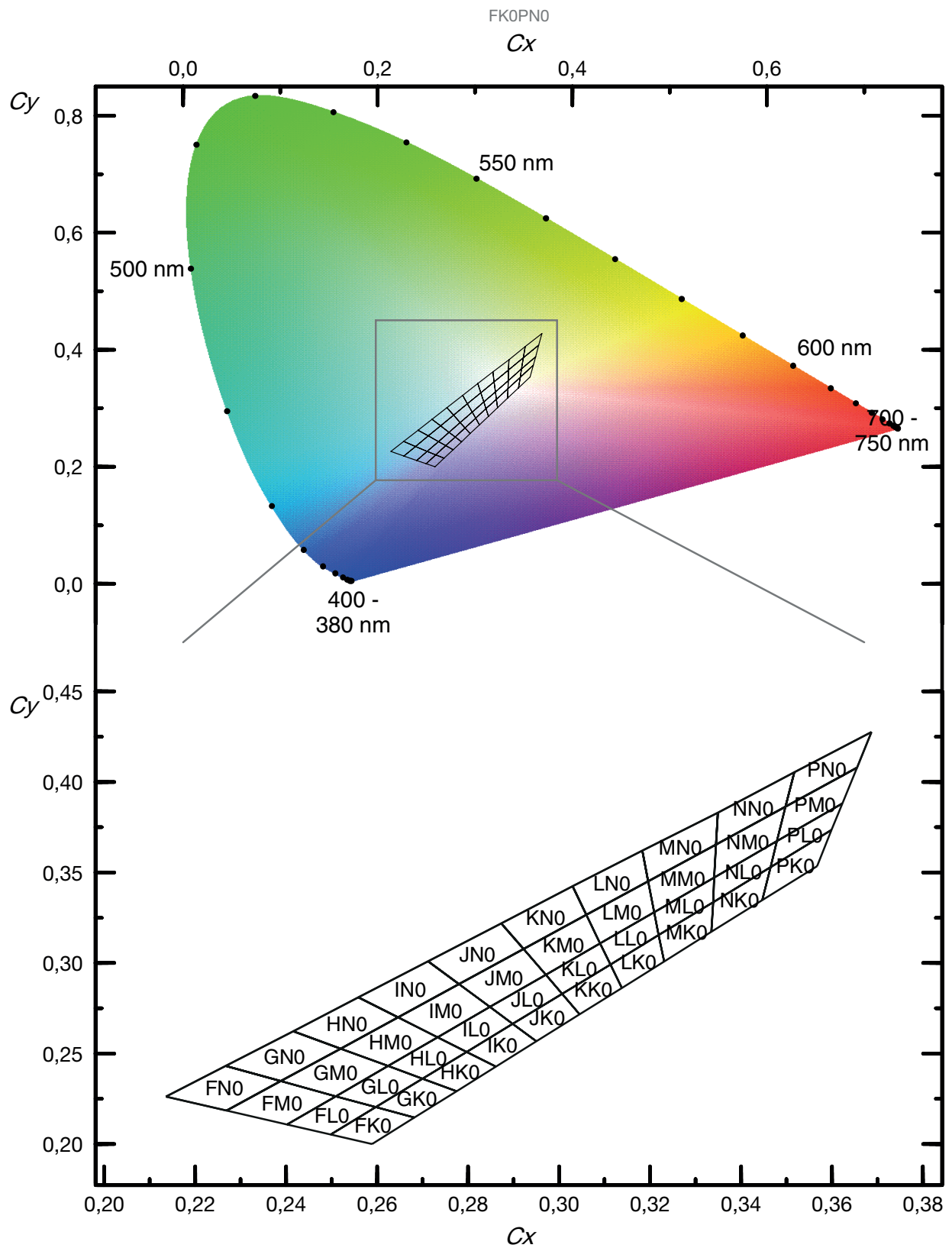

Color Chromaticity Groups ³⁾

| Group | Cx | Cy | Group | Cx | Cy | Group | Cx | Cy |
|-------|--------|--------|-------|--------|--------|-------|--------|--------|
| FK0 | 0.2498 | 0.2053 | HK0 | 0.2700 | 0.2361 | JK0 | 0.2898 | 0.2664 |
| | 0.2597 | 0.2204 | | 0.2797 | 0.2509 | | 0.3007 | 0.2830 |
| | 0.2682 | 0.2146 | | 0.2861 | 0.2427 | | 0.3045 | 0.2717 |
| | 0.2589 | 0.2000 | | 0.2775 | 0.2292 | | 0.2950 | 0.2568 |
| FL0 | 0.2402 | 0.2108 | HLO | 0.2624 | 0.2431 | JL0 | 0.2848 | 0.2757 |
| | 0.2509 | 0.2264 | | 0.2733 | 0.2590 | | 0.2971 | 0.2935 |
| | 0.2597 | 0.2204 | | 0.2797 | 0.2509 | | 0.3007 | 0.2830 |
| | 0.2498 | 0.2053 | | 0.2700 | 0.2361 | | 0.2898 | 0.2664 |
| FM0 | 0.2269 | 0.2185 | HMO | 0.2520 | 0.2527 | JMO | 0.2780 | 0.2883 |
| | 0.2388 | 0.2348 | | 0.2646 | 0.2700 | | 0.2922 | 0.3077 |
| | 0.2509 | 0.2264 | | 0.2733 | 0.2590 | | 0.2971 | 0.2935 |
| | 0.2402 | 0.2108 | | 0.2624 | 0.2431 | | 0.2848 | 0.2757 |
| FN0 | 0.2136 | 0.2262 | HNO | 0.2416 | 0.2623 | JNO | 0.2712 | 0.3009 |
| | 0.2267 | 0.2432 | | 0.2559 | 0.2810 | | 0.2873 | 0.3219 |
| | 0.2388 | 0.2348 | | 0.2646 | 0.2700 | | 0.2922 | 0.3077 |
| | 0.2269 | 0.2185 | | 0.2520 | 0.2527 | | 0.2780 | 0.2883 |
| GK0 | 0.2597 | 0.2204 | IK0 | 0.2797 | 0.2509 | KK0 | 0.3007 | 0.2830 |
| | 0.2700 | 0.2361 | | 0.2898 | 0.2664 | | 0.3113 | 0.2992 |
| | 0.2775 | 0.2292 | | 0.2950 | 0.2568 | | 0.3138 | 0.2862 |
| | 0.2682 | 0.2146 | | 0.2861 | 0.2427 | | 0.3045 | 0.2717 |
| GL0 | 0.2509 | 0.2264 | ILO | 0.2733 | 0.2590 | KLO | 0.2971 | 0.2935 |
| | 0.2624 | 0.2431 | | 0.2848 | 0.2757 | | 0.3090 | 0.3108 |
| | 0.2700 | 0.2361 | | 0.2898 | 0.2664 | | 0.3113 | 0.2992 |
| | 0.2597 | 0.2204 | | 0.2797 | 0.2509 | | 0.3007 | 0.2830 |
| GM0 | 0.2388 | 0.2348 | IMO | 0.2646 | 0.2700 | KM0 | 0.2922 | 0.3077 |
| | 0.2520 | 0.2527 | | 0.2780 | 0.2883 | | 0.3060 | 0.3266 |
| | 0.2624 | 0.2431 | | 0.2848 | 0.2757 | | 0.3090 | 0.3108 |
| | 0.2509 | 0.2264 | | 0.2733 | 0.2590 | | 0.2971 | 0.2935 |
| GN0 | 0.2267 | 0.2432 | INO | 0.2559 | 0.2810 | KN0 | 0.2873 | 0.3219 |
| | 0.2416 | 0.2623 | | 0.2712 | 0.3009 | | 0.3030 | 0.3424 |
| | 0.2520 | 0.2527 | | 0.2780 | 0.2883 | | 0.3060 | 0.3266 |
| | 0.2388 | 0.2348 | | 0.2646 | 0.2700 | | 0.2922 | 0.3077 |

| Group | Cx | Cy | Group | Cx | Cy | Group | Cx | Cy |
|-------|--------|--------|-------|--------|--------|-------|--------|--------|
| LK0 | 0.3113 | 0.2992 | MM0 | 0.3196 | 0.3451 | PK0 | 0.3465 | 0.3530 |
| | 0.3219 | 0.3154 | | 0.3345 | 0.3654 | | 0.3599 | 0.3735 |
| | 0.3231 | 0.3008 | | 0.3341 | 0.3472 | | 0.3567 | 0.3535 |
| | 0.3138 | 0.2862 | | 0.3209 | 0.3281 | | 0.3447 | 0.3347 |
| LLO | 0.3090 | 0.3108 | MNO | 0.3183 | 0.3621 | PLO | 0.3479 | 0.3673 |
| | 0.3209 | 0.3281 | | 0.3349 | 0.3830 | | 0.3623 | 0.3882 |
| | 0.3219 | 0.3154 | | 0.3345 | 0.3654 | | 0.3599 | 0.3735 |
| | 0.3113 | 0.2992 | | 0.3196 | 0.3451 | | 0.3465 | 0.3530 |
| LMO | 0.3060 | 0.3266 | NKO | 0.3339 | 0.3336 | PM0 | 0.3498 | 0.3863 |
| | 0.3196 | 0.3451 | | 0.3465 | 0.3530 | | 0.3655 | 0.4079 |
| | 0.3209 | 0.3281 | | 0.3447 | 0.3347 | | 0.3623 | 0.3882 |
| | 0.3090 | 0.3108 | | 0.3335 | 0.3172 | | 0.3479 | 0.3673 |
| LNO | 0.3030 | 0.3424 | NLO | 0.3341 | 0.3472 | PNO | 0.3517 | 0.4053 |
| | 0.3183 | 0.3621 | | 0.3479 | 0.3673 | | 0.3687 | 0.4276 |
| | 0.3196 | 0.3451 | | 0.3465 | 0.3530 | | 0.3655 | 0.4079 |
| | 0.3060 | 0.3266 | | 0.3339 | 0.3336 | | 0.3498 | 0.3863 |
| MK0 | 0.3219 | 0.3154 | NMO | 0.3345 | 0.3654 | | | |
| | 0.3339 | 0.3336 | | 0.3498 | 0.3863 | | | |
| | 0.3335 | 0.3172 | | 0.3479 | 0.3673 | | | |
| | 0.3231 | 0.3008 | | 0.3341 | 0.3472 | | | |
| MLO | 0.3209 | 0.3281 | NNO | 0.3349 | 0.3830 | | | |
| | 0.3341 | 0.3472 | | 0.3517 | 0.4053 | | | |
| | 0.3339 | 0.3336 | | 0.3498 | 0.3863 | | | |
| | 0.3219 | 0.3154 | | 0.3345 | 0.3654 | | | |

Group Name on Label

Example: Q2-FK0-3B

| Brightness | Color Chromaticity | Forward Voltage |
|------------|--------------------|-----------------|
| Q2 | FK0 | 3B |

Relative Spectral Emission ⁷⁾

$I_{rel} = f(\lambda); I_F = 10 \text{ mA}; T_S = 25 \text{ }^\circ\text{C}$

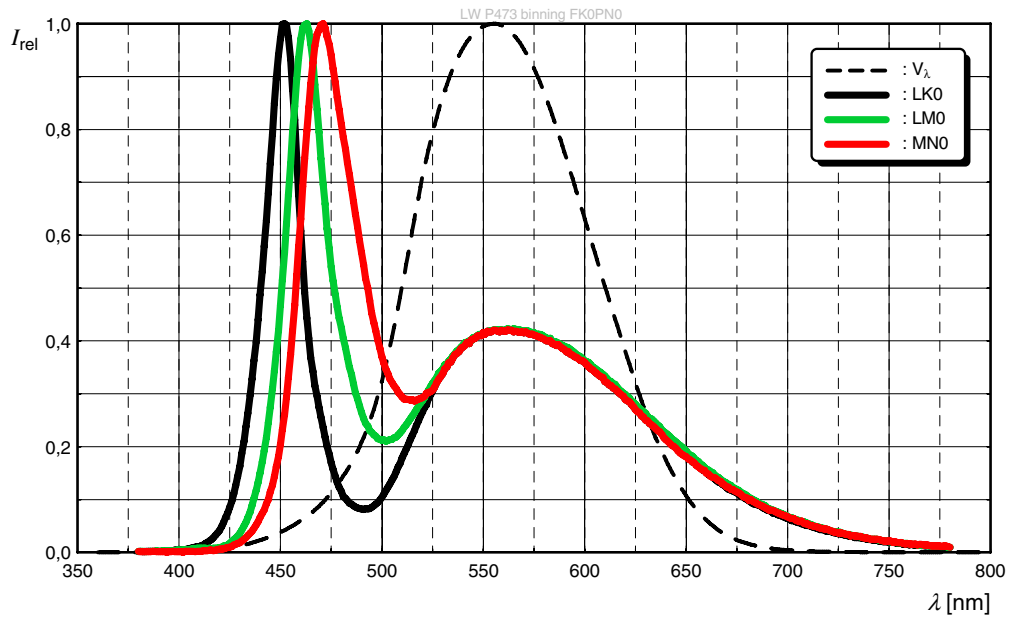

Radiation Characteristics ⁷⁾

$I_{rel} = f(\phi); T_S = 25 \text{ }^\circ\text{C}$

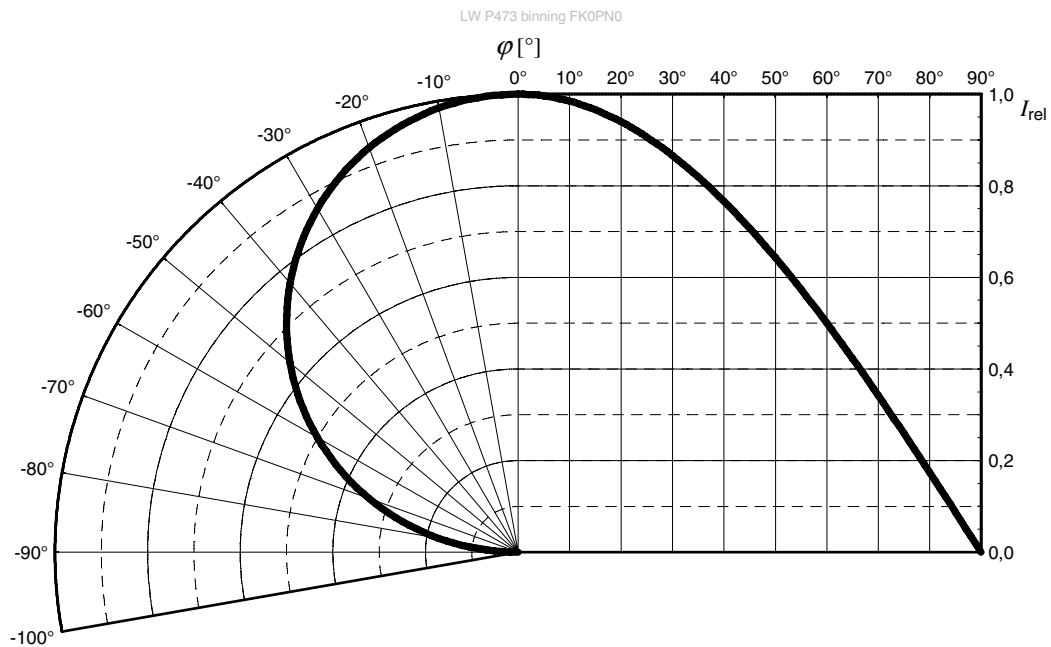

Forward current ⁷⁾

$$I_F = f(V_F); T_S = 25\text{ °C}$$

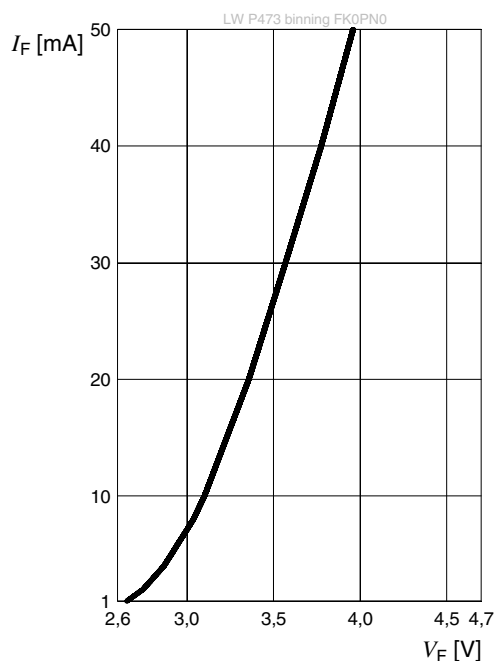

Relative Luminous Intensity ^{7), 8)}

$$I_V/I_V(10\text{ mA}) = f(I_F); T_S = 25\text{ °C}$$

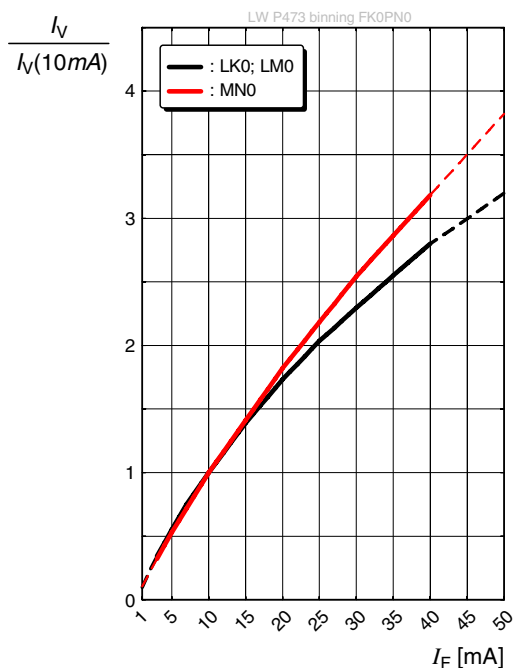

Chromaticity Coordinate Shift ⁷⁾

$$\Delta C_x, \Delta C_y = f(I_F); T_S = 25\text{ °C}$$

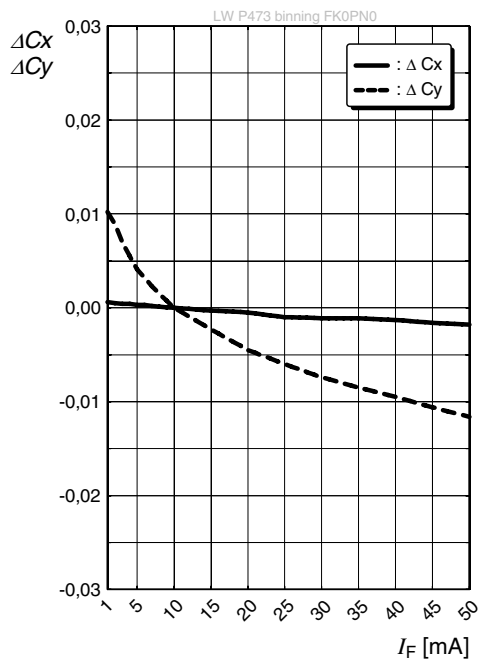

Forward Voltage ⁷⁾

$$\Delta V_F = V_F - V_F(25^\circ\text{C}) = f(T_j); I_F = 10\text{ mA}$$

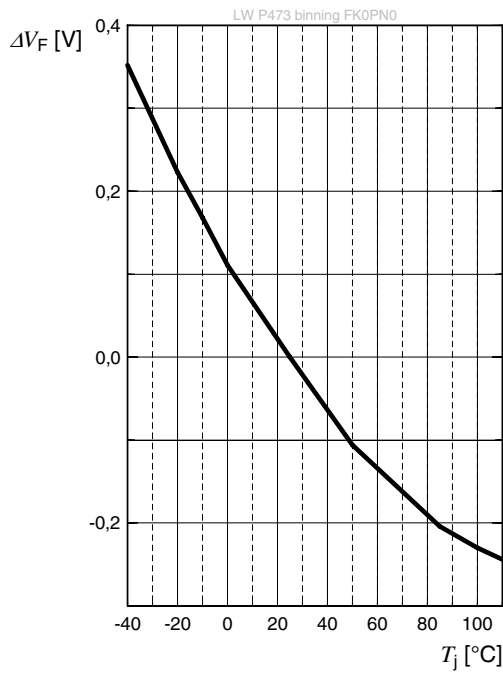

Relative Luminous Intensity ⁷⁾

$$I_V/I_V(25^\circ\text{C}) = f(T_j); I_F = 10\text{ mA}$$

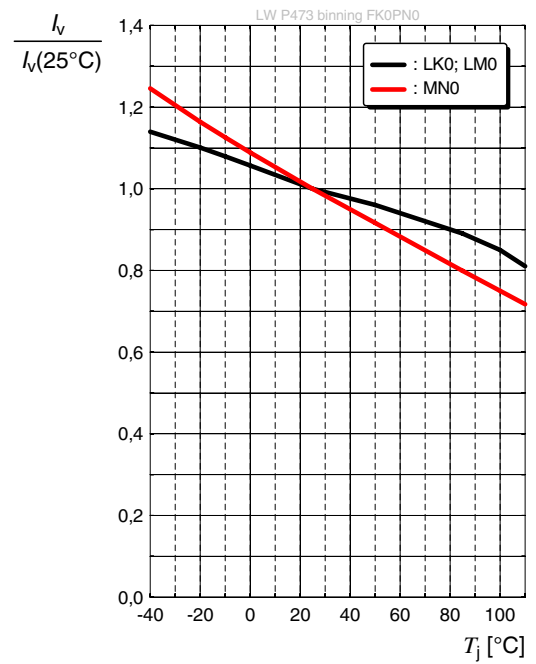

Chromaticity Coordinate Shift ⁷⁾

$$\Delta C_x, \Delta C_y = f(T_j); I_F = 10\text{ mA}$$

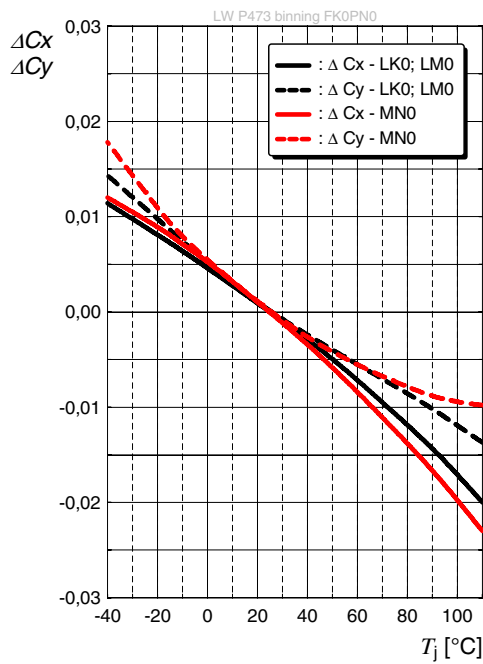

Max. Permissible Forward Current

$I_F = f(T)$

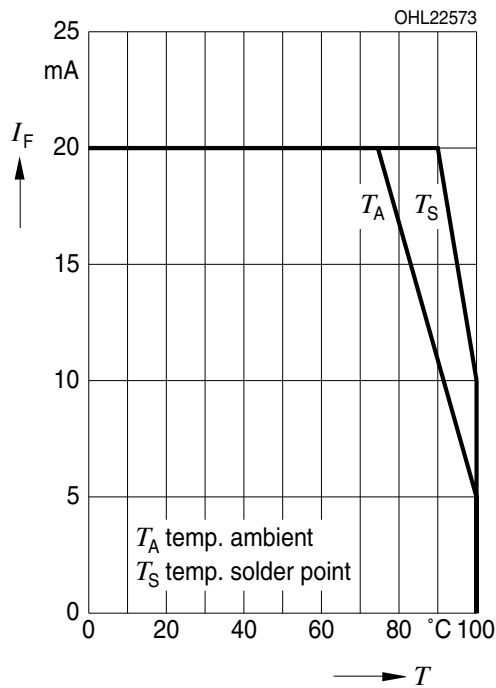

Permissible Pulse Handling Capability

$I_F = f(t_p)$; D: Duty cycle; $T_S = 25\text{ °C}$

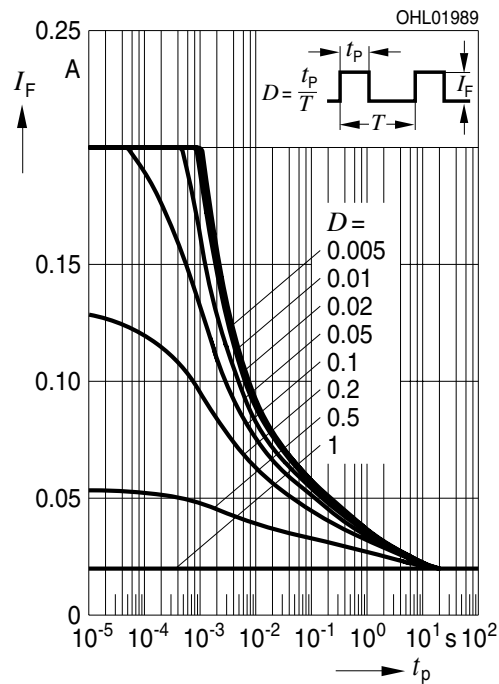

Permissible Pulse Handling Capability

$I_F = f(t_p)$; D: Duty cycle; $T_S = 85\text{ °C}$

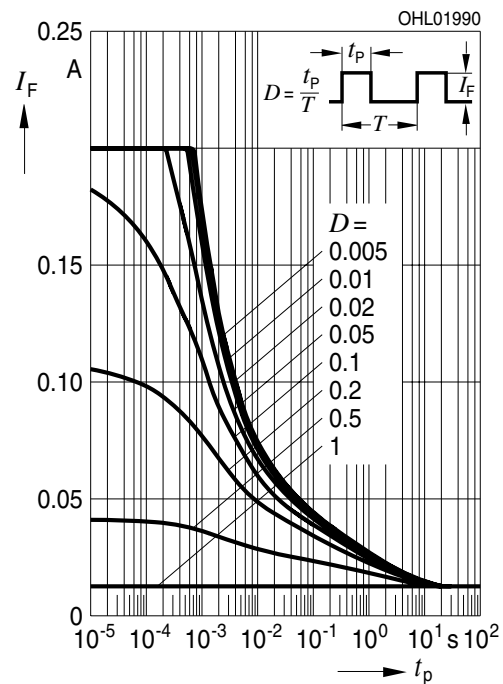

Dimensional Drawing ⁹⁾

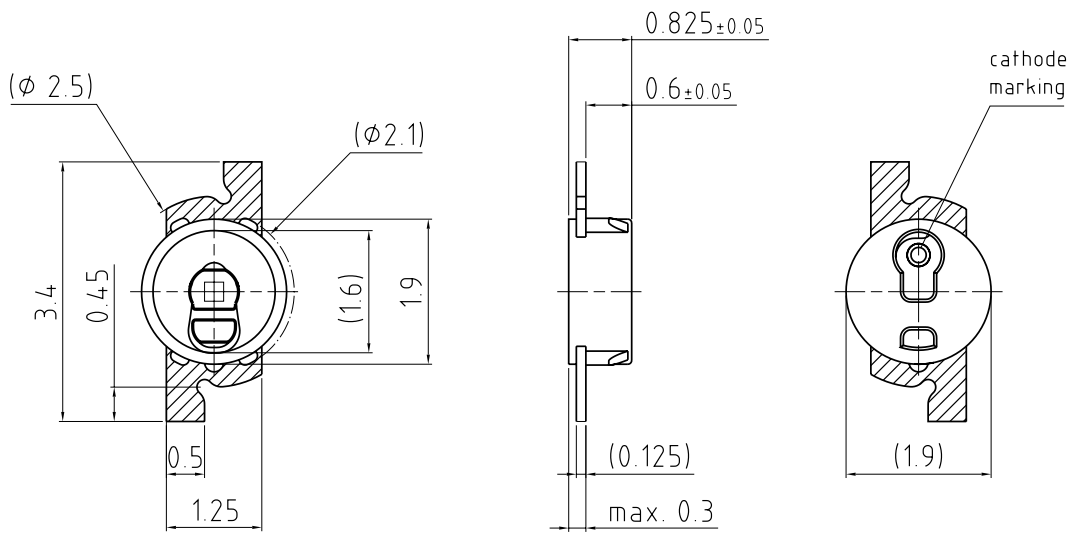

general tolerance ± 0.1

lead finish Sn 

C63062-A3773-A10.. -06

Approximate Weight: 6.0 mg

Corrosion test: Class: 3B
 Test condition: 40°C / 90 % RH / 15 ppm H₂S / 14 days (stricter than IEC 60068-2-43)

Recommended Solder Pad ⁹⁾

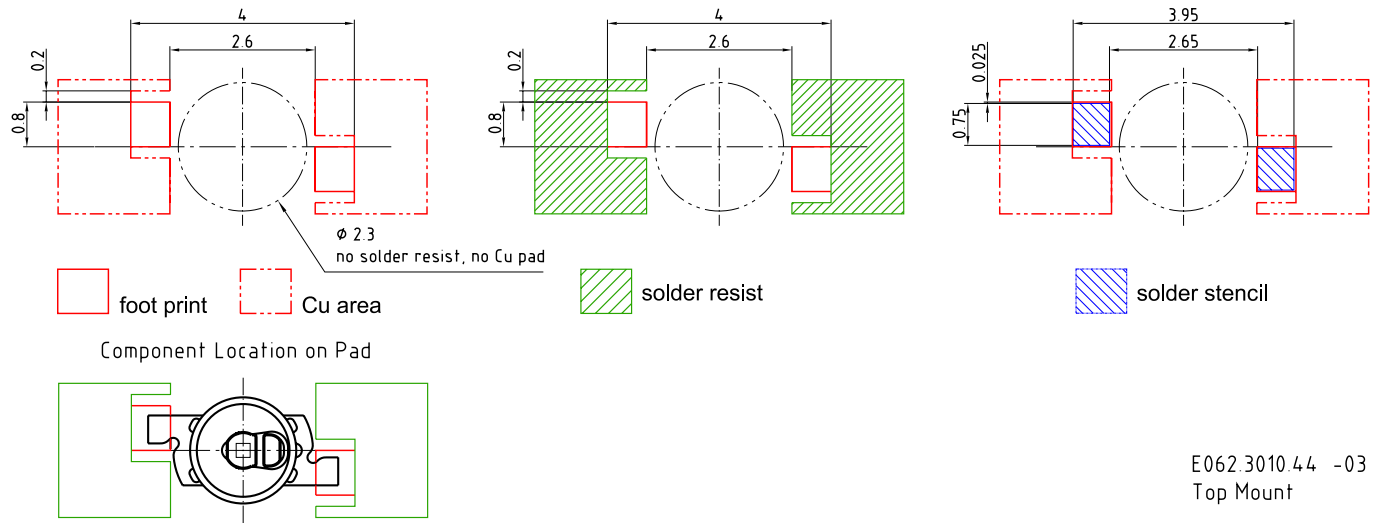

For superior solder joint connectivity results we recommend soldering under standard nitrogen atmosphere. Package not suitable for ultra sonic cleaning.

Recommended Solder Pad ⁹⁾

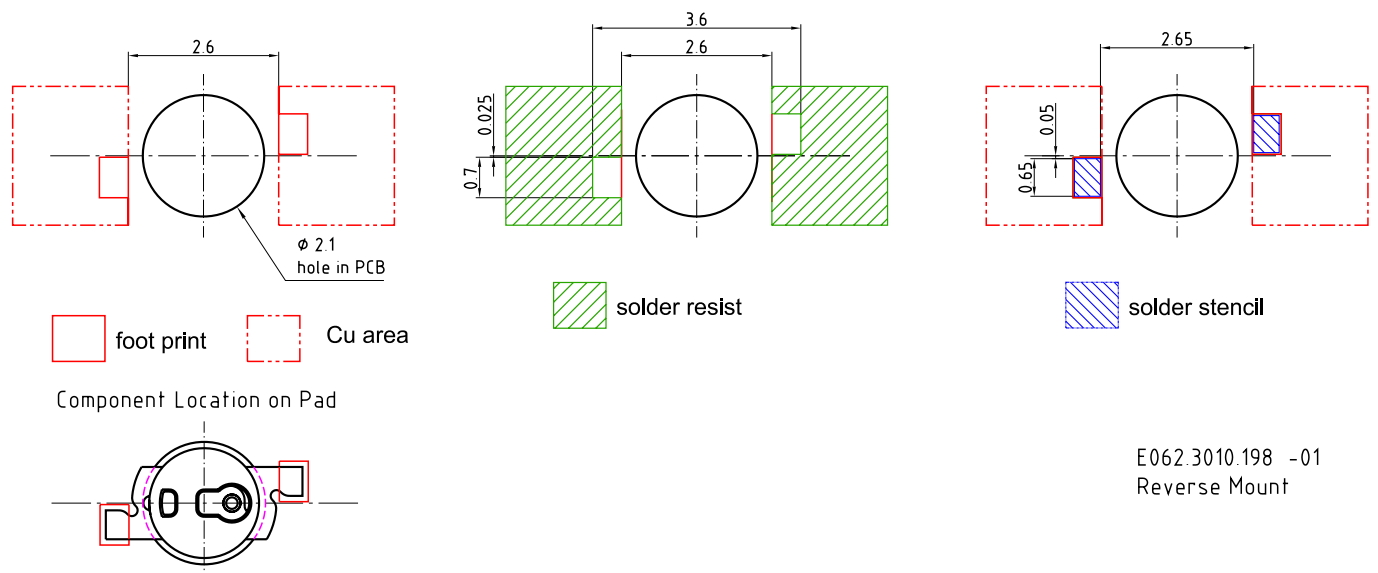

For superior solder joint connectivity results we recommend soldering under standard nitrogen atmosphere. Package not suitable for ultra sonic cleaning.

Reflow Soldering Profile

Product complies to MSL Level 2 acc. to JEDEC J-STD-020E

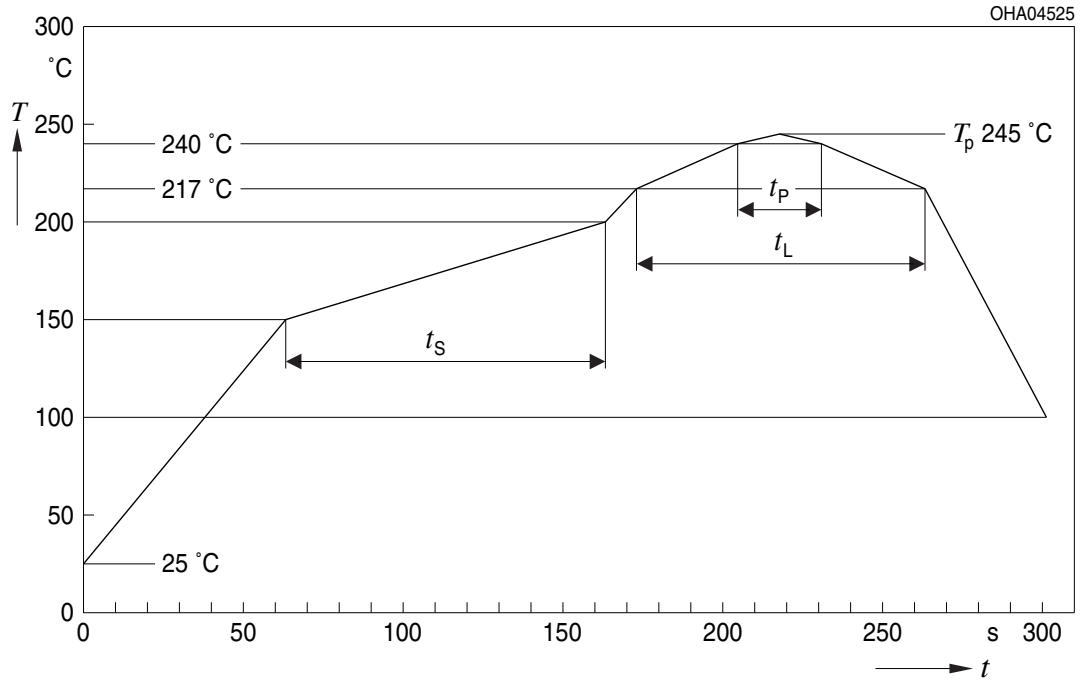

| Profile Feature | Symbol | Pb-Free (SnAgCu) Assembly | | | Unit |
|--|--------|---------------------------|----------------|---------|------|
| | | Minimum | Recommendation | Maximum | |
| Ramp-up rate to preheat*) 25 °C to 150 °C | | | 2 | 3 | K/s |
| Time t_s T_{Smin} to T_{Smax} | t_s | 60 | 100 | 120 | s |
| Ramp-up rate to peak*) T_{Smax} to T_p | | | 2 | 3 | K/s |
| Liquidus temperature | T_L | | 217 | | °C |
| Time above liquidus temperature | t_L | | 80 | 100 | s |
| Peak temperature | T_p | | 245 | 260 | °C |
| Time within 5 °C of the specified peak temperature $T_p - 5$ K | t_p | 10 | 20 | 30 | s |
| Ramp-down rate* T_p to 100 °C | | | 3 | 6 | K/s |
| Time 25 °C to T_p | | | | 480 | s |

All temperatures refer to the center of the package, measured on the top of the component
 *) slope calculation DT/Dt : Dt max. 5 s; fulfillment for the whole T-range

Taping ⁹⁾

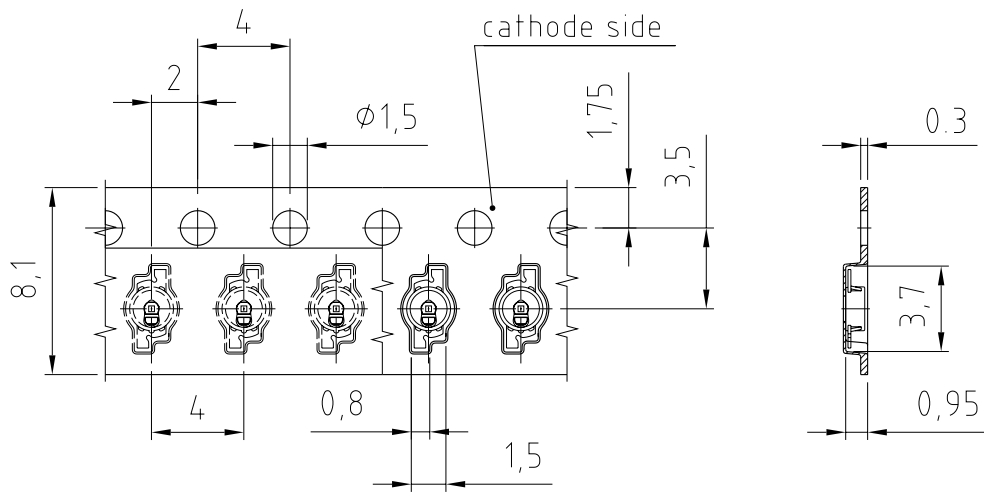

C63062-A3773-B8 -05
Top Mount

Taping ⁹⁾

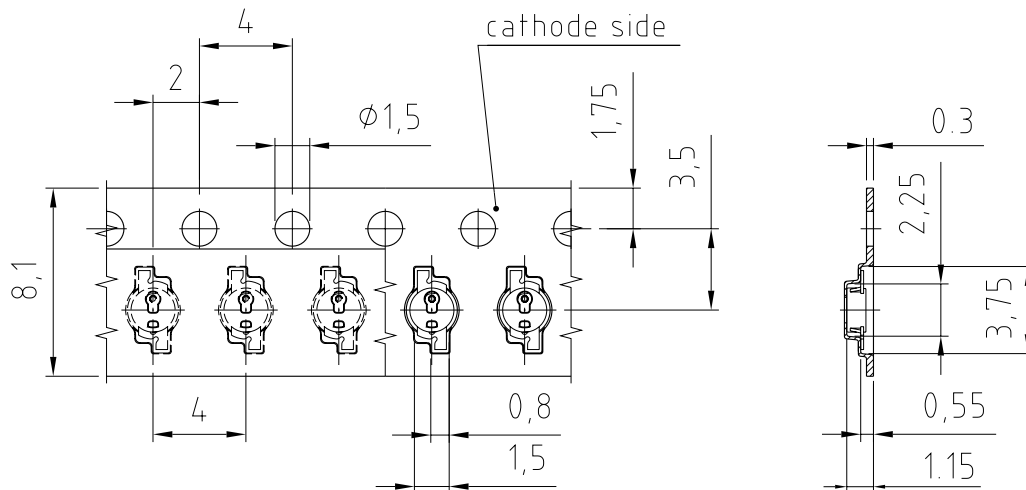

C63062-A3773-B4 -05
Reverse Mount

Tape and Reel ¹⁰⁾

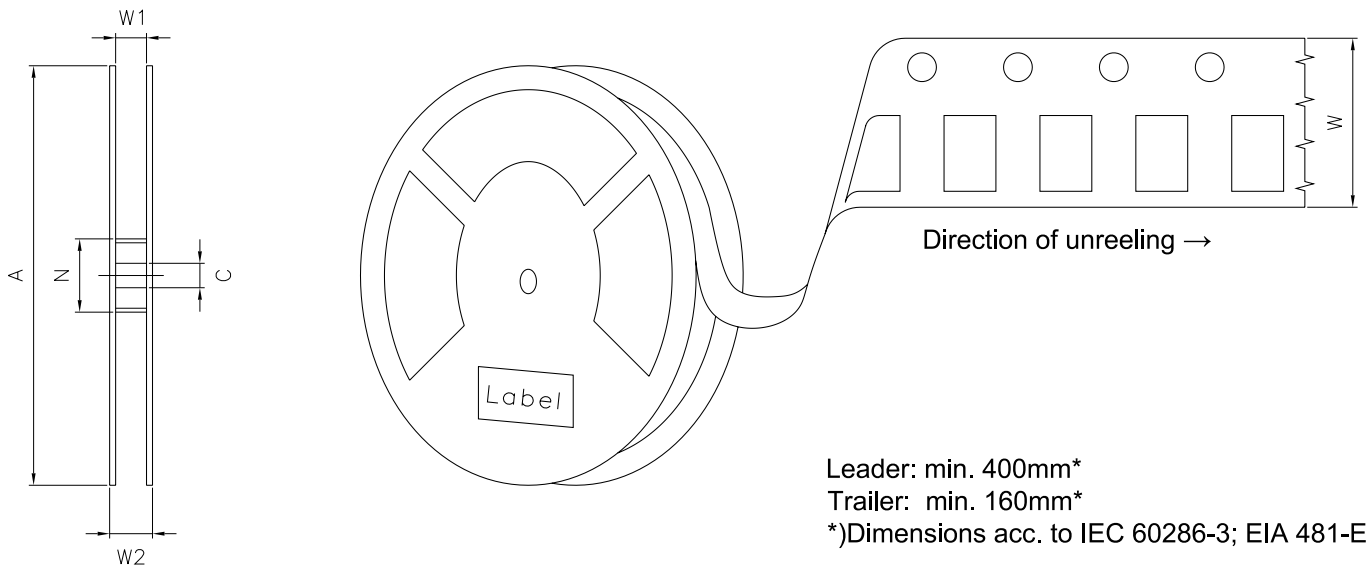

Reel dimensions [mm]

| A | W | N _{min} | W ₁ | W _{2max} | Pieces per PU |
|--------|-----------------|------------------|----------------|-------------------|---------------|
| 180 mm | 8 + 0.3 / - 0.1 | 60 | 8.4 + 2 | 14.4 | 3000 |

Barcode-Product-Label (BPL)



Dry Packing Process and Materials ⁹⁾



Moisture-sensitive product is packed in a dry bag containing desiccant and a humidity card according JEDEC-STD-033.

Transportation Packing and Materials ⁹⁾



Dimensions of transportation box in mm

| Width | Length | Height |
|------------|------------|-----------|
| 200 ± 5 mm | 195 ± 5 mm | 30 ± 5 mm |

Type Designation System

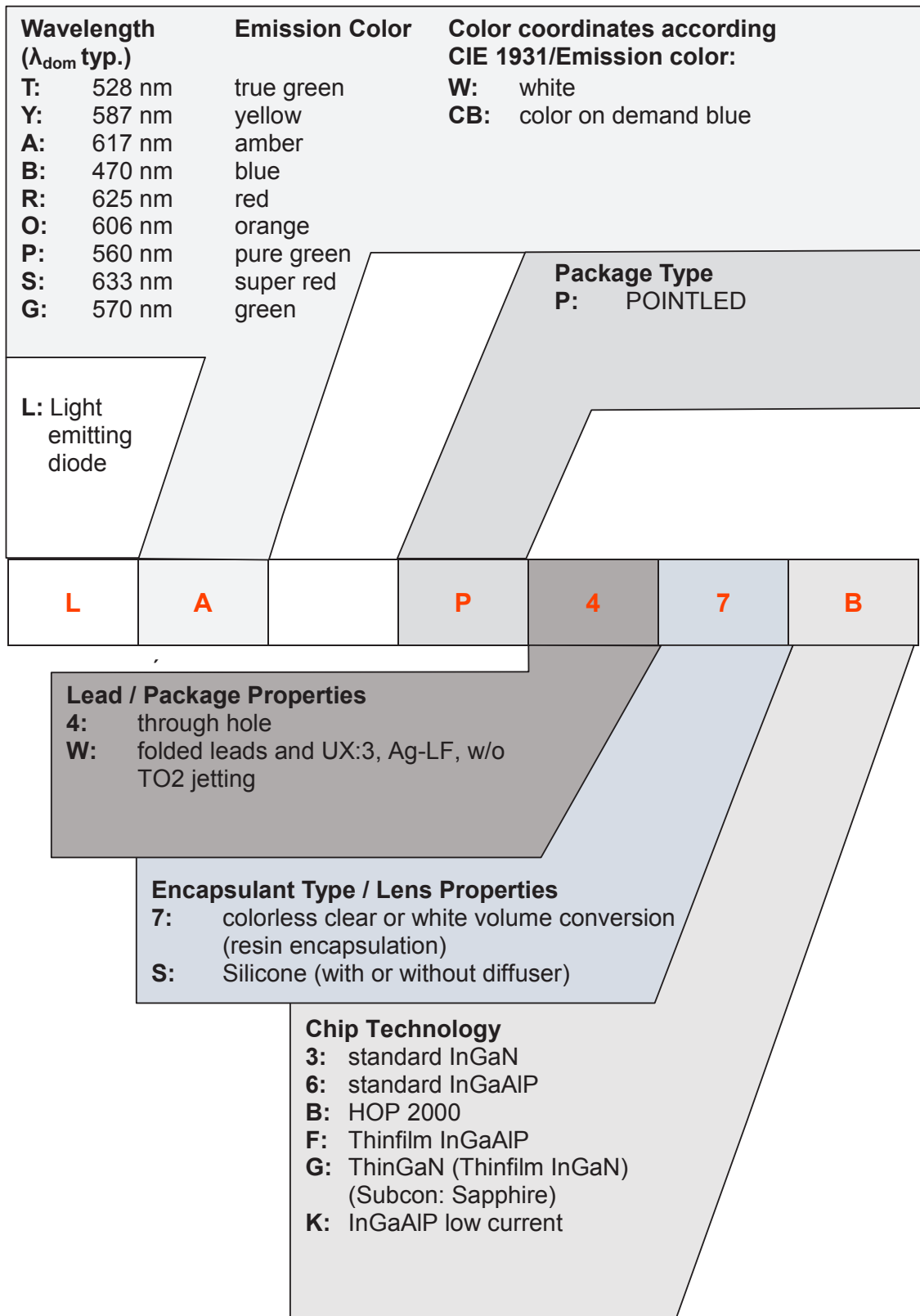

Notes

The evaluation of eye safety occurs according to the standard IEC 62471:2006 (photo biological safety of lamps and lamp systems). Within the risk grouping system of this IEC standard, the device specified in this data sheet falls into the class **exempt group (exposure time 10000 s)**. Under real circumstances (for exposure time, conditions of the eye pupils, observation distance), it is assumed that no endangerment to the eye exists from these devices. As a matter of principle, however, it should be mentioned that intense light sources have a high secondary exposure potential due to their blinding effect. When looking at bright light sources (e.g. headlights), temporary reduction in visual acuity and afterimages can occur, leading to irritation, annoyance, visual impairment, and even accidents, depending on the situation.

Subcomponents of this LED contain, in addition to other substances, metal filled materials including silver. Metal filled materials can be affected by environments that contain traces of aggressive substances. Therefore, we recommend that customers minimize LED exposure to aggressive substances during storage, production, and use. LEDs that showed visible discoloration when tested using the described tests above did show no performance deviations within failure limits during the stated test duration. Respective failure limits are described in the IEC60810.

For further application related informations please visit www.osram-os.com/appnotes

Disclaimer

Disclaimer

Language english will prevail in case of any discrepancies or deviations between the two language wordings.

Attention please!

The information describes the type of component and shall not be considered as assured characteristics. Terms of delivery and rights to change design reserved. Due to technical requirements components may contain dangerous substances.

For information on the types in question please contact our Sales Organization.

If printed or downloaded, please find the latest version on the OSRAM OS website.

Packing

Please use the recycling operators known to you. We can also help you – get in touch with your nearest sales office.

By agreement we will take packing material back, if it is sorted. You must bear the costs of transport. For packing material that is returned to us unsorted or which we are not obliged to accept, we shall have to invoice you for any costs incurred.

Product safety devices/applications or medical devices/applications

OSRAM OS components are not developed, constructed or tested for the application as safety relevant component or for the application in medical devices.

In case Buyer – or Customer supplied by Buyer– considers using OSRAM OS components in product safety devices/applications or medical devices/applications, Buyer and/or Customer has to inform the local sales partner of OSRAM OS immediately and OSRAM OS and Buyer and /or Customer will analyze and coordinate the customer-specific request between OSRAM OS and Buyer and/or Customer.

Glossary

- 1) **Brightness:** Brightness values are measured during a current pulse of typically 25 ms, with an internal reproducibility of $\pm 8\%$ and an expanded uncertainty of $\pm 11\%$ (acc. to GUM with a coverage factor of $k = 3$).
- 2) **Reverse Operation:** Reverse Operation of 10 hours is permissible in total. Continuous reverse operation is not allowed.
- 3) **Chromaticity coordinate groups:** Chromaticity coordinates are measured during a current pulse of typically 25 ms, with an internal reproducibility of ± 0.005 and an expanded uncertainty of ± 0.01 (acc. to GUM with a coverage factor of $k = 3$).
- 4) **Forward Voltage:** The forward voltage is measured during a current pulse of typically 8 ms, with an internal reproducibility of $\pm 0.05\text{ V}$ and an expanded uncertainty of $\pm 0.1\text{ V}$ (acc. to GUM with a coverage factor of $k = 3$).
- 5) **Thermal Resistance:** $R_{th\text{ max}}$ is based on statistic values (6σ).
- 6) **Thermal Resistance:** R_{thJA} results from mounting on PC board FR 4 (pad size 16 mm^2 per pad)
- 7) **Typical Values:** Due to the special conditions of the manufacturing processes of semiconductor devices, the typical data or calculated correlations of technical parameters can only reflect statistical figures. These do not necessarily correspond to the actual parameters of each single product, which could differ from the typical data and calculated correlations or the typical characteristic line. If requested, e.g. because of technical improvements, these typ. data will be changed without any further notice.
- 8) **Characteristic curve:** In the range where the line of the graph is broken, you must expect higher differences between single devices within one packing unit.
- 9) **Tolerance of Measure:** Unless otherwise noted in drawing, tolerances are specified with ± 0.1 and dimensions are specified in mm.
- 10) **Tape and Reel:** All dimensions and tolerances are specified acc. IEC 60286-3 and specified in mm.

Published by OSRAM Opto Semiconductors GmbH
Leibnizstraße 4, D-93055 Regensburg
www.osram-os.com © All Rights Reserved.

EU RoHS and China RoHS compliant product



此产品符合欧盟 RoHS 指令的要求；
按照中国的相关法规和标准，不含有毒有害物质或元素。

Компания «Океан Электроники» предлагает заключение долгосрочных отношений при поставках импортных электронных компонентов на взаимовыгодных условиях!

Наши преимущества:

- Поставка оригинальных импортных электронных компонентов напрямую с производств Америки, Европы и Азии, а так же с крупнейших складов мира;
- Широкая линейка поставок активных и пассивных импортных электронных компонентов (более 30 млн. наименований);
- Поставка сложных, дефицитных, либо снятых с производства позиций;
- Оперативные сроки поставки под заказ (от 5 рабочих дней);
- Экспресс доставка в любую точку России;
- Помощь Конструкторского Отдела и консультации квалифицированных инженеров;
- Техническая поддержка проекта, помощь в подборе аналогов, поставка прототипов;
- Поставка электронных компонентов под контролем ВП;
- Система менеджмента качества сертифицирована по Международному стандарту ISO 9001;
- При необходимости вся продукция военного и аэрокосмического назначения проходит испытания и сертификацию в лаборатории (по согласованию с заказчиком);
- Поставка специализированных компонентов военного и аэрокосмического уровня качества (Xilinx, Altera, Analog Devices, Intersil, Interpoint, Microsemi, Actel, Aeroflex, Peregrine, VPT, Syfer, Eurofarad, Texas Instruments, MS Kennedy, Miteq, Cobham, E2V, MA-COM, Hittite, Mini-Circuits, General Dynamics и др.);

Компания «Океан Электроники» является официальным дистрибьютором и эксклюзивным представителем в России одного из крупнейших производителей разъемов военного и аэрокосмического назначения «JONHON», а так же официальным дистрибьютором и эксклюзивным представителем в России производителя высокотехнологичных и надежных решений для передачи СВЧ сигналов «FORSTAR».



JONHON

«JONHON» (основан в 1970 г.)

Разъемы специального, военного и аэрокосмического назначения:

(Применяются в военной, авиационной, аэрокосмической, морской, железнодорожной, горно- и нефтедобывающей отраслях промышленности)

«FORSTAR» (основан в 1998 г.)

ВЧ соединители, коаксиальные кабели, кабельные сборки и микроволновые компоненты:

(Применяются в телекоммуникациях гражданского и специального назначения, в средствах связи, РЛС, а так же военной, авиационной и аэрокосмической отраслях промышленности).



Телефон: 8 (812) 309-75-97 (многоканальный)

Факс: 8 (812) 320-03-32

Электронная почта: ocean@oceanchips.ru

Web: <http://oceanchips.ru/>

Адрес: 198099, г. Санкт-Петербург, ул. Калинина, д. 2, корп. 4, лит. А