

## 1564 Series Sloped Console

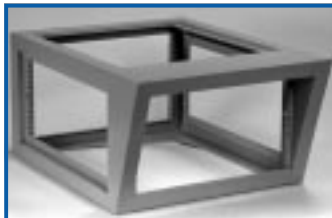

Top Console



Desk



Wedge

### Application

- Designed to provide an attractive, durable console enclosure system for control center installations and for the protection of electronic, hydraulic, pneumatic or electrical equipment.
- The 20° viewing slope provides the optimum angle for a control or instrument panel.
- Integral CRT mounting angles and optional desk panel provide versatility for many applications.
- Can be ganged together for large system applications.

### Standards

- EIA RS-310-D

### Construction

- Available in Rapid Rack (2 sizes) or as a customized assembly which can be created using the various components in the 1564 Series.
- As a system rack, all components have been designed for a clean, modular interface.
- Major components are constructed of 14 gauge steel.
- Available with either 19" or 24" mounting capability.

### Assemblies

- When assembling rack systems, please refer to master selection table for sizing information.

### Finish

- Rapid Rack is available in beige (CG1). Components are available in beige (CG1) or black (BK1).

### Accessories

- Blowers
- Casters
- Desk units
- Doors -
- Extra mounting rails
- Fan trays
- Filter fans
- Side panels
- Top consoles
- Top panels
- Wedges
- 19"/24" rack mount accessories -

K28



#### Rapid Rack

- For immediate delivery requirements, the *Rapid Rack* package can solve many sloped console needs. The package is finished with beige (CG1) frame and body.
- Package includes the following components and hardware:
  - 1 - 1564 frame with integral CRT mounting angles
  - 1 - pair of side panels
  - 1 - louvered rear door
  - 1 - solid top panel
  - 4 - upper black, punched combination rails
  - 4 - lower black, punched combination rails
  - 4 - adjustable levelling feet
  - 50 - 10-32 clip nuts



PART No.	PANEL WIDTH	A	B	C	D	E	F
RS4924CG1	19	22.56	24.5	19.06	14	17.5	21.31
RS4931CG1	19	22.56	31.5	19.06	21	24.5	19.56



Front View

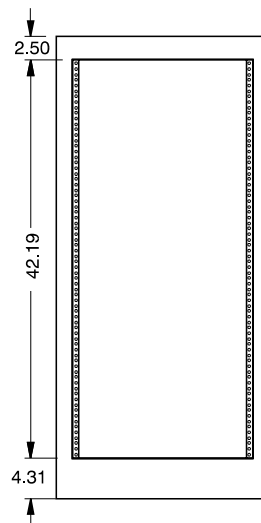

Rear View

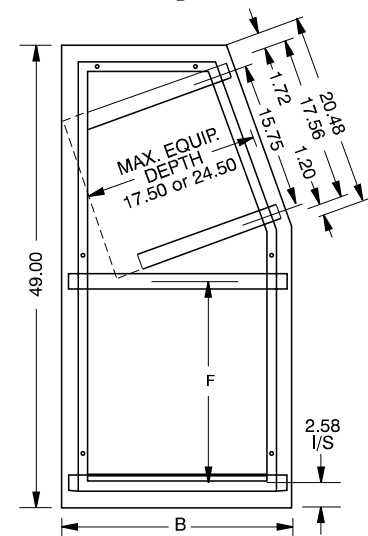

Side View

K29

All dimensions in inches unless specified otherwise

## 1564 Series Sloped Console Components



### Frame

- The basic component of a 1564 Sloped Console system is the 14 gauge steel frame.
- Designed to accommodate standard 19" or 24" rack mountable equipment on two different panel surfaces.
- Integral CRT mounting angles are a standard feature.
- Frame comes complete with 4 upper black, punched combination rails, 4 lower black, punched combination rails, 4 adjustable levelling feet and clip nuts.
- Available in beige (CG1) or black (BK1).



PART NO.	PANEL WIDTH	A	B	C	D	E	F
1564A2... <sup>1</sup>	19	22.56	24.5	19.06	14	17.5	21.31
1564B2...	19	22.56	31.5	19.06	21	24.5	19.56
1564A4...	24	27.56	24.5	24.06	14	17.5	21.31
1564B4...	24	27.56	31.5	24.06	21	24.5	19.56

<sup>1</sup> Specify 3 digit color code. Beige (CG1) or Black (BK1).

K30



Front View

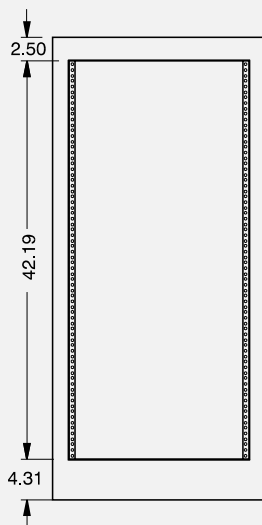

Rear View

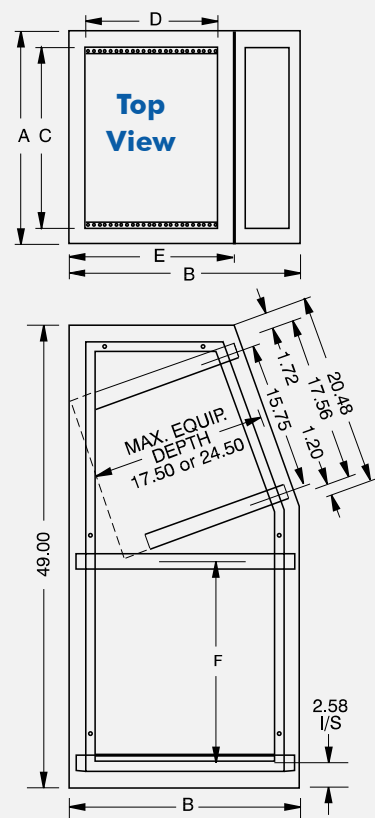

Side View

All dimensions in inches unless specified otherwise



## 1564 Series Sloped Console Components



### Side Panels

- Sold in pairs.
- Constructed of 16 gauge steel formed to 0.75" thick which hook over Amhal struts and can be secured from the inside.
- Panels fit flush with frame.
- Available in beige (CG1) or black (BK1).

PART No.	USE WITH FRAME PART No.
1564AP... <sup>1</sup>	1564A2.../1564A4...
1564BP...	1564B2.../1564B4...

<sup>1</sup> Specify 3 digit color code. Beige (CG1) or Black (BK1).

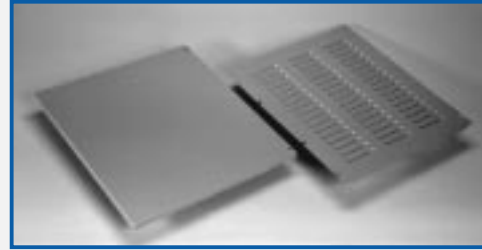

### Top Panel

- Solid 16 gauge steel panel mounts flush with frame.
- Louvered 16 gauge steel panel is recessed.
- Any 19" (or 24" as applicable) panel of proper depth will fit opening.
- Available in beige (CG1) or black (BK1).
- Mounting hardware not included, please order separately.

SOLID TOP PART No.	LOUVERED TOP PART No.	USE WITH FRAME PART No.
PBRS19014... <sup>1</sup>	PVLK19014... <sup>1</sup>	1564A2...
PBRS19021...	PVLK19021...	1564B2...
PBRS24014...	PVLK24014...	1564A4...
PBRS24021...	PVLK24021...	1564B4...

<sup>1</sup> Specify 3 digit color code. Beige (CG1) or Black (BK1).



### Rear Door

- Features lockable latch.
- Fills rear panel space and sits flush with frame.
- Solid door opens either left or right by inverting.
- Louvered door opens right hand only with louver vents facing down.
- Constructed of 18 gauge steel.
- Available in beige (CG1) or black (BK1).

SOLID DOOR PART No.	LOUVERED DOOR PART No.	USE WITH FRAME PART No.
RSDF19042... <sup>1</sup>	RSDL19042... <sup>1</sup>	1564A2...
RSDF19042...	RSDL19042...	1564B2...
RSDF24042...	RSDL24042...	1564A4...
RSDF24042...	RSDL24042...	1564B4...

<sup>1</sup> Specify 3 digit color code. Beige (CG1) or Black (BK1).

All dimensions in inches unless specified otherwise

## 1564 Series Sloped Console Components



### Front Doors

- Features lockable latch.
- Fills front lower panel space and sits flush with frame.
- For optional desk units, use RSDF19022 or RSDF24022.
- Solid door opens either left or right by inverting.
- Louvered door opens right hand only with louver vents facing down.
- Available in beige (CG1) or black (BK1).



SOLID DOOR PART No.	LOUVERED DOOR PART No.	USE W/FRAME PART No.
RSDF19022... <sup>1</sup>	n/a	1564A2... or 1564B2...
RSDF24022...	n/a	1564A4... or 1564B4...
RSDF19026...	RSDL19026... <sup>1</sup>	1564A2...
RSDF19026...	RSDL19026...	1564B2...
RSDF24026...	RSDL24026...	1564A4...
RSDF24026...	RSDL24026...	1564B4...

<sup>1</sup> Specify 3 digit color code. Beige (CG1) or Black (BK1).



### Wedges

- For wrap-around applications, 2 wedge sizes provide either 30° or 60° angles.
- Constructed of 14 gauge steel and comes complete with solid rear 16 gauge panel.
- Available in beige (CG1) or black (BK1).

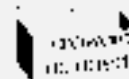

PART No.	USE WITH FRAME PART No.	WEDGE ANGLE
1564AW30... <sup>1</sup>	1564A2.../1564A4...	30
1564BW30...	1564B2.../1564B4...	30
1564AW60...	1564A2.../1564A4...	60
1564BW60...	1564B2.../1564B4...	60

<sup>1</sup> Specify 3 digit color code. Beige (CG1) or Black (BK1).

K32

## 1564 Master Selection Table

PANEL WIDTH	CABINET DEPTH	FRONT PANEL HEIGHT		SLOPE PANEL HEIGHT		SIDE PANELS (PAIR)	WEDGE		TOP PANEL		
		INCHES	UNITS	INCHES	UNITS		FRAME	30°	60°	SOLID	LOUVERED
19"	24.5	26.25	15	17.5	10	1564A2... <sup>1</sup>	1564AP... <sup>1</sup>	1564AW30... <sup>1</sup>	1564AW60... <sup>1</sup>	PBRS19014... <sup>1</sup>	PVLK19014... <sup>1</sup>
		31.5	15	17.5	10	1564B2...	1564BP...	1564BW30...	1564BW60...	PBRS19021...	PVLK19021...
24"	24.5	26.25	15	17.5	10	1564A4...	1564AP...	1564AW30...	1564AW60...	PBRS24014...	PVLK24014...
		31.5	15	17.5	10	1564B4...	1564BP...	1564BW30...	1564BW60...	PBRS24021...	PVLK24021...

<sup>1</sup> Specify 3 digit color code. Beige (CG1) or Black (BK1).

All dimensions in inches unless specified otherwise



## 1564 Series Sloped Console Components



Photo shows combination rails

### Extra Mounting Rails

- Rails are sold in **pairs**.
- Available as **punched** combination (same as supplied with 1564 rack), panel and accessory rails.
- All rails have full EIA panel mounting (0.28" dia.) for ¼-20 bolts or 10-32 clip nuts.
- Each rail is adjustable in a 1.0" x 0.281" slot.
- Constructed of 14 gauge and finished in black.
- Clip nuts are provided with rails.

PART No.	PANEL HEIGHT OF RACK	
	INCHES	UNITS
<b>RSR_00017BK3</b>	17.50	10
<b>RSR_00026BK3</b>	26.25	15

" - Specify rail type in blank space.  
(C) Combination, (A) Accessory, (P) Panel



**Combination Rails**



**Accessory Rails**



**Panel Rails**



### Castors

- Casters supplied in a set of 4.
- Features a manufacturer's specified capacity of 400 lbs. per set.
- Constructed of twin nylon swivel wheels with zinc axles and hoods.
- Wheel has a 2.37" diameter with a final mounting height of 2.75".
- 5/16-18 threaded stem mounts into existing holes in base.

PART No.	1425P
----------	-------

**K33**

DOOR				TOP CONSOLE			
REAR		FRONT		FLUSH SOLID		SIDE	TILT
SOLID	LOUVERED	SOLID	LOUVERED	FRAME	TOP PANEL	PANELS (PAIR)	BASE
RSDF19042... <sup>1</sup>	RSDL19042... <sup>1</sup>	RSDF19026... <sup>1</sup>	RSDL19026... <sup>1</sup>	1564TC1917... <sup>1</sup>	PBRS19014... <sup>1</sup>	1564TCP17... <sup>1</sup>	564CB1917... <sup>1</sup>
RSDF19042...	RSDL19042...	RSDF19026...	RSDL19026...	1564TC1924...	PBRS19021...	1564TCP24...	1564CB1924...
RSDF24042...	RSDL24042...	RSDF24026...	RSDL24026...	1564TC2417...	PBRS24014...	1564TCP17...	1564CB2417...
RSDF24042...	RSDL24042...	RSDF24026...	RSDL24026...	1564TC2424...	PBRS24021...	1564TCP24...	1564CB2424...

All dimensions in inches unless specified otherwise

Компания «Океан Электроники» предлагает заключение долгосрочных отношений при поставках импортных электронных компонентов на взаимовыгодных условиях!

Наши преимущества:

- Поставка оригинальных импортных электронных компонентов напрямую с производств Америки, Европы и Азии, а так же с крупнейших складов мира;
- Широкая линейка поставок активных и пассивных импортных электронных компонентов (более 30 млн. наименований);
- Поставка сложных, дефицитных, либо снятых с производства позиций;
- Оперативные сроки поставки под заказ (от 5 рабочих дней);
- Экспресс доставка в любую точку России;
- Помощь Конструкторского Отдела и консультации квалифицированных инженеров;
- Техническая поддержка проекта, помощь в подборе аналогов, поставка прототипов;
- Поставка электронных компонентов под контролем ВП;
- Система менеджмента качества сертифицирована по Международному стандарту ISO 9001;
- При необходимости вся продукция военного и аэрокосмического назначения проходит испытания и сертификацию в лаборатории (по согласованию с заказчиком);
- Поставка специализированных компонентов военного и аэрокосмического уровня качества (Xilinx, Altera, Analog Devices, Intersil, Interpoint, Microsemi, Actel, Aeroflex, Peregrine, VPT, Syfer, Eurofarad, Texas Instruments, MS Kennedy, Miteq, Cobham, E2V, MA-COM, Hittite, Mini-Circuits, General Dynamics и др.);

Компания «Океан Электроники» является официальным дистрибьютором и эксклюзивным представителем в России одного из крупнейших производителей разъемов военного и аэрокосмического назначения «JONHON», а так же официальным дистрибьютором и эксклюзивным представителем в России производителя высокотехнологичных и надежных решений для передачи СВЧ сигналов «FORSTAR».



## JONHON

«JONHON» (основан в 1970 г.)

Разъемы специального, военного и аэрокосмического назначения:

(Применяются в военной, авиационной, аэрокосмической, морской, железнодорожной, горно- и нефтедобывающей отраслях промышленности)

«FORSTAR» (основан в 1998 г.)

ВЧ соединители, коаксиальные кабели,  
кабельные сборки и микроволновые компоненты:

(Применяются в телекоммуникациях гражданского и специального назначения, в средствах связи, РЛС, а так же военной, авиационной и аэрокосмической отраслях промышленности).



Телефон: 8 (812) 309-75-97 (многоканальный)

Факс: 8 (812) 320-03-32

Электронная почта: [ocean@oceanchips.ru](mailto:ocean@oceanchips.ru)

Web: <http://oceanchips.ru/>

Адрес: 198099, г. Санкт-Петербург, ул. Калинина, д. 2, корп. 4, лит. А