



Is Now Part of



ON Semiconductor®

To learn more about ON Semiconductor, please visit our website at
www.onsemi.com

Please note: As part of the Fairchild Semiconductor integration, some of the Fairchild orderable part numbers will need to change in order to meet ON Semiconductor's system requirements. Since the ON Semiconductor product management systems do not have the ability to manage part nomenclature that utilizes an underscore (_), the underscore (_) in the Fairchild part numbers will be changed to a dash (-). This document may contain device numbers with an underscore (_). Please check the ON Semiconductor website to verify the updated device numbers. The most current and up-to-date ordering information can be found at www.onsemi.com. Please email any questions regarding the system integration to Fairchild_questions@onsemi.com.

ON Semiconductor and the ON Semiconductor logo are trademarks of Semiconductor Components Industries, LLC dba ON Semiconductor or its subsidiaries in the United States and/or other countries. ON Semiconductor owns the rights to a number of patents, trademarks, copyrights, trade secrets, and other intellectual property. A listing of ON Semiconductor's product/patent coverage may be accessed at www.onsemi.com/site/pdf/Patent-Marking.pdf. ON Semiconductor reserves the right to make changes without further notice to any products herein. ON Semiconductor makes no warranty, representation or guarantee regarding the suitability of its products for any particular purpose, nor does ON Semiconductor assume any liability arising out of the application or use of any product or circuit, and specifically disclaims any and all liability, including without limitation special, consequential or incidental damages. Buyer is responsible for its products and applications using ON Semiconductor products, including compliance with all laws, regulations and safety requirements or standards, regardless of any support or applications information provided by ON Semiconductor. "Typical" parameters which may be provided in ON Semiconductor data sheets and/or specifications can and do vary in different applications and actual performance may vary over time. All operating parameters, including "Typicals" must be validated for each customer application by customer's technical experts. ON Semiconductor does not convey any license under its patent rights nor the rights of others. ON Semiconductor products are not designed, intended, or authorized for use as a critical component in life support systems or any FDA Class 3 medical devices or medical devices with a same or similar classification in a foreign jurisdiction or any devices intended for implantation in the human body. Should Buyer purchase or use ON Semiconductor products for any such unintended or unauthorized application, Buyer shall indemnify and hold ON Semiconductor and its officers, employees, subsidiaries, affiliates, and distributors harmless against all claims, costs, damages, and expenses, and reasonable attorney fees arising out of, directly or indirectly, any claim of personal injury or death associated with such unintended or unauthorized use, even if such claim alleges that ON Semiconductor was negligent regarding the design or manufacture of the part. ON Semiconductor is an Equal Opportunity/Affirmative Action Employer. This literature is subject to all applicable copyright laws and is not for resale in any manner.

HCPL0700, HCPL0701, HCPL0730, HCPL0731

Low Input Current High Gain Split Darlington Optocouplers

Single Channel: HCPL0700, HCPL0701, Dual Channel: HCPL0730, HCPL0731

Features

- Low input current: 0.5mA
- Superior CTR: 2000%
- Superior CMR – 10 kV/μs
- CTR guaranteed 0°C to 70°C
- U.L. Recognized (file# E90700)
- VDE 0884 recognized (file# 136616)
– approval pending for HCPL0730/0731
- BSI recognized (file# 8661, 8662)
– HCPL0700/0701 only

Applications

- Digital logic ground isolation
- Telephone ring detector
- EIA-RS-232C line receiver
- High common mode noise line receiver
- μP bus isolation
- Current loop receiver

Description

The HCPL0700, HCPL0701, HCPL0730 and HCPL0731 optocouplers consist of an AlGaAs LED optically coupled to a high gain split darlington photodetector housed in a compact 8-pin small outline package. The HCPL0730 and HCPL0731 devices have two channels per package for optimum mounting density.

The split darlington configuration separating the input photodiode and the first stage gain from the output transistor permits lower output saturation voltage and higher speed operation than possible with conventional darlington phototransistor optocoupler.

The combination of a very low input current of 0.5mA and a high current transfer ratio of 2000% makes this family particularly useful for input interface to MOS, CMOS, LSTTL and EIA RS232C, while output compatibility is ensured to CMOS as well as high fan-out TTL requirements.

Schematics

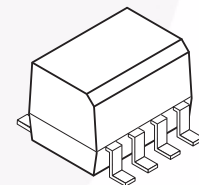
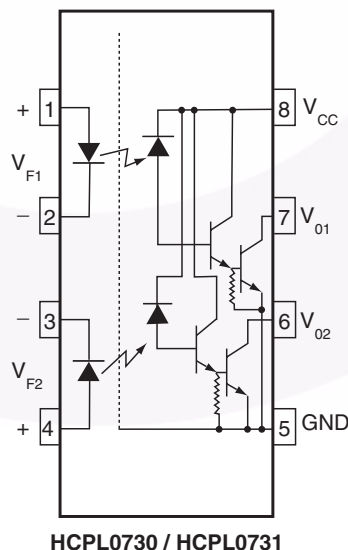

Truth Table

LED	V _O
ON	LOW
OFF	HIGH

Absolute Maximum Ratings ($T_A = 25^\circ\text{C}$ unless otherwise specified)

Stresses exceeding the absolute maximum ratings may damage the device. The device may not function or be operable above the recommended operating conditions and stressing the parts to these levels is not recommended. In addition, extended exposure to stresses above the recommended operating conditions may affect device reliability. The absolute maximum ratings are stress ratings only.

Symbol	Parameter	Value	Units	
T_{STG}	Storage Temperature	-40 to +125	$^\circ\text{C}$	
T_{OPR}	Operating Temperature	-40 to +85	$^\circ\text{C}$	
	Reflow Temperature Profile (Refer to page 12)			
EMITTER				
I_F (avg)	DC/Average Forward Input Current	20	mA	
I_F (pk)	Peak Forward Input Current (50% duty cycle, 1 ms P.W.)	40	mA	
I_F (trans)	Peak Transient Input Current - ($\leq 1 \mu\text{s}$ P.W., 300 pps)	1.0	A	
V_R	Reverse Input Voltage	5	V	
P_D	Input Power Dissipation	35	mW	
DETECTOR				
I_O (avg)	Average Output Current (Pin 6)	60	mA	
V_{EBR}	Emitter-Base Reverse Voltage	HCPL0700/HCPL0701	0.5	V
V_{CC}, V_O	Supply Voltage, Output Voltage	HCPL0700/HCPL0730	-0.5 to 7	V
		HCPL0701/HCPL0731	-0.5 to 18	
P_D	Output power dissipation	100	mW	

Electrical Characteristics ($T_A = 0$ to 70°C unless otherwise specified)

Individual Component Characteristics

Symbol	Parameter	Test Conditions	Device	Min.	Typ.*	Max	Unit	
EMITTER								
V_F	Input Forward Voltage	$I_F = 1.6\text{mA}$	$T_A = 25^\circ\text{C}$	HCPL0700/01	1.0	1.25	1.7	V
				HCPL0730/31		1.35		
		All			1.75			
BV_R	Input Reverse Breakdown Voltage	$T_A = 25^\circ\text{C}$, $I_R = 10\mu\text{A}$	All	5.0				
DETECTOR								
I_{OH}	Logic High Output Current	$I_F = 0\text{mA}$, $V_O = V_{CC} = 18\text{V}$	HCPL0701/31		0.01	100	μA	
		$I_F = 0\text{mA}$, $V_O = V_{CC} = 7\text{V}$	HCPL0700/30		0.01	250		
I_{CCL}	Logic Low Supply Current	$I_F = 1.6\text{mA}$, $V_O = \text{Open}$, $V_{CC} = 18\text{V}$	HCPL0700/01		0.4	1.5	mA	
		$I_{F1} = I_{F2} = 1.6\text{mA}$, $V_{CC} = 7\text{V}$	HCPL0730		0.8			
		$V_{O1} = V_{O2} = \text{Open}$, $V_{CC} = 18\text{V}$	HCPL0731		1			
I_{CCH}	Logic High Supply Current	$I_F = 0\text{mA}$, $V_O = \text{Open}$, $V_{CC} = 18\text{V}$	HCPL0700/01			10	μA	
		$I_{F1} = I_{F2} = 0$, $V_{CC} = 7\text{V}$	HCPL0730		0.001	20		
		$V_{O1} = V_{O2} = \text{Open}$, $V_{CC} = 18\text{V}$	HCPL0731		0.01			

Transfer Characteristics

Symbol	Parameter	Test Conditions	Device	Min.	Typ.*	Max.	Unit
CTR	COUPLED Current Transfer Ratio (Note 1, 2)	$I_F = 0.5\text{mA}$, $V_O = 0.4\text{V}$, $V_{CC} = 4.5\text{V}$	HCPL0701/31	400		5000	%
		$I_F = 1.6\text{mA}$, $V_O = 0.4\text{V}$, $V_{CC} = 4.5\text{V}$	HCPL0700	300		2600	
			HCPL0701	500		2600	
			HCPL0730	300		5000	
			HCPL0731	500		5000	
V_{OL}	Logic Low Output Voltage	$I_F = 0.5\text{mA}$, $I_O = 2\text{mA}$, $V_{CC} = 4.5\text{V}$	HCPL0701			0.4	V
		$I_F = 1.6\text{mA}$, $I_O = 8\text{mA}$, $V_{CC} = 4.5\text{V}$	HCPL0731			0.4	
		$I_F = 5\text{mA}$, $I_O = 15\text{mA}$, $V_{CC} = 4.5\text{V}$				0.4	
		$I_F = 12\text{mA}$, $I_O = 24\text{mA}$, $V_{CC} = 4.5\text{V}$				0.4	
		$I_F = 1.6\text{mA}$, $I_O = 4.8\text{mA}$, $V_{CC} = 4.5\text{V}$	HCPL0700/0730			0.4	

Isolation Characteristics

Symbol	Characteristics	Test Conditions	Min.	Typ.*	Max.	Unit
I_{I-O}	Input-Output Insulation Leakage Current	Relative humidity = 45%, $T_A = 25^\circ\text{C}$, $t = 5\text{ s}$, $V_{I-O} = 3000\text{ VDC}$ (Note 4)			1.0	μA
V_{ISO}	Withstand Insulation Test Voltage	$R_H \leq 50\%$, $T_A = 25^\circ\text{C}$, $I_{I-O} \leq 2\mu\text{A}$, $t = 1\text{ min.}$ (Note 4, 5)	2500			V_{RMS}
R_{I-O}	Resistance (Input to Output)	$V_{I-O} = 500\text{ VDC}$ (Note 4)		10^{12}		Ω

 *All typicals at $T_A = 25^\circ\text{C}$

Electrical Characteristics ($T_A = 0$ to 70°C unless otherwise specified)

Switching Characteristics ($V_{CC} = 5\text{V}$)

Symbol	Parameter	Test Conditions	Device	Min.	Typ.*	Max.	Unit			
T_{PHL}	Propagation Delay Time to Logic Low (Note 2) (Fig. 14)	$R_L = 4.7\text{k}\Omega$, $I_F = 0.5\text{mA}$ $T_A = 25^\circ\text{C}$	HCPL0701			30	μs			
			HCPL0731			120				
			HCPL0701		3	25				
			HCPL0731		5	100				
		$R_L = 270\ \Omega$, $I_F = 12\text{mA}$ $T_A = 25^\circ\text{C}$	HCPL0701				2			
			HCPL0731				3			
			HCPL0701		0.3	1				
			HCPL0731		0.4	2				
		$R_L = 2.2\ \text{k}\Omega$, $I_F = 1.6\text{mA}$ $T_A = 25^\circ\text{C}$	HCPL0700				15			
			HCPL0730/0731				25			
			HCPL0700		1	10				
			HCPL0730/0731		2	20				
T_{PLH}	Propagation Delay Time to Logic High (Note 2) (Fig. 14)	$R_L = 4.7\ \text{k}\Omega$, $I_F = 0.5\text{mA}$ $T_A = 25^\circ\text{C}$	HCPL0701/31			90	μs			
			HCPL0701/31		12	60				
		$R_L = 270\ \Omega$, $I_F = 12\text{mA}$ $T_A = 25^\circ\text{C}$	HCPL0701					10		
			HCPL0731					15		
			HCPL0701		1.6	7				
			HCPL0731		1.6	10				
		$R_L = 2.2\ \text{k}\Omega$, $I_F = 1.6\text{mA}$ $T_A = 25^\circ\text{C}$	HCPL0700/30/31					50		
			HCPL0700/30/31		7	35				
		ICM_H	Common Mode Transient Immunity at Logic High	$I_F = 0\text{mA}$, $ V_{CM} = 10\ \text{V}_{P-P}$, $T_A = 25^\circ\text{C}$, $R_L = 2.2\text{k}\Omega$ (Note 3) (Fig. 15)	ALL	1,000		10,000		$\text{V}/\mu\text{s}$
		ICM_L	Common Mode Transient Immunity at Logic Low	$I_F = 1.6\text{mA}$, $ V_{CM} = 10\ \text{V}_{P-P}$, $T_A = 25^\circ\text{C}$, $R_L = 2.2\ \text{k}\Omega$ (Note 3) (Fig. 15)	ALL	1,000		10,000		$\text{V}/\mu\text{s}$

*All typicals at $T_A = 25^\circ\text{C}$

Notes:

- Current Transfer Ratio is defined as a ratio of output collector current, I_O , to the forward LED input current, I_F , times 100%.
- Pin 7 open. Use of a resistor between pins 5 and 7 will decrease gain and delay time.
- Common mode transient immunity in logic high level is the maximum tolerable (positive) dV_{CM}/dt on the leading edge of the common mode pulse signal, V_{CM} , to assure that the output will remain in a logic high state (i.e., $V_O > 2.0\text{V}$). Common mode transient immunity in logic low level is the maximum tolerable (negative) dV_{CM}/dt on the trailing edge of the common mode pulse signal, V_{CM} , to assure that the output will remain in a logic low state (i.e., $V_O < 0.8\ \text{V}$).
- Device is considered a two terminal device: Pins 1, 2, 3 and 4 are shorted together and Pins 5, 6, 7 and 8 are shorted together.
- 2500 VAC RMS for 1 minute duration is equivalent to 3000 VAC RMS for 1 second duration.

Typical Performance Curves

Fig. 1 Propagation Delay vs. Temperature (HCPL0700, HCPL0701)

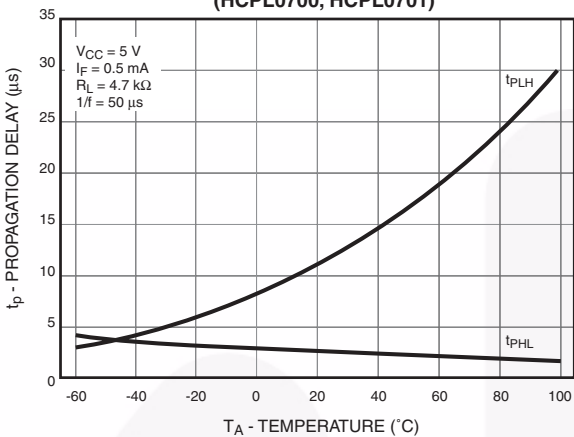

Fig. 2 Propagation Delay vs. Temperature (HCPL0700, HCPL0701)

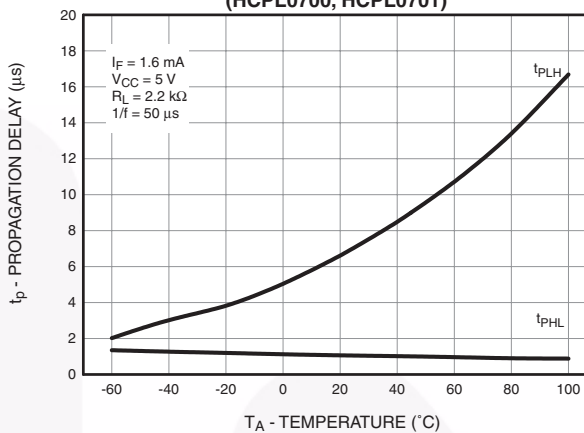

Fig. 3 Propagation Delay vs. Temperature (HCPL0700, HCPL0701)

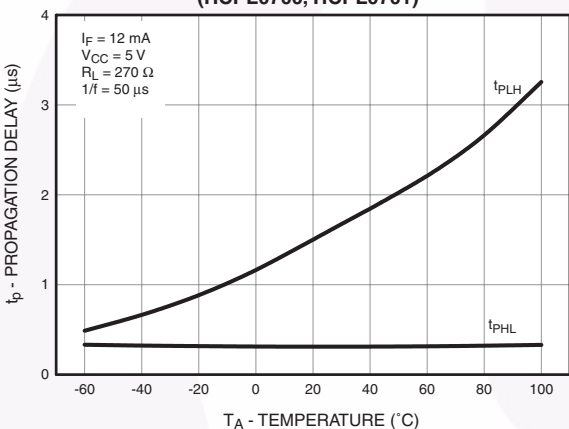

Fig. 4 Logic High Output Current vs. Temperature (HCPL0700, HCPL0701)

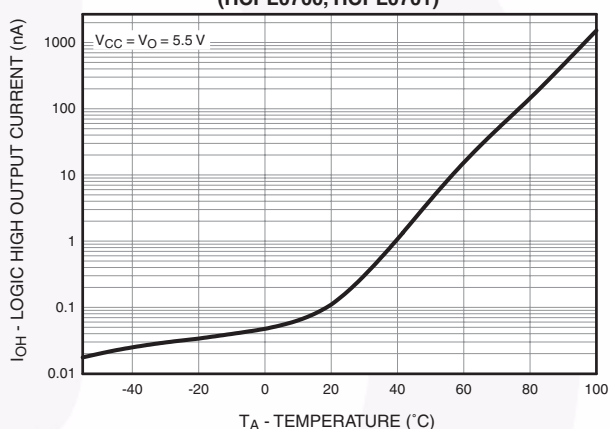

Fig. 5 Propagation Delay vs. Input Forward Current (HCPL0730, HCPL0731)

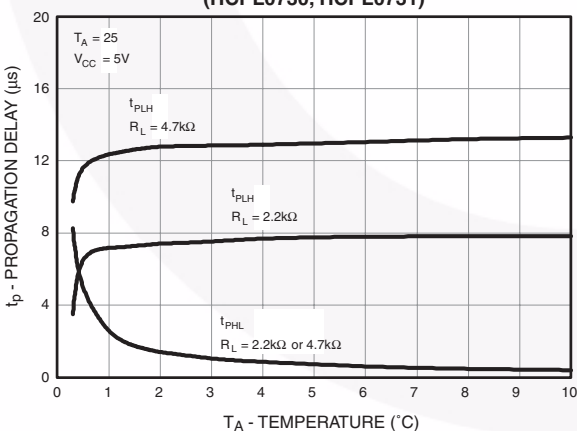
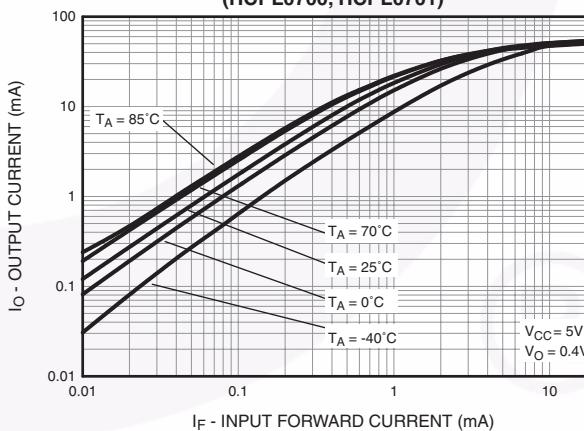

Fig. 6 Output Current vs. Input Forward Current (HCPL0700, HCPL0701)



Typical Performance Curves (Continued)

Fig. 7 Input Forward Current vs. Forward Voltage (HCPL0700, HCPL0701)

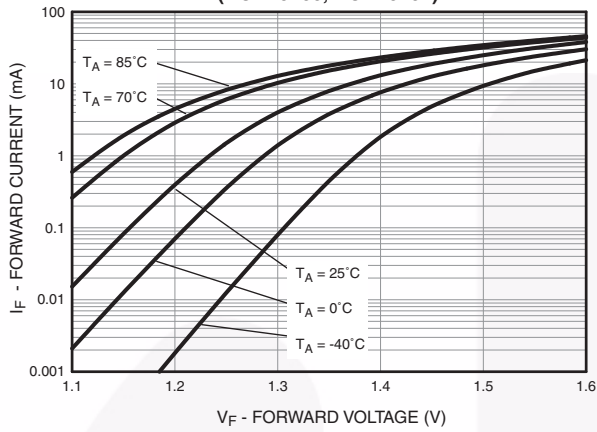

Fig. 8 Input Forward Current vs. Forward Voltage (HCPL0730, HCPL0731)

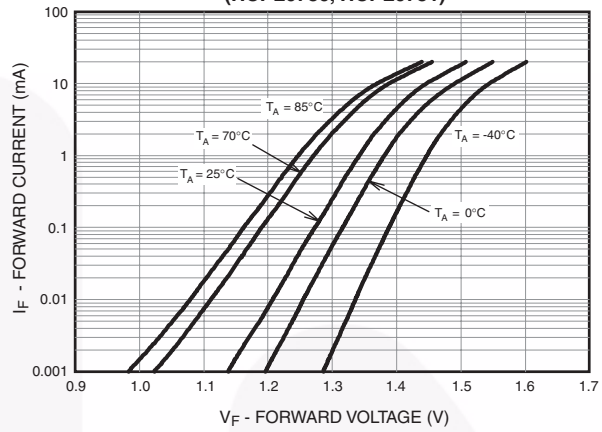

Fig. 9 Logic Low Supply Current vs. Input Forward Current (HCPL0700, HCPL0701)

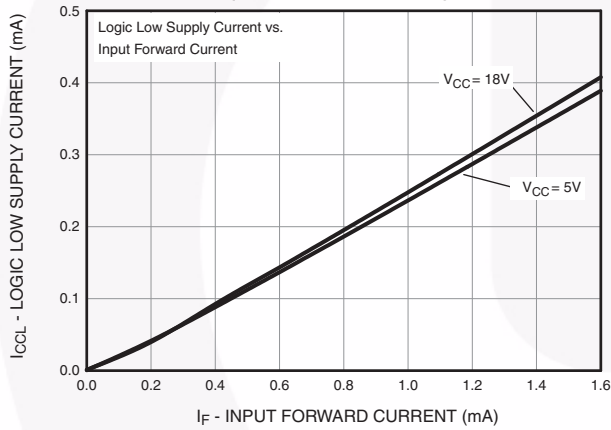

Fig. 10 Supply Current vs. Input Forward Current (HCPL0730, HCPL0731)

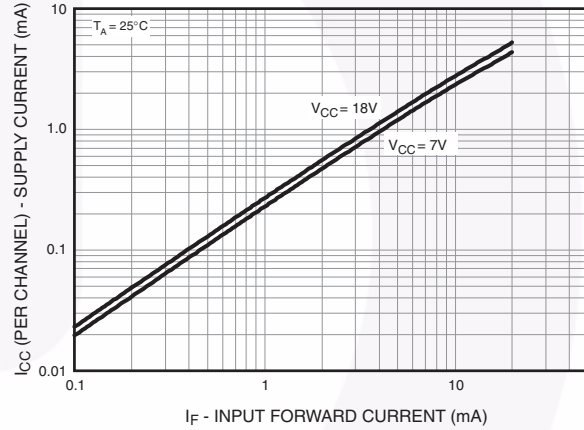

Fig. 11 DC Transfer Characteristics (HCPL0700, HCPL0701)

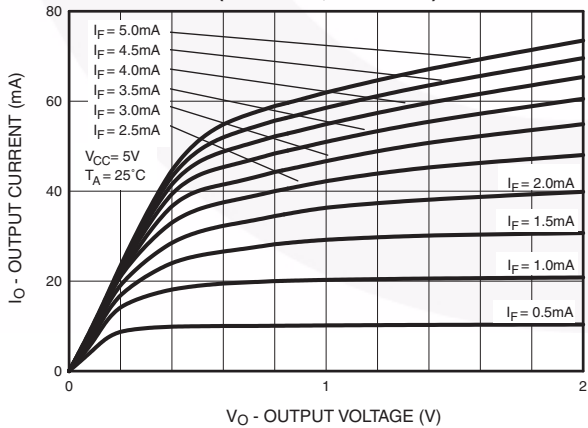
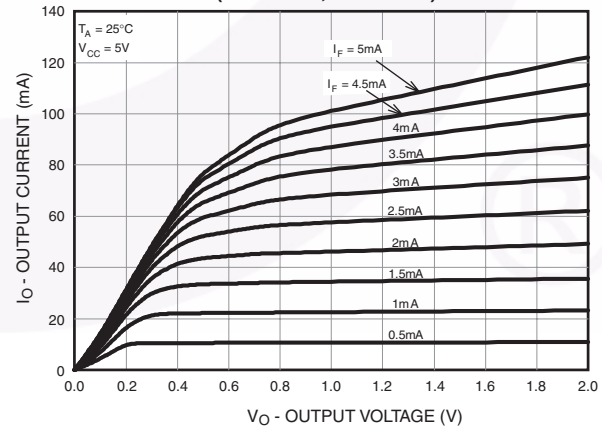
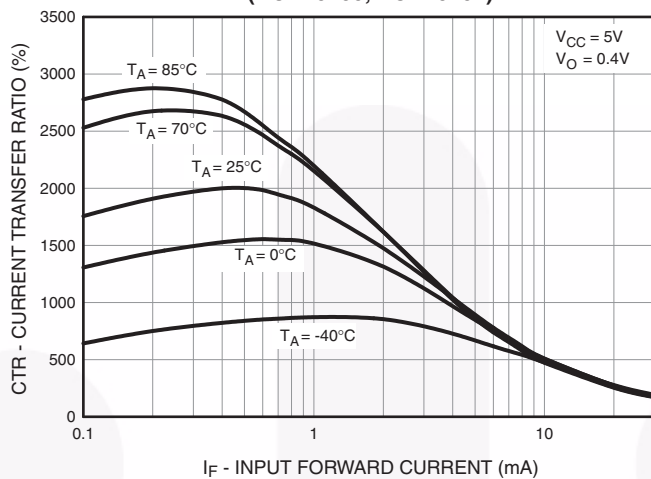

Fig. 12 DC Transfer Characteristics (HCPL0730, HCPL0731)



Typical Performance Curves (Continued)

Fig. 13 Current Transfer Ratio vs. Input Forward Current (HCPL0700, HCPL0701)



Test Circuits

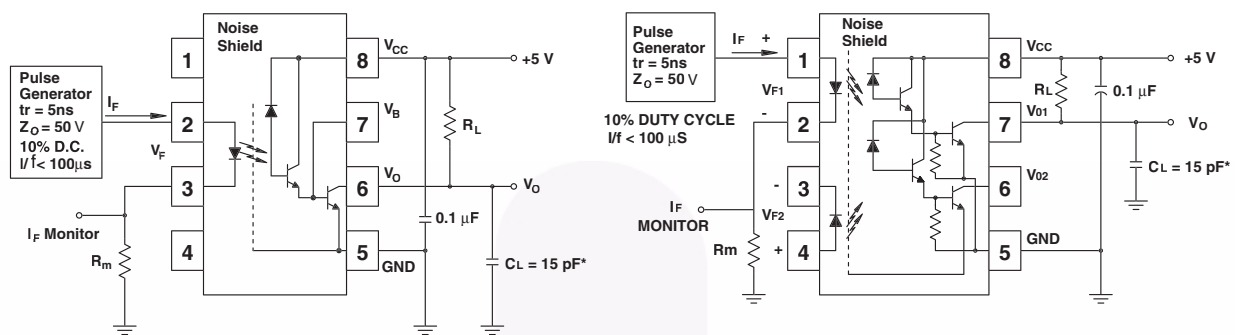

Test Circuit for HCPL-0700 and HCPL-0701

Test Circuit for HCPL-0730 and HCPL-0731

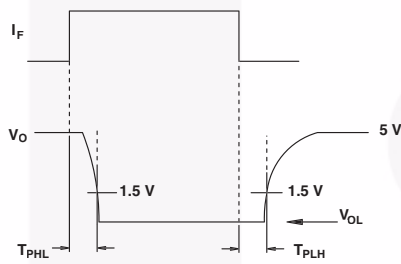
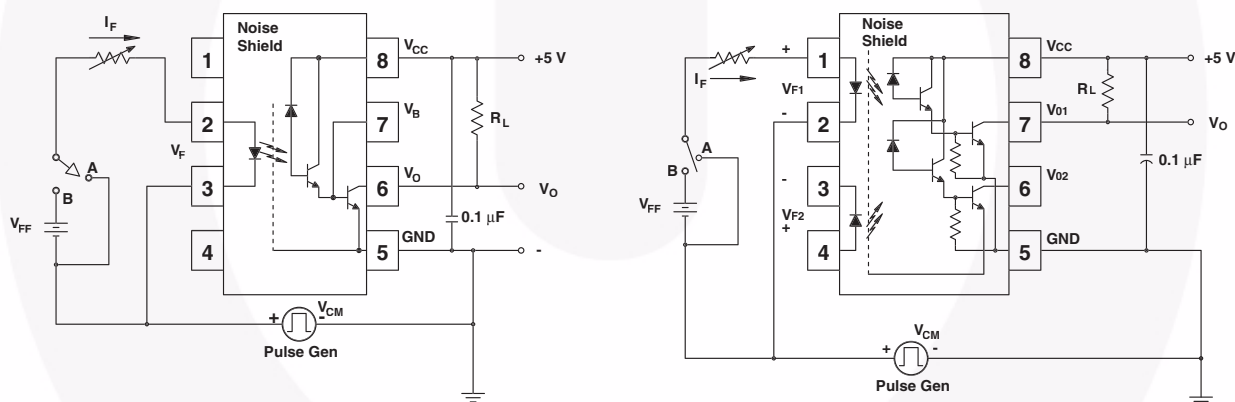

Fig. 14 Switching Time Test Circuit



Test Circuit for HCPL-0700 and HCPL-0701

Test Circuit for HCPL-0730 and HCPL-0731

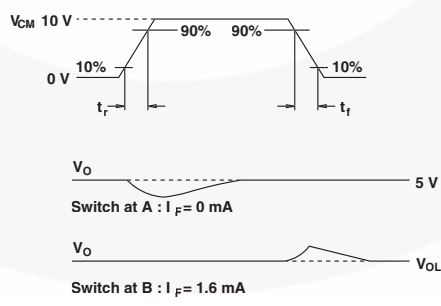

Fig. 15 Common Mode Immunity Test Circuit

Ordering Information

Option	Part Number Example	Description
V	HCPL0700V	VDE 0884
R2	HCPL0700R2	Tape and reel (2500 units per reel)
R2V	HCPL0700R2V	VDE 0884, Tape and reel (2500 units per reel)

Marking Information



Definitions	
1	Fairchild logo
2	Device number
3	VDE mark (Note: Only appears on parts ordered with VDE option – See order entry table)
4	One digit year code, e.g., '3'
5	Two digit work week ranging from '01' to '53'
6	Assembly package code

Reflow Profile

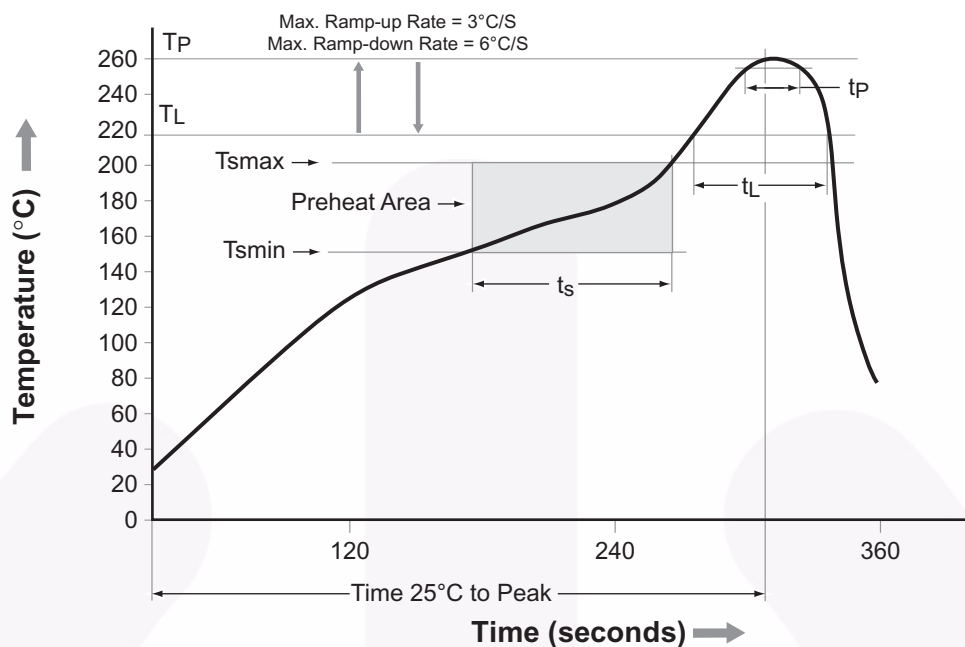

Profile Feature	Pb-Free Assembly Profile
Temperature Min. (Tsmín)	150°C
Temperature Max. (Tsmáx)	200°C
Time (ts) from (Tsmín to Tsmáx)	60–120 seconds
Ramp-up Rate (tL to tp)	3°C/second max.
Liquidous Temperature (TL)	217°C
Time (tL) Maintained Above (TL)	60–150 seconds
Peak Body Package Temperature	260°C +0°C / -5°C
Time (tp) within 5°C of 260°C	30 seconds
Ramp-down Rate (TP to TL)	6°C/second max.
Time 25°C to Peak Temperature	8 minutes max.



NOTES:

- A) NO STANDARD APPLIES TO THIS PACKAGE
- B) ALL DIMENSIONS ARE IN MILLIMETERS.
- C) DIMENSIONS DO NOT INCLUDE MOLD FLASH OR BURRS.
- D) LANDPATTERN STANDARD: SOIC127P600X175-8M.
- E) DRAWING FILENAME: MKT-M08Erev5



ON Semiconductor and  are trademarks of Semiconductor Components Industries, LLC dba ON Semiconductor or its subsidiaries in the United States and/or other countries. ON Semiconductor owns the rights to a number of patents, trademarks, copyrights, trade secrets, and other intellectual property. A listing of ON Semiconductor's product/patent coverage may be accessed at www.onsemi.com/site/pdf/Patent-Marking.pdf. ON Semiconductor reserves the right to make changes without further notice to any products herein. ON Semiconductor makes no warranty, representation or guarantee regarding the suitability of its products for any particular purpose, nor does ON Semiconductor assume any liability arising out of the application or use of any product or circuit, and specifically disclaims any and all liability, including without limitation special, consequential or incidental damages. Buyer is responsible for its products and applications using ON Semiconductor products, including compliance with all laws, regulations and safety requirements or standards, regardless of any support or applications information provided by ON Semiconductor. "Typical" parameters which may be provided in ON Semiconductor data sheets and/or specifications can and do vary in different applications and actual performance may vary over time. All operating parameters, including "Typicals" must be validated for each customer application by customer's technical experts. ON Semiconductor does not convey any license under its patent rights nor the rights of others. ON Semiconductor products are not designed, intended, or authorized for use as a critical component in life support systems or any FDA Class 3 medical devices or medical devices with a same or similar classification in a foreign jurisdiction or any devices intended for implantation in the human body. Should Buyer purchase or use ON Semiconductor products for any such unintended or unauthorized application, Buyer shall indemnify and hold ON Semiconductor and its officers, employees, subsidiaries, affiliates, and distributors harmless against all claims, costs, damages, and expenses, and reasonable attorney fees arising out of, directly or indirectly, any claim of personal injury or death associated with such unintended or unauthorized use, even if such claim alleges that ON Semiconductor was negligent regarding the design or manufacture of the part. ON Semiconductor is an Equal Opportunity/Affirmative Action Employer. This literature is subject to all applicable copyright laws and is not for resale in any manner.

PUBLICATION ORDERING INFORMATION

LITERATURE FULFILLMENT:

Literature Distribution Center for ON Semiconductor
19521 E. 32nd Pkwy, Aurora, Colorado 80011 USA
Phone: 303-675-2175 or 800-344-3860 Toll Free USA/Canada
Fax: 303-675-2176 or 800-344-3867 Toll Free USA/Canada
Email: orderlit@onsemi.com

N. American Technical Support: 800-282-9855 Toll Free
USA/Canada
Europe, Middle East and Africa Technical Support:
Phone: 421 33 790 2910
Japan Customer Focus Center
Phone: 81-3-5817-1050

ON Semiconductor Website: www.onsemi.com
Order Literature: <http://www.onsemi.com/orderlit>
For additional information, please contact your local
Sales Representative

Mouser Electronics

Authorized Distributor

Click to View Pricing, Inventory, Delivery & Lifecycle Information:

[ON Semiconductor:](#)

[HCPL0700](#) [HCPL0700R2](#) [HCPL0700V](#)

Компания «Океан Электроники» предлагает заключение долгосрочных отношений при поставках импортных электронных компонентов на взаимовыгодных условиях!

Наши преимущества:

- Поставка оригинальных импортных электронных компонентов напрямую с производств Америки, Европы и Азии, а так же с крупнейших складов мира;
- Широкая линейка поставок активных и пассивных импортных электронных компонентов (более 30 млн. наименований);
- Поставка сложных, дефицитных, либо снятых с производства позиций;
- Оперативные сроки поставки под заказ (от 5 рабочих дней);
- Экспресс доставка в любую точку России;
- Помощь Конструкторского Отдела и консультации квалифицированных инженеров;
- Техническая поддержка проекта, помощь в подборе аналогов, поставка прототипов;
- Поставка электронных компонентов под контролем ВП;
- Система менеджмента качества сертифицирована по Международному стандарту ISO 9001;
- При необходимости вся продукция военного и аэрокосмического назначения проходит испытания и сертификацию в лаборатории (по согласованию с заказчиком);
- Поставка специализированных компонентов военного и аэрокосмического уровня качества (Xilinx, Altera, Analog Devices, Intersil, Interpoint, Microsemi, Actel, Aeroflex, Peregrine, VPT, Syfer, Eurofarad, Texas Instruments, MS Kennedy, Miteq, Cobham, E2V, MA-COM, Hittite, Mini-Circuits, General Dynamics и др.);

Компания «Океан Электроники» является официальным дистрибьютором и эксклюзивным представителем в России одного из крупнейших производителей разъемов военного и аэрокосмического назначения «JONHON», а так же официальным дистрибьютором и эксклюзивным представителем в России производителя высокотехнологичных и надежных решений для передачи СВЧ сигналов «FORSTAR».



JONHON

«JONHON» (основан в 1970 г.)

Разъемы специального, военного и аэрокосмического назначения:

(Применяются в военной, авиационной, аэрокосмической, морской, железнодорожной, горно- и нефтедобывающей отраслях промышленности)

«FORSTAR» (основан в 1998 г.)

ВЧ соединители, коаксиальные кабели, кабельные сборки и микроволновые компоненты:

(Применяются в телекоммуникациях гражданского и специального назначения, в средствах связи, РЛС, а так же военной, авиационной и аэрокосмической отраслях промышленности).



Телефон: 8 (812) 309-75-97 (многоканальный)

Факс: 8 (812) 320-03-32

Электронная почта: ocean@oceanchips.ru

Web: <http://oceanchips.ru/>

Адрес: 198099, г. Санкт-Петербург, ул. Калинина, д. 2, корп. 4, лит. А