



LED Middle POWER

K140 Product Data Sheet

SZRxx Series

Created Date: 03 / 01 / 2013
Revision: 16, 06 / 06 / 2014

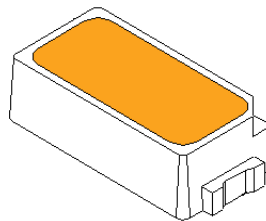

LED Middle POWER K140SZRxx Series

1. Description

The LiteON K140 Product series is a wide beam angle standard-dimension package, combining the lifetime and reliability advantages of Light Emitting Diodes with the brightness of conventional lighting. It gives you total design freedom and unmatched brightness, creating a new opportunities for solid state lighting to displace conventional lighting technologies.

1.1 Features

- Package in 8mm tape on 7" diameter reels.
- Compatible with automatic placement equipment.
- Compatible with infrared and vapor phase reflow solder process.
- EIA STD package.
- I.C. compatible.
- Meet green product and Pb-free(According to RoHS)

1.2 Available Part Numbers

| CCT | Part Number |
|-------|---------------|
| 6500K | LTW-K140SZR65 |
| 5700K | LTW-K140SZR57 |
| 5000K | LTW-K140SZR50 |
| 4000K | LTW-K140SZR40 |
| 3000K | LTW-K140SZR30 |
| 2700K | LTW-K140SZR27 |

LED Middle POWER K140SZRxx Series

2. Outline Dimensions

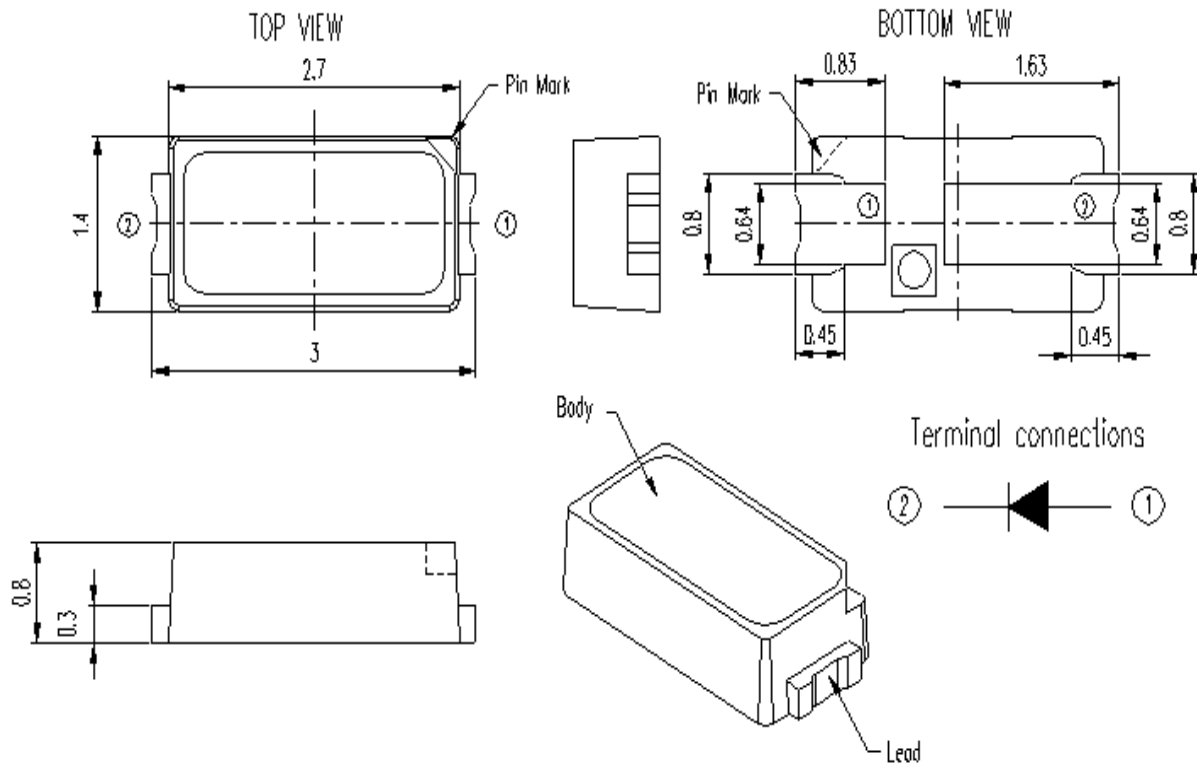

| Part No. | Lens Color | Source Color |
|---------------|------------|--------------|
| LTW-K140SZR65 | Orange | InGaN Blue |
| LTW-K140SZR57 | | |
| LTW-K140SZR50 | | |
| LTW-K140SZR40 | | |
| LTW-K140SZR30 | | |
| LTW-K140SZR27 | | |

Notes:

1. All dimensions are in millimeters.
2. Tolerance is ± 0.1 mm (.008") unless otherwise noted.

LED Middle POWER K140SZRxx Series

3. Absolute Maximum Ratings at $T_a=25^{\circ}\text{C}$

| Parameter | Symbol | Rating | Unit |
|-----------------------------|-----------|------------|--------------------|
| Power Dissipation | P_o | 280 | mW |
| Continuous Forward Current | I_F | 80 | mA |
| Operating Temperature Range | T_{opr} | -40 ~ +80 | $^{\circ}\text{C}$ |
| Storage Temperature Range | T_{stg} | -40 ~ +100 | $^{\circ}\text{C}$ |
| Junction Temperature | T_j | ≤ 115 | $^{\circ}\text{C}$ |

Notes :

1. Forbid to operating at reverse voltage condition for long.

LED Middle POWER K140SZRxx Series

4. Electro-Optical Characteristics

4.1 Typical Performance

| Parameter | Symbol | Values | | | | | | | Unit | Test Condition |
|------------------------------|-------------------|--------|-------|-------|-------|-------|-------|-------|------|-----------------------|
| | | Typ. | 2700 | 3000 | 4000 | 5000 | 5700 | 6500 | | |
| Correlated Color Temperature | CCT | Typ. | 2700 | 3000 | 4000 | 5000 | 5700 | 6500 | °K | |
| Chromaticity Coordinates | x | Typ. | 0.458 | 0.434 | 0.382 | 0.345 | 0.329 | 0.312 | - | I _F = 60mA |
| | y | Typ. | 0.410 | 0.403 | 0.380 | 0.355 | 0.342 | 0.328 | | |
| Luminous Flux ¹ | Φ _v | Min | 16 | 17 | 18 | 19 | 19 | 18 | lm | |
| | | Typ. | 20.2 | 21.0 | 22.2 | 23.7 | 23.2 | 22.7 | | |
| | | Max. | 24 | 25 | 26 | 27 | 27 | 26 | | |
| Optical Efficiency | η _{opt} | Typ. | 105 | 109 | 116 | 123 | 121 | 118 | lm/W | |
| Color Rendering Index | CRI | Min. | 80 | | | | | | - | |
| Viewing Angle | 2θ _{1/2} | Typ. | 120 | | | | | | deg | |
| Forward Voltage | V _F | Min | 2.9 | | | | | | V | |
| | | Typ. | 3.2 | | | | | | | |
| | | Max. | 3.5 | | | | | | | |
| Thermal Resistance | R _{jt} | Typ. | 30 | | | | | | °C/W | |
| Reverse Current | I _R | Max. | 100 | | | | | | μA | V _R = 5V |

Notes

- Luminous flux is the total luminous flux output as measured with an integrating sphere.
- I_v (flux Φ_v) classification code is marked on each packing bag.
- The chromaticity coordinates (x, y) is derived from the 1931 CIE chromaticity diagram.
- Caution in ESD:

Static Electricity and surge damages the LED. It is recommended using a wrist band or anti-electrostatic glove when handling the LED. All devices, equipment and machinery must be properly grounded.

- CAS140B is the test standard for the chromaticity coordinates (x, y) & Φ_v.
- The chromaticity coordinates (x, y) guarantee should be added +/- 0.01 tolerances
- CRI measurement allowance is ±5
- The Thermal Resistance is defined

as the figure, R_{jt} is the R_{th} from T_j to Thermal Pad Solder:

Reference for thermal resistance:

Using 2.5x 2.5x 0.17 cm Aluminum MCPCB, R_{jt}=30°C/W, R_{js}=35 °C/W

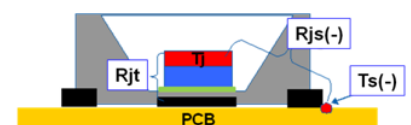

- ◆ R_{js} = R_{th} of T_j to T_s
- ◆ R_{jt} = R_{th} of T_j to Thermal pad solder
- ◆ R_{th} definition in Datasheet = R_{jt}
- ◆ R_{jt} < R_{jc}
- ◆ T_j = R_{js}*W+T_s

LED Middle POWER K140SZRxx Series

4.2 Forward Current vs. Lumen and Voltage

| Current (mA) | VF (V) | Lumen (lm) | | | | | |
|-----------------|-----------|------------|-------|-------|-------|-------|-------|
| | | 2700K | 3000K | 4000K | 5000K | 5700K | 6500K |
| 10 | 2.85 | 3.8 | 4.0 | 4.2 | 4.4 | 4.3 | 4.3 |
| 20 | 2.94 | 7.5 | 7.7 | 8.2 | 8.7 | 8.5 | 8.3 |
| 30 | 3.02 | 10.8 | 11.2 | 12.0 | 12.7 | 12.4 | 12.2 |
| 40 | 3.08 | 14.1 | 14.6 | 15.6 | 16.5 | 16.2 | 15.8 |
| 50 | 3.14 | 17.2 | 17.7 | 18.9 | 20.1 | 19.7 | 19.2 |
| 60 | 3.20 | 20.2 | 21.0 | 22.2 | 23.7 | 23.2 | 22.7 |
| 70 | 3.25 | 23.0 | 23.9 | 25.4 | 27.0 | 26.5 | 25.8 |
| 80 | 3.31 | 25.9 | 26.8 | 28.5 | 30.3 | 29.7 | 29.1 |

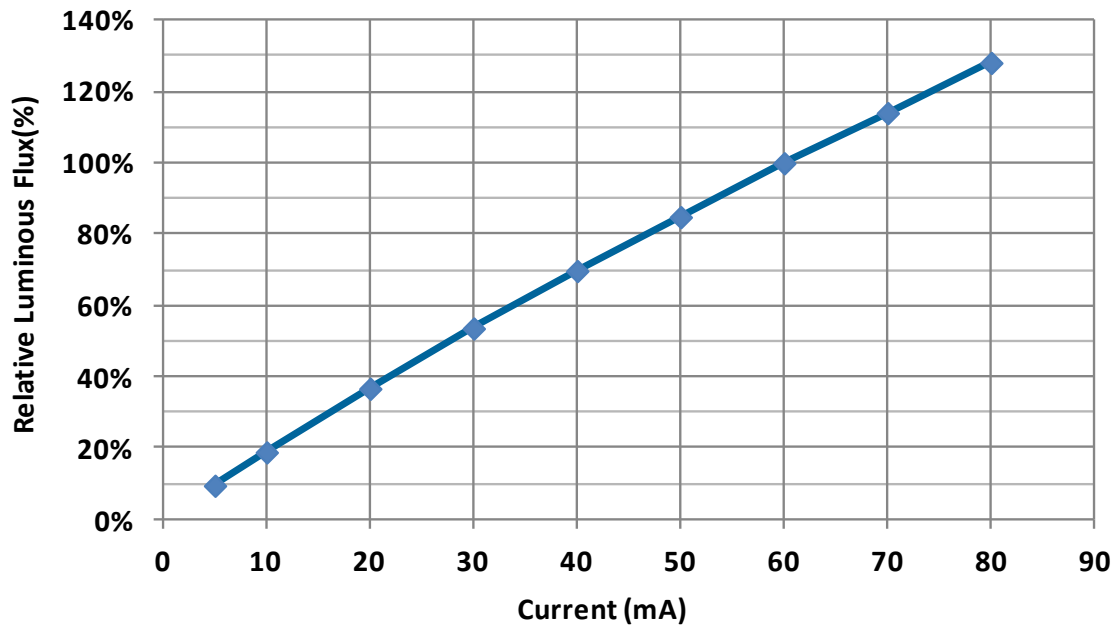

LED Middle POWER K140SZRxx Series

4.3 Relative Spectral Power Distribution at Typical Current

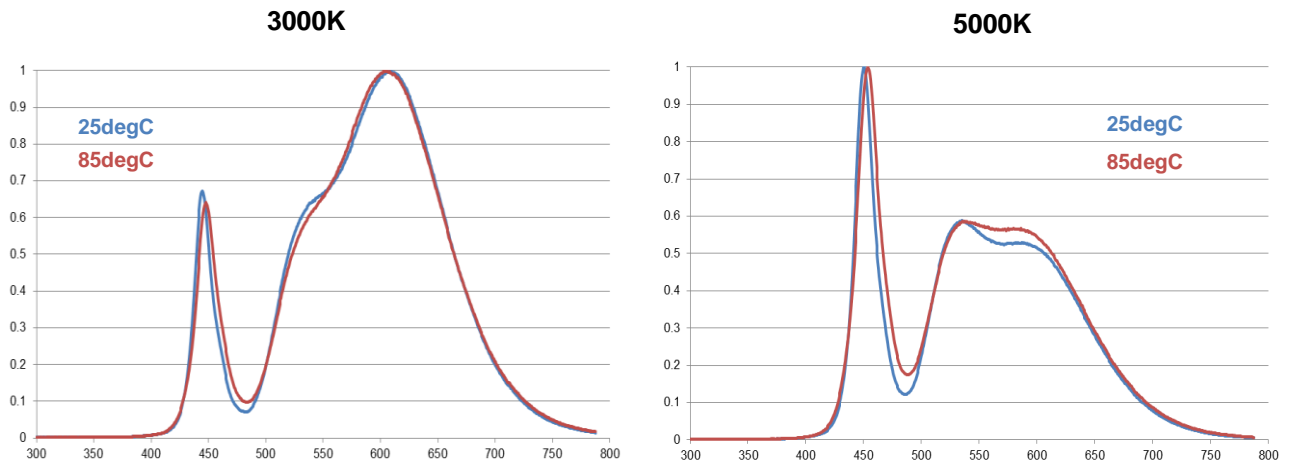

4.4 Radiation Characteristics

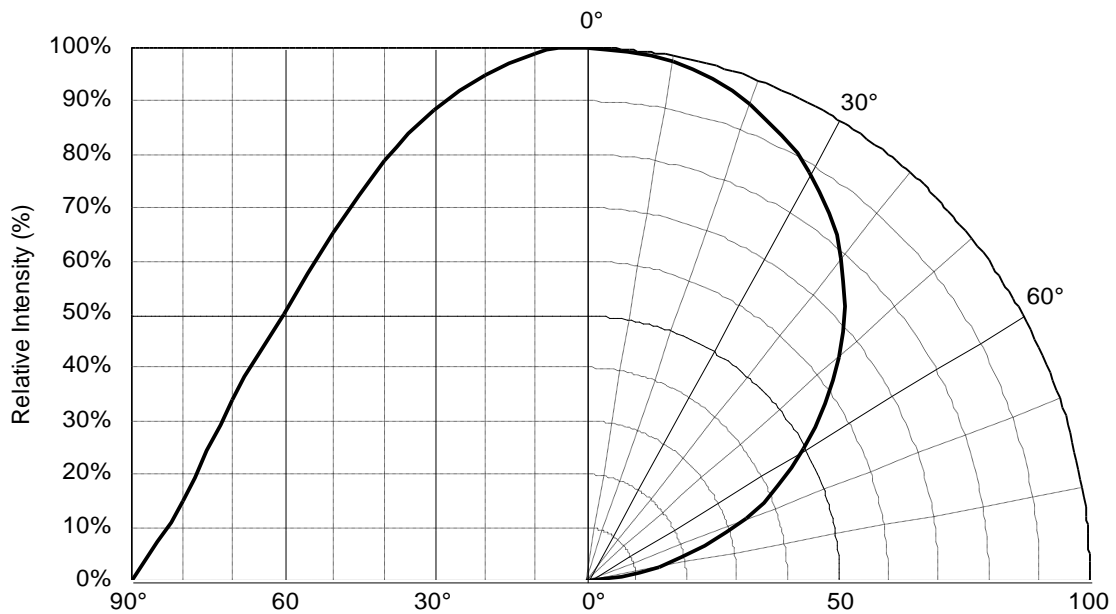

LED Middle POWER K140SZRxx Series

4.5 Forward Current vs. Forward Voltage

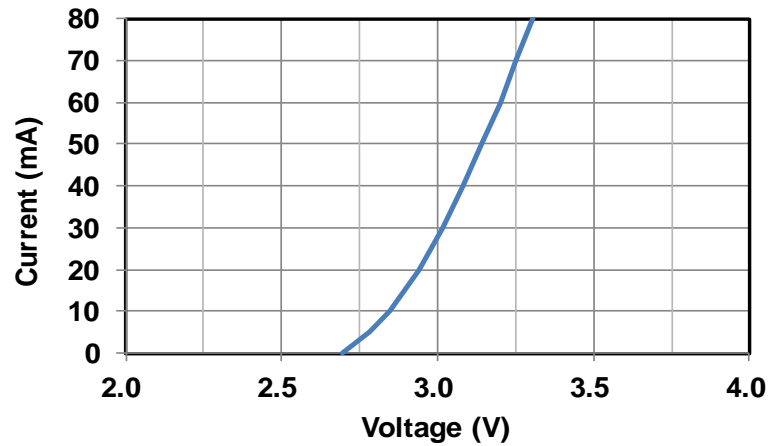

4.6 Relative Luminous Flux vs. Junction Temperature

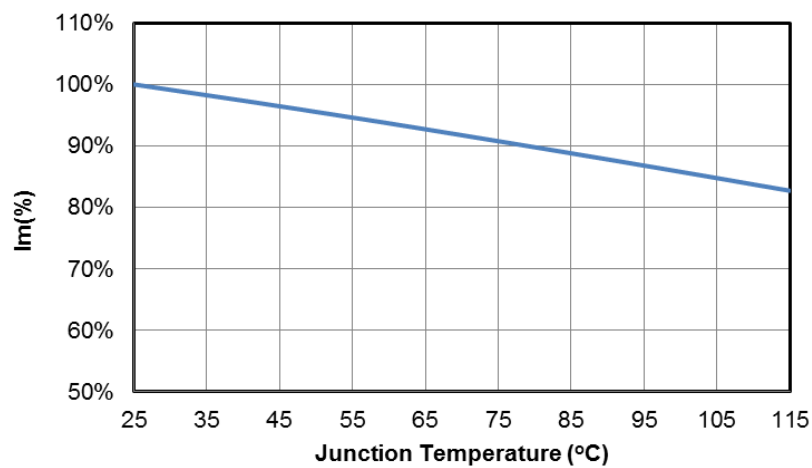

4.7 Forward Voltage vs. Junction Temperature

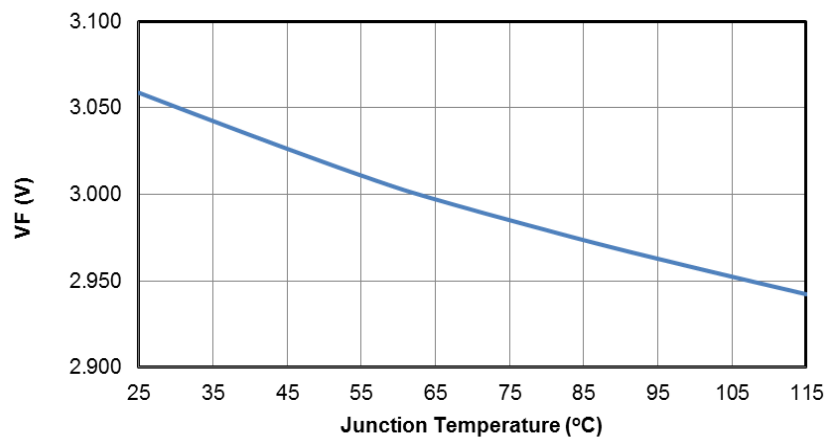

LED Middle POWER K140SZRxx Series

5. Binning Definition

5.1 Color Bin

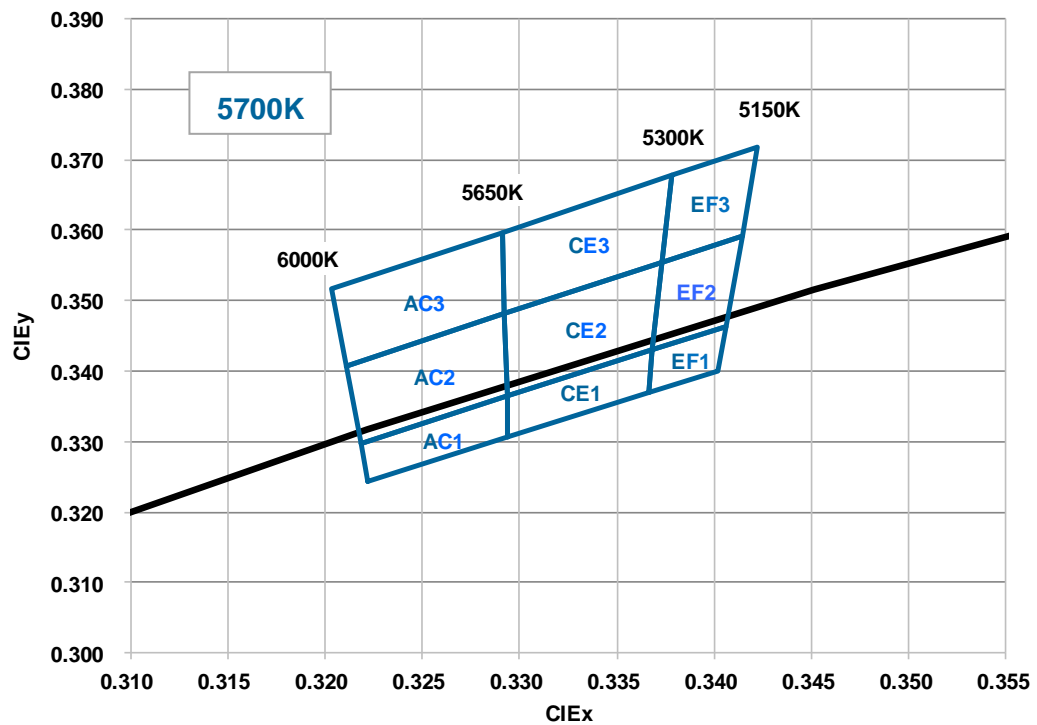
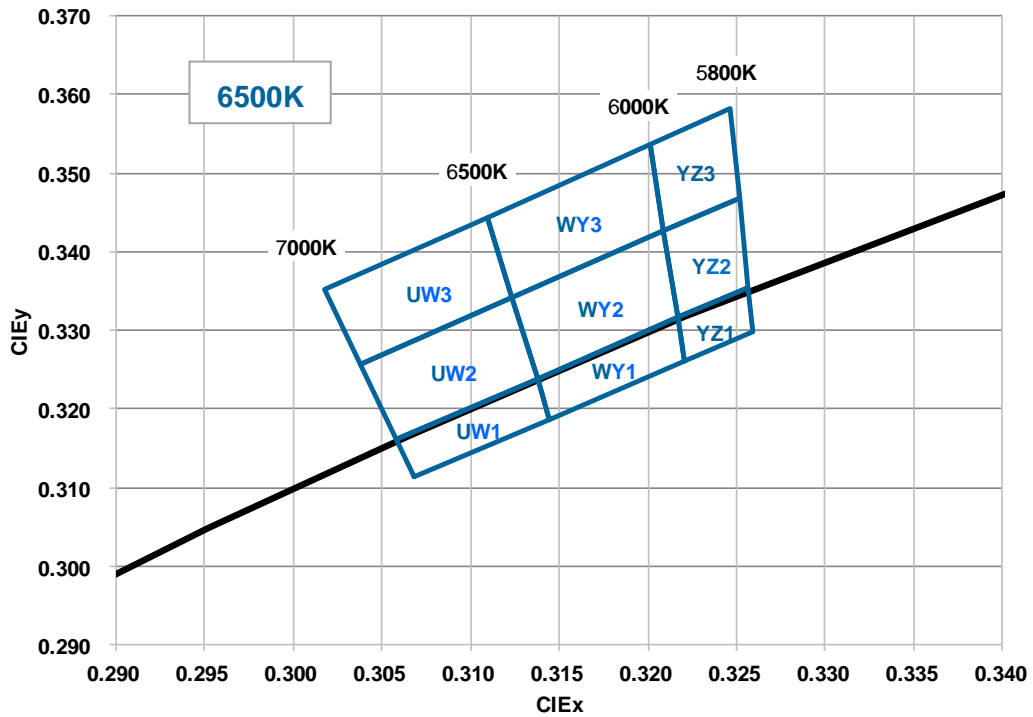

LED Middle POWER K140SZRxx Series

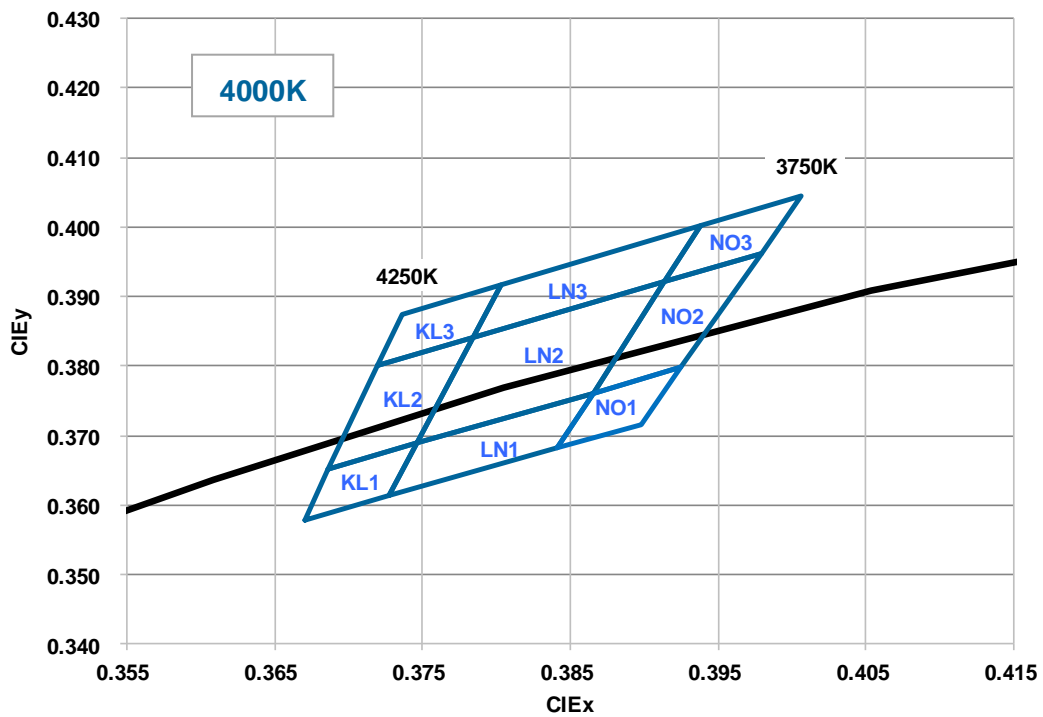
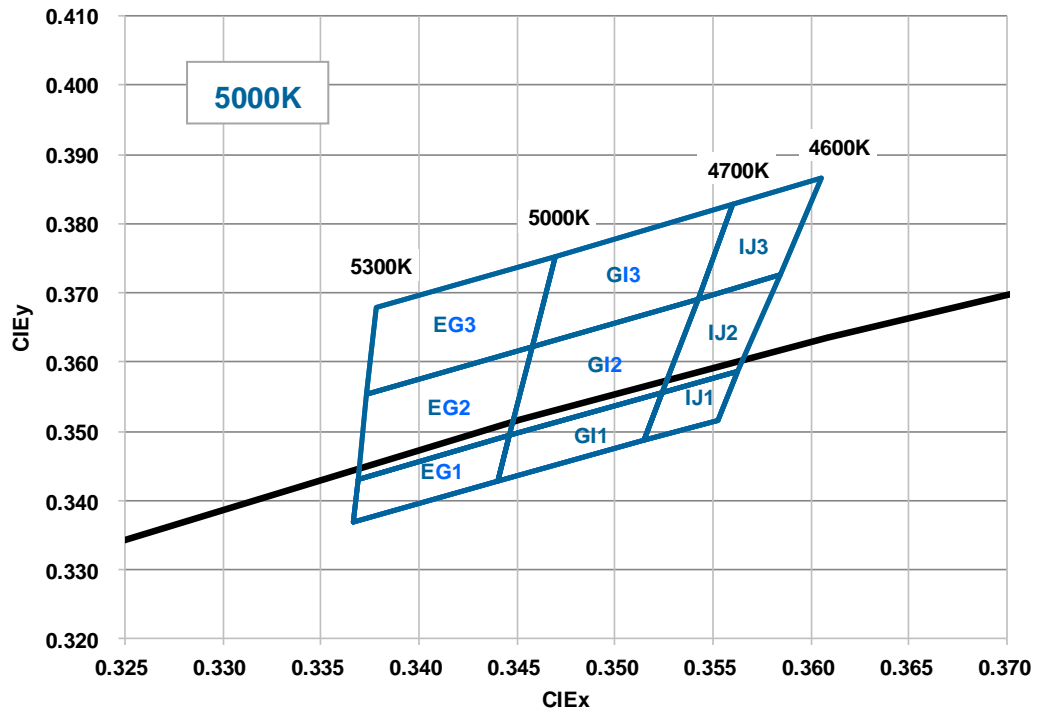

LED Middle POWER K140SZRxx Series

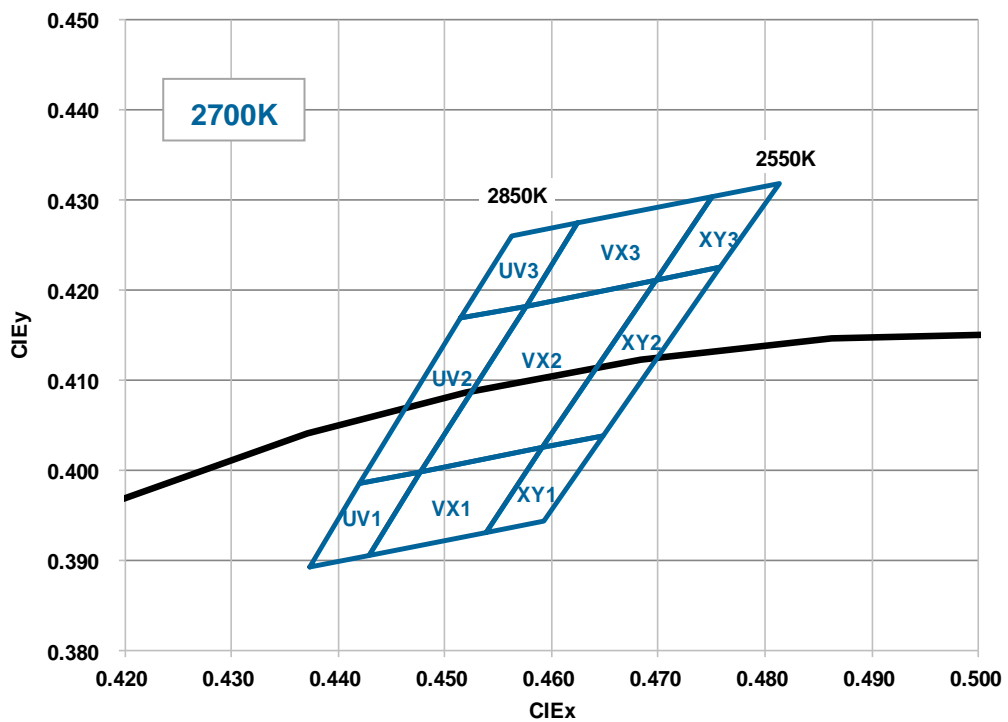
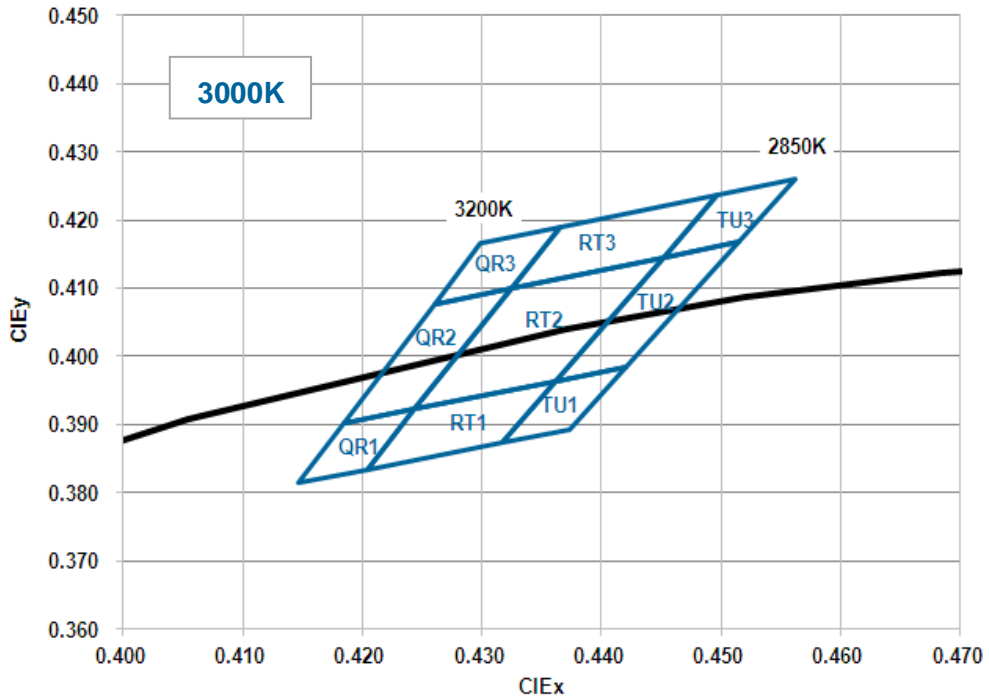

LED Middle POWER K140SZRxx Series

5.2 Color Rank

| 6500K ($I_f = 60$ mA) | | | | | | | | | | | |
|------------------------|---|--------|--------|------|---|--------|--------|------|---|--------|--------|
| Rank | - | x | y | Rank | - | x | y | Rank | - | x | y |
| UW3 | 1 | 0.3038 | 0.3256 | WY3 | 1 | 0.3124 | 0.3341 | YZ3 | 1 | 0.3209 | 0.3426 |
| | 2 | 0.3018 | 0.3352 | | 2 | 0.3110 | 0.3444 | | 2 | 0.3201 | 0.3536 |
| | 3 | 0.3110 | 0.3444 | | 3 | 0.3201 | 0.3536 | | 3 | 0.3247 | 0.3582 |
| | 4 | 0.3124 | 0.3341 | | 4 | 0.3209 | 0.3426 | | 4 | 0.3252 | 0.3468 |
| UW2 | 1 | 0.3058 | 0.3161 | WY2 | 1 | 0.3138 | 0.3238 | YZ2 | 1 | 0.3217 | 0.3316 |
| | 2 | 0.3038 | 0.3256 | | 2 | 0.3124 | 0.3341 | | 2 | 0.3209 | 0.3426 |
| | 3 | 0.3124 | 0.3341 | | 3 | 0.3209 | 0.3426 | | 3 | 0.3252 | 0.3468 |
| | 4 | 0.3138 | 0.3238 | | 4 | 0.3217 | 0.3316 | | 4 | 0.3257 | 0.3355 |
| UW1 | 1 | 0.3068 | 0.3113 | WY1 | 1 | 0.3145 | 0.3187 | YZ1 | 1 | 0.3221 | 0.3261 |
| | 2 | 0.3058 | 0.3161 | | 2 | 0.3138 | 0.3238 | | 2 | 0.3217 | 0.3316 |
| | 3 | 0.3138 | 0.3238 | | 3 | 0.3217 | 0.3316 | | 3 | 0.3257 | 0.3355 |
| | 4 | 0.3145 | 0.3187 | | 4 | 0.3221 | 0.3261 | | 4 | 0.3259 | 0.3298 |

Tolerance on each Hue bin (x,y) is +/- 0.01.

| 5700K ($I_f = 60$ mA) | | | | | | | | | | | |
|------------------------|---|--------|--------|------|---|--------|--------|------|---|--------|--------|
| Rank | - | x | y | Rank | - | x | y | Rank | - | x | y |
| AC3 | 1 | 0.3211 | 0.3407 | CE3 | 1 | 0.3292 | 0.3481 | EF3 | 1 | 0.3374 | 0.3554 |
| | 2 | 0.3203 | 0.3517 | | 2 | 0.3291 | 0.3597 | | 2 | 0.3379 | 0.3678 |
| | 3 | 0.3291 | 0.3597 | | 3 | 0.3379 | 0.3678 | | 3 | 0.3422 | 0.3718 |
| | 4 | 0.3292 | 0.3481 | | 4 | 0.3374 | 0.3554 | | 4 | 0.3414 | 0.3591 |
| AC2 | 1 | 0.3218 | 0.3298 | CE2 | 1 | 0.3293 | 0.3364 | EF2 | 1 | 0.3369 | 0.3431 |
| | 2 | 0.3211 | 0.3407 | | 2 | 0.3292 | 0.3481 | | 2 | 0.3374 | 0.3554 |
| | 3 | 0.3292 | 0.3481 | | 3 | 0.3374 | 0.3554 | | 3 | 0.3414 | 0.3591 |
| | 4 | 0.3293 | 0.3364 | | 4 | 0.3369 | 0.3431 | | 4 | 0.3406 | 0.3464 |
| AC1 | 1 | 0.3222 | 0.3243 | CE1 | 1 | 0.3294 | 0.3306 | EF1 | 1 | 0.3366 | 0.3369 |
| | 2 | 0.3218 | 0.3298 | | 2 | 0.3293 | 0.3364 | | 2 | 0.3369 | 0.3431 |
| | 3 | 0.3293 | 0.3364 | | 3 | 0.3369 | 0.3431 | | 3 | 0.3406 | 0.3464 |
| | 4 | 0.3294 | 0.3306 | | 4 | 0.3366 | 0.3369 | | 4 | 0.3402 | 0.3401 |

Tolerance on each Hue bin (x,y) is +/- 0.01.

LED Middle POWER K140SZRxx Series

| 5000K ($I_f = 60$ mA) | | | | | | | | | | | |
|------------------------|---|--------|--------|------|---|--------|--------|------|---|--------|--------|
| Rank | - | x | y | Rank | - | x | y | Rank | - | x | y |
| EG3 | 1 | 0.3374 | 0.3554 | GI3 | 1 | 0.3458 | 0.3623 | IJ3 | 1 | 0.3542 | 0.3692 |
| | 2 | 0.3379 | 0.3678 | | 2 | 0.3469 | 0.3753 | | 2 | 0.3560 | 0.3828 |
| | 3 | 0.3469 | 0.3753 | | 3 | 0.3560 | 0.3828 | | 3 | 0.3605 | 0.3866 |
| | 4 | 0.3458 | 0.3623 | | 4 | 0.3542 | 0.3692 | | 4 | 0.3584 | 0.3726 |
| EG2 | 1 | 0.3369 | 0.3431 | GI2 | 1 | 0.3446 | 0.3493 | IJ2 | 1 | 0.3524 | 0.3555 |
| | 2 | 0.3374 | 0.3554 | | 2 | 0.3458 | 0.3623 | | 2 | 0.3542 | 0.3692 |
| | 3 | 0.3458 | 0.3623 | | 3 | 0.3542 | 0.3692 | | 3 | 0.3584 | 0.3726 |
| | 4 | 0.3446 | 0.3493 | | 4 | 0.3524 | 0.3555 | | 4 | 0.3563 | 0.3586 |
| EG1 | 1 | 0.3366 | 0.3369 | GI1 | 1 | 0.3441 | 0.3428 | IJ1 | 1 | 0.3515 | 0.3487 |
| | 2 | 0.3369 | 0.3431 | | 2 | 0.3446 | 0.3493 | | 2 | 0.3524 | 0.3555 |
| | 3 | 0.3446 | 0.3493 | | 3 | 0.3524 | 0.3555 | | 3 | 0.3563 | 0.3586 |
| | 4 | 0.3441 | 0.3428 | | 4 | 0.3515 | 0.3487 | | 4 | 0.3552 | 0.3517 |

Tolerance on each Hue bin (x,y) is +/- 0.01.

| 4000K ($I_f = 60$ mA) | | | | | | | | | | | |
|------------------------|---|--------|--------|------|---|--------|--------|------|---|--------|--------|
| Rank | - | x | y | Rank | - | x | y | Rank | - | x | y |
| KL3 | 1 | 0.3720 | 0.3800 | LN3 | 1 | 0.3784 | 0.3841 | NO3 | 1 | 0.3914 | 0.3922 |
| | 2 | 0.3736 | 0.3874 | | 2 | 0.3804 | 0.3917 | | 2 | 0.3939 | 0.4002 |
| | 3 | 0.3804 | 0.3917 | | 3 | 0.3939 | 0.4002 | | 3 | 0.4006 | 0.4044 |
| | 4 | 0.3784 | 0.3841 | | 4 | 0.3914 | 0.3922 | | 4 | 0.3979 | 0.3962 |
| KL2 | 1 | 0.3687 | 0.3652 | LN2 | 1 | 0.3746 | 0.3689 | NO2 | 1 | 0.3865 | 0.3762 |
| | 2 | 0.3720 | 0.3800 | | 2 | 0.3784 | 0.3841 | | 2 | 0.3914 | 0.3922 |
| | 3 | 0.3784 | 0.3841 | | 3 | 0.3914 | 0.3922 | | 3 | 0.3979 | 0.3962 |
| | 4 | 0.3746 | 0.3689 | | 4 | 0.3865 | 0.3762 | | 4 | 0.3925 | 0.3798 |
| KL1 | 1 | 0.3670 | 0.3578 | LN1 | 1 | 0.3727 | 0.3613 | NO1 | 1 | 0.3841 | 0.3682 |
| | 2 | 0.3687 | 0.3652 | | 2 | 0.3746 | 0.3689 | | 2 | 0.3865 | 0.3762 |
| | 3 | 0.3746 | 0.3689 | | 3 | 0.3865 | 0.3762 | | 3 | 0.3925 | 0.3798 |
| | 4 | 0.3727 | 0.3613 | | 4 | 0.3841 | 0.3682 | | 4 | 0.3898 | 0.3716 |

Tolerance on each Hue bin (x,y) is +/- 0.01.

LED Middle POWER K140SZRxx Series

| 3000K ($I_f = 60$ mA) | | | | | | | | | | | |
|------------------------|---|--------|--------|------|---|--------|--------|------|---|--------|--------|
| Rank | - | x | y | Rank | - | x | y | Rank | - | x | y |
| QR3 | 1 | 0.4261 | 0.4077 | RT3 | 1 | 0.4324 | 0.4100 | TU3 | 1 | 0.4451 | 0.4146 |
| | 2 | 0.4299 | 0.4165 | | 2 | 0.4365 | 0.4189 | | 2 | 0.4496 | 0.4236 |
| | 3 | 0.4365 | 0.4189 | | 3 | 0.4496 | 0.4236 | | 3 | 0.4562 | 0.4260 |
| | 4 | 0.4324 | 0.4100 | | 4 | 0.4451 | 0.4146 | | 4 | 0.4515 | 0.4168 |
| QR2 | 1 | 0.4185 | 0.3902 | RT2 | 1 | 0.4244 | 0.3923 | TU2 | 1 | 0.4361 | 0.3964 |
| | 2 | 0.4261 | 0.4077 | | 2 | 0.4324 | 0.4100 | | 2 | 0.4451 | 0.4146 |
| | 3 | 0.4324 | 0.4100 | | 3 | 0.4451 | 0.4146 | | 3 | 0.4515 | 0.4168 |
| | 4 | 0.4244 | 0.3923 | | 4 | 0.4361 | 0.3964 | | 4 | 0.4420 | 0.3985 |
| QR1 | 1 | 0.4147 | 0.3814 | RT1 | 1 | 0.4204 | 0.3834 | TU1 | 1 | 0.4317 | 0.3873 |
| | 2 | 0.4185 | 0.3902 | | 2 | 0.4244 | 0.3923 | | 2 | 0.4361 | 0.3964 |
| | 3 | 0.4244 | 0.3923 | | 3 | 0.4361 | 0.3964 | | 3 | 0.4420 | 0.3985 |
| | 4 | 0.4204 | 0.3834 | | 4 | 0.4317 | 0.3873 | | 4 | 0.4373 | 0.3893 |

Tolerance on each Hue bin (x,y) is +/- 0.01.

| 2700K ($I_f = 60$ mA) | | | | | | | | | | | |
|------------------------|---|--------|--------|------|---|--------|--------|------|---|--------|--------|
| Rank | - | x | y | Rank | - | x | y | Rank | - | x | y |
| UV3 | 1 | 0.4515 | 0.4168 | VX3 | 1 | 0.4625 | 0.4275 | XY3 | 1 | 0.4697 | 0.4211 |
| | 2 | 0.4562 | 0.4260 | | 2 | 0.4750 | 0.4304 | | 2 | 0.4750 | 0.4304 |
| | 3 | 0.4625 | 0.4275 | | 3 | 0.4697 | 0.4211 | | 3 | 0.4813 | 0.4319 |
| | 4 | 0.4576 | 0.4183 | | 4 | 0.4576 | 0.4183 | | 4 | 0.4758 | 0.4225 |
| UV2 | 1 | 0.4515 | 0.4168 | VX2 | 1 | 0.4576 | 0.4183 | XY2 | 1 | 0.4697 | 0.4211 |
| | 2 | 0.4576 | 0.4183 | | 2 | 0.4697 | 0.4211 | | 2 | 0.4758 | 0.4225 |
| | 3 | 0.4477 | 0.3998 | | 3 | 0.4591 | 0.4025 | | 3 | 0.4648 | 0.4038 |
| | 4 | 0.4420 | 0.3985 | | 4 | 0.4477 | 0.3998 | | 4 | 0.4591 | 0.4025 |
| UV1 | 1 | 0.4373 | 0.3893 | VX1 | 1 | 0.4477 | 0.3998 | XY1 | 1 | 0.4538 | 0.3931 |
| | 2 | 0.4420 | 0.3985 | | 2 | 0.4591 | 0.4025 | | 2 | 0.4591 | 0.4025 |
| | 3 | 0.4477 | 0.3998 | | 3 | 0.4538 | 0.3931 | | 3 | 0.4648 | 0.4038 |
| | 4 | 0.4428 | 0.3906 | | 4 | 0.4428 | 0.3906 | | 4 | 0.4593 | 0.3944 |

Tolerance on each Hue bin (x,y) is +/- 0.01.

LED Middle POWER K140SZRxx Series

5.3 Flux Bin

| 2700K | Φ_v Luminous Flux Spec. Table | |
|--------------|------------------------------------|-----|
| Φ_v Bin | Lumen (lm) at $I_F = 60$ mA | |
| | Min | Max |
| AC | 16 | 18 |
| CE | 18 | 20 |
| EG | 20 | 22 |
| GI | 22 | 24 |

| 5000K | Φ_v Luminous Flux Spec. Table | |
|--------------|------------------------------------|-----|
| Φ_v Bin | Lumen (lm) at $I_F = 60$ mA | |
| | Min | Max |
| DF | 19 | 21 |
| FH | 21 | 23 |
| HJ | 23 | 25 |
| JL | 25 | 27 |

| 3000K | Φ_v Luminous Flux Spec. Table | |
|--------------|------------------------------------|-----|
| Φ_v Bin | Lumen (lm) at $I_F = 60$ mA | |
| | Min | Max |
| BD | 17 | 19 |
| DF | 19 | 21 |
| FH | 21 | 23 |
| HJ | 23 | 25 |

| 5700K | Φ_v Luminous Flux Spec. Table | |
|--------------|------------------------------------|-----|
| Φ_v Bin | Lumen (lm) at $I_F = 60$ mA | |
| | Min | Max |
| DF | 19 | 21 |
| FH | 21 | 23 |
| HJ | 23 | 25 |
| JL | 25 | 27 |

| 4000K | Φ_v Luminous Flux Spec. Table | |
|--------------|------------------------------------|-----|
| Φ_v Bin | Lumen (lm) at $I_F = 60$ mA | |
| | Min | Max |
| CE | 18 | 20 |
| EG | 20 | 22 |
| GI | 22 | 24 |
| IK | 24 | 26 |

| 6500K | Φ_v Luminous Flux Spec. Table | |
|--------------|------------------------------------|-----|
| Φ_v Bin | Lumen (lm) at $I_F = 60$ mA | |
| | Min | Max |
| CE | 18 | 20 |
| EG | 20 | 22 |
| GI | 22 | 24 |
| IK | 24 | 26 |

Tolerance on each Luminous Flux bin is +/- 10%.

LED Middle POWER K140SZRxx Series

5.4 Voltage Bin

| V _F Spec. Table | | |
|----------------------------|---------------------------------------------------|-----|
| V _F Bin | Forward Voltage (volts) at I _F = 60 mA | |
| | Min | Max |
| V1 | 2.9 | 3.1 |
| V2 | 3.1 | 3.2 |
| V3 | 3.2 | 3.3 |
| V4 | 3.3 | 3.5 |

Tolerance on each Forward Voltage bin is +/- 0.1V

6. Bin Code List

※ Notes: Full Rank on Label

Example: V1 / HJ / CE2

| Forward Voltage Rank | Luminous Flux Rank | Color Rank |
|----------------------|--------------------|------------|
| V1 | HJ | CE2 |

LED Middle POWER K140SZRxx Series

7. Reflow Soldering Characteristics

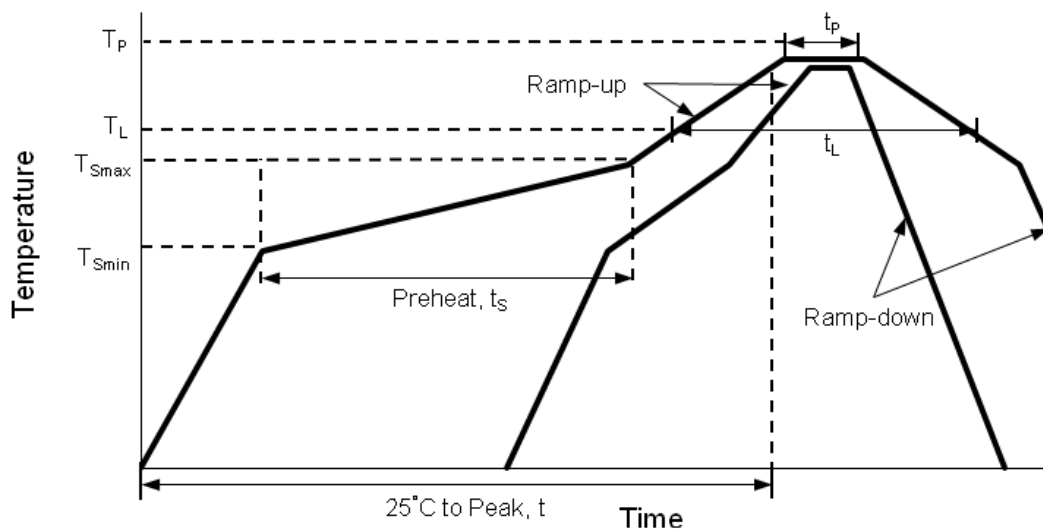

| Profile Feature | Lead Free Assembly |
|--------------------------------------------------------------|--------------------|
| Average Ramp-Up Rate (T _{Smax} to T _P) | 3°C / second max |
| Preheat Temperature Min (T _{Smin}) | 150°C |
| Preheat Temperature Max (T _{Smax}) | 200°C |
| Preheat Time (t _{Smin} to t _{Smax}) | 60 – 180 seconds |
| Time Maintained Above Temperature (T _L) | 217°C |
| Time Maintained Above Time (t _L) | 60 – 150 seconds |
| Peak / Classification Temperature (T _P) | 260°C |
| Time Within 5°C of Actual Peak Temperature (t _p) | 5 seconds |
| Ramp – Down Rate | 6°C / second max |
| Time 25°C to Peak Temperature | 8 minutes max |

Notes:

- The LEDs can be soldered using the reflow soldering or hand soldering method. The recommended hand

LED Middle POWER K140SZRxx Series

soldering condition is 350 °C max. and 2 secs max. for one time only, and the recommended reflow soldering condition is 260 °C max. and 5 secs max. for three times max.

2. All temperatures refer to topside of the package, measured on the package body surface.
3. The soldering condition referring to J-STD-020. The storage ambient for the LEDs should not exceed 30 °C temperature or 70% relative humidity. It is recommended that LEDs out of their original packaging are soldered within one week. For extended storage out of their original packaging, it is recommended that the LEDs were stored in a sealed container with appropriate desiccant, or desiccators with nitrogen ambient. If the LEDs were unpacked more than 168hrs, baking the LEDs at 60 °C for 60 mins before soldering process.
4. The soldering profile could be further referred to different soldering grease material characteristic. The grease vendor will provide this information.
5. A rapid-rate process is not recommended for the LEDs cooling down from the peak temperature.
6. Although the recommended reflow conditions are specified above, the reflow or hand soldering condition at the lowest possible temperature is desirable for the LEDs.
7. LiteOn cannot make a guarantee on the LEDs which have been already assembled using the dip soldering method.

LED Middle POWER K140SZRxx Series

8. Reliability Test

| No | Test item | Test Condition | Duration | Number of Damaged |
|----|--------------------------------------------------------|-------------------------------------------------------------------------------------|-------------|-------------------|
| 1 | Steady State Operating Life of High Temperature (HTOL) | Ts=55°C, If=60mA | 1000 hrs | 0/20 |
| 2 | Steady State Operating Life of High Temperature (HTOL) | Ts=85°C, If=60mA | 1000 hrs | 0/20 |
| 3 | Steady State Operating Life of High Temperature (HTOL) | Ts=55°C, If=80mA | 1000 hrs | 0/20 |
| 4 | Steady State Operating Life of High Temperature (HTOL) | Ts=85°C, If=80mA | 1000 hrs | 0/20 |
| 5 | Steady State Operating Life of Low Temperature (LTOL) | Ta=-40°C, If=60mA | 1000 hrs | 0/20 |
| 6 | Pulse Wet Operating Life of High Temperature (PWHTOL) | 60°C/90%RH, If=60mA 30mins ON/30min OFF | 500 hrs | 0/20 |
| 7 | High Temperature Storage (HTS) | 100°C | 1000 hrs | 0/20 |
| 8 | Low Temperature Storage (LTS) | -40°C | 1000 hrs | 0/20 |
| 9 | Thermal Cycle (TC) | -40°C~100°C 30min dwell 5min transfer | 200 cycle | 0/20 |
| 10 | Thermal Shock (TS) | -40°C~100°C 20min dwell 20sec transfer | 200 cycle | 0/20 |
| 11 | Solder Resistance (SR) | 265°C, 3X MSL | 5sec | 0/20 |
| 12 | Solder Ability (SA) | 245°C 5sec, 95% coverage | 5sec | 0/11 |
| 13 | Mechanical Shock (MS) | 1500G 0.5msec pulse shock | each 6 axis | 0/6 |
| 14 | Random Vibration (RV) | 6G RMS, 10-2000Hz, 10min | per axis | 0/6 |
| 15 | Variable Vibration Frequency (VVF) | 10-2000-10Hz, log or linear sweep rate, 20G for 1 min, 1.5mm each apply 3x per axis | over 6hrs | 0/6 |
| 16 | Salt Spread (SS) | 35°C, 30g/m ² /day | 48hrs | 0/11 |

LED Middle POWER K140SZRxx Series

Criteria for Judging the Damage

| Item | Symbol | Test Condition | Criteria for Judgment | |
|-----------------|----------------|---------------------------------|-----------------------|--------------|
| | | | Min. | Max. |
| Forward Voltage | V _f | I _F =Typical Current | | U.S.L. x 1.1 |
| Luminous Flux | L _m | I _F =Typical Current | L.S.L. x 0.7 | |
| CCX&CCY | x,y | I _F =Typical Current | | Shift<0.02 |

LED Middle POWER K140SZRxx Series

9. User Guide

■ Cleaning

Do not use unspecified chemical liquid to clean LED they could harm the package. If cleaning is necessary, immerse the LED in ethyl alcohol or isopropyl alcohol at normal temperature for less than one minute.

■ Recommend Printed Circuit Board Attachment Pad

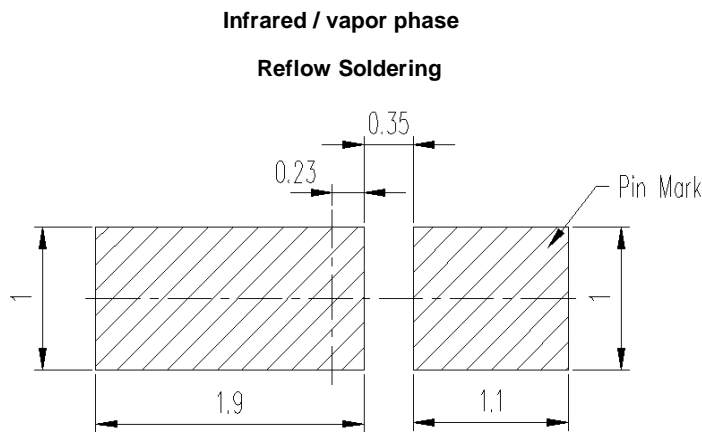

■ Package Dimensions of Tape

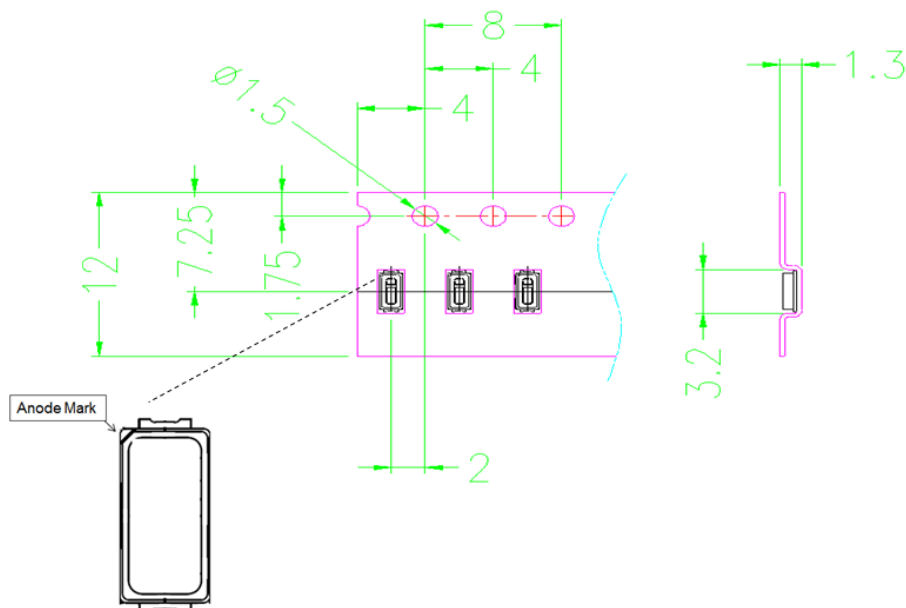

Note: All dimensions are in millimeters (inches).

LED Middle POWER K140SZRxx Series

■ Package Dimensions of Reel

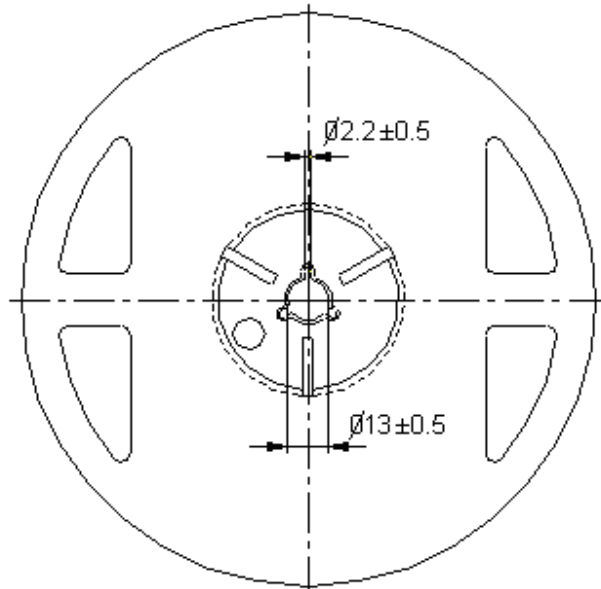

Note: 01. The tolerance unless mentioned is ± 0.1 mm
02. The measured unit is "mm"

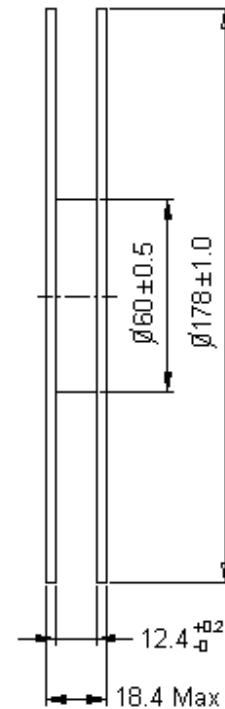

Notes:

1. Empty component pockets sealed with top cover tape.
2. 7 inch reel-3000 pieces per reel.
3. Minimum packing quantity is 500 pieces for remainders.
4. The maximum number of consecutive missing lamps is two.
5. In accordance with EIA-481-1-B specifications.

LED Middle POWER K140SZRxx Series

10. Cautions

10.1 Application

The LEDs described here are intended to be used for ordinary electronic equipment (such as office equipment, communication equipment and household applications). Consult Liteon's Sales in advance for information on applications in which exceptional reliability is required, particularly when the failure or malfunction of the LEDs may directly jeopardize life or health (such as in aviation, transportation, traffic control equipment, medical and life support systems and safety devices).

10.2 Storage

This product is qualified as Moisture sensitive Level 3 per JEDEC J-STD-020 Precaution when handling this moisture sensitive product is important to ensure the reliability of the product.

The package is sealed:

The LEDs should be stored at 30°C or less and 90%RH or less. And the LEDs are limited to use within one year, while the LEDs is packed in moisture-proof package with the desiccants inside.

The package is opened:

The LEDs should be stored at 30°C or less and 60%RH or less. Moreover, the LEDs are limited to solder process within 168hrs. If the Humidity Indicator shows the pink color in 10% even higher or exceed the storage limiting time since opened, that we recommended to baking LEDs at 60°C at least 24hrs. To seal the remainder LEDs return to package, it's recommended to be with workable desiccants in original package.

10.3 Cleaning

Use alcohol-based cleaning solvents such as isopropyl alcohol to clean the LED if necessary.

10.4 Drive Mode

An LED is a current-operated device. In order to ensure intensity uniformity on multiple LEDs connected in parallel in an application, it is recommended that a current limiting resistor be incorporated in the drive circuit, in series with each LED as shown in Circuit A below

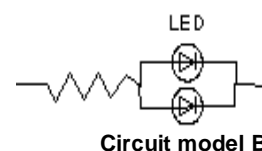
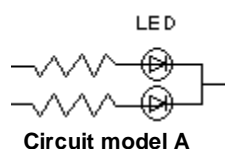

LED Middle POWER K140SZRxx Series

(A) Recommended circuit.

(B) The brightness of each LED might appear different due to the differences in the I-V characteristics of those LEDs.

10.5 ESD (Electrostatic Discharge)

Static Electricity or power surge will damage the LED. Suggestions to prevent ESD damage:

- Use of a conductive wrist band or anti-electrostatic glove when handling these LEDs.
- All devices, equipment, and machinery must be properly grounded.
- Work tables, storage racks, etc. should be properly grounded.
- Use ion blower to neutralize the static charge which might have built up on surface of the LED's plastic lens as a result of friction between LEDs during storage and handling.

ESD-damaged LEDs will exhibit abnormal characteristics such as high reverse leakage current, low forward voltage, or "no lightup" at low currents. To verify for ESD damage, check for "light up" and V_f of the suspect LEDs at low currents. The V_f of "good" LEDs should be $>2.0V@0.1mA$ for InGaP product and $>1.4V@0.1mA$ for AlInGaP product.

10.6 Suggested Checking List:

- Training and Certification
 1. Everyone working in a static-safe area is ESD-certified?
 2. Training records kept and re-certification dates monitored?
- Static-Safe Workstation & Work Areas
 1. Static-safe workstation or work-areas have ESD signs?
 2. All surfaces and objects at all static-safe workstation and within 1 ft measure less than 100V?
 3. All ionizer activated, positioned towards the units?
 4. Each work surface mats grounding is good?
- Personnel Grounding
 1. Every person (including visitors) handling ESD sensitive (ESDS) items wear wrist strap, heel strap or conductive shoes with conductive flooring?
 2. If conductive footwear used, conductive flooring also present where operator stand or walk?

LED Middle POWER K140SZRxx Series

3. Garments, hairs or anything closer than 1 ft to ESD items measure less than 100V*?
4. Every wrist strap or heel strap/conductive shoes checked daily and result recorded for all DLs?
5. All wrist strap or heel strap checkers calibration up to date?

Note: *50V for Blue LED.

- Device Handling
 1. Every ESDS items identified by EIA-471 labels on item or packaging?
 2. All ESDS items completely inside properly closed static-shielding containers when not at static-safe workstation?
 3. No static charge generators (e.g. plastics) inside shielding containers with ESDS items?
 4. All flexible conductive and dissipative package materials inspected before reuse or recycle?
- Others
 1. Audit result reported to entity ESD control coordinator?
 2. Corrective action from previous audits completed?
 3. Are audit records complete and on file?

10.7 Others:

- Do not put any pressure on the light emitting surface either by finger or any hand tool and do not stack the products. Stress or pressure may cause damage to the wires of the LED array.
- This product is not designed for the use under any of the following conditions, please confirm the performance and reliability are well enough if you use it under any of the following conditions
- Do not use sulfur-containing materials in commercial products including the materials such as seals and adhesives that may contain sulfur.
- Do not put this product in a place with a lot of moisture (over 85% relative humidity), dew condensation, briny air, and corrosive gas (Cl, H₂S, NH₃, SO₂, NO_x, etc.), exposure to a corrosive environment may affect silver plating.
- The appearance and specifications of the product may be modified for improvement without prior notice.

Компания «Океан Электроники» предлагает заключение долгосрочных отношений при поставках импортных электронных компонентов на взаимовыгодных условиях!

Наши преимущества:

- Поставка оригинальных импортных электронных компонентов напрямую с производств Америки, Европы и Азии, а так же с крупнейших складов мира;
- Широкая линейка поставок активных и пассивных импортных электронных компонентов (более 30 млн. наименований);
- Поставка сложных, дефицитных, либо снятых с производства позиций;
- Оперативные сроки поставки под заказ (от 5 рабочих дней);
- Экспресс доставка в любую точку России;
- Помощь Конструкторского Отдела и консультации квалифицированных инженеров;
- Техническая поддержка проекта, помощь в подборе аналогов, поставка прототипов;
- Поставка электронных компонентов под контролем ВП;
- Система менеджмента качества сертифицирована по Международному стандарту ISO 9001;
- При необходимости вся продукция военного и аэрокосмического назначения проходит испытания и сертификацию в лаборатории (по согласованию с заказчиком);
- Поставка специализированных компонентов военного и аэрокосмического уровня качества (Xilinx, Altera, Analog Devices, Intersil, Interpoint, Microsemi, Actel, Aeroflex, Peregrine, VPT, Syfer, Eurofarad, Texas Instruments, MS Kennedy, Miteq, Cobham, E2V, MA-COM, Hittite, Mini-Circuits, General Dynamics и др.);

Компания «Океан Электроники» является официальным дистрибьютором и эксклюзивным представителем в России одного из крупнейших производителей разъемов военного и аэрокосмического назначения «JONHON», а так же официальным дистрибьютором и эксклюзивным представителем в России производителя высокотехнологичных и надежных решений для передачи СВЧ сигналов «FORSTAR».



JONHON

«JONHON» (основан в 1970 г.)

Разъемы специального, военного и аэрокосмического назначения:

(Применяются в военной, авиационной, аэрокосмической, морской, железнодорожной, горно- и нефтедобывающей отраслях промышленности)

«FORSTAR» (основан в 1998 г.)

ВЧ соединители, коаксиальные кабели,
кабельные сборки и микроволновые компоненты:

(Применяются в телекоммуникациях гражданского и специального назначения, в средствах связи, РЛС, а так же военной, авиационной и аэрокосмической отраслях промышленности).



Телефон: 8 (812) 309-75-97 (многоканальный)

Факс: 8 (812) 320-03-32

Электронная почта: ocean@oceanchips.ru

Web: <http://oceanchips.ru/>

Адрес: 198099, г. Санкт-Петербург, ул. Калинина, д. 2, корп. 4, лит. А