

# Amphenol® High Frequency Contacts for Multi-pin Connectors

12-130-4

HIGH PERFORMANCE CONNECTORS AND CONTACTS PROVIDE SECURE, RELIABLE DATA TRANSMISSION

CONCENTRIC TWINAX



COAXIAL



TRIAx



TWINAX PC TAIL



DIFFERENTIAL TWINAX



QUADRAX CONTACTS . DIFFERENTIAL TWINAX CONTACTS . TRANSITION ADAPTERS



**Amphenol**  
Aerospace

# Amphenol High Frequency Contacts

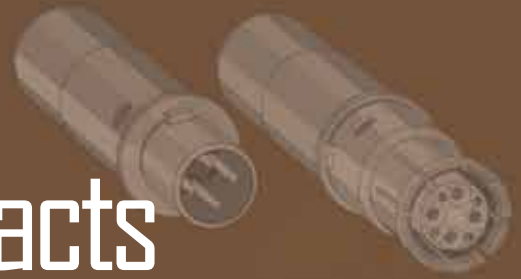

CONCENTRIC  
TWINAX

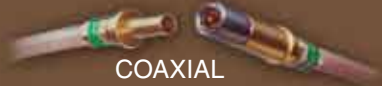

COAXIAL



“Split-Pair”  
Quadrax Contact  
& Cable

TWINAX PC TAIL

TRIAx



DIFFERENTIAL  
TWINAX

QUADRAX



## TABLE OF CONTENTS

- Table of Contents . . . . . 2
- Overview of Amphenol’s High Frequency Contacts . . . . . 3-7
- Cable Systems . . . . . 8
- Cable Usage Guide . . . . . 9-12

### MIL-DTL-38999 Circular Connector Overview . . . . . 13

#### Contacts for MIL-DTL-38999 Connectors:

- Quadrax Contacts . . . . . 14-16
- New “Split-Pair” Quadrax Contacts . . . . . 17-20
- Differential Twinax Contacts . . . . . 21, 22
- Compliant Quadrax and PC Tail Quadrax Contacts . . . . . 23
- Quadrax Transition & Differential Twinax Transitional Adapters . . . . . 24-26
- Differential Twinax Transition Adapters . . . . . 27
- Micro D-Twinax Transition Adapters . . . . . 28-30
- Insert Arrangements for MIL-DTL-38999, Series III . . . . . 31, 32
- How to Order 38999 Series III with Quadrax 100 ohm Contacts . . . . . 33
- Coaxial Contacts . . . . . 34-37
- Matched Impedance Coaxial Contacts . . . . . 38
- Typical Contact Installation Instructions for Coax Contacts . . . . . 39
- High Frequency Contacts (DC to 40 GHz) . . . . . 40
- Twinax Contacts . . . . . 41-43
- Triax Contacts . . . . . 44
- Coax, Twinax & Triax PC Tail Contacts . . . . . 45-47
- Insert Patterns for MIL-DTL-38999 Series III Incorporating Coax, Twinax and Triax Contacts . . . . . 48-50

### Standard MIL-DTL-5015 & Heavy Duty MIL-DTL-22992 Circular Connector Overview . . . . . 51

#### Contacts for Standard MIL-DTL-5015 & Heavy Duty

#### MIL-DTL-22992 Connectors:

- Coaxial Contacts . . . . . 52, 53
- Insert Patterns for Standard MIL-DTL-5015 and Heavy Duty MIL-DTL-22992 Incorporating Coax Contacts . . . . . 54
- Rectangular Rack & Panel Connectors that incorporate High Speed . . . . . 55, 56
- Additional Contact Styles from Amphenol . . . . . 57
- Guide for Selecting High Frequency Contacts and Cables . . . . . 58



## High Frequency Contacts Typical Markets:

- Military & Commercial Aviation
- Military Vehicles
- Missiles & Ordnance
- C4ISR



# Amphenol® High Frequency Contacts

## Provide High Speed Transmission and Operate in High Frequency Conditions



*When you need superior electrical performance plus shielding to eliminate interference from outside electrical sources in a connector, Amphenol has the most reliable contact solutions.*

Amphenol offers a very wide range of contacts that provide high speed transmission and operate in high frequency conditions. You can be assured of interconnection compatibility when you come to Amphenol for your contact needs as well as your connector needs. Amphenol's expertise in interconnection solutions assures that your contacts will mate properly and will perform to the application specifications of your particular requirements.

*MIL-DTL-38999 CONNECTORS - The high performance series most ideal for integrating high speed and high frequency contacts. MIL-DTL-38999, Series I, II and III are by far the choice of connector for today's avionics needs - these subminiature family connectors are ideally suited for the incorporation of shielded contacts.*



This catalog section is primarily devoted to the high speed and high frequency contact options for use in MIL-DTL-38999 Connectors, which include:

Coaxial	Concentric Twinax	Triax	Quadrax	Differential Twinax	High Frequency	Transition Adapters
Pin and socket contacts designed for RF/microwave and shielded wire applications. Sizes 4, 8, 12 & 16	Pin and socket contacts designed for protection from magnetic and electrostatic interference including nuclear electromagnetic pulse. Sizes 8 & 12	Pin and socket contacts designed for shielded wire applications with 3 conductors. Sizes 8, 10 & 12	Size 8 pin and socket contacts. An outer contact with 4 strategically spaced inner contacts forming two 100 or 150 Ohm matched impedance differential pairs.	Size 8 pin and socket contacts. An outer contact with 2 inner contacts spaced to form one 100 or 150 Ohm matched impedance differential pair.	Size 8 Coaxial contacts that provide high frequencies (DC to 40 GHz). Unique "Float Mount" technology maintains tight mechanical tolerances.	Matched impedance quadrax and twinax transition adapters provide a method of launching from the high speed connectors to PCB boards.

Other series of connectors from Amphenol Aerospace, in addition to 38999 connectors, can incorporate shielded contacts. These include the following (and are also covered in this catalog section):

- Amphenol® Heavy Duty Circular Connectors, MIL-DTL-22992 - with coax contacts.
- Amphenol® Printed Circuit Board Connectors - Rectangular connectors with standard low mating force brush contacts can have hybrid arrangements with coax contacts.
- LRM Interconnects - Rectangular module and backplane connectors with standard low mating force brush contacts can have hybrid arrangements with coax contacts.
- Amphenol® ARINC 600 and R27 Rack & Panel Connectors are available with quadrax, coax, twinax and differential twinax contacts.

The Cable Usage Guide is a key reference to help guide you in selecting the contacts best suited to your needs. Since most shielded wire applications start with a fixed requirement for cable types, the guide refers you to the Amphenol connector family utilizing contacts which are compatible with the cable characteristics.

For more information on other Amphenol connectors with shielded contacts:

- Amphenol® Circular Connectors, MIL-DTL-26482, Series 1 are available with coaxial contacts, size 8 and 12 for crimp and solder type. See catalog 12-070 on-line at [www.amphenol-industrial.com](http://www.amphenol-industrial.com), or consult Amphenol Industrial Operations.
- Amphenol® MS/Standard, MIL-DTL-5015 Circular Connectors are available with size 4, 8 and 12 coax contacts. Consult Amphenol Industrial Operations for more information or on-line at [www.amphenol-industrial.com](http://www.amphenol-industrial.com).

For more information on connectors with fiber optics see the Fiber Optic section of this catalog or consult Amphenol Aerospace, Sidney, NY.

*See High Frequency Contact Designer's Guide at end of this catalog.*





Amphenol provides the latest technology in high speed contacts - differential twinax and quadrax contacts, size 8, for use in MIL-DTL-38999 Special\* Circular Connectors.

## DIFFERENTIAL TWINAX CONTACTS

High speed Differential Twinax contacts consist of an outer contact with two inner contacts spaced to form one 100 or 150 Ohm controlled impedance differential pair. See pages 385 and 386 for performance data and ordering of Differential Twinax contacts, and consult Amphenol Aerospace for more information.



**Differential Twinax Contact**



**Quadrax Contact**

## QUADRAX CONTACTS

- High speed Quadrax contacts consist of an outer contact with four inner contacts spaced to form two 100 or 150 Ohm controlled impedance differential pair.
- Both contacts, when used in Amphenol MIL-DTL-38999 Series III and ARINC type connectors, provide an excellent alternative for harsh environment applications such as:
  - Ethernet 100 Base-T-100 Ohm
  - Gigabit Ethernet 1000 Base-T-100 Ohm
  - Fibre Channel-150 Ohm
  - IEEE1394B FireWire-110 Ohm

Differential Twinax and Quadrax contact options include:

- Crimp or printed circuit board termination
- Established designs to accommodate a variety of cable types and gages
- Ground plane connectors can incorporate quadrax contacts. These connections have conductive inserts that ground the outer conductor of the contact body to the shell of the connector. They accommodate size 8 and 12 shielded contacts of which the size 8 can be quadrax type.

See pages 378-380 for performance data of Quadrax contacts. Consult Amphenol Aerospace for further information needed.

\* Requires modified connector to accommodate keyed contacts.

*Differential Twinax and Quadrax contacts provide high data transfer rates, low power consumption, and excellent EMI capability. They offer controlled impedance of 100 or 150 Ohm and are ideal for use in harsh environments.*

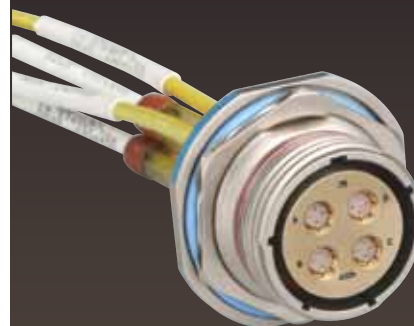

*D38999 Series III Ground Plane Connectors with Quadrax PCB Socket contacts*



*D38999 Series III with Quadrax and Power Contacts*



*D38999 Series III Connectors (standoff shell at right and standard shell below) with Quadrax PC Tail Contacts*



## QUADRAX CONTACTS FOR ARINC CONNECTORS

Amphenol ARINC 600 Rack and Panel connectors can incorporate high speed quadrax contacts as well as coax, twinax and differential twinax contacts. R27 Rack and Panel connectors use the same contacts as ARINC 600 connectors. For more information about rack and panel connectors contact Amphenol Aerospace, Sidney, NY.



**Quadrax Contact for ARINC Connectors**

## BOARD LEVEL CONNECTORS WITH COMPLIANT QUADRAX CONTACTS

Amphenol also provides compliant quadrax socket contacts and Quadrax pin contacts with PC tails for attaching to printed circuit boards. See page 387 for more information.



**Compliant Quadrax Socket and PCB Tail Quadrax Pin**

## FEED-THROUGH CONNECTOR WITH QUADRAX CONTACTS

Amphenol's feed-through connector is double-ended for through bulkhead applications. Consult Amphenol for more information.



## Quadrax Terminators

Amphenol offers a terminator assembly which is a low reactance, resistive impedance match to the characteristic impedance of a transmission line. It is used to terminate the far ends of a transmission line or an open tap so that the energy from signals traveling down the transmission line is absorbed within the resistor and not reflected back down the transmission line causing signal interference (noise). Consult Amphenol for more information.

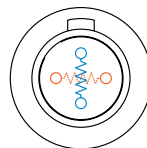

**Quadrax Terminator**

## Transition Adapters

In conjunction with its Differential Twinax and Quadrax contacts, Amphenol has developed a full line of Transition Adapters in order to facilitate launching of controlled impedance signals to printed circuit boards. These use differential twinax or quadrax 90° or straight receptacles and they can be either threaded or cable to board direct. The threaded transition adapters provide an ideal method of disconnecting the differential twinax or quadrax connector from the board.

See pages 388-390 for further description, performance data and ordering of transition adapters.

*Board Level Connector with Compliant Quadrax Contacts*

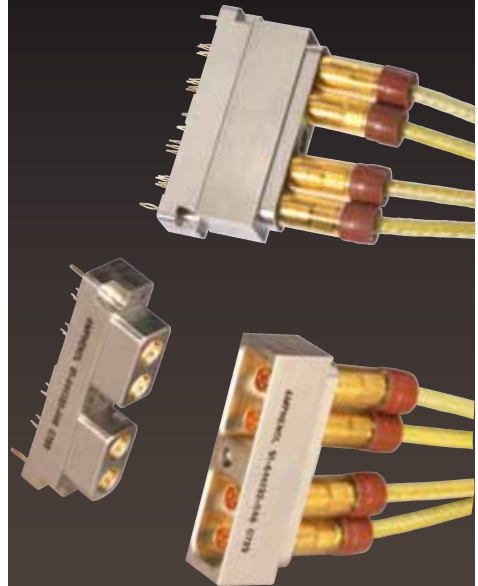

*Straight Quadrax Receptacle Contact*



*90° Quadrax Receptacle and Plug Transition Adapter*

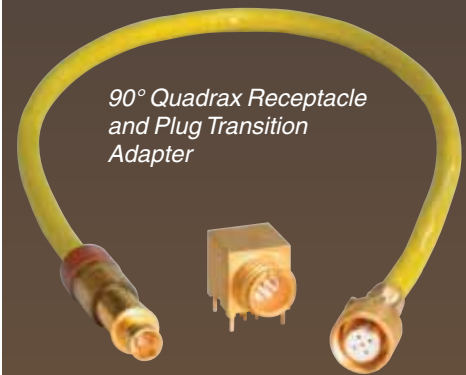

*90° Differential Twinax Receptacle and Plug Transition Adapter*

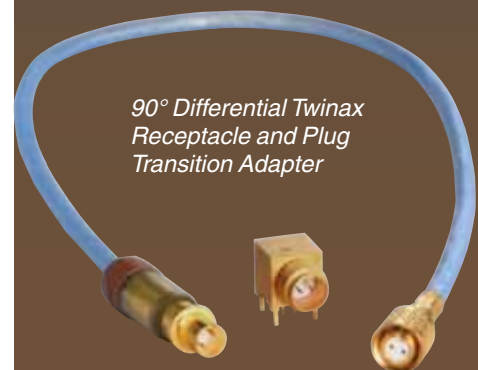

Optional choices, other than standard crimp or solder 500 cycle and 1500 cycle contacts, are often required for high frequency interconnections. Amphenol offers shielded contacts for RF applications as well as balanced high sensitivity circuits.

## SHIELDED COAXIAL CONTACTS

High speed Coax contacts within a connector provide the shielding protection, and many cases the RF/microwave performance, needed in the circuitry of many applications.



**Shielded Coax Contacts**

All popular series of Amphenol circular connectors and many rectangular connectors are available with coax contacts. Diameters are standardized in sizes 4, 8, 12 and 16 so that coaxial contacts may be interchanged with power contacts in connector arrangements which include those sizes. Popular RG cable types and a variety of other commercial coaxial cables can be accommodated. See page 398 for coax contact performance data. Matched impedance size 12 coax contacts are also available (see page 402). The use of coax contacts within a connector, compared to the use of individual coaxial/shielded connectors, offers advantages of savings in space and weight and no cross-mating difficulties. Coax and standard contacts may be mixed within the connector to meet special signal needs. The connector itself offers further protection and environmental integrity through the grommets and seals used, and coaxial junction is protected by the connector outer shell.

## CONCENTRIC TWINAX SHIELDED CONTACTS

High performance shielding capabilities are available with Concentric Twinax contacts. These are designed for protection from magnetic and electrostatic interference including nuclear electro-magnetic pulse. The contact is crimp terminable to twisted shielded cable and is fully scoop-proof (recessed pins) in MIL-DTL-38999 connectors. The concentric twinax contact is engineered to maintain shield integrity through a multi-pin circular connector and does not require contact polarization within the insert. Size 8 concentric twinax contacts were developed for use in MIL-STD-1553B Airborne multiplex data bus applications. Ideal for this application need is the high performance Tri-Start connector with its fully scoop-proof feature of recessed pins.



**Concentric Twinax Contacts Size 8**



**MIL-DTL-38999 Lanyard "Breakaway" Connector with Concentric Twinax Contacts, Qualified for MIL-STD-1760**

The concentric twinax contact is crimp terminable to twisted shielded cable. Size 12 concentric twinax contacts were developed for SAAB. They can be used in any size 12 cavity of D38999 I, II or III or SJT connector.

Size 8 & 12 coax, triax or twinax contacts or size 16 coax contacts are available in Ground Plane Connectors (See photo preceding page). These are MIL-DTL-38999 Series III connectors for data bus, LAN and coax/triax/twinax transmission lines with conductive inserts that ground the outer contact conductor to the shell. They are sold "less contacts"

*Amphenol® Shielded Contacts provide design versatility for electrical circuitry. Shielded contacts are used to eliminate interference from outside electrical sources, when standard crimp or solder contacts are not enough.*



*MIL-DTL-38999 Connector with High Speed Coax Contacts*



*Size 8 Coax Pin Contact*

*Concentric Twinax Size 12 Contacts*



*MIL-DTL-38999 Connector with Concentric Twinax Contacts*



# Coax Contacts with Frequency

Range of DC to 40 GHz

## HIGH FREQUENCY COAX CONTACTS WITH “FLOAT MOUNT” TECHNOLOGY

Amphenol Aerospace now offers DC to 40 GHz size 8 coaxial contacts for the D38999 housing and standard inserts. These contacts can be terminated to a multiple of cable types depending on the application.

By using standard interfaces that are based on MIL-STD-348 and can be installed in any D38999 size 8 insert, Amphenol has transformed the circular connector industry. This technology expands the use of D38999 connectors to include the microwave transmission lines within the multi-port configuration without change to a custom connector.

The high frequencies are maintained by Amphenol’s unique “Float Mount” technology. This technology allows for consistent microwave performance while maintaining tight mechanical tolerances. This consistency provides superior electrical performance and, unlike other blindmate connectors, will maintain an accurate phase length when mated. See page 404 for specifications, performances and ordering of this contact.



**High Frequency Size 8 Coax Contacts with “Float Mount” Technology**

## Twinax Contacts for Printed Circuit Board Applications

### PC TAIL TWINAX CONTACTS

Amphenol provides Printed Circuit Tail Twinax contacts for MIL-DTL-38999 Series I and III circular connectors and also for ARINC 404 and ARINC 600 rectangular connectors. High reliability is assured with factory pre-assembled contacts and standardized termination to the board.

See pages 409-411 for performance data and ordering of PC tail twinax contacts, and consult Amphenol Aerospace for further information needed. Also see the Printed Circuit Board, and the Series I, II, III section for MIL-DTL-38999 connectors.



**Variety of PC Tail Twinax Contacts**

### TRIAx CONTACTS WITH THREE CONDUCTORS FOR USE WITH TRIAX CABLE

Amphenol supplies sizes 8, 10 and 12 triax contacts for use in MIL-DTL-38999 Series I, II and III connectors. Triax contacts provide additional shielding when terminated to triax cable having solid or stranded center conductors. See cable compatibility in the Cable Usage Guide and performance data and ordering of triax contacts on pages 408-411. Each of the three conductors of the triax contact is separated by dielectric insulation to isolate ground planes and to improve shielding effectiveness. All conductors are crimp terminated for high reliability and ease of assembly. Triax contacts may be specified for direct connection to printed circuit boards. For maximum system flexibility, triax contacts may be mixed with coax, twinax and power contacts in a single connector.



**Triax Contacts**

*HF38999 - D38999 Connectors with High Frequency Coax Contacts*



*D38999 Connectors with PC Tail Twinax Contacts*



*Printed Circuit Twinax Contacts provide a cost effective packaging solution for limited space applications where connectors are attached to printed circuit boards.*

*Rail Launch MIL-STD-1760 Connector with Triax Contacts*

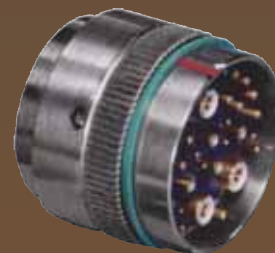

**CABLE ASSEMBLY CAPABILITIES**

Amphenol provides a large array of cable assemblies with high speed quadrax and differential twinax contacts, as well as coax and concentric twinax contacts. This page shows a few examples. The Cable Usage Guide pages that follow list the design possibilities for these high speed contacts.

Amphenol strives to offer customers the widest range of cable assemblies, keeping abreast of the latest cable types in the marketplace. Please consult with the contact product managers at Amphenol Aerospace for assistance in designing the cable assembly that suits your particular needs. From a simple one-cable interconnection, to a multiple cable system, Amphenol can design and supply your cable needs for high frequency contacts and connectors. See the High Frequency Contact Designer's Guide at the end of this catalog

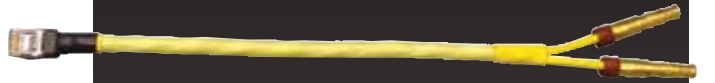

*Eight Wire Gigabit Ethernet Assembly*



*Quadrax Contact with 8P8C "RJ45"  
Jack Ethernet Assembly*



**Variety of Quadrax Cable Assemblies**

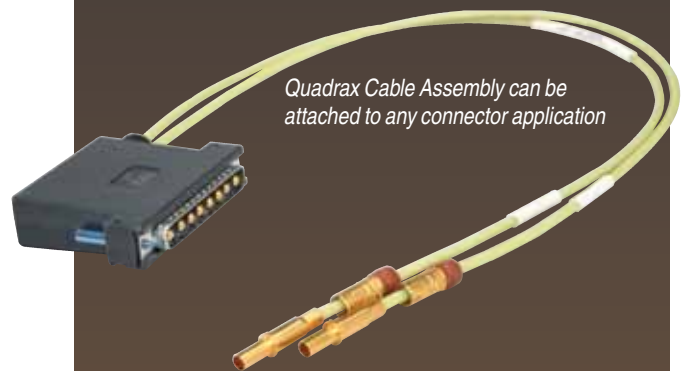

*Quadrax Cable Assembly can be  
attached to any connector application*

**TESTING OF CABLES**

Rigid testing is performed 100% on cable assemblies at Amphenol before they are shipped to make sure they meet customer requirements. These requirements include tests such as DWV, resistance and continuity. Amphenol has the background experience and understanding of harsh environmental testing to assure reliable "end-to-end" interconnect solutions.



*Quadrax Cable Assembly attached to Board  
Level Compliant Quadrax Connector*



Use the Cable Usage Guide on pages 373-376 as follows:

1. Locate the cable you are using in Cable Type column. For cables not listed consult Amphenol Aerospace.
2. Refer to the Amphenol Connector section which features contacts/adapters for this cable. Connector size, performance features and insert pattern availability may influence your choice.
3. Order your connector and contacts or transition adapters by following the procedure given in the section for the connector series selected. These instructions are supplemented by the Amphenol Catalog Section covering the basic connector.

**Quadrax Contacts**  
**CABLE USAGE GUIDE**  
**D38999 Series III\* Connectors**

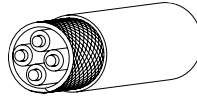

Cable Type		Nominal Impedance (ohms)	
Draka Fileca	F-4703-3	100	
	F-4703-4		
	F-4704-5		
	F-47-4-6		
Filotex	ET2PC236		
	ET2PF870		
PIC Wire	E50424		
	E50426		
	E51424		
Tensolite	NF22Q100		
	NF24Q100		
	NF24Q100-1		
	NF24Q100-01-200C		
	NF26Q100		
	NF26Q100-1		
	NF26-2Q100		
	24443/03130X-4(LD)		
	24443/03166X-4(LD)		
	24443/9P025X-4(LD)		
	23450/04090X-4 (LD)		
	24443/C20714X-4(LD)		
	Gore		RCN7688
			RCN8513
RCN8672			
S280W502-4			
JSF-18-3			
Themax	956-4TN		
	956-5		
	T956-4T200		
	MX100Q-24		
Tensolite	24450/03089X-4(LD)		
Gore	RCN8487		
JSFY02-1			
JSF18			
Tensolite	26473/02006X-4(LD)		
Gore	RCN8328		

\* Requires modified connector to accommodate keyed contacts.

**Differential Twinax Contacts**  
**CABLE USAGE GUIDE**  
**D38999 Series III\* Connectors**

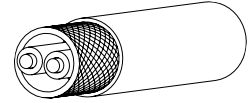

Cable Type		Nominal Impedance (ohms)
Tensolite	26463/70460X-2	98
ST5M1284-003		
Draka Fileca	2709-3	100
PIC Wire	E10224	
Tensolite	NF24T100-200C Space	
	23460/05114X-2(LD)	
	24463/03220T-2(LD)	
	24463/05099X-8(LD)	
	26453/03184X-2(LD)	
	24463/9P025X-2(LD)	
Raychem	0026A0024, 0024G0024	
S280W502-6		
JSFY11-24		
Gore	GSC-05-827300-00	
Themax	956-6262, 956-1T200	
	12814	
	MX 100-24	
Tensolite	26483/03071X-2(LD)	150

**Quadrax Transition Adapters**  
**CABLE USAGE GUIDE**  
**D38999 Series III\* Connectors**  
**or ARINC 600 Connectors**

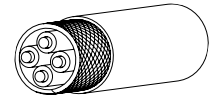

Cable Type		Nominal Impedance (ohms)	
Draka Fileca	F-4703-3	100	
	F-4704-4		
Tensolite	NF22Q100		
	NF22Q100-01		
	NF24Q100		
	NF26Q100		
Themax	956-5		
Gore	GSC-10-8273900		
Tensolite	26473/02006X-4(LD)		150

**Differential Twinax Transition Adapters**  
**CABLE USAGE GUIDE**  
**D38999 Series III\* Connectors**  
**or ARINC 600 Connectors**

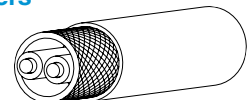

Cable Type		Nominal Impedance (ohms)
M17/176-00002		78
Tensolite	224463/9P025X-2	100
	24463/9P025X-2(LD)	
Tensolite	26483/03071X-2	150

**Quadrax Contacts**  
**CABLE USAGE GUIDE**  
**ARINC 600 Rack & Panel Connectors**

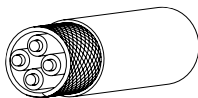

Cable Type		Nominal Impedance (ohms)	
Draka Fileca	F-4703-3	100	
	F-4704-5, F4704-4		
Tensolite	NF22Q100		
	NF24Q100		
	24443/03130X-4(LD)		
	24443/9P025X-4(LD)		
S280W502-4			
JSFY02-1			110
Gore	RCN8328		150
Tensolite	26473/02006X-4(LD)		

**Differential Twinax Contacts**  
**CABLE USAGE GUIDE**  
**ARINC 600 Rack & Panel Connectors**

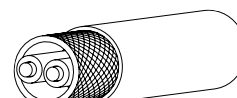

Cable Type		Nominal Impedance (ohms)
ABS0386WF24		100
ASNE0272TK22		100
ASNE0272TK24		100
Tensolite	24463/9P025X-2(LD)	100

**Concentric Twinax Contacts**  
**CABLE USAGE GUIDE**  
**D38999 Series I, II, III & SJT Connectors**

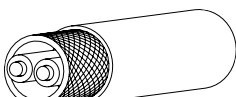

Cable Type		Nominal Impedance (ohms)
EPD32263A		77
EPD22189B		77
M17/176-00002		77
GSC-12-2548-00		77
GC875TM24H		77
GSC-12-81095-00		77
Raychem	10602	77
	10606	77
	10612	77
	10613	77
	10614	77
23089/RC		77
05A0771		77
T10971		77
7724C8664		77
7726D0664		77
782OD0111 (20 AWG)		78
0024G0024		100
5M2022-003		100
HS5930		100
S280W502-1		100
CXN2268		100

**Triax Contacts**  
**CABLE USAGE GUIDE**  
**D38999 Series I, II, III & SJT Connectors**

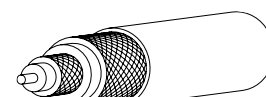

Cable Type		Nominal Impedance (ohms)
JN1088WT		50
5M2397-002		75
81264-02		75
JN1088WU		75
Gore	GSC-03-81497-00	75
RG179 (Coax Cable)		75
Tensolite	28988/50823LXX-1	75
Tensolite	28988/50823LXX-1	75
Thermatics	12447	75
10602 (Twinax Cable)		77
5M2559-001		95
81264-01		95
ST5M1323-001		95
Champlain	81-00700	95
Tensolite	28598/9C026LT-1	95
	26895/90334X-1	95
Teledyne	13809	95
11914/1		95
Times AA6603		95
RGX179		75

**Concentric Twinax Contacts**  
**CABLE USAGE GUIDE**  
**ARINC 600 Rack & Panel Connectors**

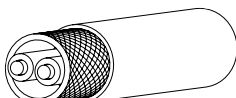

Cable Type	Nominal Impedance (ohms)
S280W502-1	100

Use the Cable Usage Guides on this page for Coax Contacts as follows:

1. Locate the cable you are using in Cable Type column. For cables not listed consult Amphenol Aerospace.
2. Refer to the Amphenol connector section which features contacts for this cable, as indicated by a • in the appropriate column. If more than one connector series utilizes contacts designed for your cable, investigate each of them. Connector size, performance features and insert pattern availability may influence your choice.
3. Order your connector and coax contact by following the procedure given in the section for the connector series selected. These instructions are supplemented by the Amphenol Catalog Section covering the basic connector.
4. The Additional Contacts column of this guide is used to indicate an additional availability of contact designs for older cable types or capability. Consult Amphenol Aerospace for further information.

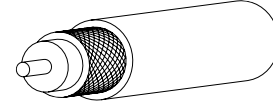

## Coax Contacts CABLE USAGE GUIDE

Cable Type		Nominal Impedance (ohms)	For Circular (MIL-DTL-38999 type)	For Standard & Heavy Duty Circular (MIL-DTL-5015 type) (MIL-DTL-22992 type)	For Rectangular Connectors	Additional Contacts (Consult Amphenol)
RG-5B/U	(M17/073-RG212)	50				•
RG-6A/U	(M17/2-RG6)	75				•
RG-7/U		97				•
RG-9B/U	(M17/075-RG214)	50				•
RG-11A/U	(M17/6-RG11)	75				•
RG-12A/U	(M17/6-RG12)	75				•
RG-13A/U		74				•
RG-21A/U		53				•
RG-55B/U	(M17/084-RG223)	53		•	•	
RG-58C/U	(M17/028-RG058)	50		•	•	
RG-58	(M17/155-00001)	50	•			
RG-59B/U	(M17/29-RG59)	75		•		
RG-62A/U	(M17/030-RG062)	93		•		
RG-62B/U		93		•		
RG-63B/U	(M17/31-RG63)	125				•
RG-71B/U	(M17/90-RG71)	93				•
RG-87A/U		50				•
RG-115/U		50				•
RG-115A/U		50				•
RG-116/U		50				•
RG-122/U	(M17/054-RG122)	50			•	•
RG-133A/U	(M17/100-RG133)	95				•
RG-140/U	(M17/110-RG302)	75		•		
RG-141A/U		50		•	•	
RG-142A/U		50		•	•	•
RG-142B/U	(M17/060-RG142)	50	•	•	•	•
RG-143A/U		50				•
RG-161/U		70	•	•		
RG-174A/U	(M17/119-RG174)	50	•	•		
RG-178B/U	(M17/093-RG178)	50	•	•		
RG-179B/U	(M17/094-RG179)	75	•	•		
RG-180B/U	(M17/095-RG180)	95	•	•	•	
RG-187A/U	(M17/094-RG179)	75	•	•		
RG-188A/U	(M17/113-RG316)	50	•	•		
RG-188 Double Braid		50				
RG-195A/U	(M17/095-RG180)	95	•	•	•	
RG-195 Double Braid		95				
RG-196A/U	(M17/169-00001)	50	•	•		
RG-210/U		93		•		
RG-212/U	(M17/073-RG212)	50		•		•
RG-214/U	(M17/075-RG214)	50				•
RG-216/U	(M17/77-RG216)	75				•
RG-222/U		50				•
RG-223/U	(M17/084-RG223)	50	•	•	•	
RG-225/U	(M17/86-RG225)	50				•
RG-227/U		50				•
RG-302/U	(M17/110-RG302)	75		•		

CHART CONTINUES ON NEXT PAGE

NOTE: For information on coax contacts for Miniature circular connectors, MIL-DTL-26482 Series 1, see catalog 12-070 and consult Amphenol Industrial Operations.

NOTE: MIL-DTL-38999 supersedes MIL-C-38999.  
MIL-DTL-5015 supersedes MIL-C-38999.  
MIL-DTL-22992 supersedes MIL-C-22992

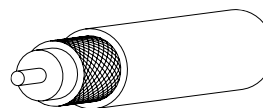

## Coax Contacts CABLE USAGE GUIDE, cont.

Cable Type		Nominal Impedance (ohms)	For Circular (MIL-DTL-38999 type)	For Standard & Heavy Duty Circular (MIL-DTL-5015 type) (MIL-DTL-22992 type)	For Rectangular Connectors	Additional Contacts (Consult Amphenol)
RG-303/U	(M17/111-RG303)	50		•	•	
RG-304/U	(M17/112-RG304)	50				•
RG-316/U	(M17/113-RG316)	50	•	•		
RD-316 Double Braid	(M17/152-00001)	50	•			
RG-400	(M17/128-RG400)	50	•			
M/A-COM 5M2869-001		50	•		•	
5022A1311-D		50	•			
Beldon 9307		50	•			
FA-19X		50	•			
T-Flex-402		50	•			
T-Flex-405		50	•			
Filotex ET124962		50	•			
JN1088WT	(Triax)	50	•			
JN1088WU	(Triax)	75	•			
PAN6422XQ		50	•			
PAN6422XY		75	•			
PAN6595XM	(Triax)	75	•			
Haveg	51-04486		•			
	81-00207		•			
Gore	GWN1159A		•			
	CXN3403		•			
Times	AA3248		•			
Teledyne	11299		•			
Raychem	5021D1331-0	50	•			
	5021D1331-9	50	•			
	5022D1312-9	50	•			
	7527A1318	75	•			
	9527A1314	95	•			
	9528A1318	95	•			
	9530A5314	95	•			
9530D5314	95	•				
Thermatics	2929-29		•			
Tensolite	30850/87T-1		•			
Thermax	50C-25A-DS-1		•			
	ESC352001	50	•			
	ESC432101	50	•			

For Cable not found in the Coax Contact Cable Usage Guide, refer to these general dimensional ranges:  
(In general, for D38999 Connectors, the size 8, 12 and 16 Coax Contacts will terminate cable in the following ranges )

### SIZE 16

.012 / .0215 Center Conductor (Stranded)
.031 / .066 Dielectric
.085 Max Outer braid (must be round for crimp termination)
.102 Max. Jacket

### SIZE 12

.012 / .0215 Center Conductor (Stranded)
.031 / .105 Dielectric
.126 Max Outer braid (must be round for crimp termination)
.145 Max. Jacket

### SIZE 8

.012 / .0395 Center Conductor (Stranded)
.055 / .133 Dielectric
.180 Max Outer braid (must be round for crimp termination)
.201 Max. Jacket

Special coax contacts may be available for cables outside of ranges shown. Consult Amphenol Aerospace for further assistance in selection of coax contact cables.

# MIL-DTL-38999 Circular Connector

## Overview

Amphenol® Connectors are ideally suited for the incorporation of shielded contacts for high performance interconnection applications. The circular family is built around MIL-DTL-38999 specifications, with Mil-approved and commercial styles offered. Normal operating voltage for circulars with power contacts only is up to 900 VAC (RMS) at sea level.

### The MIL-DTL-38999 family offer these features for contact termination flexibility:

- Widest selection of insert arrangements that can incorporate:
  - Size 8 high speed Quadrax and Differential Twinax contacts for MIL-DTL-38999 Series III (specially modified to accommodate keyed contacts)
  - Transition adapters for use in attaching D38999 Series III connectors with high speed quadrax or differential contacts to PCB boards
  - Size 8, 12 and 16 Coax contacts
  - Size 8 and 12 Twinax contacts
  - Size 8, 10 & 12 Triax contacts
- Wide selection of connector shell styles and sizes
- Scoop-Proof recessed design in LJT-R, TV-R and SJT-R connectors provide protection for contacts
- Standard power contacts are crimp rear release, qualified to SAE AS39029
- Coax, Twinax, and Triax contacts employ the same retention system as power contacts, simplifying user substitution

### GENERAL ORDERING INFORMATION

Amphenol MIL-DTL-38999, which feature rear removable contacts, are normally supplied with a full complement of power contacts, separately packaged. Coax, twinax and triax contacts are ordered by part number as referenced in the part number charts on the following pages of this catalog, and are substituted for the power contacts at the time of the cable or equipment assembly. If the application is for coax, twinax or triax contacts only, the connector may be ordered *less contacts* and no power contacts will be supplied.

### HOW TO ORDER CONNECTORS AND HIGH FREQUENCY CONTACTS

- Select the Circular Series desired.  
(See features of each series given briefly on this page and in-depth in the other sections of this catalog, which are on-line at [www.amphenol-aerospace.com](http://www.amphenol-aerospace.com)).
- Series I - LJT-R Connectors
- Series II - JT-R Connectors
- Series III - TV-R Connectors
- SJT\* - SJT-R Connectors
- See Amphe-Lite (Industrial 38999 type) Catalog 12-094
- Select the quadrax, differential twinax, coax, twinax and/or triax contacts or the transition adapters that are needed from the tables on the following pages that correspond to the cable being used.
- Select the insert arrangement to accommodate required number of contacts. Insert patterns for quadrax and differential twinax contacts are on pages 395,396. Insert patterns for coax, twinax and triax contacts are on pages 404-406.
- Complete the connector part number from the connector series catalog, incorporating the chosen insert pattern number. See detailed how to order page 397 for ordering 38999, Series III with quadrax and differential twinax contacts. Consult Amphenol for assistance in ordering 38999 circulars with coax, twinax and triax contacts.
- Consult Amphenol Aerospace for ordering information for connectors with PC tail contacts, and for transition adapters.
- If connector is ordered less contacts, power contacts and/or sealing plugs may be ordered separately to fill out the insert arrangement.



TV-R, Tri-Start, D38999 Series III

- High performance capability series for both general duty and severe environment applications
  - Offers the widest range of Subminiature Family Mil-Spec qualified options in contact and connector styles
  - Threaded coupling; completely mates in one turn; crimp termination
  - Superior EMI/EMP shielding effectiveness
  - Scoop-proof design (recessed pins)
  - Available in aluminum, stainless steel and firewall, or lightweight composite styles
- See 38999 section Series III for complete information on this section.



JT-R, D38999 Series II

See 38999 section Series II, JT for complete information on this series.

- Shorter profile connector series for applications requiring maximum space savings
- Bayonet coupling, crimp termination
- Also available in solder termination types under MIL-DTL-27599 Series II



LJT-R, D38999 Series I

See 38999 section Series I, LJT for complete information on this series.

- Scoop-proof (recessed pins)
- Bayonet coupling, crimp termination
- Also available in solder termination types under MIL-DTL-27599 Series II



Amphe-Lite, 38999 Type

See Catalog 12-094 for complete information on this series.

- Commercial/Industrial 38999 Series III type
  - Cost effective high performance connector for severe environments or general duty industrial applications
  - Consult Amphenol Industrial Operations for further information
- 12-094 catalog is on-line at [www.amphenol-industrial.com](http://www.amphenol-industrial.com).



SJT-R, 38999 Type

See the SJT section of this catalog.

- Amphenol proprietary series (non-MS) which is a further expansion of the basic JT family, but incorporates the LJT scoop-proof design
- Compliant with several European specifications

NOTE: SAE AS39029 supersedes MIL-C-39029.  
NOTE: MIL-DTL-38999 supersedes MIL-C-38999.  
MIL-DTL-27599 supersedes MIL-C-27599

**Amphenol® Quadrax Contacts** -offer several advantages for high data transfer rates, low power consumption and excellent EMI compatibility:

- Four strategically spaced inner contacts form two 100 or 150 Ohm matched impedance differential pairs
- Outer contact has rugged wall section for durability
- Available in size 8 crimp termination style
- Also available in size 8 with PC tails (see page 379)
- Requires modification of MIL-DTL-38999 connector to accommodate keyed contacts

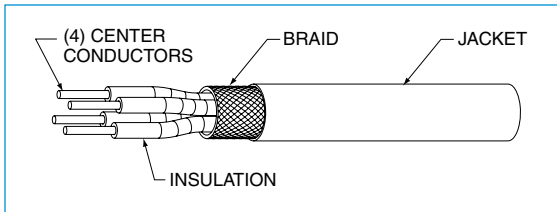

Cable Illustration - Quadrax Contact

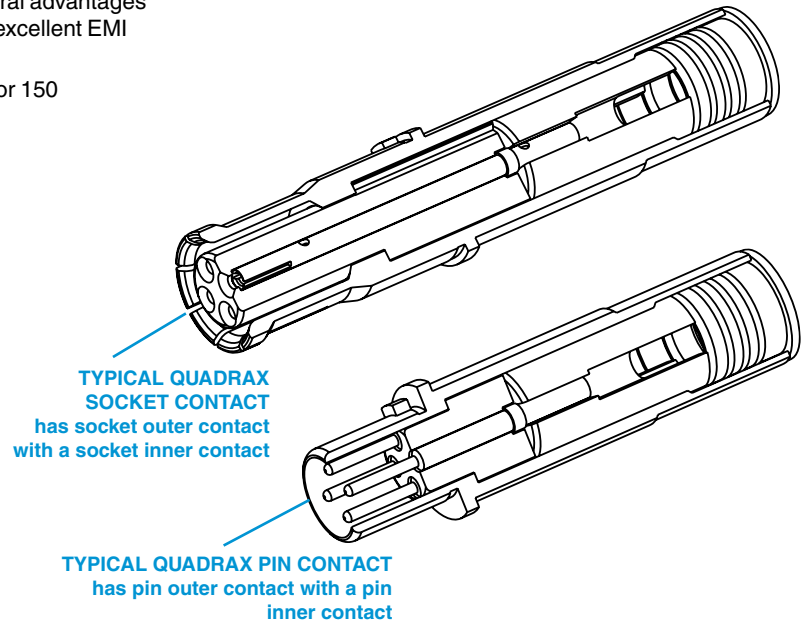

Quadrax Pin with 8P8C "RJ45" Jack



Quadrax Pin Size 8 and MIL-DTL-38999 Series III Connector

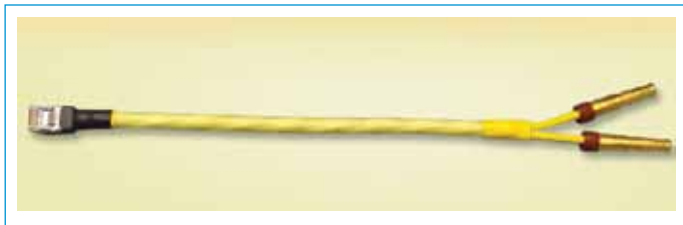

Quadrax in an Eight Wire Gigabit Ethernet Assembly

**Suggested Strain Relief - Insert Arrangements 9-5 or 19-18 with Quadrax Contacts**

Due to the piggyback grommet interference with normal strain reliefs on the shell size 9 only, the recommended strain relief for the connector is: Amphenol part number TGW-R-5309-10 (OD Cad) or TGF-R-5309-10 (Electroless nickel) - shell size 9 only. For 19-18 insert pattern, recommended backshell: Glenair 367-221-NF. This is recommended due to the proximity of the size 8 contacts in relation to the shell.

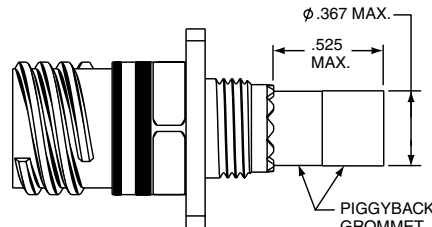

Also see Quadrax contacts for ARINC 600 and R27 Rack and Panel Connectors on page 419 and 420.

**Quadrax Contacts are gold plated, crimp termination**

Finish of mating contacts parts: supplied with 0.000050 min. gold over nickel on mating parts. Consult Amphenol for availability of other finishes.

**Quadrax Size 8 Contact Performance:**

- Bandwidth: Up to 3 Gigahertz
- Data Rate: Exceeding 3 Gbits/sec.
- Voltage Rating: 500 Vrms max. @ sea level
- Dielectric Withstanding Voltage: 1000 VAC rms between all inner contacts @ sea level, 500 VAC rms between inner and outer contacts @ sea level

**Suggested Numbering for Quadrax Contacts**

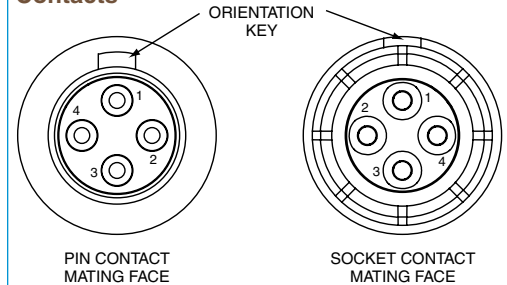

Differential Pairs, contacts 1-3, 2-4.

See page 397 for part number ordering of popularly used 38999 Series III connectors with 100 ohm quadrax contacts.

Quadrax differential pairs are 1 and 3, 2 and 4.

# Quadrax Contacts for MIL-DTL-38999 Series III, Application Data



## TV-R Series, MIL-DTL-38999 Series III\* Connectors

### QUADRAX CONTACTS FOR USE IN TV-R CONNECTORS

Cable	Contact Part Number (Termination Instruction Sheet)**		Impedance (Ohms)	Inner Conductor (AWG)	Contact Size	Electrical Protocol††	Crimping Tools	
	Pin	Socket					Inner Contact	Outer Contact
Draka Fileca F-4703-3, F4704-4, Filotex ET 2PC236, Filotex ET2PF870, PIC Wire E50424 ABS0972, Tensolite 23450/04090X-4(LD) Draka Fileca F-4704-5, ABS1503 KD 24	21-033384-021 (L-2119-A)	21-033385-021 (L-2119-A)	100	24	8	Ethernet, 1000 Base-T Gigabit Ethernet	M22520/2-01 with Positioner M22520/2-37 or with Daniels Positioner K709	M22520/5-01 with Die Set M22520/5-45 (Location A)
Tensolite NF24Q100, NF24Q100-01, 24443/9P025X-4(LD), S280W502-4, 24443/03130X-4(LD), 24443/C20714X-4(LD), 24450/0120X-4(LD), NF24-2Q100, TYCO CEC-RWC-18664, GORE GSC-01-81869-01, 24443/03166X-4(LD), Thermax T956-4T200, Pic Wire E51424, Thermax MX100Q-24, NF24Q100-01-200C (Space)	21-033384-051 (L-2119-D)	21-033385-051 (L-2119-D)		24		Ethernet, 1000 Base-T Gigabit Ethernet		
Tensolite NF22Q100, NF22Q100-01, Thermax 956-5, GORE RCN 7688	21-033384-061 (L-2119-H)	21-033385-061 (L-2119-H)		22		Ethernet (100 Mbps), 1000 Base-T Gigabit Ethernet (1 Gbps)		
Tensolite NF26Q100, NF26Q100-01, NF26-2Q100, PIC E51426	21-033384-071 (L-2119-AB)	21-033385-071 (L-2119-AB)		26		Ethernet (100 Mbps), 1000 Base-T Gigabit Ethernet (1 Gbps)		
S280W502-4/BMS13-72T03C04G024	21-033384-141 (BACC47GM1)	21-033385-141 (BACC45GN1)		24				
Draka Fileca F-4704-6, Gore RCN 8672	21-033384-151 (L-2119-AW)	21-033385-151 (L-2119-AW)		26		Ethernet (100 Mbps), 1000 Base-T Gigabit Ethernet (1 Gbps)		
Tensolite NF24Q100-01 (same as 21-03338( ) -51, uses EMI Piggyback)	21-033384-161 (L-2119-BE)	21-033385-161 (L-2119-BE)		24		Ethernet (100 Mbps), 1000 Base-T Gigabit Ethernet (1 Gbps)		
Gore RCN8513, JSFY18-3	21-033384-171 (L-2119-BN)	21-033385-171 (L-2119-BN)		22		Ethernet (100 Mbps), 1000 Base-T Gigabit Ethernet (1 Gbps)		
Tensolite NF22Q100 Special Box pattern, only mates with 21-0333( ) -181	21-033384-181 (L-2119-BP)	21-033385-181 (L-2119-BP)		22		Ethernet (100 Mbps), 1000 Base-T Gigabit Ethernet (1 Gbps)		
Tensolite NF24Q100, NF24Q100-01 for 2.5 Gbps applications	21-033384-191 (L-2119-BS)	21-033385-191 (L-2119-BS)		24		• Serial FPDP Applications (2.5 Gbps) (Typical app run at 150 Ohms) • HDMI 1.3		
USB2 (28433/02171LX-4)	21-033384-101†	21-033385-101†	90	USB2.0 (480 Mbps)				
Tensolite 24450/03089X-4(LD) Gore RCN8647	21-033384-211	21-033385-211	110	24	IEEE 1394B Firewire			
JSFY02-1, JSFY18	21-033384-221	21-033385-221		24	IEEE 1394B Firewire			
Gore RCN8487, JSFY18	21-033384-231	21-033385-231		24	IEEE 1394B Firewire			
Tensolite 24450/03089X-4(LD) Same as 21-03338( ) -211 but Box pattern, mates with 21-03338( ) -241 only	21-033384-241†	21-033385-241†		24	IEEE 1394B Firewire			
F-4703, ABS1503KD24	21-033384-281	21-033385-281	100		Meets EN3155-074			
Tensolite 26473/02006X-4(LD)/Gore RCN8328 (not for new designs, use 21-033450/1 series)	21-033384-31 (L-2119-B)	21-033385-031 (L-2119-B)	150	26				

CHART CONTINUES ON NEXT PAGE

#### QUADRAX CONTACT DATA

Contacts are inserted by hand. Refer to termination instructions listed. Contacts are removed with a removal tool. Recommended tool is MIL-I-81969/14-06, Daniels DRK-264-8. Refer to termination instructions listed. Finish of mating contact parts: Contact part numbers shown in the chart above are supplied gold plated per ASTM B488 Type II, Code C, .000050 min. thick over nickel plate per AMS-QQ-N-290, Class 2, .000030/.000150 thick.

Daniels crimping tools available from Daniels Mfg. Corp. 6103 Anno Ave., Orlando, FL 32809

\* Requires modified connector to accommodate keyed contacts.

\*\*Termination instructions are packaged with each contact and can be found on-line at: [www.amphenol-aerospace.com/serviceinstructions.asp](http://www.amphenol-aerospace.com/serviceinstructions.asp)

† Consult Amphenol for current release of this contact or instruction sheet if applicable.

†† Test reports available for indicated protocols. Consult Amphenol Aerospace. Typical applications run at 150 Ohms

### TV-R Series, MIL-DTL-38999 Series III\* Connectors

QUADRAX CONTACTS FOR USE IN TV-R CONNECTORS								
Cable	Contact Part Number <i>(Termination Instruction Sheet)**</i>		Impedance (Ohms)	Inner Conductor (AWG)	Contact Size	Electrical Protocol††	Crimping Tools	
	Pin	Socket					Inner Contact	Outer Contact
Tensolite 26473/02006X-4(LD) Same as 21-033384/5-31 but box pattern (not for new designs, use 21-033450/1 series) Gore RCN8328	21-033384-201†	21-033385-201†	150	26	8	Fibre-Channel (1 GBPS, 2 GBPS, 1G/2G), 1000 Base-CX (1.25 GBPS), SCSI-2 (3.2 GBPS)	M22520/2-01 with Positioner M22520/2-37 or with Daniels Positioner K709	M22520/5-01 with Die Set M22520/5-45 (Location A)
Gore RCN7625	21-033384-271	21-033385-271						
Tensolite 26473/02006X-4(LD), Gore RCN8328	21-033450-001 (L-2119-BW)	21-033451-001 (L-2119-BW)		26				
Tensolite 26473/02006X-4(LD), Gore RCN8328 (same as 21-033450/1-1 except box pattern. Mates with 21-033450/1-11 only.	21-033450-011†	21-033451-011†		26				

Contact Part Number	Impedance (Ohms)	L Dim	Pretinned	
Pin	Socket			
21-033398-021	21-033397-021	100 Ohm	1.035	X
21-033398-031	21-033397-031	100 Ohm	0.866	
21-033398-061	21-033397-061	150 Ohm	1.035	
21-033398-071	21-033397-071	150 Ohm	0.494	X
21-033398-081	21-033397-081	150 Ohm	0.780	X
21-033398-091	21-033397-091	100 Ohm	0.840	X
21-033398-111	21-033397-111	100 Ohm	0.708	
21-033398-121	21-033397-121	100 Ohm	0.859	
21-033398-131	21-033397-131	150 Ohm	0.780	X
21-033398-141	21-033397-141	100 Ohm	0.615	
21-033398-151	21-033397-151	150 Ohm	0.815	
21-033398-191	21-033397-191	100 Ohm	0.605	
21-033398-211	21-033397-211	150 Ohm	0.815	X
21-033398-221	21-033397-221	100 Ohm	0.775	
21-033398-231	21-033397-231	100 Ohm	0.494	
21-033398-241	21-033397-241	100 Ohm	0.741	
21-033398-251	21-033397-251	100 Ohm	0.788	
21-033398-271	21-033397-271	100 Ohm	0.741	
21-033398-281	21-033397-281	100 Ohm	0.806	
21-033398-291	21-033397-291	100 Ohm	1.035	
21-033398-301	21-033397-301	100 Ohm	0.836	
21-033398-311	21-033397-311	100 Ohm	0.940	
21-033398-341	21-033397-341	100 Ohm	0.901	
21-033398-351	21-033397-351	100 Ohm	0.871	
21-033398-361	21-033397-361	100 Ohm	0.939	
21-033398-371	21-033397-371	100 Ohm	0.672	
21-033398-381	21-033397-381	100 Ohm	0.914	
21-033398-391	21-033397-391	100 Ohm	0.360	
21-033398-401	21-033397-401	100 Ohm	1.009	
21-033398-411	21-033397-411	150 Ohm	0.866	
21-033398-421	21-033397-421	100 Ohm	1.169	
21-033398-431	21-033397-431	100 Ohm	0.819	
21-033398-451	21-033397-451	150 Ohm	0.494	
21-033398-461	21-033397-461	100 Ohm	0.761	
21-033398-471	21-033397-471	100 Ohm	0.889	
21-033398-481	21-033397-481	100 Ohm	0.971	
21-033398-491	21-033397-491	100 Ohm	0.418	
21-033398-501	21-033397-501	100 Ohm	0.875	
21-033398-511	21-033397-511	100/150 Ohm	0.699	
21-033398-521	21-033397-521	100 Ohm	0.582	
21-033398-531	21-033397-531	100 Ohm	0.666	
21-033398-541	21-033397-541	100 Ohm	0.946	
21-033398-551	21-033397-551	100 Ohm	0.788	X
21-033398-561	21-033397-561	100 Ohm	0.815	

Contact Part Number	Impedance (Ohms)	L Dim	Pretinned	
Pin	Socket			
21-033398-581	21-033397-581	100 Ohm	0.721	
21-033398-591	21-033397-591	100/150 Ohm	0.939	
21-033398-601	21-033397-601	100 Ohm	0.939	
21-033398-611	21-033397-611	100 Ohm	1.366	
21-033452-011	21-033453-011	150 Ohm	1.035 (mates to 21-033450/51 series)	
21-033452-021	21-033453-021	150 Ohm	0.815 (mates to 21-033450/51 series)	
21-033452-031	21-033453-031	150 Ohm	0.815 (mates to 21-033450/51 series)	X
21-033452-041	21-033453-041	150 Ohm	0.866 (mates to 21-033450/51 series)	
21-033452-051	21-033453-051	150 Ohm	0.494 (mates to 21-033450/51 series)	
21-033452-061	21-033453-061	150 Ohm	0.582 (mates to 21-033450/51 series)	
21-033452-071	21-033453-071	150 Ohm	0.939 (mates to 21-033450/51 series)	

Daniels crimping tools are available from Daniels Mfg. Corp. 6103 Anno Ave., Orlando, FL 32809

\* Requires modified connector to accommodate keyed contacts.

\*\* Termination instructions are packaged with each contact and can be found on-line at: [www.amphenol-aerospace.com/serviceinstructions.asp](http://www.amphenol-aerospace.com/serviceinstructions.asp)

† Consult Amphenol Aerospace for current release of this contact or instruction sheet if applicable.

†† Test reports available for indicated protocols. Consult Amphenol Aerospace.

\*\*\* Must be used with 21-033321-005 piggyback grommet seal.

SEALING PLUGS	
Sealing Plugs for use with D38999 Connectors using Quadrx Contacts - Size 8 Cavities	Part Number
***Standard Plastic	T3-4008-59P
Standard Plastic to be used with PCB tails (shorter tail length)	T3-4008-59P1
***Metal sealing plug - can be used when mating with contacts on mating half	21-033899-8Q1
Metal sealing plug used with PCB's and mating contact on mating half	21-033899-8Q2

PIGGYBACK GROMMET	
Grommet for use with D38999 Connectors using Quadrx Contacts	Part Number
Metallized piggyback grommet	21-033321-023

Indicated length given in chart at left is the distance from the rear of the contact retention shoulder to the tip of the PCB tails.

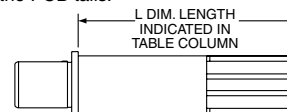

Note: it does not indicate stickout length when installed in D38999 connector.



# New “Split-Pair” Quadrax Contacts & Cables

## Assemblies for MIL-DTL-38999, Series III

### for use with CAT6A Type Cable

Amphenol Aerospace offers the high performance interconnect solution for CAT6A type cable.

#### FEATURES & BENEFITS:

- Overall higher bandwidth than standard CAT5E quadrax
- Enhanced crosstalk performance (compared to standard quadrax) due to compatibility with shielded twisted pair of cables
- Can be used for a variety of high speed applications beyond current quadrax design\*\*
- Four strategically spaced inner contacts form two 100 Ohm matched impedance differential pairs
- Outer contact has rugged wall section for durability
- Available in size 8 crimp termination style
- Also available in size 8 PC tails
- Can be installed into existing quadrax contact connector cavities
- Requires modification of MIL-DTL-38999 connector to accommodate keyed contacts



MIL-DTL-38999 Series III Connectors with “Split-Pair” Quadrax Contacts for use with CAT6A Type Cable



“Split-Pair” Quadrax Contacts for use with CAT6A Type Cable

#### APPLICATIONS:

For use with, but not limited to, the following electrical protocols :

- 10/100/1000/10GBASE-T Ethernet
- DVI
- USB 2.0
- Serial RapidIO (up to 3.125 Gbps)
- PCI-Express 2.0
- HDMI 1.3a
- SATA 2.0 (up to 3 GHz)

#### Suggested Numbering for Quadrax Contacts

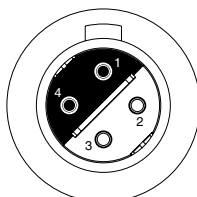

PIN CONTACT MATING FACE

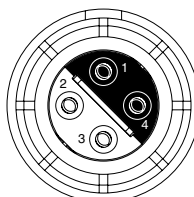

SOCKET CONTACT MATING FACE

Differential Pairs: 1 & 4, 2 & 3

#### SPLIT-PAIR QUADRAX CONTACT\* PART NUMBERS:

Crimp Style Part Number	Cable	AWG
<b>PIN 21-033470-001</b>	<b>Thermax 1536-224</b>	<b>24</b>
<b>SOCKET 21-033471-001</b>		
<b>PIN 21-033470-021</b>	<b>Thermax 1536-195</b>	<b>26</b>
<b>SOCKET 21-033471-021</b>		

#### CRIMP TOOLS:

Outer Contact	Inner Contact
<b>DANIELS M22520/5-01 with die set Y1999 or M22520/5-45</b>	<b>DANIELS M22520/2-01 with positioner K1777</b>

Daniels crimping tools are available from Daniels Mfg. Corp. 6103 Anno Ave., Orlando, FL 32809

REMOVAL TOOL: **M81969/14-12**

\* Patent pending.

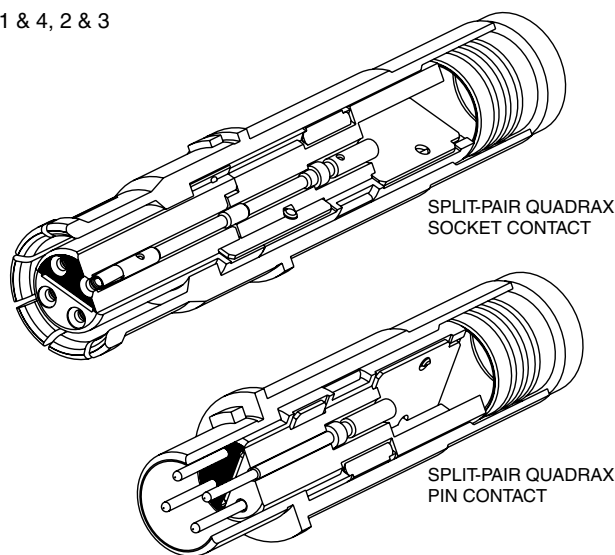

### PCB QUADRAX PIN

PCB Pin Part Numbers	Impedance	Length ±.015
21-033466-011	100 Ohm	1.035
21-033466-021		.815
21-033466-031*		.815
21-033466-041		.866
21-033466-051		.494
21-033466-061		.582
21-033466-071		.815
21-033466-081		.840

### PCB QUADRAX SOCKET

PCB Socket Part Numbers	Impedance	Length ±.015
21-033467-011	100 Ohm	1.035
21-033467-021		.815
21-033467-031*		.815
21-033467-041		.866
21-033467-051		.494
21-033467-061		.582
21-033467-071		.815
21-033467-081		.840

\*Pretinned

Indicated length given in charts above is the distance from the rear of the contact retention shoulder to the tip of the PCB tails.

Note: it does not indicate stickout length when installed in D38999 connector.

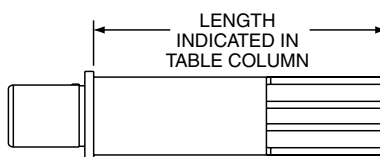

### TRANSITION ADAPTERS FOR LAUNCHING SIGNALS TO PC BOARDS

100 OHM QUADRAX TRANSITION ADAPTERS FOR LAUNCHING CONTROLLED IMPEDANCE SIGNALS TO PC BOARDS					
Quadrax Type Adapter/ Cable or PCB Tail Length	Illustration of Adapter	Part Number		Impedance (Ohms)	Mating Thread Size
		Plug	Receptacle		
Quadrax Plug Adapter/ Thermax 1536-224		21-033468-011		100	.375
PCB Quadrax Receptacle 90 Degree Adapter/ Tail Length .110			21-033469-001		
PCB Quadrax Receptacle Straight Adapter/ Tail Length .110			21-033469-011		
Quadrax Receptacle 90 degree Adapter with cable to board/ Thermax 1536-224			21-033469-021		
Quadrax Receptacle Straight Adapter with cable to board/ .195 tail length Thermax 1536-224			21-033469-031		

# New “Split-Pair” Quadrax Contacts

## Frequencies & Performance Data

For use with the following, but not limited to, electrical protocols:

10/100/1000/10GBASE-T Ethernet

- DVI
- USB 2.0
- Serial RapidIO (up to 3.125 Gbps)
- PCI-Express 2.0
- HDMI 1.3a
- SATA 2.0 (up to 3 GHz)

### FREQUENCIES OF INTEREST

Frequency (GHz)	Insertion Loss (dB)	Return Loss (dB)	NEXT (dB)	FEXT (dB)
0.1	0.09	35.68	62.36	59.29
0.24	0.22	36.44	42.87	62.25
0.5	0.45	43.66	43.63	55.22
0.625	0.57	43.49	53.68	43.53
1	0.98	17.82	49.26	48.33
1.25	1.29	15.1	43.57	44.12
1.5	1.47	17.94	46.02	40.78
1.7	1.86	12.23	48.01	47.23
2	2.11	12.9	37.45	38.12
2.5	2.42	15.97	29.9	31.52
3	2.86	16.52	35.94	29.36

### PERFORMANCE DATA

The following graphs on this page and the next page provide performance data on Amphenol® 10GBASE signal integrity (SI) quadrax contacts. Testing was done with 2 mated contacts terminated on both ends of 1 meter Thermax cable.

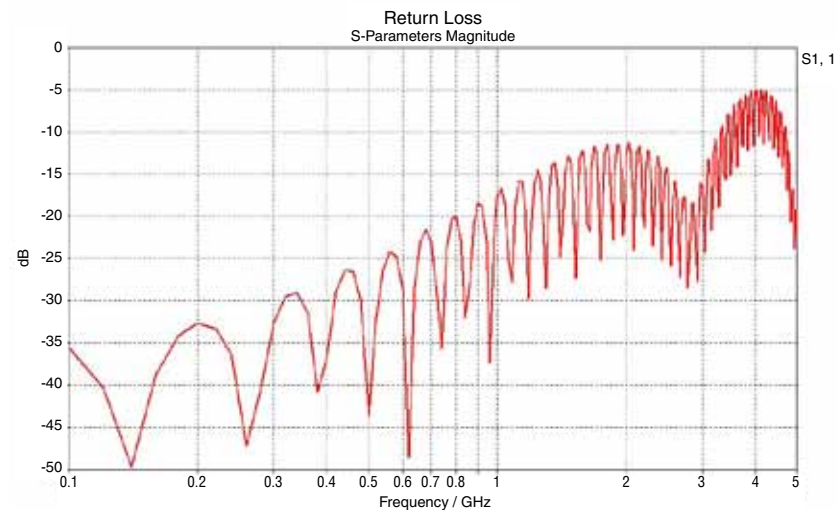
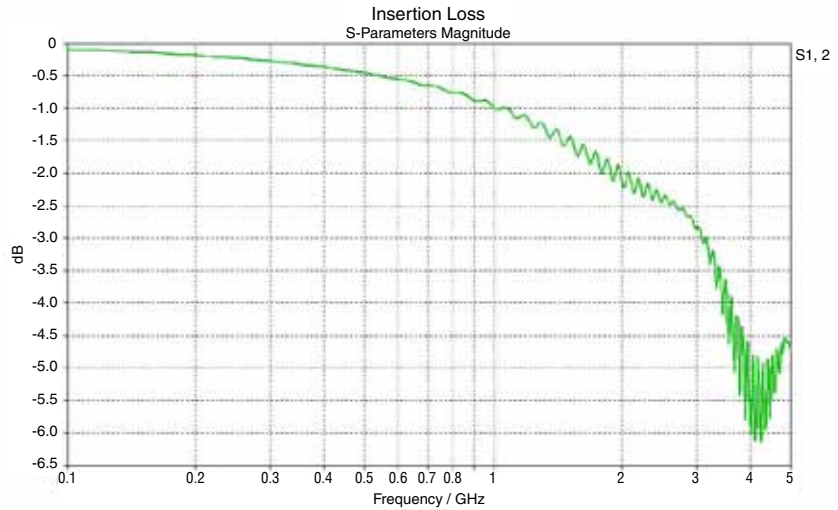

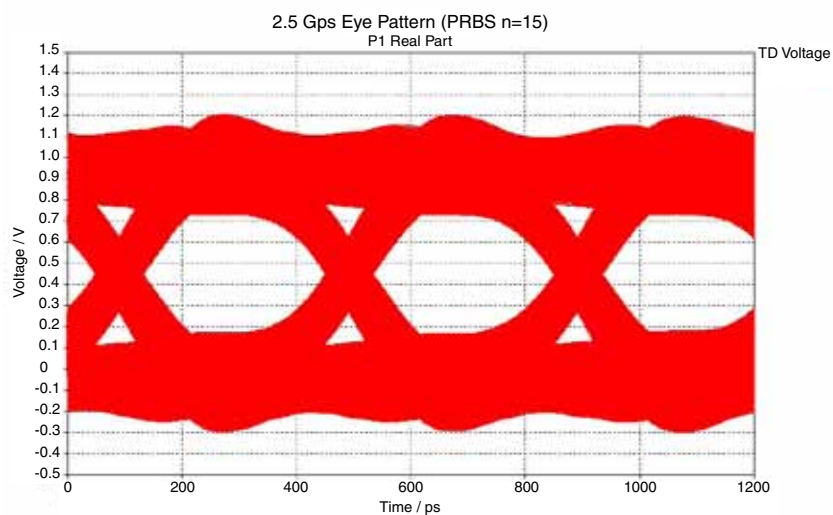
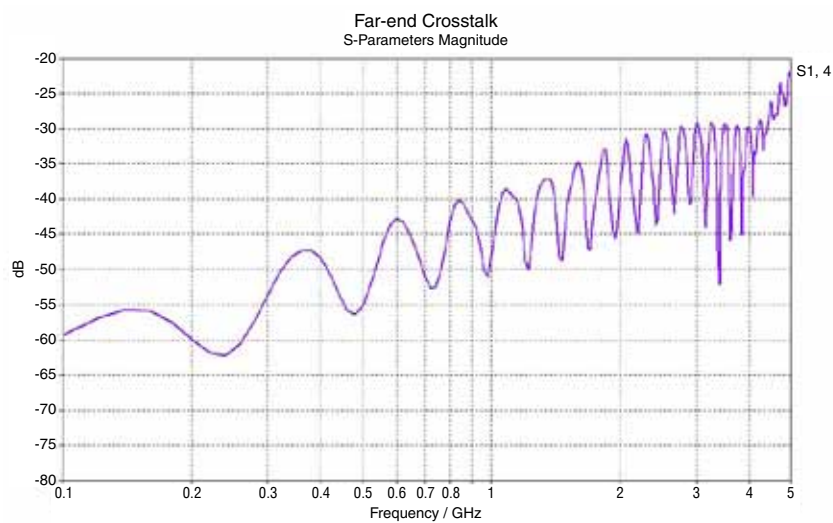
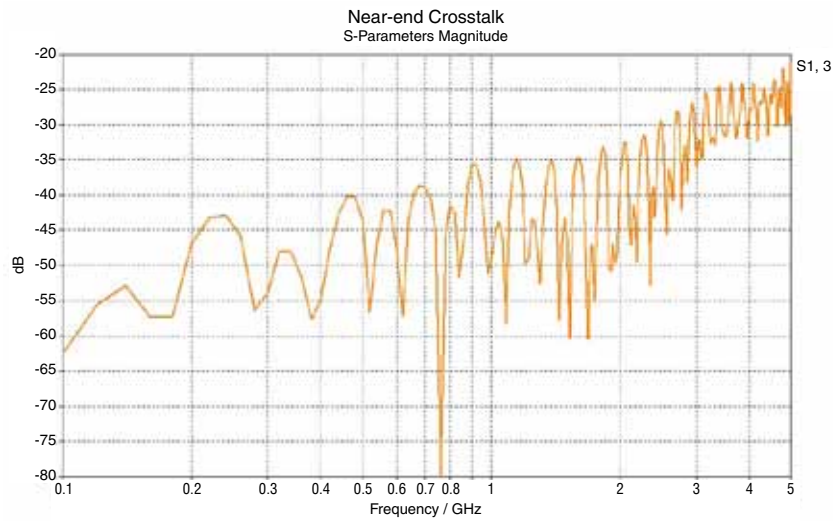

# Differential Twinax Contacts, MIL-DTL-38999

## Series III, General Description

### Amphenol® Differential Twinax Contacts -

Offer several advantages for high data transfer rates, low power consumption and excellent EMI compatibility:

- Two strategically spaced inner contacts form two 100 or 150 Ohm matched impedance differential pairs
- Outer contact has rugged wall section for durability
- Available in size 8 crimp termination style
- Also available in size 8 with PC tails (see page 386)
- Requires modification of MIL-DTL-38999 connector to accommodate keyed contacts

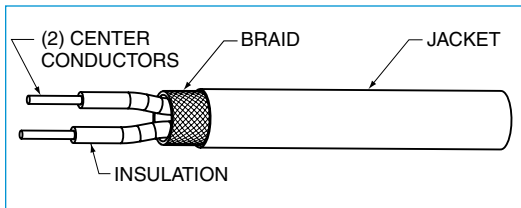

Cable Illustration - Differential Twinax Contact

**TYPICAL DIFFERENTIAL TWINAX SOCKET CONTACT** has socket outer contact with a socket inner contact

**TYPICAL DIFFERENTIAL TWINAX PIN CONTACT** has pin outer contact with a pin inner contact

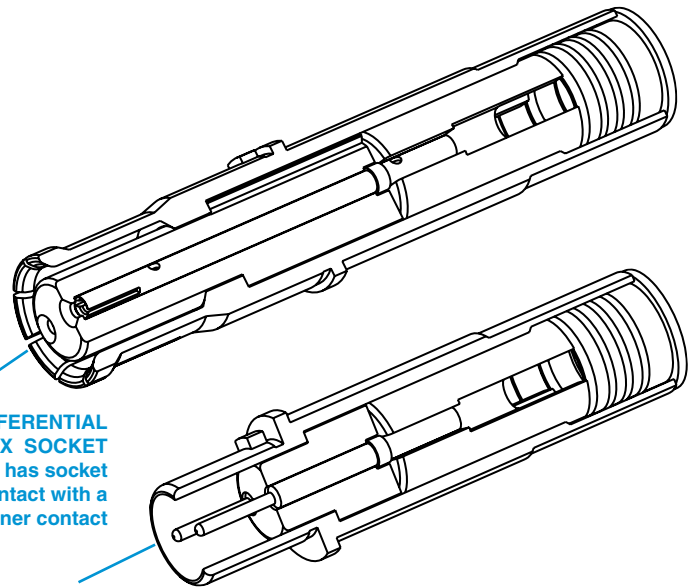

Differential Twinax Socket Contact



Differential Twinax Pin Contact

### Differential Twinax Contacts are Gold plated, Crimp Termination

Finish of mating contacts parts: supplied with 0.000050 min. gold over nickel on mating parts. Consult Amphenol for availability of other finishes.

### Differential Twinax Size 8 Contact Performance:

- Bandwidth: Up to 3 Gigahertz
- Data Rate: Exceeding 3 Gbits/sec.
- Voltage Rating: 500 Vrms max. @ sea level
- Dielectric Withstanding Voltage: 1000 VAC rms between all inner contacts @ sea level 500 VAC rms between inner and outer contacts @ sea level

### Suggested Numbering for Differential Twinax Contacts

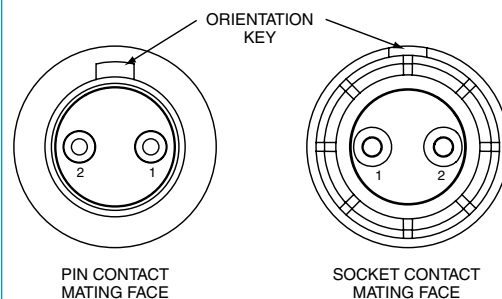

## TV-R Series, MIL-DTL-38999 Series III\* Connectors

DIFFERENTIAL TWINAX CONTACTS FOR USE IN TV-R CONNECTORS							
Cable	Contact Part Number (Termination Instruction Sheet)**		Impedance (Ohms)	Contact Size	Electrical Protocol††	Crimping Tools	
	Pin	Socket				Inner Contact	Outer Contact
Tensolite 24463/05099X-8(LD), Thermax MX 100-24, Tensolite 24463/9P025X-2(LD), Thermax 12814, ST5M1284-003 (98 Ohm), 26463/70460X-2 (98 Ohm), PIC E10224, Fileca 2709-3, NF24T100-200C (Space), S280W502-1	21-033387-021 (L-2119-E)	21-033388-021 (L-2119-E)	100	8	Ethernet, USB	M22520/2-01 with Positioner M22520/2-37 or with Daniels Positioner K709	M22520/5-01 with Die Set M22520/5-45 (Location A)
GORE GSC-05-827300-00 Tensolite 26453/03184X-2(LD) Thermax 956-626Z	21-033387-051*** (L-2119-AY)	21-033388-051*** (L-2119-AY)					
Tensolite 26453/03184X-2(LD), Thermax 956-626Z, GORE GSC-05-827300-00 ASNE08072003-09	21-033387-041 (L-2119-T)	21-033388-041 (L-2119-T)					
23460/05114X-2(LD), PIC E1024	21-033387-061 (L-2119-BH)	21-033388-061 (L-2119-BH)					
Raychem 0026A0024, M17/176-00002 (77 Ohm)	21-033387-071 (L-2119-BJ)	21-033388-071 (L-2119-BJ)					
JSFY11-24, Tensolite 24463/03220T-2(LD), Thermax 956-1T200	21-033387-091 (L-2119-BT)	21-033388-091 (L-2119-BT)					
S280W502-6, Tensolite 24463/9P026X-2(LD)	21-033387-101 (L-2119-AK)	21-033388-101 (L-2119-AK)					
AXON P509782	21-033387-131	21-033388-131	100				
Tensolite 26453/03184X-2(LD)	21-033387-151	21-033388-151	100				
Tensolite 26483/03071X-2(LD)	21-033387-031 (L-2119-AC)	21-033388-031 (L-2119-AC)	150				
Tensolite 26483/03071X-2(LD)	21-033456-001 (L-2119-BX)†	21-033457-001 (L-2119-BX)†			Fibre Channel, 1000 Base-CX Ethernet		

PCB DIFFERENTIAL TWINAX CONTACTS FOR USE IN TV-R CONNECTORS				
PCB Quadrax Contacts	Contact Part Number		Impedance (Ohms)	Contact Size
	Pin	Socket		
PCB (1.035 Length)	21-033834-001	21-033835-001	100	8
PCB (.788 Length)	21-033834-031	21-033835-031		
PCB (.494 Length)	21-033834-041	21-033835-041		
PCB (.939 Length)	21-033834-051	21-033835-051		
PCB (.780 Length)	21-033834-061	21-033835-061		
PCB (.871 Length)	21-033834-071	21-033835-071		
PCB (.937 Length)	21-033834-081	21-033835-081		
PCB (1.035 Length)	21-033834-091	21-033835-091		
PCB (.843 Length)	21-033834-101	21-033835-101		
PCB (.806 Length)	21-033834-111	21-033835-111		
PCB (.908 Length)	21-033834-121	21-033835-121		
PCB (.530 Length)	21-033834-131	21-033835-131		
PCB (.819 Length)	21-033834-141	21-033835-141		
PCB (1.035 Length)	21-033834-021	21-033835-021		
PCB (1.035 Length) mates to 210-33456/57 series	21-033458-001	21-033457-001	150	

Daniels crimping tools are available from Daniels Mfg. Corp. 6103 Anno Ave., Orlando, FL 32809

\* Requires modified connector to accommodate keyed contacts.

\*\*\* Indicated contact is vacuum degassed  
†† Test reports available for indicated protocols.  
Consult Amphenol Aerospace.

\*\*Termination instructions are packaged with each contact and can be found on-line at:

[www.amphenol-aerospace.com/serviceinstructions.asp](http://www.amphenol-aerospace.com/serviceinstructions.asp)

† Consult Amphenol Aerospace for current release of this instruction sheet.

Indicated length given in chart at left is the distance from the rear of the contact retention shoulder to the tip of the PCB tails.

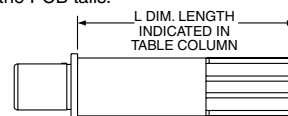

Note: it does not indicate stickout length when installed in D38999 connector.

### DIFFERENTIAL TWINAX CONTACT DATA

Contacts are inserted by hand. Refer to termination instructions listed.

Contacts are removed with a removal tool. Recommended tool is MIL-I-81969/14-06, Daniels DRK-264-8. Refer to termination instructions listed.

Finish of mating contact parts: Contact part numbers shown in the chart above are supplied gold plated per ASTM B488 Type II, Code C, .000050 min. thick over nickel plate per AMS-QQ-N-290, Class 2, .000030/.000150 thick.

# Compliant Quadrax Contacts and PC Tail

## Quadrax Contacts for Attachment to PC Boards

### General Description

#### Amphenol® Quadrax Contacts for Printed Circuit Board Attachment

Available for MIL-DTL-38999 Series III Circular connectors with straight PC tail termination and with compliant pin termination. These provide the ideal solution for bringing high speed data transmission to the board.



MIL-DTL-38999, SERIES III CONNECTOR WITH PC TAIL CONTACTS. This arrangement has 33 size 22D and 2 Quadrax PC tail contacts.



Compliant Pin Quadrax and PC Tail Quadrax Contacts

MIL-DTL-38999, SERIES III CONNECTOR WITH PC TAIL CONTACTS. This arrangement has 8 Quadrax PC tail contacts.



#### Amphenol® Quadrax Contacts for Rectangular Board Level Connectors

Incorporate the same size 8 Quadrax PCB contacts as used in circular 38999 connectors.

- Size 8 Quadrax Compliant contacts with hole diameters:
  - .025 ±.002 PTH Quadrax contact
  - .040 ±.003 PTH shell grounding
  - Accommodates backplane .125 inch min. thickness
- Consult Amphenol Aerospace for availability of additional connector configurations

##### 4 POSITION BOARD LEVEL CONNECTOR WITH QUADRAX

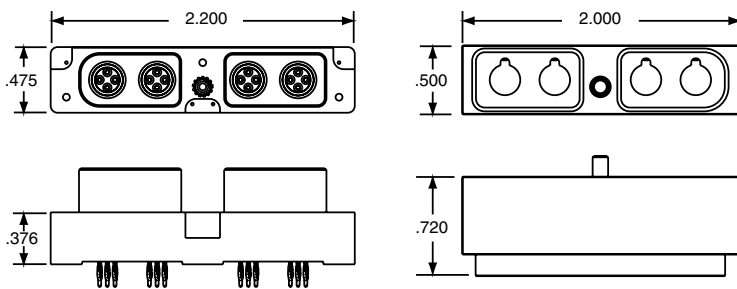

Compliant Pin Quadrax Board Level Connector

##### 8 POSITION BOARD LEVEL CONNECTOR WITH QUADRAX

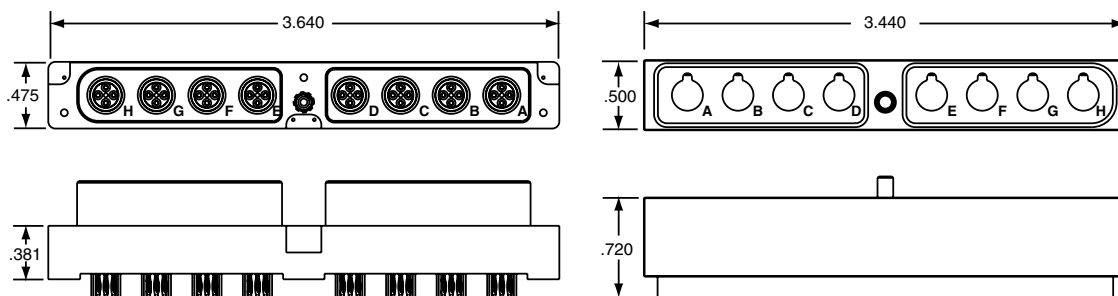

# Quadrax Transition Adapters and Differential Twinax Transition Adapters

## General Description

**Amphenol® Transition Adapters** - Are used to facilitate launching of controlled impedance signals to printed circuit boards. Amphenol provides transition adapters in both contact types:

- Quadrax transition adapters, 90° or straight receptacles threaded or cable to board style
- Differential twinax transition adapters, 90° or straight receptacles, threaded or cable to board style

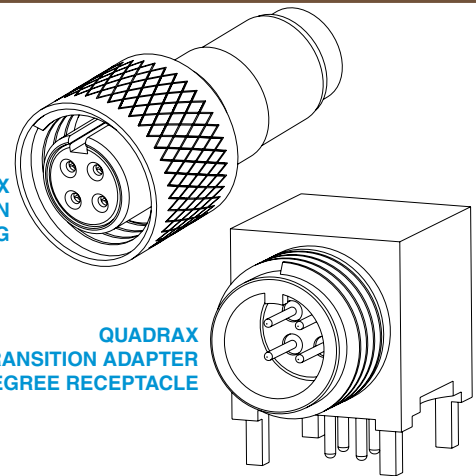

90° Quadrax Receptacle and Plug Transition Adapter

### Suggested Numbering for Transition Adapters with Quadrax Contacts

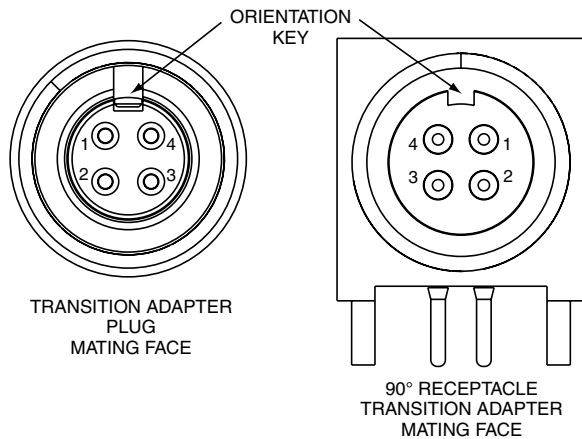

90° Differential Twinax Receptacle and Plug Transition Adapter

### TRANSITION ADAPTER DATA

Finish of mating contact parts: Contacts are supplied gold plated per ASTM B488 Type II, Code C, .000050 min. thick over nickel plate per AMS-QQ-N-290, Class 2, .000030/.000150 thick.

### ELECTRICAL PROTOCOLS FOR QUADRAX TRANSITION ADAPTERS

Part Number		Impedance (Ohms)	Electrical Protocol††
Plug	Receptacle		
21-033836-031		100	Ethernet, gigabit Ether
21-033836-041			Ethernet, gigabit Ether
21-033836-051			Ethernet, gigabit Ether
21-033836-061			Ethernet, gigabit Ether
	21-033837-081 (90 degree)		
	21-033837-091 (90 degree)		
	21-033837-041 (90 degree)		
	21-033837-051 (straight)		Ethernet, gigabit Ether
	21-033837-061 (90 degree)		
	21-033837-141 (90 degree)		
21-033837-101		150	1000 Base CX, Fibre channel
21-033836-021			1000 Base CX, Fibre channel
	21-033837-021 (90 degree)		
	21-033837-211 (jam nut)		
	21-033837-031 (straight)		
	21-033837-071 (90 degree)		
21-033837-111			

### ELECTRICAL PROTOCOLS FOR DIFFERENTIAL TWINAX TRANSITION ADAPTERS

Part Number		Impedance (Ohms)	Electrical Protocol††
Plug	Receptacle		
21-033832-81		100	Ethernet
21-033832-21			Ethernet
	21-033833-021 (90 degree)		
	21-033833-031 (90 degree)		
	21-033833-151 (90 degree)		
21-033832-111†			
	21-033833-161† (90 degree)		
	21-033833-171† (90 degree)		
	21-033833-091 (90 degree)		
	21-033833-051 (90 degree)		
	21-033833-141 (90 degree)		
21-033832-91		150	
	21-033833-111 (90 degree)		
	21-033833-181† (90 degree)		
	21-033833-101 (90 degree)		

† Consult Amphenol Aerospace for current release of this adapter.  
 †† Test reports available for indicated protocols; consult Amphenol Aerospace.



# Quadrax Transition Adapters

## for Attachment to PC Boards

### Application Data

100 OHM QUADRAX TRANSITION ADAPTERS FOR LAUNCHING CONTROLLED IMPEDANCE SIGNALS TO PC BOARDS											
Quadrax Type Adapter/ Cable or PCB Tail Length	Illustration of Adapter	Part Number (Termination Instruction Sheet)**		Impedance (Ohms)	Mating Thread Size	Crimping Tools					
		Plug	Receptacle			Inner Contact	Outer Contact				
Quadrax Plug Adapter/ Tensolite NF24Q100, NF24Q100-01 24443/9P025X-4(LD) S280W502-4 24443/03130X-4(LD) Thermax 956-4TN		21-033836-031 (L-2119-U)		100	.375	M22520/2-01 with Positioner M22520/2-37 or with Daniels Positioner K709	M22520/5-01 with Die Set M22520/5-45 (Location A)				
Quadrax Plug Adapter/ Tensolite NF22Q100, NF22Q100-01, Thermax 956-5, Tensolite 24450/030894-4(LD) Draka Fileca F-4704-5		21-033836-041 (L-2119-W)†									
Quadrax Plug Adapter/ Draka Fileca F-4703-3, F-4704-4		21-033836-051 (L-2119-Y)									
Quadrax Plug Adapter/ NF26Q100		21-033836-061 (L-2119-AM)†									
Gore RCN8724 (30 awg)		21-033836-071									
Gore ACN1042 (28 awg) Gore RCN8973		21-033836-101									
Quadrax Plug Adapter/ Hexnut with Lock Wire Holes Tensolite NF24Q100-01		21-033836-081		100	.375	M22520/2-01 with Positioner M22520/2-37 or with Daniels Positioner K709	M22520/5-01 with Die Set M22520/5-45 (Location A)				
Quadrax Receptacle Straight Adapter in-line jam nut (threaded)/ GSC-10-8273900			21-033837-081 (L-2119-AR)†								
Quadrax Receptacle Straight Adapter in-line jam nut (threaded) Tensolite NF24Q100-01			21-033837-261								
Quadrax Receptacle Straight Adapter in-line (threaded)/NF24Q100 Tensolite NF24Q100-01, Tensolite 24443/9P025X -4 (LD), S280W502-4, Tensolite 24443/03130X-4 (LD), Thermax 956-4TN			21-033837-091 (L-2119-BL)								
PCB Quadrax Receptacle 90 Degree Adapter/Tail Length .110			21-033837-041					100	.375	NA	NA
PCB Quadrax Receptacle 90 Degree Adapter/Tail Length .200			21-033837-201								
PCB Quadrax Receptacle Straight Adapter/Tail Length .110			21-033837-051								
PCB Quadrax Receptacle Straight Adapter/Special Tail Length (.200)			21-033837-061								
Straight adapter Tail Length .175			21-033837-131								
Quadrax Receptacle 90 degree Adapter with cable to board/ NF24Q100 Tail Length .110			21-033837-141 (L-2119-BB)†					100	.375	M22520/2-01 with Positioner M22520/2-37 or with Daniels Positioner K709	M22520/5-01 with Die Set M22520/5-45 (Location A)
Quadrax Receptacle 90 degree Adapter with cable to board/ ABS1503KD24 Tail Length .110 Tensolite NF22Q100-01 Thermax 956-5 Draka Fileca F4704-5			21-033837-231								
Quadrax Receptacle Straight Adapter with cable to board/ NF24Q100, NF24Q100-01 Tail Length .195			21-033837-101 (L-2119-AN)								
Quadrax receptacle straight adapter w/ cable to board, Tail length .195 Draka Fileca F-4703-3, F-4703-4				21-033837-241							

Daniels crimping tools are available from Daniels Mfg. Corp. 6103 Anno Ave., Orlando, FL 32809

\*\* Termination instructions are packaged with each contact and can be found on-line at: [www.amphenol-aerospace.com/serviceinstructions.asp](http://www.amphenol-aerospace.com/serviceinstructions.asp)





† Consult Amphenol Aerospace for current release of this adapter and instruction sheet if applicable.

See electrical protocols for transition adapters on page 388.

# Quadrax Transition Adapters

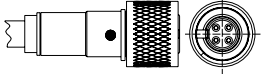
## For Attachment to PC Boards

### Application Data

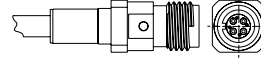
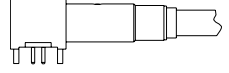
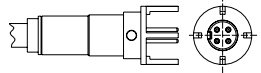
150 OHM QUADRIX TRANSITION ADAPTERS FOR LAUNCHING CONTROLLED IMPEDANCE SIGNALS TO PC BOARDS							
Quadrax Type Adapter/ Cable or PCB Tail Length	Illustration of Adapter	Part Number (Termination Instruction Sheet)**		Impedance (Ohms)	Mating Thread Size	Crimping Tools	
		Plug	Receptacle			Inner Contact	Outer Contact
Quadrax Plug Adapter/ Tensolite 26473/02006X-4(LD), Gore RCN8328		21-033836-021 (L-2119-S)		150	.375	M22520/2-01 with Positioner M22520/2-34	NA
PCB Quadrax Receptacle 90 Degree Adapter/Tail Length .110			21-033837-021				
PCB Receptacle 90 Degree Adapter/ Tail Length .200			21-033837-251				
PCB Quadrax Receptacle Straight Adapter/Tail Length .110			21-033837-031				
Quadrax Receptacle Straight Adapter in-line Jam Nut (threaded) Tensolite 26473/02006X-4 (LD), Gore RCN8328			21-033837-211 (L-2119-BY)	150		M22520/2-01 with Positioner M22520/2-34	M22520/5-01 with Die Set M22520/5-45 (Location A)
Quadrax Receptacle 90 degree Adapter with cable to board/ Tensolite 26473/02006X-4			21-033837-071 (L-2119-A)†				
Quadrax Receptacle Straight Adapter with cable to board/ Tensolite 26473/02006X-4 (LD)			21-033837-111 (L-2119-AP)				

Daniels crimping tools are available from Daniels Mfg. Corp. 6103 Anno Ave., Orlando, FL 32809

\*\*Termination instructions are packaged with each contact and can be found on-line at: [www.amphenol-aerospace.com/serviceinstructions.asp](http://www.amphenol-aerospace.com/serviceinstructions.asp)

† Consult Amphenol Aerospace for current release of this adapter and instruction sheet if applicable.

See electrical protocols for transition adapters on page 388.

# Differential Twinax Transition Adapters for Attachment to PC Boards - Application Data

100 OHM DIFFERENTIAL TWINAX TRANSITION ADAPTERS FOR LAUNCHING CONTROLLED IMPEDANCE SIGNALS TO PC BOARDS							
Differential Twinax Type Adapter/ Cable or PCB Tail Length	Illustration of Adapter	Part Number (Termination Instruction Sheet)**		Impedance (Ohms)	Mating Thread Size	Crimping Tools	
		Plug	Receptacle			Inner Contact	Outer Contact
Differential Twinax Plug Adapter/ M17/176-00002 (77 ohms) 24463/9P026X-2		21-033832-081 (L-2119-AJ)		100	.3125	M22520/2-01 with Positioner M22520/2-34	M22520/5-01 with Die Set M22520/5-05 (Location B)
Differential Twinax Plug Adapter/ Tensolite 24463/9P025X-2(LD) 10-646060		21-033832-021 (L-2119-P)					
PCB Differential Twinax Receptacle 90 Degree Adapter/ Tail Length .110			21-033833-021				
PCB Differential Twinax Receptacle Straight Adapter/ Tail Length .110			21-033833-031				
PCB Differential Twinax Receptacle Straight Adapter/ Tail Length .165			21-033833-151				
Differential Twinax Plug Adapter/ Tensolite CAN22TDT120 (120 Ohm)		21-033832-111†		100	.375	M22520/2-01 with Positioner M22520/2-34	M22520/5-01 with Die Set M22520/5-45 (Location A)
PCB Differential Twinax Receptacle 90 degree Adapter/Tail Length .283			21-033833-161†				
PCB Differential Twinax Receptacle Straight Adapter/Tail Length .283			21-033833-171†				
Differential Twinax Receptacle 90 degree Adapter (low profile) with cable to board/ Tensolite 24463/9P026X-2			21-033833-091 (L-2119-AF)	100	N/A	M22520/2-01 with Positioner M22520/2-34	M22520/5-01 with Die Set M22520/5-45 (Location A)
Differential Twinax Receptacle 90 degree Adapter with cable to board/ Tensolite 24463/9P025X-2			21-033833-051 (L-2119-V)				
Differential Twinax Receptacle 90 degree Adapter with cable to board/ Tensolite 24463/9P025X-2			21-033833-141 (L-2119-BU)				

150 OHM DIFFERENTIAL TWINAX TRANSITION ADAPTERS FOR LAUNCHING CONTROLLED IMPEDANCE SIGNALS TO PC BOARDS							
Differential Twinax Type Adapter/ Cable or PCB Tail Length	Illustration of Adapter	Part Number (Termination Instruction Sheet)**		Impedance (Ohms)	Mating Thread Size	Crimping Tools	
		Plug	Receptacle			Inner Contact	Outer Contact
Differential Twinax Plug Adapter/ Tensolite 26483/03071X-2		21-033832-091 (L-2119-BR)		150	.375	M22520/2-01 with Positioner M22520/2-34	M22520/5-01 with Die Set M22520/5-45 (Location A)
PCB Differential Twinax Receptacle 90 Degree Adapter/ Tail Length .110			21-033833-111				
PCB Differential Twinax Receptacle Straight Adapter/ Tail Length .110			21-033833-181†				
Differential Twinax Receptacle 90 degree Adapter with cable to board/ Tensolite 26483/03071X-2			21-033833-101 (L-2119-BM)†	150	N/A	M22520/2-01 with Positioner M22520/2-34	M22520/5-01 with Die Set M22520/5-45 (Location A)

\*\*Termination instructions are packaged with each contact and can be found on-line at:  
[www.amphenol-aerospace.com/serviceinstructions.asp](http://www.amphenol-aerospace.com/serviceinstructions.asp)

† Consult Amphenol Aerospace for current release of this adapter and instruction  
sheet if applicable. See electrical protocols for transition adapters on page 388.

Amphenol now offers differential twinax transition adapters in smaller sizes that provide matched impedance interconnection to PCB boards. Our unique push-pull quick disconnect adapter design offers:

- Advantages over traditional threaded type adapters
- Launching of controlled impedance (100 ohm) signals for high speed twinax contacts with push-pull quick disconnect coupling
- Rugged construction, 100+ mating cycles for reliable and secure data transmission
- Miniature size for tighter spacing on boards
- Intermountability with existing threaded solutions having the same PCB tail footprint

Styles include:

- Plug - standard length and extended length options
- Straight PCB receptacle, 90° PCB receptacle
- Two jam nut receptacle styles - both with standard length and extended length options
- Bushing assembly 90° adapter (used with plug or jam nut receptacle)



**Micro D-Twinax Transition Adapters**  
Shown right: Straight receptacle mated to plug  
Shown left: Jam nut and 90° receptacles

### Micro D-Twinax Transition Adapter Plug

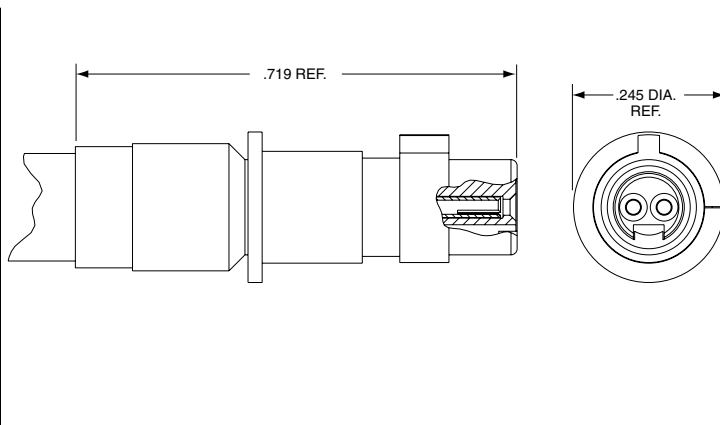

Part Number	Cable Type*	Impedance (Ohms)
21-033832-151	Calmont 3007-1923-12-7	100
21-033832-161	Tensolite 26453/03184X-2LD Thermax 956-626Z	
21-033832-121**	Calmont 3007-1923-12-7	

\* See page 3 for information on other cable terminations.

\*\* Same as -151 with extended ferrule for added cable support

### Micro D-Twinax Transition Adapter Straight PCB Receptacle

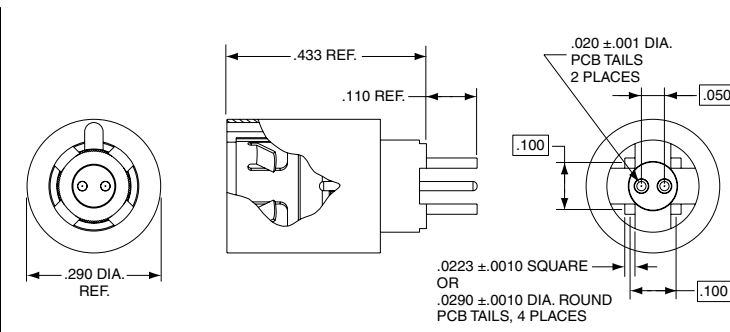

Part Number	Impedance (Ohms)
21-033833-191	100

All dimensions for reference only.

# Micro D-Twinax Transition Adapters

## Push-Pull Quick disconnect Interconnects

### Micro D-Twinax Transition Adapter 90° PCB Receptacle

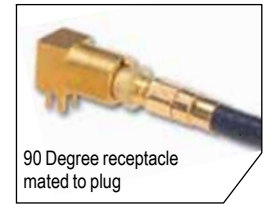
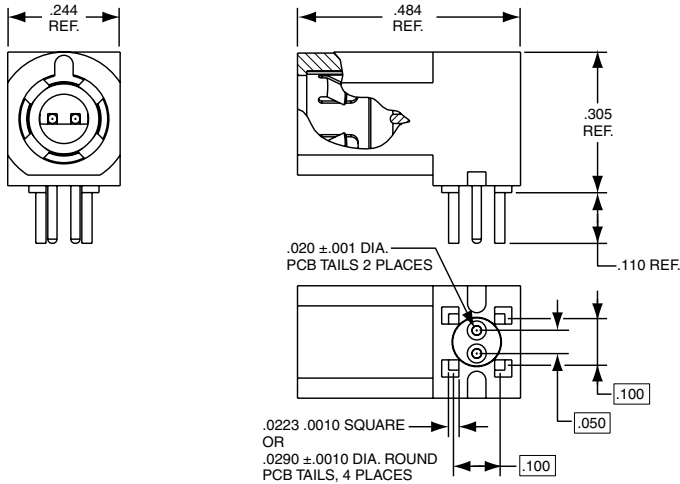

Part Number	Impedance (Ohms)
21-033833-201	100
21-033833-281 .140 PCB tail length	

All dimensions for reference only.

### Micro D-Twinax Transition Adapter Jam Nut Receptacles

#### Jam Nut Receptacle, Style 1

Smaller diameter front shell requires a smaller mounting D-hole dimension in panel.

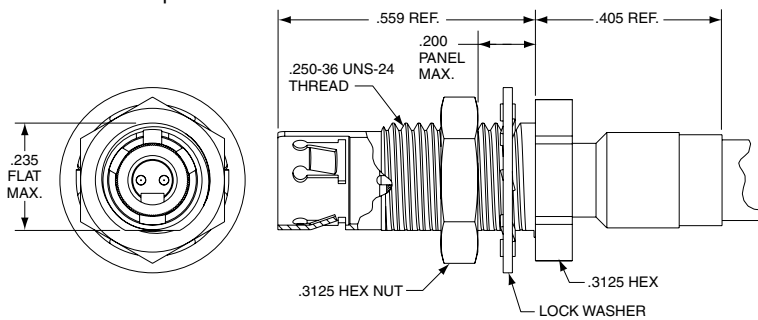

Part Number	Cable Type*	Impedance (Ohms)
21-033833-241	Calmont 3007-1923-12-7	100
21-033833-261	Tensolite 26453/03184X-2LD Thermax 956-626Z	
21-033833-211**	Calmont 3007-1923-12-7	

\* See page 3 for information on other cable terminations.

\*\* Same as -241 with extended ferrule for added cable support

#### Jam Nut Receptacle, Style 2

Has a larger diameter front shell than Style 1. Requires a larger mounting D-hole in panel.

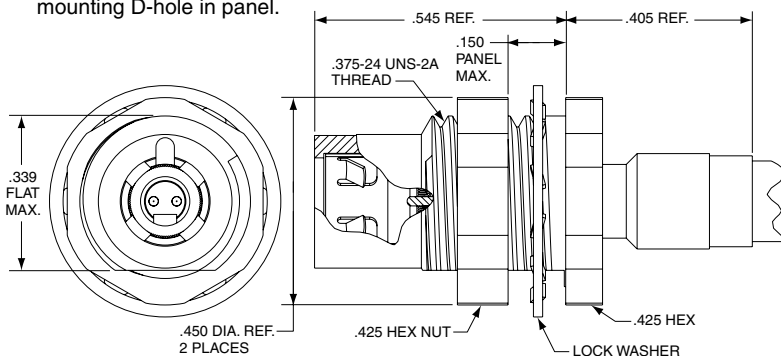

Part Number	Cable Type*	Impedance (Ohms)
21-033833-251	Calmont 3007-1923-12-7	100
21-033833-271	Tensolite 26453/03184X-2LD Thermax 956-626Z	
21-033833-231**	Calmont 3007-1923-12-7	

\* See page 3 for information on other cable terminations.

\*\* Same as -251 with extended ferrule for added cable support

### 90° Bushing Assemblies for use with Wired Micro D Transition Adapters

To facilitate tight cable bend requirements, Amphenol provides 90° bushing assemblies which convert straight plug and receptacle wired adapters into 90° wired adapters.

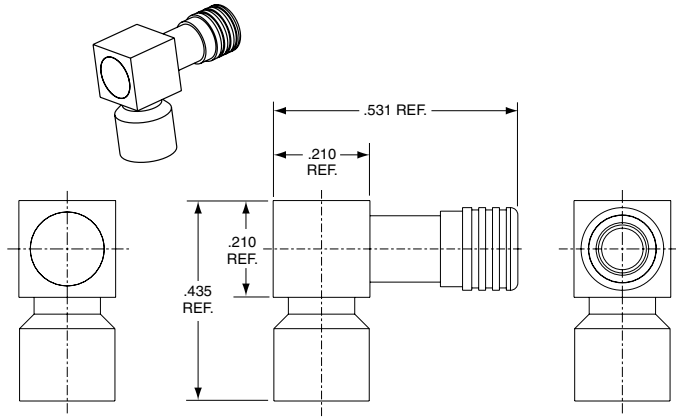

#### 90° Bushing Assembly Part Number

21-033425-201

90° bushing assembly is ordered separately. Adapters are not included with bushing assembly.



90° Bushing Assembly with  
Jam Nut Micro D Transition Adapter

Illustrations below show how the 90° bushing assembly attaches to either a plug or a jam nut receptacle adapter.

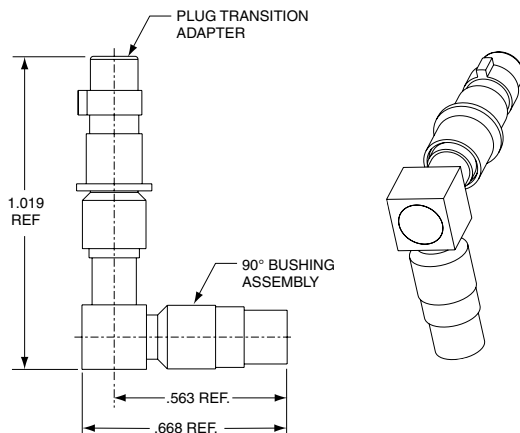

90° Bushing Assembly with Wired Micro D Plug Transition Adapter

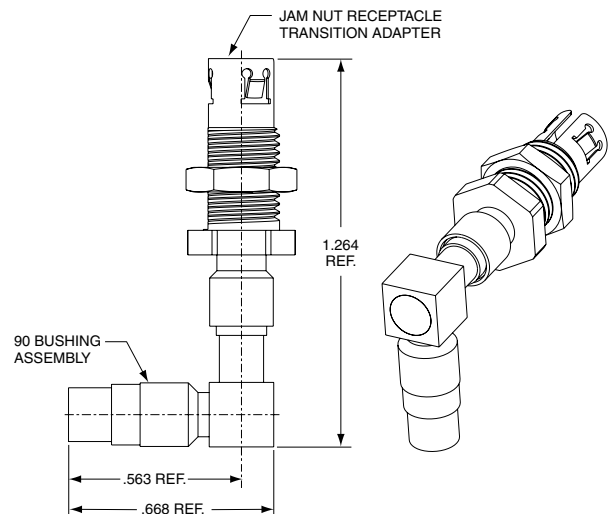

90° Bushing Assembly with Wired Micro D Jam Nut Receptacle Transition Adapter

All dimensions for reference only.

Amphenol transition adapters are capable of terminating to additional 100 Ohm cables beyond what are listed in the charts on pages 1 and 2. Cables need to have the following dimensions:

- .0210/.011 Dia. stranded center conductor (26/30 AWG)
- .045 Dia. max. inner wire insulation
- .115 Dia. max. outer braid (round type preferred)
- .150 Dia. max. jacket

Consult Amphenol Aerospace for other cable termination possibilities.

# Insert Arrangements - MIL-DTL-38999, Series III Incorporating Quadrax & Differential Twinax Contacts

This illustrated listing represents the most readily available patterns incorporating quadrax and differential twinax contacts within D38999, Series III connectors. If you require other arrangements than what are shown here, consult Amphenol for further availability. In most cases, unless otherwise stated, size 8 cavities can be filled with quadrax or differential twinax contacts. Arrangements can be mixed with any size 8 coax, and/or concentric twinax or triax contacts.

## Front face of pin inserts illustrated

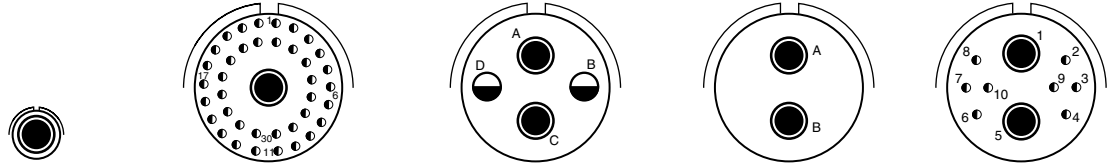

Insert Arrangement	9-5		17-2		17-22		17-52		17-60	
Number of Contacts	1		38	1	2	2	2		8	2
Contact Size	8		22D	8 Twinax	12	8	8		22D	8
	Grounded				Meets Boeing Specification					

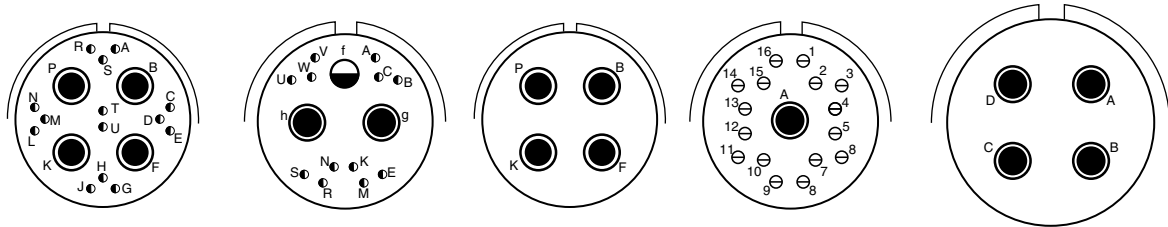

Insert Arrangement	19-18		19-31			19-AB	19-AD		21-75
Number of Contacts	14	4	12	1	2	4	16	1	4
Contact Size	22D	8	22D	12	8	8	20	8	8

Note: 19-AB same as 19-18 but no 22D contacts. Ground plane only.

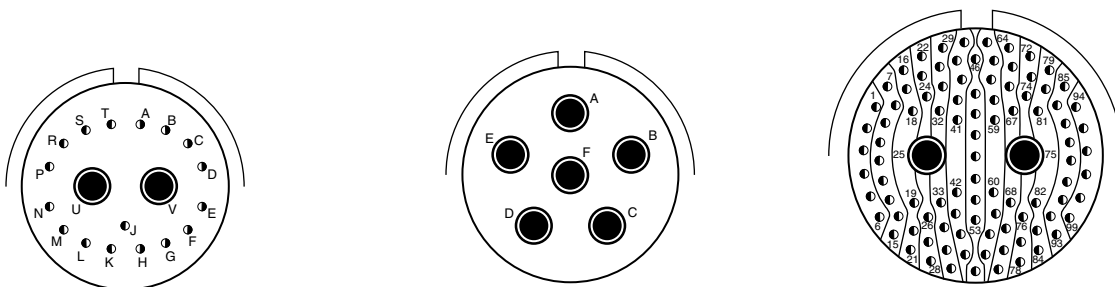

Insert Arrangement	21-79		23-6		25-7	
Number of Contacts	17	2	6		97	2
Contact Size	22D	8	8		22D	8

### CONTACT LEGEND



Front face of pin inserts illustrated

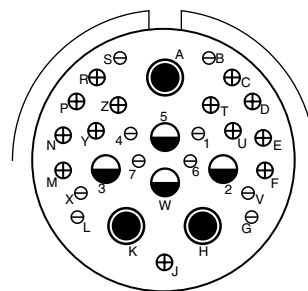
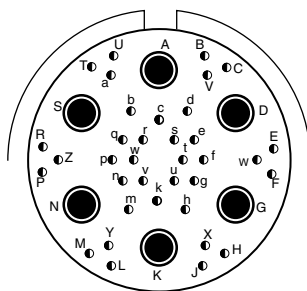
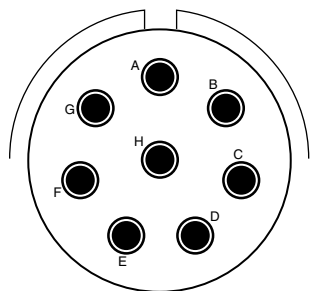

Insert Arrangement	25-8			25-17			25-20				
Number of Contacts	8			36	6		10	13	3	4	
Contact Size	8			22D	8		20	16	8	12	

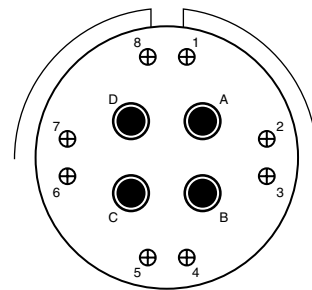
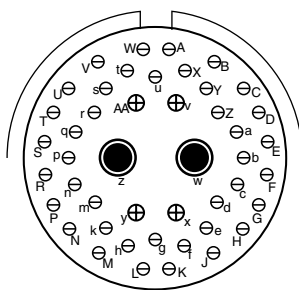
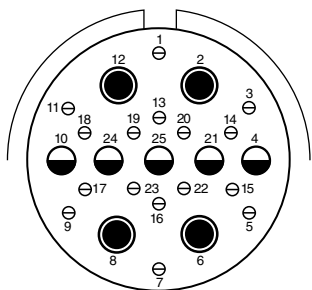

Insert Arrangement	25-26			25-46			25-62	
Number of Contacts	16	5	41	40	4	2	8	4
Contact Size	20	12	8	20	16	8	16	8

Ground plane only





# How to Order 38999, Series III Circular With Quadrax 100 Ohm Contacts

Amphenol Tri-Start, 38999 Series III\* Connectors can be ordered with the following popularly used Quadrax contacts:  
 100 ohm quadrax 21-033385-051 socket contacts  
 100 ohm quadrax 21-033384-051 pin contacts  
 Use the following coded number ordering procedure :

1.	2.	3.	4.	5.	6.
Connector Type	Shell Type	Service Class	Shell Size – Insert Arrangement	Contact Type	Alternate Keying Position
<b>TVP</b>	<b>00</b>	<b>RQW</b>	<b>21-75</b>	<b>P</b>	<b>B</b>

For ordering of connectors with any other quadrax contacts or differential twinax contacts, please consult Amphenol Aerospace for part numbers.

## Step 1. Select a Connector Type

<b>TV</b>	Tri-Start Series Connector with metal shells
<b>TVP</b>	Back panel mounted receptacle with metal shells
<b>CTV</b>	Tri-Start Series Connector with composite shells
<b>CTVP</b>	Back panel mounted receptacle with composite shells

## Step 2. Select a Shell Style

<b>00</b>	Wall mount receptacle
<b>02</b>	Box mount receptacle available only with the PCB tails and epoxy backfilled (non-removable)
<b>06</b>	Straight plug
<b>07</b>	Jam nut receptacle

## Step 3. Select a Service Class with Quadrax

<b>RQF</b>	Electroless nickel plated
<b>RGQF</b>	Electroless nickel plated ground plane
<b>RQW</b>	Olive drab cadmium plate
<b>RGQW</b>	Olive drab cadmium plated ground plane
<b>RQB</b>	NiAlBronze
<b>RGQB</b>	NiAlBronze ground plane
<b>RQK</b>	Corrosion resistance stainless steel
<b>RGQK</b>	Stainless steel ground plane
<b>QDT</b>	Durmalon plated, Nickel-PTFE alternative to cadmium
<b>GQDT</b>	Groundplane Durmalon

## Step 4. Select a Shell Size and Insert Arrangement

See insert arrangements available with quadrax contacts on preceding pages. Shell Size and Insert Arrangements are together in one chart. First number represents Shell Size, second number is the Insert Arrangement

## Step 5. Select Contact Type

<b>P</b>	Pin contacts
<b>S</b>	Socket contacts

## Step 6. Select an Alternate Keying Position

Locksmith keying—rotation of minor keys. See Series III Alternate Positions below “N” not required for normal position

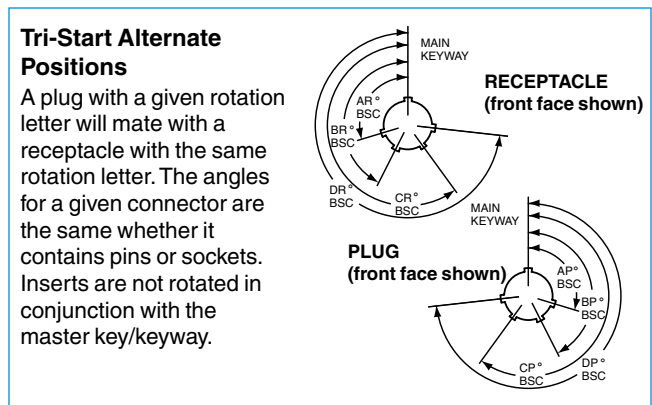

Shell Size	Key & Keyway Arrangement Identification Letter	AR° or AP° BSC	BR° or BP° BSC	CR° or CP° BSC	DR° or DP° BSC
9	N	105	140	215	265
	A	102	132	248	320
	B	80	118	230	312
	C	35	140	205	275
	D	64	155	234	304
11, 13, and 15	N	95	141	208	236
	A	113	156	182	292
	B	90	145	195	252
	C	53	156	220	255
	D	119	146	176	298
17 and 19	N	80	142	196	293
	A	135	170	200	310
	B	49	169	200	244
	C	66	140	200	257
	D	62	145	180	280
21, 23, and 25	N	80	142	196	293
	A	135	170	200	310
	B	49	169	200	244
	C	66	140	200	257
	D	62	145	180	280
25L, 33, and 37	N	80	142	188	293
	A	135	170	188	310
	B	49	169	188	244
	C	66	140	188	257
	D	62	145	188	280
	E	79	153	188	272

\* The incorporation of quadrax or differential twinax contacts requires a modified connector to accommodate keyed contacts.

For more information on Tri-Start, MIL-DTL-38999 Series III connectors see the section in this catalog.

**Amphenol® Coaxial Contacts** - Offer several advantages for reliable interconnection and continued performance:

- Large crimping area assures low contact resistance and high tensile strength
- Back insulator positively captivates inner contact against axial loads
- Front insulator provides closed entry for socket inner contact
- Recessed inner contact is protected
- Outer contact has rugged wall section for durability

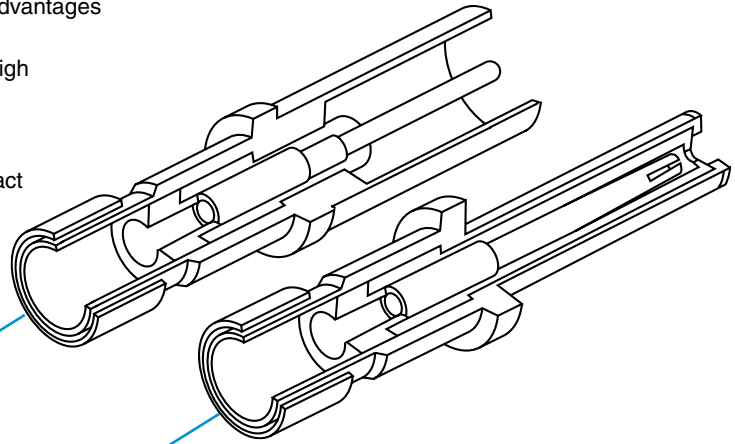

**TYPICAL SUBMINIATURE COAX SOCKET CONTACT** has socket outer contact with a pin inner contact

**TYPICAL SUBMINIATURE COAX PIN CONTACT** has pin outer contact with a socket inner contact



MIL-DTL-38999 LJT-R, JT-R, TV-R, SJT-R MS Type, Coax Size 12 Socket Assembled Contact

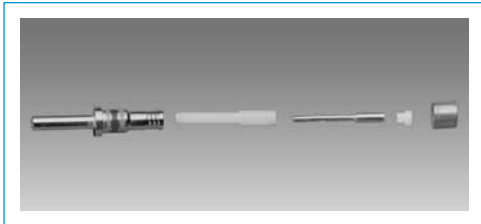

MIL-DTL-38999 LJT-R, JT-R, TV-R, SJT-R MS Type, Coax Size 16 Pin Unassembled Contact

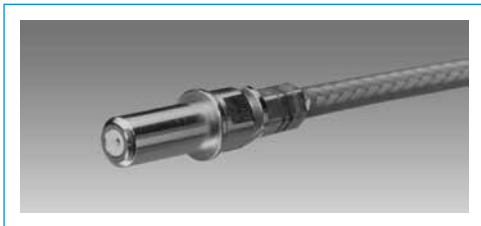

MIL-DTL-38999 LJT-R, JT-R, TV-R, SJT-R MS Type, Coax Size 8 Pin Assembled Contact

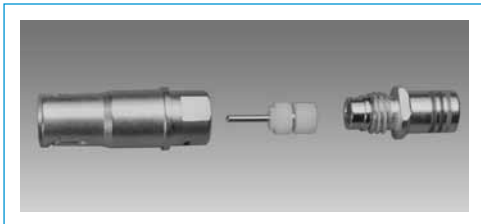

MIL-DTL-38999 LJT-R, JT-R, TV-R, SJT-R MS Type, Coax Size 8 Socket Unassembled Contact

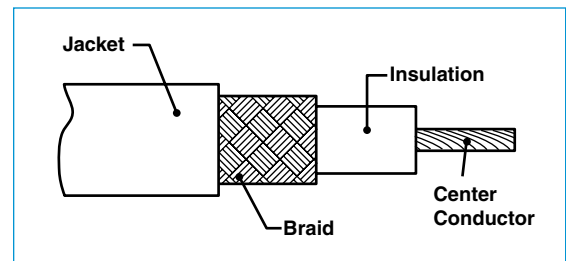

Cable Illustration - Coax Contact

**Coax Contacts are gold plated, crimp termination**

Finish of mating contacts parts: supplied with 0.000050 min. gold over nickel on mating parts. Other finishes are available; consult Amphenol for further information.

**Coax Size 12 & 16 Contact Performance:**

- Typical VSWR: 1.5:1 maximum up to 700 MHz and 500 MHz respectively, for properly cabled size 12 and 16 coaxial contacts in the M38999 Series I, II and III
- Insulation Resistance: 5,000 megohms minimum @ 25°C
- Dielectric Withstanding Voltage:  
Size 12: 1,000 VAC Rms @ sea level, 250 VAC Rms @ 50,000 ft.  
Size 16: 800 VAC Rms @ sea level, 250 VAC Rms @ 50,000 ft.
- Contact Resistance: See MIL-C-39029/27, /28, /75, /76, /77, /78

**Coax Size 8 Contact Performance:**

- Typical VSWR when terminated to specified 50 ohm cable: 1.5:1 maximum up to 3 GHz (excluding 21-033101/2-27)
- Insulation Resistance: 5,000 megohms minimum @ 25°C
- Dielectric Withstanding Voltage:  
1,300 VAC Rms @ sea level, 250 VAC Rms @ 50,000 ft.
- Contact Resistance: See MIL-C-39029/59, /60

### JT-R Series, MIL-DTL-38999 Series II, SAE AS39029 (27, 28, 76, 78)

COAX CONTACTS FOR USE IN JT-R CONNECTORS							
Cable	Contact Part Number (Termination Instruction Sheet)**		Contact Size	Crimping Tools		Installation Tools	
	Pin	Socket		Inner Contact	Crimp Ferrule	Insertion	Removal
RG-178B/U, RG-196A/U	21-033122-564 (M39029/76-425) (L-2035-AG)	21-033121-564 (M39029/78-433) (L-2035-AH)	16	M22520/2-01 with Positioner M22520/2-35 or with Daniels Positioner K532	M22520/4-01 with Positioner M22520/4-02	M81969/8-07 or M81969/14-03	M81969/8-08 or M81969/14-03
Haveg 30-00761, 30-02024, 30-02033 Tensolite 24713/A955KK1, 26723/ A955KK1	21-033122-562† (L-2035-AN)	21-033121-562† (L-2035-AP)				Amphenol 11-8674-16 11-8794-16 or MS27495A16	Amphenol 11-8675-16 11-8795-16 or MS27495R16
Haveg 61-02051	21-033122-561† (L-2035-AK)	21-033121-561† (L-2035-AL)				or MS27534-16	MS27534-16
RG-174A/U, RG-188A/U, RG-161/U, RG-187A/U, RG-316/U, RG-179B/U, Haveg 8100207, Times (HS-179) AA3248, Teledyne 11299, Raychem 7528H1424	21-033122-563 (M39029/76-424) (L-2035-AD)	21-033121-563 (M39029/78-432) (L-2035-AE)				12	M22520/2-01 with Positioner M22520/2-34 or with Daniels Positioner K323
RG-180B/U, RG-195A/U, Raychem 9528A1318	21-033122-541 (M39029/28-409) (L-2035-C)	21-033121-541 (M39029/27-402) (L-2035-E)	Amphenol 11-8674-12 11-8794-12 or MS27495A12	Amphenol 11-8675-12 11-8795-12 or MS27495R12			
Raychem 5022E5111	21-033122-543† (L-2035-M)	21-033121-543† (L-2035-N)	or MS27534-12	MS27534-12			
Raychem 9530A5314	21-033122-544 (L-2035-R)	21-033121-544 (L-2035-S)	MS27534-12	MS27534-12			
Raychem 9527A1318	21-033122-545 (L-2035-U)	21-033121-545 (L-2035-V)					
Gore GWN1159A	21-033122-547† (L-2035-X)	21-033121-547† (L-2035-Y)					

### MIL-DTL-38999 CONTACT DATA

All contacts mate with other contacts in this series which have the same inner and outer contact diameters.

NOTE: SAE AS39029 supersedes MIL-C-39029

\*\*Termination instructions are packaged with each contact and can be found on-line at:  
[www.amphenol-aerospace.com/serviceinstructions.asp](http://www.amphenol-aerospace.com/serviceinstructions.asp)

JT Example:	Socket 21-033121-564 on RG-196A/U cable will mate with pin 21-033122-563 on RG-188A/U cable which is used in both this and the LJTR series.
LJT, TV, SJT, Amphe-Lite Example:	Socket 21-033123-564 on RG-196A/U cable will mate with pin 21-033122-563 on RG-188A/U cable which is used in both this and the JT-R series.

Finish of mating contact parts: Contact part numbers shown in the chart above are supplied with 0.000050 min. gold (Knoop hardness 130-200) over nickel on mating parts. Other finishes are available; consult Amphenol.

Daniels crimping tools are available from:  
Daniels Mfg. Corp. 6103 Anno Ave., Orlando FL 32809

### LJT-R, MIL-DTL-38999 Series I; TV-R, MIL-DTL-38999 Series III; Amphe-Lite and SJT-R Series, SAE AS39029 (28, 59, 60, 75, 76, 77)

COAX CONTACTS FOR USE IN LJTR, TVR, AMPHE-LITE AND SJTR CONNECTORS							
Cable	Contact Part Number		Contact Size	Crimping Tools		Installation Tools	
	Pin	Socket		Inner Contact	Crimp Ferrule	Insertion	Removal
RG-178B/U, RG-196A/U	21-033122-564 (M39029/76-425) <i>(L-2035-AG)</i>	21-033123-564 (M39029/77-429) <i>(L-2035-AJ)</i>	16	M22520/2-01 with Positioner M22520/2-35 or with Daniels Positioner K532	M22520/4-01 with Positioner M22520/4-02	M81969/8-07 or M81969/14-03	M81969/8-08 or M81969/14-03
Haveg 30-00761, 30-02024, 30-02033 Tensolite 24713/A955KK1, 26723/A955KK1	21-033122-562† <i>(L-2035-AN)</i>	21-033123-562† <i>(L-2035-AR)†</i>				Amphenol 11-8674-16 11-8794-16 or MS27495A16	Amphenol 11-8675-16 11-8795-16 or MS27495R16
Haveg 61-02051	21-033122-561† <i>(L-2035-AK)†</i>	21-033123-561† <i>(L-2035-AM)†</i>				or MS27534-16	or MS27534-16
RG-174A/U, RG-188A/U, RG-316/U, RG-161/U RG-187A/U, RG-179B/U, Haveg 8100207, Times (HS-179) Raychem 7528H1424 AA3248, Teledyne 11299	21-033122-563 (M39029/76-424) <i>(L-2035-AD)</i>	21-033123-563 (M39029/77-428) <i>(L-2035-AF)</i>					
RG-180B/U, RG-195A/U, Raychem 9528A1318	21-033122-546 (M39029/28-211) <i>(L-2035-F)</i>	21-033123-546 (M39029/75-416) <i>(L-2035-H)</i>	12	M22520/2-01 with Positioner M22520/2-34 or with Daniels Positioner K323	M22520/31-01 with Positioner M22520/31-02 or Daniels GS-200 Tool with Positioner G2P330	M81969/8-09 or M81969/14-04	M81969/8-10 or M81969/14-04
Raychem 5022E5111	21-033122-543† <i>(L-2035-M)†</i>	21-033123-543† <i>(L-2035-P)†</i>				Amphenol 11-8674-12 11-8794-12 or MS27495A12	Amphenol 11-8675-12 11-8795-12 or MS27495R12
Raychem 9530A5314	21-033122-544† <i>(L-2035R)</i>	21-033123-544† <i>(L-2035-T)†</i>				or MS27534-12	or MS27534-12
Raychem 9527A1318	21-033122-545† <i>(L-2035-U)†</i>	21-033123-545† <i>(L-2035-W)</i>					
Raychem 9527A1314	21-033122-585 <i>(L-2035-GG)</i>	21-033123-585 <i>(L-2035-GH)</i>					
Gore GWN1159A, Nexans RG179-DT	21-033122-547 <i>(L-2035-X)†</i>	21-033123-547 <i>(L-2035-Z)†</i>					
M/A-Com 5M2869-001	21-033122-589 <i>(L-2035-GR)</i>	21-033123-589 <i>(L-2035-GT)</i>					
RG-187A/U, RG-179B/U, RG-174A/U, RG-188A/U, RG-316/U, RG-161/U Haveg 8100207, Times (HS-179)AA3248, Teledyne 11299	21-033102-023† <i>(L-1107-C)</i>	21-033101-023† <i>(L-1107-G)</i>	8	M22520/2-01 with Positioner M22520/2-31†† or solder	M22520/5-01 with die set M22520/5-03 (A) or M22520/5-08 (A) M22520/5-35 (B) or M22520/10-01 with Die Set M22520/10-05 (A) M22520/5-01 with die set M22520/5-05 (A) or M22520/5-19 (B) or M22520/10-01 with Die Set M22520/10-07 (A)	Hand inserted	11-9170 or MS
RG-142B/U, RG-223/U	21-033102-024* <i>(L-1107-D)</i>	21-033101-024* <i>(L-1107-H)</i>					

NOTE: SAE AS39029 supersedes MIL-C-39029  
 CRIMPING TOOLS: Italicized letters in parenthesis that follow positioner part numbers indicate applicable die closure. Commercial equivalents with the same die closure dimension may be used.  
 CHART CONTINUES ON NEXT PAGE

† Consult Amphenol Aerospace for current release of this contact or instruction sheet if applicable.  
 †† When inner contact is installed by crimping only. 11-10134 Expander Tool Kit must be used to assemble rear insulator over contact.  
 \*\*Termination instructions are packaged with each contact and can be found on-line at: [www.amphenol-aerospace.com/serviceinstructions.asp](http://www.amphenol-aerospace.com/serviceinstructions.asp)

### LJT-R, MIL-DTL-38999 Series I; TV-R, MIL-DTL-38999 Series III; Amphe-Lite and SJT-R Series, SAE AS39029 (28, 59, 60, 75, 76, 77), cont.

COAX CONTACTS FOR USE IN LJTR, TVR, AMPHE-LITE AND SJTR CONNECTORS, CONT.							
Cable	Contact Part Number (Termination Instruction Sheet)***		Contact Size	Crimping Tools		Installation Tools	
	Pin	Socket		Inner Contact	Crimp Ferrule	Insertion	Removal
Haveg 51-03111, Tensolite 28895/2X1	21-033102-022 (L-1107-B)	21-033101-022 (L-1107-F)	8	M22520/2-01 with Positioner M22520/2-31** or solder	M22520/5-01 with die set M22520/5-05 (B) or M22520/5-41 (B) or M22520/10-01 with Die Set M22520/10-07 (B)	Hand inserted	11-9170 or MS
RG-180B/U, RG-195A/U, Raychem 9528A1318	21-033102-021 (M39029/60-367 Supersedes MS27536) (L-1107-A)	21-033101-021 (M39029/59-366 Supersedes MS27535) (L-1107-E)					
RD-316 Double Shield (M17/152-00001)	21-033102-025 (L-1107-J)	21-033101-025 (L-1107-N)					
Raychem 7524D5111-9 (triax cable - contact will terminate inner coax portion only)	21-033102-026 (L-1107-M)	21-033101-026 (L-1107-M)					
RG-400, ECS3C058A ECS352001 ECS432101	21-033102-027 (L-1286-B)	21-033101-027 (L-1293-B)					
RG-58 (M17/155-00001), M17/028-RG-058 RG303 Times LMR-195-UF	21-033102-029 (L-1107-AA)	21-033101-029 (L-1107-Y)†					
5021D1331-0	21-033102-036 (L-1107-P)	21-033101-036† (L-1107-Q)					
5M2869-001 ESC432101 BMS13-65	21-033102-037 (L-1107-V)	21-033101-037 (L-1107-W)					
5022A1311-0	21-033102-039 (L-1107-AC)	21-033101-036† (L-1107-AB)					
FA-19X	21-033652-001 (L-2091-A)	21-033653-001 (L-2091-B)					
T Flex-402 Utiflex UFB142G	21-033102-041 (L-1107-AG)	21-033101-041 (L-1107-AF)		Solder	M22520/5-01 with Die Set M22520/5-05 (B)		

NOTE: SAE AS39029 supersedes MIL-C-39029  
 NOTE: Contacts can be ordered by part numbers given in chart  
 CRIMPING TOOLS: Italicized letters in parenthesis that follow positioner part numbers indicate applicable die closure. Commercial equivalents with the same die closure dimension may be used.

† Consult Amphenol Aerospace for current release of this contact or instruction sheet if applicable  
 \*\*When inner contact is installed by crimping only. 11-10134 Expander Tool Kit must be used to assemble rear insulator over contact.  
 \*\*\*Termination instructions are packaged with each contact and can be found on-line at: [www.amphenol-aerospace.com/serviceinstructions.asp](http://www.amphenol-aerospace.com/serviceinstructions.asp)

## Amphenol® Matched Impedance Size 12 Coaxial Contacts for RF/Microwave, High Frequency and High Performance Requirements

The matched impedance coax contact is available in size 12. It incorporates a captivated inner contact which “snaps into” the outer contact preventing displacement or pull back of the inner contact in situations where the cable may be bent.

**TYPICAL MATCHED IMPEDANCE COAX SOCKET CONTACT**  
has socket outer contact with a captivated pin inner contact

**TYPICAL MATCHED IMPEDANCE COAX PIN CONTACT**  
has pin outer contact with a captivated socket inner contact

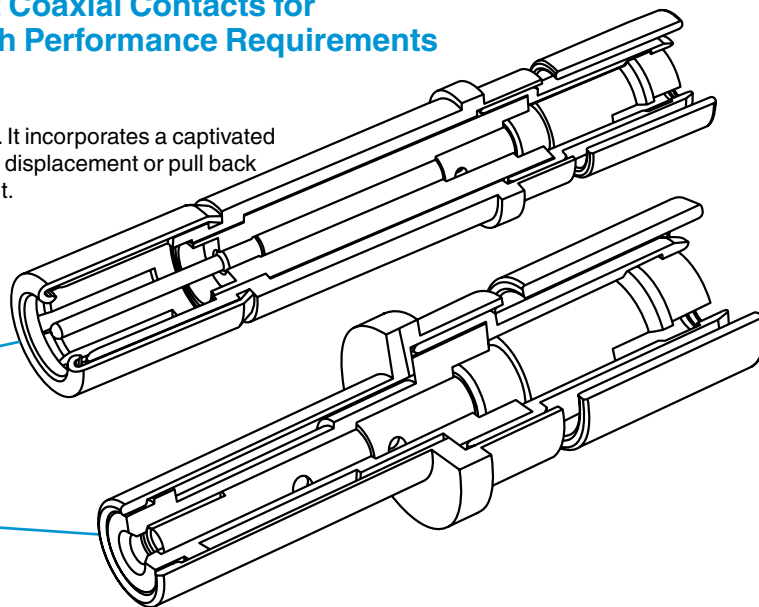

Design features and benefits of the Matched Impedance:

- For use in 90 degree angle or bent cable applications
- Provides 50 ohm matched impedance resulting in low VSWR and low insertion loss
- Frequency range for a mated pair extends to 3 GHz and beyond, higher than other coaxial contacts previously offered.
- Ideally suited for D38999 high performance and MIL-STD-1760 high band coaxial contact requirements

### High Performance Size 12 Coax 50 Ohm matched

**LJT-R, MIL-DTL-38999 Series I, JT-R, MIL-DTL-38999 Series II, and TV-R, MIL-DTL-38999 Series III**

Use with Cable	Comment	Pin (Termination Instruction Sheet)**	Socket (Termination Instruction Sheet)**
RG316, T-Flex-405 Semflex SM405	M39029/102/103	21-033651-011 (L-2092-C)	21-033650-011 (L-2092-C)
RG-316, T-Flex-405	JT-R, MIL-DTL-38999 Series II		21-033729-011 (L-2092-P)
RD316, Filotex, ET124962, M17/152-00001	M39029/102/103 Type	21-033651-017 (L-2092-F)	21-033650-017 (L-2092-F)
JN1088WT	JN1104*50C	21-033213-042	21-033214-042 (L-2092-D)
PAN6422XQ	PAN6841*50C	21-033651-012 (L-2092-E)	21-033650-012
RG178, Gore CXN 3403	M39029/102/103 Type	21-033651-018 (L-2092-K)	21-033650-018 (L-2092-K)
RG178, Gore CXN 3403	JT-R, MIL-DTL-38999 Series II		21-033729-018 (L-2092-K)
SFT-316-TR	M39029/102/103 Type	21-033651-022 (L-2092-N)	21-033650-022 (L-2092-N)
Semflex SW060	M39029/102/103 Type	21-033651-025	21-033650-025
Semflex SW086 (solid inner conductor)	M39029/102/103 Type	21-033651-026	21-033650-026

\* Add P or S for pin or socket

\*\*Termination instructions are packaged with each contact and can be found on-line at:  
[www.amphenol-aerospace.com/serviceinstructions.asp](http://www.amphenol-aerospace.com/serviceinstructions.asp)

### Matched Impedance Coax Contact Performance:

Electrical Specifications:

- Contact impedance = 50 ohms nominal
- Frequency range = 0–3 GHz Operable at higher frequencies depending on cable selection. Consult Amphenol for details.
- Dielectric withstanding voltage (for a mated pair):  
At sea level = 1000 VRMS  
At 50, 000 ft. = 250 VRMS
- Insulation resistance: 5 gigaohms min. @ 25°C
- VSWR: 1.20 + .04F (F in GHz) max. up to 3 GHz
- Insertion Loss:  $.11\sqrt{f\text{GHz}}$  dB max.

Environmental Specifications:

- Thermal limits: –55 ° to 200°C

Mechanical Specifications:

- Mating: slide-on
- Mounting: conforms to M39029/102 & /103 envelope dimensions

# Typical Contact Installation Instructions for Coax Contacts

The following is an example of a contact instruction sheet that would be shipped within the package of contacts for a Crimp, Size 12 Coax Contact for use in Subminiature, D38999 connectors. The sheet provides detailed instructions for assembling the component parts and for crimping the contact to coaxial cable, along with the recommended cable and tooling to be used. Installation instructions are included within all contacts for D38999 connectors. For installation instructions for other connector series, there are separate documents (not included in packaging of parts) as follows: L- 633 for Miniature solder types, L-613 for Miniature SE types, L-660 for Miniature CE types, and L-650 for MS/Standard and Heavy Duty types. For any other instructions needed, consult Amphenol. Most installation instructions can be found on-line at [www.amphenol-aerospace.com](http://www.amphenol-aerospace.com) (from home page, go to Service Instructions and enter contact part number or instruction sheet number).

## 21-033651-011 (PIN) 21-033650-011 (SOCKET)

Contact, Pin and Socket, Coaxial,  
Type LJT-R & TV-R, (MIL-DTL-38999 Series I & III) Crimp, Size 12  
Installation Instructions

See table on reverse side for coaxial cable recommended and crimp tool information.

- A.
  1. Slide outer crimp ferrule over cable outer jacket as shown.
  2. Strip cable outer braid as illustrated. Ends must be cut cleanly and at right angles to the axial plane of the cable. The cable must not be deformed while making cuts.
  3. Flare outer braid, then strip cable dielectric as shown.
- B.
  1. Assemble inner contact assembly over cable center conductor and cable dielectric until inside bore of bushing butts against cable dielectric.
  2. Cable center conductor must be visible through the inspection hole in the inner contact wire well.
  3. Crimp inner contact wire well using crimp tool listed in table.
- C.
  1. Carefully slide outer contact assembly over inner contact assembly and under cable outer braid until inner contact butts against insulator shoulder as illustrated. (Inner contact assembly will snap into the locked position when fully assembled inside the outer contact assembly.)
  2. Bring outer crimp ferrule forward over cable outer braid as illustrated. (Continue to push the inner contact assembly fully forward while bringing the outer crimp ferrule into position.)
  3. Crimp outer crimp ferrule using crimp tool listed in table (.156 Max. over ferrule after crimping). Trim excess braid ahead of crimp ferrule, if necessary.

## 21-033651-011 (PIN) 21-033650-011 (SOCKET)

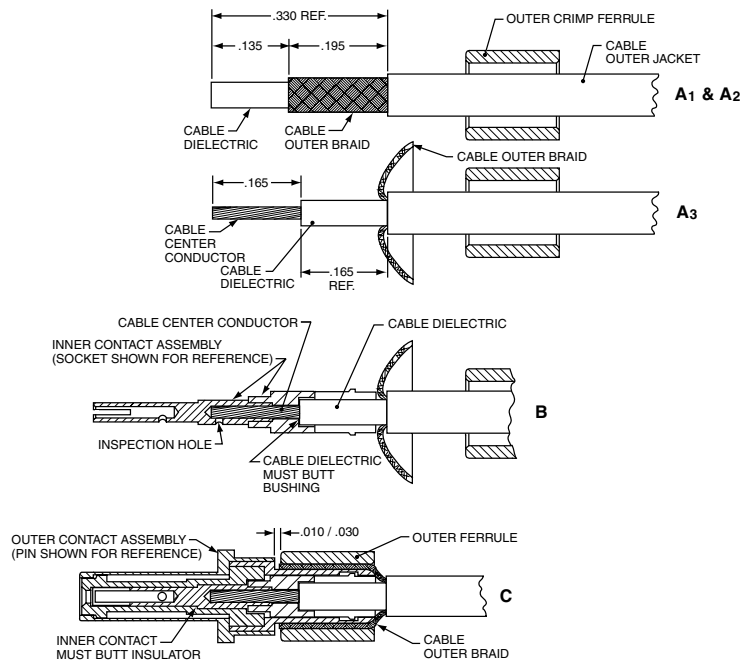

### CONTACT INSERTION INTO CONNECTOR

Using insertion tool (part number M81969/8-09 or M81969/14-04), insert contact assembly into rear connector grommet hole. Contact must be aligned with hole and not inserted at an angle. Push forward until contact is felt to snap into position within insert. Remove tool.

### CONTACT REMOVAL FROM CONNECTOR

Position removal tool (part number M81969/8-10 or M81969/14-04) around cable and slide tool down wire until tool tips enter rear grommet and come to a positive stop. Hold tool tip firmly against positive stop on contact, grip wire and simultaneously remove tool, contact and cable.

L-2092-C  
October 2001

FSCM77820

Amphenol® Part Number	Description	Coaxial Cable Accommodated	Tools				
			Inner Contact			Outer Contact	
			Crimp Tool	Setting	Positioner (Daniels)	Tool	Positioner
21-033651-011	Matched Impedance* Size 12 Coax Pin	RG316 (M17/113-RG316)	MH992 (Daniels)	5	K1360	M22520/5-01	M22520/5-03 (A) or M22520/5-35 (B)
		RG179 (M17/094-RG179)	MH992 (Daniels)	4	K1360		
21-033650-011	Matched Impedance* Size 12 Coax Socket	RG316 (M17/113-RG316)	MH992 (Daniels)	5	K1360		
		RG179 (M17/094-RG179)	MH992 (Daniels)	4	K1360		

\* Matched Impedance applies when contacts are terminated to RG316 cable only.

## Amphenol® High Frequency Contacts

Amphenol and SV Microwave (an Amphenol company) offer DC to 40 GHz high frequency size 8, 12 and 16 coaxial contacts for the D38999 Series III housing and standard inserts. These contacts allow any application to continue to use the D38999 connector and be able to expand the use to include the microwave transmission lines. Features include:

- Superior electrical performance and high frequency capability
- Blindmate advantage and maintenance of an accurate phase length when mated
- Can be terminated to a multiple of cable types depending on the application
- Uses standard interfaces based on MIL-STD-348, and can be installed in any MIL-DTL-38999 size 8, 12 or 16 insert
- Unique “Float Mount” technology allows for consistent microwave performance while maintaining tight mechanical tolerances



Subminiature MIL-DTL-38999 Series III Connector with Size 8 High Frequency Contacts

## HIGH FREQUENCY CONTACTS

### SPECIFICATIONS

#### Electrical

**(Mated pair size 8 - RG 405 Semi-Rigid Cable)**

Impedance	50 Ω
Frequency Range	DC - 40 GHz
VSWR	1.05 +.01 (freq. GHz)
Insertion Loss	0.03.√(freq. GHz)
Insulation Resistance (Min.)	10,000 M Ω
Contact Resistance (Max.)	
Center conductor:	6.0 mΩ
outer conductor:	3.0 mΩ
outer to cable:	0.5 mΩ
Dielectric Withstanding Voltage	1,000 VRMS
Corona Extinction Voltage	250 VRMS
RF High Potential Voltage	500 VRMS
RF Leakage	-(80-freq. GHz)

#### Materials and Finish

Body and Sleeve	Stainless steel per AMS-5640 Alloy UNS S30300 Type 1
Ferrule	Brass per ASTM B16, Alloy UNS C36000
Contact & Lock Ring	Beryllium copper per ASTM B196 Alloy UNS C17300, Td04
Insulator	PTFE per ASTM D1710, Type 1, Grade 1, Class B
Spring	Stainless steel per ASTM A313 Type 631
Rear Body & Contacts	Gold per ASTM B488 Type II, Code C, Class 1.27; over Nickel per AMS-QQ-N-290 Class 1 (60μ inches); over Copper per MIL-C-14550 (10μ inches) Passivated per AMS-2700, Type 2

#### Environmental

Temperature Range	-65°C to +125°C
Corrosion (Salt Spray)	MIL-STD-202, Method 101, Condition B
Vibration	MIL-STD-202, Method 204, Condition D, 20 Gs
Shock	MIL-STD-202, Method 213, Condition 1, 100 Gxs
Thermal Shock	MIL-STD-202, Method 107, Condition B, -65°C to +125°C
Moisture Resistance	MIL-STD-202, Method 106, Less step 7B
Barometric Pressure (Altitude)	MIL-STD-202, Method 105, Condition C, 70,000 ft.

### HIGH FREQUENCY COAX CONTACTS FOR USE IN D38999, SERIES III CONNECTORS

High Frequency Amphenol Part Number (Termination Instruction Sheet)	Interface	Frequency	For use with Cable	Type	Cavity Size	Piggyback Grommet
21-033449-001HF (300-17-008)	BMZ	40 GHz	TFLEX-405	Socket	8	21-033321-007
21-033448-001HF (300-17-008)				Pin		
21-033449-002HF (300-89-009)	BMZ	18 GHz	TFLEX-405	Socket	8	21-033321-007
21-033448-002HF (300-89-009)				Pin		
21-033449-003HF (300-89-008)	BMZ	12 GHz	RG-400/ RG-142	Socket	8	21-033321-009
21-033448-003HF (300-89-008)				Pin		
21-033449-004HF (300-89-002)	BMZ	18 GHz	TFLEX-402	Socket	8	21-033321-010
21-033448-004HF (300-89-002)				Pin		
21-033449-006HF	BMA	26.5 GHz	TFLEX-405	Socket	8	21-033321-007
21-033448-006HF				Pin		
21-033449-007HF	BMA	26.5 GHz	TFLEX-402	Socket	8	21-033321-010
21-033448-007HF				Pin		
21-033449-008HF	BMZ-75 Ohm	2 GHz	LMR-240-75	Socket	8	21-033321-008
21-033448-008HF				Pin		
21-033449-009HF	SMPM	65 GHz	TFLEX-405	Socket	12	N/A
21-033448-009HF				Pin		
21-033449-010HF	SMPS	65 GHz	0.047 Dia. Cable	Socket	16	N/A
21-033448-010HF				Pin		



# Twinax Contacts for MIL-DTL-38999

## General Description, Application Data - Size 10 & 12

**Amphenol® Twinax Contacts** - Were designed for use with twinax cable in Data Bus systems. Twinax contacts provide the following benefits:

- Protection from magnetic interference
- Protection from electrostatic interference including nuclear electromagnetic pulse
- Meets parameters defined by MIL-STD-1553B
- Maintains shield integrity through a multi-pin circular connector and does not require contact polarization within the insert

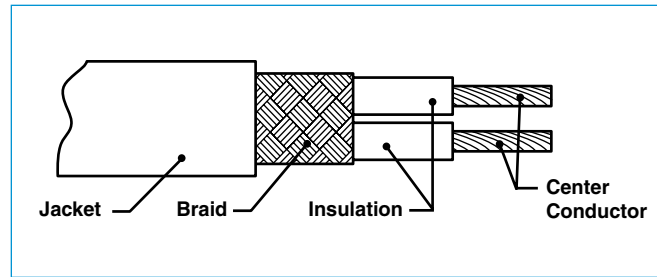

Cable Illustration - Twinax Contact

### SIZE 10 & 12 CONCENTRIC TWINAX CONTACTS

The size 12 concentric twinax contact interface was developed for JN1104 EuroFighter contacts, and can be used in any size 12 cavity M38999 I, II or III or SJT connector.

Features:

- Operating temperature –55°C to 175°C
- Pins are scoop-proof
- Meets performance levels of M38999 connector
- 4 components, gold plated crimp termination
- For use with a variety of cables (See chart below)



Concentric Twinax Contacts Size 12

### TYPICAL ELECTRICAL PERFORMANCE

#### Size 10 & 12 Concentric Twinax Contacts

Voltage Rating: 500 Vrms max. @ sea level

Contact Resistance:

Center @ 1 Amp, 55 millivolts max. voltage drop @ 25°C

Intermediate @ 1 Amp, 55 millivolts max. voltage drop @ 25°C

Outer @ 12 Amps, 85 millivolts max. voltage drop @ 25°C

Operating Frequency: 0–30 MHz

Dielectric Withstanding Voltage:

Center to Intermediate 800 VAC Rms @ Sea Level

Intermediate to Outer 500 VAC Rms @ Sea Level

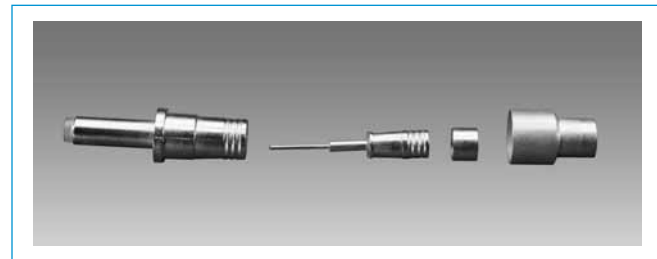

Unassembled Components of Size 12 Concentric Twinax Contact

SIZE 10 & 12 CONCENTRIC TWINAX CONTACTS FOR USE IN D38999 CONNECTORS					
For use with Cable	Concentric Twinaxial Contact Part Number (Termination Instruction Sheet)**		Contact Size	Comments	Connector Series
	Pin	Socket			
M17/176-00002, ST5M1212-002, TWC-78-1	21-033909-025 (L-2092-G)	21-033908-025 (L-2092-G)	12	JN1104 Interface	D38999 Series I, III
0024A0024, Fileca F2709-13-CA	21-033909-028 (L-2092-G)	21-033908-028 (L-2092-G)			
EPD32263A, 10612, GSC-12-2548-00	21-033909-029 (L-2092-H)	21-033908-029 (L-2092-H)			
ASNE0849, 5PTM1T04-1	21-033909-081 (L-2092-AB)	21-033908-081 (L-2092-AB)			
VG95218T023D002	21-033909-091 (L-2092-AC)	21-033908-091 (L-2092-AC)			
VG95218T023D002	21-033909-101 (L-2092-AC)	21-033908-101 (L-2092-AC)	12	Same as -91 except new ferrule with wire support	D38999 Series II
M17/176-00002, GSC-12-2549-00		21-033640-025 (L-2092-W)		JN1104 Interface	
0024A0024		21-033640-028 (L-2092-V)			
5M2022-003	21-033844-001 (L-1255-A)	21-033843-001 (L-1255-B)	10	Supplied with Thermal fit sleeve	D38999 Series I, III

\*\*Termination instructions are packaged with each contact and can be found on-line at: [www.amphenol-aerospace.com/serviceinstructions.asp](http://www.amphenol-aerospace.com/serviceinstructions.asp)

High performance connectors within the D38999 families are the most commonly used connectors for incorporation of Twinax contacts. These connectors offer wide versatility in insert arrangements for not only concentric Twinax contacts, but also coax, triax, PCB, wire wrap, thermocouples and EMI filter contacts.

Other connectors available with concentric Twinax contacts:

- Wire Integrated Connectors (WICS) for Data Bus Systems. Consult Amphenol Aerospace, Sidney, NY.
- ARINC 404, ARINC 600 and R27 Series rectangular connectors. Supplied by Amphenol Canada.

### SIZE 8 CONCENTRIC TWINAX CONTACTS

The size 8 concentric Twinax contact was developed for use in MIL-STD-1553 Airborne multiplex data bus applications which require high performance interconnect characteristics in multi-pin connectors. Ideal for this application need is the high performance Tri-Start connector with its fully scoop-proof feature of recessed pins. The concentric Twinax contact is crimp terminable to twisted shielded cable. Features include:

- Provides protection from magnetic and electrostatic interference including nuclear electromagnetic pulse
- Maintains shield integrity through a multi-pin circular connector and does not require contact polarization within the insert
- 175°C rated and meets performance levels of MIL-DTL-38999 Series III connectors
- MIL-C-17/176-00002 cable termination
- Gold plated full crimp termination contacts qualified to M39029/90 & /91
- Integral part of the MIL-STD-1760 interconnection system
- Also available in modified but intermateable versions for termination to a host of cables (See chart on next page)

### TYPICAL ELECTRICAL PERFORMANCE

#### Size 8 Concentric Twinax Contacts

Voltage Rating: 500 Vrms max. @ sea level

Contact Resistance:

Center @ 1 Amp, 55 millivolts max. voltage drop @ 25°C

Intermediate @ 1 Amp, 55 millivolts max. voltage drop @ 25°C

Outer @ 12 Amps, 75 millivolts max. voltage drop @ 25°C

Operating Frequency: 0–20 MHz

Dielectric Withstanding Voltage:

Center to Intermediate: 1000 VAC Rms @ Sea Level

Intermediate to Outer: 500 VAC Rms @ Sea Level

### SHORT PROFILE TWINAX CONTACT OPTION

A Short Profile size 8 Twinax is available that can be used with a low profile right angle backshell and can offer increased packaging efficiency. Consult Amphenol Aerospace for further information.



MIL-DTL-38999 Series III Connector with Twinax Contacts and Standard Contacts



Concentric Twinax Contacts Size 8

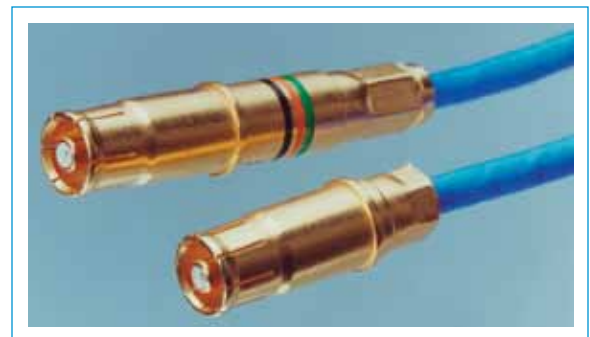

Short Profile Twinax vs Standard Length Twinax Contact

# Twinax Contacts for MIL-DTL-38999

## General Description, Application Data - Size 8, cont.

SIZE 8 CONCENTRIC TWINAX CONTACTS FOR USE IN D38999 CONNECTORS				
For use with Cable	Size 8 Concentric Twinaxial Contact Part Number (Termination Instruction Sheet)**		Comments	Connector Series
	Pin	Socket		
M17/176-00002	21-033190-625 (L-1253-AG)	21-033191-628 (L-1253-AG)	AS39029/113-625 & /114-628 (Amphenol) Supplied with heat shrink seal	D38999 Series I, III
M17/176-00002, 5PTM1T04-2	21-033190-529 (L-1253-A)	21-033191-530 (L-1253-B)	AS39029/90/91 (Amphenol) Supplied with heat shrink seal	
M17/176-00002	T3-46T08-LD (PN-430)	T3-47T08-LD (PN-430)	M39029/90/91 (Pyle) Supplied with heat shrink seal	
M17/176-00002	21-033190-000 (L-1253-A)	21-033191-000 (L-1253-B)	Without seals	
M17/176-00002	21-033190-001 (L-1253-A)	21-033191-001 (L-1253-B)	Supplied with piggyback grommet seal	
Raychem 10612, 5M2022-003	21-033190-026 (L-1253-AA)	21-033191-026†	Without seals	
Raychem 10614, EPD22189B, 7724C8664, 05A0771, GC875TM24H, T10971	21-033190-022 (L-1253-C)	21-033191-022 (L-1253-D)	Without seals	
Raychem 10613, PAN711-6421, 23089/RC	21-033190-027 (L-1253-K)	21-033191-027 (L-1253-L)	Supplied with heat shrink seal	
Raychem 10613, PAN711-6421, 23089/RC	21-033190-029 (L-1253-K)	21-033191-029 (L-1253-L)	Supplied with piggyback grommet seal	
Raychem 10613, PAN711-6421, 23089/RC	21-033190-030 (L-1253-K)	21-033191-030 (L-1253-L)	Without seals	
GSC-12-2548-00, 7726D0664, ASNE 08072003-09	21-033190-040 (L-1253-S)	21-033191-040 (L-1253-T)	Supplied with heat shrink sleeve	
Axon P517417	21-033190-081 (L-1253-W)†	21-033191-081 (L-1253-Y)†	Supplied with piggyback grommet seal	
Raychem 10612, 5M2022-003	21-033190-261 (L-1253-AA)	21-033191-261†	Supplied with piggyback grommet seal	
Raychem 10612, 5M2022-003	21-033190-262 (L-1253-AA)	21-033190-262†	Supplied with heat shrink seal	
Raychem 10614, 7724C8664	T3-46TB08-LD (PN-494)	T3-47TB08-LD (PN-494)	Without seals	
7820D0111 (20 AWG)	T3-467C08-LD (PN-537)	T3-47TC08-LD (PN-537)	Without seals	
Gore CXN2268	T3-46TE08-LD (PN-1001)	T3-47TE08-LD (PN-1001)	Short profile Supplied with heat shrink seal (.465)	
M17/176-00002	T3-46TD08-LD (PN-1000)	T3-47TD08-LD (PN-1000)	Short profile Supplied with heat shrink seal (.465)	
M17/176-00002	21-033910-015† (PN-1005)	21-033922-015 (PN-1005)	Short profile Without seals (.263)	
M17/176-00002	21-033617-001 (REF PN-100)		Short profile Supplied with piggyback grommet seal (.465)	
Gore CNX2702	T3-46TF08-LD (PN-1002)	T3-47TF08-LD (PN-1002)	Short profile Supplied with heat shrink seal (.465)	
M17/176-00002		P-209546-27†	Short profile Without seals (.303)	
S280W502-1, Fileca F2709-13-CA, HS5930, Raychem 10602 0024G0024, 0024A0024	21-033190-070 (L-1253-U)	21-033191-070 (L-1253-V)	Without seals	
S280W502-1, Fileca F2709-13-CA, HS5930, Raychem 10602 0024G0024, 0024A0024 Tensolite 24463/9P025x-2(LD)	21-033190-071 (L-1253-U)	21-033191-071 (L-1253-V)	Supplied with piggyback grommet seal	
S280W502-1, Fileca F2709-13-CA, HS5930, Raychem 10602 0024G0024, 0024A0024	21-033190-072 (L-1253-U)	21-033191-072 (L-1253-V)	Supplied with heat shrink seal	
0024A0311, PIC E10244	21-033190-090†	21-033191-090 (L-1253-AD)	Without seals	
0024A0311, PIC E1024	21-033190-091†	21-033191-091 (L-1253-AD)	Supplied with piggyback grommet seal	
0024A0311, PIC E1024	21-033190-092†	21-033191-092 (L-1253-AD)	Supplied with heat shrink seal	
M17/176-00002	21-033190-625 (L-1253-AG)	21-033191-628 (L-1253-AG)	M39029/113-625 & /114-628 Supplied with heat shrink seal	

\*\*Termination instructions are packaged with each contact and can be found on-line at: [www.amphenol-aerospace.com/serviceinstructions.asp](http://www.amphenol-aerospace.com/serviceinstructions.asp)

† Consult Amphenol Aerospace for current release of this contact or instruction sheet if applicable.

**Amphenol® Triax Contacts** -Provide additional shielding when terminated to triax cable having solid or stranded center conductors. Amphenol supplies triax contacts in sizes 8, 10 and 12 and they are ideally suited for use in D38999 Series I, II and III circular connectors.

Features and benefits of Amphenol triax contacts include:

- Incorporates three conductors, designed for use with triax cable
- Each of the three conductors are separated by dielectric insulation to isolate ground planes
- Shielding effectiveness is improved with two isolated shields
- May be specified for direct connection to printed circuit boards
- May be mixed with coax, twinax and power contacts in a single connector

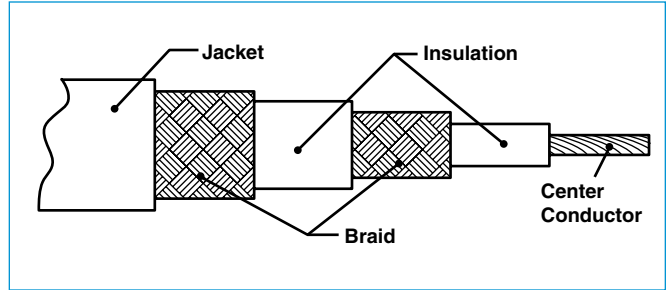

Cable Illustration - Triax Contact



Triax Size 8 Pin Contact



Triax Size 12 Socket Contact

### TYPICAL ELECTRICAL PERFORMANCE

#### Size 8, 10 and 12 Triax Contacts

Center @ 1 Amp, 120 millivolts max. voltage drop @ 25°C  
 Intermediate @ 1 Amp, 60 millivolts max. voltage drop @ 25°C  
 Outer @ 12 Amps, 90 millivolts max. voltage drop @ 25°C

Operating Frequency:

Size 12: 0-30 MHz  
 Size 10: 0-300 MHz  
 Size 8: 0-500 MHz

Dielectric Withstanding Voltage:

Center to Intermediate 800 VAC Rms @ Sea Level  
 Intermediate to Outer 500 VAC Rms @ Sea Level

Insulation Resistance:

1000 megohms minimum @ 25°C

### SIZE 8, 10 & 12 TRIAX CONTACTS FOR USE IN D38999 SERIES I & III CONNECTORS

For use with Cable	Size	Size 8, 10, 12 Triax Contact Part Number (Termination Instruction Sheet)**		Comments
		Pin	Socket	
5M2397-002, 81264-02, RGX-179, RT-179, Champlain 81-00321A, Tensolite 28883/02060X-1(LD), 7528A5314, Thermatics 12447, 28883/02060X-1, RTG 179, Semflex RT316	8	21-033198-003 (L-1254-F)	21-033197-003 (L-1254-E)	
752866314, 7528G6314	8	21-033198-011 (L-1254-V)	21-033197-011 (L-1254-T)	
5M2559-001, 81264-01, Tensolite 28598/9J063T-1, Teledyne 13809, Cheminax 9530F5214	8	21-033198-004 (L-1254-D)	21-033197-004 (L-1254-C)	
ST5M1323-001, Champlain 81-00700, Teledyne 11914/1, Times AA6603, Tensolite 26895/90334X-1	8	21-033198-010 (L-1254-S)	21-033197-010 (L-1254-S)	
5M2397-002	10	21-033800-001 (L-1256-A)	21-033801-001 (L-1256-B)	
JN1088WU (75Ω), JN1088WT (50Ω)	12	21-033909-012 (L-1256-J)	21-033908-012 (L-1256-J)	JN1104 Interface
GSC-03-81497-00 (75Ω)	12	21-033909-023 (L-1256-M)	21-033908-023 (L-1256-M)	Replaced by -33 with improved rear insulator
GSC-03-81497-00 (75Ω)	12	21-033909-033 (L-1256-P)	21-033908-033 (L-1256-P)	JN1104 Interface
Harbour TRX179, Times Microwave AA-6151 (RT-179), Axon RGX-179, 540-1050-000 (75Ω)	12	21-033909-071 (L-1256-AA)	21-033908-071 (L-1256-AA)	
10602 (Twinax)	8	21-033724-015 (L-1255-C)	(Consult with Amphenol for availability)	Special design with triax mating end and twinax cable termination

\*\*Termination instructions are packaged with each contact and can be found on-line at:  
[www.amphenol-aerospace.com/serviceinstructions.asp](http://www.amphenol-aerospace.com/serviceinstructions.asp)

### Amphenol® Printed Circuit Tail Contacts

are currently supplied as follows:

- 8, 12 and 16 Coax
- 8, 10 and 12 Twinax
- 8 Triax (socket only)

PC Tail shielded contacts provide a cost effective packaging solution for limited space applications where connectors are attached to printed circuit boards. High reliability is assured with factory pre-assembled contacts and standardization termination to the board. PC Tail contacts are available for MIL-DTL-38999 Series I and III circular connectors and also for ARINC 404, ARINC 600 and R27 rectangular connectors. The following pages (410 & 411) show the available PC Tail contact part numbers for 38999 Circular connectors. See page 420 Rectangular Section of this catalog for information on twinax contacts for ARINC Rectangular connectors along with compatible cable terminations. Consult Amphenol Aerospace for further information on the applicable tooling for these contacts.

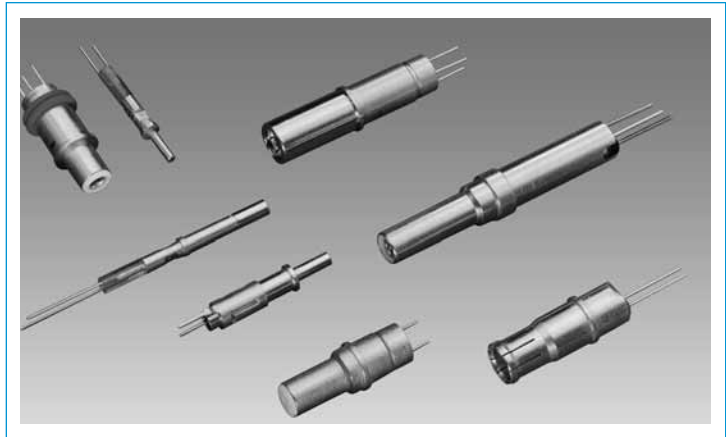

PC Tail Coax and Twinax Contacts for Attachment to Printed Circuit Boards

### TYPICAL ELECTRICAL PERFORMANCE

#### Size 8, 12 & 16 PC Tail Coax Contacts

Contact Resistance:

Center @ 1 Amp, 55 millivolts max. voltage drop @ 25°C

Outer @ 1 Amp, 55 millivolts max. voltage drop @ 25°C

Operating Frequency: 0–500 MHz

Dielectric Withstanding Voltage:

Center to Outer 500 VAC Rms @ Sea Level

Insulation Resistance

1,000 megohms minimum @ 25°C

### TYPICAL ELECTRICAL PERFORMANCE

#### Size 8, 10 & 12 PC Tail Twinax Contacts

Contact Resistance:

Center @ 1 Amp, 55 millivolts max. voltage drop @ 25°C

Intermediate @ 1 Amp, 55 millivolts max. voltage drop @ 25°C

Outer @ 1 Amp, 55 millivolts max. voltage drop @ 25°C

Operating Frequency: 0–20 MHz

Dielectric Withstanding Voltage:

Center to Intermediate 500 VAC Rms @ Sea Level

Intermediate to Outer 500 VAC Rms @ Sea Level

Insulation Resistance

1,000 megohms minimum @ 25°C

### TYPICAL ELECTRICAL PERFORMANCE

#### Size 8 PC Tail Triax Contacts

Contact Resistance:

Center @ 1 Amp, 55 millivolts max. voltage drop @ 25°C

Intermediate @ 1 Amp, 55 millivolts max. voltage drop @ 25°C

Outer @ 1 Amp, 55 millivolts max. voltage drop @ 25°C

Operating Frequency: 0–500 MHz

Dielectric Withstanding Voltage:

Center to Intermediate 500 VAC Rms @ Sea Level

Intermediate to Outer 500 VAC Rms @ Sea Level

Insulation Resistance

1,000 megohms minimum @ 25°C

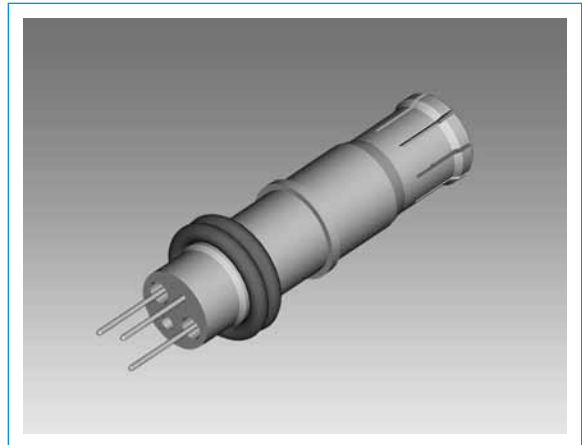

Size 8, PC Tail Twinax Socket Contact for use in D38999 Connectors



D38999 Connector with PC Tail Coax Contacts, Sealing Plugs in unused contact cavities and PC Tail Alignment Disc

PCTAIL COAX, TWINAX, AND TRIAX CONTACTS FOR USE IN D38999 SERIES I & III CONNECTORS						
Size	PC Tail Coax Contact Part Number	PC Tail Twinax Contact Part Number	PC Tail Triax Contact Part Number	Tails*	Comments	
8 Pin	21-033733-007			PCB 2 tails		
8 Pin	21-033733-002			PCB 2 tails	For epoxy filled connector	
8 Pin	21-033733-004			PCB 2 tails	For epoxy filled connector	
8 Pin	21-033733-005			PCB 4 outer tails, 1 inner		
8 Pin	21-033733-009			PCB 2 tails		
8 Pin	21-033733-008			PCB 2 tails		
8 Socket	21-033426-001			PCB 2 tails		
8 Pin		21-033967-115		PCB 3 tails	M39029/90/91 Interface	
8 Pin		21-033967-125		PCB 3 tails		
8 Pin		21-033967-015		PCB 3 tails		
8 Pin		21-033967-045		PCB 3 tails		
8 Pin		21-033967-055		PCB 3 tails		
8 Pin		21-033967-065		PCB 3 tails		
8 Pin		21-033967-085		PCB 3 tails		
8 Pin		21-033967-095		PCB 3 tails		
8 Pin		P-209550†		PCB 3 tails		
8 Pin		P-209532-1		PCB 9 tails		
8 Pin		P-209532-2		PCB 9 tails		
8 Socket		21-033921-015		PCB 3 tails		
8 Socket		21-033921-045		PCB 3 tails		
8 Socket		21-033921-035		PCB 3 tails		
8 Socket		21-033921-065		PCB 3 tails		
8 Socket		21-033921-075		PCB 3 tails		
8 Socket		21-033921-115†		PCB 3 tails		
8 Socket		21-033479-001		PCB 3 tails		AS39029/114 Type (with hood)
8 Socket		21-033479-021		PCB 3 tails		AS39029/114 Type (with hood)
8 Socket		21-033921-105†		PCB 3 tails		M39029/90/91 Interface .040 dia. tails
8 Socket		DB-109002		PCB 2 tails	M39029/91 Interface Outer body grounded to shell	
8 Socket		21-033919-015		PCB 2 tails		
8 Socket		21-033919-025		PCB 2 tails		
8 Pin			21-033828-001	PCB 3 tails		
8 Pin			21-033828-021	PCB 3 tails		
8 Pin			21-033828-041	PCB 3 tails		
8 Socket			21-033840-001	PCB 3 tails		
8 Socket			21-033840-021	PCB 2 tails	Outer body grounded to shell	
8 Socket			21-033841-001	PCB 2 tails	Outer body grounded to shell	
10 Pin		21-033844-002†		PCB 2 tails	Outer body grounded to shell	
12 Socket						

\* Consult Amphenol Aerospace for tail configurations and tail diameters.

† Consult Amphenol Aerospace for current release of this contact.

# Coax, Twinax & Triax PC Tail Contacts

## Application Data, cont.

PC TAIL COAX, TWINAX, AND TRIAX CONTACTS FOR USE IN D38999 SERIES I & III CONNECTORS					
Size	PC Tail Coax Contact Part Number	PC Tail Twinax Contact Part Number	PC Tail Triax Contact Part Number	Tails*	Comments
12 Pin	21-033686-008			PCB 2 tails	
12 Pin	21-033686-009			PCB 2 tails	Outer tail clip type
12 Pin	21-033686-005			PCB 2 tails	
12 Pin	21-033686-010			PCB 2 tails	
12 Pin	21-033686-013			PCB 2 tails	Outer tail clip type
12 Pin	21-033687-006			PCB 2 tails	For epoxy filled connector
12 Pin	21-033687-007			PCB 2 tails	
12 Pin	21-033686-016†			PCB 2 tails	
12 Socket	21-033614-001			PCB 2 tails	
12 Socket	21-033614-021			PCB 2 tails	
12 Socket	21-033614-041			PCB 2 tails	
12 Socket	21-033611-003			PCB 2 tails	Outer tail clip type
12 Socket	21-033440-001			PCB 3 tails	
12 Socket	21-033430-001			PCB 2 tails	Outer tail clip type, M38999 Series II
12 Socket	21-033430-021			PCB 2 tails	M38999 Series II
12 Socket	21-033430-041				M38999 Series II
12 Pin		21-033633-001†**		PCB 4 tails	JN1104 Interface
12 Pin		21-033633-002**		PCB 4 tails	
12 Pin		21-033633-006**		PCB 4 tails	
12 Pin		21-033633-007**		PCB 4 tails	
12 Socket		21-033393-006**		PCB 4 tails	
12 Socket		21-033393-005**		PCB 4 tails	
12 Socket		21-033433-001**		PCB 4 tails	M38999 Series II, JN1104 Interface
16 Pin	21-033856-015			PCB 2 tails	
16 Pin	21-033856-025			PCB 90 degree, 2 tails	
16 Pin	21-033856-065			PCB 2 tails	
16 Pin	21-033634-015			PCB 1 tail	Outer body grounded to shell
16 Pin	21-033634-035			PCB 1 tail	Outer body grounded to shell
16 Pin	21-033634-045			PCB 1 tail	
16 Pin	21-033386-001			PCB 2 tails	
16 Socket	21-033857-001			PCB 2 tails	
16 Socket	21-033857-008			PCB 2 tails	
16 Socket	21-033857-007			PCB 2 tails	
16 Socket	21-033610-001			PCB 2 tails	
16 Socket	21-033610-002			PCB 2 tails	
16 Socket	21-033441-001			PCB 2 tails	
16 Socket	21-033606-001			PCB 2 tails	
16 Socket	21-033606-021†			PCB 2 tails	M38999 Series II
16 Socket	21-033606-031†			PCB 2 tails	
16 Socket	21-033610-003			PCB 2 tails	
16 Socket	21-033857-003			PCB 2 tails	

\* Consult Amphenol Aerospace for tail configurations and tail diameters.

\*\* Size 12 twinax and triax contacts are intermatable.

† Consult Amphenol Aerospace for current release of this contact.

Front face of pin inserts illustrated

Insert Arrangement	<b>9-5</b>	<b>10-2</b>	<b>11-2</b>	<b>12-3</b>	<b>13-3</b>	<b>12-4</b>	<b>13-4</b>	<b>14-4</b>	<b>15-4</b>	
Connector Series	<b>TV</b>	<b>SJT</b>	<b>LJT, TV</b>	<b>JT</b>	<b>LJT</b>	<b>JT, SJT</b>	<b>LJT, TV</b>	<b>JT</b>	<b>LJT</b>	
Service Rating	Grounded	I		II		I		I		
Number of Contact	1	2		3		4		4		
Contact Size	8 Twinax	16		16		16		12		
Insert Arrangement	<b>14-5</b>	<b>15-5</b>	<b>14-15</b>	<b>15-15</b>	<b>14-68</b>	<b>15-68</b>	<b>14-97</b>	<b>15-97</b>	<b>16-6</b>	<b>17-6</b>
Available in Connector Series	<b>JT, SJT</b>	<b>LJT, TV</b>	<b>JT, SJT</b>	<b>LJT, TV</b>	<b>JT</b>	<b>LJT</b>	<b>JT, SJT</b>	<b>LJT, TV</b>	<b>JT, SJT</b>	<b>LJT, TV</b>
Service Rating	II		I		I		I		I	
Number of Contact	5		14	1	8		8	4	6	
Contact Size	16		20	16	16		20	16	12	
Insert Arrangement	<b>16-8</b>	<b>17-8</b>	<b>16-13</b>	<b>17-13</b>	<b>16-99</b>	<b>17-99</b>	<b>17-2</b>	<b>17-22</b>	<b>16-6</b>	<b>17-6</b>
Connector Series	<b>JT, SJT</b>	<b>LJT, TV</b>	<b>JT, SJT</b>	<b>LJT</b>	<b>JT, SJT</b>	<b>LJT, TV</b>	<b>LJT</b>	<b>TV</b>	<b>LJT</b>	<b>TV</b>
Service Rating	II		I		I		M		Coax	
Number of Contact	8		13		21	2	38	1	2	2
Contact Size	16		16		20	16	22D	8	12	8
Insert Arrangement	<b>17-25</b>	<b>18-11</b>	<b>19-11</b>	<b>18-28</b>	<b>19-28</b>	<b>18-30</b>	<b>19-30</b>	<b>19-31</b>		
Connector Series	<b>LJT</b>	<b>JT, SJT</b>	<b>LJT, TV</b>	<b>JT</b>	<b>LJT</b>	<b>JT</b>	<b>LJT</b>	<b>TV</b>		
Service Rating	M		II		I		I	M		
Number of Contact	22	2	11	26	2	29	1	2	1	12
Contact Size	22D	8	16	20	16	20	16	8	12	22D

The insert arrangements shown on this page and the next page represent the most readily available patterns within the 38999 Circular Series. If you require other arrangements than what are shown here, consult Amphenol for further availability. In most cases, unless otherwise stated, size 8 and size 12 cavities can be filled with either coax, twinax, triax or power contacts.

### CONTACT LEGEND

8	10	12	16	20	22D
Coax/Twinax/ Triax or Power	Twinax/Triax/ or Power	Coax/Twinax/ Triax or Power	Coax or Power	Power	Power



# Insert Patterns - MIL-DTL-38999

## Incorporating Coax, Twinax and Triax Contacts

Front face of pin inserts illustrated

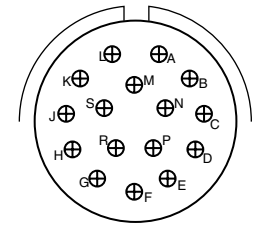
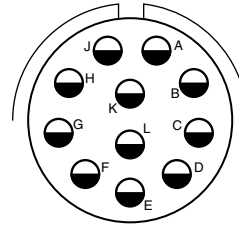
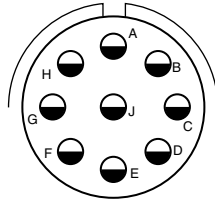
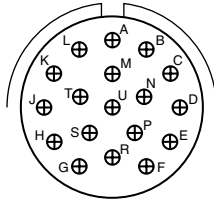

Insert Arrangement	18-68	19-68	18-96	20-11	21-11	20-16	21-16
Connector Series	JT	LJT	JT	JT, SJT	LJT, TV	JT, SJT	LJT, TV
Service Rating		I	I		I		II
Number of Contact	18		9		11		16
Contact Size		16	12		12		16

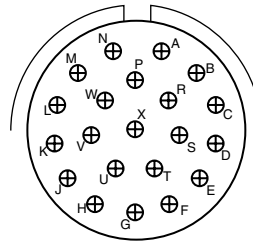
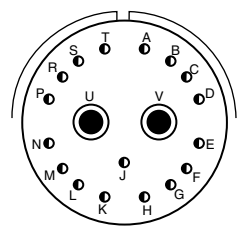
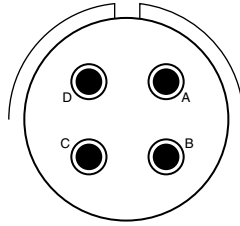
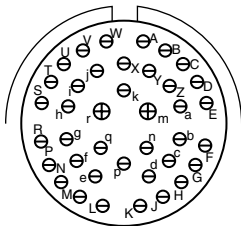

Insert Arrangement	20-39	21-39	20-75	21-75	20-79	21-79	22-21	23-21
Connector Series	JT, SJT	LJT, TV	SJT	LJT, TV	SJT	LJT	JT, SJT	LJT, TV
Service Rating		I		M		II		II
Number of Contact	37	2		4		17		21
Contact Size	20	16		8		22D		16

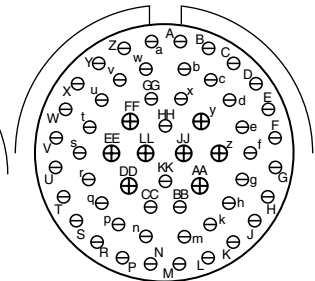
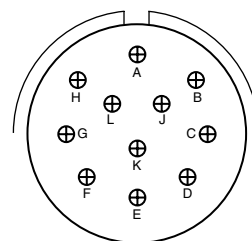
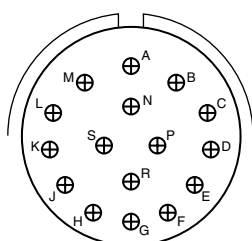
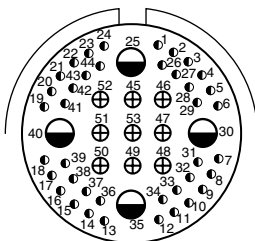

Insert Arrangement	23-54	23-97	23-99	24-4	25-4
Connector Series	TV	LJT	LJT	JT, SJT	LJT, TV
Service Rating		II	II		I
Number of Contact	40	9	11	48	8
Contact Size	22D	16	16	20	16

### CONTACT LEGEND

8	10	12	16	20	22D
Coax/Twinax/Triax or Power	Twinax/Triax or Power	Coax/Twinax/Triax or Power	Coax or Power	Power	Power

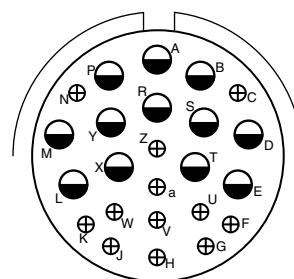
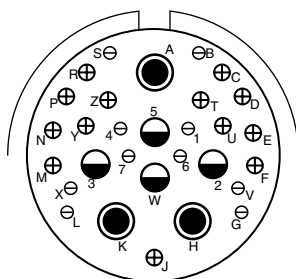
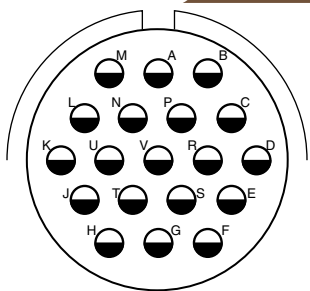

Insert Arrangement	24-19	25-19	24-20	25-20*	24-24	25-24
Connector Series	JT, SJT	LJT, TV	SJT	LJT, TV	JT, SJT	LJT, TV
Service Rating	I		N		I	
Number of Contact	19		10	13	3	4
Contact Size	12		20	16	8	12

(Locations U and Y - Dedicated to Fiber Optics)

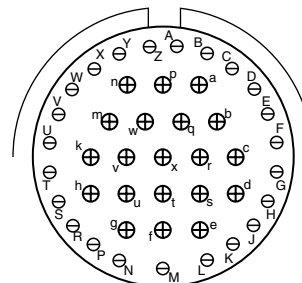
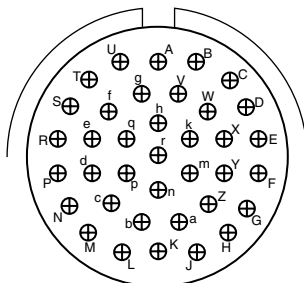
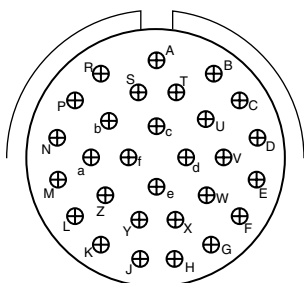

Insert Arrangement	24-29	25-29	24-37	25-37	24-43	25-43
Connector Series	JT, SJT	LJT, TV	JT, SJT	LJT, TV	JT, SJT	LJT, TV
Service Rating	I		I		I	
Number of Contact	29		37		23	20
Contact Size	16		16		20	16

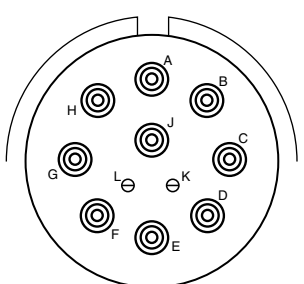
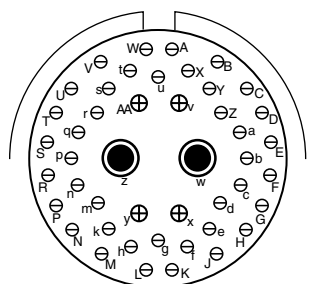

Insert Arrangement	24-46	25-46	25-11*
Connector Series	SJT	LJT, TV	LJT, TV
Service Rating	I		N
Number of Contact	40	4	2
Contact Size	20	16	8

\* For use in MIL-STD-1760 applications with MIL-DTL-38999 Series III.

### CONTACT LEGEND

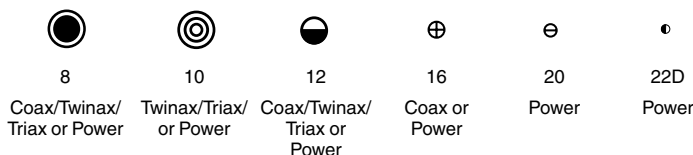

# MIL-DTL-5015, MIL-DTL-22992 Circular Connector Overview

Amphenol's medium to heavy weight circular include the MS/Standard MIL-DTL-5015 series and the heaviest weight, largest size circular is the Heavy Duty MIL-DTL-22992 series. These time-tested circulars have been used for several years. They are dependable general duty and environmentally resistant connectors for military and industrial applications.

Shielded coax contacts, although more popularly used in 38999 types and 26482 types, can be incorporated into some arrangements of the 5015 and 22992 type circulars. Shielded coaxial contacts within these series are considered MS modifications to the MIL-spec connector and the coax contacts are pre-installed in the connector. Normal operating voltage with power contacts only is up to 3000 VAC (RMS) at sea level for MIL-DTL-5015 circulars. The Heavy Duty types are designed for high current capacity and have current ratings (with power contacts only) of up to 200 amps.

## Standard and Heavy Duty Circular offer these features for contact termination flexibility:

- Insert arrangements that can incorporate:
- Size 4, 8 & 12 Crimp Coax contacts, pre-installed in the connector
- Wide selection of connector shell styles and sizes
- Standard power contact options within the various connector styles include: solder type, crimp front release, crimp rear release
- Coax contacts are designed to the same high performance standards as power contacts. Coax and power contacts may be intermixed with no degradation of connector reliability.

## Amphenol® MS/Standard Circular MIL-DTL-5015\* Type Connector Family:

See MS/Standard catalog 12-020 for complete information on these styles

### MS-A, MS-C, MS-E, MS-F, MS-R

- Produced in strict accordance with MIL-DTL-5015
- Threaded coupling, solder or crimp rear insertion contacts (coax available in crimp type only)
- Class A, Solid Shell - intended for general connector usage
- Class C, Pressurized - for use on pressurized bulkheads or pressure barriers
- Class E/F, Environmental Resisting - ideally suited for installation where condensation, vibration and rapid changes in pressure or temperature are considerations
- Class R, Lightweight Environmental Resisting - shorter in length and lighter in weight than Class E

## GENERAL ORDERING INFORMATION

Amphenol MS/Standard MIL-DTL-5015 type and Heavy Duty MIL-DTL-22992 type circulars are normally supplied with a full complement of power contacts, separately packaged. Coax contacts are ordered by part number as referenced in the part number charts on the following pages of this catalog, and are substituted for the power contacts at the time of the cable or equipment assembly. Coax contacts are pre-installed in these series. Installation instructions for the coax contacts for these series are provided in Amphenol document L-650.

### HOW TO ORDER:

1. Select the coax contacts designed for the cable being used from the chart on page 409 of this catalog. Select a connector insert from those shown on page 44 which will accommodate the quantity and size of coaxial contacts needed plus any power contacts required.
2. Determine the MS/Standard or Heavy Duty Series style desired. (See features of each series referenced above). The catalog referenced for each series will guide you in determining shell style, finish, service class and insert rotation required for your application. MS/Standard MIL-DTL-5015 Type Connectors (Catalog 12-020 on-line at [www.amphenol-industrial.com](http://www.amphenol-industrial.com)) Catalog 12-052 - MIL-DTL-22992 QWLD Connectors (on-line at [www.amphenol-aerospace.com](http://www.amphenol-aerospace.com)) Catalog 12-053 - QWL Connectors (currently not on-line; consult Amphenol Aerospace for hardcopy)
3. Consult Amphenol, Sidney, NY with the pertinent cable, contact, insert arrangement and connector style choices for complete connector part number.

\* Amphenol also offers the following other MIL-DTL-5015 Circular Connectors which are threaded coupling

- (consult Amphenol Industrial for availability of shielded contacts in any of these series):
- Amphenol®/Matrix® MIL-DTL-5015 with crimp rear releasable and rear insertable contacts. (See Matrix 5015 section of this catalog)
  - Amphenol® MIL-DTL-5015 Modifications (Ask for Industrial Catalog 12-021)
  - Amphenol® GT Series with reverse bayonet coupling (Ask for Catalog 12-024)
  - Amphenol® AC Threaded and AC-B Bayonet Series (Ask for Industrial Catalog 12-025)



MS/Standard MIL-DTL-5015 Type Connectors



Heavy Duty QWLD, MIL-DTL-22992 Connectors

## Amphenol® Heavy Duty Circular MIL-DTL-22992 Connector Family:

### QWLD

- Designed for most power and control circuits
  - Military MIL-DTL-22992 qualified versions and proprietary equivalents
- See Catalog 12-052 for complete information on these styles.

### QWL

- A more compact heavy duty design for industrial power and control applications

See Catalog 12-053 for complete information on these styles.

NOTE:  
MIL-DTL-5015 supersedes MIL-C-5015  
MIL-DTL-22992 supersedes MIL-C-22992

**Amphenol® Coaxial Contacts** can be incorporated into MS/Standard MIL-DTL-5015 Type Circular Connectors and Heavy Duty MIL-DTL-22992 Connectors. They offer the same durability advantages and design benefits for reliable interconnection as the Amphenol coax contacts used in high performance D38999 connectors. A variety of military and commercial shielded cables are accommodated within these circular series.

Other features of the coax contacts available for MS/Standard and Heavy Duty circulars include:

- Several insert arrangements that can incorporate:
  - Size 4, 8 and 12 coax contacts
- Advanced shielding wire technology in a rugged military connector
- Single connector with multiple coaxial connection eliminates cross-mating
- Positive contact captivation - especially important in these series with its much higher coupling/uncoupling force
- Older shielded cable type availability



**Coax Contact, Pin**  
for use in MS/Standard MIL-DTL-5015 and  
Heavy Duty MIL-DTL-22992 Connectors



**Coax Contact, Socket**  
for use in MS/Standard MIL-DTL-5015 and  
Heavy Duty MIL-DTL-22992 Connectors

## TYPICAL ELECTRICAL PERFORMANCE

Size 4, 8 & 12 Contacts

Contact Resistance:

Center @ 1 Amp, 170 millivolts max. voltage drop @ 25°C

Outer @ 12 Amps, 150 millivolts max. voltage drop @ 25°C

Dielectric Withstanding Voltage:

Size 4 & 8: 1,300 VAC Rms @ sea level

Size 12: 1,000 VAC Rms @ sea level

Size 4, 8 & 12: 250 VAC Rms @ 50,000 ft.

Insulation Resistance

5,000 megohms minimum @ 25°C

All contacts in these series are non-impedance matched contacts.

Part numbers 21-033063-XX( ) and 21-033064-XX( ) are moisture seal design (internal O-ring).

## CONTACT FINISHES:

Suffix      Finish

1	0.00020 min. silver over copper flash
2	0.00005 min. gold (Knoop hardness 130-200) over silver
3	0.00010 min. gold (Knoop hardness 130-200) over silver
4	0.00010 min. gold (Knoop hardness 130-200) over copper
5	0.00005 min. gold (Knoop hardness 130-200) over nickel
E	0.00005 min. gold (Knoop hardness 90 max.) over copper
F	0.00005 min. gold (Knoop hardness 130-200) over copper
H	0.00010 min. gold (Knoop hardness 130-200) over copper

# Coaxial Contacts for MIL-DTL-5015, Heavy Duty MIL-DTL-22992 Application Data

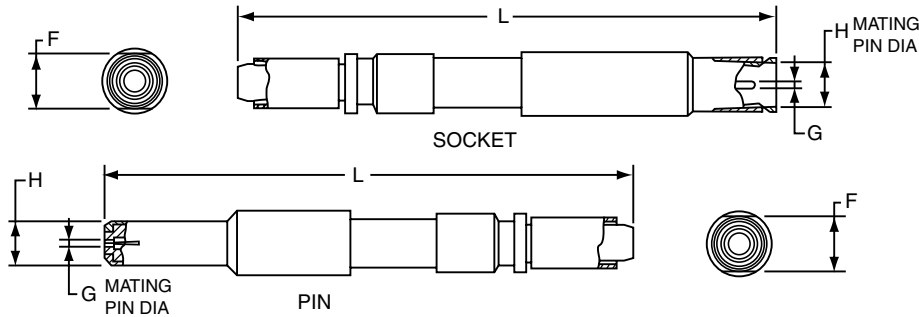

NOTE: All contacts of the same size and the same inner and outer contact diameters (G & H) will mate with each other.

COAX CONTACTS													
For use in MS/Standard MIL-DTL-5015 Type and Heavy Duty MIL-DTL-22992 Type Connectors													
Cable	Contact Part Number (See L-650 Termination Instruction Sheet for all contacts listed below)**		Size	Finish on Mating Parts (See Pg. 42)	Dimensional Data (See Drawings above)				Crimp Ferrule Tools			Retainer Nut Wrench	
	Pin	Socket			G Dia.	H Dia. ± 0.001	F Across Flats ±0.004	L Length Ref.		MIL-T-22910/7-1 Tool Use with Die Part Number	MIL-T-22520/5-01 Tool Use with Die Part Number		MIL-T-229520/10-01 Tool Use with Die Part Number
RG-58C/U, RG-141A/U, RG-303/U	21-033014-001	21-033013-001	8	5	0.0355 ± 0.0010	0.218	0.280	1.481	1.511	M22910/7-15 (B)	M22520/5-05 (B) M22520/5-41 (B)	M22520/10-07 (B)	11-8676-2
	21-033034-002	21-033033-002	8	1									
	21-033048-002	21-033047-002	8	††									
	21-033016-005	21-033015-005	8	3									
	21-033130-002()	21-033129-002()	8	***									
RG-59B/U, RG-62A/U, RG-62B/U, RG-210/U	21-033014-005	21-033013-005	8	5	0.0355 ± 0.0010	0.218	0.280	1.481	1.511	M22910/7-18 (B)	M22520/5-45 (B)		11-8676-3
	21-033016-002	21-033015-002	8	3									
	21-033034-005	21-033033-005†	8	1									
	21-033130-005()	21-033129-005()	8	***									
	21-033064-021()	21-033063-021()	8	***									
21-033060-010()	21-033059-010()	4	***	0.0400 ± 0.0010	0.344	0.375	1.669	1.605				11-8676-4	
RG-161/U, RG-174A/U, RG-179B/U, RG-187A/U, RG-188A/U, RG-316/U	21-033014-003	21-033013-003	8	5	0.0355 ± 0.0010	0.218	0.280	1.481	1.511	M22910/7-12 (B)	M22520/5-03 (A) M22520/5-08 (A) M22520/5-35 (B)	M22520/10-05 (A)	11-8676-2
	21-033016-001	21-033015-001	8	3									
	21-033034-003	21-033033-003	8	1									
	21-033130-003()†	21-033129-003()†	8	***									
	21-033064-020()†	21-033063-020()†	8	***									
21-033014-021	21-033013-021	12	5	0.0200 ± 0.0005	0.128	0.172	1.481	1.511	M22910/7-11 (B)	M22520/5-03 (B) M22520/5-33 (B)	M22520/10-05 (B)	11-8676-1	
21-033034-001	21-033033-001	12	1										
21-033048-001	21-033047-001	12	***										
21-033130-001()†	21-033129-001()†	12	***										
RG-178B/U, RG-196A/U	21-033014-022†	21-033013-022†	12	5	0.0200 ± 0.0005	0.128	0.172	1.481	1.511	M22910/7-11 (B)	M22520/5-03 (B) M22520/5-33 (B)	M22520/10-05 (B)	11-8676-1
RG-180B/U, RG-195A/U	21-033014-006	21-033013-006	8	5	0.355 ± 0.0010	0.218	0.280	1.481	1.511	M22910/7-15 (B)	M22520/5-05 (B) M22520/5-41 (B)	M22520/10-07 (B)	11-8676-2
	21-033034-006†	21-033033-006†	8	1									
	21-033048-003	21-033047-003	8	***									
	21-033130-006()†	21-033129-006()	8	***									
RG-212/U	21-033060-011()	21-033059-011()	4	***	0.0625 ± 0.0010	0.344	0.375	1.669	1.605	M22910/7-14 (A)	M22520/5-39 (A)		11-8676-4
RG-140/U, RG-302/U	21-033014-008	21-033013-008	8	5	0.0355 ± 0.0010	0.218	0.280	1.481	1.511	M22910/7-17 (B)	M22520/5-05 (A) M22520/5-19 (B)	M22520/10-07 (A)	11-8676-2
	21-033034-008	21-033033-008	8	1									
	21-033130-008()†	21-033129-008()†	8	***									
RG-55B/U, RG-142A/U, RG-142B/U, RG-223/U	21-033014-004	21-033013-004	8	5	0.0355 ± 0.0010	0.218	0.280	1.481	1.511	M22910/7-17 (B)	M22520/5-05 (A) M22520/5-19 (B)	M22520/10-07 (A)	11-8676-2
	21-033034-004	21-033033-004	8	1									
	21-033130-004()	21-033129-004()	8	***									
21-033060-102()	21-033059-012()	4	***	0.0625 ± 0.0010	0.344	0.375	1.669	1.605				11-8676-4	

\*\*\*See finish options for MS/Standard and Heavy Duty contacts listed on page 416. Replace the parenthesis of the contact part number with the finish suffix number. However, you should consult Amphenol Aerospace regarding the availability of all finish choices for each part number.

† Consult Amphenol Aerospace for current availability of this contact.  
CRIMPING TOOLS: Italicized letters in parenthesis that follow positioner part numbers indicate applicable die closure. Commercial equivalents with the same die closure dimension may be used.  
†† 21-033047-X and 21-033048-X are supplied with E (soft gold) finish on mating socket parts, and F (hard gold) finish on mating pin parts.\*\*Termination instruction sheet L-650 can be found on-line at: [www.amphenol-aerospace.com/serviceinstructions.asp](http://www.amphenol-aerospace.com/serviceinstructions.asp)

# Insert Patterns - Standard MIL-DTL-5015, Heavy Duty MIL-DTL-22992 Incorporating Coax Contacts

Front face of pin inserts illustrated

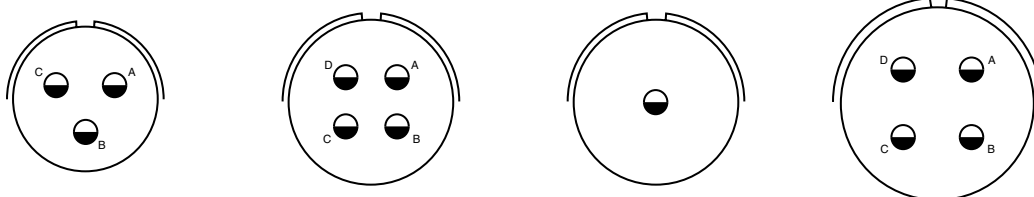

Insert Arrangement	16-10	18-10	18-16	20-4
Connector Series	MS/Standard, QWLD, QWL	MS/Standard, QWLD, QWL	MS/Standard, QWLD, QWL	MS/Standard, QWLD, QWL
Service Rating	A	A	C	D
Number of Contact	3	4	1	4
Contact Size	12	12	12	12

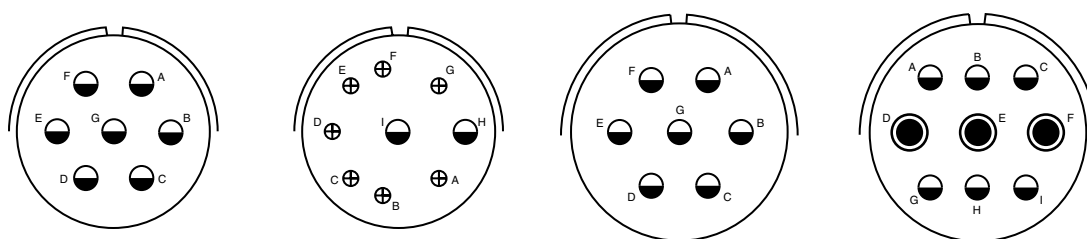

Insert Arrangement	20-15	20-16	24-2	24-11
Connector Series	MS/Standard, QWLD, QWL	MS/Standard, QWLD, QWL	MS/Standard, QWLD, QWL	MS/Standard, QWLD, QWL
Service Rating	A	A	D	A
Number of Contact	7	2      7	7	3      6
Contact Size	12	12      16	12	8      12

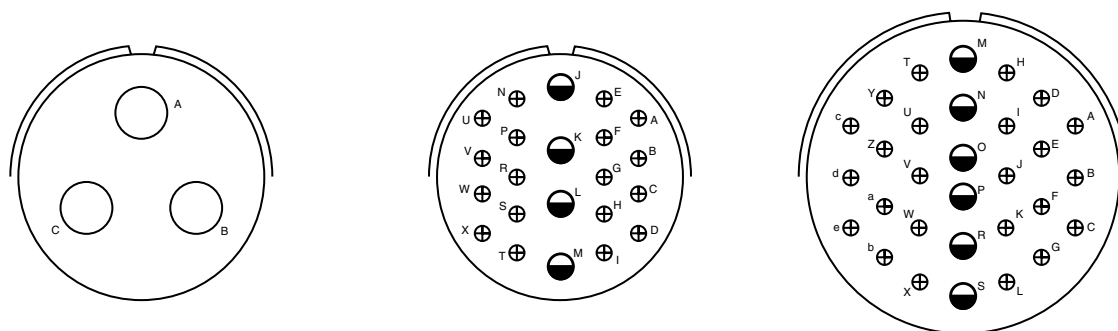

Insert Arrangement	28-6	28-11	32-8
Connector Series	MS/Standard, QWLD, QWL	MS/Standard, QWLD, QWL	MS/Standard, QWLD, QWL
Service Rating	D	A	A
Number of Contact	3	4      18	6      24
Contact Size	4	12      16	12      16

The insert arrangements shown on this page represent the most readily available patterns within the MIL-DTL-5015 and MIL-DTL-22992 Series. If you require other arrangements than what are shown here, consult Amphenol for further availability. MS/Standard connectors have over 200 insert pattern arrangements available, and within these patterns any size 4, 8 or 12 contact cavities can be incorporated with coax contacts. However, you need to consult Amphenol, Sidney NY for availability and ordering information. All coax contacts in the Standard and Heavy Duty series come pre-installed in connectors.

**CONTACT LEGEND**

4	8	12	16
Coax or Power	Coax/ Twinax/Triax or Power	Coax/Twinax/ Triax or Power	Coax or Power

# Rectangular Rack & Panel Connectors

## That Incorporate High Speed Contacts

Amphenol provides an impressive array of Rectangular Interconnection products to meet the needs of high density systems such as opto-electrical backplanes used in many applications that include: medical equipment, IC chip testers, telecommunications, military and commercial aviation, military ground vehicles, GPS systems, space and industrial applications.

- ARINC 600 and R27 Rack and Panel connectors can incorporate:
  - size 8 Coax contacts
  - Size 1 and size 5 Coax (consult Amphenol Canada)
  - Size 12 Twinax contacts
  - Size 8 Quadrax contacts
  - Size 8 Differential Twinax contacts

### ARINC 600 Rack and Panel Rectangular Connectors

See Amphenol Canada Publication SL-379, ARINC 600 Rack and Panel Connectors for complete information.

- The ARINC 600 is the successor to the ARINC 404 for many of the new avionics designs and offers lower mating force contacts, increased contact count and a front release, floating keying system
- ARINC 600 Connectors are a recognized standard rack and panel connector for aircraft applications with both environmental and non-environmental versions available
- Designed to meet all relevant ARINC 600 connector specifications
- Front removable keying posts
- Up to 800 size 22 contact positions in one connector
- Contact options: standard contacts are power/signal crimp rear release in sizes 12, 16, 20 and 22 in crimp or PCB; or shielded coax, concentric twinax, quadrax contacts; or fiber optics
- Waveguide connections

### R27 Rack and Panel Rectangular Connectors

See Amphenol Canada Publication for R27 Series Connectors for complete information.

- The R27 Series is a robust rectangular connector designed to meet or surpass all the requirements of the MIL-DTL-83527 specification and EN 3682 European Standard.
- Well suited for harsh environments - enhanced environmental sealing, robust and durable shells, EMI shielding spring
- Filtered or non-filtered
- Connectors, shells, inserts, termination modules and contacts are sold separately or fully assembled
- Interchangeable insert patterns with ARINC 600 models
- Contact options: standard contacts are power/signal crimp rear release in sizes 12, 16, 20 and 22 in crimp or PCB; or shielded coax, concentric twinax, quadrax contacts; or fiber optics

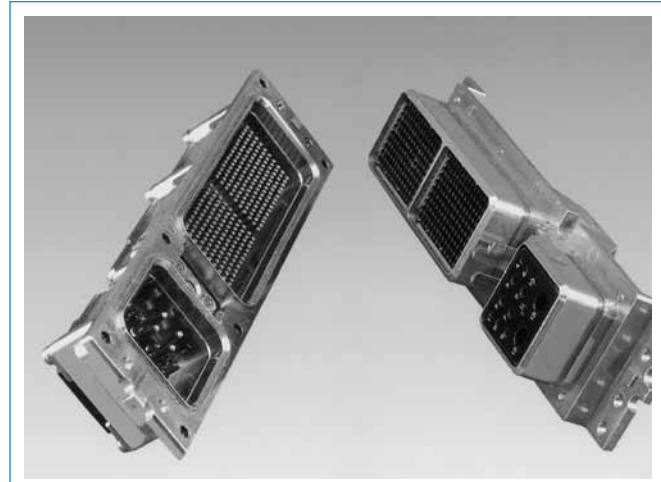

ARINC 600 Rack and Panel Connectors are high density connectors that can incorporate high speed shielded contacts

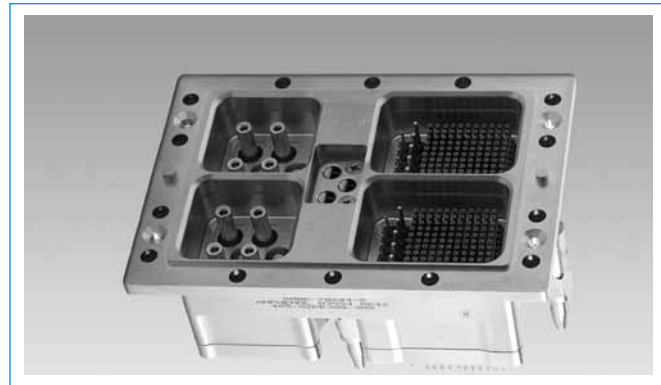

R27 Series Rack and Panel Connector can incorporate high speed shielded contacts



Coax Contact , Size 8 for use in ARINC Rack and Panel Connectors

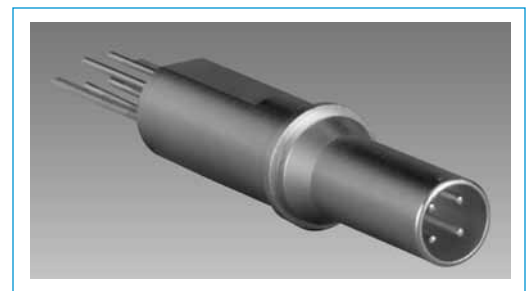

Quadrax Contact , Size 8 for use in ARINC Rack and Panel Connectors

### ARINC 600 & R27 Rack and Panel Connectors

QUADRAX CONTACTS FOR USE IN ARINC 600 & R27 CONNECTORS						
Cable	Contact Part Number (Termination Instruction Sheet)**		Impedance (Ohms)	Contact Size	Crimping Tools	
	Pin	Socket			Inner Contact	Outer Contact
Tensolite NF24Q100-01, 24443/9P025X-4(LD), S280W502-4, 24443/03130X-4(LD)	21-033382-021 (L-2119-AH)	21-033383-021 (L-2119-AH)	100	8	M22520/2-01 with Positioner Daniels K709 (M22520/2-37)	M22520/5-01 with Die Set M22520/5-45 (Location B)
Draka Fileca F-4703-3	21-033382-031 (L-2119-I)	21-033383-031 (L-2119-I)	100			
Draka Fileca F-4704-5, NF22Q100	21-033382-101 (L-2119-AS)†	21-033383-101 (L-2119-AS)†	100			
JSFY02-1	21-033382-071 ↑	21-033383-071 ↑	110			
Tensolite 26473/02006X-4(LD), Gore RCN8328	21-033382-061 (L-2119-L)	21-033383-061 (L-2119-L)	150		M22520/2-01 with Positioner Daniels K709 (M22520/2-37)	M22520/5-01 with Die Set M22520/5-45 (Location A)

DIFFERENTIAL TWINAX CONTACTS FOR USE IN ARINC 600 & R27 CONNECTORS						
Cable	Contact Part Number (Termination Instruction Sheet)**		Impedance (Ohms)	Contact Size	Crimping Tools	
	Pin	Socket			Inner Contact	Outer Contact
ABS0386WF24	21-033378-021 (L-2119-G)	21-033379-021 (L-2119-G)	100	8	M22520/2-01 with Positioner Daniels K709 (M22520/2-37)	M22520/5-01 with Die Set M22520/5-45 (Location A & B)
ASNE0272TK22	21-033378-031 (L-2119-G)	21-033379-031 (L-2119-G)	100			
ASNE0272TK24	21-033378-041 (L-2119-G)	21-033379-041 (L-2119-G)	100			
Tensolite 24463/9P025X-2(LD)	21-033378-051 ↑	21-033379-051 ↑	100			
GC875TM24H	21-033378-061 (L-2119-AU)	21-033379-061 (L-2119-AU)	77			
	21-033378-071 ↑	21-033379-071 ↑	110			

COAX CONTACTS FOR USE IN ARINC 600 & R27 CONNECTORS					
Cable	Contact Part Number (Termination Instruction Sheet)**		Contact Size	Crimping Tools	
	Pin	Socket		Inner Contact	Outer Contact
RG-179	21-033676-001 (L-2090-B)	21-033675-001 (L-2090-A)	8	M22520/2-01 with Positioner K1275	M22520/10-01 with Die Set M22520/10-05 (A)
RG-179	21-033476-001	21-033475-001			
5M2869-001	21-033676-002 ↑	21-033675-002 ↑			

PCB QUADRAX CONTACTS FOR USE IN ARINC 600 & R27 CONNECTORS				
PCB Quadrax Contacts	Contact Part Number		Impedance (Ohms)	Contact Size
	Pin	Socket		
PCB (.346 Length)		21-033397-171	100	8
PCB (.473 Length)	21-033398-261			

TWINAX CONTACTS FOR USE IN ARINC 600 & R27 CONNECTORS					
Cable	Contact Part Number (Termination Instruction Sheet)**		Contact Size	Crimping Tools	
	Pin	Socket		Inner Contact	Outer Contact
EPD 32263, 10612, GSC-12-2548-00	21-033631-004† (L-2092-U)†	21-033632-003 (L-2092-J)	12	MH992 with Positioner K1365	GS200-1 with Positioner GP959

† Consult Amphenol Aerospace for current release of this contact or instruction sheet if applicable.  
Daniels crimping tools are available from Daniels Mfg. Corp. 6103 Anno Ave., Orlando, FL 32809

\*\*Termination instructions are packaged with each contact and can be found on-line at: [www.amphenol-aerospace.com/serviceinstructions.asp](http://www.amphenol-aerospace.com/serviceinstructions.asp)



*Amphenol has today's broadest range of interconnection solutions for military, commercial and industrial applications. As a worldwide interconnection product leader, Amphenol can meet not only connector needs, but also contact needs of all types. In addition to the shielded and high frequency contacts shown in this publication, Amphenol offers many other contact styles:*

## **PRINTED CIRCUIT BOARD SIGNAL AND POWER CONTACTS**

See the Printed Circuit Board section of this catalog.

## **THERMOCOUPLE CONTACTS**

Available for MIL-DTL-5015, MIL-DTL-22992, MIL-DTL-26482, MIL-DTL-26500, MIL-DTL-38999, MIL-DTL-83723 and other series connectors. Thermocouples are designed for temperature measuring applications, and are available in both pin and socket configurations in alumel, chromel, iron and constantan materials. Please refer to the mil series sections in this catalog.

## **FLEX TERMINATION ASSEMBLIES FOR PCB APPLICATION**

Flex circuits are available for MIL-DTL-38999, MIL-DTL-5015 and MIL-DTL-26482, as well as for special products such as EMI/EMP filter connectors and rectangular LRM connectors. Please contact an Amphenol Sales Person for more information or visit [www.amphenol-aerospace.com/support](http://www.amphenol-aerospace.com/support) to find a sales person in your area.

## **FIBER OPTIC TERMINI**

See the Fiber Optic section of this catalog

## **FILTER PI TYPE TUBULAR AND PLANAR ARRAY CONTACT ASSEMBLIES**

See the Printed Circuit Board section of this catalog.

## **RADSOK® HIGH POWER CONTACTS**

Amphenol's RADSOK® contact design is a hyperbolic, stamped grid configuration within the socket cylinder. As the male pin is inserted, axial members in the female socket half deflect, imparting high current flow across the connection with minimal voltage loss. Another advantage of the RADSOK® contact is low insertion force. The RADSOK® contact has been incorporated into three of the large industrial families of connectors; the GT series, the P-Lok series and 5015 types. These connectors, known as Amphe-Power® connectors, can handle up to 150% higher amperages. Amphenol Industrial Operations division also provides a wide range of power to board interconnects utilizing the RADSOK® technology. These provide high amperage connection to busbars, wires and circuit boards.

RADSOK® contacts are being further introduced into military/aerospace products. High power RADSOK® is now developed into applications for engine connectors for Commercial Air, and are also being designed into LRM interconnects for high speed data transfer. See Amphenol Industrial Brochure, SL-391. (visit [www.amphenol-industrial.com](http://www.amphenol-industrial.com))

See more information on RADSOK® in options, other products section of this catalog pages.

## **RECTANGULAR CONNECTORS**

Amphenol provides an impressive array of Rectangular Interconnection products to meet the needs of high density systems such as opto-electrical backplanes used in many applications that include: medical equipment, IC chip testers, telecommunications, military and commercial aviation, military ground vehicles, GPS systems, space and industrial applications.

Available in Low Mating Force with Brush contacts, Power Strip, LRM, ARINC 600 Rack and Panel, and R27 Rack and Panel Rectangular Connectors.

For more information please contact an Amphenol Sales Person on visit [www.amphenol-aerospace.com/support](http://www.amphenol-aerospace.com/support) for a sales person in your area.



**PC Tails Signal and Power Contacts and Custom PC Tail Designs. Compliant Pin (Press Fit) Contacts for Solderless Mounting to PC Boards**



**Sculptured Flex Circuits**



**RADSOK® High Power Contacts and Connectors**



**LRM Connectors with Inserts of Staggered Brush Contacts and Inserts of Coax Contacts**

The following check list is provided to help you specify a high frequency contact and cable system, and it will help our design team to meet your requirements. You may copy this page and fax it to Amphenol Aerospace 607-563-5157, attention Contact Design. Or call 607-563-5011 or 800-678-0141 for assistance.

Date \_\_\_\_\_

Amphenol Salesperson \_\_\_\_\_

## CUSTOMER INFORMATION

Customer Company Name \_\_\_\_\_

Engineer Name \_\_\_\_\_

Program \_\_\_\_\_

Forecast \_\_\_\_\_

## CABLE INFORMATION

Cable Part Number\* \_\_\_\_\_

Cable Manufacturer \_\_\_\_\_

Cable Type: Coaxial  Twinax

Triax  Quadrax

Cable Impedance \_\_\_\_\_

\* if not an RG-Number complete below information:

O.D. of Inner Wire \_\_\_\_\_ AWG of Inner Wires \_\_\_\_\_

No. of Inner Wire Strands \_\_\_\_\_ Material of Inner Wires \_\_\_\_\_

O.D. of Inner Insulation \_\_\_\_\_ Material of Inner Insulation \_\_\_\_\_

O.D. of First Braid \_\_\_\_\_ Braid Type \_\_\_\_\_ Braid AWG \_\_\_\_\_  
(flat, round, wrap)

O.D. of First Jacket \_\_\_\_\_ Jacket Material \_\_\_\_\_

O.D. of Second Braid \_\_\_\_\_ Braid Type \_\_\_\_\_ Braid AWG \_\_\_\_\_  
(flat, round, wrap)

O.D. of Second Jacket \_\_\_\_\_ Jacket Material \_\_\_\_\_

It is essential that a 3 foot sample of the cable be supplied for performance and crimp tool development.

## CONNECTOR INFORMATION

Connector Family: TV-R  LJT-R  JT-R

Other \_\_\_\_\_

Insert Arrangement Desired \_\_\_\_\_

Shell Style \_\_\_\_\_

Shell Plating \_\_\_\_\_

## CONTACT INFORMATION

Type: Coaxial  Concentric Twinax  Triax

Differential Twinax\*  Quadrax\*

Size\*: 8  12  16

Contact Impedance Matched? Yes  No

50Ω  75Ω  100Ω  150Ω  Other \_\_\_\_\_

\* Quadrax and Differential Twinax currently available in size 8 only.

## PERFORMANCE INFORMATION

Electrical Protocol \_\_\_\_\_

VSWR Requirement 1. to 1. \_\_\_\_\_ Cross Talk \_\_\_\_\_ db

Operating Frequency \_\_\_\_\_ Attenuation \_\_\_\_\_ Insertion Loss \_\_\_\_\_

Operating Voltage \_\_\_\_\_ VAC (RMS) \_\_\_\_\_ DC

Current Outer Contact \_\_\_\_\_ Amp Current Inner Contacts \_\_\_\_\_

Application Temperature \_\_\_\_\_ Environmental Requirement \_\_\_\_\_

Компания «Океан Электроники» предлагает заключение долгосрочных отношений при поставках импортных электронных компонентов на взаимовыгодных условиях!

Наши преимущества:

- Поставка оригинальных импортных электронных компонентов напрямую с производств Америки, Европы и Азии, а так же с крупнейших складов мира;
- Широкая линейка поставок активных и пассивных импортных электронных компонентов (более 30 млн. наименований);
- Поставка сложных, дефицитных, либо снятых с производства позиций;
- Оперативные сроки поставки под заказ (от 5 рабочих дней);
- Экспресс доставка в любую точку России;
- Помощь Конструкторского Отдела и консультации квалифицированных инженеров;
- Техническая поддержка проекта, помощь в подборе аналогов, поставка прототипов;
- Поставка электронных компонентов под контролем ВП;
- Система менеджмента качества сертифицирована по Международному стандарту ISO 9001;
- При необходимости вся продукция военного и аэрокосмического назначения проходит испытания и сертификацию в лаборатории (по согласованию с заказчиком);
- Поставка специализированных компонентов военного и аэрокосмического уровня качества (Xilinx, Altera, Analog Devices, Intersil, Interpoint, Microsemi, Actel, Aeroflex, Peregrine, VPT, Syfer, Eurofarad, Texas Instruments, MS Kennedy, Miteq, Cobham, E2V, MA-COM, Hittite, Mini-Circuits, General Dynamics и др.);

Компания «Океан Электроники» является официальным дистрибьютором и эксклюзивным представителем в России одного из крупнейших производителей разъемов военного и аэрокосмического назначения «JONHON», а так же официальным дистрибьютором и эксклюзивным представителем в России производителя высокотехнологичных и надежных решений для передачи СВЧ сигналов «FORSTAR».



## JONHON

«JONHON» (основан в 1970 г.)

Разъемы специального, военного и аэрокосмического назначения:

(Применяются в военной, авиационной, аэрокосмической, морской, железнодорожной, горно- и нефтедобывающей отраслях промышленности)

«FORSTAR» (основан в 1998 г.)

ВЧ соединители, коаксиальные кабели,  
кабельные сборки и микроволновые компоненты:

(Применяются в телекоммуникациях гражданского и специального назначения, в средствах связи, РЛС, а так же военной, авиационной и аэрокосмической отраслях промышленности).



Телефон: 8 (812) 309-75-97 (многоканальный)

Факс: 8 (812) 320-03-32

Электронная почта: [ocean@oceanchips.ru](mailto:ocean@oceanchips.ru)

Web: <http://oceanchips.ru/>

Адрес: 198099, г. Санкт-Петербург, ул. Калинина, д. 2, корп. 4, лит. А