



# MATRIX Mercury

Nanopower Energy Harvesting Synchronous Boost Converter with Microwatt Cold-Start, Input Impedance Matching and Regulated Output

## DESCRIPTION

MATRIX Mercury is a family of highly integrated DC/DC boost converters that are ideal for harvesting and managing surplus energy from extremely low input voltage sources such as TEGs (thermoelectric generators) and thermopiles.

The patented transformer reuse topology works as a flyback converter, and can operate from input power as little as a few microwatts. The unique impedance matching feature presents a constant impedance load and enables the highest efficiency energy harvesting across the entire operating range of input voltages.

There are multiple input protection voltage options available based on the ratio of the transformer. The 8-bit on-chip ADC detects when  $V_{oc}$  exceeds the programmed limit and turns off the input to ensure reliable operation. The result of the measurement is transmitted via a two-wire interface to a micro-controller.

There are many maximum output voltages between 2V to 5V available. Integrated VOUT regulation prevents voltage overshoot, securing reliable operation with various battery types.

Mercury is available in a 10-lead, 3mm x 3mm DFN package and a 9-bump 1.2mm x 1.0mm WLP package. Operation temperature is -40°C to +85°C.

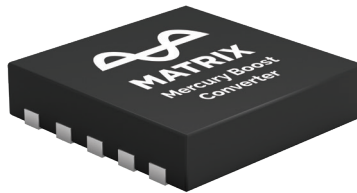

## EXAMPLE APPLICATION: HEALTH MONITORING WEARABLE

Figure 1:  
Example Application circuit

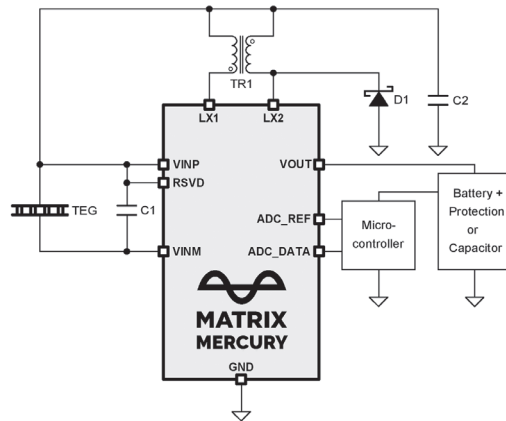
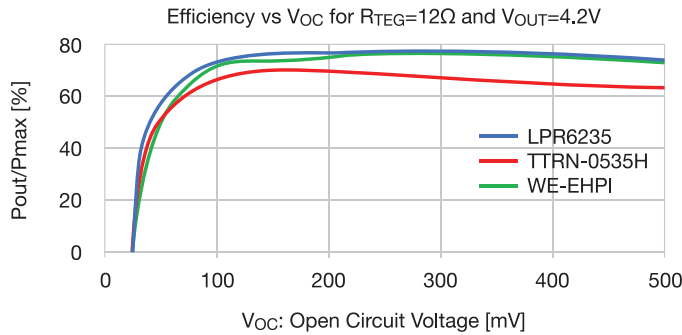

Figure 2:  
Example application efficiency chart



- C1: 100µF/0805, 2.5V, C2: 4.7µF/0402 6.3V. D1: Nexperia BAS70L/DFN1006-2

- Cold-start voltage is  $V_{oc}=24mV$  which gives a  $P_{MAX}=12µW$ .

- Overall Efficiency is defined as  $P_{OUT}/P_{MAX}$  where  $P_{MAX}=V_{oc}^2/(4 \times R_{TEG})$ .

## FEATURES & BENEFITS

### A new low to lead a new era of energy harvesting

- $V_{IN}$  as low as 10mV ( $V_{oc}=20mV$ ,  $R_{IN}=5Ω$ ) to  $V_{OUT}$  of up to 5V
- $V_{IN}$  as low as 6mV ( $V_{oc}=12mV$ ,  $R_{IN}=5Ω$ ) to  $V_{OUT}$  of 3V
- Ultra-Low quiescent current of 700nA ensures the fastest possible charge times of the output reservoir capacitor.
- Cold-start with  $V_{oc}=16mV$  ( $R_{IN}=5Ω$ , 1:100 transformer)

### A new high of efficiency to maximize power transfer

- Up to 80% peak conversion efficiency
- Near-ideal impedance matching with input source

### Minimized power leakage with active input monitoring

- Built-in  $V_{oc}$  monitoring through an 8-bit ADC
- True shutdown by disconnecting output when  $V_{oc}$  is below startup requirement securing zero power leakage.

### Miniaturized solution size

- Three external components are required: input capacitor, output capacitor and a transformer
- Optional Schottky diode for efficiency improvement
- Compact WLP package available

## APPLICATIONS

- Thermal Energy Harvesting (TEG, Thermopiles)
- Industrial Remote Sensors
- Portable Medical
- Consumer Wearables
- Smart Meters
- Building Automation
- Predictive Maintenance

## ABSOLUTE MAXIMUM RATINGS

RSVD, VINP, VOUT: -0.5V to 7V

ADC\_REF, ADC\_DATA: -0.5V to 7V

LX2: -0.5V to 52V (62V for  $T \geq 0^{\circ}\text{C}$ )

LX1, VINM: VINP-2.3V to VINP+0.5V

Operating Temperature Range:  $-40^{\circ}\text{C}$  to  $85^{\circ}\text{C}$

Storage Temperature Range:  $-55^{\circ}\text{C}$  to  $150^{\circ}\text{C}$

Electrostatic discharge to ANSI/ESDA/JEDEC JS-001-2014 for HBM:  $\pm 2\text{kV}$  for all pins

## PACKAGE AND PINOUT

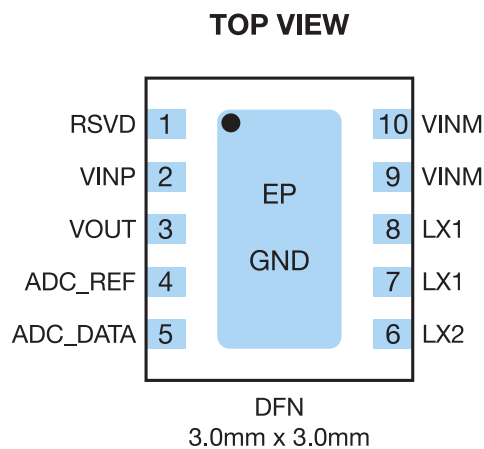

Figure 3:  
Package diagram for 10-lead, 3mm x 3mm DFN

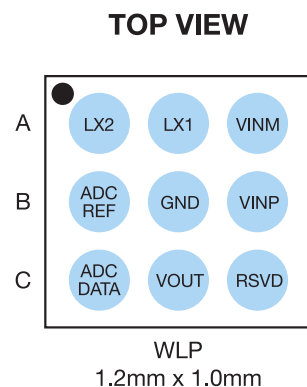

Figure 4:  
Package diagram for 9-bump 1.2mm x 1.0mm  
WLP. Horizontal pitch is 0.4mm  
and the vertical pitch is 0.35mm.

## PIN DESCRIPTION

Pin Name	Pin Number		Description
	WLP	DFN	
RSVD	C3	1	Reserved. Connect to VINP during normal operation
VINP	B3	2	Positive potential of the input voltage
VOUT	C2	3	Output connection
ADC_REF	B1	4	Reference clock of the ADC measurement. Connect to GND if not used
ADC_DATA	C1	5	Data output of the ADC measurement. Connect to GND if not used
LX2	A1	6	Connection of LX2 of the transformer
LX1	A2	7, 8	Connection of LX1 of the transformer
VINM	A3	9, 10	Negative potential of the input voltage
GND	B2	EP	Ground connection

## ORDERING INFORMATION

To secure the highest efficiency through impedance matching and adapt to a wide spectrum of system design considerations, we offer customizable product parameters:

①②: Input impedance ( $R_{IN}$ ):  $\Omega$

③④⑤: Transformer inductance (L1):  $\mu\text{H}$

⑥: Transformer turns ratio: P (1:20), Q (1:50), S (1:100)

⑦⑧: Maximum output voltage  $V_{OUT,MAX}$ : V

Part Number	Package Type	Dimension	Temp Grade
MCRY①②-③④⑤⑥-⑦⑧DI	DFN	3x3mm <sup>2</sup>	Industrial: -40°C to +85°C
MCRY①②-③④⑤⑥-⑦⑧WI	WLP	1.2x1.0mm <sup>2</sup>	Industrial: -40°C to +85°C

A Letter T can be added at the end of the part number to order Tape & Reel

For example:

Part Number	Rel	L1	N	Vout,max	Package	Shipping
MCRY75-125Q-46DIT	7.5 $\Omega$	12.5 $\mu\text{H}$	1:50	4.6 V	DFN	Tape & Reel
MCRY12-125Q-46WI	12 $\Omega$	12.5 $\mu\text{H}$	1:50	4.6 V	WLP	Tray
MCRY23-075P-25WI	23 $\Omega$	7.5 $\mu\text{H}$	1:20	2.5 V	WLP	Tray

The following standard versions are available.

Part Number	Rel	L1	N	Vout,max	Package	Shipping	Marking
MCRY12-125Q-42DI	12 $\Omega$	12.5 $\mu\text{H}$	1:50	4.2 V	DFN	Bulk	CS59B
MCRY12-125Q-42DIT	12 $\Omega$	12.5 $\mu\text{H}$	1:50	4.2 V	DFN	Tape & Reel	CS59B

Sample stock is held on standard versions only. Standard versions have an order increment of 5000 pieces. Contact MATRIX [info@matrixindustries.com](mailto:info@matrixindustries.com) for availability of nonstandard versions.

# BLOCK DIAGRAM

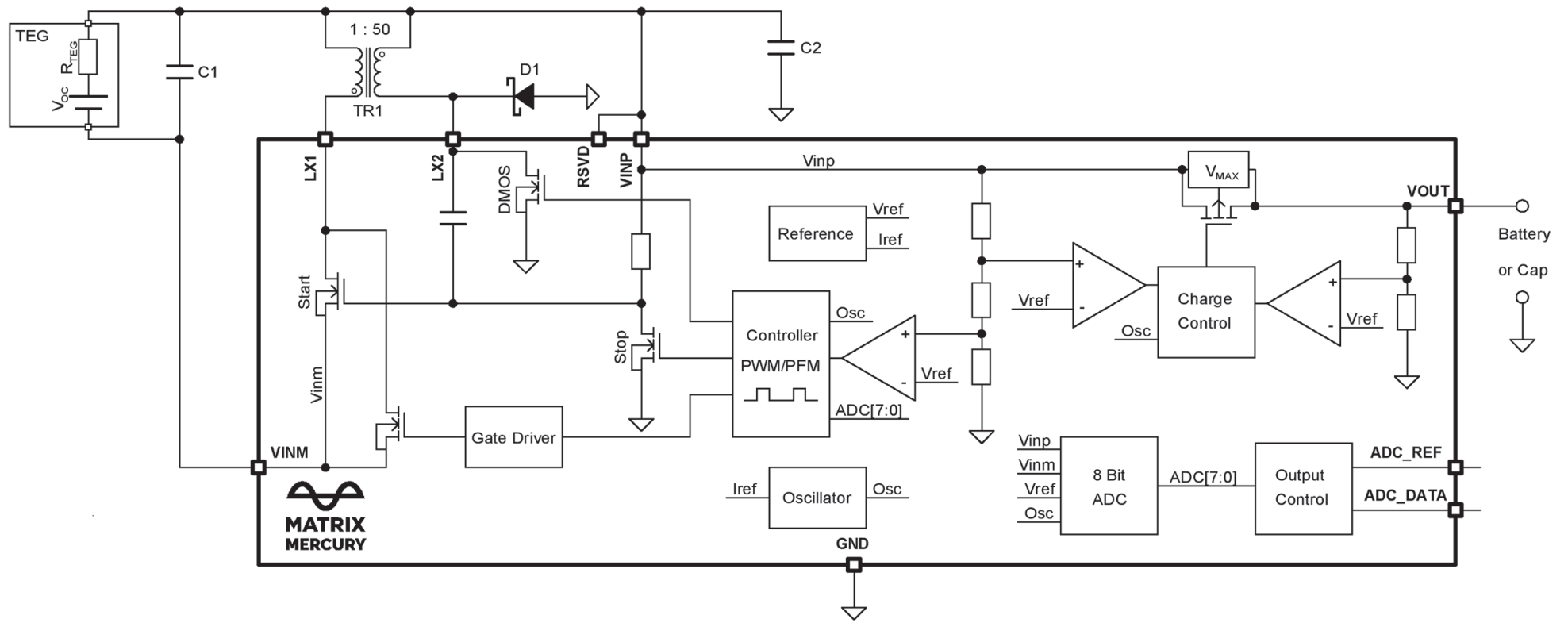

Figure 5: Block Diagram

# ELECTRICAL CHARACTERISTICS

**Table 1.** Electrical Characteristics of MCRY12-125Q-42\*1

RTEG=12Ω; GND=0V; C1=100μF; C2=4.7μF; D1=BAS70; TR1=LPR6235-123Q;  
Tamb=23°C; unless otherwise specified.

Symbol	Parameter	Conditions	Min	Typ	Max	Unit
<b>Input Voltage</b>						
V <sub>OC,CS</sub>	open circuit voltage for cold start <sup>[1]</sup>	C2 discharged; V <sub>OUT</sub> ≤ 3V	-	24	-	mV
V <sub>OC,MIN,OUT=3V</sub>	minimum Voc for charging, after cold-start	V <sub>OUT</sub> = 3V	-	18	-	mV
V <sub>OC,MIN,OUT=4.2V</sub>		V <sub>OUT</sub> =4.2V	-	25	-	mV
V <sub>OC,MAX</sub>	maximum open circuit, voltage for charging <sup>[2]</sup>		490	500	510	mV
V <sub>OC</sub>	V <sub>OC</sub> , operation range	T <sub>amb</sub> = -40°C to +85°C	0	-	1.98	V
<b>Output voltage</b>						
V <sub>OUT,MAX</sub>	maximum V <sub>OUT</sub> voltage for charging <sup>[3]</sup>		4.17	4.2	4.23	V
		T <sub>amb</sub> = -40°C to +85°C	4.15	4.2	4.25	V
V <sub>OUT</sub>	V <sub>OUT</sub> , operation range	T <sub>amb</sub> = -40°C to +85°C	0	-	5.5	V
<b>Supply current and efficiency</b>						
I <sub>Q</sub>	quiescent current <sup>[4]</sup>	V <sub>OUT</sub> = 4.2V; V <sub>OC</sub> = 510mV	-	0.7	1.0	μA
I <sub>LEAK</sub>	leakage current	V <sub>OUT</sub> = 4.15V; V <sub>OC</sub> = 0V	-	5	50	nA
		T <sub>amb</sub> = +85°C	-	20	200	nA
<b>Flyback converter</b>						
f	switching frequency		19	20	21	kHz
DC <sub>SW1</sub>	LX1-switch duty-cycle	V <sub>OUT</sub> = 4V	19	20	21	%
t <sub>ON,SW2</sub>	LX2-switch (DMOS) on-time <sup>[5]</sup>	V <sub>IN</sub> -V <sub>INM</sub> = 128mV; V <sub>OUT</sub> = 4V	-	-	12	μs
<b>ADC</b>						
	resolution		-	8	-	Bits
V <sub>LSB</sub>	size of least significant bit (LSB)		1.96	2	2.04	mV
	offset error		-1	0	1	LSB
INL	integral nonlinearity		-1	0	1	LSB
DNL	differential nonlinearity		-0.1	0	0.1	LSB
t	time between two measurements		1.22	1.23	1.24	s
t <sub>M</sub>	measurement timeout <sup>[6]</sup>		-	5.4	-	ms
<b>Switches</b>						
R <sub>SW1</sub>	resistance of the LX1-switch		-	120	-	mΩ
R <sub>SW2</sub>	resistance of the LX2-switch (DMOS)		-	20	-	Ω
R <sub>PMOS</sub>	resistance of the PMOS		-	1	-	Ω
<b>Outputs ADC_REF &amp; ADC_DATA</b>						
I <sub>OUT</sub>	output current	output = 0.4V	-	4	-	mA
t <sub>LOW</sub>	low-time of an output pulse		-	10	-	ns
C <sub>LOAD</sub>	load capacitance		-	-	20	pF
t <sub>REF</sub>	period between two reference pulses		50.7	51.2	51.7	ms
t <sub>DATA</sub>	period between two data pulses <sup>[7]</sup>		198	200	202	μs

[1] This is the open circuit voltage of the TEG which is necessary to start charging of the battery/cap. The input voltage V<sub>IN</sub> is smaller than this voltage. Depending on V<sub>out</sub> the minimum open circuit voltage to charge the battery/cap can be smaller or higher after cold-start – see efficiency graphs.

[2] The open circuit voltage is measured by the ADC and when V<sub>OC,MAX</sub> is exceeded, the flyback converter is stopped to avoid over voltage on LX2 pin. The pin tolerates higher voltages within the V<sub>OC</sub> range.

[3] The V<sub>OUT</sub> voltage is supervised by a comparator and when V<sub>OC,MAX</sub> is exceeded, the flyback converter is stopped to avoid over voltage on V<sub>OUT</sub> pin. The pin tolerates higher voltages within the V<sub>OUT</sub> range.

[4] With an open circuit voltage of 510mV the flyback converter is stopped and the PMOS is closed to prevent switching. In this state it is possible to measure the internal quiescent current into V<sub>OUT</sub> pin.

[5] The on-time of the DMOS depends on the input voltage V<sub>IN</sub> and V<sub>OUT</sub>.

[6] The flyback converter is stopped to load C1 to the open circuit voltage. At the end of the timeout the measurement is done.

[7] The first data pulse starts 200μs after the reference pulse. The time between the last data pulse and the next reference pulse depends on the ADC measurement – see ADC output description.

# TYPICAL PERFORMANCE CHARACTERISTICS

$T_{amb} = 23^{\circ}\text{C}$ ; unless otherwise specified.

Efficiency vs  $V_{OC}$  for MCRY12-125Q-42\*1 with  $R_{TEG}=12\Omega$  and  $V_{OUT}=4.2\text{V}$

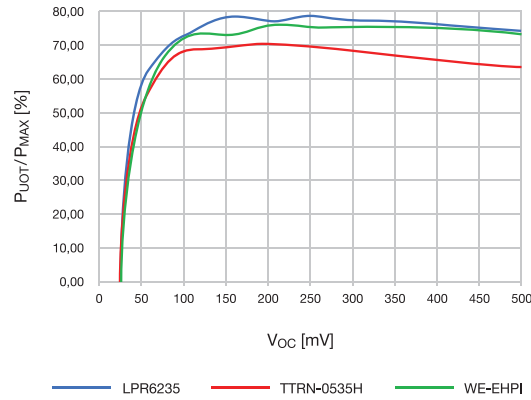

Efficiency vs  $V_{OC}$  for MCRY12-125Q-42\*1 with  $R_{TEG}=12\Omega$  and  $V_{OUT}=3.0\text{V}$

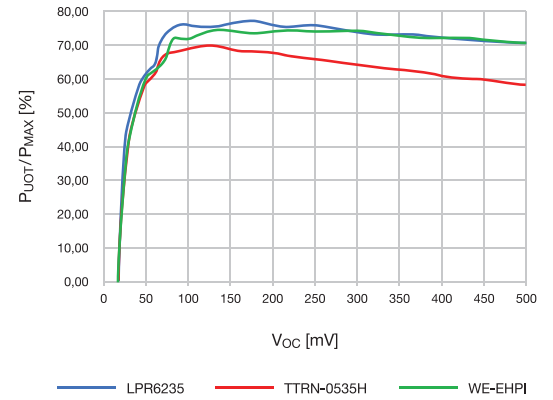

Switching Frequency vs  $T_{amb}$  for MCRY12-125Q-42\*1

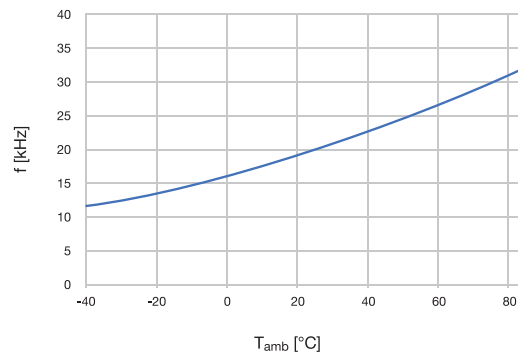

LX1-switch on-time vs  $T_{amb}$  for MCRY12-125Q-42\*1

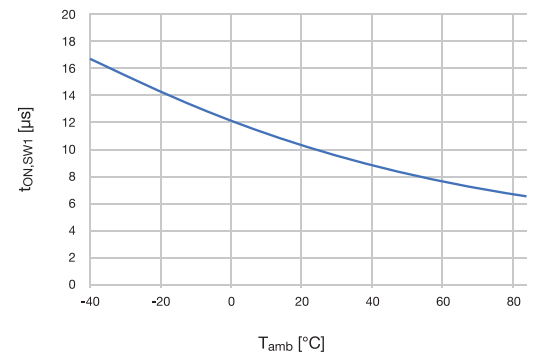

$R_{IN}$  (calculated from  $t_{ON,SW1}$  and  $f$ ) vs  $T_{amb}$  for MCRY12-125Q-42\*1 and  $L1=12.5\mu\text{H}$

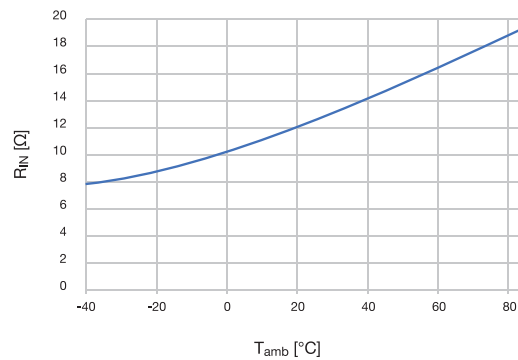

# OPERATION

## INTRODUCTION

The Mercury family of boost converters is designed to make thermal energy harvesting not only possible, but also efficient and reliable. Mercury is ideal for harvesting and managing surplus energy from extremely low input voltage sources such as thermoelectric generators (TEGs) and thermopiles. The energy harvested can be used to charge a standard capacitor, supercapacitor or rechargeable battery, ensuring reliable system operation during high current bursts and even eliminate the need for battery changes. Mercury is designed with the highest efficiency and lowest external component counts in mind. Figure 5 illustrates the internal block diagram of Mercury.

## START-OSCILLATOR

The Start-Oscillator is formed from the external step-up transformer TR1, a native Start-NMOS, and an internal coupling capacitor at LX2 which is biased by an internal resistor to the voltage at VINP. This resonant Start-Oscillator is utilized only during cold-start.

## RECTIFIER

An optional external diode D1 rectifies the AC voltage on the secondary winding of the transformer TR1, and the rectified current charges the external capacitor C2. If D1 is not provided, the rectifier circuit will use the body diode of the DMOS instead. Use of an external Schottky diode D1 is strongly recommended for improved cold-start and low-power efficiency.

## VINP AND VINM

Mercury uses a unique top-referenced boost converter topology. VINP is connected to the positive potential  $V_{IN+}$  of the input and the external capacitor C2. Once C2 is charged by the Rectifier, the GND pin potential will sink below the potential  $V_{IN-}$  at VINM. Do not connect VINM to GND.

## REFERENCE

Mercury includes a precision nanopower Reference to accurately regulate output voltages. It also provides a stable reference current for the internal Oscillator. The Reference becomes active as soon as the voltage at the external capacitor C2 exceeds 1V.

## OSCILLATOR

Mercury also includes a trimmed nanopower Oscillator which has a positive temperature coefficient. This design helps to maintain impedance matching of RIN to RTEG across the entire operating temperature range (see INPUT IMPEDANCE AND LOAD MATCHING). The Oscillator also becomes active as soon as the voltage at the external capacitor C2 exceeds 1V.

## FLYBACK CONVERTER

The Controller is enabled when a comparator detects sufficient voltage at the external capacitor C2. Normal operation begins with halting the Start-Oscillator using the Stop-NMOS. During normal operation, the transformer and rectifier are reused in a Flyback Converter topology. A bootstrapped gate driver turns on the LX1 switch using pulse width modulation (PWM) at constant duty cycle until the maximum output voltage is reached. Once this happens, the gate driver switches to a pulse frequency modulation (PFM) scheme to maintain the output voltage.

## ADC

An 8-bit analog-to-digital converter (ADC) measures the open circuit voltage every second. Just before each measurement, the Flyback Converter is stopped temporarily to charge the input capacitor C1 via RTEG up to  $V_{OC}$ . The measurement result is used to determine the gate driver settings, whether the DMOS should be used, and to stop the Flyback Converter at high  $V_{OC}$  to prevent damage to the chip.

## SYNCHRONOUS RECTIFIER

A 50V DMOS switch is used in parallel to the Rectifier to optimize Mercury's efficiency at input power levels above approximately 100 $\mu$ W.

## CHARGE CONTROL

When the voltage at the external capacitor C2 is higher than the output voltage  $V_{OUT}$ , the Charge Control closes the PMOS. This is done in such a way that the current is limited and the voltage at C2 always stays above 1.8V. If the ADC measurement result shows that the input power is insufficient to charge the output, the PMOS is opened and Mercury powers down. In this state, only a very low leakage current  $I_{LEAK}$  enters the  $V_{OUT}$  pin, and stored energy in the battery or capacitor is not dissipated into Mercury.

## $V_{MAX}$ DETECTION

Since either side of the PMOS can be presented with a higher potential than the other, the  $V_{MAX}$  detector switches the higher voltage into the PMOS bulk to avoid dissipating current through a body diode.

## OUTPUT CONTROL

The ADC measurement result is transmitted on two open-drain outputs via a serial protocol.

## INTRODUCTION

Mercury is a next-generation energy harvester for very low input voltage sources, converting their outputs to usable levels to power sensors, microprocessors, and wireless transmitters. Such applications generally require much higher voltages and peak powers than the input source can provide. Mercury harvests energy over an extended period of time to enable short high power bursts for data acquisition, processing, and transmission, whilst minimizing losses from self-consumption and leakage. The bursts must occur at a sufficiently low duty cycle such that the total energy output during the burst does not exceed the total energy input over the accumulation duration between bursts. For many applications, this duration could range from seconds, to minutes, to hours, or more.

## INPUT VOLTAGE SOURCES

Mercury is optimized for operation from low voltage sources such as thermopiles or thermoelectric generators (TEGs). In any given application, the minimum open circuit voltage ( $V_{OC}$ ) required will depend on the load power drawn and the internal DC resistance ( $R_{TEG}$ ) of the voltage source.

## INPUT IMPEDANCE AND LOAD MATCHING

Once started, Mercury's flyback converter is designed to operate in discontinuous current mode (DCM). The input resistance  $R_{IN}$  of a DCM flyback converter, without losses and parasitic effects, can be calculated in the following way:

$$R_{IN} = 2 \times L1 / (t_{ON,SW1}^2 \times f)$$

$R_{IN}$  of a DCM flyback converter is independent of  $V_{OC}$  and can be set by controlling its on-time  $t_{ON,SW1}$  and frequency  $f$ , for a given transformer with primary inductance  $L1$ .

Due to the coupling between the thermal and electrical systems in the TEG, its effective output resistance  $R_{TEG}$  is generally higher than the AC resistance  $R_{TEG,AC}$  measured under thermal adiabatic conditions. The exact relationship is a function of the current drawn from and the heat flux passing through the TEG. Under simultaneous thermal and electrical matching conditions, when both electrical and thermal circuits are optimized for maximum power throughput:

$$R_{TEG} = R_{TEG,AC} \times \sqrt{1 + ZT}$$

$$K_{TEG} = K_{TEG,OC} \times \sqrt{1 + ZT}$$

$R_{TEG}$  of a thermally and electrically matched TEG is larger than  $R_{TEG,AC}$  scaled by a factor dependent on the dimensionless figure-of-merit  $ZT$  of the thermoelectric. At the same time, the effective thermal conductance  $K_{TEG}$  is scaled by the same factor over the thermal conductance  $K_{TEG,OC}$  measured under electrical open circuit conditions. While optimized matching conditions are not easy to attain, it is a fair approximation in many cases where effort is made to match the thermal resistance. Using a  $ZT$  value of 0.7 for the TEG:

$$R_{TEG} = 1.3 \times R_{TEG,AC}$$

$$K_{TEG} = 1.3 \times K_{TEG,OC}$$

When the flyback converter is optimally matched, the input voltage  $V_{IN} = V_{IN+} - V_{IN-} = V_{OC}/2$ . This is accomplished by choosing the input resistance:

$$R_{IN} = R_{TEG}$$

In most TEGs,  $R_{TEG}$  increases with temperature. For consistent matching across the entire operating temperature range,  $R_{IN}$  must increase with temperature in the same manner. This is achieved by designing appropriate temperature coefficients for the oscillator frequency  $f$  and the on-time  $t_{ON,SW1}$  (see TYPICAL PERFORMANCE CHARACTERISTICS).

## EFFICIENCY

For a given  $V_{OC}$  and  $R_{TEG}$  the maximum input power is:

$$P_{MAX} = V_{OC}^2 / (4 \times R_{TEG})$$

The efficiency curves in TYPICAL PERFORMANCE CHARACTERISTICS show the output power  $P_{OUT}$  relative to  $P_{MAX}$ , so they show the product of electrical efficiency and impedance matching.

## VOUT

A capacitor, supercapacitor or rechargeable battery may be connected to the  $V_{OUT}$  pin as a charge storage device. The device will be charged up to  $V_{OUT,MAX}$  so it is important to select the appropriate Mercury for the device. Since Mercury cannot protect a battery from over-discharge or short-circuit by an external load, a battery protection circuit is strongly recommended especially when using lithium ion batteries.



## ADC OUTPUTS

The two ADC Outputs ADC\_REF and ADC\_DATA are open drain, active low outputs and intended to be connected to GPIOs of a microcontroller. If the microprocessor includes internal pull-up resistors on the GPIOs, they can be used to define the high level of the two signals. Alternatively, external resistors may be used and a value of 47kΩ is recommended. If the ADC outputs are not used they must be connected to GND.

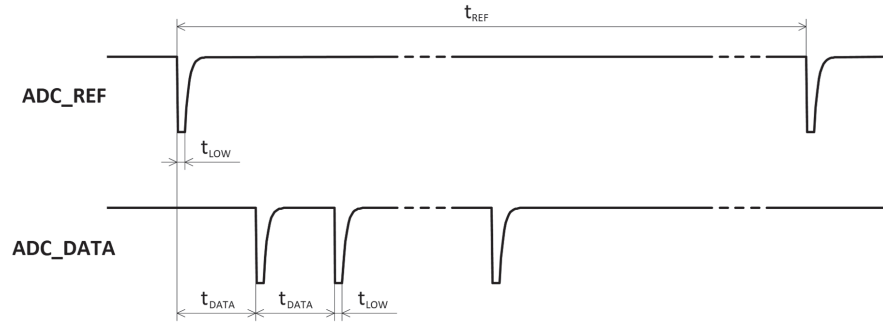

Figure 6: Timing charts of ADC Outputs

The serial transmission protocol is illustrated above. A pulse on ADC\_REF signals the start of the data transmission in each reference period t<sub>REF</sub>, during which a train of pulses is transmitted on ADC\_DATA. The open circuit voltage V<sub>OC</sub> measured by the ADC is:  $V_{OC} = n \times V_{LSB}$

V<sub>OC</sub> is the product of the number of ADC\_DATA pulses received n, and the ADC lowest significant bit (LSB) size V<sub>LSB</sub>. For example, 20 pulses with V<sub>LSB</sub> = 2mV means V<sub>OC</sub> = 40mV. If there is insufficient input power to charge the output, Mercury sends two low pulses on ADC\_REF before powering down.

## COMPONENT SELECTION

### TRANSFORMER

Every version of Mercury is optimized for a specific transformer configuration. The following transformers are recommended:

Part number	Vendor	Part number	L1	Turns ratio	Size (mm)
MCRY12-125Q-42*1	Coilcraft	LPR6235-123QMR	12.5μH	1:50	6 x 6 x 3.5
	Tokyocoil	TTRN-0535H	12.5μH	1:50	5 x 5 x 3.5
	Würth	WE-EHPI 74488540120	13μH	1:50	6 x 6 x 4.0

### INPUT CAPACITOR C1

The input capacitor C1 serves as a charge bank to reduce the input voltage ripple and ohmic loss in the TEG. The capacitor size depends on the current amplitude in the transformer primary, the TEG resistance R<sub>TEG</sub> and the primary inductance L1.

X5R or X7R ceramic capacitors (MLCC) which have low effective series resistance (ESR) and a minimum voltage rating of 2.5V are recommended for C1. The values recommended below provide maximum efficiency and no larger capacitors should be used. Larger capacitors at C1 cause the timeout for the V<sub>OC</sub> measurement to occur before V<sub>OC</sub> is settled – this can increase the measurement time and reduce efficiency. Alternatively, a Tantalum capacitor with ESR < 10mΩ can be used, but the nominal capacitance used should be half of the following recommended MLCCs.

Part number	Vendor	Part number	C	Ratings	Size (mm)
MCRY12-125Q-42*1	Murata	GRM21BR60E107ME15	100μF	X5R 2.5V	2 x 1.25 x 1.25
	Taiyo Yuden	JMK316BJ107ML-T	100μF	X5R 6.3V	3.2 x 1.6 x 1.6

## CAPACITOR C2

A 4.7 $\mu$ F X5R or X7R MLCC with low ESR and a minimum voltage rating of 6.3V is recommended.

Part number	Vendor	Part number	C	Ratings	Size (mm)
MCRY*	Murata	GRM155R60J475ME87	4.7 $\mu$ F	X5R 6.3V	1.0 x 0.5 x 0.5
	Taiyo Yuden	JMK107BJ475KA-T	4.7 $\mu$ F	X5R 6.3V	1.6 x 0.6 x 0.6

## DIODE D1

A Schottky diode with small capacitance, low reverse current and high voltage rating is recommended.

Part number	Vendor	Part number	C <sub>D</sub>	I <sub>R</sub>	V <sub>R</sub>	Size (mm)
MCRY12-125Q-42*1	Nexperia	BAS70L	2pF	100nA	70V	1.0 x 0.6 x 0.5
	Vishay	BAS70-02V-V-G	2pF	100nA	70V	1.6 x 0.8 x 0.7

## PCB LAYOUT GUIDELINES

### TRANSFORMER

Mercury's flyback converter runs at low power levels and at a rather low switching frequency, so it does not depend as critically on careful printed circuit board (PCB) layout as with many other DC/DC converters. However, there are several important points to consider. Due to the very low input voltages encountered with this circuit, voltage drops due to stray resistance in the connections to VINM, LX1, and the transformer primary should be minimized. Any parasitic resistances in the primary winding conduction path will lower efficiency, increase cold-start voltage, and result in slower charge times. Additionally, due to the low charge currents available at VOUT, any source of leakage current on the output path must be minimized. Finally, parasitic inter-winding capacitance between the transformer windings can cause severe degradation in Mercury's performance, so take particular care to connect the primary winding to LX1 and the secondary winding to LX2 in the following way:

Vendor	Part number	Mercury LX1	Mercury LX2
Coilcraft	LPR6235	Pin 1	Pin 3
Tokyocoil	TTRN-0535H	Pin 1	Pin 5
Würth	WE-EHPI	Pin 2	Pin 4

An example board layout is shown below:

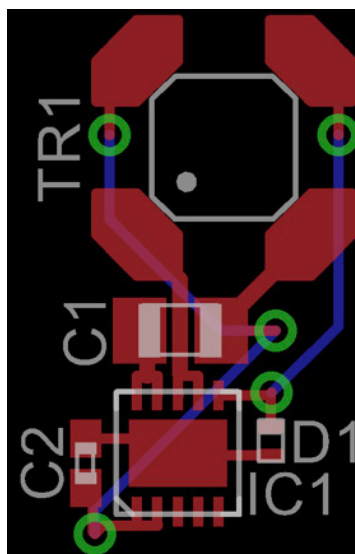

Figure 7: Example Component Placement for Two-Layer PCB using LPR6235 (DFN Package)

## PACKAGE DIMENSIONS

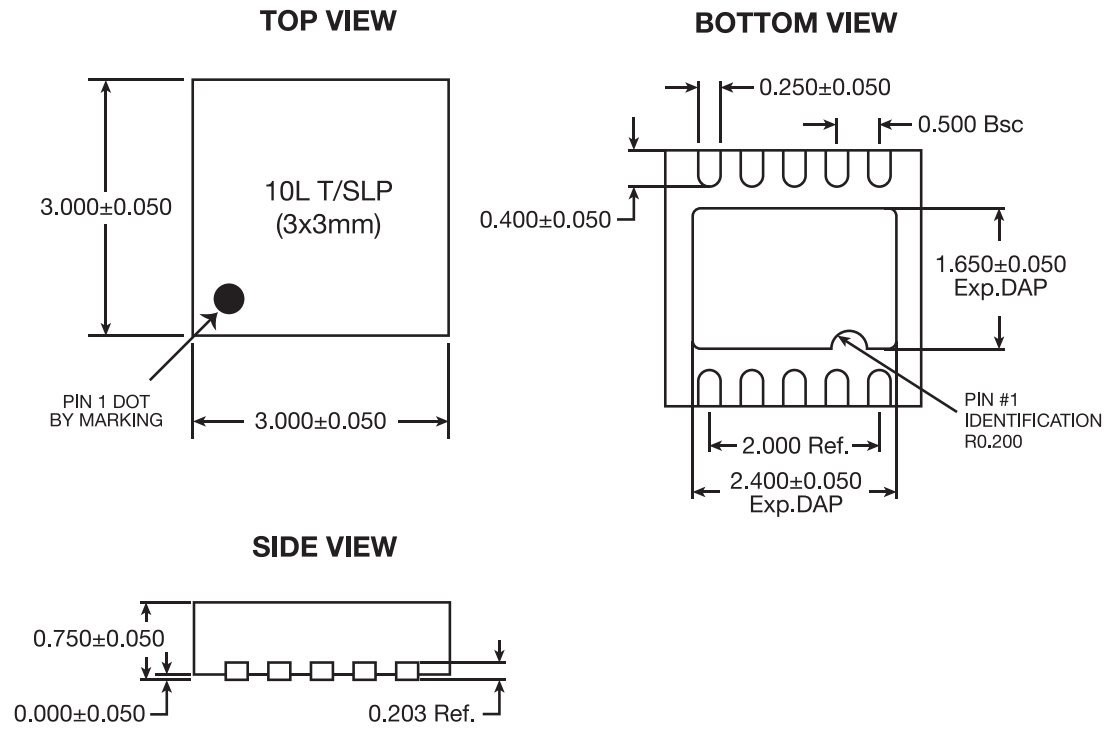

Figure 8: Package drawing of 10-lead, 3mm × 3mm DFN

## REVISION HISTORY

Revision	Date	Description
*A	Jan 2019	Preliminary Datasheet Release
*B	Feb 2019	Production release

## DISCLAIMER

ALL PRODUCT, PRODUCT SPECIFICATIONS AND DATA ARE SUBJECT TO CHANGE WITHOUT NOTICE TO IMPROVE RELIABILITY, FUNCTION OR DESIGN OR OTHERWISE.

MATRIX Industries, Inc., its affiliates, agents, and employees, and all persons acting on its or their behalf (collectively, "MATRIX"), disclaim any and all liability for any errors, inaccuracies or incompleteness contained in any datasheet or in any other disclosure relating to any product.

MATRIX makes no warranty, representation or guarantee regarding the suitability of the products for any particular purpose or the continuing production of any product. To the maximum extent permitted by applicable law, MATRIX disclaims (i) any and all liability arising out of the application or use of any product, (ii) any and all liability, including without limitation special, consequential or incidental damages, and (iii) any and all implied warranties, including warranties of fitness for particular purpose, non-infringement and merchantability.

Statements regarding the suitability of products for certain types of applications are based on MATRIX's knowledge of typical requirements that are often placed on MATRIX products in generic applications. Such statements are not binding statements about the suitability of products for a particular application. It is the customer's responsibility to validate that a particular product with the properties described in the product specification is suitable for use in a particular application. Parameters provided in datasheets and / or specifications may vary in different applications and performance may vary over time. All operating parameters, including typical parameters, must be validated for each customer application by the customer's technical experts. Product specifications do not expand or otherwise modify MATRIX's terms and conditions of purchase, including but not limited to the warranty expressed therein.

Except as expressly indicated in writing, MATRIX products are not designed for use in medical, life-saving, or life-sustaining applications or for any other application in which the failure of the MATRIX product could result in personal injury or death. Customers using or selling MATRIX products not expressly indicated for use in such applications do so at their own risk. Please contact authorized MATRIX personnel to obtain written terms and conditions regarding products designed for such applications.

No license, express or implied, by MATRIX or otherwise, to any intellectual property rights is granted by this document or by any conduct of MATRIX. Product names and markings noted herein may be trademarks of their respective owners.

Компания «Океан Электроники» предлагает заключение долгосрочных отношений при поставках импортных электронных компонентов на взаимовыгодных условиях!

Наши преимущества:

- Поставка оригинальных импортных электронных компонентов напрямую с производств Америки, Европы и Азии, а так же с крупнейших складов мира;
- Широкая линейка поставок активных и пассивных импортных электронных компонентов (более 30 млн. наименований);
- Поставка сложных, дефицитных, либо снятых с производства позиций;
- Оперативные сроки поставки под заказ (от 5 рабочих дней);
- Экспресс доставка в любую точку России;
- Помощь Конструкторского Отдела и консультации квалифицированных инженеров;
- Техническая поддержка проекта, помощь в подборе аналогов, поставка прототипов;
- Поставка электронных компонентов под контролем ВП;
- Система менеджмента качества сертифицирована по Международному стандарту ISO 9001;
- При необходимости вся продукция военного и аэрокосмического назначения проходит испытания и сертификацию в лаборатории (по согласованию с заказчиком);
- Поставка специализированных компонентов военного и аэрокосмического уровня качества (Xilinx, Altera, Analog Devices, Intersil, Interpoint, Microsemi, Actel, Aeroflex, Peregrine, VPT, Syfer, Eurofarad, Texas Instruments, MS Kennedy, Miteq, Cobham, E2V, MA-COM, Hittite, Mini-Circuits, General Dynamics и др.);

Компания «Океан Электроники» является официальным дистрибьютором и эксклюзивным представителем в России одного из крупнейших производителей разъемов военного и аэрокосмического назначения «JONHON», а так же официальным дистрибьютором и эксклюзивным представителем в России производителя высокотехнологичных и надежных решений для передачи СВЧ сигналов «FORSTAR».



## JONHON

«JONHON» (основан в 1970 г.)

Разъемы специального, военного и аэрокосмического назначения:

(Применяются в военной, авиационной, аэрокосмической, морской, железнодорожной, горно- и нефтедобывающей отраслях промышленности)

«FORSTAR» (основан в 1998 г.)

ВЧ соединители, коаксиальные кабели,  
кабельные сборки и микроволновые компоненты:

(Применяются в телекоммуникациях гражданского и специального назначения, в средствах связи, РЛС, а так же военной, авиационной и аэрокосмической отраслях промышленности).



Телефон: 8 (812) 309-75-97 (многоканальный)

Факс: 8 (812) 320-03-32

Электронная почта: [ocean@oceanchips.ru](mailto:ocean@oceanchips.ru)

Web: <http://oceanchips.ru/>

Адрес: 198099, г. Санкт-Петербург, ул. Калинина, д. 2, корп. 4, лит. А