

IBS SYS FOC ASSEMBLY

INTERBUS Fiber Optic Installation Guidelines

AUTOMATIONWORX

Data Sheet
5570_en_03

© PHOENIX CONTACT - 02/2007

Bus Connection Using Fiber Optics (FO)

Data transmission via fiber optics is preferred if the physical limits of copper-based data communication have been reached.

Fiber optic transmission paths offer the following features in particular:

- Immunity to interference under extreme electromagnetic interference
- High-quality electrical isolation between communication units
- Transmission distances of up to several kilometers
- High transmission speeds

Nothing changes for the user when fiber optic technology is used. Bus topology, configuration, and programming of the system remain the same. This enables the combined use of fiber optics, copper cables, and other transmission media in a single system.

Fiber optics are available in the form of HCS and polymer fiber cables.

- **Polymer fiber cables**

Depending on the system used, polymer fiber cables are used for distances up to 70 meters.

- **HCS cables**

Depending on the system used, HCS cables are used for distances up to 400 meters. These cables feature extremely low fiber attenuation.

The following installation guidelines must be observed as bending radii that are too small, a tensile load that is too high, and squeezing the cable result in increased attenuation of the transmitted optical power. This can also cause permanent damage to the cable. Increased attenuation may shorten the maximum possible transmission path and reduce transmission quality.



Technical modifications reserved.



Fiber optic cables must only be installed and assembled by specialist personnel.



Make sure you always use the latest documentation.
It can be downloaded at www.download.phoenixcontact.com.
A conversion table is available on the Internet at
www.download.phoenixcontact.com/general/7000_en_00.pdf.



This data sheet is valid for all products listed on the following pages:

Table of Contents

Ordering Data	3
Technical Data	5
System Differentiation of 50 m and 70 m Systems and OPC Systems	6
Installation Guidelines for Polymer Fiber Cables (980/1000 µm).....	7
Installation Guidelines for HCS Cables (200/230 µm)	8
Installing Fiber Optic Cables	9
Assembling Polymer Fiber Cables.....	13
Assembling F-SMA Connectors.....	15
Polishing F-SMA Connectors.....	16
Assembling QUICK F-SMA Connectors	17
Assembling Rugged Line Connectors.....	18
Assembling HCS Fibers	20
Assembling the SC-RJ Connector	27
Power Measurement After Initial Installation.....	28
Implementing Optical Diagnostics for the OPC System With CMD	33
Reduction of Distances in Special Applications	34
Fiber Optic Cable Specifications	36
Checklist for Complete Installation of Fiber Optic Cables.....	39
Fiber Optic Measured Value Protocol.....	40

Ordering Data



Phoenix Contact recommends the use of Phoenix Contact cables together with Phoenix Contact components. Specific system properties (e.g., transmission lengths) can only be ensured for these cable types.

These cables can be assembled very easily using Phoenix Contact quick mounting connectors. In addition, pre-assembled cables can be supplied in any length.

Polymer Fibers

Description	Type	Order No.	Pcs./Pck.
Polymer fiber cable, 980/1000 µm, sold by the meter without connectors			
For permanent indoor installation	PSM-LWL-KDHEAVY-980/1000	2744319	
Heavy version, for permanent indoor installation	PSM-LWL-RUGGED-980/1000	2744322	
Heavy version, highly flexible, for drag chain applications indoors	PSM-LWL-RUGGED-FLEX-980/1000	2744335	
F-SMA connector set for polymer fiber cable with bend protection	PSM-SET-FSMA/4-KT	2799720	4
F-SMA connector set for polymer fiber cable	PSM-SET-FSMA-LINK/2	2799416	2
SC-RJ connector set for polymer fiber cable	PSM-SET-SCRJ-DUP/2-POF	2708656	2 duplex connectors
Rugged Line bus connector for polymer fibers	IBS RL PLUG-LK/POF	2731076	1
QUICK F-SMA connector	Q-FSMA-KT	1885994	1
Assembly kit for polymer fibers	PSM-POF-KONFTOOL	2744131	1
Polishing set (polymer fiber)	PSM-SET-FSMA-POLISH	2799348	1
Stripping knife	KAMES LWL	1206146	1
Stripping pliers	PSM-FO-STRIP	2744199	1
Fiber cutter	IBS RL FOC	2725147	1
Measuring device case	PSM-FO-POWERMETER	2799539	1

HCS Fibers

Description	Type	Order No.	Pcs./Pck.
HCS cable, duplex, 200/230 µm, sold by the meter without connectors			
For permanent indoor installation	PSM-LWL-HCS-RUGGED-200/230	2799885	
For permanent outdoor installation	PSM-LWL-HCSO-200/230	2799445	
Connector set for self assembly of quick mounting connectors for HCS fibers			
F-SMA connector set	PSM-SET-FSMA/4-HCS	2799487	4
B-FOC (ST [®]) connector set	PSM-SET-B-FOC/4-HCS	2708481	4
SC-RJ connector set	PSM-SET-SCRJ-DUP/2-HCS	2313070	2 duplex connectors
Fiber optic assembly kit for HCS cables (200/230 µm)			1
With F-SMA connectors	PSM-HCS-KONFTOOL	2799526	
With B-FOC (ST [®]) connectors	PSM-HCS-KONFTOOL/B-FOC	2708465	
With SC-RJ connectors	PSM-HCS-KONFTOOL/SC-RJ	2708876	
Fiber cleaving tool			
For F-SMA connectors	PSM-HCS-CLEAVETOOL	2744995	1
For B-FOC (ST [®]) connectors	PSM-HCS-CLEAVETOOL/B-FOC	2708478	1
For SC-RJ connectors	PSM-HCS-CLEAVETOOL/SCRJ	2313122	1
Stripping knife	KAMES LWL	1206146	1
Stripping pliers for individual wires	PSM-FO-STRIP	2744199	1
Measuring device case	PSM-FO-POWERMETER	2799539	1

IBS SYS FOC ASSEMBLY

Converters

Description	Type	Order No.	Pcs./Pck.
Fiber optic converter with integrated optical diagnostics, alarm contact, for RS-422/RS-485 4-wire/INTERBUS up to 2 Mbps, termination device with one fiber optic interface (F-SMA), 660 nm, for polymer/HCS fiber cable	PSI-MOS-RS422/FO 660 E	2708342	1
Fiber optic converter with integrated optical diagnostics, alarm contact, for RS-422/RS-485 4-wire/INTERBUS up to 2 Mbps, T-coupler with two fiber optic interfaces (F-SMA), 660 nm, for polymer/HCS fiber cable	PSI-MOS-RS422/FO 660 T	2708384	1
Fiber optic converter with integrated optical diagnostics, alarm contact, for RS-422/RS-485 4-wire/INTERBUS up to 2 Mbps, termination device with one fiber optic interface (B-FOC (ST [®])), 850 nm, for HCS/glass fiber cable	PSI-MOS-RS422/FO 850 E	2708355	1
Fiber optic converter with integrated optical diagnostics, alarm contact, for RS-422/RS-485 4-wire/INTERBUS up to 2 Mbps, T-coupler with two fiber optic interfaces (B-FOC (ST [®])), 850 nm, for HCS/glass fiber cable	PSI-MOS-RS422/FO 850 T	2708397	1
Fiber optic converter, can be plugged into all controller board remote OUT interfaces, for polymer and HCS fibers, INTERBUS up to 500 kbps			
D-SUB connector, output to the right	IBS OPTOSUB-MA/M/R-LK	2750125	1
D-SUB connector, output to the left	IBS OPTOSUB-MA/M/L-LK	2750112	1
Fiber optic converter, can be plugged into all INTERBUS remote bus interfaces (self supplying), for polymer and HCS fibers, INTERBUS up to 500 kbps			
Remote OUT	OPTOSUB-PLUS-K-OUT	2799610	1
Remote IN	OPTOSUB-PLUS-K-IN	2799584	1
Fiber optic converter, can be plugged into all INTERBUS remote bus interfaces (self supplying), for glass fibers, INTERBUS up to 500 kbps			
Remote OUT	OPTOSUB-PLUS-G-OUT	2799636	1
Remote IN	OPTOSUB-PLUS-G-IN	2799623	1
Converter for an INTERBUS remote OUT interface (9-pos. D-SUB) to polymer fiber (F-SMA), 500 kbps, in a controlled OPC system	IBS OPTOSUB-MA/M/R-LK-OPC	2732635	1
Converter for an INTERBUS remote OUT interface (9-pos. D-SUB) to polymer fiber (F-SMA), 2 Mbps, in a controlled OPC system	IBS OPTOSUB-MA/M/R-LK-OPC-2MBD	2731458	1

Recommended Bend Protection Measures

Description	Manufacturer	Type	Order No.
PG screw connection with bend protection spiral	Hummel Elektrotechnik GmbH Merklinstr. 34 79183 Waldkirch Germany	HSK-FLEX-PG9 HSK-FLEX-PG11	1.293.0900.1 1.293.1100.15
Control cabinet feed-through with heavy industrial connector	PHOENIX CONTACT GmbH & Co. KG	HC-B 16-TFQ-60/ O1-PG21-S VC-M-KV-PG21- 3x7 DN	1673892 1855898
Corrugated tube and PG screw connection to connect the corrugated tube to the industrial connector	PHOENIX CONTACT GmbH & Co. KG	VC-WR 21 VC-WR-PG 21	1853609 1854954
Spiral tube	Hellermann Siemensstr. 5 25421 Pinneberg Germany	SP161 TYP II 5- 20 mm	161-20400 162-20100
Cable binder/clip	SES Giesen GmbH & Co.KG Buchholzstr. 49 51469 Bergisch Gladbach Germany	SP-06	686-210

Technical Data

F-SMA Connectors

Type	F-SMA, type 905 according to IEC 60874-2
Diameter	8.1 mm
Length including bend protection sleeve	63.3 mm (when assembled)
Suitable fiber type	200/230 µm step index with individual wires \varnothing 2.9 mm
Insertion attenuation	< 2 dB
Assembly method	Triple clamping when connector is assembled
Extraction forces	100 N, minimum
Tightening torque	0.2 Nm, minimum; 0.5 Nm, maximum
Operating temperature	-20°C ... +70°C
Insertion/withdrawal cycles	> 250
Degree of protection	IP20

B-FOC (ST[®]) Connectors

Type	B-FOC (ST [®])
Diameter	9.5 mm
Length including bend protection sleeve	63.3 mm (when assembled)
Suitable fiber type	200/230 µm step index with individual wires \varnothing 2.9 mm
Insertion attenuation	< 2 dB
Assembly method	Triple clamping when connector is assembled
Extraction forces	100 N, minimum
Tightening torque	0.2 Nm, minimum; 0.5 Nm, maximum
Operating temperature	-20°C ... +70°C
Insertion/withdrawal cycles	> 250
Degree of protection	IP20

SC-RJ Connectors

SC-RJ socket face	According to EN 50277-6-1
External connector width	16.4 mm
Connector height	11.0 mm
Length including bend protection sleeve	88.5 mm (when assembled)
Suitable fiber type	200/230 µm step index with individual wires \varnothing 2.9 mm
Insertion attenuation	< 1.5 dB
Assembly method	Triple clamping when connector is assembled
Extraction forces	85 N, minimum
Tightening torque	0.2 Nm, minimum; 0.5 Nm, maximum
Operating temperature	-20°C ... +70°C
Insertion/withdrawal cycles	> 250
Degree of protection	IP20

System Differentiation of 50 m and 70 m Systems and OPC Systems

- All INTERBUS devices that were supplied before January 1998 are **50 m systems**. These devices are not marked and support 50 m polymer fibers and 300 m HCS fibers.
- Since January 1998 a large part of the product range has been supplied with **70 m interfaces**. These devices are clearly marked with a corresponding label and support 70 m polymer fiber distances and 400 m HCS fiber distances.
- From the year 2000 onwards, INTERBUS devices have been fitted with the SUPI 3 OPC INTERBUS protocol chip. In this generation, optical transmission power is automatically regulated depending on the path attenuation. The maximum distance for polymer fibers is 50 m and, for HCS fibers, 300 m. These devices are marked with a corresponding label.

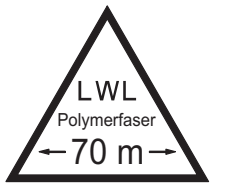

Figure 1 Label for 70 m systems



Figure 2 Label for OPC systems

Installation Guidelines for Polymer Fiber Cables (980/1000 μm)

The properties of a fiber optic transmission system are mainly determined by:

- Optical interface performance
- Cable type used
- Quality of the installation and of the connector assembly

Do Not Exceed Maximum Cable Lengths



When installing polymer fiber cables, the **maximum cable length** of 50 or 70 m (depending on the fiber optic system used) between two devices must not be exceeded (see page 29). The cable length can be further reduced using special cables or joints (see page 34).

Safe data transmission is ensured up to this length if the cables have been correctly installed.

In order to monitor the installed cable length, Phoenix Contact cables are marked with consecutive meter lengths.

A system reserve of 3 dB is taken into account for the maximum transmission distance. This means that the optical power transmitted through the cable can drop to half of the initial value due to the aging of system components, without affecting the safe operation of the fiber optic path.

Do Not Use Cables Shorter Than the Permitted Minimum Lengths



Fiber optic cables that are shorter than 1 m can result in the receiver being overcontrolled. Only use cables longer than 1 m. (For paths less than 1 m, see "Notes for Cable Lengths < 1 m" on page 30.)

The Bending Radius Must Be Maintained



Please ensure that the minimum **bending radius** is no smaller than 30 to 135 mm (for bending radii for polymer fiber cables, see page 36). This is particularly important if fiber optic cables are led through housing or installed in right angle cable ducts.

Do Not Exceed Tensile Load and Lateral Strength



The permanent **tensile load** of a polymer fiber cable must not exceed 100 N (see page 36).



Squeezing the cable, for a period longer than just stepping on it, must be avoided (lateral strength up to 20 N/cm).

Installation Guidelines for HCS Cables (200/230 μm)

Do Not Exceed Maximum Cable Lengths



When installing HCS cables, the **maximum cable length** of 300 or 400 m (depending on the fiber optic system used) between two devices must not be exceeded (see page 29).

Safe data transmission is ensured up to this length if the cables have been correctly installed.

In order to monitor the installed cable length, Phoenix Contact cables are marked with consecutive meter lengths.

A system reserve of 3 dB is taken into account for the maximum transmission distance. This means that the optical power transmitted through the cable can drop to half of the initial value due to the aging of system components, without affecting the safe operation of the fiber optic path.

The Bending Radius Must Be Maintained



Please note that the **bending radius** must not fall below the minimum value (for bending radii for HCS cables, see page 37). This is particularly important if fiber optic cables are led through housing or installed in right angle cable ducts.

Do Not Exceed Tensile Load and Lateral Strength



The permanent **tensile load** of an HCS cable must not exceed 200 N (see page 37).



Squeezing the cable, for a period longer than just stepping on it, must be avoided (lateral strength of 100 N/cm to 300 N/cm).

Installing Fiber Optic Cables

Use an Uncoiling Device to Uncoil the Fiber Optic Cable

The fiber optic cable must only be uncoiled from the cable drum using an uncoiling device.

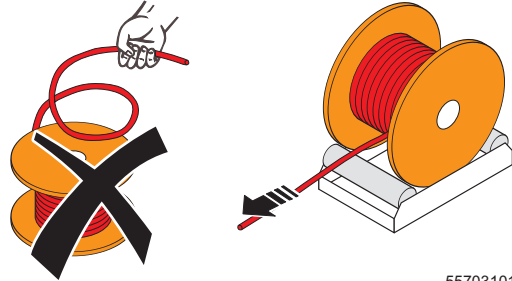

55703101

Figure 3 Use an uncoiling device

Do Not Twist the Cable

With short cable runs, avoid twisting the cable (torsion).



55703102

Figure 4 Avoid torsion

Insert the Fiber Optic Cable Correctly

Do not pull the cable by the individual fibers. Do not pull the cable forcefully if the cable becomes caught.

If you install the fiber optic cable using a cable-pulling device you must secure the device to the strain relief (e.g., aramide yarn).

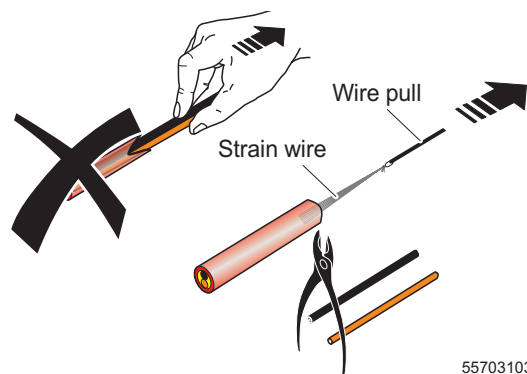

55703103

Figure 5 Do not pull by the individual fibers

Install Cables in Cable Ducts

Install the cables in cable ducts without loops.

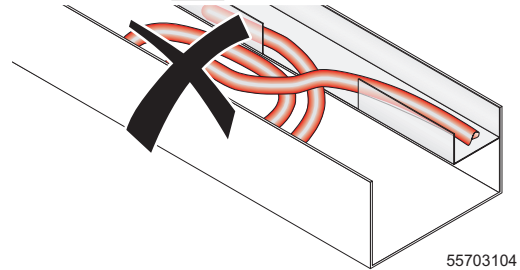

Figure 6 Install cables without loops

Install Fiber Optic Cables Separately

Fiber optic cables are installed in cable ducts or cable conduits. If these cables are installed in ducts together with heavy power cables, the fiber optic cables should be installed in a separated area of the duct or as the uppermost cable.

This is to protect fiber optic cables against increased bending and tensile loads such as those which occur, for example, when copper cables are replaced in the shared cable duct. If a separate installation is not possible, you should proceed as follows when replacing copper cables:

- Remove the fiber optic cables from the shared cable duct.
- Install the copper cables.
- Install the fiber optic cables again according to the installation instructions.
- To check the installation, check the optical power level or, in the case of INTERBUS devices with SUPI 3 OPC INTERBUS protocol chip, carry out a check via the system.

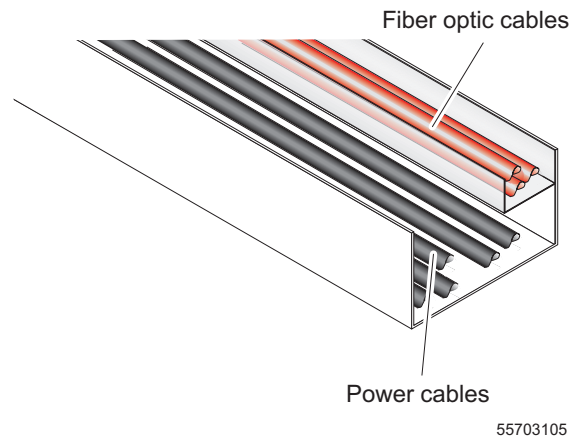

Figure 7 Separate cable ducts (example)

Protect Fiber Optic Cables From Sharp Edges

Protect the fiber optic cables from sharp edges. Insert an edge protector. Smooth or remove any sharp edges.

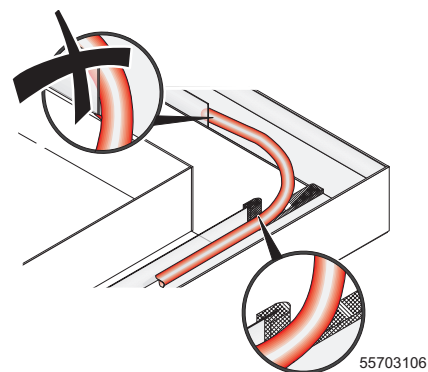

Figure 8 Insert an edge protector

Secure the Bending Radius: Cable

If the fiber optic cable has to be installed at a right angle, secure it with cable binders. This prevents the bending radius falling below its permissible range of 30 mm to 200 mm (depending on the cable type used, see "Fiber Optic Cable Specifications" on page 36).

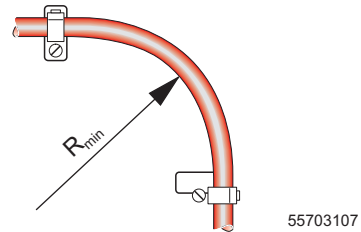

Figure 9 Maintain minimum bending radius

Secure the Bending Radius: Connector/Individual Fibers

Reduce the strain on the wire ends and connector mechanically (e.g., using cable binders).

In vertical cable ducts, reduce the permanent tensile load caused by the weight of the cable to a minimum through appropriate strain relief measures.

If the cable is inserted from below, it must be secured at the beginning of the cable sheath, so that the weight of the cable does not put strain on the F-SMA connector and the permissible bending radii are fixed.

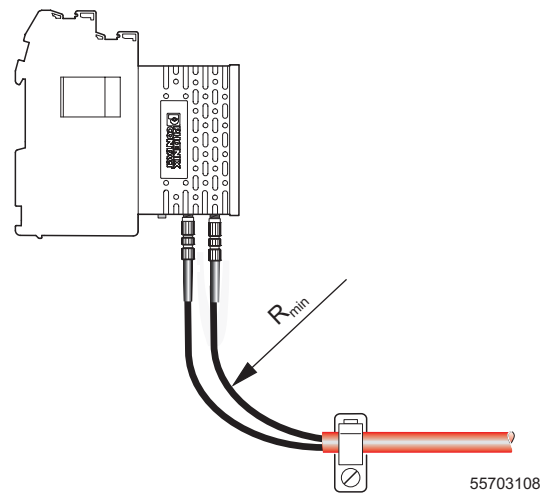

Figure 10 Secure the bending radius

Use Bend Protection When Routing a Cable Through a Control Cabinet

If cables are routed through control cabinets, the bending radius may fall below the permissible value. The use of PG screw connections with bend protection spirals is recommended. These provide good strain relief for the fiber optic cable and prevent bending radii that are too small.

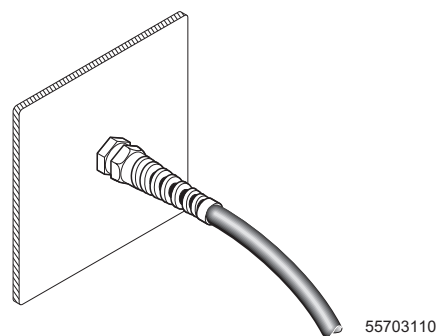

Figure 11 PG screw connection with bend protection

Installation on Moving Parts (Control Cabinet Doors)

Squeezing and non-permissible bending radii must be avoided when the cable crosses a moving part, e.g., a control cabinet door. This can be ensured by additional protection, e.g., using a secure corrugated tube or a spiral tube.



Even if the control cabinet door is closed, the bending radius must not fall below the permissible value.

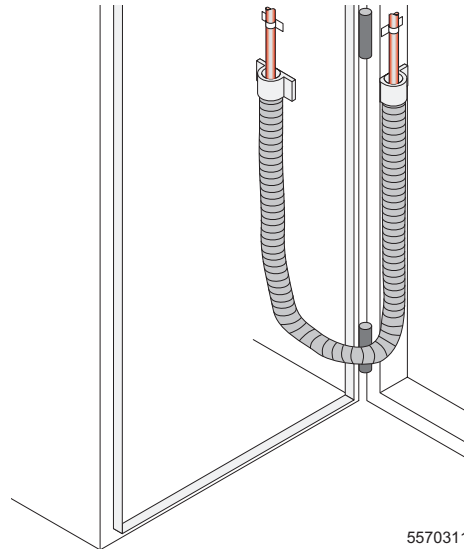

55703111

Figure 12 Spiral tube

Installation in Special Areas

If fiber optic cables are installed close to welding robots or in the ground, special cables must be used or appropriate mechanical safety measures must be implemented (e.g., installation of conduits, heat protector tube, etc.).

Do Not Squeeze Fiber Optic Cables When Securing

When securing cable binders, clamps, and control cabinet inlets, ensure the cable is not squeezed.

Preferably use plastic fastening elements with a large surface to avoid squeezing.

The fastening elements must have a width of at least 5 mm and should be carefully tightened manually.

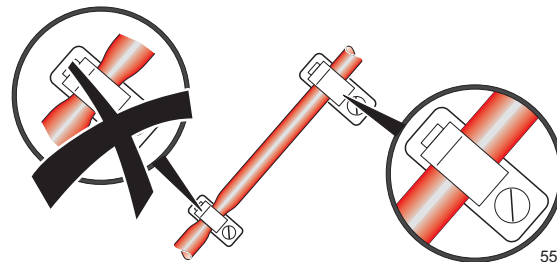

55703109

Figure 13 Use cable binders with a large (wide) surface

Assembling Polymer Fiber Cables

Strip the Outer Cable Sheath



Only use the method described below when stripping the red outer cable sheath.

The tools required for cable assembly are included in the PSM-POF-KONFTOOL assembly kit or can be ordered individually (see page 3).

Cut the Cable Sheath Lengthways

- Position the cable cross section so that the cable is cut along the aramide yarn or the tearing wire.
- Place the cable knife (KAMES LWL; Order No. 12 06 14 6) on the cable sheath approximately 10 cm away from the cable end. Pull the cable knife lengthways. If necessary repeat this step until the cable sheath is cut open.

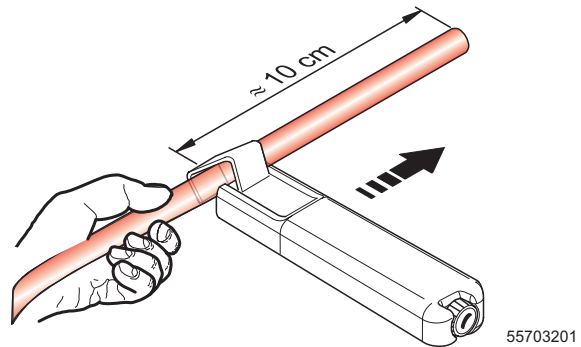

Figure 14 Stripping the outer cable sheath using KAMES LWL

Remove the Strain Relief

- Remove the strain relief (aramide yarn or tearing wire) from the open cable sheath.

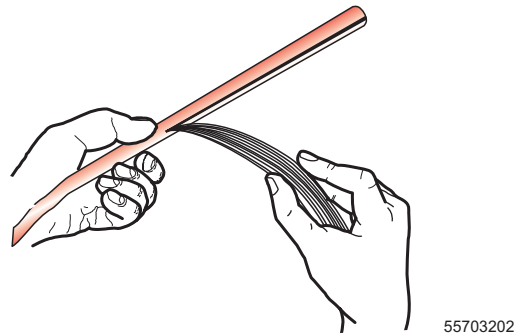

Figure 15 Removing the strain relief

Tear Open the Cable Sheath

- Twist the strain relief around a supporting tool (e.g., screwdriver, pliers) and make sure it is secure.
- Use the strain relief to tear open another 18 cm, approximately of the red outer cable sheath without bending the cable.

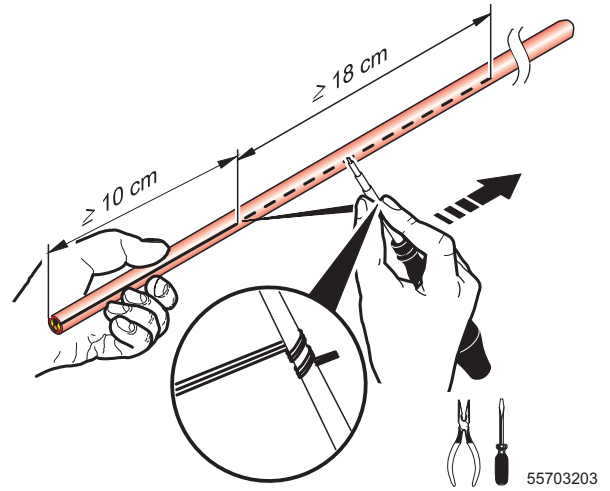

Figure 16 Tearing open the cable sheath

Remove the Individual Fibers



The two individual fibers must not be damaged.

- Cut off the red outer cable sheath and the strain relief at the end of the slit area using a sharp diagonal cutter (A) without damaging the two individual fibers.
- Shorten the individual fibers by 12 cm, as this part can be damaged by stripping the cable with the cable knife (B).

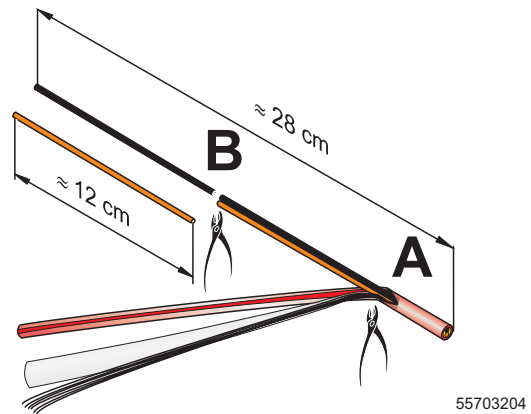

Figure 17 Removing the individual fibers

Assembling F-SMA Connectors



Polymer fiber cables must be fitted with F-SMA connectors that comply with the international F-SMA standard (type 905 according to IEC 60874-2).

Recommended F-SMA connector with bend protection: PSM-SET-FSMA/4-KT (see "Ordering Data" on page 3).

Strip the Individual Fibers



Do not use a knife, diagonal cutter or similar to strip the individual fibers.

The Phoenix Contact cable has rugged sheathing around each individual fiber that cannot simply be removed using any kind of stripping pliers.

Phoenix Contact recommends using the PSM-FO-STRIP tool that is part of the PSM-POF-KONFTOOL assembly kit.

- Strip the individual fibers with the smallest opening of the stripping pliers for 1.0 mm cable diameter (18 - 20 AWG).
- Strip 10 mm off each of the two individual fibers.

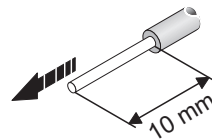

55703205

Figure 18 Stripping the individual fibers

Fit the Individual Fiber in the F-SMA Connector

- Unscrew the cap nut by one rotation.
- Remove the yellow protective cap.
- Push the individual fiber as far as possible into the F-SMA connector.

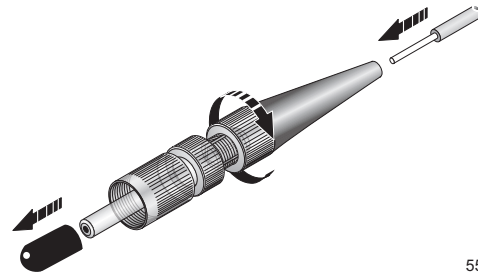

55703206

Figure 19 Fitting the individual fiber

Secure the Individual Fiber and Cut Off the Protruding Wire

- Tighten the cap nut of the F-SMA connector manually. (Tightening torque: 0.2 Nm)
- Cut the protruding polymer fiber with a **sharp** diagonal cutter to approximately 1 mm. Phoenix Contact recommends using the diagonal cutter that is part of the PSM-POF-KONFTOOL assembly kit.
- To check the tightness pull briefly but firmly on the individual fiber. The fiber must still protrude approximately 1 mm from the front end.
- Then polish the F-SMA connector (see "Polishing F-SMA Connectors" on page 16).

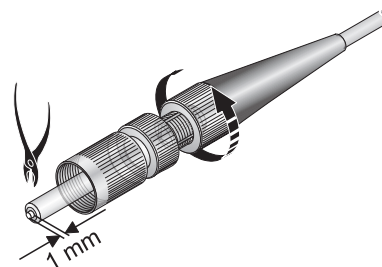

55703207

Figure 20 Assembling the connector

Polishing F-SMA Connectors



To achieve a minimum insertion attenuation, the front end of the polymer fiber has to be sanded and polished.

Prepare for Polishing

- Place the connector on the polishing plate.
- Place the abrasive paper on a level, flat surface.

Sand and Polish the Front of the Fiber



Make sure that you sand only the fiber and not the F-SMA connector.

- Sand the front of the polymer fiber with the abrasive paper (1500 grain), using figure of eight movements, until it is flush with the connector.
- Polish the front of the polymer fiber on the matt side of the 1 μ foil, using figure of eight movements (15 to 20 cycles).

Check the Quality

- Remove the abrasive dust with a clean, lint-free cloth.



The surface of the optical fiber and F-SMA connector must be smooth and free of scratches.

Connect the F-SMA Connector to the Module

- Plug the F-SMA connectors into the connections provided and manually secure the connection with the cap nuts.
- After assembly, label the cable ends with IN and OUT. This avoids confusion on startup.

The PSM-SET-FSMA-POLISH polishing set is used for polymer fibers. It consists of a polishing plate, abrasive paper, and polishing foil. The polishing set is part of the PSM-POF-KONFTOOL assembly kit or can be ordered separately (see page 3).

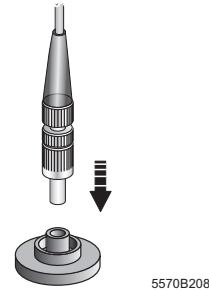

Figure 21 Placing the F-SMA connector on the polishing plate

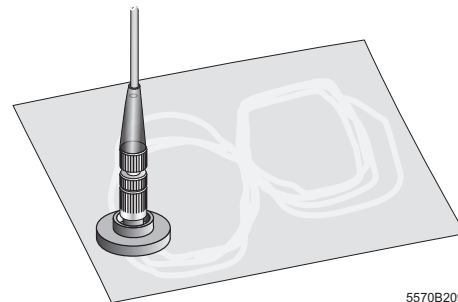

Figure 22 Polishing the F-SMA connector

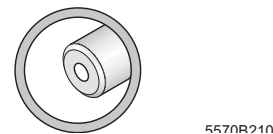

Figure 23 Checking the quality

Remote IN indicates the connections for the incoming remote bus. Remote OUT indicates the connections for the outgoing remote bus.



If the cable is not yet connected to the module, use the protective caps to protect the front side of the connector from dust and scratches.

Assembling QUICK F-SMA Connectors



The QUICK F-SMA connector (Q-FSMA-KT) must not be used if fiber optic joints are used.

Procedure

- Strip approximately 10 cm off the outer cable sheath as described under "Assembling Polymer Fiber Cables" on page 13.
- Carefully push one of the individual fibers through the bend protection sleeve in the QUICK F-SMA connector. The individual fiber must protrude approximately 20 mm from the connector.



Ensure that the individual fiber remains in position until it is finally secured.

- Cut off the protruding polymer fibers using the IBS RL FOC fiber cutter.



The blade of the IBS RL FOC fiber cutter must be replaced after approximately 100 cuts.

Alternative Procedure

- Strip approximately 10 cm off the outer cable sheath as described under "Assembling Polymer Fiber Cables" on page 13.
- Cut off the protruding polymer fibers using the IBS RL FOC fiber cutter.



The blade of the IBS RL FOC fiber cutter must be replaced after approximately 100 cuts.

- Screw the Quick F-SMA connector onto the connection provided, leaving it slightly loose
- Insert the individual fiber as far as possible.
- Tighten the connector.

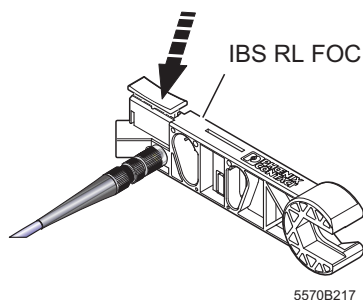

Figure 24 Cutting the wire with the IBS RL FOC fiber cutter

- Plug the QUICK F-SMA connectors into the connections provided and manually secure the connection with the cap nuts.

Assembling Rugged Line Connectors

Description of Individual Parts

- 1 QUICKON screw
- 2 Compression ring
- 3 Grommet
- 4 Splice ring

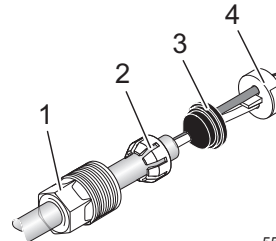

5570B211

Figure 25 Individual parts

Connect Individual Parts to the Cable

- Strip off the outer cable sheath (see "Assembling Polymer Fiber Cables" on page 13).
- Pierce the membrane of the grommet (3) using a screwdriver.
- Push the QUICKON screw (1), the compression ring (2), and the grommet (3) onto the polymer fiber cable. Push the grommet to the edge of the insulation.

Cross the Individual Fibers

- Note the IN/OUT labeling of the splice ring (4). Cross the individual fibers at the opposite splice ring.
- Push the two individual fibers through the splice ring. The colored side of the splice ring must point towards the cable.
If the individual fibers are flush with the splice ring, it is easier to fit the splice ring in the bus connector.

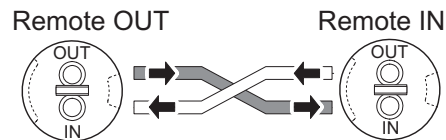

5570B212

Figure 26 Crossing the individual fibers

Insert the Individual Fibers in the Bus Connector

- Insert the two individual fibers in the corresponding opening of the bus connector and push them through until they emerge out of the other side. Please note that the keying of the splice ring must fit into the recesses of the bus connector.

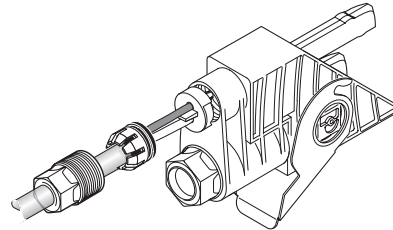

5570B2013

Figure 27 Bus connector

Tighten the QUICKON Screw



Tighten the QUICKON screw with a tightening torque of 2.5 Nm. Only the IBS RL FOC fiber cutter wrench should be used. This torque creates strain relief.
A connection that is too tight can lead to a long-term decline in the transmission power.

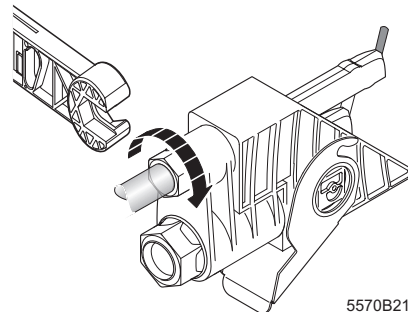

5570B214

Figure 28 Creating strain relief

Cut Off the Protruding Individual Fibers

- Push the IBS RL FOC fiber cutter as far as possible onto the bus connector, ensuring that it is flush with the protruding individual fibers.
- Cut off the individual fibers using the IBS RL FOC fiber cutter.



The blade of the IBS RL FOC fiber cutter must be replaced after approximately 100 uses.

- Check the connection quality using the optical diagnostics of the CMD configuration software (see "Implementing Optical Diagnostics for the OPC System With CMD" on page 33).

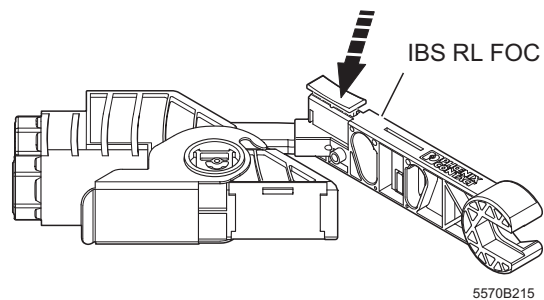

5570B215

Figure 29 Cutting off the individual fibers

Assembling HCS Fibers

Basic Information



When working with fiber optic cables observe the mechanical properties specified by the manufacturer. Fiber breaks can occur if the bending radii and maximum permissible tractive forces are exceeded or the cable is crushed. For the corresponding data for Phoenix Contact cables, please refer to the Appendix.



The fast connection technology described here is suitable for cable lengths up to 400 m. The individual wires of HCS cables must have a cross section of 2.9 mm.



The thin fibers of fiber optic cables are protected by a complex cable structure. These insulating/protective layers must be removed from fibers for assembly.



When assembling the connectors, please follow the described order precisely so as to achieve a good and consistent level of quality. Since the cable structure varies from manufacturer to manufacturer, certain steps may not be required.

Fast connection technology requires connectors (F-SMA, B-FOC (ST[®]) or SC-RJ) and an assembly kit. Phoenix Contact offers three assembly kits for the different connector types:

- PSM-HCS-KONFTOOL for F-SMA connectors
- PSM-HCS-KONFTOOL/B-FOC for B-FOC (ST[®]) connectors
- PSM-HCS-KONFTOOL/SC-RJ for SC-RJ connectors

The assembly kits contain:

- Stripping knife
- F-SMA connector (4 pcs.) or B-FOC connector (4 pcs.) or SC-RJ connector (2 duplex connectors)
- Aramide scissors
- Stripping pliers
- Wire stripper
- HCS fiber cleaving tool
- Microscope
- Adhesive strips

Cut the Cable Sheath Lengthways

- Position the cable cross section so that the cable is cut along the aramide yarn or the tearing wire.
- Place the stripping knife (KAMES LWL) on the cable sheath approximately 10 cm away from the cable end. Pull the stripping knife lengthways. If necessary repeat this step until the cable sheath is cut open.

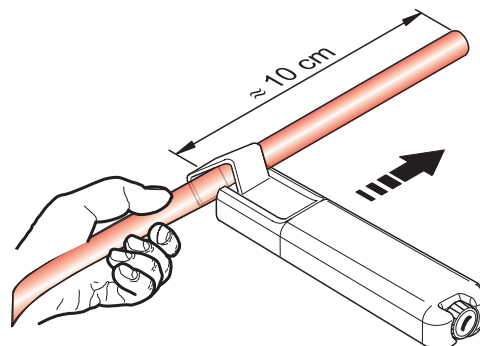

55703201

Figure 30 Stripping the outer cable sheath

Remove the Tearing Wire

- Remove the tearing wire from the open cable sheath.

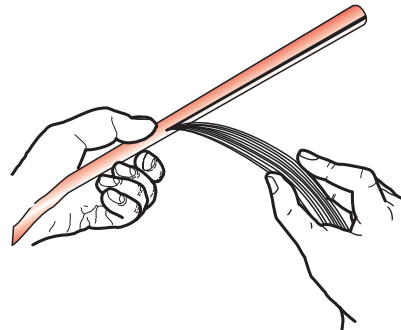

55703202

Figure 31 Removing the tearing wire

Tear Open the Cable Sheath

- Twist the tearing wire around a supporting tool (e.g., screwdriver, pliers) and make sure it is secure.
- Use the tearing wire to tear open approximately another 20 cm of the outer cable sheath without bending the cable.

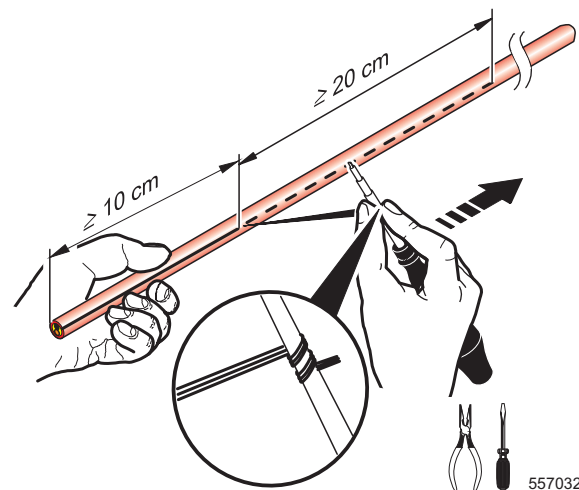

55703218

Figure 32 Tearing open the cable sheath

Remove the Individual Wires



The two individual wires must not be damaged.

- Cut off the outer cable sheath and – depending on the cable type – ties, rodent protection, and swelling yarns at the end of the slit area using aramide scissors (A), without damaging the individual wires.
- Shorten the individual wires by 12 cm, as this part can be damaged by stripping the cable with the cable knife (B).

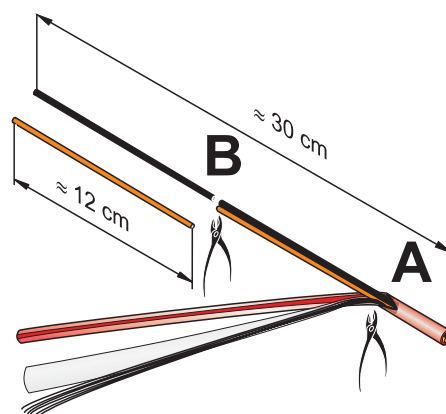

55703219

Figure 33 Removing the individual wires

Prepare the Connector



Make sure that you do not lose the wire clamp (1 in Figure 34). It is loose in the connector.

- Separate the connector into its individual parts. Hold the connector vertically with the bend protection sleeve pointing downwards and unscrew the connector.
- Remove the protective cap.

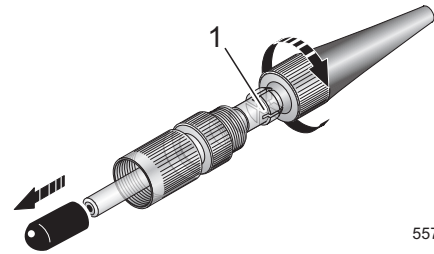

5570D002

Figure 34 Unscrewing the connector (with the example of an F-SMA connector)

Push on the Bend Protection Sleeve and the Clamping Nut

- Push the bend protection sleeve with the clamping nut onto the individual wires.

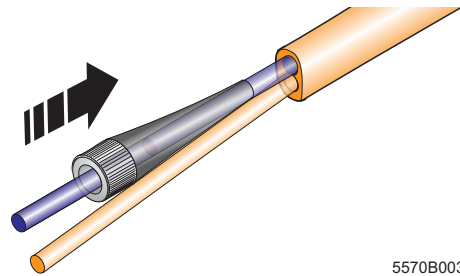

5570B003

Figure 35 Pushing on the bend protection sleeve

Strip the Individual Wires

- To strip the individual wires, use the 1.6 mm notch of the stripping pliers (second notch from the left).
- Strip approximately 8 cm off the conductor shielding.

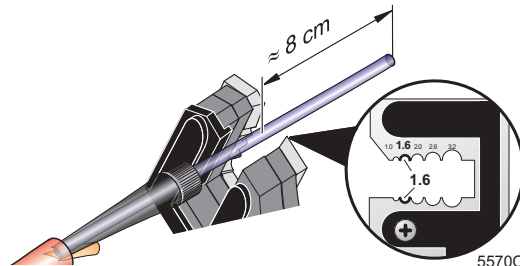

5570C004

Figure 36 Stripping the individual wires

Remove the Fiber Protection Layer (Coating)



Risk of injury
Without the fiber protection layer, fibers are very thin and can easily pierce the skin.



Once the fiber protection layer has been removed, the fiber must not be bent sharply. It can easily break.



The kit may contain a fixed or adjustable wire stripper. For the adjustable version, set it to 30 = 0.3 mm.

- Insert the fiber into the front opening of the wire stripper (A).
- Pull the aramide yarn to the side and push the fiber as far as possible into the conductor shielding.
- Push the handles of the stripping pliers firmly together (B) and then, with a jerk, pull the fiber protection layer (coating) from the fiber (C).

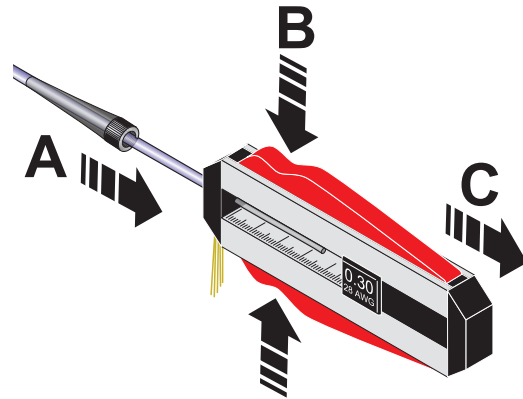

5570B005

Figure 37 Removing the coating

Cut Off the Strain Relief

- Using the aramide scissors, shorten the strain relief to approximately 6 mm.

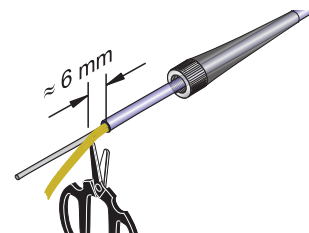

5570C006

Figure 38 Cutting off the strain relief

Push on the Wire Clamp

- Push the wire clamp over the fiber with the clamping slits towards the back.
- Insert at least 60% of the aramide yarn in the wire clamp. When pushing it into the aramide yarn, turn the wire clamp and push it as far as possible into the conductor shielding. The conductor shielding must be visible through the clamping slits.

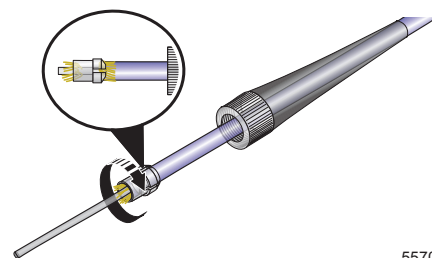

5570D007

Figure 39 Pushing on the wire clamp

Screw on the Basic Unit of the Connector

- Carefully insert the fiber in the basic unit.
- Hold the basic unit and then tighten the clamping nut manually (tightening torque of 0.2 Nm to 0.5 Nm).



5570D008

Figure 40 Screwing on the basic unit (with the example of an F-SMA connector)

Prepare the Fiber Cleaving Tool

The fiber cleaving tool is used to break the HCS fiber carefully.



The fiber cleaving tool must not be damaged or dirty.

- Turn the fiber span wheel (1) as far as possible towards the "Open" position (A).
- Turn the fiber cleave wheel (2) towards "Open", position 0 (B). This will lower the fiber span wheel.

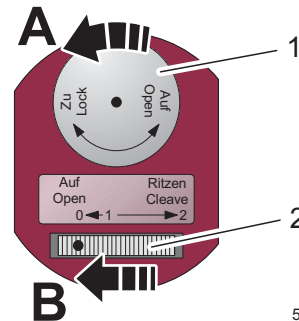

5570B009

Figure 41 Fiber cleaving tool

Assemble F-SMA Connectors

- Carefully wire up the F-SMA connector with the protruding fiber on the underside of the tool (A).

The fiber must be able to pass easily through the tool. It will come out of the drill hole in the fiber span wheel on the opposite side.

- Screw the F-SMA connector as far as possible onto the threads (B).

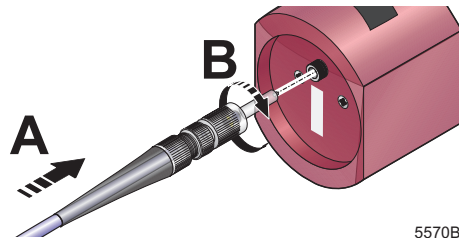

5570B010

Figure 42 Assembling the F-SMA connector with the fiber cleaving tool

Insert and Lock B-FOC Connectors

- Carefully wire up the B-FOC connector with the protruding fiber on the underside of the tool (A).

The fiber must be able to pass easily through the tool. It will come out of the drill hole in the fiber span wheel on the opposite side.

- Push the B-FOC connector onto the bayonet locking, push it down, and turn it clockwise until it snaps into place (B).

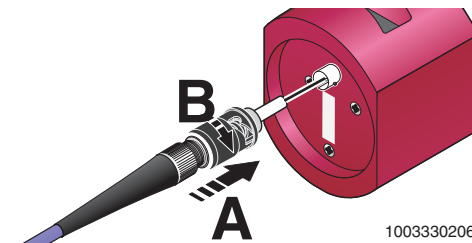

1003330206

Figure 43 Inserting and locking B-FOC connectors in the fiber cleaving tool

Insert and Snap in SC-RJ Connectors

- Carefully wire up the SC-RJ connector with the protruding fiber on the underside of the tool (A).

The fiber must be able to pass easily through the tool. It will come out of the drill hole in the fiber span wheel on the opposite side.

- Push the SC-RJ connector into the locking. The connector tabs must snap into the locking on the right and left-hand side (B). This should then prevent the connector from being removed unintentionally.

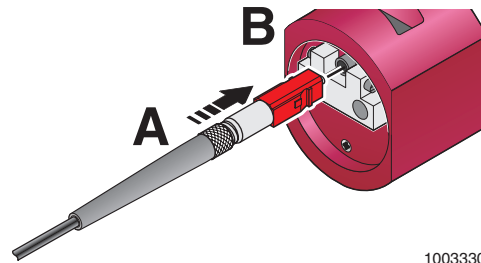

1003330207

Figure 44 Inserting and snapping in SC-RJ connectors in the fiber cleaving tool

Secure and Tighten the Fiber



To prevent damage to the fiber cleaving tool, tighten the span wheel carefully.

- Turn the fiber span wheel clockwise towards the "LOCK" position (A). The fiber is now secured and tightened in place.

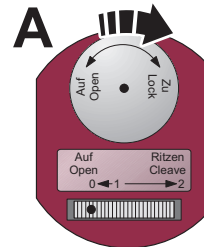

5570B011

Figure 45 Securing the fiber

Cleave and Break the Fiber



Please note that during the following step the fiber span wheel (B) should remain mobile (do not hold it or press down on it).

- Turn the fiber cleave wheel (A) slowly from the "Open" position (0), past position (1) to the "Cleave" position (2). This carefully breaks the fiber between position 1 and 2. The fiber span wheel (B) will visibly jump approximately 2 mm forwards.



Risk of injury

You can easily be injured by the remains of the fiber which have been broken off. The ends of the fiber can easily pierce the skin. Dispose of the remains of the fiber in a suitable receptacle (e.g., a film canister).

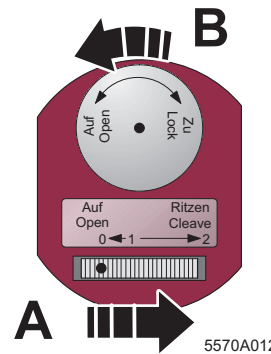

5570A012

Figure 46 Fiber cleave wheel (A) and fiber span wheel (B)

- Loosen the fiber span wheel (B) and remove the remains of the fiber.
- Unscrew the connector.

Clean the Connector

- To remove the remains of the fiber, dab the front of the connector with the adhesive strips provided.



Place the protective cap over the connector to prevent the fiber from getting dirty.

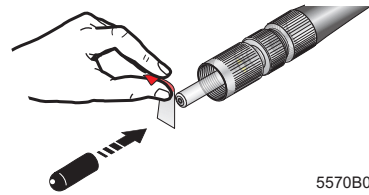

5570B013

Figure 47 Removing the remains of the fiber (with the example of an F-SMA connector)

Check the Quality



In the assembly kit, the microscope adapter for B-FOC/SC-RJ connectors is already assembled on the microscope upon delivery. For F-SMA connectors, the F-SMA microscope adapter is also included in the F-SMA assembly kit.

- Assemble the corresponding microscope adapter.
- Insert the connector in the opening provided (A) and switch on the microscope (B).
- View the front of the connector with the microscope (C).
- Adjust the visual acuity with the focusing screw on the side (D).

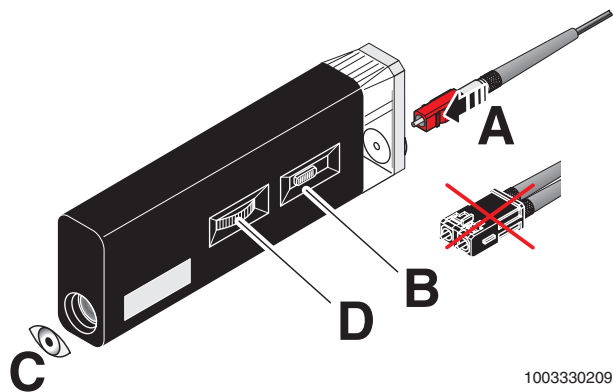

1003330209

Figure 48 Microscope (example: SC-RJ connector)

Assess the Quality

- Example of good assembly.
- Dust or remains of the fiber on the fiber or connector. These impurities increase the attenuation. Clean the connector. To remove the remains of the fiber, dab the front of the connector with the adhesive strips provided.
- Individual splinters on the fiber edge. Optical power is hardly affected. Measure the optical power to check the quality.
- Grooves, scratches or large surface splinters. These increase the attenuation to impermissible levels. Reassemble.

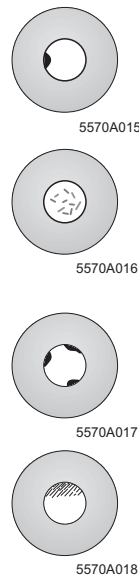

In large fiber optic installations, it is advisable to document the optical attenuation of the cables laid in the installation plans. A measuring device is available from Phoenix Contact (PSM-FO-POWERMETER, Order No. 2799539).

Assembling the SC-RJ Connector



Following assembly, insert both **SC-RJ connectors** in the duplex frame, so they cannot be removed again.

Assembly

- Insert both assembled SC-RJ connectors in the duplex frame with the tab pointing upwards. They engage with a click and cannot be pulled out again.

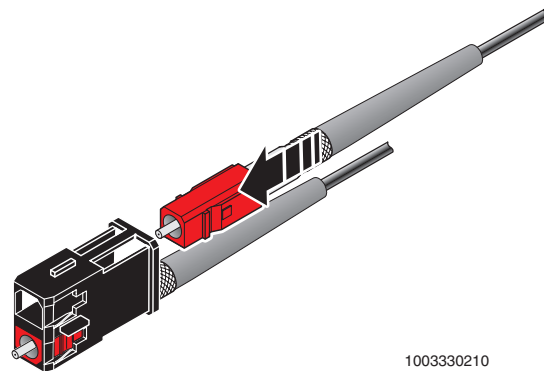

1003330210

Figure 49 Assembling the SC-RJ connector

Power Measurement After Initial Installation

After the installation of a fiber optic link, the optical power can be checked before the receiving device using a fiber optic measuring device.



Power measurement is **not necessary** for INTERBUS devices with a **SUPI 3 OPC INTERBUS protocol chip**. With these devices, the quality of the transmission path is automatically determined and compensated for in limits. The optical power of an installed path can be determined using the CMD software (Version 4.5x or later).

A reference cable must be used to measure the optical power after 1 m of cable. This measuring cable is supplied as standard with the PSM-FO-POWERMETER measuring device case.

Measure the Optical Power



For polymer fibers and HCS fibers, set the measuring device to 660 nm and the power measuring range to dBm.



When using the QUICK F-SMA connector (Q-FSMA-KT), you must use the Q-FSMA-IBS-MA measuring device adapter.

- Set the INTERBUS modules to steady light. For this check you must interrupt the bus directly after the controller board and check if the operating voltage is present at the modules. (An operating voltage is present if the green UL LEDs of all modules are on.)

- INTERBUS modules with SUP1 3 OPC INTERBUS protocol chip can also be measured. For this, the voltage must be reset so that the module reaches a defined control level.

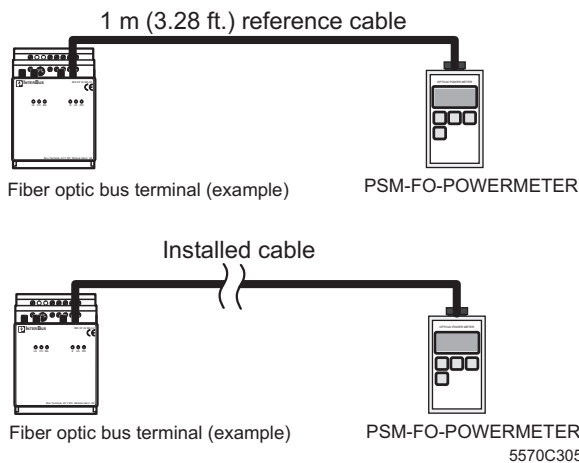

Measured Values for New Devices

See table row "Minimum transmission power measured with 1 m reference cable (25°C) [dBm]" on page 29.

Measured Values for New Devices

See table row "Minimum optical power to be measured at the cable end (25°C) [dBm]" on page 29.

Figure 50 Power measurement of fiber optic cables

Standard Optical Power and Path Lengths for Standard Cables



Fiber optic cables that are shorter than 1 m can result in the receiver being overcontrolled. Only use cables longer than 1 m. (For paths under 1 m, see "Notes for Cable Lengths < 1 m" on page 30.)



The dBm values indicated already take into account a system reserve, temperature influences, and aging of the transmitter/receiver.

System	50 m System *)		70 m System		Controlled OPC System		
Fiber	POF	HCS	POF	HCS	POF		HCS
Connection Method	F-SMA	F-SMA	F-SMA	F-SMA	F-SMA	Rugged Line	F-SMA
Maximum permitted optical power at the receiver [dBm]	-3.6	-3.6	-3.6	-3.6	-4.5	-3.5	-4.5
Minimum transmission power measured with 1 m reference cable (25°C) [dBm]	-3.6 to -8.2	-10.0 to -18.0	-3.6 to -5.3	-10.0 to -18.0	-4.5 to -6.8	-3.5 to -8.8	Typical: > -17.5
Minimum optical power to be measured at the cable end (25°C) [dBm]	-20.6	-22.6	-20.6	-22.6	-17.2	-17.2	-19.2
Maximum path length	50 m	300 m	70 m	400 m	50 m	50 m	100 m/ 300 m #)

*) Only applies to devices supplied before 1998

#) 100 m with fast connection technology/300 m with bonded and polished connectors

Power Measurement (Polymer Fibers)

After **initial installation**, the level measured by the reference cable for safe data transmission should not be outside the tolerance range for the minimum transmission power as specified in the table above. This reference cable is part of the PSM-FO-POWERMETER measuring device case.

The minimum measured values, which **must be maintained** at the end of the laid cables, are shown in the following figures (page 31 to page 35).

This information also takes into account all temperature influences of the transmit and receive components and a system reserve of 3 dB.

This system reserve must be maintained in each fiber optic system to reduce physical aging of the optical transmitter. This value is typically 1 dB in the first year and approximately 0.2 dB per year after that. This results in a service life of more than ten years at maximum system application.

Notes for Cable Lengths < 1 m



As a general rule, a minimum path length of 1 m must be maintained. Phoenix Contact can only ensure that fiber optic receivers will not be overcontrolled due to excessive optical power, if this minimum length is observed.



If cable lengths under 1 m are used, the optical power must be checked at the cable end so that overcontrol is avoided (see table row "Maximum permitted optical power at the receiver [dBm]" on page 29).

It is the responsibility of the installation engineer and the customer to ensure that this check is carried out.

Alternatively, optical control and diagnostics can be used in order to check that paths < 1 m are operating correctly.

Limit Value for Manual Optical Power Measurement

- Disconnect the connection to the controller board.
- For OPC systems: Reset the voltage on the controller board.
This automatically sets the control level to 14.
- Measure the optical power using an optical power device at the end of the installed cable.

If the following limit value is maintained, overcontrol of the receiver is avoided:

$$P_{\text{optical}} < -3.6 \text{ dBm (for OPC systems -4.5 dBm)}$$

Limit Value for OPC Diagnostics

- Start up the bus at the affected location.

One effect of overcontrol is that the next module may not be detected.

Even if the bus can be started up, problems may arise due to changes in the ambient temperature during operation, which will cause the optical power to increase and possibly result in overcontrol of the bus at a later stage.

- Read the optical diagnostics.

If the OPC system is operated with a **minimum control level of 5** (or higher), overcontrol can be avoided even in the event of temperature drifts.

Limit Values for Polymer Fibers of Different Lengths in 50 m Systems

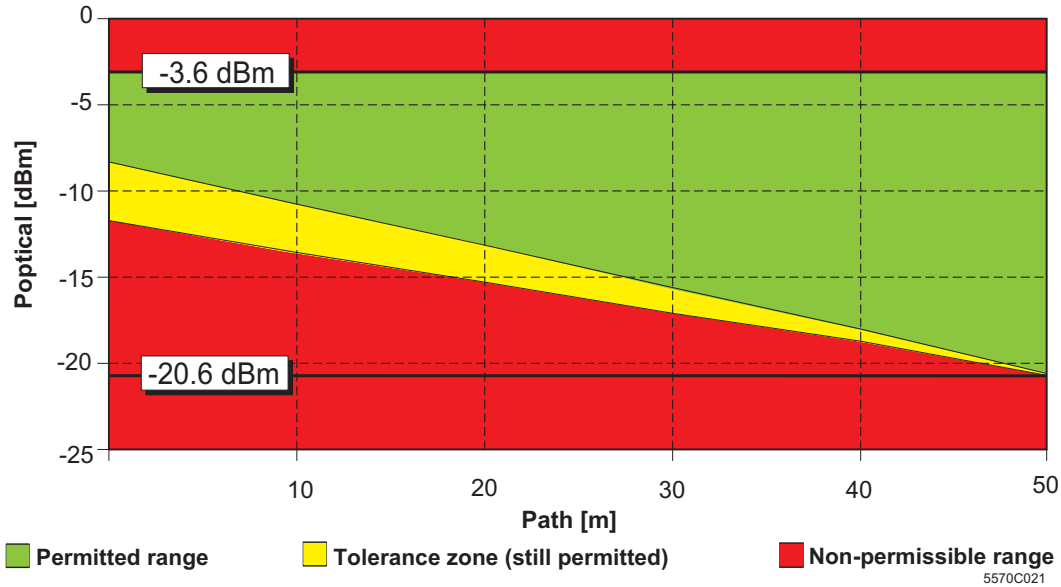

Figure 51 Limit values for a 50 m system

Limit Values for Polymer Fibers of Different Lengths in 70 m Systems

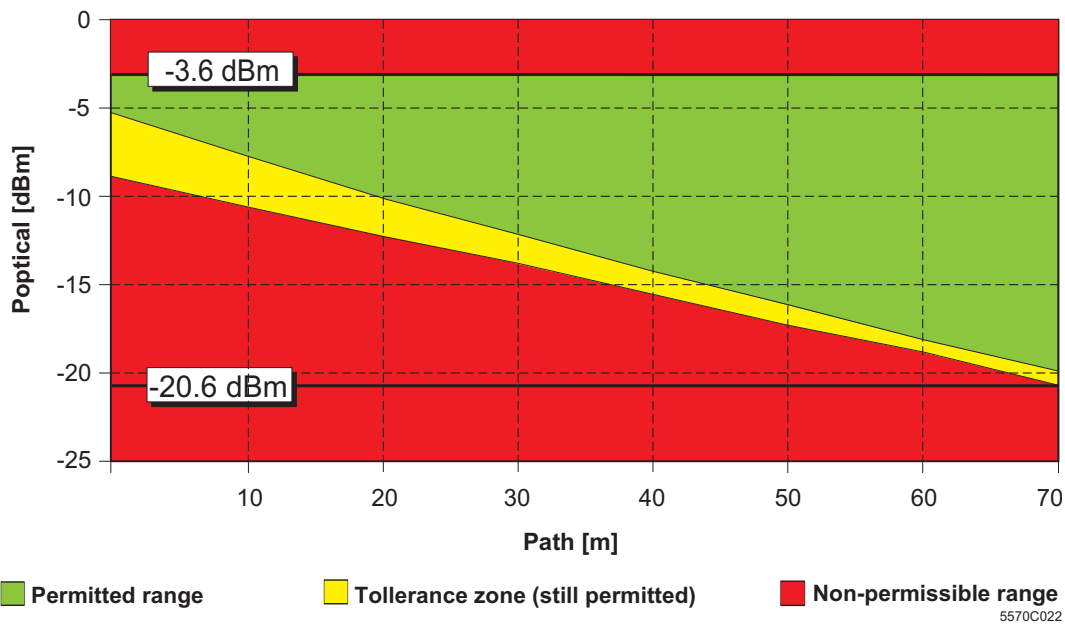

Figure 52 Limit values for a 70 m system

Power Measurement (HCS Cable)

For safe data transmission, the level measured after **initial installation must not exceed** a maximum value of -10 dBm and **must not fall below** a minimum value of -22.6 dBm (in 50 m/70 m systems) and -19.2 dBm (in OPC systems). This level takes into account all temperature influences of the transmit and receive components and a system reserve of 3 dB.

Due to the aging of the transmitter diode, the optical transmission power is usually reduced by typically 1 dB in the first year and by approximately 0.2 dB per year after that. All in all this results in a service life of more than ten years.

Limit Values for HCS Fibers of Different Lengths in 50 m Systems

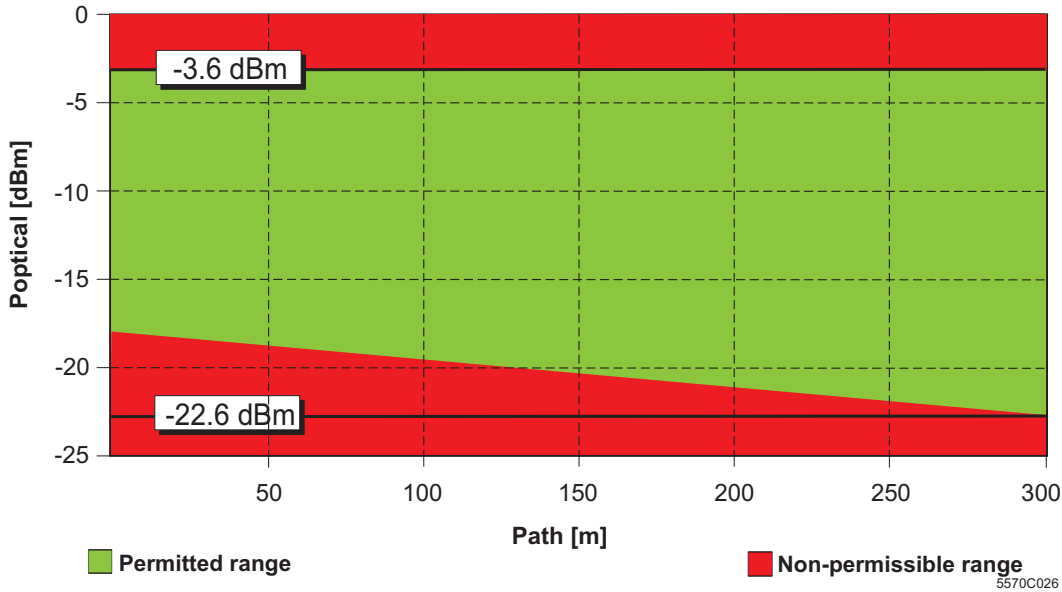

Figure 53 Limit values for HCS fibers in 50 m systems

Limit Values for HCS Fibers of Different Lengths in 70 m Systems

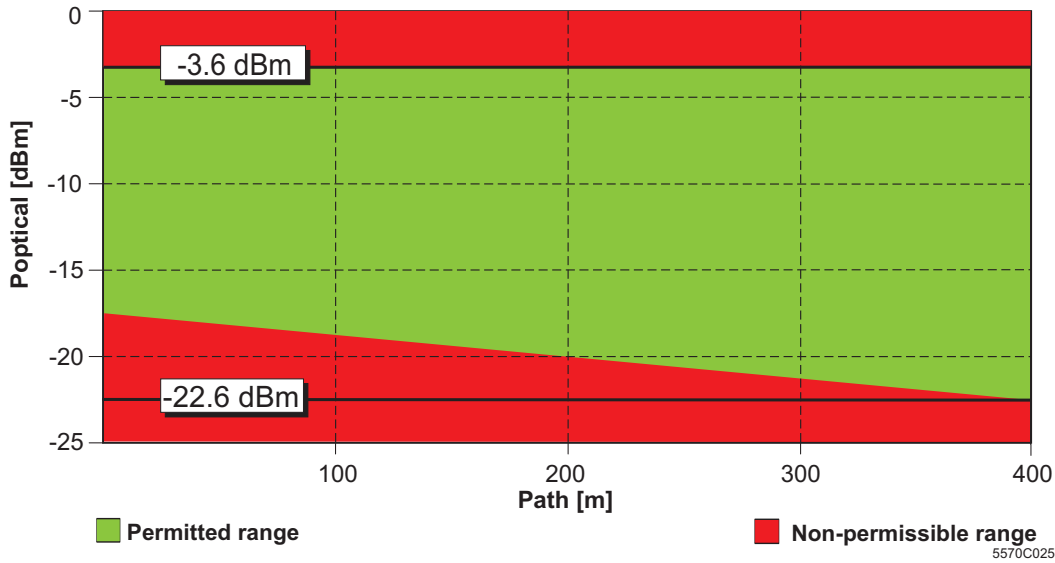

Figure 54 Limit values for HCS fibers in 70 m systems

Implementing Optical Diagnostics for the OPC System With CMD

- Start INTERBUS using the CMD software (Version 4.5x or later). Read the configuration frame and execute parameterization.
- Ensure that the bus is running.
- Select the "Add-On Programs" menu item from the "Options" menu.
- Select the "orm.dll" file in the "bin" directory and confirm with "OK".
- Select the "Optical Diagnostics" menu item from the controller board context menu.
- Select the "Read In" menu item in the "Optical Diagnostics" window.
- Select the "Current Values" menu item to read the current optical diagnostic data.

Values are displayed for the path length, optical power levels for forward and return paths, and an evaluation of the path quality. More or less the same values should be displayed for forward and return paths. If the values of the optical diagnostics are too poor, the installation and the cable assembly of the corresponding paths must be checked.

Criteria for evaluating optical diagnostics

Cable Type	Path Length	Criteria for Good Installation
Polymer fiber (POF)	1 m to 25 m	"optimal" or "normal"
	25 m to 50 m	"optimal", "normal" or "adequate"
HCS cable	1 m to 150 m	Control level ≤ 13
	150 m to 300 m	Control level ≤ 14

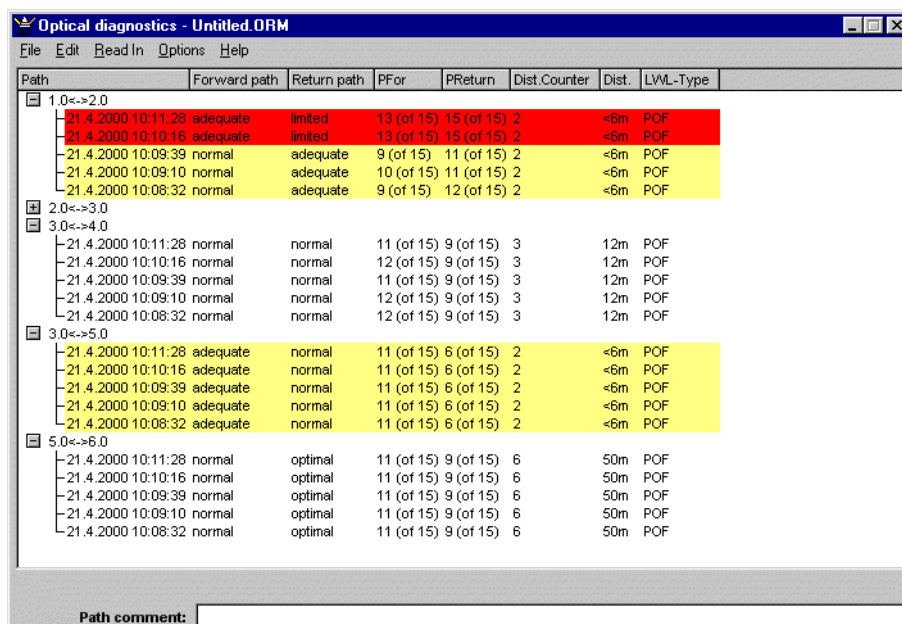

Figure 55 "Optical Diagnostics" dialog box

Reduction of Distances in Special Applications

Application of Fiber Optic Joints in Polymer Fiber Connections



Fiber optic joints must not be used with:

- HCS cable connections.
- QUICK F-SMA connectors.
- Cable connections, which have only been cut with the IBS RL FOC fiber cutter and have not been polished.

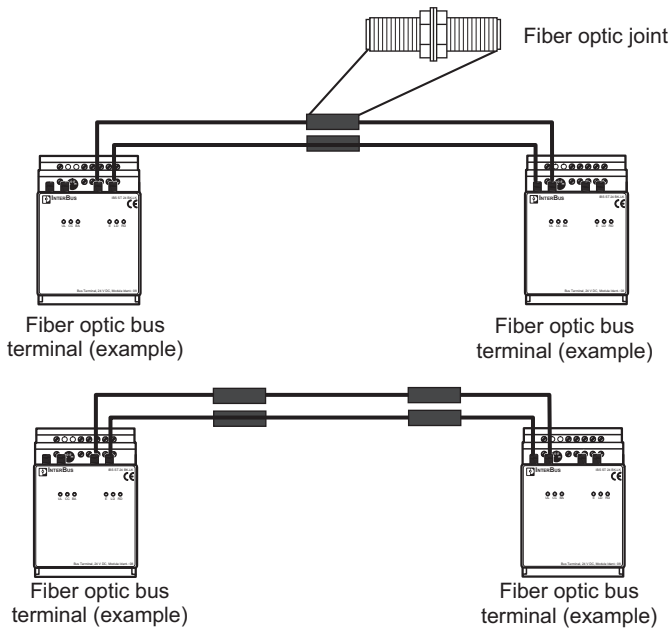

Insertion of one joint:

Attenuation is increased by approximately 2 to 3 dB.

The available path is therefore reduced by 10 m (32.81 ft.).

Example: A maximum of 60 m (164.04 ft.) is permitted in a 70 m (229.66 ft.) fiber optic system.

Insertion of two joints:

Attenuation is increased by approximately 4 to 6 dB.

The available path is therefore reduced by 20 m (65.62 ft.).

Example: A maximum of 50 m (164.04 ft.) is permitted in a 70 m (229.66 ft.) fiber optic system.

5570C112

Figure 56 Fiber optic joints

Application of Cables Suitable for Use With Drag Chain

The highly flexible PSM-LWL-RUGGED-FLEX drag chain cable has an alternating bending strength of 5 million cycles.



Due to the high basic attenuation of the cable, the transmission length is reduced by 15 m.

Application of HCS Outdoor Cables

The HCS outdoor cable has a higher basic attenuation at lower ambient temperatures ($< 0^{\circ}\text{C}$).



Compared to the standard HCS cable the transmission length of HCS outdoor cables is reduced by 100 m.

Limit Values for Polymer Fibers in Drag Chain Applications of Different Lengths (50 m System)

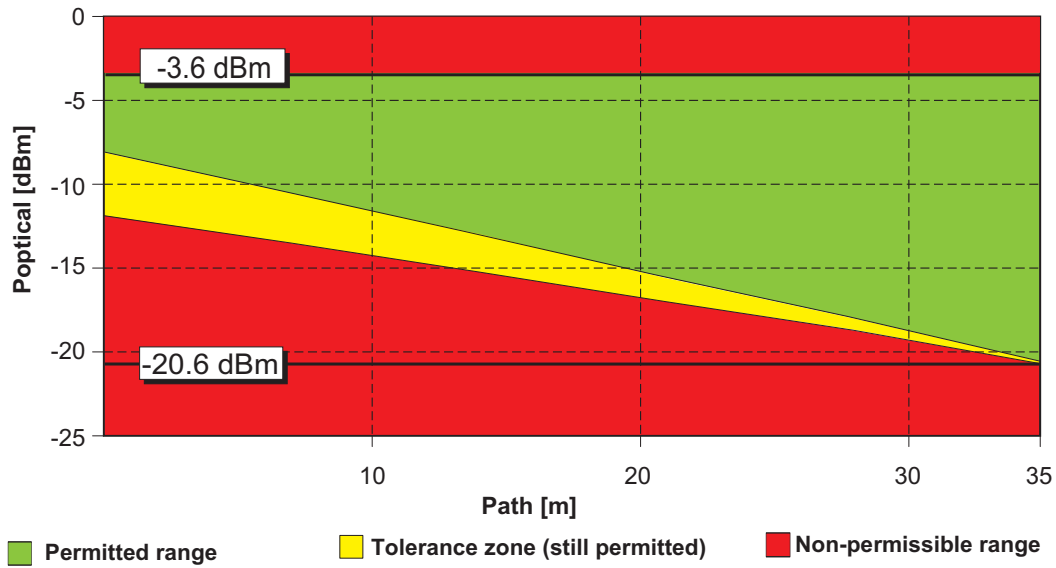

5570C023

Figure 57 Limit values for a 50 m system in drag chain applications

Limit Values for Polymer Fibers in Drag Chain Applications of Different Lengths (70 m System)

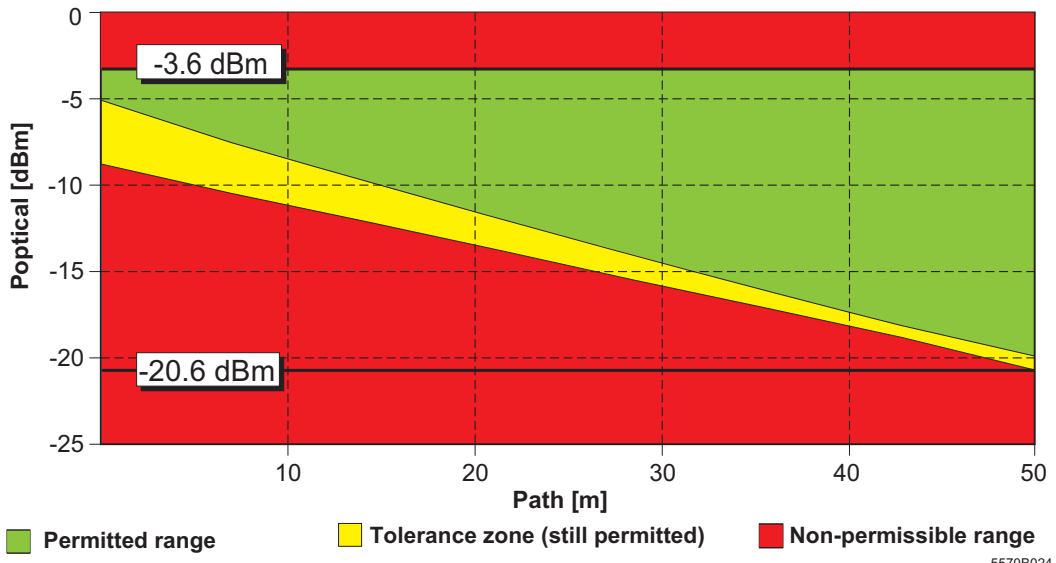

5570B024

Figure 58 Limit values for a 70 m system in drag chain applications

Fiber Optic Cable Specifications

Specification of Polymer Fiber Cables

	Standard Polymer Fiber Cable for Permanent Indoor Installation	Heavy Polymer Fiber Cable for Permanent Indoor Installation	Highly Flexible Polymer Fiber Cable for Indoor Installation
	PSM-LWL-KDHEAVY- 980/1000	PSM-LWL-RUGGED- 980/1000	PSM-LWL-RUGGED-FLEX- 980/1000
Fiber			
Core/cladding diameter	980/1000 µm	980/1000 µm	980/1000 µm
Refractive index profile	Step index	Step index	Step index
Material	PMMA	PMMA	PMMA
Attenuation at 660 nm LED	≤ 230 dB/km (LED)	≤ 230 dB/km (LED)	≤ 280 dB/km (LED)
Bandwidth length product (at 660 nm LED)	> 10 MHz x 100 m	> 10 MHz x 100 m	> 10 MHz x 100 m
Individual fiber			
Material	Polyamide (PA)	Polyamide (PA)	Polyamide (PA)
Color	Orange or black	Orange or black	Orange or black
Diameter	2.2 ± 0.07 mm	2.2 ± 0.07 mm	2.2 ± 0.07 mm
Outer cable sheath			
Material	Polyurethane (PUR)	Polyurethane (PUR)	Polyurethane (PUR)
Color	Red	Red	Red
Strain relief	Non-metal, aramide yarn	Non-metal, aramide yarn	Non-metal, aramide yarn
Diameter	6.0 ± 0.5 mm	8.0 ± 0.5 mm	8.0 ± 0.5 mm
Rodent protection	–	–	–
Temperature range			
Storage	-40°C to +80°C	-40°C to +80°C	-40°C to +80°C
Installation	+5°C to +50°C	+5°C to +50°C	+5°C to +50°C
Operation	-20°C to +70°C	-20°C to +70°C	-20°C to +70°C
Weight	28 kg/km	42 kg/km	51 kg/km
Bending radius (individual fiber)	≥ 30 mm	≥ 30 mm	≥ 30 mm
Bending radius (cable)			
Short-term	≥ 30 mm	≥ 65 mm	≥ 50 mm
Permanent	≥ 30 mm	≥ 65 mm	≥ 50 mm
Tensile strength (cable)			
Short-term	< 600 N	< 1000 N	< 200 N
Permanent	< 100 N	< 100 N	< 100 N
Lateral strength			
Short-term	< 200 N/cm	< 200 N/cm	< 200 N/cm
Permanent	< 20 N/cm	< 20 N/cm	< 20 N/cm
Impact strength	2 Nm/10 impacts, maximum	2 Nm/10 impacts, maximum	2 Nm/10 impacts, maximum
Alternating bending strength ^{#)} (DIN EN 187000, method 509)	–	–	10 x d, 10 N At least 50,000 cycles
Repeated bending ^{#)} (DIN EN 187000, method 507)	–	–	10 x d, 5 N At least 100,000 cycles
Torsion (DIN EN 187000, method 508)			±360°, 50 N, 10,000 cycles
Suitable for use with drag chain ^{#)}	–	–	10 x d At least 5 million cycles
Resistance to oil	ASTM oil No. 2, 100°C, DIN VDE 0473-811-2-1		
Free of substances that would hinder coating with paint or varnish	Chloroform test according to central standard 57650 of VW, Audi, and Seat		
Halogen-free (DIN VDE 0472-813)	According to IEC 60754-2 A1:1997		
Resistance to ozone	DIN VDE 0472-805, test type B		
UV resistance	DIN 53387 (method 1, condition A)		
Resistance to abrasion (DIN EN 187000, method 502)	At least 5000 cycles, 0.45 mm radius of the steel point, 7 N		

#) Evaluation criterion: Increase in attenuation ≤ 1 dBm

Specification of HCS Cables

Indoor Cable

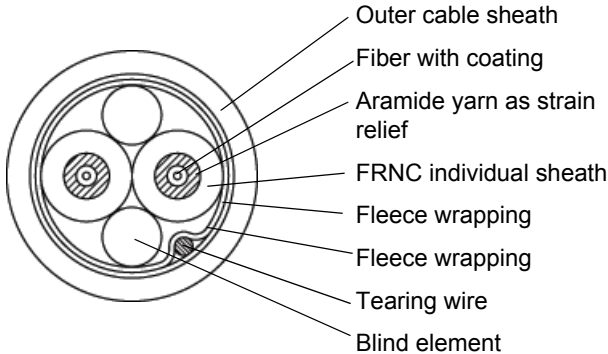

Outdoor Cable

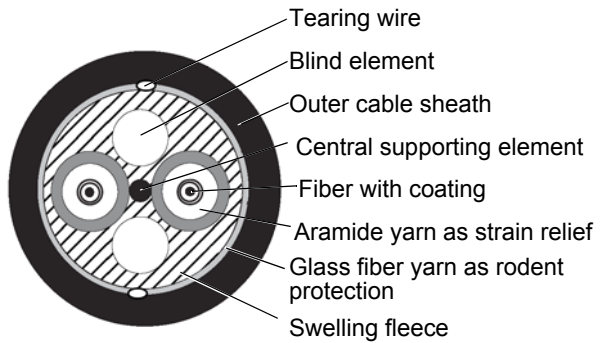

	HCS Cable for Permanent Indoor Installation	HCS Cable for Permanent Outdoor Installation
	PSM-LWL-HCS-RUGGED-230/230	PSM-LWL-HCSO-200/230
Fiber		
Core/cladding diameter	200/230 µm	200/230 µm
Refractive index profile	Step index	Step index
Bandwidth length product at 650 nm	≥ 17 MHz x km	≥ 17 MHz x km
Bandwidth length product at 850 nm	≥ 20 MHz x km	≥ 20 MHz x km
Attenuation at 650 nm LED	≤ 10 dB/km	≤ 10 dB/km (0°C ... +70°C) ≤ 15 dB/km (-20°C ... 0°C)
Attenuation at 850 nm LED	≤ 8 dB/km	≤ 8 dB/km (0°C ... +70°C) ≤ 12 dB/km (-20°C ... 0°C)
Individual wire		
Material	Copolymer FRNC (flame-retardant and non-corrosive)	Copolymer FRNC (flame-retardant and non-corrosive)
Color	Red/green	Gray
Strain relief	Non-metal, aramide yarn	Non-metal, aramide yarn
Outside diameter	2.9 mm ±0.1 mm (for 3 mm crimping)	2.9 mm ±0.1 mm (for 3 mm crimping)
Outer cable sheath		
Material	Polyurethane	Polyethylene (PE)
Color	Orange	Black
Diameter	8.0 mm ±0.5 mm	11.0 mm, approximately
Rodent protection	-	Glass yarn
Temperature range		
Storage	-25°C ... +70°C	-25°C ... +70°C
Installation	-5°C ... +50°C	-5°C ... +50°C
Operation	-5°C ... +70°C	-20°C ... +70°C
Weight	45 kg/km	90 kg/km
Bending radius (individual wires)		
Short-term	≥ 30 mm	≥ 30 mm
Permanent	≥ 50 mm	≥ 50 mm
Bending radius (cable)		
Short-term	≥ 65 mm	≥ 150 mm
Permanent	≥ 65 mm	≥ 200 mm
Tensile strength (EN 187000, method 501)		
Short-term	< 1000 N	< 1500 N
Permanent	< 200 N	< 500 N
Lateral strength (EN 187000, method 504)		
Short-term	< 400 N/cm	< 500 N/cm
Permanent	< 100 N/cm	< 300 N/cm
Impact strength (EN 187000, method 505)	2 Nm/10 impacts, maximum	1.5 Nm/3 impacts, maximum
Longitudinal water tightness (EN 187000, method 605)	-	By swelling material 1 m cable, 1 m water column, 24 h
Resistance to oil	ASTM oil No. 2, 100°C, DIN VDE 0473-811-2-1	Resistant to oil, gasoline, acids, and lyes

IBS SYS FOC ASSEMBLY

	HCS Cable for Permanent Indoor Installation	HCS Cable for Permanent Outdoor Installation
	PSM-LWL-HCS-RUGGED-230/230	PSM-LWL-HCSO-200/230
Free of substances that would hinder coating with paint or varnish	Chloroform test according to central standard 57650 of VW, Audi, and Seat	
Halogen-free	IEC 60754-2 A1:1997	
Flame-resistance	Highly inflammable	–
Fire load	1.72 MJ/m (0.48 kWh/m)	1.68 MJ/m (0.47 kWh/m)
UV resistance	DIN 53387, method 1, condition A	
Resistance to abrasion	5000 cycles, minimum; 0.45 mm radius of the steel point, 7 N	–

Checklist for Complete Installation of Fiber Optic Cables

Step	OK	Remark
Installing Fiber Optic Cables		
Fiber optic cable uncoiled with uncoiling device		
Maximum cable lengths not exceeded		
Bending radius maintained		
Cable not squeezed or bent when routed through a control cabinet		
No non-permissible squeezing and bending radii when crossing control cabinet doors		
Tensile load not exceeded		
Lateral strength not exceeded		
Implementing Safety Measures		
Fiber optic cable protected against strain relief and non-permissible bending radii		
Fiber optic cable not squeezed when fixed in place		
Cable installed without loops in cable ducts		
Fiber optic cable protected from sharp edges		
Separate installation of fiber optic cable and power cables or the fiber optic cable is installed last, on top of the other cables		
Special cables used or safety measures implemented for installation in special areas (underground installation, in the vicinity of welding robots)		
Assembling Fiber Optic Cables		
Outer cable sheath stripped without damaging the individual fiber		
Individual fiber cannot be pulled out of the connector		
Front of the connector is polished and the individual fiber is flush with the front of the connector		
Dimensioning Fiber Optic Cables		
Limit values maintained		

Компания «Океан Электроники» предлагает заключение долгосрочных отношений при поставках импортных электронных компонентов на взаимовыгодных условиях!

Наши преимущества:

- Поставка оригинальных импортных электронных компонентов напрямую с производств Америки, Европы и Азии, а так же с крупнейших складов мира;
- Широкая линейка поставок активных и пассивных импортных электронных компонентов (более 30 млн. наименований);
- Поставка сложных, дефицитных, либо снятых с производства позиций;
- Оперативные сроки поставки под заказ (от 5 рабочих дней);
- Экспресс доставка в любую точку России;
- Помощь Конструкторского Отдела и консультации квалифицированных инженеров;
- Техническая поддержка проекта, помощь в подборе аналогов, поставка прототипов;
- Поставка электронных компонентов под контролем ВП;
- Система менеджмента качества сертифицирована по Международному стандарту ISO 9001;
- При необходимости вся продукция военного и аэрокосмического назначения проходит испытания и сертификацию в лаборатории (по согласованию с заказчиком);
- Поставка специализированных компонентов военного и аэрокосмического уровня качества (Xilinx, Altera, Analog Devices, Intersil, Interpoint, Microsemi, Actel, Aeroflex, Peregrine, VPT, Syfer, Eurofarad, Texas Instruments, MS Kennedy, Miteq, Cobham, E2V, MA-COM, Hittite, Mini-Circuits, General Dynamics и др.);

Компания «Океан Электроники» является официальным дистрибьютором и эксклюзивным представителем в России одного из крупнейших производителей разъемов военного и аэрокосмического назначения «JONHON», а так же официальным дистрибьютором и эксклюзивным представителем в России производителя высокотехнологичных и надежных решений для передачи СВЧ сигналов «FORSTAR».



JONHON

«JONHON» (основан в 1970 г.)

Разъемы специального, военного и аэрокосмического назначения:

(Применяются в военной, авиационной, аэрокосмической, морской, железнодорожной, горно- и нефтедобывающей отраслях промышленности)

«FORSTAR» (основан в 1998 г.)

ВЧ соединители, коаксиальные кабели,
кабельные сборки и микроволновые компоненты:

(Применяются в телекоммуникациях гражданского и специального назначения, в средствах связи, РЛС, а так же военной, авиационной и аэрокосмической отраслях промышленности).



Телефон: 8 (812) 309-75-97 (многоканальный)

Факс: 8 (812) 320-03-32

Электронная почта: ocean@oceanchips.ru

Web: <http://oceanchips.ru/>

Адрес: 198099, г. Санкт-Петербург, ул. Калинина, д. 2, корп. 4, лит. А