

Metal Oxide Resistors, Special Purpose, High Voltage

FEATURES

- Low TCR; ± 200 ppm/ $^{\circ}\text{C}$ standard; ± 100 ppm/ $^{\circ}\text{C}$, ± 50 ppm/ $^{\circ}\text{C}$ available
- Tolerance: $\pm 1\%$; $\pm 2\%$; $\pm 5\%$; $\pm 10\%$
- High Voltage (up to 45 kV)
- For oil bath or open air operation
- Matched sets available
- Special testing available upon request
- Material categorization:
For definitions of compliance please see www.vishay.com/doc?99912

RoHS*
 COMPLIANT

Note

* Lead (Pb)-containing terminations are not RoHS-compliant. Exemptions may apply.

| STANDARD ELECTRICAL SPECIFICATIONS | | | | | | | | |
|------------------------------------|------------------|--|--|---|---|---|-----------------------|--|
| GLOBAL MODEL | HISTORICAL MODEL | POWER RATING | | | MAXIMUM WORKING VOLTAGE ⁽²⁾ V | RESISTANCE RANGE ⁽³⁾ Ω | TOLERANCE $\pm \%$ | TEMPERATURE COEFFICIENT \pm ppm/ $^{\circ}\text{C}$ |
| | | $P_{25^{\circ}\text{C}}$ W ⁽¹⁾ | $P_{70^{\circ}\text{C}}$ W ⁽¹⁾ | $P_{125^{\circ}\text{C}}$ W ⁽¹⁾ | | | | |
| ROX050 | ROX-1/2 | 2.0 | 1.4 | 1.0 | 2K | 1M to 100M | 1, 2, 5, 10 | 50 |
| | | | | | | 1K to 100M | 1, 2, 5, 10 | 100 |
| | | | | | | 1K to 1G | 1, 2, 5, 10 | 200 |
| ROX075 | ROX-3/4 | 3.0 | 2.16 | 1.5 | 5K | 1M to 100M | 1, 2, 5, 10 | 50 |
| | | | | | | 1K to 500M | 1, 2, 5, 10 | 100 |
| | | | | | | 1K to 3G | 1, 2, 5, 10 | 200 |
| ROX100 | ROX-1 | 4.0 | 2.88 | 2.0 | 7.5K | 100 to 1M | 1, 2, 5, 10 | Non-inductive ⁽⁴⁾ |
| | | | | | | 1M to 100M | 1, 2, 5, 10 | 50 |
| | | | | | | 1K to 500M | 1, 2, 5, 10 | 100 |
| ROX150 | ROX-1-1/2 | 5.0 | 3.6 | 2.5 | 11K | 1K to 3G | 1, 2, 5, 10 | 200 |
| | | | | | | 100 to 1M | 1, 2, 5, 10 | Non-inductive ⁽⁴⁾ |
| | | | | | | 1M to 100M | 1, 2, 5, 10 | 50 |
| ROX200 | ROX-2 | 6.0 | 4.32 | 3.0 | 15K | 1K to 500M | 1, 2, 5, 10 | 100 |
| | | | | | | 1K to 1G | 1, 2, 5, 10 | 100 |
| | | | | | | 1K to 3G | 1, 2, 5, 10 | 200 |
| ROX300 | ROX-3 | 10.0 | 7.2 | 5.0 | 22.5K | 100 to 1M | 1, 2, 5, 10 | Non-inductive ⁽⁴⁾ |
| | | | | | | 1M to 500M | 1, 2, 5, 10 | 50 |
| | | | | | | 1K to 1G | 1, 2, 5, 10 | 100 |
| ROX400 | ROX-4 | 12.0 | 8.64 | 6.0 | 30K | 1K to 3G | 1, 2, 5, 10 | 200 |
| | | | | | | 500 to 10M | 1, 2, 5, 10 | Non-inductive ⁽⁴⁾ |
| | | | | | | 1M to 500M | 1, 2, 5, 10 | 50 |
| ROX500 | ROX-5 | 16.0 | 11.52 | 8.0 | 37.5K | 1K to 1G | 1, 2, 5, 10 | 100 |
| | | | | | | 1K to 3G | 1, 2, 5, 10 | 200 |
| | | | | | | 500 to 10M | 1, 2, 5, 10 | Non-inductive ⁽⁴⁾ |
| ROX600 | ROX-6 | 20.0 | 14.4 | 10.0 | 45K | 1M to 500M | 1, 2, 5, 10 | 50 |
| | | | | | | 1K to 1G | 1, 2, 5, 10 | 100 |
| | | | | | | 1K to 3G | 1, 2, 5, 10 | 200 |
| | | | | | | 500 to 10M | 1, 2, 5, 10 | Non-inductive ⁽⁴⁾ |

Notes

- All resistance values are calibrated at 100 V_{DC}. Calibration at other voltages available.
- $\pm 1\%$ not available above 1 G Ω
- Part marking: Print marked - Dale, model, value, tolerance, temperature coefficient, date code
- (1) Increase wattage by 40 % for 0.040" (1.02 mm) diameter leads
- (2) Continuous working voltage shall be $\sqrt{P \times R}$ or maximum working voltage, whichever is less.
- (3) For resistance values above and below those listed please contact us
- (4) Non-inductive ± 200 ppm/ $^{\circ}\text{C}$ TCR only

| TECHNICAL SPECIFICATIONS | | | | | | | | | | |
|----------------------------|--------------------|---|--------|--------|--------|--------|--------|--------|--------|--------|
| PARAMETER | UNIT | ROX050 | ROX075 | ROX100 | ROX150 | ROX200 | ROX300 | ROX400 | ROX500 | ROX600 |
| Insulation Resistance | Ω | $\geq 10^{11}$ | | | | | | | | |
| Category Temperature Range | $^{\circ}\text{C}$ | Epoxy coated = - 55/+ 180; Silicone coated = - 55/+ 230 | | | | | | | | |

GLOBAL PART NUMBER INFORMATION

New Global Part Numbering: ROX300100MGNF5 (preferred part numbering format)

R O X 3 0 0 1 0 0 M G N F 5

| GLOBAL MODEL (See Electrical Specifications table) | RESISTANCE VALUE R = Ω K = kΩ M = MΩ G = GΩ 910R = 910 Ω 10M0 = 10 MΩ 1G00 = 1.0 GΩ | TOLERANCE CODE F = ± 1 % G = ± 2 % J = ± 5 % K = ± 10 % | TEMP. COEFFICIENT H = 50 ppm K = 100 ppm N = 200 ppm | PACKAGING (1) EL = Lead (Pb)-free, lacer (all, except 3, 4, 5, 6) EE = Lead (Pb)-free, T/R (1/2, 3/4, 1 only) EM = Lead (Pb)-free, foam (3, 4, 5, 6 only) LB = Tin/lead, lacer (all, except 3, 4, 5, 6) RF = Tin/lead, T/R (1/2, 3/4, 1 only) F5 = Tin/lead, foam (3, 4, 5, 6 only) | CONSTRUCTION (Up to 2 digits) Blank = Standard N = Non-inductive P = 0.040 Ø leads S = Solid body, axial T = Threaded terminals Y = One end axial, one threaded terminal | SPECIAL Blank = Standard (Dash number) (Up to 3 digits) From 1 to 999 as applicable |
|---|--|---|---|---|---|--|
|---|--|---|---|---|---|--|

Historical Part Number example: ROX-3100MGN (will continue to be accepted)

| | | | | | |
|------------------|--------------|------------------|----------------|-------------------|-----------|
| ROX-3 | | 100M | G | N | F05 |
| HISTORICAL MODEL | CONSTRUCTION | RESISTANCE VALUE | TOLERANCE CODE | TEMP. COEFFICIENT | PACKAGING |

Notes

(1) Some packaging codes are model specific.

- For additional information on packaging, refer to the Through-Hole Resistor Packaging document (www.vishay.com/doc?31544).

DIMENSIONS in inches (millimeters)

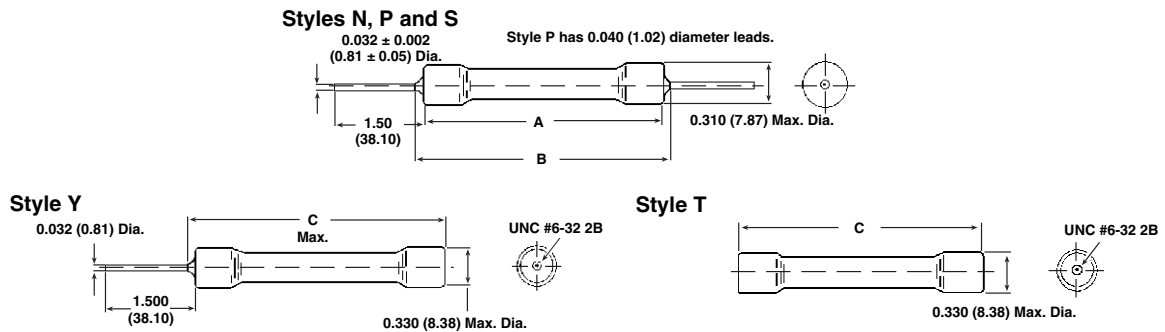

| GLOBAL MODEL | STYLE N, P, S | | STYLE T | STYLE Y |
|--------------|-------------------------------|----------------|-------------------------------|----------------|
| | A | B | C | C MAX. |
| ROX050 | 0.550 ± 0.032 (13.97 ± 0.81) | 0.700 (17.78) | N/A | N/A |
| ROX075 | 0.800 ± 0.032 (20.32 ± 0.81) | 0.900 (22.86) | 1.168 ± 0.022 (29.66 ± 0.56) | 1.050 (26.67) |
| ROX100 | 0.920 ± 0.032 (23.37 ± 0.81) | 1.020 (25.91) | 1.288 ± 0.022 (32.72 ± 0.56) | 1.170 (29.72) |
| ROX150 | 1.550 ± 0.032 (39.37 ± 0.81) | 1.650 (41.91) | 1.918 ± 0.022 (48.72 ± 0.56) | 1.800 (45.72) |
| ROX200 | 2.050 ± 0.032 (52.07 ± 0.81) | 2.150 (54.61) | 2.418 ± 0.022 (61.42 ± 0.56) | 2.300 (58.42) |
| ROX300 | 3.050 ± 0.032 (77.47 ± 0.81) | 3.150 (80.01) | 3.418 ± 0.022 (86.82 ± 0.56) | 3.300 (83.82) |
| ROX400 | 4.050 ± 0.032 (102.87 ± 0.81) | 4.150 (105.41) | 4.418 ± 0.022 (112.22 ± 0.56) | 4.300 (109.22) |
| ROX500 | 5.050 ± 0.032 (128.27 ± 0.81) | 5.150 (130.81) | 5.418 ± 0.022 (137.62 ± 0.56) | 5.300 (134.62) |
| ROX600 | 6.050 ± 0.032 (153.67 ± 0.81) | 6.150 (156.21) | 6.418 ± 0.022 (163.02 ± 0.56) | 6.300 (160.02) |

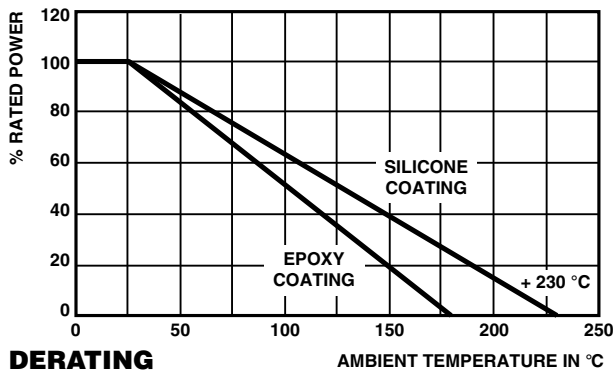

MECHANICAL SPECIFICATIONS

| | |
|-------------------|---|
| Terminal Strength | 10 pound pull test |
| Solderability | Continuous satisfactory coverage when tested in accordance with MIL-STD-202, Method 208 |

MATERIAL SPECIFICATIONS

| | |
|-------------|---|
| Element | High temperature fired cermet film |
| Core | High purity 96 % alumina, tubular or solid |
| Coating | Blue flame-retardant epoxy on ROX050 thru ROX200. Black flameproof silicone on ROX300 thru ROX600 |
| Termination | Standard lead material is solder-coated copper; solderable and weldable. 0.032" (0.813 mm) style P 0.040" (1.02 mm) available |





Disclaimer

ALL PRODUCT, PRODUCT SPECIFICATIONS AND DATA ARE SUBJECT TO CHANGE WITHOUT NOTICE TO IMPROVE RELIABILITY, FUNCTION OR DESIGN OR OTHERWISE.

Vishay Intertechnology, Inc., its affiliates, agents, and employees, and all persons acting on its or their behalf (collectively, "Vishay"), disclaim any and all liability for any errors, inaccuracies or incompleteness contained in any datasheet or in any other disclosure relating to any product.

Vishay makes no warranty, representation or guarantee regarding the suitability of the products for any particular purpose or the continuing production of any product. To the maximum extent permitted by applicable law, Vishay disclaims (i) any and all liability arising out of the application or use of any product, (ii) any and all liability, including without limitation special, consequential or incidental damages, and (iii) any and all implied warranties, including warranties of fitness for particular purpose, non-infringement and merchantability.

Statements regarding the suitability of products for certain types of applications are based on Vishay's knowledge of typical requirements that are often placed on Vishay products in generic applications. Such statements are not binding statements about the suitability of products for a particular application. It is the customer's responsibility to validate that a particular product with the properties described in the product specification is suitable for use in a particular application. Parameters provided in datasheets and/or specifications may vary in different applications and performance may vary over time. All operating parameters, including typical parameters, must be validated for each customer application by the customer's technical experts. Product specifications do not expand or otherwise modify Vishay's terms and conditions of purchase, including but not limited to the warranty expressed therein.

Except as expressly indicated in writing, Vishay products are not designed for use in medical, life-saving, or life-sustaining applications or for any other application in which the failure of the Vishay product could result in personal injury or death. Customers using or selling Vishay products not expressly indicated for use in such applications do so at their own risk. Please contact authorized Vishay personnel to obtain written terms and conditions regarding products designed for such applications.

No license, express or implied, by estoppel or otherwise, to any intellectual property rights is granted by this document or by any conduct of Vishay. Product names and markings noted herein may be trademarks of their respective owners.

Material Category Policy

Vishay Intertechnology, Inc. hereby certifies that all its products that are identified as RoHS-Compliant fulfill the definitions and restrictions defined under Directive 2011/65/EU of The European Parliament and of the Council of June 8, 2011 on the restriction of the use of certain hazardous substances in electrical and electronic equipment (EEE) - recast, unless otherwise specified as non-compliant.

Please note that some Vishay documentation may still make reference to RoHS Directive 2002/95/EC. We confirm that all the products identified as being compliant to Directive 2002/95/EC conform to Directive 2011/65/EU.

Vishay Intertechnology, Inc. hereby certifies that all its products that are identified as Halogen-Free follow Halogen-Free requirements as per JEDEC JS709A standards. Please note that some Vishay documentation may still make reference to the IEC 61249-2-21 definition. We confirm that all the products identified as being compliant to IEC 61249-2-21 conform to JEDEC JS709A standards.

Компания «Океан Электроники» предлагает заключение долгосрочных отношений при поставках импортных электронных компонентов на взаимовыгодных условиях!

Наши преимущества:

- Поставка оригинальных импортных электронных компонентов напрямую с производств Америки, Европы и Азии, а так же с крупнейших складов мира;
- Широкая линейка поставок активных и пассивных импортных электронных компонентов (более 30 млн. наименований);
- Поставка сложных, дефицитных, либо снятых с производства позиций;
- Оперативные сроки поставки под заказ (от 5 рабочих дней);
- Экспресс доставка в любую точку России;
- Помощь Конструкторского Отдела и консультации квалифицированных инженеров;
- Техническая поддержка проекта, помощь в подборе аналогов, поставка прототипов;
- Поставка электронных компонентов под контролем ВП;
- Система менеджмента качества сертифицирована по Международному стандарту ISO 9001;
- При необходимости вся продукция военного и аэрокосмического назначения проходит испытания и сертификацию в лаборатории (по согласованию с заказчиком);
- Поставка специализированных компонентов военного и аэрокосмического уровня качества (Xilinx, Altera, Analog Devices, Intersil, Interpoint, Microsemi, Actel, Aeroflex, Peregrine, VPT, Syfer, Eurofarad, Texas Instruments, MS Kennedy, Miteq, Cobham, E2V, MA-COM, Hittite, Mini-Circuits, General Dynamics и др.);

Компания «Океан Электроники» является официальным дистрибьютором и эксклюзивным представителем в России одного из крупнейших производителей разъемов военного и аэрокосмического назначения «JONHON», а так же официальным дистрибьютором и эксклюзивным представителем в России производителя высокотехнологичных и надежных решений для передачи СВЧ сигналов «FORSTAR».



JONHON

«JONHON» (основан в 1970 г.)

Разъемы специального, военного и аэрокосмического назначения:

(Применяются в военной, авиационной, аэрокосмической, морской, железнодорожной, горно- и нефтедобывающей отраслях промышленности)

«FORSTAR» (основан в 1998 г.)

ВЧ соединители, коаксиальные кабели, кабельные сборки и микроволновые компоненты:

(Применяются в телекоммуникациях гражданского и специального назначения, в средствах связи, РЛС, а так же военной, авиационной и аэрокосмической отраслях промышленности).



Телефон: 8 (812) 309-75-97 (многоканальный)

Факс: 8 (812) 320-03-32

Электронная почта: ocean@oceanchips.ru

Web: <http://oceanchips.ru/>

Адрес: 198099, г. Санкт-Петербург, ул. Калинина, д. 2, корп. 4, лит. А