

## Index

### Series Swisstac

<b>Description</b>	<b>Page 583</b>
<b>Product Assembly</b>	<b>Page 584</b>
<b>Mounting Instruction</b>	<b>Page 585</b>
<b>Product Range</b>	
- pushbuttons for standard mounting	<b>Page 591</b>
- pushbuttons for flush mounting	<b>Page 608</b>
- accessories / spare parts	<b>Page 622</b>
<b>Technical Data</b>	<b>Page 638</b>
<b>Drawing / Dimension / Layouts</b>	<b>Page 642</b>
<b>Circuit Drawing</b>	<b>Page 657</b>
<b>Marking</b>	<b>Page 667</b>

## SWISSTAC - Three crucial advantages!

Easy storage in minimum space  
Every SWISSTAC switch can be altered very simply any number of times, and afterwards added to, modified or adapted. This highly modular concept means that only a few subassemblies reducing storage costs.

## All connections on one plane

All the terminals are arranged at the same level, are clearly laid out and fully accessible even when in close-packed arrays. Three colours provide optical help to make connections easier.

## Ideal for switch interlock systems

SWISSTAC switches can be mechanically combined in many ways to form switch interlock systems and in fact in rows of up to 20 switches. This means that complicated protection and relay interlocks are unnecessary. Individual and irregular spacings between the switches of an array are no problem either.

## CE

Our products are marked with the internationally approved CE low-voltage safety standard.

## General information

Swisstac, a modularly constructed control switch system, offers the user a wide range of products: buzzers, illuminated pushbuttons and pushbuttons, indicators, emergency stop switches, push-pull illuminated switches, keylock switches and selector switches, as well as switch interlock systems in the front-facing protection classes IP 40 and IP 65.

The front dimensions of the switch units are: 18 mm dia., 18 x 18 mm, 24 mm dia., 24 x 24 mm. For flush mounting, dimensions 25 mm dia., 24 x 24 mm, 24 x 30 mm are also available.

## Construction

SWISSTAC switches are of modular construction and are divided into the following three groups:

- Front section: Man/switch interface and status indicator two-part lens for engraving, film insert or printing
- Intermediate section: Latching/ pulse facility, lamp holder, latch function
- Intermediate section with switching mechanism and lamp holder, which is available in two versions: T: 5.5 max., 1.2 W and midget grooved T 1 3/4 max.

1.2 W.

- Terminal block: up to a max. of five switching elements can be joined together in one switch terminal block. Are supplied mounted serially on intermediate sections.

Can be disassembled easily for wiring.

## Marking

Engraved, printed film inlay see under 'Marking' page 667.

## Illumination

Perfect illumination of the lenses supplied in various colours is guaranteed by the incandescent lamps midget grooved T 1 3/4 and T 5.5 (6-60V9).

Where supply voltages are over 60 V, a voltage-reduction element (ext. protective series resistor or capacitor) must be used. Because of high surface temperature, the protective series resistor may not be soldered direct onto the connections of the pushbuttons.

Multi-LED midget grooved T 1 3/4 and T 5.5 (6, 12, 24, 48 V) are available in the colours red, yellow and green.

## Switch position indicator

When the pushbutton with latch function is operated, the lens latches in mechanically. The position of the lens makes the switch position evident at all the times.

## Keylock switches

Standard lock

1 Standard number is B2 300. We supply B2 300 without specifications of the lock numbers. Four further standard locks are B2 301 - B2 304. This additional designation should be quoted when ordering. A further 95 locks are available in or without passepartout version on request. 2 keys are supplied per keylock switch.

Spare keys for a standard lock can be ordered under Type no. 240-2001-00 (please quote lock number). Example: 240-200-00 B2 300.

## Emergency stop switch with key to unlock

Standard lock is B2 390. Four further standard locks are B2 391 - B2-394. When ordering this additional designation should be quoted. Spare keys for standard lock can be ordered under Type no. 240-3001-00 (please quote lock). Example: 240-3001-00 B2 390.

Two keys are supplied per emergency stop switch.

## Emergency Stop Switch, foolproof with key to unlock

Kaba safety switch. Standard lock number is 1001. Spare keys can be ordered under Type no. 240.4001-00 1001.

2 keys are supplied per emergency stop switches.

All measurements in mm

Technical specifications subject to modification.

illuminated-/pushbutton



- 1 lens
- 2 front bezel
- 3 fixing nut
- 4 spring with pin for changing from maintained to momentary
- 5 intermediate section
- 6 holder for switching element
- 7 switching element block
- 8 switching element

pushbutton-/illuminated pushbutton for flush mounting



- 1 lens
- 2 front bezel
- 3 front bezel set f. fl. mounting
- 4 front panel
- 5 fixing nut
- 6 spring with pin f. changing from main to mom
- 7 intermediate section
- 8 holder f. switching element
- 9 switching element block
- 10 switching element

## illuminated-/pushbutton 35mm

The switch is mounted in a fascia or control panel in three steps:

1. Detach terminal block as in drawing, remove fixing nut
2. Insert switch from the front in fascia/control panel
3. Reassemble the switch in the reverse order

To detach terminal block

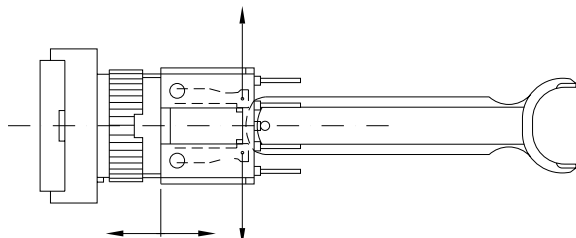

Note: Type-identification on legs of actuator

## illuminated-/pushbutton 55 - 70 mm

The switch is mounted in a fascia/control panel in two steps:

1. Insert switch from back side in fascia/control panel
2. Snap on bezel and tighten fixing nut

Lens

Bezel

Illuminated pushbutton

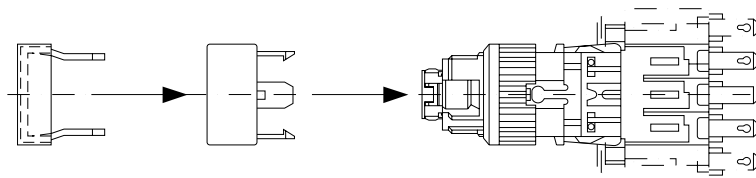

## illuminated-/pushbutton 55 - 70 mm sealing gland and -ring

The first time the button is pressed, the gland is forced into its groove and becomes effective.

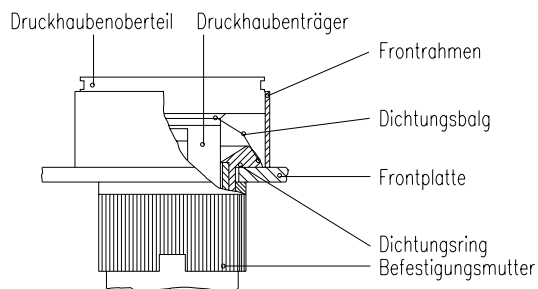

## indicator 30 - 70 mm

The indicator is mounted in a fascia/control panel in two steps:

1. Insert indicator from back side in fascia/control panel
2. Snap on bezel and tighten fixing nut



## indicator 30 - 70 mm sealing gland, -ring and press ring

The press ring is fitted between gland and lens. The seal is effective when the lens is snapped into place.



## emergency stop switch turn to release 55 - 70 mm

The switch is mounted in a fascia or control panel in three steps:

1. Detach front section just in released position, as in drawing
2. Insert switch from back side in fascia/control panel
3. Snap on front section and tighten fixing nut

### Important for IP 65

With models to IP 65, the sealing ring 1) is already fitted. This must be removed if the SWISSTAC emergency Stop identity plate (IP 65 model) is used.

Sealing ring 2) is fitted as standard in models to IP 65.

Zero position      Identity plate      Wiring diagram



## emergency stop switch with key release 55 - 70 mm

The switch is mounted in a fascia or control panel in three steps:

1. Detach front section, just in released position, as in drawing, remove fixing nut
2. Insert switch from back side in fascia/control panel
3. Snap on front section and tighten fixing nut

### Important for IP 65

With models to IP 65, the sealing ring1) is already fitted  
This must be removed if the SWISSTAC emergency  
Stop identity plate (IP 65 model) is used.

Sealing ring2) is fitted as standard  
in models to IP 65.

Zero position

Identity plate

Wiring diagram



## emergency stop switch foolproof

Hint for mounting: the torque with which the fixing nut is tightened must not exceed 50 Ncm.

Hint for dismounting: dismantling of switching element just with dismantling tool.



## keylock switch 45mm

The switch is mounted in a fascia or control panel in three steps:

1. Detach terminal block as in drawing, remove fixing nut
2. Insert switch from front side in fascia/control panel
3. Reassemble the switch in the reverse order

To detach terminal block



## keylock switch 55 mm

The switch is mounted in a fascia/control panel in three steps:

1. Remove front section as in drawing
2. Insert switch from back side in fascia/control panel
3. Snap on front section (see Note) and tighten fixing nut

Zero position

Wiring diagram

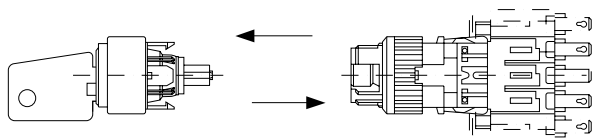

To assemble, the key must be at the zero position, the symbol **0** is at the top, and on the terminal block the circuit diagram is uppermost.

## keylock switch 70 mm

The switch is mounted in a fascia/control panel in three steps:

1. Remove front section as in drawing
2. Insert switch from back side in fascia/control panel
3. Snap on front section (see Note) and tighten fixing nut.

Zero position

Wiring diagram

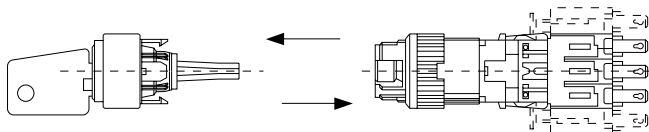

To assemble, the key must be at the zero position, the symbol **0** is at the top, and on the terminal block the circuit diagram is uppermost.

## selector switch 45 mm

The switch is mounted in a fascia or control panel in three steps:

1. Detach terminal block as in drawing, remove fixing nut
2. Insert switch from front side in fascia/control panel
3. Reassemble the switch in the reverse order

To detach terminal block





## selector switch 55 mm

The switch is mounted in a fascia/control panel in three steps:

1. Remove front section as in drawing
2. Insert switch from back side in fascia/control panel
3. Snap on front section (see Note) and tighten fixing nut

Zero position

Wiring diagram



To assemble, the lever must be at the zero position, the symbol **0** is as the top, and on the terminal block the circuit diagram is uppermost.

## selector switch 70 mm

The switch is mounted in a fascia/control panel in three steps:

1. Remove front section as in drawing
2. Insert switch from back side in fascia/control panel
3. Snap on front section (see Note) and tighten fixing nut

Zero position

Wiring diagram



To assemble, the lever must be at the zero position, the symbol **0** is at the top, and on the terminal block the circuit diagram is uppermost.

## push pull illuminated switch

The switch is mounted in a fascia or control panel in three steps:

1. Detach terminal block as in drawing, remove fixing nut
2. Insert switch from back side in fascia/control panel
3. Reassemble the switch in the reverse order

Push-Pull knob

To detach terminal block



Push-pull knob can be mounted in only one position. Zero position Wiring diagram

## buzzer 30 - 55 mm

The alarmbuzzer is mounted in a fascia/control panel in two steps:

1. Insert alarmbuzzer from backside in fascia/control panel
2. snap on bezel and tighten fixing nut

buzzerelement

bezel

buzzerhousing

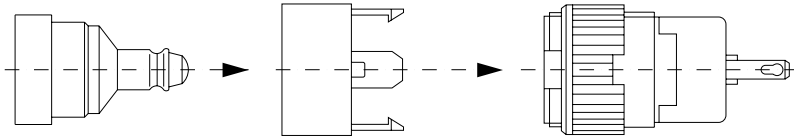

## indicator actuator 35 mm



- 🛒 lens for 35 mm page 622
- 🛒 lamp element block for 35 mm page 632
- 🛒 filament lamp MG T 1 3/4 page 634
- 🛒 LED MG T 1 3/4 page 634

	degree of protection	□ 18 x 24 mm Typ-Nr.	∅ 18 x 18 mm Typ-Nr.	18 mm dia. Typ-Nr.	circuit drawing	technical drawing	mounting dimensions	component layout	📄
<b>indicator actuator 35 mm</b> lampholder MG T 1 3/4	IP 40	<b>690-6000-00</b>	<b>690-4000-00</b>	<b>690-2000-00</b>	1	1	1	1	0,004
	IP 65	<b>690-6000-W0</b>	<b>690-4000-W0</b>	<b>690-2000-W0</b>	1	1	2	1	0,005

circuit drawings from page 657, technical drawings from page 642, mounting dimensions from page 652, component layouts from page 657

## indicator 30 - 70 mm

protection degree IP 40/IP 65 is determined by front bezel and lens



- 🛒 lens page 623
- 🛒 front bezel for illuminated-/pushbutton 55 - 70 mm and indicator 30 - 70 mm page 627
- 🛒 pressure ring page 630
- 🛒 filament lamp MG T 1 3/4 page 634
- 🛒 LED MG T 1 3/4 page 634
- 🛒 filament lamp T 5.5 page 634
- 🛒 LED T 5.5 page 635

	mounting depth	connection method	lamp socket	part no.	circuit drawing	technical drawing	mounting dimensions	component layout	📄
<b>indicator 30 - 70 mm</b>	30 mm	-	MG T 1 3/4	<b>990-.000-K0</b>	1	2	3		0,004
	45 mm	-	T 5.5	<b>890-.000-K0</b>	1	3	3		0,006
	52 mm	P	MG T 1 3/4	<b>990-.000-0P</b>	1	4	3	1	0,007
	55 mm	-	MG T 1 3/4	<b>990-.000-00</b>	1	5	3		0,007
	67 mm	P	T 5.5	<b>890-.000-0P</b>	1	6	3	1	0,010
	70 mm	-	T 5.5	<b>890-.000-00</b>	1	7	3		0,010

connection method : soldering-/plug-in terminal = -, PCB terminal = P

The indicators 55 mm and 70 mm are as long as the corresponding illuminated pushbuttons and fit to the PCB plug-in base and multi-plug housing.  
circuit drawings from page 657, technical drawings from page 642, mounting dimensions from page 652, component layouts from page 657

## pushbutton-/illuminated pushbutton actuator 35 mm



🛒 lens for 35 mm page 622

🛒 filament lamp MG T 1 3/4 page 634

🛒 LED MG T 1 3/4 page 634

🛒 snap-action switching element block for 35 mm page 631

	degree of protection	switching action	□ 18 x 24 mm Typ-Nr.	⊕ 18 x 18 mm Typ-Nr.	18 mm dia. Typ-Nr.	circuit drawing	technical drawing	mounting dimensions	component layout	
<b>pushbutton-/illuminated pushbutton actuator 35 mm</b> lampholder MG T 1 3/4	IP 40	M	<b>680-6000-00</b>	<b>680-4000-00</b>	<b>680-2000-00</b>	2	1	1	1	0,004
		MA	<b>600-6000-00</b>	<b>600-4000-00</b>	<b>600-2000-00</b>	3	1	1	1	0,004
	IP 65	M	<b>680-6000-W0</b>	<b>680-4000-W0</b>	<b>680-2000-W0</b>	2	1	2	1	0,005
		MA	<b>600-6000-W0</b>	<b>600-4000-W0</b>	<b>600-2000-W0</b>	3	1	2	1	0,005

switching action : momentary action = M, maintained action = MA (changeable to momentary action, reversible)

circuit drawings from page 657, technical drawings from page 642, mounting dimensions from page 652, component layouts from page 657

## illuminated-/pushbutton 55 - 70 mm

protection degree IP 40/IP 65 is determined by front bezel and lens



- 🛒 lens page 623
- 🛒 front bezel for illuminated-/pushbutton 55 - 70 mm and indicator 30 - 70 mm page 627
- 🛒 filament lamp MG T 1 3/4 page 634
- 🛒 filament lamp T 5.5 page 634
- 🛒 LED T 5.5 page 635

	mounting depth	contacts	switching action	connection method	lamp socket	part no.	circuit drawing	technical drawing	mounting dimensions	component layout	
<b>illuminated-/pushbutton 55 - 70 mm</b>	52 mm	1 NC + 1 NO	MA	P	MG T 1 3/4	<b>901-.000-0P</b>	4	8	3	1	0,013
		2 NC + 2 NO	MA	P	MG T 1 3/4	<b>902-.000-0P</b>	5	8	3	1	0,014
		3 NC + 3 NO	MA	P	MG T 1 3/4	<b>903-.000-0P</b>	6	8	3	1	0,014
		4 NC + 4 NO	MA	P	MG T 1 3/4	<b>904-.000-0P</b>	7	8	3	1	0,018
		5 NC + 5 NO	MA	P	MG T 1 3/4	<b>905-.000-0P</b>	8	8	3	1	0,021
	55 mm	1 NC + 1 NO	MA	-	MG T 1 3/4	<b>901-.000-00</b>	4	9	3		0,013
		2 NC + 2 NO	MA	-	MG T 1 3/4	<b>902-.000-00</b>	5	9	3		0,014
		3 NC + 3 NO	MA	-	MG T 1 3/4	<b>903-.000-00</b>	6	9	3		0,015
		4 NC + 4 NO	MA	-	MG T 1 3/4	<b>904-.000-00</b>	7	9	3		0,019
		5 NC + 5 NO	MA	-	MG T 1 3/4	<b>905-.000-00</b>	8	9	3		0,022
	67 mm	1 NC + 1 NO	MA	P	T 5.5	<b>801-.000-0P</b>	4	10	3	1	0,015
		2 NC + 2 NO	MA	P	T 5.5	<b>802-.000-0P</b>	5	10	3	1	0,016
		3 NC + 3 NO	MA	P	T 5.5	<b>803-.000-0P</b>	6	10	3	1	0,017
		4 NC + 4 NO	MA	P	T 5.5	<b>804-.000-0P</b>	7	10	3	1	0,020
		5 NC + 5 NO	MA	P	T 5.5	<b>805-.000-0P</b>	8	10	3	1	0,023
	70 mm	1 NC + 1 NO	MA	-	T 5.5	<b>801-.000-00</b>	4	11	3		0,015
		2 NC + 2 NO	MA	-	T 5.5	<b>802-.000-00</b>	5	11	3		0,016
		3 NC + 3 NO	MA	-	T 5.5	<b>803-.000-00</b>	6	11	3		0,017
		4 NC + 4 NO	MA	-	T 5.5	<b>804-.000-00</b>	7	11	3		0,021
		5 NC + 5 NO	MA	-	T 5.5	<b>805-.000-00</b>	8	11	3		0,024

contacts : normally closed = NC, normally open = NO

switching action : maintained action = MA (changeable to momentary action, reversible)

connection method : PCB terminal = P, soldering-/plug-in terminal = -

circuit drawings from page 657, technical drawings from page 642, mounting dimensions from page 652, component layouts from page 657

## emergency stop switch 55 - 70 mm



🛒 label for emergency stop switch page 636

	unlocking	degree of protection	mounting depth	contacts	connection method	24 mm dia. Typ-Nr.	circuit drawing	technical drawing	mounting dimensions	component layout	
<b>emergency stop switch 55 - 70 mm</b> according to VDE max. 2 NC are permitted	twist to release	IP 40	52 mm	1 NC	P	<b>951+2000-0P</b>	9	12	4	1	0,018
				2 NC	P	<b>952+2000-0P</b>	10	12	4	1	0,019
				3 NC	P	<b>953+2000-0P</b>	11	12	4	1	0,020
			55 mm	1 NC	-	<b>951+2000-00</b>	9	13	4		0,018
				2 NC	-	<b>952+2000-00</b>	10	13	4		0,019
				3 NC	-	<b>953+2000-00</b>	11	13	4		0,020
			67 mm	1 NC	P	<b>851+2000-0P</b>	9	14	4	1	0,021
				2 NC	P	<b>852+2000-0P</b>	10	14	4	1	0,022
				3 NC	P	<b>853+2000-0P</b>	11	14	4	1	0,023
			70 mm	1 NC	-	<b>851+2000-00</b>	9	15	4		0,021
				2 NC	-	<b>852+2000-00</b>	10	15	4		0,022
				3 NC	-	<b>853+2000-00</b>	11	15	4		0,023
		IP 65	52 mm	1 NC	P	<b>951+2000-WP</b>	9	12	5	1	0,018
				2 NC	P	<b>952+2000-WP</b>	10	12	5	1	0,019
				3 NC	P	<b>953+2000-WP</b>	11	12	5	1	0,020
			55 mm	1 NC	-	<b>951+2000-W0</b>	9	13	5		0,018
				2 NC	-	<b>952+2000-W0</b>	10	13	5		0,019
				3 NC	-	<b>953+2000-W0</b>	11	13	5		0,020
			67 mm	1 NC	P	<b>851+2000-WP</b>	9	14	5	1	0,021
				2 NC	P	<b>852+2000-WP</b>	10	14	5	1	0,022
				3 NC	P	<b>853+2000-WP</b>	11	14	5	1	0,023
			70 mm	1 NC	-	<b>851+2000-W0</b>	9	15	5		0,021
				2 NC	-	<b>852+2000-W0</b>	10	15	5		0,022
				3 NC	-	<b>853+2000-W0</b>	11	15	5		0,023

Continued on next page

	unlocking	degree of protection	mounting depth	contacts	connection method	24 mm dia. Typ-Nr.	circuit drawing	technical drawing	mounting dimensions	component layout	
<b>emergency stop switch 55 - 70 mm</b> standard lock B2 390, other lock numbers on request according to VDE max. 2 NC are permitted	key to release	IP 40	52 mm	1 NC	P	<b>961+2401-0P</b>	9	12	4	1	0,030
				2 NC	P	<b>962+2401-0P</b>	10	12	4	1	0,031
				3 NC	P	<b>963+2401-0P</b>	11	12	4	1	0,032
			55 mm	1 NC	-	<b>961+2401-00</b>	9	13	4		0,030
				2 NC	-	<b>962+2401-00</b>	10	13	4		0,031
				3 NC	-	<b>963+2401-00</b>	11	13	4		0,032
			67 mm	1 NC	P	<b>861+2401-0P</b>	9	14	4	1	0,033
				2 NC	P	<b>862+2401-0P</b>	10	14	4	1	0,034
				3 NC	P	<b>863+2401-0P</b>	11	14	4	1	0,035
			70 mm	1 NC	-	<b>861+2401-00</b>	9	15	4		0,033
				2 NC	-	<b>862+2401-00</b>	10	15	4		0,034
				3 NC	-	<b>863+2401-00</b>	11	15	4		0,035
		IP 65	52 mm	1 NC	P	<b>961+2401-WP</b>	9	12	5	1	0,030
				2 NC	P	<b>962+2401-WP</b>	10	12	5	1	0,031
				3 NC	P	<b>963+2401-WP</b>	11	12	5	1	0,032
			55 mm	1 NC	-	<b>961+2401-W0</b>	9	13	5		0,030
				2 NC	-	<b>962+2401-W0</b>	10	13	5		0,031
				3 NC	-	<b>963+2401-W0</b>	11	13	5		0,032
			67 mm	1 NC	P	<b>861+2401-WP</b>	9	14	5	1	0,033
				2 NC	P	<b>862+2401-WP</b>	10	14	5	1	0,034
				3 NC	P	<b>863+2401-WP</b>	11	14	5	1	0,035
			70 mm	1 NC	-	<b>861+2401-W0</b>	9	15	5		0,033
				2 NC	-	<b>862+2401-W0</b>	10	15	5		0,034
				3 NC	-	<b>863+2401-W0</b>	11	15	5		0,035

contacts : 1 normally closed = 1 NC, normally closed = NC

connection method : PCB terminal = P, soldering-/plug-in terminal = -

hint:

- we recommend to use location strip no. 260-0020-00 for anti-twisting of the front bezel.

- at momentary position the overturning force is max. 60 Ncm.

circuit drawings from page 657, technical drawings from page 642, mounting dimensions from page 652, component layouts from page 657

## emergency stop switch foolproof 41 mm

according to EN 418



label for emergency stop switch page 636

	unlocking	degree of protection	mounting depth	contacts	connection method	27 mm dia. Typ-Nr.	circuit drawing	technical drawing	mounting dimensions	
<b>emergency stop switch foolproof 41 mm</b>	twist to release	IP 65	41 mm	1 NC	-	<b>551-8000-W0</b>	12	16	6	0,025
				1 NC + 1 NO	-	<b>553-8000-W0</b>	13	16	6	0,025
				2 NC	-	<b>552-8000-W0</b>	14	16	6	0,025
standard lock 1001	key to release	IP 65	41 mm	1 NC	-	<b>561-8101-W0</b>	12	16	6	0,047
				1 NC + 1 NO	-	<b>563-8101-W0</b>	13	16	6	0,047
				2 NC	-	<b>562-8101-W0</b>	14	16	6	0,047

contacts : 1 normally closed = 1 NC, normally closed = NC, normally open = NO

connection method : soldering-/plug-in terminal = -

Mounting hint: starting torque for fixing nut max. 50 Ncm

circuit drawings from page 657, technical drawings from page 642, mounting dimensions from page 652



## pushbutton with mushroom-head cap 55 - 70 mm



🛒 mushroom-head cap page 625

🛒 front bezel for mushroom-head pushbutton 55 - 70 mm page 628

	degree of protection	mounting depth	contacts	switching action	connection method	part no.	circuit drawing	technical drawing	mounting dimensions	component layout	
<b>pushbutton with mushroom-head cap 55 - 70 mm</b>	IP 40	52 mm	1 NC + 1 NO	maintained	P	<b>901-.000-0P</b>	15	17	7	1	0,013
			2 NC + 2 NO	maintained	P	<b>902-.000-0P</b>	16	17	7	1	0,014
			3 NC + 3 NO	maintained	P	<b>903-.000-0P</b>	17	17	7	1	0,014
			4 NC + 4 NO	maintained	P	<b>904-.000-0P</b>	18	17	7	1	0,018
			5 NC + 5 NO	maintained	P	<b>905-.000-0P</b>	19	17	7	1	0,021
		55 mm	1 NC + 1 NO	maintained	-	<b>901-.000-00</b>	15	18	7		0,013
			2 NC + 2 NO	maintained	-	<b>902-.000-00</b>	16	18	7		0,014
			3 NC + 3 NO	maintained	-	<b>903-.000-00</b>	17	18	7		0,015
			4 NC + 4 NO	maintained	-	<b>904-.000-00</b>	18	18	7		0,019
			5 NC + 5 NO	maintained	-	<b>905-.000-00</b>	19	18	7		0,022
		67 mm	1 NC + 1 NO	maintained	P	<b>801-.000-0P</b>	15	19	7	1	0,015
			2 NC + 2 NO	maintained	P	<b>802-.000-0P</b>	16	19	7	1	0,016
			3 NC + 3 NO	maintained	P	<b>803-.000-0P</b>	17	19	7	1	0,017
			4 NC + 4 NO	maintained	P	<b>804-.000-0P</b>	18	19	7	1	0,020
			5 NC + 5 NO	maintained	P	<b>805-.000-0P</b>	19	19	7	1	0,023
		70 mm	1 NC + 1 NO	maintained	-	<b>801-.000-00</b>	15	20	7		0,015
			2 NC + 2 NO	maintained	-	<b>802-.000-00</b>	16	20	7		0,016
			3 NC + 3 NO	maintained	-	<b>803-.000-00</b>	17	20	7		0,017
			4 NC + 4 NO	maintained	-	<b>804-.000-00</b>	18	20	7		0,021
			5 NC + 5 NO	maintained	-	<b>805-.000-00</b>	19	20	7		0,024

contacts : normally closed = NC, normally open = NO

switching action: maintained action = MA (changeable to momentary action, reversible)



connection method : PCB terminal = P, soldering-/plug-in terminal = -

circuit drawings from page 657, technical drawings from page 642, mounting dimensions from page 652, component layouts from page 657

## keylock switch 2 positions 45 - 70 mm

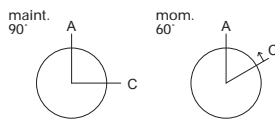

front cap for keylock-/selector switch 2 positions page 625

	degree of protection	mounting depth	contacts	switching action	connection method	key removable in	part no.	circuit drawing	technical drawing	mounting dimensions	component layout	
<b>keylock switch</b> <b>2 positions</b> 45 - 70 mm standard lock B2 300, other lock numbers on re- quest	IP 40	42 mm	1 NC + 1 NO	M	P	A	<b>781-.401-0P</b>	21	21	8	1	0,022
				MA	P	A	<b>771-.401-0P</b>	20	21	8	1	0,022
						A+C	<b>761-.401-0P</b>	20	21	8	1	0,022
			2 NC + 2 NO	M	P	A	<b>782-.401-0P</b>	23	21	8	1	0,023
				MA	P	A	<b>772-.401-0P</b>	22	21	8	1	0,023
						A+C	<b>762-.401-0P</b>	22	21	8	1	0,023
		45 mm	1 NC + 1 NO	M	-	A	<b>781-.401-00</b>	21	22	8		0,022
				MA	-	A	<b>771-.401-00</b>	20	22	8		0,022
						A+C	<b>761-.401-00</b>	20	22	8		0,022
			2 NC + 2 NO	M	-	A	<b>782-.401-00</b>	23	22	8		0,023
				MA	-	A	<b>772-.401-00</b>	22	22	8		0,023
						A+C	<b>762-.401-00</b>	22	22	8		0,023
		52 mm	1 NC + 1 NO	M	P	A	<b>931-.401-0P</b>	25	23	8	1	0,024
				MA	P	A	<b>921-.401-0P</b>	24	23	8	1	0,024
						A+C	<b>911-.401-0P</b>	24	23	8	1	0,024
			2 NC + 2 NO	M	P	A	<b>932-.401-0P</b>	23	23	8	1	0,025
				MA	P	A	<b>922-.401-0P</b>	22	23	8	1	0,025
						A+C	<b>912-.401-0P</b>	22	23	8	1	0,025
			3 NC + 3 NO	M	P	A	<b>933-.401-0P</b>	27	23	8	1	0,026
				MA	P	A	<b>923-.401-0P</b>	26	23	8	1	0,026
						A+C	<b>913-.401-0P</b>	26	23	8	1	0,026
			4 NC + 4 NO	M	P	A	<b>934-.401-0P</b>	29	23	8	1	0,029
				MA	P	A	<b>924-.401-0P</b>	28	23	8	1	0,029
						A+C	<b>914-.401-0P</b>	28	23	8	1	0,029
5 NC + 5 NO	M	P	A	<b>935-.401-0P</b>	31	23	8	1	0,032			
	MA	P	A	<b>925-.401-0P</b>	30	23	8	1	0,032			
			A+C	<b>915-.401-0P</b>	30	23	8	1	0,032			

Continued on next page



**keylock switch**  
**2 positions** 45 - 70 mm  
 standard lock B2 300,  
 other lock numbers on re-  
 quest

degree of protection	mounting depth	contacts	switching action	connection method	key removable in	part no.	circuit drawing	technical drawing	mounting dimensions	component layout	kg		
	55 mm	1 NC + 1 NO	M	-	A	<b>931-.401-00</b>	25	24	8		0,024		
			MA	-	A	<b>921-.401-00</b>	24	24	8		0,024		
				-	A+C	<b>911-.401-00</b>	24	24	8		0,024		
		2 NC + 2 NO	M	-	A	<b>932-.401-00</b>	23	24	8		0,025		
			MA	-	A	<b>922-.401-00</b>	22	24	8		0,025		
				-	A+C	<b>912-.401-00</b>	22	24	8		0,025		
		3 NC + 3 NO	M	-	A	<b>933-.401-00</b>	27	24	8		0,027		
			MA	-	A	<b>923-.401-00</b>	26	24	8		0,027		
				-	A+C	<b>913-.401-00</b>	26	24	8		0,027		
		4 NC + 4 NO	M	-	A	<b>934-.401-00</b>	29	24	8		0,030		
			MA	-	A	<b>924-.401-00</b>	28	24	8		0,030		
				-	A+C	<b>914-.401-00</b>	28	24	8		0,030		
		5 NC + 5 NO	M	-	A	<b>935-.401-00</b>	31	24	8		0,033		
			MA	-	A	<b>925-.401-00</b>	30	24	8		0,033		
				-	A+C	<b>915-.401-00</b>	30	24	8		0,033		
		67 mm	1 NC + 1 NO	M	P	A	<b>831-.401-0P</b>	25	25	8	1	0,026	
					MA	P	A	<b>821-.401-0P</b>	24	25	8	1	0,026
						P	A+C	<b>811-.401-0P</b>	24	25	8	1	0,026
	2 NC + 2 NO			M	P	A	<b>832-.401-0P</b>	23	25	8	1	0,027	
					MA	P	A	<b>822-.401-0P</b>	22	25	8	1	0,027
						P	A+C	<b>812-.401-0P</b>	22	25	8	1	0,027
	3 NC + 3 NO			M	P	A	<b>833-.401-0P</b>	27	25	8	1	0,028	
					MA	P	A	<b>823-.401-0P</b>	26	25	8	1	0,028
						P	A+C	<b>813-.401-0P</b>	26	25	8	1	0,028
	4 NC + 4 NO		M	P	A	<b>834-.401-0P</b>	29	25	8	1	0,031		
				MA	P	A	<b>824-.401-0P</b>	28	25	8	1	0,031	
					P	A+C	<b>814-.401-0P</b>	28	25	8	1	0,031	
	5 NC + 5 NO		M	P	A	<b>835-.401-0P</b>	31	25	8	1	0,034		
				MA	P	A	<b>825-.401-0P</b>	30	25	8	1	0,034	
					P	A+C	<b>815-.401-0P</b>	30	25	8	1	0,034	
70 mm	1 NC + 1 NO		M	-	A	<b>831-.401-00</b>	25	26	8		0,026		
				MA	-	A	<b>821-.401-00</b>	24	26	8		0,026	
					-	A+C	<b>811-.401-00</b>	24	26	8		0,026	
		2 NC + 2 NO	M	-	A	<b>832-.401-00</b>	23	26	8		0,027		
				MA	-	A	<b>822-.401-00</b>	22	26	8		0,027	
					-	A+C	<b>812-.401-00</b>	22	26	8		0,027	
		3 NC + 3 NO	M	-	A	<b>833-.401-00</b>	27	26	8		0,029		
				MA	-	A	<b>823-.401-00</b>	26	26	8		0,029	
					-	A+C	<b>813-.401-00</b>	26	26	8		0,029	
	4 NC + 4 NO	M	-	A	<b>834-.401-00</b>	29	26	8		0,032			
			MA	-	A	<b>824-.401-00</b>	28	26	8		0,032		
				-	A+C	<b>814-.401-00</b>	28	26	8		0,032		
	5 NC + 5 NO	M	-	A	<b>835-.401-00</b>	31	26	8		0,035			
			MA	-	A	<b>825-.401-00</b>	30	26	8		0,035		
				-	A+C	<b>815-.401-00</b>	30	26	8		0,035		

Continued on next page



	degree of protection	mounting depth	contacts	switching action	connection method	key removable in	part no.	circuit drawing	technical drawing	mounting dimensions	component layout		
<b>keylock switch</b> 2 positions 45 - 70 mm standard lock B2 300, other lock numbers on re- quest	IP 65	42 mm	1 NC + 1 NO	M	P	A	<b>781-.401-WP</b>	21	21	9	1	0,022	
				MA	P	A	<b>771-.401-WP</b>	20	21	9	1	0,022	
						A+C	<b>761-.401-WP</b>	20	21	9	1	0,022	
			2 NC + 2 NO	M	P	A	<b>782-.401-WP</b>	23	21	9	1	0,023	
				MA	P	A	<b>772-.401-WP</b>	22	21	9	1	0,023	
						A+C	<b>762-.401-WP</b>	22	21	9	1	0,023	
		45 mm	1 NC + 1 NO	M	-	A	<b>781-.401-WO</b>	21	22	9		0,022	
				MA	-	A	<b>771-.401-WO</b>	20	22	9		0,022	
						A+C	<b>761-.401-WO</b>	20	22	9		0,022	
			2 NC + 2 NO	M	-	A	<b>782-.401-WO</b>	23	22	9		0,023	
				MA	-	A	<b>772-.401-WO</b>	22	22	9		0,023	
						A+C	<b>762-.401-WO</b>	22	22	9		0,023	
		52 mm	1 NC + 1 NO	M	P	A	<b>931-.401-WP</b>	25	23	9	1	0,024	
				MA	P	A	<b>921-.401-WP</b>	24	23	9	1	0,024	
						A+C	<b>911-.401-WP</b>	24	23	9	1	0,024	
			2 NC + 2 NO	M	P	A	<b>932-.401-WP</b>	23	23	9	1	0,025	
				MA	P	A	<b>922-.401-WP</b>	22	23	9	1	0,025	
						A+C	<b>912-.401-WP</b>	22	23	9	1	0,025	
			3 NC + 3 NO	M	P	A	<b>933-.401-WP</b>	27	23	9	1	0,026	
				MA	P	A	<b>923-.401-WP</b>	26	23	9	1	0,026	
						A+C	<b>913-.401-WP</b>	26	23	9	1	0,026	
			4 NC + 4 NO	M	P	A	<b>934-.401-WP</b>	29	23	9	1	0,029	
				MA	P	A	<b>924-.401-WP</b>	28	23	9	1	0,029	
						A+C	<b>914-.401-WP</b>	28	23	9	1	0,029	
			5 NC + 5 NO	M	P	A	<b>935-.401-WP</b>	31	23	9	1	0,032	
				MA	P	A	<b>925-.401-WP</b>	30	23	9	1	0,032	
						A+C	<b>915-.401-WP</b>	30	23	9	1	0,032	
			55 mm	1 NC + 1 NO	M	-	A	<b>931-.401-WO</b>	25	24	9		0,024
					MA	-	A	<b>921-.401-WO</b>	24	24	9		0,024
							A+C	<b>911-.401-WO</b>	24	24	9		0,024
		2 NC + 2 NO		M	-	A	<b>932-.401-WO</b>	23	24	9		0,025	
				MA	-	A	<b>922-.401-WO</b>	22	24	9		0,025	
						A+C	<b>912-.401-WO</b>	22	24	9		0,025	
		3 NC + 3 NO		M	-	A	<b>933-.401-WO</b>	27	24	9		0,027	
				MA	-	A	<b>923-.401-WO</b>	26	24	9		0,027	
						A+C	<b>913-.401-WO</b>	26	24	9		0,027	
		4 NC + 4 NO		M	-	A	<b>934-.401-WO</b>	29	24	9		0,030	
				MA	-	A	<b>924-.401-WO</b>	28	24	9		0,030	
						A+C	<b>914-.401-WO</b>	28	24	9		0,030	
		5 NC + 5 NO		M	-	A	<b>935-.401-WO</b>	31	24	9		0,033	
				MA	-	A	<b>925-.401-WO</b>	30	24	9		0,033	
						A+C	<b>915-.401-WO</b>	30	24	9		0,033	

Continued on next page

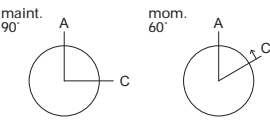

keylock switch 2 positions 45 - 70 mm standard lock B2 300, other lock numbers on re- quest	degree of protec- tion	mounting depth	contacts	switching action	connection method	key removable in	part no.	circuit drawing	technical drawing	mounting dimensions	component layout	kg/H	
		67 mm	1 NC + 1 NO	M	P	A	<b>831-.401-WP</b>	25	25	9	1	0,026	
				MA	P	A	<b>821-.401-WP</b>	24	25	9	1	0,026	
						A+C	<b>811-.401-WP</b>	24	25	9	1	0,026	
			2 NC + 2 NO	M	P	A	<b>832-.401-WP</b>	23	25	9	1	0,027	
				MA	P	A	<b>822-.401-WP</b>	22	25	9	1	0,027	
						A+C	<b>812-.401-WP</b>	22	25	9	1	0,027	
			3 NC + 3 NO	M	P	A	<b>833-.401-WP</b>	27	25	9	1	0,028	
				MA	P	A	<b>823-.401-WP</b>	26	25	9	1	0,028	
						A+C	<b>813-.401-WP</b>	26	25	9	1	0,028	
			4 NC + 4 NO	M	P	A	<b>834-.401-WP</b>	29	25	9	1	0,031	
				MA	P	A	<b>824-.401-WP</b>	28	25	9	1	0,031	
						A+C	<b>814-.401-WP</b>	28	25	9	1	0,031	
		5 NC + 5 NO	M	P	A	<b>835-.401-WP</b>	31	25	9	1	0,034		
			MA	P	A	<b>825-.401-WP</b>	30	25	9	1	0,034		
					A+C	<b>815-.401-WP</b>	30	25	9	1	0,034		
		70 mm		1 NC + 1 NO	M	-	A	<b>831-.401-WO</b>	25	26	9		0,026
					MA	-	A	<b>821-.401-WO</b>	24	26	9		0,026
							A+C	<b>811-.401-WO</b>	24	26	9		0,026
				2 NC + 2 NO	M	-	A	<b>832-.401-WO</b>	23	26	9		0,027
					MA	-	A	<b>822-.401-WO</b>	22	26	9		0,027
							A+C	<b>812-.401-WO</b>	22	26	9		0,027
				3 NC + 3 NO	M	-	A	<b>833-.401-WO</b>	27	26	9		0,029
					MA	-	A	<b>823-.401-WO</b>	26	26	9		0,029
							A+C	<b>813-.401-WO</b>	26	26	9		0,029
4 NC + 4 NO	M			-	A	<b>834-.401-WO</b>	29	26	9		0,032		
	MA			-	A	<b>824-.401-WO</b>	28	26	9		0,032		
					A+C	<b>814-.401-WO</b>	28	26	9		0,032		
5 NC + 5 NO	M	-	A	<b>835-.401-WO</b>	31	26	9		0,035				
	MA	-	A	<b>825-.401-WO</b>	30	26	9		0,035				
			A+C	<b>815-.401-WO</b>	30	26	9		0,035				

contacts : normally closed = NC, normally open = NO

switching action : maintained action = MA, momentary action = M

connection method : PCB terminal = P, soldering-/plug-in terminal = -

other key removable combination on request

hint:

- we recommend to use location strip no. 260-0020-00 for anti-twisting of the front bezel.

- at momentary position the overturning force is max. 60 Ncm.

circuit drawings from page 657, technical drawings from page 642, mounting dimensions from page 652, component layouts from page 657

## keylock switch 3 positions 45 mm



front cap for keylock-/selector switch 3 positions page 626

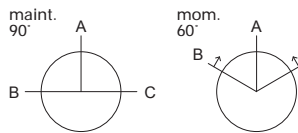

	degree of protection	mounting depth	contacts	switching action	connection method	key removable in	part no.	circuit drawing	technical drawing	mounting dimensions	component layout	
<b>keylock switch 3 positions 45 mm</b> standard lock B2 300, other lock numbers on request	IP 40	42 mm	2 NC + 2 NO	0 - MA - MA	P	B+A+C	<b>722-.401-0P</b>	32	21	8	1	0,023
				M - 0 - M	P	A	<b>732-.401-0P</b>	33	21	8	1	0,023
				M - 0 - MA	P	A+C	<b>752-.401-0P</b>	35	21	8	1	0,023
				MA - 0 - M	P	B+A	<b>742-.401-0P</b>	34	21	8	1	0,023
				MA - 0 - MA	P	B+A+C	<b>712-.401-0P</b>	32	21	8	1	0,023
		45 mm	2 NC + 2 NO	0 - MA - MA	-	B+A+C	<b>722-.401-00</b>	32	22	8		0,023
				M - 0 - M	-	A	<b>732-.401-00</b>	33	22	8		0,023
				M - 0 - MA	-	A+C	<b>752-.401-00</b>	35	22	8		0,023
				MA - 0 - M	-	B+A	<b>742-.401-00</b>	34	22	8		0,023
				MA - 0 - MA	-	B+A+C	<b>712-.401-00</b>	32	22	8		0,023
	IP 65	42 mm	2 NC + 2 NO	0 - MA - MA	P	B+A+C	<b>722-.401-WP</b>	32	21	9	1	0,023
				M - 0 - M	P	A	<b>732-.401-WP</b>	33	21	9	1	0,023
				M - 0 - MA	P	A+C	<b>752-.401-WP</b>	35	21	9	1	0,023
				MA - 0 - M	P	B+A	<b>742-.401-WP</b>	34	21	9	1	0,023
				MA - 0 - MA	P	B+A+C	<b>712-.401-WP</b>	32	21	9	1	0,023
		45 mm	2 NC + 2 NO	0 - MA - MA	-	B+A+C	<b>722-.401-W0</b>	32	22	9		0,023
M - 0 - M				-	A	<b>732-.401-W0</b>	33	22	9		0,023	
M - 0 - MA				-	A+C	<b>752-.401-W0</b>	35	22	9		0,023	
MA - 0 - M				-	B+A	<b>742-.401-W0</b>	34	22	9		0,023	
MA - 0 - MA				-	B+A+C	<b>712-.401-W0</b>	32	22	9		0,023	

contacts : normally closed = NC, normally open = NO

switching action: maintained action = MA, momentary action = M

connection method : PCB terminal = P, soldering-/plug-in terminal = -

other key removable combination on request

hint:

- we recommend to use location strip no. 260-0020-00 for anti-twisting of the front bezel.

- at momentary position the overturning force is max. 60 Ncm.

circuit drawings from page 657, technical drawings from page 642, mounting dimensions from page 652, component layouts from page 657

## selector switch 2 positions 45 - 70 mm



🛒 front cap for keylock-/selector switch 2 positions page 625

🛒 lever page 627



selector switch 2 positions 45 - 70 mm	degree of protection	mounting depth	contacts	switching action	connection method	part no.	circuit drawing	technical drawing	mounting dimensions	component layout	📄	
selector switch 2 positions 45 - 70 mm	IP 40	42 mm	1 NC + 1 NO	M	P	<b>781-.700-0P</b>	37	27	10	1	0,011	
				MA	P	<b>761-.700-0P</b>	36	27	10	1	0,011	
			2 NC + 2 NO	M	P	<b>782-.700-0P</b>	39	27	10	1	0,012	
				MA	P	<b>762-.700-0P</b>	38	27	10	1	0,012	
		45 mm	1 NC + 1 NO	M	-	<b>781-.700-00</b>	37	28	10		0,011	
				MA	-	<b>761-.700-00</b>	36	28	10		0,011	
			2 NC + 2 NO	M	-	<b>782-.700-00</b>	39	28	10		0,012	
				MA	-	<b>762-.700-00</b>	38	28	10		0,012	
			52 mm	1 NC + 1 NO	M	P	<b>931-.700-0P</b>	41	29	10	1	0,013
					MA	P	<b>911-.700-0P</b>	40	29	10	1	0,013
		2 NC + 2 NO		M	P	<b>932-.700-0P</b>	39	29	10	1	0,014	
				MA	P	<b>912-.700-0P</b>	38	29	10	1	0,014	
		3 NC + 3 NO		M	P	<b>933-.700-0P</b>	43	29	10	1	0,015	
				MA	P	<b>913-.700-0P</b>	42	29	10	1	0,015	
		4 NC + 4 NO		M	P	<b>934-.700-0P</b>	45	29	10	1	0,018	
				MA	P	<b>914-.700-0P</b>	44	29	10	1	0,018	
		5 NC + 5 NO		M	P	<b>935-.700-0P</b>	47	29	10	1	0,022	
				MA	P	<b>915-.700-0P</b>	46	29	10	1	0,022	
		55 mm	1 NC + 1 NO	M	-	<b>931-.700-00</b>	41	30	10		0,013	
				MA	-	<b>911-.700-00</b>	40	30	10		0,013	
			2 NC + 2 NO	M	-	<b>932-.700-00</b>	39	30	10		0,014	
				MA	-	<b>912-.700-00</b>	38	30	10		0,014	
			3 NC + 3 NO	M	-	<b>933-.700-00</b>	43	30	10		0,015	
				MA	-	<b>913-.700-00</b>	42	30	10		0,015	
			4 NC + 4 NO	M	-	<b>934-.700-00</b>	45	30	10		0,019	
				MA	-	<b>914-.700-00</b>	44	30	10		0,019	
			5 NC + 5 NO	M	-	<b>935-.700-00</b>	47	30	10		0,023	
				MA	-	<b>915-.700-00</b>	46	30	10		0,023	
		67 mm	1 NC + 1 NO	M	P	<b>831-.700-0P</b>	41	31	10	1	0,015	
				MA	P	<b>811-.700-0P</b>	40	31	10	1	0,015	
			2 NC + 2 NO	M	P	<b>832-.700-0P</b>	39	31	10	1	0,016	
				MA	P	<b>812-.700-0P</b>	38	31	10	1	0,016	
			3 NC + 3 NO	M	P	<b>833-.700-0P</b>	43	31	10	1	0,017	
				MA	P	<b>813-.700-0P</b>	42	31	10	1	0,017	
			4 NC + 4 NO	M	P	<b>834-.700-0P</b>	45	31	10	1	0,020	
				MA	P	<b>814-.700-0P</b>	44	31	10	1	0,020	
			5 NC + 5 NO	M	P	<b>835-.700-0P</b>	47	31	10	1	0,024	
				MA	P	<b>815-.700-0P</b>	46	31	10	1	0,024	

Continued on next page



	degree of protection	mounting depth	contacts	switching action	connection method	part no.	circuit drawing	technical drawing	mounting dimensions	component layout			
<b>selector switch 2 positions</b> 45 - 70 mm	IP 40	70 mm	1 NC + 1 NO	M	-	<b>831-.700-00</b>	41	32	10		0,015		
				MA	-	<b>811-.700-00</b>	40	32	10		0,015		
			2 NC + 2 NO	M	-	<b>832-.700-00</b>	39	32	10		0,016		
				MA	-	<b>812-.700-00</b>	38	32	10		0,016		
			3 NC + 3 NO	M	-	<b>833-.700-00</b>	43	32	10		0,017		
				MA	-	<b>813-.700-00</b>	42	32	10		0,017		
			4 NC + 4 NO	M	-	<b>834-.700-00</b>	45	32	10		0,021		
				MA	-	<b>814-.700-00</b>	44	32	10		0,021		
			5 NC + 5 NO	M	-	<b>835-.700-00</b>	47	32	10		0,025		
				MA	-	<b>815-.700-00</b>	46	32	10		0,025		
			IP 65	42 mm	1 NC + 1 NO	M	P	<b>781-.700-WP</b>	37	27	11	1	0,011
						MA	P	<b>761-.700-WP</b>	36	27	11	1	0,011
	2 NC + 2 NO	M				P	<b>782-.700-WP</b>	39	27	11	1	0,012	
		MA				P	<b>762-.700-WP</b>	38	27	11	1	0,012	
	45 mm	1 NC + 1 NO				M	-	<b>781-.700-W0</b>	37	28	11		0,011
						MA	-	<b>761-.700-W0</b>	36	28	11		0,011
		2 NC + 2 NO			M	-	<b>782-.700-W0</b>	39	28	11		0,012	
					MA	-	<b>762-.700-W0</b>	38	28	11		0,012	
		52 mm			1 NC + 1 NO	M	P	<b>931-.700-WP</b>	41	29	11	1	0,013
						MA	P	<b>911-.700-WP</b>	40	29	11	1	0,013
	2 NC + 2 NO				M	P	<b>932-.700-WP</b>	39	29	11	1	0,014	
					MA	P	<b>912-.700-WP</b>	38	29	11	1	0,014	
	3 NC + 3 NO			M	P	<b>933-.700-WP</b>	43	29	11	1	0,015		
				MA	P	<b>913-.700-WP</b>	42	29	11	1	0,015		
55 mm	1 NC + 1 NO	M		-	<b>931-.700-W0</b>	41	30	11		0,013			
		MA		-	<b>911-.700-W0</b>	40	30	11		0,013			
	2 NC + 2 NO	M		-	<b>932-.700-W0</b>	39	30	11		0,014			
		MA		-	<b>912-.700-W0</b>	38	30	11		0,014			
	3 NC + 3 NO	M		-	<b>933-.700-W0</b>	43	30	11		0,015			
		MA		-	<b>913-.700-W0</b>	42	30	11		0,015			
67 mm	1 NC + 1 NO	M		P	<b>831-.700-WP</b>	41	31	11	1	0,015			
		MA		P	<b>811-.700-WP</b>	40	31	11	1	0,015			
	2 NC + 2 NO	M		P	<b>832-.700-WP</b>	39	31	11	1	0,016			
		MA		P	<b>812-.700-WP</b>	38	31	11	1	0,016			
	3 NC + 3 NO	M		P	<b>833-.700-WP</b>	43	31	11	1	0,017			
		MA		P	<b>813-.700-WP</b>	42	31	11	1	0,017			
4 NC + 4 NO	M	P		<b>834-.700-WP</b>	45	31	11	1	0,020				
	MA	P		<b>814-.700-WP</b>	44	31	11	1	0,020				
5 NC + 5 NO	M	P		<b>835-.700-WP</b>	47	31	11	1	0,024				
	MA	P		<b>815-.700-WP</b>	46	31	11	1	0,024				

Continued on next page



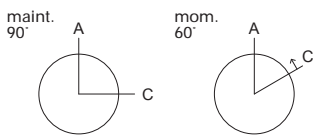

	degree of protection	mounting depth	contacts	switching action	connection method	part no.	circuit drawing	technical drawing	mounting dimensions	component layout	
<b>selector switch 2 positions</b> 45 - 70 mm	IP 65	70 mm	1 NC + 1 NO	M	-	<b>831-.700-W0</b>	41	32	11		0,015
				MA	-	<b>811-.700-W0</b>	40	32	11		0,015
			2 NC + 2 NO	M	-	<b>832-.700-W0</b>	39	32	11		0,016
				MA	-	<b>812-.700-W0</b>	38	32	11		0,016
			3 NC + 3 NO	M	-	<b>833-.700-W0</b>	43	32	11		0,017
				MA	-	<b>813-.700-W0</b>	42	32	11		0,017
			4 NC + 4 NO	M	-	<b>834-.700-W0</b>	45	32	11		0,021
				MA	-	<b>814-.700-W0</b>	44	32	11		0,021
			5 NC + 5 NO	M	-	<b>835-.700-W0</b>	47	32	11		0,025
				MA	-	<b>815-.700-W0</b>	46	32	11		0,025

contacts : normally closed = NC, normally open = NO

switching action : maintained action = MA, momentary action = M

connection method : PCB terminal = P, soldering-/plug-in terminal = -

hint:

- we recommend to use location strip no. 260-0020-00 for anti-twisting of the front bezel.

- at momentary position the overturning force is max. 60 Ncm.

circuit drawings from page 657, technical drawings from page 642, mounting dimensions from page 652, component layouts from page 657

## selector switch 3 positions 45 mm



☞ front cap for keylock-/selector switch 3 positions page 626

☞ lever page 627



	degree of protection	mounting depth	contacts	switching action	connection method	part no.	circuit drawing	technical drawing	mounting dimensions	component layout	
<b>selector switch 3 positions 45 mm</b>	IP 40	42 mm	2 NC + 2 NO	0 - MA - MA	P	<b>722-.700-0P</b>	48	27	10	1	0,012
				M - 0 - M	P	<b>732-.700-0P</b>	49	27	10	1	0,012
				M - 0 - MA	P	<b>752-.700-0P</b>	51	27	10	1	0,012
				MA - 0 - M	P	<b>742-.700-0P</b>	50	27	10	1	0,012
				MA - 0 - MA	P	<b>712-.700-0P</b>	48	27	10	1	0,012
		45 mm	2 NC + 2 NO	0 - MA - MA	-	<b>722-.700-00</b>	48	28	10		0,012
				M - 0 - M	-	<b>732-.700-00</b>	49	28	10		0,012
				M - 0 - MA	-	<b>752-.700-00</b>	51	28	10		0,012
				MA - 0 - M	-	<b>742-.700-00</b>	50	28	10		0,012
				MA - 0 - MA	-	<b>712-.700-00</b>	48	28	10		0,012
	IP 65	42 mm	2 NC + 2 NO	0 - MA - MA	P	<b>722-.700-WP</b>	48	27	11	1	0,012
				M - 0 - M	P	<b>732-.700-WP</b>	49	27	11	1	0,012
				M - 0 - MA	P	<b>752-.700-WP</b>	51	27	11	1	0,012
				MA - 0 - M	P	<b>742-.700-WP</b>	50	27	11	1	0,012
				MA - 0 - MA	P	<b>712-.700-WP</b>	48	27	11	1	0,012
		45 mm	2 NC + 2 NO	0 - MA - MA	-	<b>722-.700-W0</b>	48	28	11		0,012
				M - 0 - M	-	<b>732-.700-W0</b>	49	28	11		0,012
				M - 0 - MA	-	<b>752-.700-W0</b>	51	28	11		0,012
				MA - 0 - M	-	<b>742-.700-W0</b>	50	28	11		0,012
				MA - 0 - MA	-	<b>712-.700-W0</b>	48	28	11		0,012

contacts : normally closed = NC, normally open = NO

switching action: maintained action = MA, momentary action = M

connection method : PCB terminal = P, soldering-/plug-in terminal = -

hint:

- we recommend to use location strip no. 260-0020-00 for anti-twisting of the front bezel.

- at momentary position the overturning force is max. 60 Ncm.

circuit drawings from page 657, technical drawings from page 642, mounting dimensions from page 652, component layouts from page 657

## buzzer 30 - 55 mm



🛒 buzzer element page 627

🛒 front bezel for buzzer 30 - 55 mm page 628

	degree of protection	mounting depth	connection method	buzzer socket	part no.	circuit drawing	technical drawing	mounting dimensions	component layout	
<b>buzzer 30 - 55 mm</b>	IP 40	30 mm	-	MG T 1 3/4	<b>970-000-K0</b>	52	2	12		0,004
		52 mm	P	MG T 1 3/4	<b>970-000-0P</b>	52	4	12	1	0,007
		55 mm	-	MG T 1 3/4	<b>970-000-00</b>	52	5	12		0,007

connection method : soldering-/plug-in terminal = -, PCB terminal = P

the buzzer 55 mm is as long as the corresponding illuminated pushbutton and fits to the PCB plug-in base and multi plug housing

circuit drawings from page 657, technical drawings from page 642, mounting dimensions from page 652, component layouts from page 657

## push-pull illuminated switch 45 mm



🛒 push-pull knob page 627

🛒 filament lamp MG T 1 3/4 page 634

🛒 LED MG T 1 3/4 page 634

	mounting depth	contacts	switching action	connection method	colour of front bezel	18 mm dia. Typ-Nr.	circuit drawing	technical drawing	mounting dimensions	component layout	
<b>push-pull illuminated switch 45 mm</b> IP 40, lampholder MG T 1 3/4	42 mm	2 NC + 2 NO	M - 0 - M	P	grey	<b>792-1000-0P</b>	53	33	13	1	0,015
					black	<b>792-2000-0P</b>	53	33	13	1	0,015
	45 mm	2 NC + 2 NO	M - 0 - M	-	grey	<b>792-1000-00</b>	53	34	13		0,015
					black	<b>792-2000-00</b>	53	34	13		0,015

contacts : normally closed = NC, normally open = NO

switching action: maintained action = MA, momentary action = M

connection method : PCB terminal = P, soldering-/plug-in terminal = -

circuit drawings from page 657, technical drawings from page 642, mounting dimensions from page 652, component layouts from page 657

## indicator actuator 41-44 mm for flush mounting



- 🛒 lens for 35 mm page 622
- 🛒 front bezel-set for flush mounting page 628
- 🛒 filament lamp MG T 1 3/4 page 634
- 🛒 LED MG T 1 3/4 page 634
- 🛒 lamp element block for 35 mm page 632

	degree of protection	a 24 x 30 mm part no.	b 24 x 24 mm part no.	25 mm dia. part no.	circuit drawing	technical drawing	mounting dimension	components layout	
<b>indicator actuator 41-44 mm for flush mounting</b> lamp socket MG T 1 3/4	IP 40	690-6000-00	690-4000-00	690-2000-00	1	35	14	-	0,004
	IP 65	690-6000-W0	690-4000-W0	690-2000-W0	1	35	14	-	0,005

circuit drawings from page 657, technical drawings from page 642, mounting dimensions from page 652

## indicator for flush mounting 39 - 79 mm

protection degree IP 40



- 🛒 lens page 623
- 🛒 front bezel for indicator 39 - 79 mm page 627
- 🛒 front bezel-set for flush mounting page 628
- 🛒 filament lamp MG T 1 3/4 page 634
- 🛒 LED MG T 1 3/4 page 634
- 🛒 filament lamp T 5.5 page 634
- 🛒 LED T 5.5 page 635

	mounting depth	connection method	lamp socket	part no.	circuit drawing	technical drawing	mounting dimensions	component layout	
<b>indicator for flush mounting 39 - 79 mm</b>	39 mm	-	MG T 1 3/4	<b>990-.000-K0</b>	1	36	14		0,004
	54 mm	-	T 5.5	<b>890-.000-K0</b>	1	37	14		0,006
	61 mm	P	MG T 1 3/4	<b>990-.000-0P</b>	1	38	14	1	0,007
	64 mm	-	MG T 1 3/4	<b>990-.000-00</b>	1	39	14		0,007
	76 mm	P	T 5.5	<b>890-.000-0P</b>	1	40	14	1	0,010
	79 mm	-	T 5.5	<b>890-.000-00</b>	1	41	14		0,010

connection method : soldering-/plug-in terminal = -, PCB terminal = P

The indicators 55 mm and 70 mm are as long as the corresponding illuminated pushbuttons and fit to the PCB plug-in base and multi-plug housing. circuit drawings from page 657, technical drawings from page 642, mounting dimensions from page 652, component layouts from page 657

## illuminated-/pushbutton actuator 41-44 mm for flush mounting



- ☞ lens page 623
- ☞ filament lamp MG T 1 3/4 page 634
- ☞ LED MG T 1 3/4 page 634
- ☞ snap-action switching element block for 35 mm page 631

	degree of protection	switching action	component layout		25 mm dia. Typ-Nr.	circuit drawing			technical drawing			mounting dimensions
			□ 24 x 30 mm Typ-Nr.	⌀ 24 x 24 mm Typ-Nr.								
<b>illuminated-/pushbutton actuator 41-44 mm for flush mounting</b>	IP 40	M			<b>680-2000-00</b>	54	35	14	0,004			
				<b>680-4000-00</b>		54	35	14	0,004			
			<b>680-6000-00</b>		54	35	14	0,004				
		MA (M)		<b>600-2000-00</b>	55	35	14	0,004				
				<b>600-4000-00</b>	55	35	14	0,004				
			<b>600-6000-00</b>		55	35	14	0,004				
	IP 65	M			<b>680-2000-W0</b>	54	35	14	0,005			
				<b>680-4000-W0</b>		54	35	14	0,005			
			<b>680-6000-W0</b>		54	35	14	0,005				
		MA (M)		<b>600-2000-W0</b>	55	35	14	0,005				
				<b>600-4000-W0</b>	55	35	14	0,005				
			<b>600-6000-W0</b>		55	35	14	0,005				

switching action : momentary action = M, maintained action = MA

circuit drawings from page 657, technical drawings from page 642, mounting dimensions from page 652

## pushbutton-/illuminated pushbutton for flush mounting 61 - 79 mm

protection degree IP 40



- 🛒 lens page 623
- 🛒 front bezel for illuminated-/pushbutton 61 - 79 mm page 627
- 🛒 front bezel-set for flush mounting page 628
- 🛒 filament lamp MG T 1 3/4 page 634
- 🛒 LED MG T 1 3/4 page 634
- 🛒 filament lamp T 5.5 page 634
- 🛒 LED T 5.5 page 635

	mounting depth	contacts	switching action	connection method	lamp socket	part no.	circuit drawing	technical drawing	mounting dimensions	component layout	
<b>pushbutton-/illuminated pushbutton for flush mounting 61 - 79 mm</b>	61 mm	1 NC + 1 NO	maintained	P	MG T 1 3/4	<b>901-.000-0P</b>	4	42	14	1	0,013
		2 NC + 2 NO	maintained	P	MG T 1 3/4	<b>902-.000-0P</b>	5	42	14	1	0,014
		3 NC + 3 NO	maintained	P	MG T 1 3/4	<b>903-.000-0P</b>	6	42	14	1	0,014
		4 NC + 4 NO	maintained	P	MG T 1 3/4	<b>904-.000-0P</b>	7	42	14	1	0,018
		5 NC + 5 NO	maintained	P	MG T 1 3/4	<b>905-.000-0P</b>	8	42	14	1	0,021
	64 mm	1 NC + 1 NO	maintained	-	MG T 1 3/4	<b>901-.000-00</b>	4	43	14		0,013
		2 NC + 2 NO	maintained	-	MG T 1 3/4	<b>902-.000-00</b>	5	43	14		0,014
		3 NC + 3 NO	maintained	-	MG T 1 3/4	<b>903-.000-00</b>	6	43	14		0,015
		4 NC + 4 NO	maintained	-	MG T 1 3/4	<b>904-.000-00</b>	7	43	14		0,019
		5 NC + 5 NO	maintained	-	MG T 1 3/4	<b>905-.000-00</b>	8	43	14		0,022
	76 mm	1 NC + 1 NO	maintained	P	T 5.5	<b>801-.000-0P</b>	4	44	14	1	0,015
		2 NC + 2 NO	maintained	P	T 5.5	<b>802-.000-0P</b>	5	44	14	1	0,016
		3 NC + 3 NO	maintained	P	T 5.5	<b>803-.000-0P</b>	6	44	14	1	0,014
		4 NC + 4 NO	maintained	P	T 5.5	<b>804-.000-0P</b>	7	44	14	1	0,020
		5 NC + 5 NO	maintained	P	T 5.5	<b>805-.000-0P</b>	8	44	14	1	0,023
	79 mm	1 NC + 1 NO	maintained	-	T 5.5	<b>801-.000-00</b>	4	45	14		0,015
		2 NC + 2 NO	maintained	-	T 5.5	<b>802-.000-00</b>	5	45	14		0,016
		3 NC + 3 NO	maintained	-	T 5.5	<b>803-.000-00</b>	6	45	14		0,017
		4 NC + 4 NO	maintained	-	T 5.5	<b>804-.000-00</b>	7	45	14		0,021
		5 NC + 5 NO	maintained	-	T 5.5	<b>805-.000-00</b>	8	45	14		0,024

contacts : normally closed = NC, normally open = NO

switching action: (changeable to momentary, reversible)

connection method : PCB terminal = P, soldering-/plug-in terminal = -

circuit drawings from page 657, technical drawings from page 642, mounting dimensions from page 652, component layouts from page 657

## keylock switch 2 positions for flush mounting 51 - 79 mm



☞ front cap for keylock-/selector switch 2 positions page 625

☞ front bezel-set for flush mounting page 628

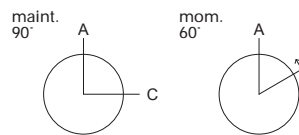

	degree of protection	mounting depth	contacts	switching action	connection method	key removable in	part no.	circuit drawing	technical drawing	mounting dimensions	component layout	
<b>keylock switch 2 positions</b> for flush mounting 51 - 79 mm	IP 40	51 mm	1 NC + 1 NO	M	P	A	<b>781-.401-0P</b>	21	46	14	1	0,022
				MA	P	A	<b>771-.401-0P</b>	20	46	14	1	0,022
						A+C	<b>761-.401-0P</b>	20	46	14	1	0,022
			2 NC + 2 NO	M	P	A	<b>782-.401-0P</b>	23	46	14	1	0,023
				MA	P	A	<b>772-.401-0P</b>	22	46	14	1	0,023
						A+C	<b>762-.401-0P</b>	22	46	14	1	0,023
		54 mm	1 NC + 1 NO	M	-	A	<b>781-.401-00</b>	21	47	14		0,022
				MA	-	A	<b>771-.401-00</b>	20	47	14		0,022
						A+C	<b>761-.401-00</b>	20	47	14		0,022
			2 NC + 2 NO	M	-	A	<b>782-.401-00</b>	23	47	14		0,023
				MA	-	A	<b>772-.401-00</b>	22	47	14		0,023
						A+C	<b>762-.401-00</b>	22	47	14		0,023
		61 mm	1 NC + 1 NO	M	P	A	<b>931-.401-0P</b>	25	48	14	1	0,024
				MA	P	A	<b>921-.401-0P</b>	24	48	14	1	0,024
						A+C	<b>911-.401-0P</b>	24	48	14	1	0,024
			2 NC + 2 NO	M	P	A	<b>932-.401-0P</b>	23	48	14	1	0,025
				MA	P	A	<b>922-.401-0P</b>	22	48	14	1	0,025
						A+C	<b>912-.401-0P</b>	22	48	14	1	0,025
			3 NC + 3 NO	M	P	A	<b>933-.401-0P</b>	27	48	14	1	0,026
				MA	P	A	<b>923-.401-0P</b>	26	48	14	1	0,026
						A+C	<b>913-.401-0P</b>	26	48	14	1	0,026
			4 NC + 4 NO	M	P	A	<b>934-.401-0P</b>	29	48	14	1	0,029
				MA	P	A	<b>924-.401-0P</b>	28	48	14	1	0,029
						A+C	<b>914-.401-0P</b>	28	48	14	1	0,029
5 NC + 5 NO	M		P	A	<b>935-.401-0P</b>	31	48	14	1	0,032		
	MA		P	A	<b>925-.401-0P</b>	30	48	14	1	0,032		
				A+C	<b>915-.401-0P</b>	30	48	14	1	0,032		

Continued on next page



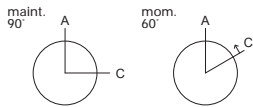

keylock switch 2 positions for flush mounting 51 - 79 mm	degree of protection	mounting depth	contacts	switching action	connection method	key removable in	part no.	circuit drawing	technical drawing	mounting dimensions	component layout	②	
keylock switch 2 positions for flush mounting 51 - 79 mm	IP 40	64 mm	1 NC + 1 NO	M	-	A	<b>931-.401-00</b>	25	49	14		0,024	
				MA	-	A	<b>921-.401-00</b>	24	49	14		0,024	
					-	A+C	<b>911-.401-00</b>	24	49	14		0,024	
			2 NC + 2 NO	M	-	A	<b>932-.401-00</b>	23	49	14		0,025	
				MA	-	A	<b>922-.401-00</b>	22	49	14		0,025	
					-	A+C	<b>912-.401-00</b>	22	49	14		0,025	
			3 NC + 3 NO	M	-	A	<b>933-.401-00</b>	27	49	14		0,027	
				MA	-	A	<b>923-.401-00</b>	26	49	14		0,027	
					-	A+C	<b>913-.401-00</b>	26	49	14		0,027	
			4 NC + 4 NO	M	-	A	<b>934-.401-00</b>	29	49	14		0,030	
				MA	-	A	<b>924-.401-00</b>	28	49	14		0,030	
					-	A+C	<b>914-.401-00</b>	28	49	14		0,030	
			5 NC + 5 NO	M	-	A	<b>935-.401-00</b>	31	49	14		0,033	
				MA	-	A	<b>925-.401-00</b>	30	49	14		0,033	
					-	A+C	<b>915-.401-00</b>	30	49	14		0,033	
			76 mm	1 NC + 1 NO	M	P	A	<b>831-.401-0P</b>	25	50	14	1	0,026
					MA	P	A	<b>821-.401-0P</b>	24	50	14	1	0,026
						P	A+C	<b>811-.401-0P</b>	24	50	14	1	0,026
		2 NC + 2 NO		M	P	A	<b>832-.401-0P</b>	23	50	14	1	0,027	
				MA	P	A	<b>822-.401-0P</b>	22	50	14	1	0,027	
					P	A+C	<b>812-.401-0P</b>	22	50	14	1	0,027	
		3 NC + 3 NO		M	P	A	<b>833-.401-0P</b>	27	50	14	1	0,028	
				MA	P	A	<b>823-.401-0P</b>	26	50	14	1	0,028	
					P	A+C	<b>813-.401-0P</b>	26	50	14	1	0,028	
		4 NC + 4 NO		M	P	A	<b>834-.401-0P</b>	29	50	14	1	0,031	
				MA	P	A	<b>824-.401-0P</b>	28	50	14	1	0,031	
					P	A+C	<b>814-.401-0P</b>	28	50	14	1	0,031	
		5 NC + 5 NO		M	P	A	<b>835-.401-0P</b>	31	50	14	1	0,034	
				MA	P	A	<b>825-.401-0P</b>	30	50	14	1	0,034	
					P	A+C	<b>815-.401-0P</b>	30	50	14	1	0,034	
		79 mm		1 NC + 1 NO	M	-	A	<b>831-.401-00</b>	25	51	14		0,026
					MA	-	A	<b>821-.401-00</b>	24	51	14		0,026
						-	A+C	<b>811-.401-00</b>	24	51	14		0,026
			2 NC + 2 NO	M	-	A	<b>832-.401-00</b>	23	51	14		0,027	
				MA	-	A	<b>822-.401-00</b>	22	51	14		0,027	
					-	A+C	<b>812-.401-00</b>	22	51	14		0,027	
			3 NC + 3 NO	M	-	A	<b>833-.401-00</b>	27	51	14		0,029	
				MA	-	A	<b>823-.401-00</b>	26	51	14		0,029	
					-	A+C	<b>813-.401-00</b>	26	51	14		0,029	
			4 NC + 4 NO	M	-	A	<b>834-.401-00</b>	29	51	14		0,032	
				MA	-	A	<b>824-.401-00</b>	28	51	14		0,032	
					-	A+C	<b>814-.401-00</b>	28	51	14		0,032	
			5 NC + 5 NO	M	-	A	<b>835-.401-00</b>	31	51	14		0,035	
				MA	-	A	<b>825-.401-00</b>	30	51	14		0,035	
					-	A+C	<b>815-.401-00</b>	30	51	14		0,035	
IP 65	51 mm		1 NC + 1 NO	M	P	A	<b>781-.401-WP</b>	21	46	14	1	0,022	
				MA	P	A	<b>771-.401-WP</b>	20	46	14	1	0,022	
					P	A+C	<b>761-.401-WP</b>	20	46	14	1	0,022	
		2 NC + 2 NO	M	P	A	<b>782-.401-WP</b>	23	46	14	1	0,023		
			MA	P	A	<b>772-.401-WP</b>	22	46	14	1	0,023		
				P	A+C	<b>762-.401-WP</b>	22	46	14	1	0,023		

Continued on next page

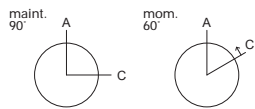

keylock switch 2 positions for flush mounting 51 - 79 mm	degree of protection	mounting depth	contacts	switching action	connection method	key removable in	part no.	circuit drawing	technical drawing	mounting dimensions	component layout	kg	
keylock switch 2 positions for flush mounting 51 - 79 mm	IP 65	54 mm	1 NC + 1 NO	M	-	A	<b>781-.401-W0</b>	21	47	14		0,022	
				MA	-	A	<b>771-.401-W0</b>	20	47	14		0,022	
						A+C	<b>761-.401-W0</b>	20	47	14		0,022	
			2 NC + 2 NO	M	-	A	<b>782-.401-W0</b>	23	47	14		0,023	
				MA	-	A	<b>772-.401-W0</b>	22	47	14		0,023	
						A+C	<b>762-.401-W0</b>	22	47	14		0,023	
		61 mm	1 NC + 1 NO	M	P	A	<b>931-.401-WP</b>	25	48	14	1	0,024	
				MA	P	A	<b>921-.401-WP</b>	24	48	14	1	0,024	
						A+C	<b>911-.401-WP</b>	24	48	14	1	0,024	
			2 NC + 2 NO	M	P	A	<b>932-.401-WP</b>	23	48	14	1	0,025	
				MA	P	A	<b>922-.401-WP</b>	22	48	14	1	0,025	
						A+C	<b>912-.401-WP</b>	22	48	14	1	0,025	
			3 NC + 3 NO	M	P	A	<b>933-.401-WP</b>	27	48	14	1	0,026	
				MA	P	A	<b>923-.401-WP</b>	26	48	14	1	0,026	
						A+C	<b>913-.401-WP</b>	26	48	14	1	0,026	
			4 NC + 4 NO	M	P	A	<b>934-.401-WP</b>	29	48	14	1	0,029	
				MA	P	A	<b>924-.401-WP</b>	28	48	14	1	0,029	
						A+C	<b>914-.401-WP</b>	28	48	14	1	0,029	
			5 NC + 5 NO	M	P	A	<b>935-.401-WP</b>	31	48	14	1	0,032	
				MA	P	A	<b>925-.401-WP</b>	30	48	14	1	0,032	
						A+C	<b>915-.401-WP</b>	30	48	14	1	0,032	
			64 mm	1 NC + 1 NO	M	-	A	<b>931-.401-W0</b>	25	49	14		0,024
					MA	-	A	<b>921-.401-W0</b>	24	49	14		0,024
							A+C	<b>911-.401-W0</b>	24	49	14		0,024
		2 NC + 2 NO		M	-	A	<b>932-.401-W0</b>	23	49	14		0,025	
				MA	-	A	<b>922-.401-W0</b>	22	49	14		0,025	
						A+C	<b>912-.401-W0</b>	22	49	14		0,025	
		3 NC + 3 NO		M	-	A	<b>933-.401-W0</b>	27	49	14		0,027	
				MA	-	A	<b>923-.401-W0</b>	26	49	14		0,027	
						A+C	<b>913-.401-W0</b>	26	49	14		0,027	
		4 NC + 4 NO		M	-	A	<b>934-.401-W0</b>	29	49	14		0,030	
				MA	-	A	<b>924-.401-W0</b>	28	49	14		0,030	
						A+C	<b>914-.401-W0</b>	28	49	14		0,030	
		5 NC + 5 NO		M	-	A	<b>935-.401-W0</b>	31	49	14		0,033	
				MA	-	A	<b>925-.401-W0</b>	30	49	14		0,033	
						A+C	<b>915-.401-W0</b>	30	49	14		0,033	
		76 mm	1 NC + 1 NO	M	P	A	<b>831-.401-WP</b>	25	50	14	1	0,026	
				MA	P	A	<b>821-.401-WP</b>	24	50	14	1	0,026	
						A+C	<b>811-.401-WP</b>	24	50	14	1	0,026	
			2 NC + 2 NO	M	P	A	<b>832-.401-WP</b>	23	50	14	1	0,027	
				MA	P	A	<b>822-.401-WP</b>	22	50	14	1	0,027	
						A+C	<b>812-.401-WP</b>	22	50	14	1	0,027	
3 NC + 3 NO	M		P	A	<b>833-.401-WP</b>	27	50	14	1	0,028			
	MA		P	A	<b>823-.401-WP</b>	26	50	14	1	0,028			
				A+C	<b>813-.401-WP</b>	26	50	14	1	0,028			
4 NC + 4 NO	M		P	A	<b>834-.401-WP</b>	29	50	14	1	0,031			
	MA		P	A	<b>824-.401-WP</b>	28	50	14	1	0,031			
				A+C	<b>814-.401-WP</b>	28	50	14	1	0,031			
5 NC + 5 NO	M		P	A	<b>835-.401-WP</b>	31	50	14	1	0,034			
	MA		P	A	<b>825-.401-WP</b>	30	50	14	1	0,034			
				A+C	<b>815-.401-WP</b>	30	50	14	1	0,034			

Continued on next page

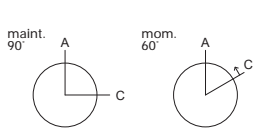

	degree of protection	mounting depth	contacts	switching action	connection method	key removable in	part no.	circuit drawing	technical drawing	mounting dimensions	component layout	
<b>keylock switch 2 positions</b> for flush mounting 51 - 79 mm	IP 65	79 mm	1 NC + 1 NO	M	-	A	<b>831-.401-W0</b>	25	51	14		0,026
				MA	-	A	<b>821-.401-W0</b>	24	51	14		0,026
					-	A+C	<b>811-.401-W0</b>	24	51	14		0,026
			2 NC + 2 NO	M	-	A	<b>832-.401-W0</b>	23	51	14		0,027
				MA	-	A	<b>822-.401-W0</b>	22	51	14		0,027
					-	A+C	<b>812-.401-W0</b>	22	51	14		0,027
			3 NC + 3 NO	M	-	A	<b>833-.401-W0</b>	27	51	14		0,029
				MA	-	A	<b>823-.401-W0</b>	26	51	14		0,029
					-	A+C	<b>813-.401-W0</b>	26	51	14		0,029
			4 NC + 4 NO	M	-	A	<b>834-.401-W0</b>	29	51	14		0,032
				MA	-	A	<b>824-.401-W0</b>	28	51	14		0,032
					-	A+C	<b>814-.401-W0</b>	28	51	14		0,032
			5 NC + 5 NO	M	-	A	<b>835-.401-W0</b>	31	51	14		0,035
				MA	-	A	<b>825-.401-W0</b>	30	51	14		0,035
					-	A+C	<b>815-.401-W0</b>	30	51	14		0,035

contacts : normally closed = NC, normally open = NO

switching action : maintained action = MA, momentary action = M

connection method : PCB terminal = P, soldering-/plug-in terminal = -

other key removable combination on request

hint:

- we recommend to use location strip no. 260-0020-00 for anti-twisting of the front bezel.

- at momentary position the overturning force is max. 60 Ncm.

circuit drawings from page 657, technical drawings from page 642, mounting dimensions from page 652, component layouts from page 657

## keylock switch with 3 positions for flush mounting 51 - 54 mm



🛒 front cap for keylock-/selector switch 3 positions 626

🛒 front bezel-set for flush mounting page 628

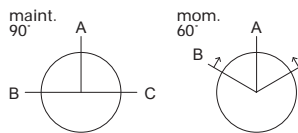

	degree of protection	mounting depth	contacts	switching action	connection method	key removable in	part no.	circuit drawing	technical drawing	mounting dimensions	component layout	
<b>keylock switch with 3 positions</b> for flush mounting 51 - 54 mm	IP 40	51 mm	2 NC + 2 NO	0 - MA - MA	P	B+A+C	<b>722-.401-0P</b>	32	46	14	1	0,023
				M - 0 - M	P	A	<b>732-.401-0P</b>	33	46	14	1	0,023
				M - 0 - MA	P	A+C	<b>752-.401-0P</b>	35	46	14	1	0,023
				MA - 0 - M	P	B+A	<b>742-.401-0P</b>	34	46	14	1	0,023
				MA - 0 - MA	P	B+A+C	<b>712-.401-0P</b>	32	46	14	1	0,023
		54 mm	2 NC + 2 NO	0 - MA - MA	-	B+A+C	<b>722-.401-00</b>	32	47	14		0,023
				M - 0 - M	-	A	<b>732-.401-00</b>	33	47	14		0,023
				M - 0 - MA	-	A+C	<b>752-.401-00</b>	35	47	14		0,023
	IP 65	51 mm	2 NC + 2 NO	0 - MA - MA	P	B+A+C	<b>722-.401-WP</b>	32	46	14	1	0,023
				M - 0 - M	P	A	<b>732-.401-WP</b>	33	46	14	1	0,023
				M - 0 - MA	P	A+C	<b>752-.401-WP</b>	35	46	14	1	0,023
				MA - 0 - M	P	B+A	<b>742-.401-WP</b>	34	46	14	1	0,023
				MA - 0 - MA	P	B+A+C	<b>712-.401-WP</b>	32	46	14	1	0,023
		54 mm	2 NC + 2 NO	0 - MA - MA	-	B+A+C	<b>722-.401-W0</b>	32	47	14		0,023
				M - 0 - M	-	A	<b>732-.401-W0</b>	33	47	14		0,023
				M - 0 - MA	-	A+C	<b>752-.401-W0</b>	35	47	14		0,023
			MA - 0 - M	-	B+A	<b>742-.401-W0</b>	34	47	14		0,023	
			MA - 0 - MA	-	B+A+C	<b>712-.401-W0</b>	32	47	14		0,023	

contacts : normally closed = NC, normally open = NO

switching action : maintained action = MA, momentary action = M

connection method : PCB terminal = P, soldering-/plug-in terminal = -

other key removable combination on request

hint:

- we recommend to use location strip no. 260-0020-00 for anti-twisting of the front bezel.

- at momentary position the overturning force is max. 60 Ncm.

circuit drawings from page 657, technical drawings from page 642, mounting dimensions from page 652, component layouts from page 657

## selector switch 2 positions for flush mounting 51 - 79 mm



🛒 front cap for keylock-/selector switch 2 positions page 625

🛒 lever page 627

🛒 front bezel-set for flush mounting page 628

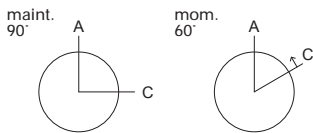

selector switch 2 positions for flush mounting 51 - 79 mm	degree of protection	mounting depth	contacts	switching action	connection method	part no.	circuit drawing	technical drawing	mounting dimensions	component layout	📄
selector switch 2 positions for flush mounting 51 - 79 mm	IP 40	51 mm	1 NC + 1 NO	M	P	<b>781-.700-0P</b>	37	52	15	1	0,011
				MA	P	<b>761-.700-0P</b>	36	52	15	1	0,011
			2 NC + 2 NO	M	P	<b>782-.700-0P</b>	39	52	15	1	0,012
				MA	P	<b>762-.700-0P</b>	38	52	15	1	0,012
		54 mm	1 NC + 1 NO	M	-	<b>781-.700-00</b>	37	53	15		0,011
				MA	-	<b>761-.700-00</b>	36	53	15		0,011
			2 NC + 2 NO	M	-	<b>782-.700-00</b>	39	53	15		0,012
				MA	-	<b>762-.700-00</b>	38	53	15		0,012
		61 mm	1 NC + 1 NO	M	P	<b>931-.700-0P</b>	41	54	15	1	0,013
				MA	P	<b>911-.700-0P</b>	40	54	15	1	0,013
			2 NC + 2 NO	M	P	<b>932-.700-0P</b>	39	54	15	1	0,014
				MA	P	<b>912-.700-0P</b>	38	54	15	1	0,014
			3 NC + 3 NO	M	P	<b>933-.700-0P</b>	43	54	15	1	0,015
				MA	P	<b>913-.700-0P</b>	42	54	15	1	0,015
			4 NC + 4 NO	M	P	<b>934-.700-0P</b>	45	54	15	1	0,018
				MA	P	<b>914-.700-0P</b>	44	54	15	1	0,018
			5 NC + 5 NO	M	P	<b>935-.700-0P</b>	47	54	15	1	0,022
				MA	P	<b>915-.700-0P</b>	46	54	15	1	0,022
		64 mm	1 NC + 1 NO	M	-	<b>931-.700-00</b>	41	55	15		0,013
				MA	-	<b>911-.700-00</b>	40	55	15		0,013
			2 NC + 2 NO	M	-	<b>932-.700-00</b>	39	55	15		0,014
				MA	-	<b>912-.700-00</b>	38	55	15		0,014
			3 NC + 3 NO	M	-	<b>933-.700-00</b>	43	55	15		0,015
				MA	-	<b>913-.700-00</b>	42	55	15		0,015
			4 NC + 4 NO	M	-	<b>934-.700-00</b>	45	55	15		0,019
				MA	-	<b>914-.700-00</b>	44	55	15		0,019
			5 NC + 5 NO	M	-	<b>935-.700-00</b>	47	55	15		0,023
				MA	-	<b>915-.700-00</b>	46	55	15		0,023

Continued on next page

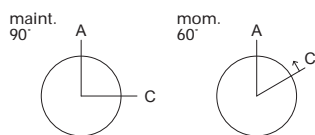

	degree of protection	mounting depth	contacts	switching action	connection method	part no.	circuit drawing	technical drawing	mounting dimensions	component layout		
<b>selector switch 2 positions</b> for flush mounting 51 - 79 mm	IP 65	76 mm	1 NC + 1 NO	M	P	<b>831-.700-0P</b>	41	56	15	1	0,015	
				MA	P	<b>811-.700-0P</b>	40	56	15	1	0,015	
			2 NC + 2 NO	M	P	<b>832-.700-0P</b>	39	56	15	1	0,016	
				MA	P	<b>812-.700-0P</b>	38	56	15	1	0,016	
			3 NC + 3 NO	M	P	<b>833-.700-0P</b>	43	56	15	1	0,017	
				MA	P	<b>813-.700-0P</b>	42	56	15	1	0,017	
			4 NC + 4 NO	M	P	<b>834-.700-0P</b>	45	56	15	1	0,020	
				MA	P	<b>814-.700-0P</b>	44	56	15	1	0,020	
			5 NC + 5 NO	M	P	<b>835-.700-0P</b>	47	56	15	1	0,024	
				MA	P	<b>815-.700-0P</b>	46	56	15	1	0,024	
			79 mm	1 NC + 1 NO	M	-	<b>831-.700-00</b>	41	57	15		0,015
					MA	-	<b>811-.700-00</b>	40	57	15		0,015
		2 NC + 2 NO		M	-	<b>832-.700-00</b>	39	57	15		0,016	
				MA	-	<b>812-.700-00</b>	38	57	15		0,016	
		3 NC + 3 NO		M	-	<b>833-.700-00</b>	43	57	15		0,017	
				MA	-	<b>813-.700-00</b>	42	57	15		0,017	
		4 NC + 4 NO		M	-	<b>834-.700-00</b>	45	57	15		0,021	
				MA	-	<b>814-.700-00</b>	44	57	15		0,021	
		5 NC + 5 NO		M	-	<b>835-.700-00</b>	47	57	15		0,025	
				MA	-	<b>815-.700-00</b>	46	57	15		0,025	
		51 mm		1 NC + 1 NO	M	P	<b>781-.700-WP</b>	37	52	15	1	0,011
					MA	P	<b>761-.700-WP</b>	36	52	15	1	0,011
			2 NC + 2 NO	M	P	<b>782-.700-WP</b>	39	52	15	1	0,012	
				MA	P	<b>762-.700-WP</b>	38	52	15	1	0,012	
		54 mm	1 NC + 1 NO	M	-	<b>781-.700-W0</b>	37	53	15		0,011	
				MA	-	<b>761-.700-W0</b>	36	53	15		0,011	
			2 NC + 2 NO	M	-	<b>782-.700-W0</b>	39	53	15		0,012	
				MA	-	<b>762-.700-W0</b>	38	53	15		0,012	
		61 mm	1 NC + 1 NO	M	P	<b>931-.700-WP</b>	41	54	15	1	0,013	
				MA	P	<b>911-.700-WP</b>	40	54	15	1	0,013	
			2 NC + 2 NO	M	P	<b>932-.700-WP</b>	39	54	15	1	0,014	
				MA	P	<b>912-.700-WP</b>	38	54	15	1	0,014	
			3 NC + 3 NO	M	P	<b>933-.700-WP</b>	43	54	15	1	0,015	
				MA	P	<b>913-.700-WP</b>	42	54	15	1	0,015	
			4 NC + 4 NO	M	P	<b>934-.700-WP</b>	45	54	15	1	0,018	
				MA	P	<b>914-.700-WP</b>	44	54	15	1	0,018	
			5 NC + 5 NO	M	P	<b>935-.700-WP</b>	47	54	15	1	0,022	
				MA	P	<b>915-.700-WP</b>	46	54	15	1	0,022	
			64 mm	1 NC + 1 NO	M	-	<b>931-.700-W0</b>	41	55	15		0,013
					MA	-	<b>911-.700-W0</b>	40	55	15		0,013
		2 NC + 2 NO		M	-	<b>932-.700-W0</b>	39	55	15		0,014	
				MA	-	<b>912-.700-W0</b>	38	55	15		0,014	
		3 NC + 3 NO		M	-	<b>933-.700-W0</b>	43	55	15		0,015	
				MA	-	<b>913-.700-W0</b>	42	55	15		0,015	
		4 NC + 4 NO		M	-	<b>934-.700-W0</b>	45	55	15		0,019	
				MA	-	<b>914-.700-W0</b>	44	55	15		0,019	
		5 NC + 5 NO		M	-	<b>935-.700-W0</b>	47	55	15		0,023	
				MA	-	<b>915-.700-W0</b>	46	55	15		0,023	

Continued on next page



	degree of protection	mounting depth	contacts	switching action	connection method	part no.	circuit drawing	technical drawing	mounting dimensions	component layout	
<b>selector switch 2 positions</b> for flush mounting 51 - 79 mm	IP 65	76 mm	1 NC + 1 NO	M	P	<b>831-.700-WP</b>	41	56	15	1	0,015
				MA	P	<b>811-.700-WP</b>	40	56	15	1	0,015
			2 NC + 2 NO	M	P	<b>832-.700-WP</b>	39	56	15	1	0,016
				MA	P	<b>812-.700-WP</b>	38	56	15	1	0,016
			3 NC + 3 NO	M	P	<b>833-.700-WP</b>	43	56	15	1	0,017
				MA	P	<b>813-.700-WP</b>	42	56	15	1	0,017
			4 NC + 4 NO	M	P	<b>834-.700-WP</b>	45	56	15	1	0,020
				MA	P	<b>814-.700-WP</b>	44	56	15	1	0,020
			5 NC + 5 NO	M	P	<b>835-.700-WP</b>	47	56	15	1	0,024
				MA	P	<b>815-.700-WP</b>	46	56	15	1	0,024
		79 mm	1 NC + 1 NO	M	-	<b>831-.700-WO</b>	41	57	15		0,015
				MA	-	<b>811-.700-WO</b>	40	57	15		0,015
			2 NC + 2 NO	M	-	<b>832-.700-WO</b>	39	57	15		0,016
				MA	-	<b>812-.700-WO</b>	38	57	15		0,016
			3 NC + 3 NO	M	-	<b>833-.700-WO</b>	43	57	15		0,017
				MA	-	<b>813-.700-WO</b>	42	57	15		0,017
			4 NC + 4 NO	M	-	<b>834-.700-WO</b>	45	57	15		0,021
				MA	-	<b>814-.700-WO</b>	44	57	15		0,021
			5 NC + 5 NO	M	-	<b>835-.700-WO</b>	47	57	15		0,025
				MA	-	<b>815-.700-WO</b>	46	57	15		0,025

contacts : normally closed = NC, normally open = NO

switching action : maintained action = MA, momentary action = M

connection method : PCB terminal = P, soldering-/plug-in terminal = -

hint:

- we recommend to use location strip no. 260-0020-00 for anti-twisting of the front bezel.

- at momentary position the overturning force is max. 60 Ncm.

circuit drawings from page 657, technical drawings from page 642, mounting dimensions from page 652, component layouts from page 657

## selector switch 3 positions for flush mounting 51 - 54 mm



🛒 front cap for keylock-/selector switch 3 positions page 626

🛒 lever page 627

🛒 front bezel-set for flush mounting page 628

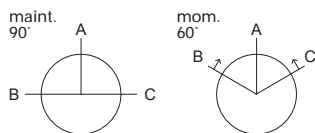

	degree of protection	mounting depth	contacts	switching action	connection method	part no.	circuit drawing	technical drawing	mounting dimensions	component layout	
<b>selector switch 3 positions for flush mounting 51 - 54 mm</b>	IP 40	51 mm	2 NC + 2 NO	0 - MA - MA	P	<b>722-.700-0P</b>	48	52	15	1	0,012
				M - 0 - M	P	<b>732-.700-0P</b>	49	52	15	1	0,012
				M - 0 - MA	P	<b>752-.700-0P</b>	51	52	15	1	0,012
				MA - 0 - M	P	<b>742-.700-0P</b>	50	52	15	1	0,012
				MA - 0 - MA	P	<b>712-.700-0P</b>	48	52	15	1	0,012
		54 mm	2 NC + 2 NO	0 - MA - MA	-	<b>722-.700-00</b>	48	53	15		0,012
				M - 0 - M	-	<b>732-.700-00</b>	49	53	15		0,012
				M - 0 - MA	-	<b>752-.700-00</b>	51	53	15		0,012
				MA - 0 - M	-	<b>742-.700-00</b>	50	53	15		0,012
				MA - 0 - MA	-	<b>712-.700-00</b>	48	53	15		0,012
	IP 65	51 mm	2 NC + 2 NO	0 - MA - MA	P	<b>722-.700-WP</b>	48	52	15	1	0,012
				M - 0 - M	P	<b>732-.700-WP</b>	49	52	15	1	0,012
				M - 0 - MA	P	<b>752-.700-WP</b>	51	52	15	1	0,012
				MA - 0 - M	P	<b>742-.700-WP</b>	50	52	15	1	0,012
				MA - 0 - MA	P	<b>712-.700-WP</b>	48	52	15	1	0,012
		54 mm	2 NC + 2 NO	0 - MA - MA	-	<b>722-.700-W0</b>	48	53	15		0,012
				M - 0 - M	-	<b>732-.700-W0</b>	49	53	15		0,012
				M - 0 - MA	-	<b>752-.700-W0</b>	51	53	15		0,012
				MA - 0 - M	-	<b>742-.700-W0</b>	50	53	15		0,012
				MA - 0 - MA	-	<b>712-.700-W0</b>	48	53	15		0,012

contacts : normally closed = NC, normally open = NO

switching action: maintained action = MA, momentary action = M

connection method : PCB terminal = P, soldering-/plug-in terminal = -

hint:

- we recommend to use location strip no. 260-0020-00 for anti-twisting of the front bezel.

- at momentary position the overturning force is max. 60 Ncm.

circuit drawings from page 657, technical drawings from page 642, mounting dimensions from page 652, component layouts from page 657



## buzzer for flush mounting 39 - 64 mm



- 🛒 buzzer element page 627
- 🛒 front bezel for buzzer 30 - 55 mm page 628
- 🛒 front bezel set for flush mounting for buzzer page 628

	degree of protection	mounting depth	connection method	buzzer socket	part no.	circuit drawing	technical drawing	mounting dimensions	component layout	
<b>buzzer for flush mounting 39 - 64 mm</b>	IP 40	39 mm	-	MG T 1 3/4	<b>970-.000-K0</b>	52	36	16		0,004
		61 mm	P	MG T 1 3/4	<b>970-.000-0P</b>	52	38	16	1	0,007
		64 mm	-	MG T 1 3/4	<b>970-.000-00</b>	52	39	16		0,007

connection method : soldering-/plug-in terminal = -, PCB terminal = P

the buzzer 55 mm is as long as the corresponding illuminated pushbutton and fits to the PCB plug-in base and multi plug housing

circuit drawings from page 657, technical drawings from page 642, mounting dimensions from page 652, component layouts from page 657

at front

lens for 35 mm

for pushbuttons 35 mm

	shape	lens/support	colour	⌀ 18 x 24 mm Typ-Nr.	⌀ 18 x 18 mm Typ-Nr.	18 mm dia. Typ-Nr.	 kg
<b>lens for 35 mm</b> of plastic	flat	transparent/translucent	blue	<b>600-5150-00</b>	<b>600-3150-00</b>	<b>600-1150-00</b>	0,001
			yellow	<b>600-5170-00</b>	<b>600-3170-00</b>	<b>600-1170-00</b>	0,001
			green	<b>600-5140-00</b>	<b>600-3140-00</b>	<b>600-1140-00</b>	0,001
			orange	<b>600-5110-00</b>	<b>600-3110-00</b>	<b>600-1110-00</b>	0,001
			red	<b>600-5120-00</b>	<b>600-3120-00</b>	<b>600-1120-00</b>	0,001
			white	<b>600-5160-00</b>	<b>600-3160-00</b>	<b>600-1160-00</b>	0,001
of plastic (not recommended for film insert)	flat	transparent/translucent	blue	<b>600-5250-00</b>	<b>600-3250-00</b>	<b>600-1250-00</b>	0,001
			yellow	<b>600-5270-00</b>	<b>600-3270-00</b>	<b>600-1270-00</b>	0,001
			green	<b>600-5240-00</b>	<b>600-3240-00</b>	<b>600-1240-00</b>	0,001
			orange	<b>600-5210-00</b>	<b>600-3210-00</b>	<b>600-1210-00</b>	0,001
			red	<b>600-5220-00</b>	<b>600-3220-00</b>	<b>600-1220-00</b>	0,001
			white	<b>600-5260-00</b>	<b>600-3260-00</b>	<b>600-1260-00</b>	0,001
of plastic (not for film insert and illumination)	flat	opaque/translucent	grey	<b>600-5180-00</b>	<b>600-3180-00</b>	<b>600-1180-00</b>	0,001
			black	<b>600-5190-00</b>	<b>600-3190-00</b>	<b>600-1190-00</b>	0,001



**lens**

lens of plastic	degree of protection	front dimension pushbutton	shape	lens/support	colour	part no.	
	IP 40	18 x 18 mm	flat	transparent/translucent	blue	<b>200-3150-00</b>	0,001
					yellow	<b>200-3170-00</b>	0,001
					green	<b>200-3140-00</b>	0,001
					orange	<b>200-3110-00</b>	0,001
					red	<b>200-3120-00</b>	0,001
		white	<b>200-3160-00</b>	0,001			
		18 x 24 mm	flat	transparent/translucent	blue	<b>200-5150-00</b>	0,001
					yellow	<b>200-5170-00</b>	0,001
					green	<b>200-5140-00</b>	0,001
					orange	<b>200-5110-00</b>	0,001
					red	<b>200-5120-00</b>	0,001
		white	<b>200-5160-00</b>	0,001			
		24 x 24 mm	flat	transparent/translucent	blue	<b>200-9150-00</b>	0,001
					yellow	<b>200-9170-00</b>	0,001
					green	<b>200-9140-00</b>	0,001
					orange	<b>200-9110-00</b>	0,001
					red	<b>200-9120-00</b>	0,001
		white	<b>200-9160-00</b>	0,001			
		18 mm dia.	flat	transparent/translucent	blue	<b>200-1150-00</b>	0,001
					yellow	<b>200-1170-00</b>	0,001
	green				<b>200-1140-00</b>	0,001	
	orange				<b>200-1110-00</b>	0,001	
	red				<b>200-1120-00</b>	0,001	
	white	<b>200-1160-00</b>	0,001				
	24 mm dia.	flat	transparent/translucent	blue	<b>200-7150-00</b>	0,001	
				yellow	<b>200-7170-00</b>	0,001	
				green	<b>200-7140-00</b>	0,001	
				orange	<b>200-7110-00</b>	0,001	
				red	<b>200-7120-00</b>	0,001	
	white	<b>200-7160-00</b>	0,001				
	IP 65	24 x 24 mm	flat	transparent/translucent	blue	<b>200-9150-W0</b>	0,002
					yellow	<b>200-9170-W0</b>	0,002
					green	<b>200-9140-W0</b>	0,002
					orange	<b>200-9110-W0</b>	0,002
					red	<b>200-9120-W0</b>	0,002
					white	<b>200-9160-W0</b>	0,002
					24 mm dia.	flat	transparent/translucent
		yellow	<b>200-7170-W0</b>	0,002			
		green	<b>200-7140-W0</b>	0,002			
		orange	<b>200-7110-W0</b>	0,002			
red		<b>200-7120-W0</b>	0,002				
white		<b>200-7160-W0</b>	0,002				



Continued on next page

lens of plastic (not recommended for film insert)	IP 40	18 x 18 mm	flat	transparent/ transparent	blue	<b>200-3250-00</b>	0,001
					yellow	<b>200-3270-00</b>	0,001
					green	<b>200-3240-00</b>	0,001
					orange	<b>200-3210-00</b>	0,001
					red	<b>200-3220-00</b>	0,001
		18 x 24 mm	flat	transparent/ transparent	white	<b>200-3260-00</b>	0,001
					blue	<b>200-5250-00</b>	0,001
					yellow	<b>200-5270-00</b>	0,001
					green	<b>200-5240-00</b>	0,001
					orange	<b>200-5210-00</b>	0,001
		24 x 24 mm	flat	transparent/ transparent	red	<b>200-5220-00</b>	0,001
					white	<b>200-5260-00</b>	0,001
					blue	<b>200-9250-00</b>	0,001
					yellow	<b>200-9270-00</b>	0,001
					green	<b>200-9240-00</b>	0,001
		18 mm dia.	flat	transparent/ transparent	orange	<b>200-9210-00</b>	0,001
					red	<b>200-9220-00</b>	0,001
					white	<b>200-9260-00</b>	0,001
					blue	<b>200-1250-00</b>	0,001
					yellow	<b>200-1270-00</b>	0,001
24 mm dia.	flat	transparent/ transparent	green	<b>200-1240-00</b>	0,001		
			orange	<b>200-1210-00</b>	0,001		
			red	<b>200-1220-00</b>	0,001		
			white	<b>200-1260-00</b>	0,001		
			blue	<b>200-7250-00</b>	0,001		
IP 65	24 x 24 mm	flat	transparent/ transparent	yellow	<b>200-7270-00</b>	0,001	
				green	<b>200-7240-00</b>	0,001	
				orange	<b>200-7210-00</b>	0,001	
				red	<b>200-7220-00</b>	0,001	
				white	<b>200-7260-00</b>	0,001	
	24 mm dia.	flat	transparent/ transparent	blue	<b>200-9250-W0</b>	0,002	
				yellow	<b>200-9270-W0</b>	0,002	
				green	<b>200-9240-W0</b>	0,002	
				orange	<b>200-9210-W0</b>	0,002	
				red	<b>200-9220-W0</b>	0,002	
of plastic (not for film insert and illumination)	IP 40	18 x 18 mm	flat	opaque/translucent	white	<b>200-9260-W0</b>	0,002
					blue	<b>200-9250-W0</b>	0,002
		18 x 24 mm	flat	opaque/translucent	grey	<b>200-9180-00</b>	0,001
					black	<b>200-9190-00</b>	0,001
		24 x 24 mm	flat	opaque/translucent	grey	<b>200-5180-00</b>	0,001
	black				<b>200-5190-00</b>	0,001	
	18 mm dia.	flat	opaque/translucent	grey	<b>200-9180-00</b>	0,001	
				black	<b>200-9190-00</b>	0,001	
	24 mm dia.	flat	opaque/translucent	grey	<b>200-1180-00</b>	0,001	
				black	<b>200-1190-00</b>	0,001	
IP 65	24 x 24 mm	flat	opaque/translucent	grey	<b>200-7180-00</b>	0,001	
				black	<b>200-7190-00</b>	0,001	
	24 mm dia.	flat	opaque/translucent	grey	<b>200-9180-W0</b>	0,002	
				black	<b>200-9190-W0</b>	0,002	
24 mm dia.	flat	opaque/translucent	grey	<b>200-7180-W0</b>	0,002		
			black	<b>200-7190-W0</b>	0,002		

**mushroom-head cap**

can only be used with front bezel 18 mm dia.

	degree of protection	mushroom	colour	☐ 18 x 24 mm Typ-Nr.	☐ 24 x 24 mm Typ-Nr.	24 mm dia. Typ-Nr.	
<b>mushroom-head cap</b>	IP 40	opaque	yellow	<b>200-5370-00</b>	<b>200-9370-00</b>	<b>200-7370-00</b>	0,005
			green	<b>200-5340-00</b>	<b>200-9340-00</b>	<b>200-7340-00</b>	0,005
			red	<b>200-5320-00</b>	<b>200-9320-00</b>	<b>200-7320-00</b>	0,005
			black	<b>200-5390-00</b>	<b>200-9390-00</b>	<b>200-7390-00</b>	0,005



**front cap for keylock-/selector switch 2 positions**

for IP 40/IP 65, will be delivered assembled

	front dimension pushbutton	for switching action	marking	colour	part no.	
<b>front cap for keylock-/selector switch 2 positions</b> plastic, for types 761-... - 772-..., 911-... - 925-..., 811-... - 825-...	18 x 18 mm	0 - MA	0 - I (90°)	grey	<b>200-3001-00</b>	0,002
				black	<b>200-4001-00</b>	0,002
	18 x 24 mm	0 - MA	0 - I (90°)	grey	<b>200-5001-00</b>	0,002
				black	<b>200-6001-00</b>	0,002
	24 x 24 mm	0 - MA	0 - I (90°)	grey	<b>200-9001-00</b>	0,002
				black	<b>200-0001-00</b>	0,002
	18 mm dia.	0 - MA	0 - I (90°)	grey	<b>200-1001-00</b>	0,002
				black	<b>200-2001-00</b>	0,002
	24 mm dia.	0 - MA	0 - I (90°)	grey	<b>200-7001-00</b>	0,002
				black	<b>200-8001-00</b>	0,002
plastic, for types 781-... - 782-..., 931-... - 935-..., 831-... - 835-...	18 x 18 mm	0 - M	0 - I (60°)	grey	<b>200-3001-01</b>	0,002
				black	<b>200-4001-01</b>	0,002
	18 x 24 mm	0 - M	0 - I (60°)	grey	<b>200-5001-01</b>	0,002
				black	<b>200-6001-01</b>	0,002
	24 x 24 mm	0 - M	0 - I (60°)	grey	<b>200-9001-01</b>	0,002
				black	<b>200-0001-01</b>	0,002
	18 mm dia.	0 - M	0 - I (60°)	grey	<b>200-1001-01</b>	0,002
				black	<b>200-2001-01</b>	0,002
	24 mm dia.	0 - M	0 - I (60°)	grey	<b>200-7001-01</b>	0,002
				black	<b>200-8001-01</b>	0,002
of plastic, fits for all types	18 x 18 mm	M- or MA action	without marking	grey	<b>200-3004-00</b>	0,002
				black	<b>200-4004-00</b>	0,002
	18 x 24 mm	M- or MA action	without marking	grey	<b>200-5004-00</b>	0,002
				black	<b>200-6004-00</b>	0,002
	24 x 24 mm	M- or MA action	without marking	grey	<b>200-9004-00</b>	0,002
				black	<b>200-0004-00</b>	0,002
	18 mm dia.	M- or MA action	without marking	grey	<b>200-1004-00</b>	0,002
				black	<b>200-2004-00</b>	0,002
	24 mm dia.	M- or MA action	without marking	grey	<b>200-7004-00</b>	0,002
				black	<b>200-8004-00</b>	0,002



**front cap for keylock-/selector switch 3 positions**

for IP 40/IP 65, will be delivered assembled

	front dimension	for switching action	marking	colour	part no.	
<b>front cap for keylock-/selector switch 3 positions</b> plastic, for type 712-...	18 x 18 mm	M - 0 - M	I (90°) - 0 - II (90°)	grey	<b>200-3002-00</b>	0,002
				black	<b>200-4002-00</b>	0,002
	18 x 24 mm	M - 0 - M	I (90°) - 0 - II (90°)	grey	<b>200-5002-00</b>	0,002
				black	<b>200-6002-00</b>	0,002
	24 x 24 mm	M - 0 - M	I (90°) - 0 - II (90°)	grey	<b>200-9002-00</b>	0,002
				black	<b>200-0002-00</b>	0,002
	18 mm dia.	M - 0 - M	I (90°) - 0 - II (90°)	grey	<b>200-1002-00</b>	0,002
				black	<b>200-2002-00</b>	0,002
	24 mm dia.	M - 0 - M	I (90°) - 0 - II (90°)	grey	<b>200-7002-00</b>	0,002
				black	<b>200-8002-00</b>	0,002
plastic, for type 722-...	18 x 18 mm	0 - M - M	0 (90°) - I - II (90°)	grey	<b>200-3003-01</b>	0,002
				black	<b>200-4003-01</b>	0,002
	18 x 24 mm	0 - M - M	0 (90°) - I - II (90°)	grey	<b>200-5003-01</b>	0,002
				black	<b>200-6003-01</b>	0,002
	24 x 24 mm	0 - M - M	0 (90°) - I - II (90°)	grey	<b>200-9003-01</b>	0,002
				black	<b>200-0003-01</b>	0,002
	18 mm dia.	0 - M - M	0 (90°) - I - II (90°)	grey	<b>200-1003-01</b>	0,002
				black	<b>200-2003-01</b>	0,002
	24 mm dia.	0 - M - M	0 (90°) - I - II (90°)	grey	<b>200-7003-01</b>	0,002
				black	<b>200-8003-01</b>	0,002
plastic, for type 732-...	18 x 18 mm	M - 0 - M	I (60°) - 0 - II (60°)	grey	<b>200-3002-02</b>	0,002
				black	<b>200-4002-02</b>	0,002
	18 x 24 mm	M - 0 - M	I (60°) - 0 - II (60°)	grey	<b>200-5002-02</b>	0,002
				black	<b>200-6002-02</b>	0,002
	24 x 24 mm	M - 0 - M	I (60°) - 0 - II (60°)	grey	<b>200-9002-02</b>	0,002
				black	<b>200-0002-02</b>	0,002
	18 mm dia.	M - 0 - M	I (60°) - 0 - II (60°)	grey	<b>200-1002-02</b>	0,002
				black	<b>200-2002-02</b>	0,002
	24 mm dia.	M - 0 - M	I (60°) - 0 - II (60°)	grey	<b>200-7002-02</b>	0,002
				black	<b>200-8002-02</b>	0,002
plastic, for type 742-...	18 x 18 mm	MA - 0 - M	I (90°) - 0 - II (60°)	grey	<b>200-3002-03</b>	0,002
				black	<b>200-4002-03</b>	0,002
	18 x 24 mm	MA - 0 - M	I (90°) - 0 - II (60°)	grey	<b>200-5002-03</b>	0,002
				black	<b>200-6002-03</b>	0,002
	24 x 24 mm	MA - 0 - M	I (90°) - 0 - II (60°)	grey	<b>200-9002-03</b>	0,002
				black	<b>200-0002-03</b>	0,002
	18 mm dia.	MA - 0 - M	I (90°) - 0 - II (60°)	grey	<b>200-1002-03</b>	0,002
				black	<b>200-2002-03</b>	0,002
	24 mm dia.	MA - 0 - M	I (90°) - 0 - II (60°)	grey	<b>200-7002-03</b>	0,002
				black	<b>200-8002-03</b>	0,002
plastic, for type 752-...	18 x 18 mm	M - 0 - MA	I (60°) - 0 - II (90°)	grey	<b>200-3002-04</b>	0,002
				black	<b>200-4002-04</b>	0,002
	18 x 24 mm	M - 0 - MA	I (60°) - 0 - II (90°)	grey	<b>200-5002-04</b>	0,002
				black	<b>200-6002-04</b>	0,002
	24 x 24 mm	M - 0 - MA	I (60°) - 0 - II (90°)	grey	<b>200-9002-04</b>	0,002
				black	<b>200-0002-04</b>	0,002
	18 mm dia.	M - 0 - MA	I (60°) - 0 - II (90°)	grey	<b>200-1002-04</b>	0,002
				black	<b>200-2002-04</b>	0,002
	24 mm dia.	M - 0 - MA	I (60°) - 0 - II (90°)	grey	<b>200-7002-04</b>	0,002
				black	<b>200-8002-04</b>	0,002



Continued on next page

front cap for keylock-/selector switch 3 positions of plastic, fits for all types	18 x 18 mm	M- or MA action	without marking	grey	<b>200-3004-00</b>	0,002
				black	<b>200-4004-00</b>	0,002
	18 x 24 mm	M- or MA action	without marking	grey	<b>200-5004-00</b>	0,002
				black	<b>200-6004-00</b>	0,002
	24 x 24 mm	M- or MA action	without marking	grey	<b>200-9004-00</b>	0,002
				black	<b>200-0004-00</b>	0,002
	18 mm dia.	M- or MA action	without marking	grey	<b>200-1004-00</b>	0,002
				black	<b>200-2004-00</b>	0,002
	24 mm dia.	M- or MA action	without marking	grey	<b>200-7004-00</b>	0,002
				black	<b>200-8004-00</b>	0,002

**lever**

will be delivered assembled

	construction	colour	part no.	
lever	short	black	<b>200-.704-00</b>	0,001
		chromium-plated	<b>200-.604-00</b>	0,001
	long	black	<b>200-.904-00</b>	0,001
		chromium-plated	<b>200-.804-00</b>	0,001



**buzzer element**

	voltage	colour	18 x 24 mm Typ-Nr.	24 x 24 mm Typ-Nr.	
buzzer element	6 V AC/DC	grey	<b>970-5006-00</b>	<b>970-9006-00</b>	0,004
		black	<b>970-6006-00</b>	<b>970-0006-00</b>	0,004
	12 V AC/DC	grey	<b>970-5012-00</b>	<b>970-9012-00</b>	0,004
		black	<b>970-6012-00</b>	<b>970-0012-00</b>	0,004
	24 V AC/DC	grey	<b>970-5024-00</b>	<b>970-9024-00</b>	0,004
		black	<b>970-6024-00</b>	<b>970-0024-00</b>	0,004



**push-pull knob**

	knob	colour	part no.	
push-pull knob	transparent	blue	<b>200-.255-00</b>	0,003
		yellow	<b>200-.275-00</b>	0,003
		green	<b>200-.245-00</b>	0,003
		red	<b>200-.225-00</b>	0,003
		white	<b>200-.265-00</b>	0,003



**front bezel for illuminated-/pushbutton 55 - 70 mm and indicator 30 - 70 mm**

	degree of protection	front dimension	material	colour	part no.	
front bezel for illuminated-/pushbutton 55 - 70 mm and indicator 30 - 70 mm	IP 40	18 x 18 mm	plastic	grey	<b>200-3000-00</b>	0,002
				black	<b>200-4000-00</b>	0,002
		18 x 24 mm	plastic	grey	<b>200-5000-00</b>	0,002
				black	<b>200-6000-00</b>	0,002
		24 x 24 mm	plastic	grey	<b>200-9000-00</b>	0,002
				black	<b>200-0000-00</b>	0,002
		18 mm dia.	plastic	grey	<b>200-1000-00</b>	0,002
				black	<b>200-2000-00</b>	0,002
		24 mm dia.	plastic	grey	<b>200-7000-00</b>	0,002
				black	<b>200-8000-00</b>	0,002
	IP 65	24 x 24 mm	plastic	grey	<b>200-9000-W0</b>	0,002
				black	<b>200-0000-W0</b>	0,002
		24 mm dia.	plastic	grey	<b>200-7000-W0</b>	0,002
				black	<b>200-8000-W0</b>	0,002



**front bezel for mushroom-head pushbutton 55 - 70 mm**

	degree of protection	material	colour	18 mm dia. Typ-Nr.	
<b>front bezel for mushroom-head pushbutton 55 - 70 mm</b>	IP 40	plastic	grey	<b>200-1000-00</b>	0,002
			black	<b>200-2000-00</b>	0,002



**front bezel for buzzer 30 - 55 mm**

	degree of protection	material	colour	 18 x 24 mm Typ-Nr.	 24 x 24 mm Typ-Nr.	
<b>front bezel for buzzer 30 - 55 mm</b>	IP 40	plastic	grey	<b>200-5000-00</b>	<b>200-9000-00</b>	0,002
			black	<b>200-6000-00</b>	<b>200-0000-00</b>	0,002



**front bezel-set for flush mounting**

to us as IP 40: cut off (with knife) the anti-twisting at the front bezel/actuator

	degree of protection	material	colour	 18 x 24 mm Typ-Nr.	 18 x 18 mm Typ-Nr.	18 mm dia. Typ-Nr.	
<b>front bezel-set for flush mounting</b> 24 x 24 mm	IP 40/IP 65	plastic	black		<b>200-4400-V0</b>		0,007
24 x 30 mm	IP 40/IP 65	plastic	black	<b>200-6400-V0</b>			0,008
25 mm dia.	IP 40/IP 65	plastic	black			<b>200-8400-V0</b>	0,006



**front bezel set for flush mounting for buzzer**

to us as IP 40: cut off (with knife) the anti-twisting at the front bezel/actuator

	degree of protection	material	colour	 18 x 24 mm Typ-Nr.	
<b>front bezel set for flush mounting for buzzer</b> 24 x 30 mm	IP 40	plastic	black	<b>200-6400-V0</b>	0,008



**protective cover for 35 mm**

for pushbuttons 35 mm

	degree of protection	 18 x 24 mm Typ-Nr.	 18 x 18 mm Typ-Nr.	technical drawing	
<b>protective cover for 35 mm</b> hinged, transparent, with means for sealing	IP 40	<b>200-6008-00</b>	<b>200-4008-00</b>	58	0,002
	IP 65	<b>200-6008-W0</b>	<b>200-4008-W0</b>	58	0,002



technical drawings from page 642



**protective cover for illuminated-/pushbutton 55 - 70 mm**

	degree of protection	18 x 24 mm Typ-Nr.	18 x 18 mm Typ-Nr.	24 x 24 mm Typ-Nr.	technical drawing	
<b>protective cover for illuminated-/pushbutton 55 - 70 mm</b> hinged, transparent, not with means for sealing, for use as IP 40: cut off (with knife) the anti-twisting at the front bezel/actuator	IP 40/IP 65			<b>200-0008-W0</b>	58	0,006
hinged, transparent, with means for sealing	IP 40	<b>200-6008-00</b>	<b>200-4008-00</b>		58	0,005



technical drawings from page 642

**protective cover for flush mounting**

to us as IP 40: cut off (with knife) the anti-twisting at the front bezel/actuator

	degree of protection	use	material	colour	18 x 24 mm Typ-Nr.	18 x 18 mm Typ-Nr.	
<b>protective cover for flush mounting</b> 24x24 mm, hinged, transparent, with means for sealing	IP 40/IP65	for illuminated pushbutton/keylock switch	plastic	black		<b>200-4408-V0</b>	0,006
24x30 mm, hinged, transparent, with means for sealing	IP 40/IP65	for illuminated pushbutton/keylock switch	plastic	black	<b>200-6408-V0</b>		0,006



**sprayproof cover**

	material	18 x 24 mm Typ-Nr.	18 x 18 mm Typ-Nr.	
<b>sprayproof cover</b> 24x24 mm, two-part, protection IP 65, illumination exchangeable from the front	PVC		<b>200-3009-W0</b>	0,003
24x30 mm, two-part, protection IP 65, illumination exchangeable from the front	silicone	<b>200-5009-W0</b>		0,003



**protective guard for illuminated-/pushbutton**

for mounting depth 55/70 mm

	18 x 24 mm Typ-Nr.	18 x 18 mm Typ-Nr.	18 mm dia. Typ-Nr.	
<b>protective guard for illuminated-/pushbutton</b> aluminium anodized colourless, 18x20 mm		<b>200-3007-00</b>		0,002
aluminium anodized colourless, 20x24 mm	<b>200-5007-00</b>			0,002
aluminium anodized colourless, 20 mm dia.			<b>200-1007-00</b>	0,002



**pressure ring**

for indicator IP 65, mounting depth 30/45 mm, obligatory

	part no.	
<b>pressure ring</b> plastic suitable for 24 dia. mm and 24 x 24 mm	<b>200-8009-W0</b>	0,001



**sealing ring**

for front bezel IP 65, 24 dia. mm and 24 x 24 mm

	degree of protection	material	part no.	
<b>sealing ring</b>	IP 65	silicone	<b>200-9009-W0</b>	0,001



**sealing bulb**



for lens IP65, 24 dia. mm and 24 x 24 mm

	degree of protection	material	part no.	
<b>sealing bulb</b>	IP 65	silicone	<b>200-7009-W0</b>	0,001



**blind plug for 35 mm**

for lenses and pushbuttons 35 mm

	degree of protection	colour	 18 x 24 mm Typ-Nr.	 18 x 18 mm Typ-Nr.	18 mm dia. Typ-Nr.	
<b>blind plug for 35 mm</b> for mounting hole 16.2 mm dia.	IP 40	grey	<b>200-5006-00</b>	<b>200-3006-00</b>	<b>200-1006-00</b>	0,003
		black	<b>200-6006-00</b>	<b>200-4006-00</b>	<b>200-2006-00</b>	0,003
	IP 65	black	<b>200-6006-W0</b>	<b>200-4006-W0</b>	<b>200-2006-W0</b>	0,003



**blind plug**

for lenses and pushbuttons 30/45/55/70 mm

	degree of protection	colour	∅ 18 x 24 mm Typ-Nr.	∅ 18 x 18 mm Typ-Nr.	18 mm dia. Typ-Nr.	∅ 24 x 24 mm Typ-Nr.	
<b>blind plug</b> for mounting hole 16.2 mm dia.	IP 40	grey	<b>200-5006-00</b>	<b>200-3006-00</b>	<b>200-1006-00</b>		0,003
		black	<b>200-6006-00</b>	<b>200-4006-00</b>	<b>200-2006-00</b>		0,003
	IP 65	black	<b>200-6006-W0</b>	<b>200-4006-W0</b>	<b>200-2006-W0</b>	<b>200-0006-W0</b>	0,003



**spare key**

add to the part no., the engraved lock no.

	use	part no.	
<b>spare key</b> for standard lock 1001	for emergency stop switch foolproof with key to release	<b>240-4001-00</b>	0,005
for standard lock B2 300, other lock numbers on request	for keylock switch	<b>240-2001-00</b>	0,005
for standard lock B2 390, other lock numbers on request	for emergency stop switch with key to release	<b>240-3001-00</b>	0,005



At ordering indicate marked lock no.

**at back**

**snap-action switching element block for 35 mm**

for pushbuttons 35 mm

	contacts	connection method	part no.	circuit drawing	component layout	
<b>snap-action switching element block for 35 mm</b>	1 NC + 1 NO	-	<b>601-0000-00</b>	56		0,006
		P	<b>601-0000-0P</b>	56	1	0,006
	1 NC + 1 NO + 1	-	<b>608-0000-00</b>	58		0,006
		P	<b>608-0000-0P</b>	58	1	0,006
	1 NC + 1 NO + 2	-	<b>609-0000-00</b>	59		0,006
		P	<b>609-0000-0P</b>	59	1	0,006
	2 NC + 2 NO	-	<b>602-0000-00</b>	57		0,006
		P	<b>602-0000-0P</b>	57	1	0,006



circuit drawings from page 657, component layouts from page 657

**lamp element block for 35 mm**

for indicator 35 mm

	diodes	connection method	part no.	circuit drawing	component layout	
<b>lamp element block for 35 mm</b>	0	-	<b>600-0000-00</b>	1		0,005
		P	<b>600-0000-0P</b>	1	1	0,005
	1	-	<b>606-0000-00</b>	60		0,006
		P	<b>606-0000-0P</b>	60	1	0,006
	2	-	<b>607-0000-00</b>	61		0,006
		P	<b>607-0000-0P</b>	61	1	0,006



circuit drawings from page 657, component layouts from page 657

**blind element**

	part no.	
<b>blind element</b> white	<b>202-0600-00</b>	0,002



**lamp terminal**

	use	part no.	
<b>lamp terminal</b>	for soldering-/plug-in terminal	<b>270-0000-00</b>	0,001
	for PCB terminal	<b>270-0000-0P</b>	0,001



**intermediate section**

	use	part no.	
<b>intermediate section</b> incl. fixing nut	for illuminated pushbutton 55 mm MG T 1 3/4	<b>260-9000-00</b>	0,005
	for illuminated pushbutton 70 mm T 5.5	<b>260-8000-00</b>	0,008



**snap-action switching element**

	contacts	colour	connection method	material of contacts	part no.	technical drawing	
<b>snap-action switching element</b>	1 NC + 1 NO	blue	-	gold plated	<b>201-0500-00</b>	59	0,003
		grey	-	gold plated	<b>201-0800-00</b>	59	0,003
			P	gold plated	<b>221-0800-0P</b>	59	0,003
		green	-	gold plated	<b>201-0400-00</b>	59	0,003



technical drawings from page 642

**holder for 2 switching elements**

	use	material	part no.	
<b>holder for 2 switching elements</b>	push-pull illuminated switch	plastic	<b>270-2000-00</b>	0,001
	for pushbutton 35 mm, keylock-/selector switch 45 mm	plastic	<b>270-3000-00</b>	0,001



**holder for 3 switching elements**

	use	material	part no.	
<b>holder for 3 switching elements</b>	for illuminated-/pushbuttons 55-70 mm	stainless steel	<b>270-1000-00</b>	0,001



**spring with pin**

for maintained version at the intermediate section

	use	part no.	
<b>spring with pin</b>	for illuminated pushbutton 55/70 mm	<b>260-0010-00</b>	0,001



**PCB plug-in base**

	for	pin orientation	part no.	
<b>PCB plug-in base</b> lamp terminal 0.5 mikron Au incl. lamp terminal 0.5 mikron Au	indicator 35/55/70 mm	angled	<b>280-0200-00</b>	0,006
		straight	<b>280-0100-00</b>	0,005
	1NC + 1NO for 35/45 mm	angled	<b>280-1210-00</b>	0,006
		straight	<b>280-1110-00</b>	0,005
	1NC + 1NO for 55/70 mm	angled	<b>280-1200-00</b>	0,006
		straight	<b>280-1100-00</b>	0,005
	2NC + 2NO for 35/45/55/70 mm	angled	<b>280-2200-00</b>	0,006
		straight	<b>280-2100-00</b>	0,005
	3NC + 3NO for 55/70 mm	angled	<b>280-3200-00</b>	0,006
		straight	<b>280-3100-00</b>	0,005



**multi-plug housing**

	part no.	
<b>multi-plug housing</b> for flat connector with locating tongue with 14 terminal possibilities, 10 terminals plugable max.	<b>280-0000-00</b>	0,002



**cable shoe**

	use	locating tongue	wire cross-section of terminal	connection method	part no.	
<b>cable shoe</b>	for multi-plug housing (280-0000-00)	with	0.1 - 0.25 mm&	- 2.8 x 0.5 mm	<b>280-0001-00</b>	0,001
			0.5 - 1.00 mm&	- 2.8 x 0.5 mm	<b>280-0002-00</b>	0,001
as per VDE 0630 use with insulation socket (280-0010-00)	for insulation socket (280-0010-00)	without	0.2 - 0.75 mm&	- 2.8 x 0.5 mm	<b>280-0003-00</b>	0,001



connector with two outputs

	use	connection method	part no.	
connector with two outputs	for cable shoe (280-0003-00)	- 2.8 x 0.5 mm	<b>280-0004-00</b>	0,001



insulation socket

	part no.	
insulation socket for connector without locating tongue (280-0003-00)	<b>280-0010-00</b>	0,001



for illumination

filament lamp MG T 1 3/4

	voltage/current	part no.	
filament lamp MG T 1 3/4	14 V / 80 mA	<b>10-1310.1319</b>	0,001
	28 V / 40 mA	<b>10-1313.1249</b>	0,001
	36 V / 30 mA	<b>10-1316.1209</b>	0,001
	48 V / 25 mA	<b>10-1319.1199</b>	0,001
	6.3 V / 200 mA	<b>10-1307.1369</b>	0,001
	60 V / 20 mA	<b>10-1320.1179</b>	0,001



filament lamp T 5.5

	voltage/current	part no.	
filament lamp T 5.5	6 V / 200 mA	<b>10-1106.1369</b>	0,001
	12 V / 100 mA	<b>10-1109.1329</b>	0,001
	24 V / 50 mA	<b>10-1112.1279</b>	0,001
	36 V / 35 mA	<b>10-1116.1229</b>	0,001
	48 V / 25 mA	<b>10-1119.1199</b>	0,001



LED MG T 1 3/4

	number of chips	voltage/current	colour	part no.	
LED MG T 1 3/4 with built-in protective diode	6	6 VDC / 45 mA	yellow	<b>10-5306.3254</b>	0,001
			green	<b>10-5306.3255</b>	0,001
			red	<b>10-5306.3252</b>	0,001
		12 VDC / 25 mA	yellow	<b>10-5309.3204</b>	0,001
			green	<b>10-5309.3205</b>	0,001
			red	<b>10-5309.3202</b>	0,001
		24 VDC / 12.5 mA	yellow	<b>10-5312.3134</b>	0,001
			green	<b>10-5312.3135</b>	0,001
			red	<b>10-5312.3132</b>	0,001
		48 VDC / 12.5 mA	yellow	<b>10-5319.3104</b>	0,001
			green	<b>10-5319.3105</b>	0,001
			red	<b>10-5319.3102</b>	0,001



**Note:**  
For optimal illumination we strongly recommend using our new single-chip LEDs.

For new designs, only the new single-chip LEDs should be chosen. They can be found on page 669.

**LED T 5.5**

	number of chips	voltage/current	colour	part no.	
<b>LED T 5.5</b> with built-in protective diode  <b>Note:</b> For optimal illumination we strongly recommend using our new single-chip LEDs.  For new designs, only the new single-chip LEDs should be chosen. They can be found on page 669.	6	6 VDC / 45 mA	yellow	<b>10-5106.3254</b>	0,001
			green	<b>10-5106.3255</b>	0,001
			red	<b>10-5106.3252</b>	0,001
		12 VDC / 25 mA	yellow	<b>10-5109.3204</b>	0,001
			green	<b>10-5109.3205</b>	0,001
			red	<b>10-5109.3202</b>	0,001
		24 VDC / 12.5 mA	yellow	<b>10-5112.3144</b>	0,001
			green	<b>10-5112.3145</b>	0,001
			red	<b>10-5112.3142</b>	0,001
		48 VDC / 12.5 mA	yellow	<b>10-5119.3134</b>	0,001
			green	<b>10-5119.3135</b>	0,001
			red	<b>10-5119.3132</b>	0,001



**diode element**

	diodes	colour	connection method	part no.	
<b>diode element</b> diode 1N/4007	1	red	-	<b>212-0100-00</b>	0,003
			P	<b>222-0100-0P</b>	0,003
	2	red	-	<b>213-0100-00</b>	0,003
			P	<b>214-0100-0P</b>	0,003



**capacitor**

for lamp voltage reduction

	value	part no.	
<b>capacitor</b> use with 60 V/20 mA, 50 Hz lamp voltage	220 V/0.27 µF	<b>300-0090-00</b>	0,004



Please keep to the country specific security rules.

**series resistor**

for lamp voltage reduction

	value	part no.	
<b>series resistor</b> use with 60 V / 20 mA lamp rating	100 V / 2.7 kΩ	<b>300-0010-00</b>	0,003
	125 V / 3.3 kΩ	<b>300-0020-00</b>	0,003
	145 V / 4.7 kΩ	<b>300-0030-00</b>	0,003
	230 V / 8.2 kΩ	<b>300-0040-00</b>	0,003
	240 V / 10 kΩ	<b>300-0050-00</b>	0,003



Please keep to the country specific security rules.

**terminal plate empty**

for fitting with series resistors and capacitors

	no. of spaces	part no.	
<b>terminal plate empty</b> 125 x 60 x 15 mm	10 spaces	<b>300-0110-00</b>	0,045
187.5 x 60 x 15 mm	15 spaces	<b>300-0115-00</b>	0,090
250 x 60 x 15 mm	20 spaces	<b>300-0120-00</b>	0,095
62.5 x 60 x 15 mm	5 spaces	<b>300-0105-00</b>	0,025



for emergency stop switch

label for emergency stop switch

	degree of protection	marking	43 mm dia. Typ-Nr.	
label for emergency stop switch yellow, other constructions on request	IP 40	in German	<b>200-1300-02</b>	0,002
		in English	<b>200-1300-03</b>	0,002
		in French	<b>200-1300-04</b>	0,002
		without	<b>200-1300-01</b>	0,002
	IP 65	in German	<b>200-1300-W2</b>	0,002
		in English	<b>200-1300-W3</b>	0,002
		in French	<b>200-1300-W4</b>	0,002
		without	<b>200-1300-W1</b>	0,002



slow-make switching element for emergency stop switch

	contacts	colour	connection method	material of contacts	part no.	technical drawing	
slow-make switching element for emergency stop switch	1 NC	grey	-	gold plated	<b>211+0800-00</b>	60	0,003
			P	gold plated	<b>231+0800-0P</b>	60	0,003



technical drawings from page 642

dismantling tool for emergency stop switch foolproof

	part no.	
dismantling tool for emergency stop switch foolproof	<b>300-0017-00</b>	0,004



assembling

fixing nut

for standard mounting

	use	panel thickness	colour	part no.	
fixing nut plastic	for mounting depth 30-70 mm	1-3 mm	grey	<b>260-0001-00</b>	0,001
		3-5 mm	grey	<b>260-0002-00</b>	0,001
		5-7 mm	grey	<b>260-0005-00</b>	0,001
	for mounting depth 35 mm	1-3 mm	black	<b>260-0003-00</b>	0,001





**fixing nut for flush mounting**

	use	panel thickness	colour	part no.	
fixing nut for flush mounting plastic	for mounting depth 41/44 mm	1-3 mm	black	<b>260-0003-00</b>	0,001
	for mounting depth 39-79 mm	3-5 mm	grey	<b>260-0002-00</b>	0,001



**location strip**

for indicators, illuminated/push buttons, push-pull illuminated button, buzzer, mushroom-head cap, key and selector switches and emergency button 55-70 mm IP 40 / IP 65 designs

	use	part no.	
location strip anti-twisting, in-line arrays or single switches	graduation 18 mm	<b>260-0020-00</b>	0,001
	graduation 24 mm	<b>260-0021-00</b>	0,001



**lens remover**

	part no.	
lens remover	<b>300-0001-00</b>	0,012



**lamp/LED remover**

	part no.	
lamp/LED remover	<b>300-0002-00</b>	0,003



Warning:  
when replacing lamps/LED a switching process can be triggered!

**mounting tool**

	part no.	
mounting tool for tightening (or loosening) fixing nuts (at dismantled element block)	<b>300-0003-00</b>	0,007



**contact element pliers**

for block mounting

	part no.	
contact element pliers for dismantling the switching elements off the holder for 3 switching elements	<b>300-0005-00</b>	0,013



**jaw spanner**

	part no.	
jaw spanner for tightening (or loosening) fixing nuts and dismantling of the element blocks (mounting depth 35-70 mm)	<b>300-0004-00</b>	0,003



**cable shoe remover**

	part no.	
cable shoe remover for removing the connector from the multi-plug housing (280-0000-00)	<b>300-0006-00</b>	0,001



## Switching system

Self-cleaning, double-break slow-make element with four-path contacts (contact opening width 2 x 1.5 mm). The slow-make elements are constructed as per DIN EN 60947-5-1.

## Materials

### Mushroom-head cap

Polyamide PA

### Actuator housing

Polyetherimide PEI, self-extinguishing

### Switching element

Polyamide PA  
Polysulfone PSU

### Contact material

Silver

## Connections

### Solder/plug-in terminal

max. wire diameter: 2 wires of 1 mm  
max. wire cross-section: 1 strand at 0.75 mm<sup>2</sup>

### Connection

2.8 x 0.5 mm

## Mechanical characteristic values

### Actuating travel

EMERGENCY button 10 mm

### Actuating force

max. 65 N (measured on mushroom-head cap of emergency button)

### Self-aligning torque

15 Ncm

### Shock resistance

(single impact, half-sinusoidal)  
50 g, 11 ms as per IEC 512-4

### Resistance to vibration

(sinusoidal)  
10 g, at 10- 2000- 10- Hz  
Amplitude 0.75 mm as per IEC 512-4

### Rebound time

<= 2 ms

### Degree of pollution

3

## Protection class

Front side IP 65  
Switching element IP 40

## Ambient temperature

-25°C as per DIN EN 60068-2-1  
+55°C as per DIN EN 60068-2-2

## Storage temperature

-40°C to +85°C

## Mechanical service life

EMERGENCY button 50,000 operations

## Electrical characteristic values

### Switch rating

Silver contact  
(Solder/plug-inmin. 20 VAC, 10 mA  
connection)max. 250 VAC, 5 A

### Service category

Rated service voltage	Rated service current (inductive)	
	AC 13	AC 14
250 VAC	3 A	2 A
120 VAC	5 A	3 A
60 VAC	6 A	4 A
24 VAC	6 A	5 A

### Service category

Rated service voltage	Rated service current	
	resistive	DC 13
240 VDC	0.5 A	0.2 A
110 VDC	0.7 A	0.4 A
60 VDC	2.0 A	1.0 A
24 VDC	6.0 A	2.0 A

### Volume resistivity

New value for:  
Silver contact  
<= 50 m Ω  
as per IEC 512-2 Test 5

### Rated insulation voltage Ui

300 VAC

### Electric strength

as per VDE 0660 (IEC 512-2-11)  
4000 VAC, 50 Hz, 1 min between connections and earth

### Overvoltage category

III

## Thermal steady current

### $I_{th2}$ solder/plug-in connection 5 A

Max. permissible current for continuous operation and ambient temperature which does not exceed the specified max. values

### Max. permissible rated current

for series-connected blow-out fuse  
10 A gL

### Electrical service life

Slow-make element 6050 operations

### Approvals

- CE (declaration of conformity)
- CSA
- UR
- VDE
- ENEC

Right reserved to change all technical specifications.

## EMERGENCY slow-make element

### General

Is equipped with rigid contact link. The slow-make element opens positively and simply consists of a double-break NC. The multilayer contacts are designed for universal use and are gilded with a 2  $\mu$ m gold coating. The EMERGENCY slow-make element is designed according to DIN EN 60947-5-1.

### Material

### Housing

Duroplast (DAP)  
with fireproofing as per UL 94 V0

### Contact

AgNi, 2  $\mu$ m gilded

### Contact carrier

Brass or CuBe

### Connection

Brass gilded  
2.8 x 0.5 mm solder/plug-in or PCB connection  
1 mm<sup>2</sup> max. connection cross-section

### Mechanical characteristic values

#### Ambient temperature

-25°C as per DIN EN 60068-2-1  
+55°C as per DIN EN 60068-2-2

#### Storage temperature

-40°C to +85°C

#### Mechanical service life

8000 switching cycles

#### Contact opening width

> 2 x 1.5 mm

EMERGENCY switching element

### Electrical characteristic values

#### Rated voltage

250 V / 50 Hz

#### Service category

AC 15: 250 V / 1 A

#### Rated insulation voltage $U_i$

250 V

#### Series-connected blow-out fuse

5 A gL

#### Conventional thermal current $I_{th}$

5 A

#### Electrical service life

8000 switching cycles AC 15: 250 V / 1 A

### Diode element

#### General

Has no switching function. The diodes are soldered into the switching element housing between the contact connections.

#### Material

#### Housing

Thermoplast (PETP)  
with fireproofing as per UL 94 V0

#### Connection

Brass gilded  
2.8 x 0.5 mm solder/plug-in or PCB connection  
1 mm<sup>2</sup> max. connection cross-section

### Electrical characteristic values

#### Diode

1 N / 4007,  $I_{max.} = 1$  A,  $U_{block} = 1000$  V

### Dummy element

#### General

Is inserted in empty places in the switching element block. The dummy element has no metal parts and no electrical function.

#### Material

#### Housing

Thermoplast (PET)  
with fireproofing as per UL 94 V0

### Alarm buzzer

### Operating voltage

## Current consumption

approx. 13 mA

## Reverse-connect protection

yes

## Acoustics

approx. 84 dB at 0.1 m

## Frequency

approx. 2.3 kHz

## Unit

## General

In accordance with the low-voltage directive, our products are labelled with the CE mark.

SWISSTAC switches are modularly designed and are divided into the following three groups:

### 1. Front

Man-switch interface and state detector

### 2. Intermediate piece

Set and reset device, bulb holder, latching function

### 3. Switching element block

Up to five switching elements can be integrated in a switching element block.

Each switch is tested fully mounted. Electrical output and service life are determined by the switching element. Front and intermediate piece are designed for maximum service life of the switching element. They determine in what way the switches are protected against external influences. The type approvals relate to the complete switches. The approval regulations are UL 1054, VDE 0630 (EMERGENCY button VDE 0660), CSA 22.2.

## Mechanical characteristic values

### Resistance to vibration

tested as per DIN EN 60068-2-6 (10 g to 2000 Hz)

### Shock resistance

tested as per DIN EN 60068-2-27 (semi-sinusoidal, 50 g during 11 ms) (single impacts, semi-sinusoidal)  
15 g during 11 ms as per DIN EN 60068-2-29

## Approvals

- CE (declaration of conformity)
- CSA
- UR
- VDE
- ENEC

## Front

### General

The front notifies the switching status, serves for activation of the switch and determines its type of protection. The form and colours of the front also characterise the appearance of the entire switching system. With the exception of the front  $\gamma$  18 mm of the illuminated pushbuttons 55 and 70 mm, all front frame elements have activation protection.

## Material

### Lens

Thermoplast (PC)

### Front bezel

Thermoplast with fireproofing (PBT)

### Actuator 35 mm

Thermoplast with fireproofing (PBT)

### Lock housing

Thermoplast with fireproofing (PBT)

### Lock cylinder

Rynite reinforced with carbon fibre (PBT + CF)

Seal bellows (IP 65)

Silicon

## Mechanical characteristic values

### Protection class

as per IEC 529 (front side)

IP 40

IP 65

IP 67

protection against water

0 = without protection

5 = spray water

7 = watertight up to 1 m WS

protection against solid matter of varying size

4 = protection against solid matter  $> \gamma$  1 mm

6 = dust-tight

see "Intermediate piece" for other properties

## Intermediate piece

### General

The intermediate piece serves for several properties such as the setting and resetting functions, and the latching device. In addition, all parts necessary for a complete switch are fastened to the intermediate piece. These include the front parts, switching element block and lamps.

## Material

### Housing

Thermoplast with fireproofing (PC)

### Lamp connection

Nickel silver 2.8 x 0.5 mm

## Electrical characteristic values

### Electric strength

3750 V AC, 1 min. as per DIN EN 61058-1

### Insulation resistance

$> 10^{12} \Omega$  as per IEC 512-2-10

## Illumination

### Lamp voltage

6 V to 125 V as per CSA

6 V to 60 V as per VDE, UL, DEMKO

## Lamp output

max. 1.2 W

## Mechanical characteristic values

### Ambient temperature

-25°C as per DIN EN 60068-2-1

+55°C as per DIN EN 60068-2-2

### Storage temperature

-40°C to +85°C

### Service life

> 2 x 10<sup>6</sup> activations of the illuminated pushbuttons

> 5 x 10<sup>4</sup> activations of the key and selector switches

> 8 x 10<sup>3</sup> activations of the emergency button

> 2.5 x 10<sup>5</sup> activations of the push-pull illuminated button

## Switching element block

### General

Up to five independent switching elements can be integrated in the switching element block as a switching unit. There are four different types of switching element available.

1. Snap-action switching element
2. Emergency button switching element
3. Diode element
4. Dummy element

### Material

#### Bracket for three switching elements

rust-free chromium steel

#### Bracket for two switching elements

Thermoplast with fireproofing (PA6)

#### Lamp connection

CuBe, 2 µm Optalloy 2.8 x 0.5 mm solder/plug-in connection

## Electrical characteristic values

### Electric strength

2000 V AC, 50 Hz 1 min. (functional isolation)

### Insulation resistance

> 10<sup>12</sup> W

In accordance with the VDE 0630 regulation, blade receptacles must be used with the insulation socket 280-0010-00.

## Snap-action switching element

### General

Is equipped with double-break jump contacts. Owing to the large cleaning path, outstanding self-cleaning is possible. The multilayer contacts are designed for universal use. They are gilded with a 2 µm gold coating. Each snap-action switching element comprises an NC (normally closed contact) and an NO (normally open contact)

### Material

#### Housing

Thermoplast (PETP)  
with fireproofing as per UL 94 V0

## Contact

AgNi, 2 µm gilded

### Contact carrier

Brass or CuBe

### Connection

Brass gilded

2.8 x 0.5 mm solder/plug-in or PCB connection

1 mm<sup>2</sup> max. connection cross-section

## Mechanical characteristic values

### Ambient temperature

-25°C to +55°C

-25°C as per DIN EN 60068-2-1

+55°C as per DIN EN 60068-2-2

### Storage temperature

-40°C to +85°C as per DIN EN 60068

### Mechanical service life

2 x 10<sup>5</sup> switching cycles

### Contact opening width

2 x 0.65 mm

### Contact cleaning path

2 x 0.6 mm

### Rebound time

typically 0.5 ms

### Activation force

approx. 2 N for each snap-action switching element

## Electrical characteristic values

### Thermal steady current I<sub>th</sub> max.

6 A, up to 3-pole switching element block

4 A, for 4- and 5-pole switching element blocks

Limited on thermal grounds to I<sub>max</sub> = 4 A

### Volume resistivity

< = 50 m Ω typically, new statically

### Electrical load as per DIN EN 61058-1

5(1.5) A 250 V up to 3 switching elements

4(1) A 250 V for 4 or 5 switching elements,

min. AC / DC: 5 V / 1 mA

### Electrical service life

> 10<sup>4</sup> switching operations

DIN EN 61058-1250 V, (1.5) A

DIN EN 60947-5-1 AC 12:250 V / 0.5 A

110 V / 2 A

75 V / 5 A

60 V / 6 A

48 V / 6 A

24 V / 6 A

## Snap-action switching element

Out 4.7

In 3.6

## technical drawings

**1 indicator actuator 35 mm, pushbutton-/illuminated pushbutton actuator 35 mm**  
page 591, 592



**2 indicator 30 - 70 mm, buzzer 30 - 55 mm**  
page 591, 607

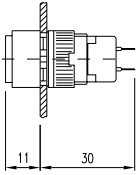

**3 indicator 30 - 70 mm**  
page 591



**4 indicator 30 - 70 mm, buzzer 30 - 55 mm**  
page 591, 607



**5 indicator 30 - 70 mm, buzzer 30 - 55 mm**  
page 591, 607



**6 indicator 30 - 70 mm**  
page 591



## 7 indicator 30 - 70 mm

page 591



## 8 illuminated-/pushbutton 55 - 70 mm

page 593



## 9 illuminated-/pushbutton 55 - 70 mm

page 593



## 10 illuminated-/pushbutton 55 - 70 mm

page 593



## 11 illuminated-/pushbutton 55 - 70 mm

page 593

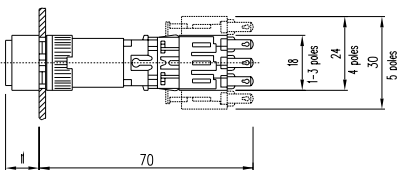

## 12 emergency stop switch 55 - 70 mm

page 594

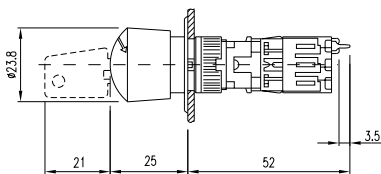

## 13 emergency stop switch 55 - 70 mm

page 594

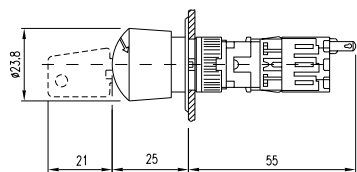

## 14 emergency stop switch 55 - 70 mm

page 594

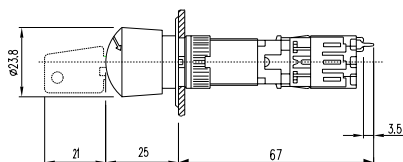

## 15 emergency stop switch 55 - 70 mm

page 594

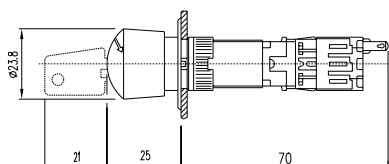

## 16 emergency stop switch foolproof 41 mm

page 596

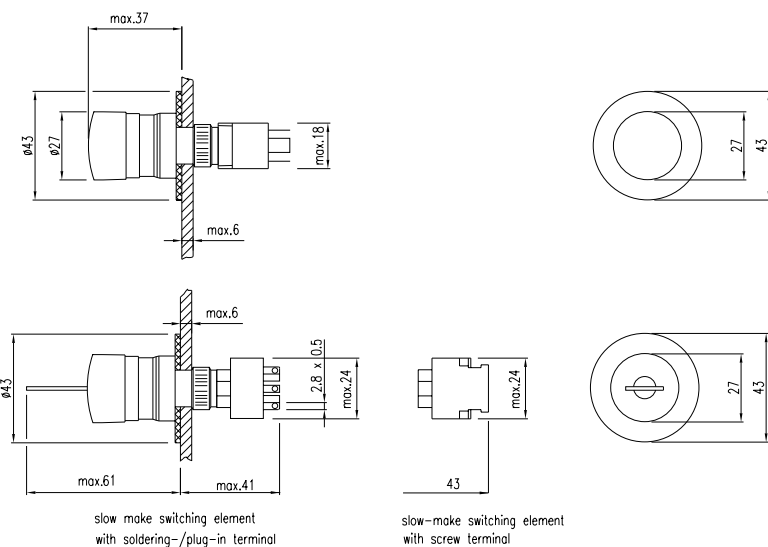

## 17 pushbutton with mushroom-head cap 55 - 70 mm

page 597

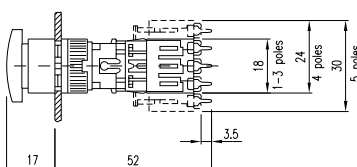



**18 pushbutton with mushroom-head cap 55 - 70 mm**

page 597

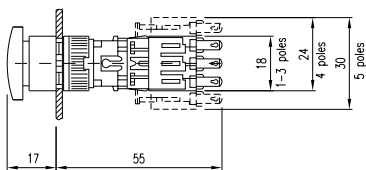

**19 pushbutton with mushroom-head cap 55 - 70 mm**

page 597

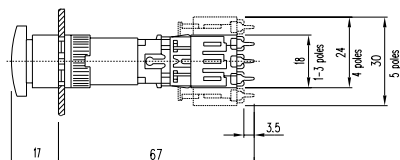

**20 pushbutton with mushroom-head cap 55 - 70 mm**

page 597

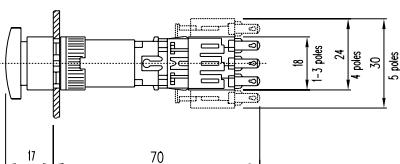

**21 keylock switch 2 positions 45 - 70 mm, keylock switch 3 positions 45 mm**

page 598, 602

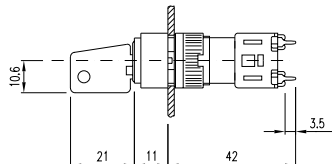

**22 keylock switch 2 positions 45 - 70 mm, keylock switch 3 positions 45 mm**

page 598, 602

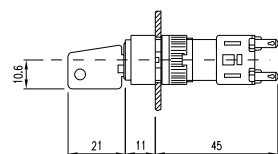

**23 keylock switch 2 positions 45 - 70 mm**

page 598

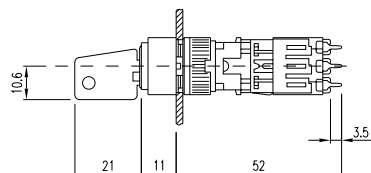

**24 keylock switch 2 positions 45 - 70 mm**  
page 598

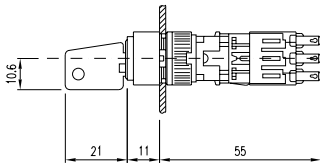

**25 keylock switch 2 positions 45 - 70 mm**  
page 598



**26 keylock switch 2 positions 45 - 70 mm**  
page 598

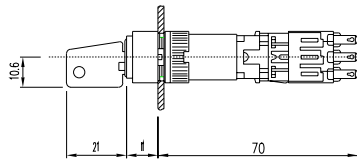

**27 selector switch 2 positions 45 - 70 mm, selector switch 3 positions 45 mm**  
page 603, 606

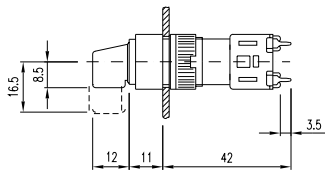

**28 selector switch 2 positions 45 - 70 mm, selector switch 3 positions 45 mm**  
page 603, 606

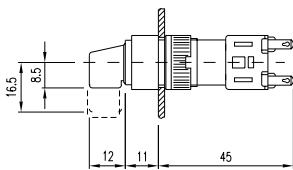

**29 selector switch 2 positions 45 - 70 mm**  
page 603

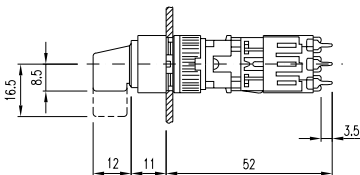

**30 selector switch 2 positions 45 - 70 mm**  
page 603



**31 selector switch 2 positions 45 - 70 mm**  
page 603



**32 selector switch 2 positions 45 - 70 mm**  
page 603



**33 push-pull illuminated switch 45 mm**  
page 607



**34 push-pull illuminated switch 45 mm**  
page 607



**35 indicator actuator 41-44 mm for flush mounting, illuminated-/pushbutton actuator 41-44 mm for flush mounting**  
page 608, 610



**36 indicator for flush mounting 39 - 79 mm, buzzer for flush mounting 39 - 64 mm**  
page 609, 621

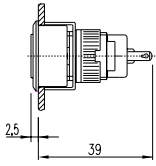

**37 indicator for flush mounting 39 - 79 mm**  
page 609

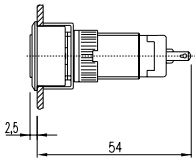

**38 indicator for flush mounting 39 - 79 mm, buzzer for flush mounting 39 - 64 mm**  
page 609, 621

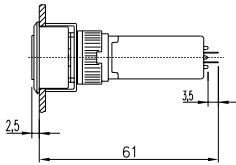

**39 indicator for flush mounting 39 - 79 mm, buzzer for flush mounting 39 - 64 mm**  
page 609, 621

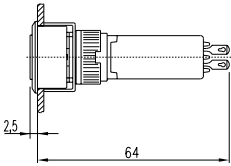

**40 indicator for flush mounting 39 - 79 mm**  
page 609

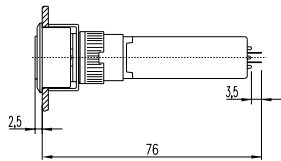

**41 indicator for flush mounting 39 - 79 mm**  
page 609

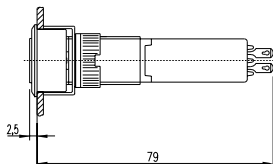

**42 pushbutton-/illuminated pushbutton for flush mounting 61 - 79 mm**

page 611

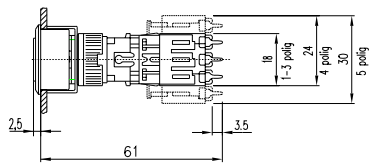

**43 pushbutton-/illuminated pushbutton for flush mounting 61 - 79 mm**

page 611

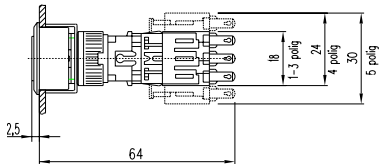

**44 pushbutton-/illuminated pushbutton for flush mounting 61 - 79 mm**

page 611

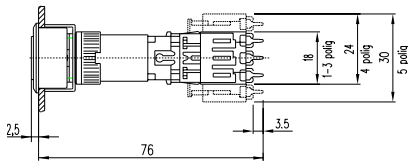

**45 pushbutton-/illuminated pushbutton for flush mounting 61 - 79 mm**

page 611

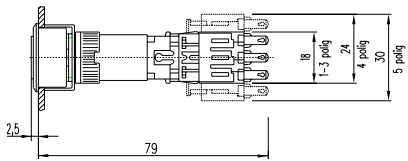

**46 keylock switch 2 positions for flush mounting 51 - 79 mm, keylock switch with 3 positions for flush mounting 51 - 54 mm**

page 612, 616

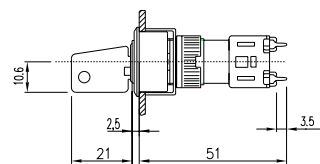

**47 keylock switch 2 positions for flush mounting 51 - 79 mm, keylock switch with 3 positions for flush mounting 51 - 54 mm**

page 612, 616

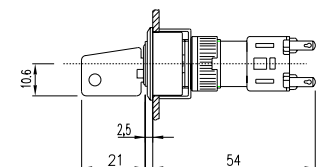

**48 keylock switch 2 positions for flush mounting 51 - 79 mm**

page 612

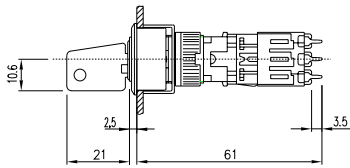

**49 keylock switch 2 positions for flush mounting 51 - 79 mm**

page 612

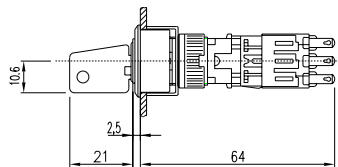

**50 keylock switch 2 positions for flush mounting 51 - 79 mm**

page 612

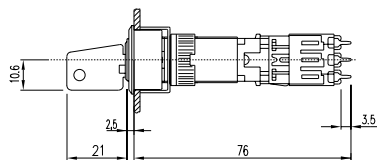

**51 keylock switch 2 positions for flush mounting 51 - 79 mm**

page 612

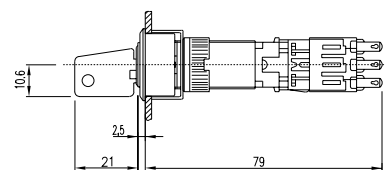

**52 selector switch 2 positions for flush mounting 51 - 79 mm, selector switch 3 positions for flush mounting 51 - 54 mm**

page 617, 620

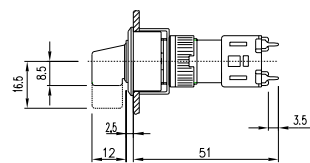

**53 selector switch 2 positions for flush mounting 51 - 79 mm, selector switch 3 positions for flush mounting 51 - 54 mm**

page 617, 620

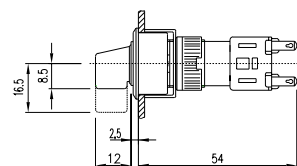

**54 selector switch 2 positions for flush mounting 51 - 79 mm**  
page 617



**55 selector switch 2 positions for flush mounting 51 - 79 mm**  
page 617



**56 selector switch 2 positions for flush mounting 51 - 79 mm**  
page 617



**57 selector switch 2 positions for flush mounting 51 - 79 mm**  
page 617



**58 protective cover for 35 mm, protective cover for illuminated-/pushbutton 55 - 70 mm**  
page 628, 629



## 59 snap-action switching element

page 632

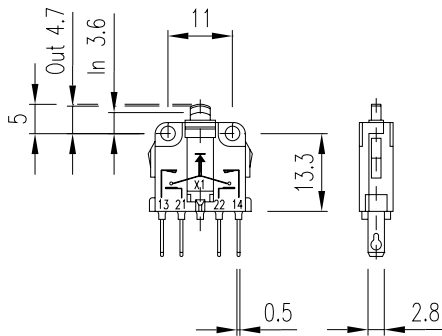

## 60 slow-make switching element for emergency stop switch

page 636

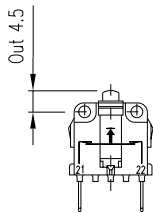

### mounting dimensions

#### 1 indicator actuator 35 mm, pushbutton-/illuminated pushbutton actuator 35 mm

page 591, 592

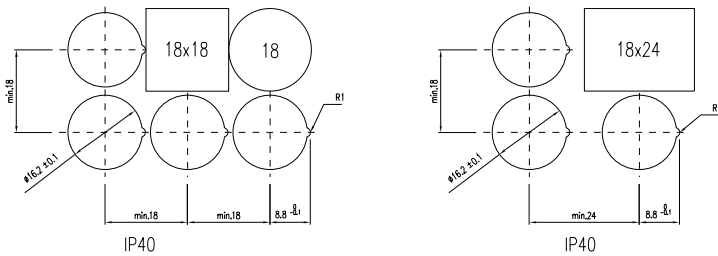

#### 2 indicator actuator 35 mm, pushbutton-/illuminated pushbutton actuator 35 mm

page 591, 592

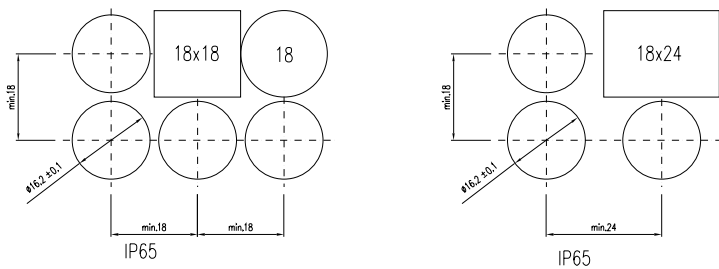



**3 indicator 30 - 70 mm, illuminated-/pushbutton 55 - 70 mm**  
page 591, 593,



**4 emergency stop switch 55 - 70 mm**  
page 594



**5 emergency stop switch 55 - 70 mm**  
page 594



**6 emergency stop switch foolproof 41 mm**  
page 596



## 7 pushbutton with mushroom-head cap 55 - 70 mm

page 597

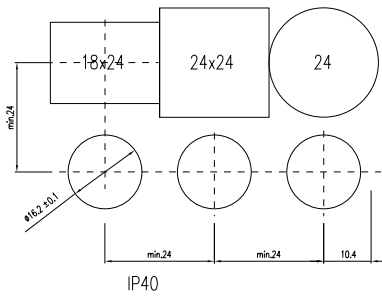

## 8 keylock switch 2 positions 45 - 70 mm, keylock switch 3 positions 45 mm

598, 602,

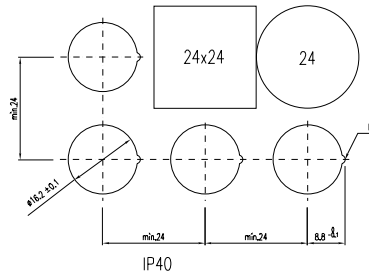
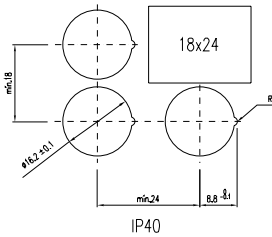
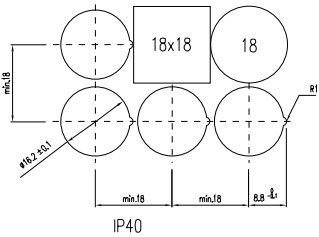

## 9 keylock switch 2 positions 45 - 70 mm, keylock switch 3 positions 45 mm

page 598, 602

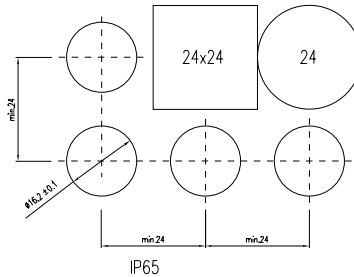
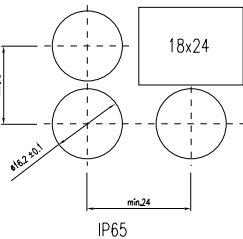
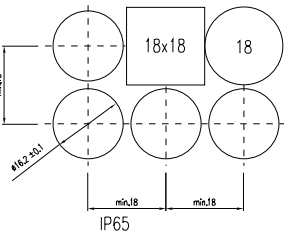

## 10 selector switch 2 positions 45 - 70 mm, selector switch 3 positions 45 mm

page 603, 606

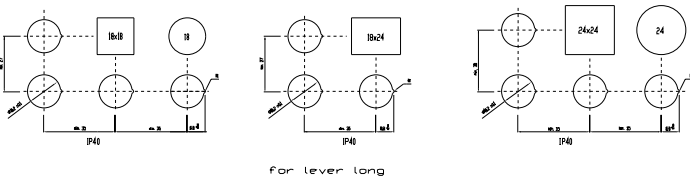

for lever long

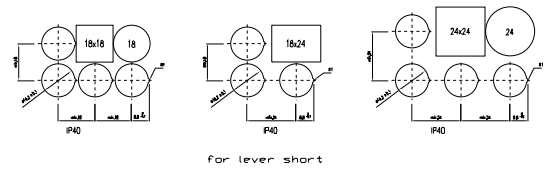

for lever short

## 11 selector switch 2 positions 45 - 70 mm, selector switch 3 positions 45 mm

page 603, 606

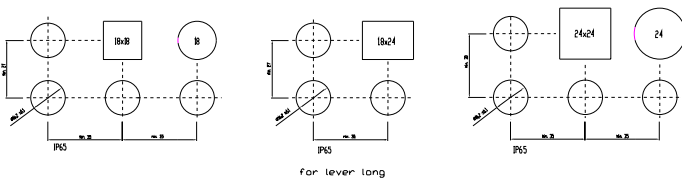

for lever long

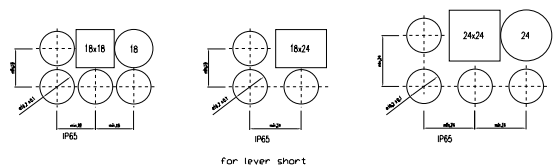

for lever short

## 12 buzzer 30 - 55 mm

page 607

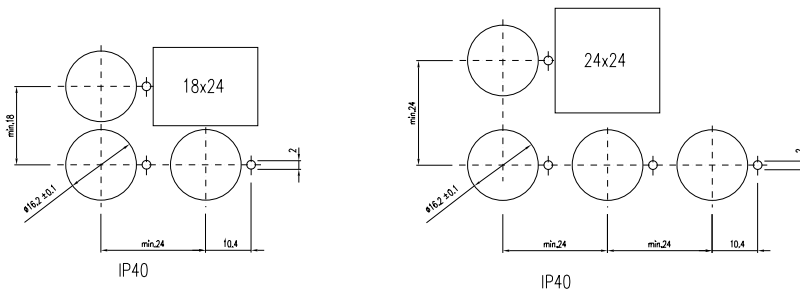

## 13 push-pull illuminated switch 45 mm

page 607

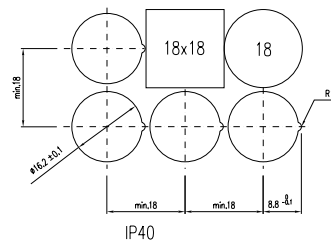

**14 indicator actuator 41-44 mm for flush mounting, indicator for flush mounting 39 - 79 mm, illuminated-/pushbutton actuator 41-44 mm for flush mounting, pushbutton-/illuminated pushbutton for flush mounting 61 - 79 mm, keylock switch with 3 positions for flush mounting 51 - 54 mm**  
page 608, 609, 610, 611, 612, 616

$\varnothing 25\text{mm}$

24 x 30mm

24 x 24mm

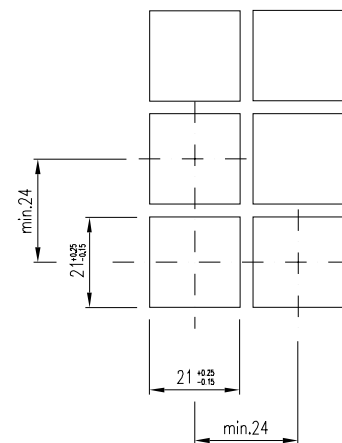
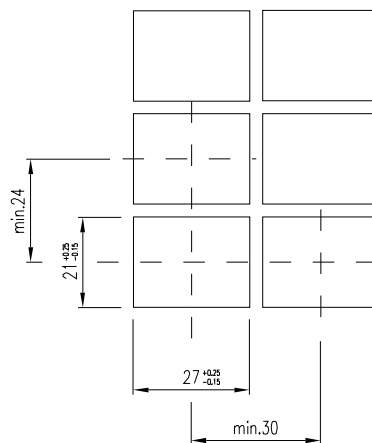
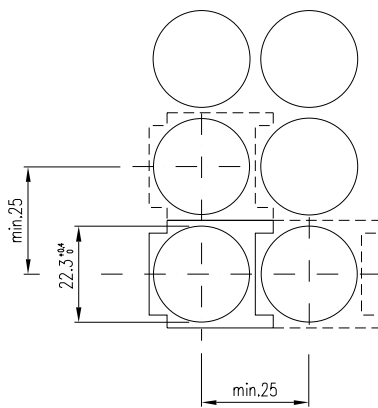

**15 selector switch 2 positions for flush mounting 51 - 79 mm, selector switch 3 positions for flush mounting 51 - 54 mm**  
page 617, 620

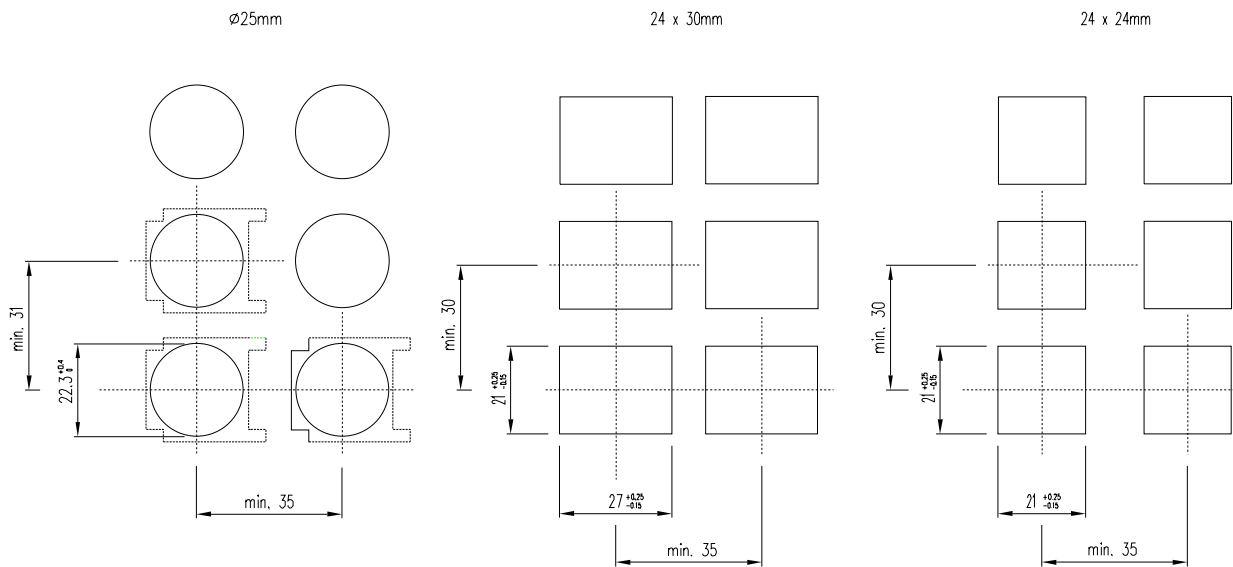

**16 buzzer for flush mounting 39 - 64 mm**  
page 621

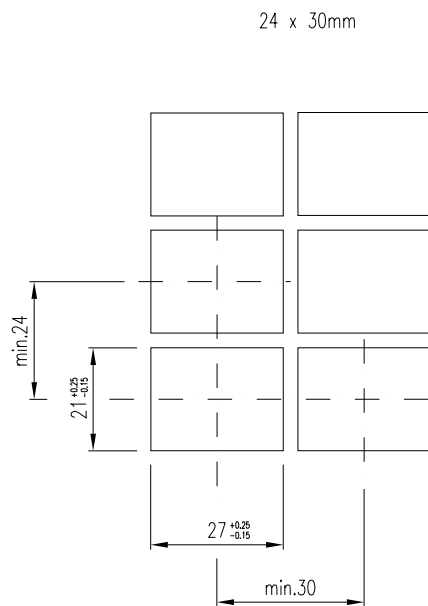

## component layouts

1 indicator actuator 35 mm, indicator 30 - 70 mm, pushbutton-/illuminated pushbutton actuator 35 mm, illuminated-/pushbutton 55 - 70 mm, emergency stop switch 55 - 70 mm, pushbutton with mushroom-head cap 55 - 70 mm, keylock switch 2 positions 45 - 70 mm, keylock switch 3 positions 45 mm, selector switch 2 positions 45 - 70 mm, selector switch 3 positions 45 mm, buzzer 30 - 55 mm, push-pull illuminated switch 45 mm, indicator for flush mounting 39 - 79 mm, pushbutton-/illuminated pushbutton for flush mounting 61 - 79 mm, keylock switch 2 positions for flush mounting 51 - 79 mm, keylock switch with 3 positions for flush mounting 51 - 54 mm, selector switch 2 positions for flush mounting 51 - 79 mm, selector switch 3 positions for flush mounting 51 - 54 mm, buzzer for flush mounting 39 - 64 mm, snap-action switching element block for 35 mm, lamp element block for 35 mm

page 591, 591, 592, 593, 594, 597, 598, 602, 603, 606, 607, 607, 609, 611, 612, 616, 617, 620, 621, 631, 632

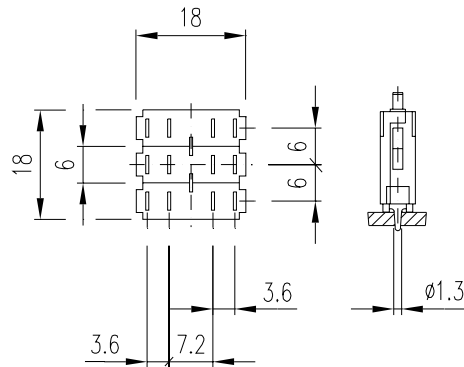

## circuit drawings

1 indicator actuator 35 mm, indicator 30 - 70 mm, indicator actuator 41-44 mm for flush mounting, indicator for flush mounting 39 - 79 mm, lamp element block for 35 mm

page 591, 591, 608, 609, 632

x1+



x2-

2 pushbutton-/illuminated pushbutton actuator 35 mm

page 592



3 pushbutton-/illuminated pushbutton actuator 35 mm

page 59

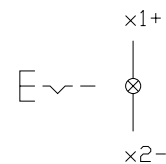

**4 illuminated-/pushbutton 55 - 70 mm, pushbutton-/illuminated pushbutton for flush mounting 61 - 79 mm**  
 593, 611,

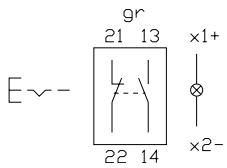

**5 illuminated-/pushbutton 55 - 70 mm, pushbutton-/illuminated pushbutton for flush mounting 61 - 79 mm**  
 page 593, 611

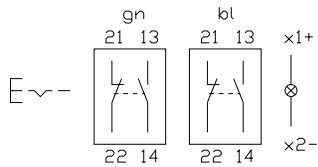

**6 illuminated-/pushbutton 55 - 70 mm, pushbutton-/illuminated pushbutton for flush mounting 61 - 79 mm**  
 page 593, 611

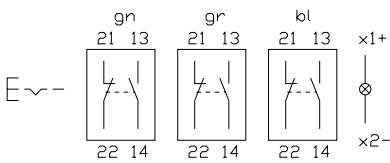

**7 illuminated-/pushbutton 55 - 70 mm, pushbutton-/illuminated pushbutton for flush mounting 61 - 79 mm**  
 page 593, 611

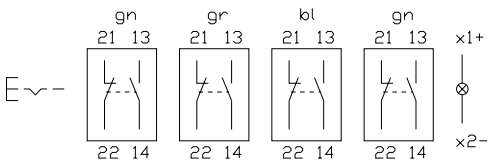

**8 illuminated-/pushbutton 55 - 70 mm, pushbutton-/illuminated pushbutton for flush mounting 61 - 79 mm**  
 page 593, 611

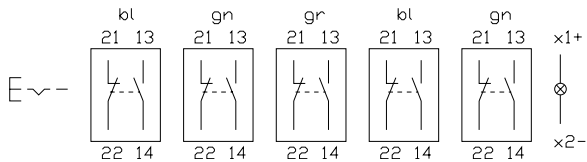

**9 emergency stop switch 55 - 70 mm**  
 page 594

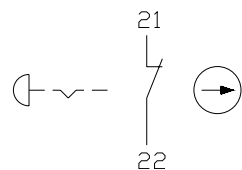

**10 emergency stop switch 55 - 70 mm**  
 page 594

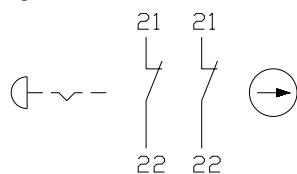

## 11 emergency stop switch 55 - 70 mm

page 594



## 12 emergency stop switch foolproof 41 mm

page 596



## 13 emergency stop switch foolproof 41 mm

page 596

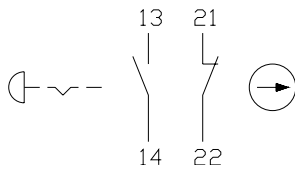

## 14 emergency stop switch foolproof 41 mm

page 596

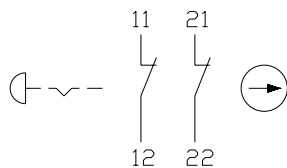

## 15 pushbutton with mushroom-head cap 55 - 70 mm

page 597

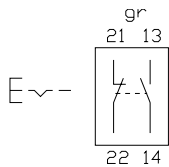

## 16 pushbutton with mushroom-head cap 55 - 70 mm

page 597

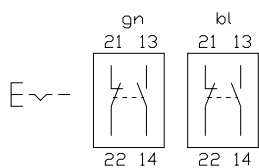

## 17 pushbutton with mushroom-head cap 55 - 70 mm

page 597

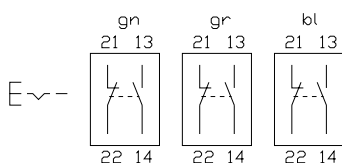

## 18 pushbutton with mushroom-head cap 55 - 70 mm

page 597



## 19 pushbutton with mushroom-head cap 55 - 70 mm

page 597



## 20 keylock switch 2 positions 45 - 70 mm, keylock switch 2 positions for flush mounting 51 - 79 mm

page 598, 612



## 21 keylock switch 2 positions 45 - 70 mm, keylock switch 2 positions for flush mounting 51 - 79 mm

page 598, 612



## 22 keylock switch 2 positions 45 - 70 mm, keylock switch 2 positions for flush mounting 51 - 79 mm

page 598, 612

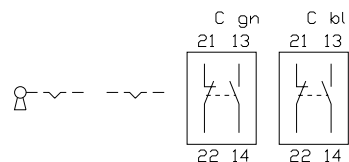

## 23 keylock switch 2 positions 45 - 70 mm, keylock switch 2 positions for flush mounting 51 - 79 mm

page 598, 612



## 24 keylock switch 2 positions 45 - 70 mm, keylock switch 2 positions for flush mounting 51 - 79 mm

page 598, 612





**25 keylock switch 2 positions 45 - 70 mm, keylock switch 2 positions for flush mounting 51 - 79 mm**  
page 598, 612



**26 keylock switch 2 positions 45 - 70 mm, keylock switch 2 positions for flush mounting 51 - 79 mm**  
page 598, 612



**27 keylock switch 2 positions 45 - 70 mm, keylock switch 2 positions for flush mounting 51 - 79 mm**  
page 598, 612



**28 keylock switch 2 positions 45 - 70 mm, keylock switch 2 positions for flush mounting 51 - 79 mm**  
page 598, 612



**29 keylock switch 2 positions 45 - 70 mm, keylock switch 2 positions for flush mounting 51 - 79 mm**  
page 598, 612



**30 keylock switch 2 positions 45 - 70 mm, keylock switch 2 positions for flush mounting 51 - 79 mm**  
page 598, 612



**31 keylock switch 2 positions 45 - 70 mm, keylock switch 2 positions for flush mounting 51 - 79 mm**  
page 598, 612



**32 keylock switch 3 positions 45 mm, keylock switch with 3 positions for flush mounting 51 - 54 mm**  
page 602, 616

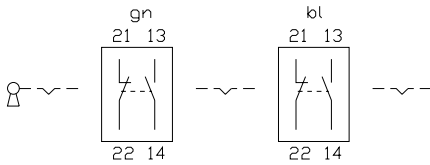

**33 keylock switch 3 positions 45 mm, keylock switch with 3 positions for flush mounting 51 - 54 mm**  
page 602, 616



**34 keylock switch 3 positions 45 mm, keylock switch with 3 positions for flush mounting 51 - 54 mm**  
page 602, 616



**35 keylock switch 3 positions 45 mm, keylock switch with 3 positions for flush mounting 51 - 54 mm**  
page 602, 616



**36 selector switch 2 positions 45 - 70 mm, selector switch 2 positions for flush mounting 51 - 79 mm**  
page 603, 617



**37 selector switch 2 positions 45 - 70 mm, selector switch 2 positions for flush mounting 51 - 79 mm**  
page 603, 617

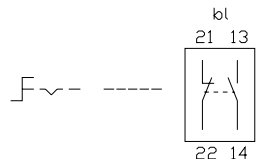

**38 selector switch 2 positions 45 - 70 mm, selector switch 2 positions for flush mounting 51 - 79 mm**  
page 603, 617



**39 selector switch 2 positions 45 - 70 mm, selector switch 2 positions for flush mounting 51 - 79 mm**  
page 603, 617



**40 selector switch 2 positions 45 - 70 mm, selector switch 2 positions for flush mounting 51 - 79 mm**  
page 603, 617

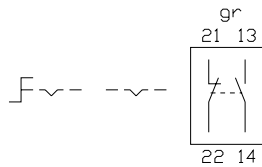

**41 selector switch 2 positions 45 - 70 mm, selector switch 2 positions for flush mounting 51 - 79 mm**  
page 603, 617

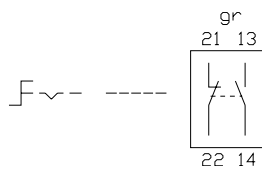

**42 selector switch 2 positions 45 - 70 mm, selector switch 2 positions for flush mounting 51 - 79 mm**  
page 603, 617

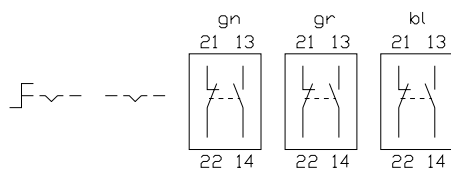

**43 selector switch 2 positions 45 - 70 mm, selector switch 2 positions for flush mounting 51 - 79 mm**  
page 603, 617

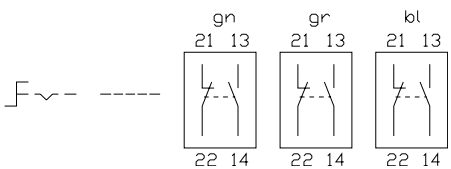

**44 selector switch 2 positions 45 - 70 mm, selector switch 2 positions for flush mounting 51 - 79 mm**  
page 603, 617

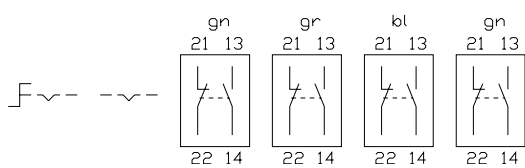

**45 selector switch 2 positions 45 - 70 mm, selector switch 2 positions for flush mounting 51 - 79 mm**  
page 603, 617

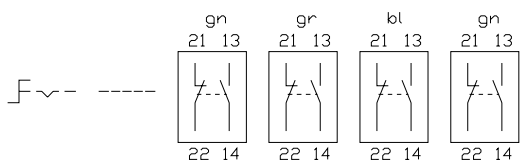

**46 selector switch 2 positions 45 - 70 mm, selector switch 2 positions for flush mounting 51 - 79 mm**  
page 603, 617

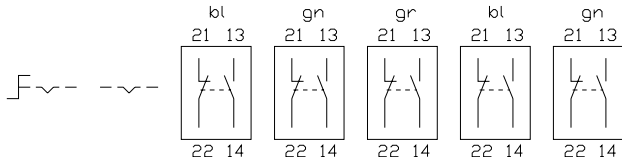

**47 selector switch 2 positions 45 - 70 mm, selector switch 2 positions for flush mounting 51 - 79 mm**  
page 603, 617

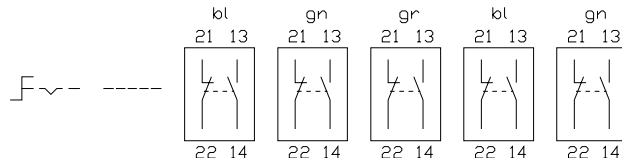

**48 selector switch 3 positions 45 mm, selector switch 3 positions for flush mounting 51 - 54 mm**  
page 606, 620

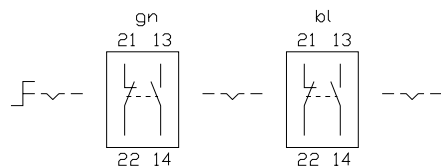

**49 selector switch 3 positions 45 mm, selector switch 3 positions for flush mounting 51 - 54 mm**  
page 606, 620

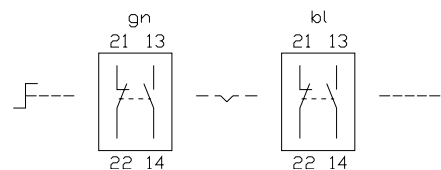

**50 selector switch 3 positions 45 mm, selector switch 3 positions for flush mounting 51 - 54 mm**  
page 606, 620

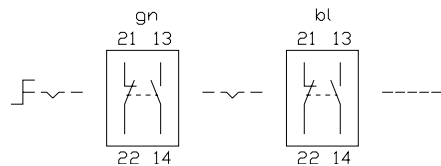

**51 selector switch 3 positions 45 mm, selector switch 3 positions for flush mounting 51 - 54 mm**  
page 606, 620

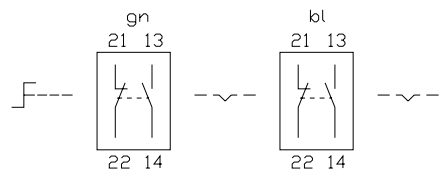

**52 buzzer 30 - 55 mm, buzzer for flush mounting 39 - 64 mm**  
page 607, 621

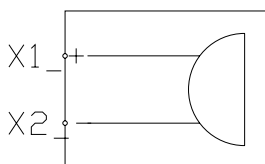

## 53 push-pull illuminated switch 45 mm

page 607

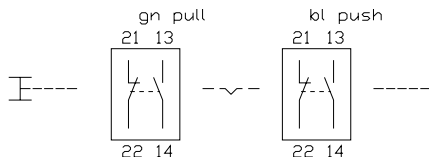

## 54 illuminated-/pushbutton actuator 41-44 mm for flush mounting

page 610



## 55 illuminated-/pushbutton actuator 41-44 mm for flush mounting

page 610



## 56 snap-action switching element block for 35 mm

page 631



## 57 snap-action switching element block for 35 mm

page 631



## 58 snap-action switching element block for 35 mm

page 631



## 59 snap-action switching element block for 35 mm

page 631



## 60 lamp element block for 35 mm

page 632

14 x1+



13 x2-

## 61 lamp element block for 35 mm

page 632

14 22 x1+



13 21 x2-

## 1. Engraving

The lens top or the lens holder can be engraved in any of the usual languages.  
Typefaces: compressed typeface to DIN 1451. Other faces on request.

### Colour of lettering

White for lens tops red, blue, green and black  
Black for lens tops orange, yellow, grey and white  
Black for lens holders translucent and transparent

### Important!

With engraving, the position of the lens must agree with the position of the push-button or indicator.  
However, the lens can be mounted turned through 180°.

## 2. Hot stamping

For lettering any sizeable quantity we recommend pad printing on the lens holder.

### Important!

With pad printing, the position of the lens must agree with the position of the push-button or indicator.  
However, the lens can be mounted turned through 180°.

## 3. Film insert

Instead of engraving, a transparent foil can be laid in the lens tops, except with the colours grey and black.

### Foil thickness

Ø 18 mm  
18 x 18 mm  
18 x 24 mm  
Ø 24 mm  
24 x 24 mm

### 0.1 mm max

Ø 12,7 mm  
12,7 x 12,7 mm  
12,7 x 18,9 mm  
Ø 18,3 mm  
18,3 x 18,3 mm

### Filmdickemax. 0,1mm



### Important!

When a foil is used, the position of the lens must agree with the position of the push-button or indicator.  
However, the lens can be mounted turned through 180°.

Height of letters	'round' 18		18 x 18		18 x 24		24 x 18		'round' 24		24 x 24	
	Number of lines	- Number of letters per line	Number of lines	- Number of letters per line	Number of lines	- Number of letters per line	Number of lines	- Number of letters per line	Number of lines	- Number of letters per line	Number of lines	- Number of letters per line
h												
2,5 mm	2	5	3	5	3	8	5	5	4	7	5	8
3 mm	2	5	3	5	3	8	4	5	3	7	4	8
4 mm	1	3	2	3	2	5	3	3	3	4	3	6
5 mm	1	2	1	3	1	5	2	3	2	3	2	5





Компания «Океан Электроники» предлагает заключение долгосрочных отношений при поставках импортных электронных компонентов на взаимовыгодных условиях!

Наши преимущества:

- Поставка оригинальных импортных электронных компонентов напрямую с производств Америки, Европы и Азии, а так же с крупнейших складов мира;
- Широкая линейка поставок активных и пассивных импортных электронных компонентов (более 30 млн. наименований);
- Поставка сложных, дефицитных, либо снятых с производства позиций;
- Оперативные сроки поставки под заказ (от 5 рабочих дней);
- Экспресс доставка в любую точку России;
- Помощь Конструкторского Отдела и консультации квалифицированных инженеров;
- Техническая поддержка проекта, помощь в подборе аналогов, поставка прототипов;
- Поставка электронных компонентов под контролем ВП;
- Система менеджмента качества сертифицирована по Международному стандарту ISO 9001;
- При необходимости вся продукция военного и аэрокосмического назначения проходит испытания и сертификацию в лаборатории (по согласованию с заказчиком);
- Поставка специализированных компонентов военного и аэрокосмического уровня качества (Xilinx, Altera, Analog Devices, Intersil, Interpoint, Microsemi, Actel, Aeroflex, Peregrine, VPT, Syfer, Eurofarad, Texas Instruments, MS Kennedy, Miteq, Cobham, E2V, MA-COM, Hittite, Mini-Circuits, General Dynamics и др.);

Компания «Океан Электроники» является официальным дистрибьютором и эксклюзивным представителем в России одного из крупнейших производителей разъемов военного и аэрокосмического назначения «JONHON», а так же официальным дистрибьютором и эксклюзивным представителем в России производителя высокотехнологичных и надежных решений для передачи СВЧ сигналов «FORSTAR».



## JONHON

«JONHON» (основан в 1970 г.)

Разъемы специального, военного и аэрокосмического назначения:

(Применяются в военной, авиационной, аэрокосмической, морской, железнодорожной, горно- и нефтедобывающей отраслях промышленности)

«FORSTAR» (основан в 1998 г.)

ВЧ соединители, коаксиальные кабели, кабельные сборки и микроволновые компоненты:

(Применяются в телекоммуникациях гражданского и специального назначения, в средствах связи, РЛС, а так же военной, авиационной и аэрокосмической отраслях промышленности).



Телефон: 8 (812) 309-75-97 (многоканальный)

Факс: 8 (812) 320-03-32

Электронная почта: [ocean@oceanchips.ru](mailto:ocean@oceanchips.ru)

Web: <http://oceanchips.ru/>

Адрес: 198099, г. Санкт-Петербург, ул. Калинина, д. 2, корп. 4, лит. А