

Description

The AL3065 is a high efficiency 4-channel boost controller for WLED backlight applications. It operates over a wide input voltage ranged from 4.5V to 33V.

The current of the 4 channels is simply programmed from 20mA to 400mA with an external resistor. The current match between any channel is $\pm 1.5\%$ (typical). Its operating frequency can be adjusted from 0.1MHz to 1MHz.

The AL3065 can support three dimming modes: direct PWM dimming, PWM to analog dimming and DC to analog dimming.

Robust protection features include cycle by cycle current limit, soft-start, UVLO, programmable OVP, OTP, open/short LED protection, Schottky Diode Short and Open Protection, Inductor Short-Circuit Protection and V_{OUT} Short protection.

The IC is available in SO-16 package.

Features

- Input Voltage Range: 4.5V to 33V
- Drivers up to 4 Strings in Parallel, 250mA per String, 400mA Pulse Current
- $\pm 3\%$ Current Precision
- Low Ripple for Low BOM Cost
- 4KV HBM ESD Class
- High Voltage Pins CS and OVP for Safety Test
- Supports Direct PWM Dimming, PWM to Analog Dimming and DC to Analog Dimming Control
- Minimum PWM Dimming Duty Cycle can be 1/10,000 at 100Hz Dimming Frequency
- LED Open/Short Protection
- Schottky Diode/Inductor Short-Circuit Protection
- Built-in OCP, OVP, OTP, UVLO, V_{OUT} Short/Schottky Diode Open Protection
- **Totally Lead-Free & Fully RoHS Compliant (Notes 1 & 2)**
- **Halogen and Antimony Free. "Green" Device (Note 3)**

- Notes:
1. No purposely added lead. Fully EU Directive 2002/95/EC (RoHS) & 2011/65/EU (RoHS 2) compliant.
 2. See http://www.diodes.com/quality/lead_free.html for more information about Diodes Incorporated's definitions of Halogen- and Antimony-free, "Green" and Lead-free.
 3. Halogen- and Antimony-free "Green" products are defined as those which contain <900ppm bromine, <900ppm chlorine (<1500ppm total Br + Cl) and <1000ppm antimony compounds.

Pin Assignments

(Top View)

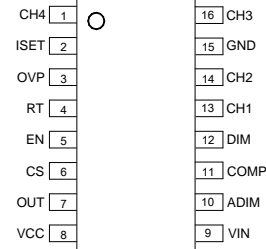

SO-16

Applications

- LCD Monitor
- LCD Display Module
- LCD TV

Typical Applications Circuit

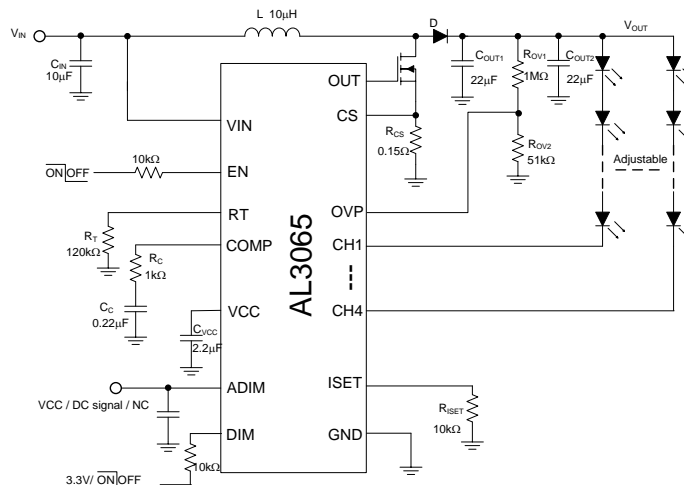

Pin Descriptions

Pin Number	Pin Name	Function
1	CH4	LED current sink 4. Leave the pin open directly if not used.
2	ISET	LED current set pin. The corresponding maximum current of all 4 strings is set through connecting a resistor from this pin to GND.
3	OVP	Overshoot protection pin. When the OVP pin voltage exceeds 2.0V, the OVP is triggered and the power switch is turned off. When the OVP pin voltage drops below Hysteresis voltage, the OVP is released and the power switch will resume normal operation.
4	RT	Frequency control pin.
5	EN	ON/OFF control pin. Forcing this pin voltage above 2.4V enables the IC while below 0.5V shuts down the IC. When the IC is in shutdown mode, all functions are disabled to reduce the supply current below 3 μ A.
6	CS	Power switch current sense input.
7	OUT	Boost converter power switch gate output. This pin outputs high voltage (10V) to drive the external N-MOSFET.
8	VCC	10V linear regulator output pin. This pin should be bypassed to GND with a ceramic capacitor.
9	VIN	Supply input pin. A capacitor (typical 10 μ F) should be connected between the VIN and GND to keep the DC input voltage constant.
10	ADIM	Analog dimming pin, used in conjunction with DIM. When a DC voltage between 0V and 1.5V is applied to this pin analog dimming is achieved if DIM is tied HIGH. When a capacitor is connected between this pin and GND, the PWM signal applied to the DIM pin is filtered and modulates the output current. When this pin is connected to a HIGH level, direct PWM dimming is achieved.
11	COMP	Soft-start and control loop compensation.
12	DIM	PWM dimming control pin, used in conjunction with ADIM. Apply the PWM signal to this pin. Tie this pin to logic HIGH level, for analog dimming.
13	CH1	LED current sink 1. Leave the pin open directly if not used.
14	CH2	LED current sink 2. Leave the pin open directly if not used.
15	GND	Ground
16	CH3	LED current sink 3. Leave the pin open directly if not used.

Functional Block Diagram

NEW PRODUCT

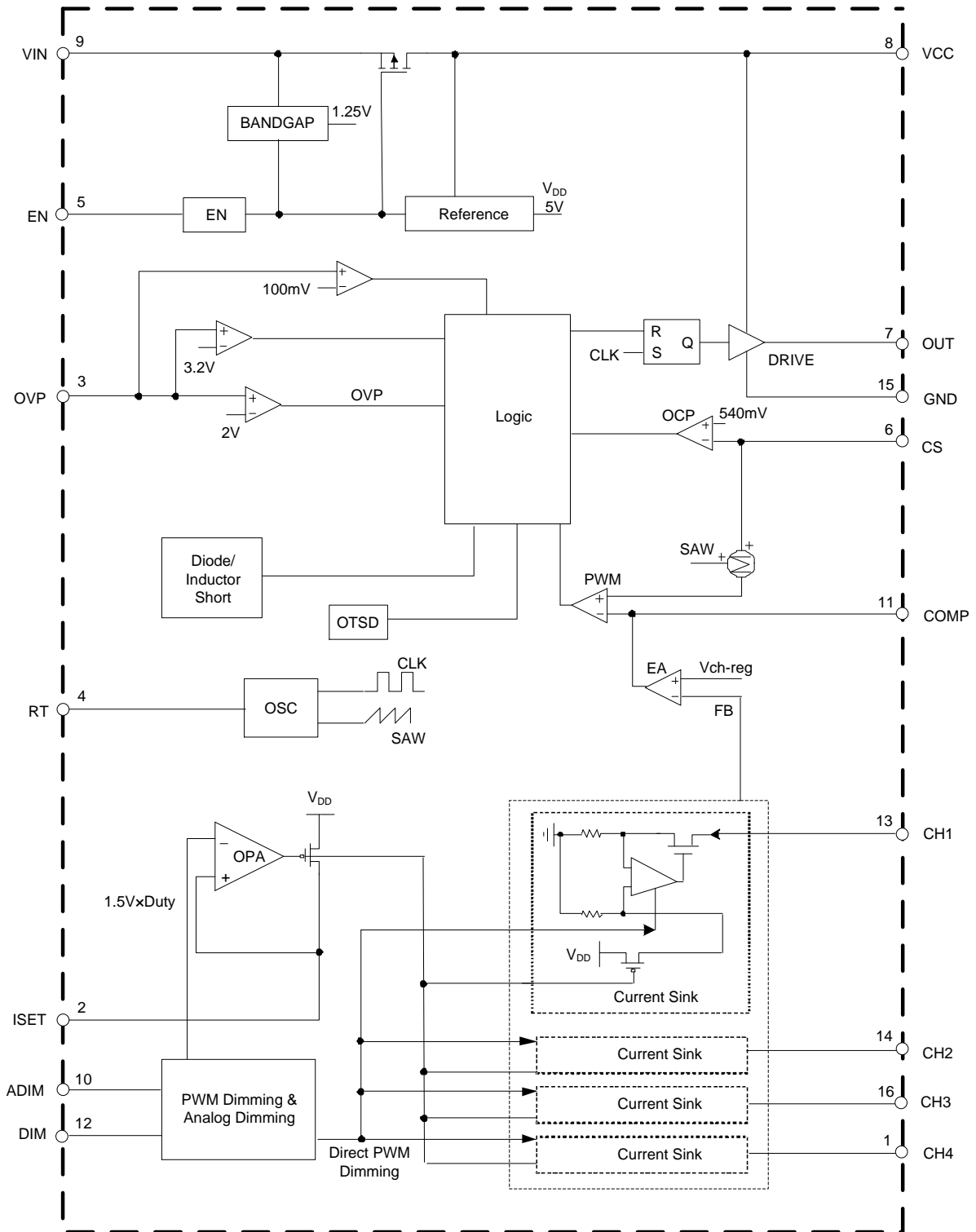

Absolute Maximum Ratings (@T_A = +25°C, unless otherwise specified. Notes 4, 5)

Symbol	Parameter	Rating	Unit
V _{IN}	Input Voltage	-0.3 to 40	V
V _{EN}	EN Pin Voltage	-0.3 to 7	V
V _{CC}	VCC Pin Voltage	-0.3 to 7	V
V _{CH}	CH1 to CH4 Pins Voltage	-0.3 to 60	V
V _{CS}	CS Pin Voltage	-0.3 to 42	V
V _{COMP}	COMP Pin Voltage	-0.3 to 7	V
V _{ISET}	ISET Pin Voltage	-0.3 to 7	V
V _{OUT}	OUT Pin Voltage	-0.3 to 7	V
V _{OVP}	OVP Pin Voltage	-0.3 to 42	V
V _{RT}	RT Pin Voltage	-0.3 to 7	V
V _{ADIM}	ADIM Pin Voltage	-0.3 to 7	V
V _{DIM}	DIM Pin Voltage	-0.3 to 7	V
V _{GND}	GND Pin Voltage	-0.3 to 0.3	V
θ _{JA}	Thermal Resistance (Free Air, No Heatsink)	100	°C/W
T _J	Operating Junction Temperature	+150	°C
T _{STG}	Storage Temperature	-65 to +150	°C
T _{LEAD}	Lead Temperature (Soldering, 10sec)	+260	°C
–	ESD (Machine Model)	200	V
–	ESD (Human Body Model)	4000	V

- Notes:
- Stresses greater than those listed under “Absolute Maximum Ratings” may cause permanent damage to the device. These are stress ratings only and functional operation of the device at these or any other conditions beyond those indicated under “Recommended Operating Conditions” are not implied. Exposure to “Absolute Maximum Ratings” for extended periods may affect device reliability.
 - For better performance, the AL3065 should have high voltage pins CS and OVP. If CS or OVP pin is added to 16V, the IC will not smoke or burn.

Recommended Operating Conditions

Symbol	Parameter	Min	Max	Unit
V _{IN}	Input Voltage	4.5	33	V
f _O	Operating Frequency	0.1	1	MHz
I _{CH}	LED Channel Current	20	400	mA
f _{PWM}	PWM Dimming Frequency	0.1	25	KHz
T _A	Operating Ambient Temperature	-40	+85	°C

Electrical Characteristics (@ $T_A = +25^\circ\text{C}$, $V_{IN} = 12\text{V}$, $V_{EN} = 5\text{V}$, unless otherwise specified.)

Symbol	Parameter	Conditions	Min	Typ	Max	Unit
Input Supply						
V_{IN}	Input Voltage	–	4.5	–	33	V
I_Q	Quiescent Current	No Switching	–	3	–	mA
I_{SHDN}	Shutdown Supply Current	$V_{EN} = 0\text{V}$	–	1	–	μA
V_{UVLO}	Under-Voltage Lockout Voltage	V_{IN} Rising	3.7	4.0	4.3	V
V_{HYS}	UVLO Hysteresis	–	–	200	–	mV
V_{CC} Regulator						
V_{CC}	V_{CC} Voltage	$V_{IN} \geq 5.5\text{V}$	–	5	–	V
		$V_{IN} < 5.5\text{V}$	–	$V_{IN}-0.5$	–	V
t_{RISE}	OUT Pin Rise Time	OUT Pin Load = 1nF	–	30	–	ns
t_{FALL}	OUT Pin Fall Time	OUT Pin Load = 1nF	–	30	–	ns
–	Load Regulation	Load = 0 to 30mA	–	5	–	mV/mA
–	Line Regulation	$V_{IN} = 12\text{V}$ to 33V	–	0.3	–	mV/V
High Frequency Oscillator						
f_{OSC1}	Switch Frequency	$R_T = 100\text{k}\Omega$	–	500	–	kHz
–	Switch Frequency Range	–	0.1	–	1	MHz
D_{MAX}	Max. Duty Cycle	$R_T = 100\text{k}\Omega$	88	90	–	%
$t_{ON-TIME}$	Minimum On-time	–	–	200	–	ns
Enable Logic and Dimming Logic						
V_{EN_H}	EN High Voltage	–	2.4	–	–	V
V_{EN_L}	EN Low Voltage	–	–	–	0.5	V
V_{DIM_H}	PWM Logic for External Dimming	–	2.5	–	–	V
V_{DIM_L}		–	–	–	0.3	V
V_{ADIM}	ADIM Voltage Range for DC Dimming	–	0	–	1.5	V
R_{ADIM}	ADIM Output Resistance	–	70	100	130	$\text{k}\Omega$
Power Switch Drive						
V_{LIMIT}	Current Limit Threshold Voltage	–	–	540	–	mV
V_{LIMIT2}	D/L Short Threshold Voltage	–	720	800	880	mV
t_{LEB}	Current Sense LEB Time (Note 6)	–	80	100	150	ns
Compensation and Soft Start (COMP Pin)						
I_{O_H}	Sourcing Current	$V_{COMP} = 0.5\text{V}$	–	120	–	μA
I_{O_L}	Sinking Current	$V_{COMP} = 2\text{V}$	–	120	–	μA

Electrical Characteristics (Cont. @T_A = +25°C, V_{IN} = 12V, V_{EN} = 5V, unless otherwise specified.)

Symbol	Parameter	Conditions	Min	Typ	Max	Unit
Over Voltage Protection						
V _{OVP}	OVP Threshold Voltage	V _{OUT} Rising	1.9	2.0	2.1	V
V _{OVP_HYS}	OVP Hysteresis	–	–	200	–	mV
V _{OVP-SH}	Shutdown Under Abnormal Condition	–	3.0	3.2	3.4	V
Current Source						
I _{CH_MATCH}	LED Current Matching between Each String (Note 7)	I _{CH} = 100mA	–	1.5	2.7	%
I _{CH}	Regulation Current per Channel	R _{ISSET} = 12kΩ	97	100	103	mA
V _{LED_REG}	Minimum LED Regulation Voltage	I _{CH} = 120mA	–	500	–	mV
I _{LED_LEAK}	CH1 to CH4 Leakage Current	V _{EN} = 0V, V _{LED} = 37V	–	0.1	1	A
V _{LED-S}	LED Short Protection Threshold	–	6.6	7.3	8.0	V
Over Temperature Protection						
T _{OTSD}	Thermal Shutdown Temperature (Note 6)	–	+155	+160	+165	°C
T _{HYS}	Thermal Shutdown Temperature Hysteresis (Note 6)	–	–	+30	–	°C

Notes: 6. Guaranteed by Design.

$$7. I_{CH_MATCH} = \frac{I_{MAX} - I_{MIN}}{2 \times I_{AVG}} \times 100\%$$

Performance Characteristic (@ $T_A = +25^\circ\text{C}$, $V_{IN} = 24\text{V}$, $V_{EN} = V_{DIM} = 5\text{V}$, unless otherwise specified)

Frequency vs. RT Resistor

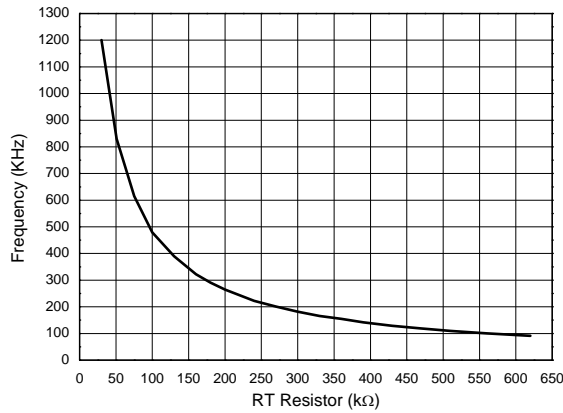

VCC Voltage vs. VIN pin Voltage

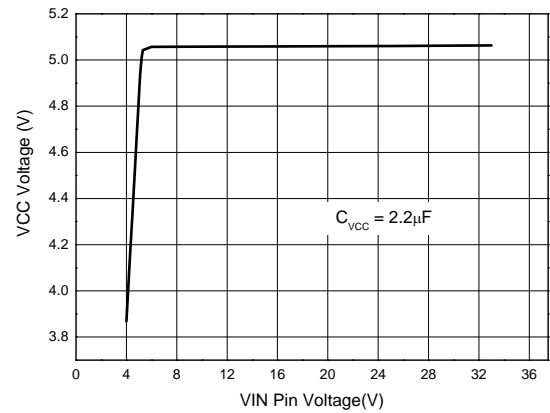

CHX Pin Regulation Voltage vs. Output Current / CH

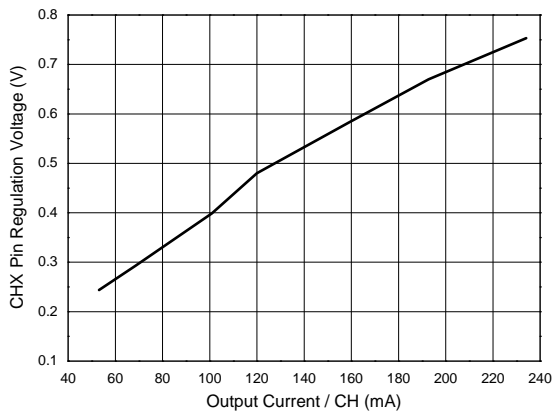

CHX Pin Regulation Voltage vs. Temperature

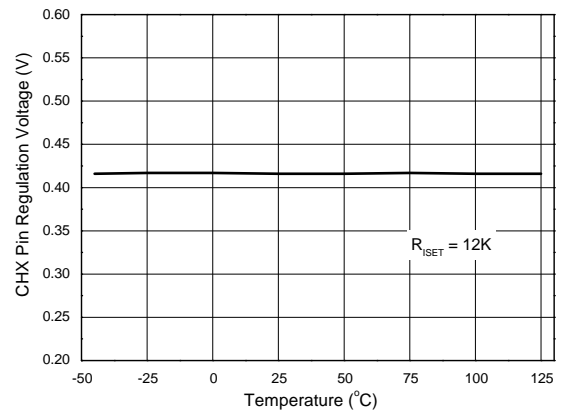

Channel Current vs. Channel

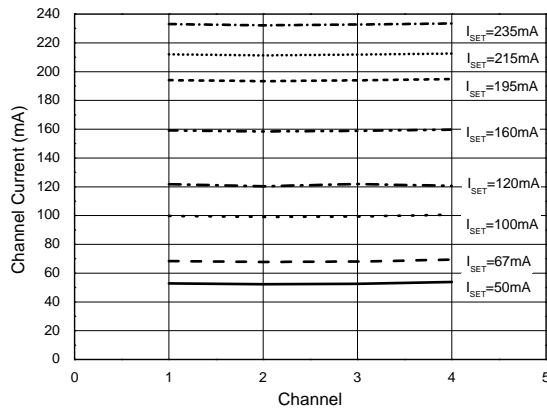

**Direct PWM Dimming @ $f_{PWM} = 100\text{Hz}$
Channel Current vs. Duty Cycle**

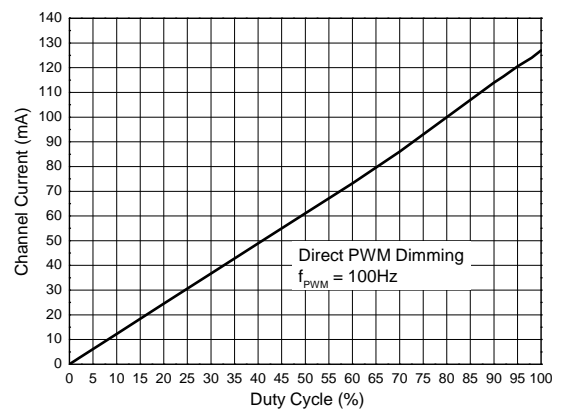

Performance Characteristic (Cont. @ $T_A = +25^\circ\text{C}$, $V_{IN} = 24\text{V}$, $V_{EN} = V_{DIM} = 5\text{V}$, unless otherwise specified.)

Direct PWM Dimming @ $f_{PWM} = 20\text{kHz}$
Channel Current vs. Duty Cycle

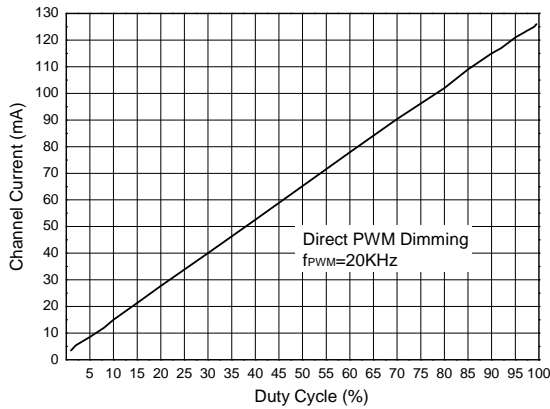

PWM to Analog Dimming @ $f_{PWM} = 20\text{kHz}$
Channel Current vs. Duty Cycle

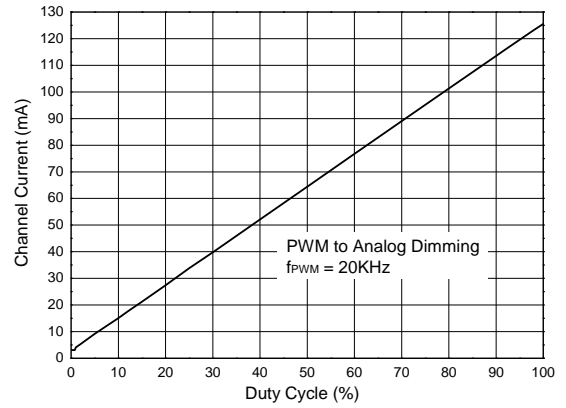

DC to Analog Dimming
Channel Current vs. ADIM pin Voltage

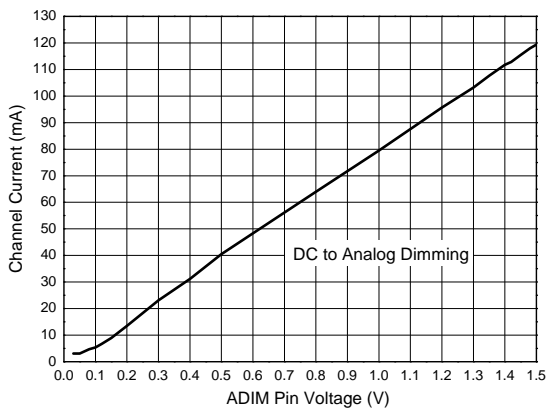

Steady State

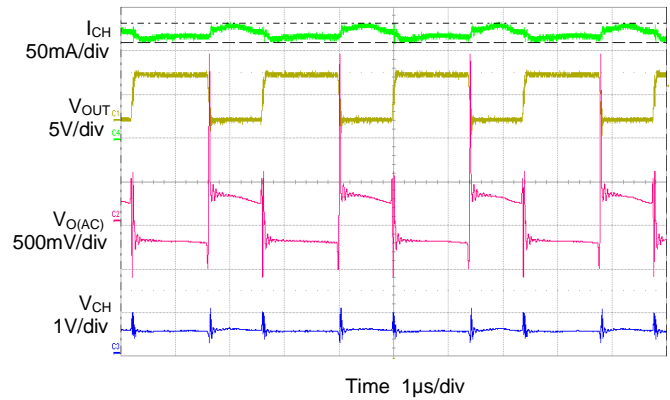

System Startup

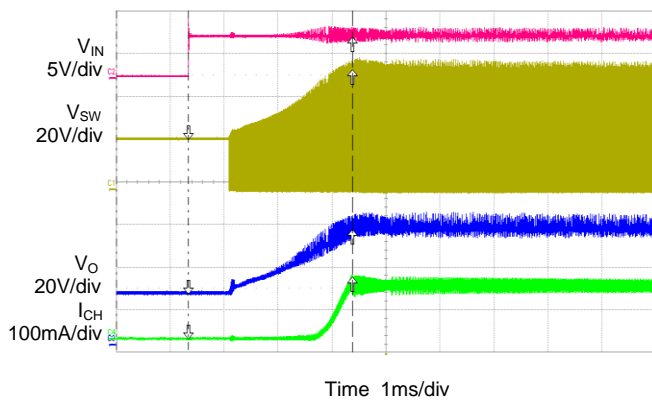

Direct PWM Dimming

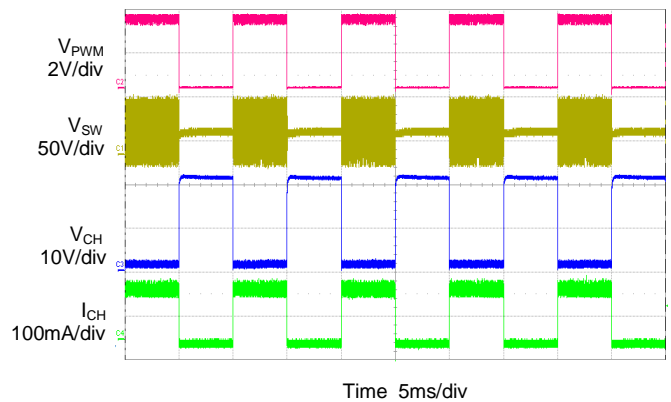

Performance Characteristic (Cont. @ $T_A = +25^\circ\text{C}$, $V_{IN} = 24\text{V}$, $V_{EN} = V_{DIM} = 5\text{V}$, unless otherwise specified.)

PWM to Analog Dimming

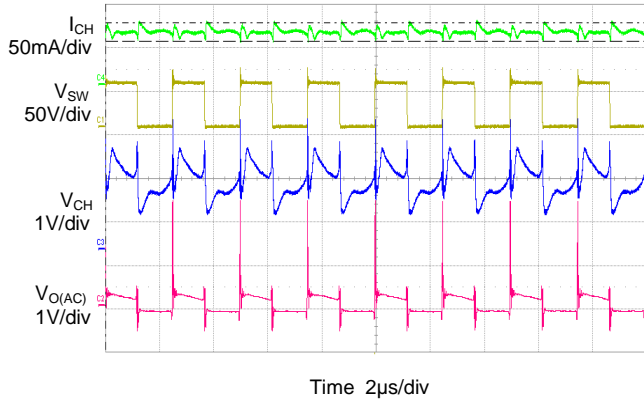

LED Short Protection

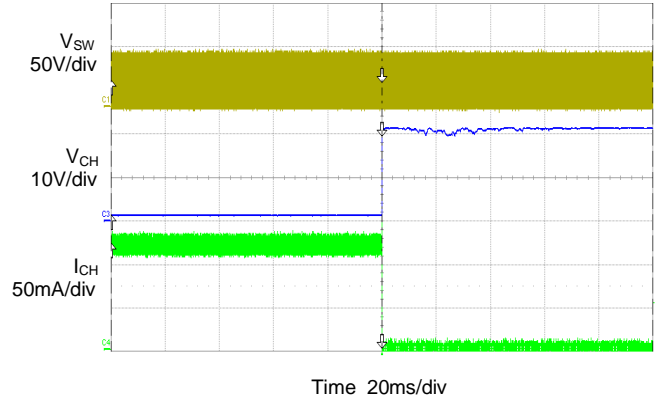

LED Open Protection

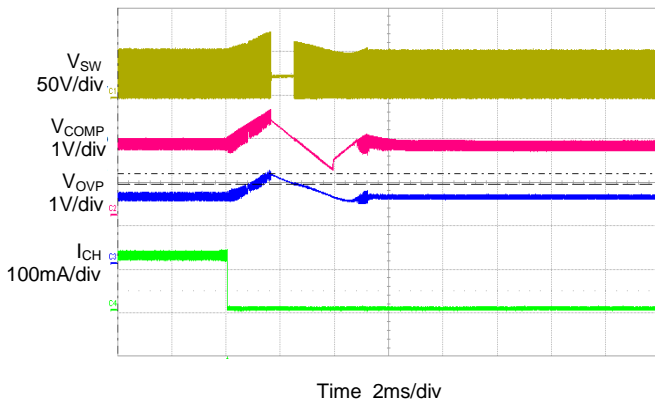

Schottky/Inductor Short Protection

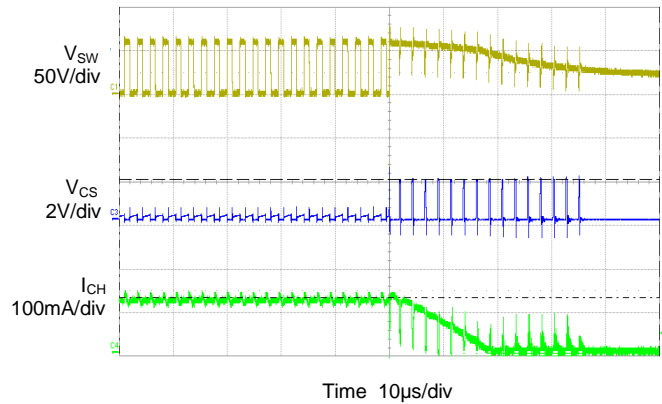

VOUT Short/Diode Open Protection

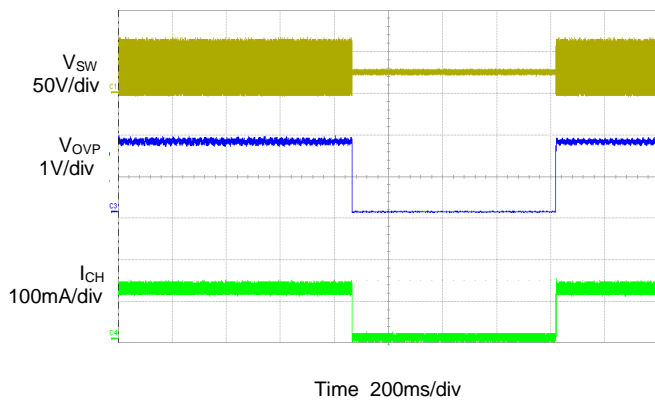

Over Temperature Protection

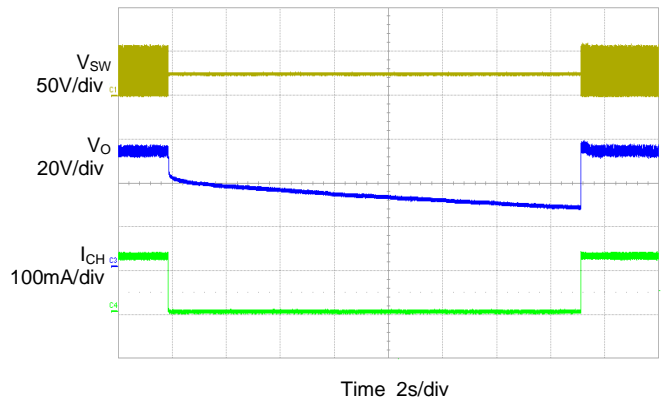

NEW PRODUCT

Application Information

Enable

The AL3065 is enabled when the voltage at EN pin is greater than approximately 2.4V, and disabled when lower than 0.5V.

Frequency Selection

An external resistor R_T , placed between RT pin and GND, can be used to set the operating frequency. The operating frequency ranges from 100KHz to 1MHz. The high frequency operation optimizes the regulator for the smallest-sized component application, while low frequency operation can help to reduce switch loss. The approximate operating frequency can be expressed as below:

$$f_{OSC}[MHz] = \frac{52}{R_T[K\Omega]}$$

LED Current Setting

The maximum LED current per channel can be adjusted up to 400mA via ISET pin. When $\geq 400mA$ current is needed in application, two or more channels can be paralleled to provide larger drive current. A resistor R_{ISET} is connected between ISET pin and GND to set the reference current I_{SET} . The LED current can be expressed as below:

$$I_{LED}[mA] = \frac{1200}{R_{ISET}[K\Omega]}$$

Dimming Control

1) Direct PWM Dimming Control

Compared to Analog dimming, PWM dimming offers superior dimming resolution and reduced LED color shift. Tying ADIM to VCC pin enables direct PWM dimming. The PWM signal is applied to the DIM pin. The LED current of all enabled channels can be adjusted at the same time and the LED brightness can be adjusted from $1\% \times I_{CH_MAX}$ to $100\% \times I_{CH_MAX}$.

During the “high level” period of PWM signal, the LED is turned on and 100% of the current flows through the LED, while during the “low level” period of the PWM signal, the LED is turned off and almost no current flows through the LED. Changing the average current through the LED can adjust the LED brightness.

The external PWM signal frequency applied to DIM pin can be 100Hz or higher and the minimum duty PWM duty can be 1/10,000 at 100Hz dimming frequency.

2) PWM to Analog Dimming Control

When a capacitor is connected between ADIM pin and GND, the IC provides analog dimming function from PWM signal input of DIM pin. The capacitor forms a filter with the output resistance of ADIM. The output of this filter contains an average DC component thereby modulating the amplitude of the LED current.

3) DC to Analog Dimming Control

When a DC signal is connected to ADIM pin, the IC provides analog dimming. The amplitude of the LED current can be modified by varying the ADIM pin voltage between 0V to 1.5V. Tie the DIM pin to logic high level.

Protection

1) Over Voltage Protection

The AL3065 integrates an OVP circuit. The OVP pin is connected to the center tap of voltage-divider (R_{OV1} and R_{OV2}) connected between high voltage output and GND.

If the voltage at OVP pin exceeds 2.0V, which may result from open loop or excessive output voltage, all the functions of the AL3065 will be disabled with output voltage falling. The OVP hysteresis is 200mV.

Application Information (Cont.)

2) Over-Current Protection

The AL3065 integrates an OCP circuit. The CS pin is connected to the voltage-sensor (RCS) placed between the source of the MOSFET and GND. If the voltage at CS pin exceeds 0.54V, the MOSFET is turned off immediately and will not turn on until the next cycle begins.

3) LED Short-Circuit Protection

The AL3065 integrates an LED Short-Circuit Protection circuit. If the voltage at any of the CH1 to CH4 pins exceeds a threshold of approximately 7.3V during normal operation, the corresponding channel is latched off. Toggle V_{IN} or EN to reset the latch. LED short detecting logic priority is lower than open LED and OVP logic. The LED short detecting is triggered when $0.1V < V_{LED_MIN}$ under dimming on mode, and disabled when LED open occurs until output voltage resumes to the regulated voltage.

4) LED Open-Circuit Protection

The AL3065 integrates an LED Open-Circuit Protection circuit. When any LED string is open, V_{OUT} will boost up until the voltage at OVP pin reaches an approximate threshold of 2.0V. The IC will automatically ignore the open string whose corresponding pin voltage is less than 100mV and the remaining string will continue operation. If all the strings are open and the voltage at OVP pin reaches a threshold of 2.0V, the MOSFET drive gate will turn off and the IC will shut down and latch.

5) V_{OUT} Short/Open Schottky Diode Protection

The AL3065 monitors the OVP pin, if the OVP pin voltage is less than 0.1V, MOSFET drive output will turn off. This protects the converter if the output Schottky diode is open or V_{OUT} is shorted to ground.

6) Under-Voltage Lockout

The AL3065 provides an under voltage lockout circuit to prevent it from undefined status when it starts up. The UVLO circuit shuts down the device when V_{CC} drops below 3.8V. The UVLO circuit has 200mV hysteresis, which means the device starts up again when V_{CC} rises to 4.0V.

7) Over-Temperature Protection

The AL3065 features Over-Temperature Protection. If the junction temperature exceeds approximately +160°C, the IC will shut down until the junction temperature is less than approximately +140°C. When the IC is released from over temperature shutdown, it will start a soft-start process.

8) Schottky Diode/Inductor Short-Circuit Protection

The AL3065 features Schottky Diode/Inductor Short-Circuit protection circuit. When CS pin voltage exceeds 0.8V for greater than 16 switching clocks, the IC will latch off. The voltage of CS pin is monitored after a short delay of t_{LEB} .

9) Shut Down under Abnormal Condition

The AL3065 features Shutdown under Abnormal Condition Protection circuit. When the OVP pin voltage exceeds 3.2V, the IC will latch off. Toggle EN pin to restart the IC. This feature can be used to shut down the IC under any defined abnormal condition.

Ordering Information

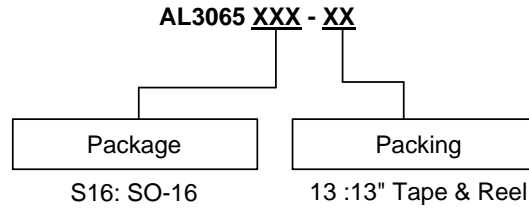

Part Number	Package Code	Package	13" Tape and Reel	
			Quantity	Part Number Suffix
AL3065S16-13	S16	SO-16	2500/Tape & Reel	-13

Marking Information

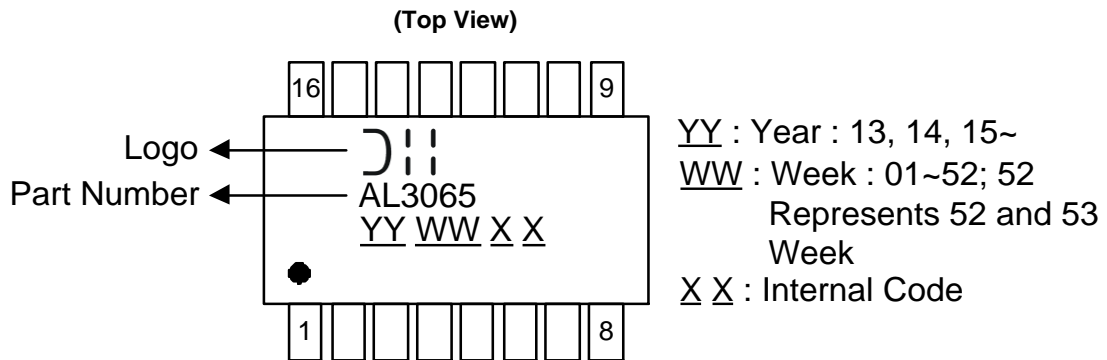

Package Outline Dimensions (All dimensions in mm(inch).)

(1) Package Type: SO-16

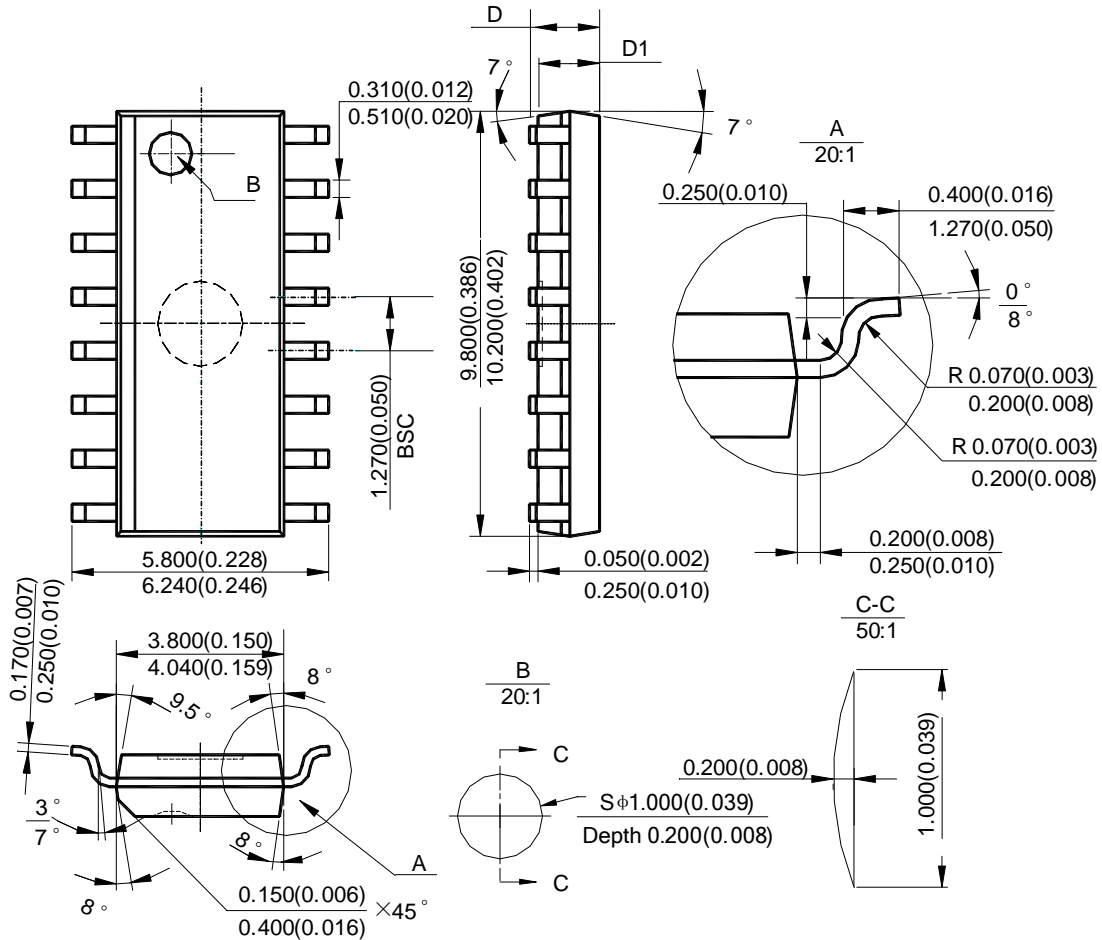

Note: Eject hole, oriented hole and mold mark is optional.

Symbol	D				D1			
	min(mm)	max(mm)	min(inch)	max(inch)	min(mm)	max(mm)	min(inch)	max(inch)
Option1	1.350	1.750	0.053	0.069	1.250	1.650	0.049	0.065
Option2	-	1.260	-	0.050	1.020	-	0.040	-

Suggested Pad Layout

(1) Package Type: SO-16

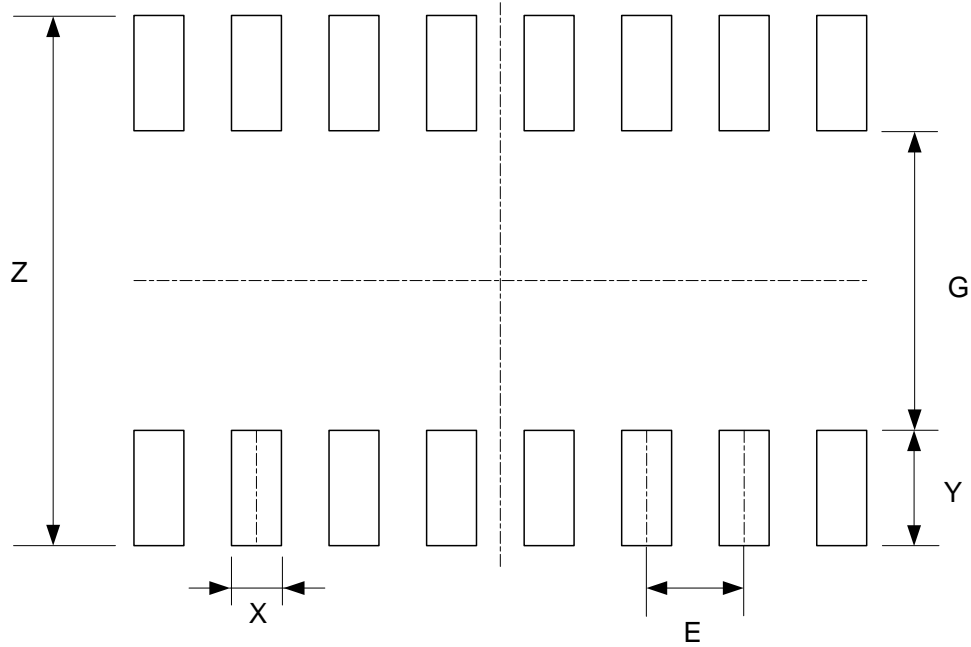

Dimensions	Z (mm)/(inch)	G (mm)/(inch)	X (mm)/(inch)	Y (mm)/(inch)	E (mm)/(inch)
Value	6.900/0.272	3.900/0.154	0.650/0.026	1.500/0.059	1.270/0.050

NEW PRODUCT

IMPORTANT NOTICE

DIODES INCORPORATED MAKES NO WARRANTY OF ANY KIND, EXPRESS OR IMPLIED, WITH REGARDS TO THIS DOCUMENT, INCLUDING, BUT NOT LIMITED TO, THE IMPLIED WARRANTIES OF MERCHANTABILITY AND FITNESS FOR A PARTICULAR PURPOSE (AND THEIR EQUIVALENTS UNDER THE LAWS OF ANY JURISDICTION).

Diodes Incorporated and its subsidiaries reserve the right to make modifications, enhancements, improvements, corrections or other changes without further notice to this document and any product described herein. Diodes Incorporated does not assume any liability arising out of the application or use of this document or any product described herein; neither does Diodes Incorporated convey any license under its patent or trademark rights, nor the rights of others. Any Customer or user of this document or products described herein in such applications shall assume all risks of such use and will agree to hold Diodes Incorporated and all the companies whose products are represented on Diodes Incorporated website, harmless against all damages.

Diodes Incorporated does not warrant or accept any liability whatsoever in respect of any products purchased through unauthorized sales channel. Should Customers purchase or use Diodes Incorporated products for any unintended or unauthorized application, Customers shall indemnify and hold Diodes Incorporated and its representatives harmless against all claims, damages, expenses, and attorney fees arising out of, directly or indirectly, any claim of personal injury or death associated with such unintended or unauthorized application.

Products described herein may be covered by one or more United States, international or foreign patents pending. Product names and markings noted herein may also be covered by one or more United States, international or foreign trademarks.

This document is written in English but may be translated into multiple languages for reference. Only the English version of this document is the final and determinative format released by Diodes Incorporated.

LIFE SUPPORT

Diodes Incorporated products are specifically not authorized for use as critical components in life support devices or systems without the express written approval of the Chief Executive Officer of Diodes Incorporated. As used herein:

A. Life support devices or systems are devices or systems which:

1. are intended to implant into the body, or
2. support or sustain life and whose failure to perform when properly used in accordance with instructions for use provided in the labeling can be reasonably expected to result in significant injury to the user.

B. A critical component is any component in a life support device or system whose failure to perform can be reasonably expected to cause the failure of the life support device or to affect its safety or effectiveness.

Customers represent that they have all necessary expertise in the safety and regulatory ramifications of their life support devices or systems, and acknowledge and agree that they are solely responsible for all legal, regulatory and safety-related requirements concerning their products and any use of Diodes Incorporated products in such safety-critical, life support devices or systems, notwithstanding any devices- or systems-related information or support that may be provided by Diodes Incorporated. Further, Customers must fully indemnify Diodes Incorporated and its representatives against any damages arising out of the use of Diodes Incorporated products in such safety-critical, life support devices or systems.

Copyright © 2015, Diodes Incorporated

www.diodes.com

Компания «Океан Электроники» предлагает заключение долгосрочных отношений при поставках импортных электронных компонентов на взаимовыгодных условиях!

Наши преимущества:

- Поставка оригинальных импортных электронных компонентов напрямую с производств Америки, Европы и Азии, а так же с крупнейших складов мира;
- Широкая линейка поставок активных и пассивных импортных электронных компонентов (более 30 млн. наименований);
- Поставка сложных, дефицитных, либо снятых с производства позиций;
- Оперативные сроки поставки под заказ (от 5 рабочих дней);
- Экспресс доставка в любую точку России;
- Помощь Конструкторского Отдела и консультации квалифицированных инженеров;
- Техническая поддержка проекта, помощь в подборе аналогов, поставка прототипов;
- Поставка электронных компонентов под контролем ВП;
- Система менеджмента качества сертифицирована по Международному стандарту ISO 9001;
- При необходимости вся продукция военного и аэрокосмического назначения проходит испытания и сертификацию в лаборатории (по согласованию с заказчиком);
- Поставка специализированных компонентов военного и аэрокосмического уровня качества (Xilinx, Altera, Analog Devices, Intersil, Interpoint, Microsemi, Actel, Aeroflex, Peregrine, VPT, Syfer, Eurofarad, Texas Instruments, MS Kennedy, Miteq, Cobham, E2V, MA-COM, Hittite, Mini-Circuits, General Dynamics и др.);

Компания «Океан Электроники» является официальным дистрибьютором и эксклюзивным представителем в России одного из крупнейших производителей разъемов военного и аэрокосмического назначения «JONHON», а так же официальным дистрибьютором и эксклюзивным представителем в России производителя высокотехнологичных и надежных решений для передачи СВЧ сигналов «FORSTAR».



JONHON

«JONHON» (основан в 1970 г.)

Разъемы специального, военного и аэрокосмического назначения:

(Применяются в военной, авиационной, аэрокосмической, морской, железнодорожной, горно- и нефтедобывающей отраслях промышленности)

«FORSTAR» (основан в 1998 г.)

ВЧ соединители, коаксиальные кабели, кабельные сборки и микроволновые компоненты:

(Применяются в телекоммуникациях гражданского и специального назначения, в средствах связи, РЛС, а так же военной, авиационной и аэрокосмической отраслях промышленности).



Телефон: 8 (812) 309-75-97 (многоканальный)

Факс: 8 (812) 320-03-32

Электронная почта: ocean@oceanchips.ru

Web: <http://oceanchips.ru/>

Адрес: 198099, г. Санкт-Петербург, ул. Калинина, д. 2, корп. 4, лит. А