

## HIP4080A

80V/2.5A Peak, High Frequency Full Bridge FET Driver

FN3658  
Rev.8.00  
Dec 11, 2019

The HIP4080A is a high frequency, medium voltage Full Bridge N-Channel FET driver IC, available in 20 lead plastic SOIC and DIP packages. The HIP4080A includes an input comparator, used to facilitate the “hysteresis” and PWM modes of operation. Its HEN (high enable) lead can force current to freewheel in the bottom two external power MOSFETs, maintaining the upper power MOSFETs off. Since it can switch at frequencies up to 1MHz, the HIP4080A is well suited for driving Voice Coil Motors, switching power amplifiers and power supplies.

HIP4080A can also drive medium voltage brush motors, and two HIP4080As can be used to drive high performance stepper motors, since the short minimum “on-time” can provide fine micro-stepping capability.

Short propagation delays of approximately 55ns maximize control loop crossover frequencies and dead-times which can be adjusted to near zero to minimize distortion, resulting in precise control of the driven load.

The similar HIP4081A IC allows independent control of all 4 FETs in a Full Bridge configuration.

The Application Note for the HIP4080A is AN9404.

### Ordering Information

PART NUMBER	TEMPERATURE RANGE (°C)	PACKAGE (RoHS Compliant)	PKG. DWG. #
HIP4080AIPZ (Note 1)	-40 to +85	20 Ld PDIP	E20.3
HIP4080AIBZ (Note 1)	-40 to +85	20 Ld SOIC	M20.3

#### NOTES:

- Intersil Pb-Free products employ special Pb-free material sets; molding compounds/die attach materials and 100% matte tin plate termination finish, which is compatible with both SnPb and Pb-free soldering operations. Intersil Pb-Free products are MSL classified at Pb-free peak reflow temperatures that meet or exceed the Pb-free requirements of IPC/JEDEC J Std-020B.
- Add “T” suffix for Tape and Reel packing option. HIP4080AIP not available in Tape and Reel.

### Features

- Drives N-Channel FET Full Bridge Including High Side Chop Capability
- Bootstrap Supply Max Voltage to 95VDC
- Drives 1000pF Load at 1MHz in Free Air at +50°C with Rise and Fall Times of Typically 10ns
- User-Programmable Dead Time
- Charge-Pump and Bootstrap Maintain Upper Bias Supplies
- DIS (Disable) Pin Pulls Gates Low
- Input Logic Thresholds Compatible with 5V to 15V Logic Levels
- Very Low Power Consumption
- Undervoltage Protection
- Pb-Free (RoHS Compliant)

### Applications

- Medium/Large Voice Coil Motors
- Full Bridge Power Supplies
- Switching Power Amplifiers
- High Performance Motor Controls
- Noise Cancellation Systems
- Battery Powered Vehicles
- Peripherals
- U.P.S.

### Pinout

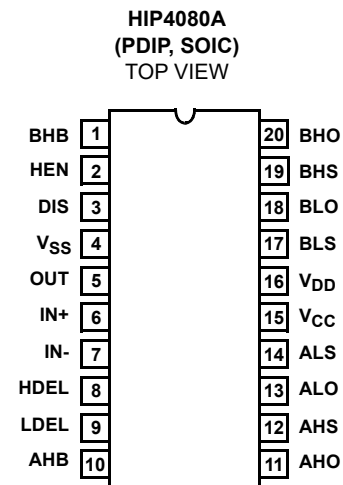

**Application Block Diagram**

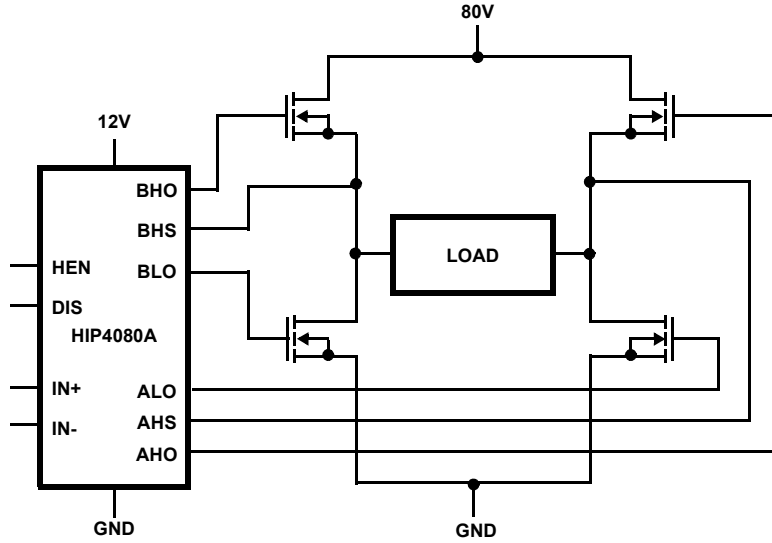

**Functional Block Diagram (1/2 HIP4080A)**

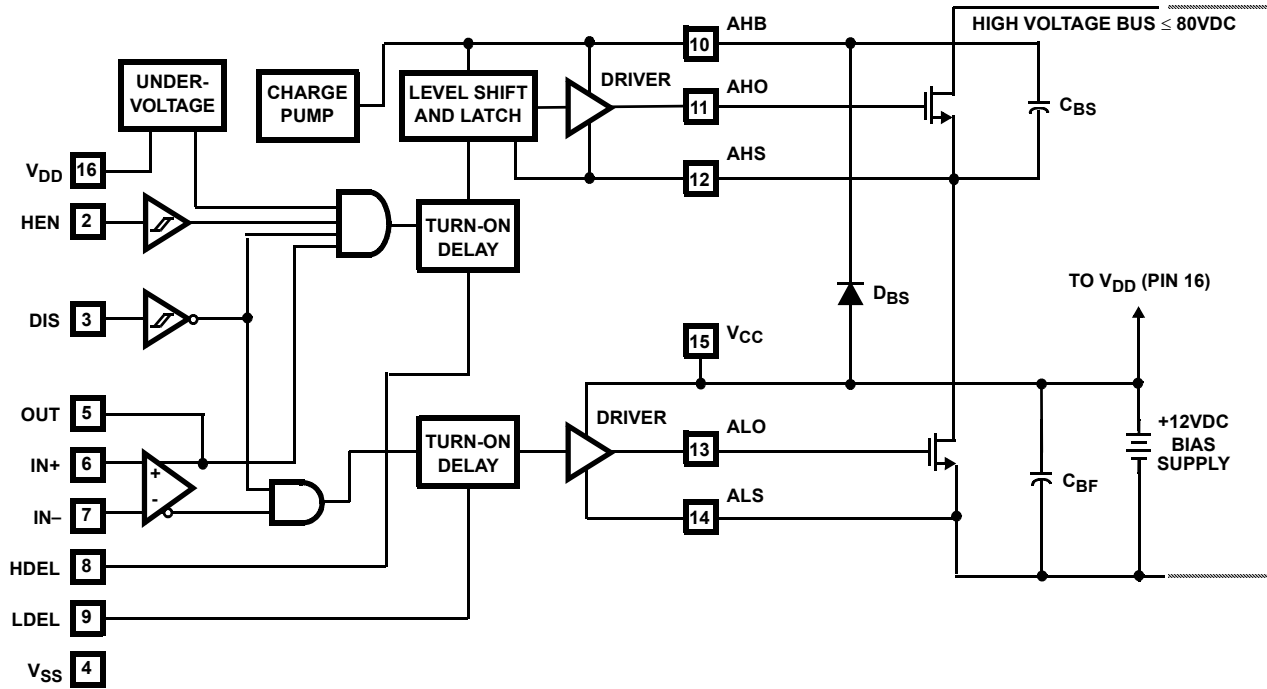



**Absolute Maximum Ratings**

Supply Voltage,  $V_{DD}$  and  $V_{CC}$  ..... -0.3V to 16V  
 Logic I/O Voltages ..... -0.3V to  $V_{DD}$  +0.3V  
 Voltage on AHS, BHS ... -6.0V (Transient) to 80V (25°C to 125°C)  
 Voltage on AHS, BHS ... -6.0V (Transient) to 70V (-55°C to 125°C)  
 Voltage on ALS, BLS ..... -2.0V (Transient) to +2.0V (Transient)  
 Voltage on AHB, BHB .....  $V_{AHS}$ , BHS -0.3V to  $V_{AHS}$ , BHS + $V_{DD}$   
 Voltage on ALO, BLO .....  $V_{ALS}$ , BLS -0.3V to  $V_{CC}$  +0.3V  
 Voltage on AHO, BHO .....  $V_{AHS}$ , BHS -0.3V to  $V_{AHB}$ , BHB +0.3V  
 Input Current, HDEL and LDEL ..... -5mA to 0mA  
 Phase Slew Rate ..... 20V/ns  
 All Voltages relative to  $V_{SS}$ , unless otherwise specified.

**Thermal Information**

Thermal Resistance (Typical, Note 3)  $\theta_{JA}$  (°C/W)  
 SOIC Package ..... 85  
 PDIP Package ..... 75  
 Maximum Power Dissipation at +85°C  
 SOIC Package ..... 470mW  
 PDIP Package ..... 530mW  
 Storage Temperature Range ..... -65°C to +150°C  
 Operating Max. Junction Temperature ..... +125°C  
 Lead Temperature (Soldering 10s) ..... +300°C  
 (For SOIC - Lead Tips Only)

**Operating Conditions**

Supply Voltage,  $V_{DD}$  and  $V_{CC}$  ..... +9.5V to +15V  
 Voltage on ALS, BLS ..... -1.0V to +1.0V  
 Voltage on AHB, BHB .....  $V_{AHS}$ , BHS +5V to  $V_{AHS}$ , BHS +15V  
 Input Current, HDEL and LDEL ..... -500µA to -50µA  
 Operating Ambient Temperature Range ..... -40°C to +85°C

*CAUTION: Stresses above those listed in "Absolute Maximum Ratings" may cause permanent damage to the device. This is a stress only rating and operation of the device at these or any other conditions above those indicated in the operational sections of this specification is not implied.*

NOTE:

3.  $\theta_{JA}$  is measured with the component mounted on a low effective thermal conductivity test board in free air. See Tech Brief TB379 for details.

**Electrical Specifications**  $V_{DD} = V_{CC} = V_{AHB} = V_{BHB} = 12V$ ,  $V_{SS} = V_{ALS} = V_{BLS} = V_{AHS} = V_{BHS} = 0V$ ,  $R_{HDEL} = R_{LDEL} = 100K$ , and  $T_A = +25^\circ C$ , Unless Otherwise Specified

PARAMETERS	SYMBOL	TEST CONDITIONS	$T_J = +25^\circ C$			$T_J = -40^\circ C$ TO $+125^\circ C$		UNITS
			MIN	TYP	MAX	MIN	MAX	
<b>SUPPLY CURRENTS AND CHARGE PUMPS</b>								
$V_{DD}$ Quiescent Current	$I_{DD}$	IN- = 2.5V, Other Inputs = 0V	8	11	14	7	14	mA
$V_{DD}$ Operating Current	$I_{DDO}$	Outputs switching f = 500kHz, No Load	9	12	15	8	15	mA
$V_{CC}$ Quiescent Current	$I_{CC}$	IN- = 2.5V, Other Inputs = 0V, $I_{ALO} = I_{BLO} = 0$	-	25	80	-	100	µA
$V_{CC}$ Operating Current	$I_{CCO}$	f = 500kHz, No Load	1	1.25	2.0	0.8	3	mA
AHB, BHB Quiescent Current - Qpump Output Current	$I_{AHB}$ , $I_{BHB}$	IN- = 2.5V, Other Inputs = 0V, $I_{AHO} = I_{BHO} = 0$ , $V_{DD} = V_{CC} = V_{AHB} = V_{BHB} = 10V$	-50	-25	-11	-60	-10	µA
AHB, BHB Operating Current	$I_{AHBO}$ , $I_{BHBO}$	f = 500kHz, No Load	0.62	1.2	1.5	0.5	1.9	mA
AHS, BHS, AHB, BHB Leakage Current	$I_{HLK}$	$V_{BHS} = V_{AHS} = 80V$ , $V_{AHB} = V_{BHB} = 93V$	-	0.02	1.0	-	10	µA
AHB-AHS, BHB-BHS Qpump Output Voltage	$V_{AHB} - V_{AHS}$ $V_{BHB} - V_{BHS}$	$I_{AHB} = I_{AHS} = 0$ , No Load	11.5	12.6	14.0	10.5	14.5	V
<b>INPUT COMPARATOR PINS: IN+, IN-, OUT</b>								
Offset Voltage	$V_{OS}$	Over Common Mode Voltage Range	-10	0	+10	-15	+15	mV
Input Bias Current	$I_{IB}$		0	0.5	2	0	4	µA
Input Offset Current	$I_{OS}$		-1	0	+1	-2	+2	µA
Input Common Mode Voltage Range	CMVR		1	-	$V_{DD} - 1.5$	1	$V_{DD} - 1.5$	V

**Electrical Specifications**  $V_{DD} = V_{CC} = V_{AHB} = V_{BHB} = 12V$ ,  $V_{SS} = V_{ALS} = V_{BLS} = V_{AHS} = V_{BHS} = 0V$ ,  $R_{HDEL} = R_{LDEL} = 100K$ , and  $T_A = +25^\circ C$ , Unless Otherwise Specified **(Continued)**

PARAMETERS	SYMBOL	TEST CONDITIONS	$T_J = +25^\circ C$			$T_J = -40^\circ C$ TO $+125^\circ C$		UNITS
			MIN	TYP	MAX	MIN	MAX	
Voltage Gain	AVOL		10	25	-	10	-	V/mV
OUT High Level Output Voltage	$V_{OH}$	$IN+ > IN-$ , $I_{OH} = -250\mu A$	$V_{DD} - 0.4$	-	-	$V_{DD} - 0.5$	-	V
OUT Low Level Output Voltage	$V_{OL}$	$IN+ < IN-$ , $I_{OL} = +250\mu A$	-	-	0.4	-	0.5	V
Low Level Output Current	$I_{OL}$	$V_{OUT} = 6V$	6.5	14	19	6	20	mA
High Level Output Current	$I_{OH}$	$V_{OUT} = 6V$	-17	-10	-3	-20	-2.5	mA
<b>INPUT PINS: DIS</b>								
Low Level Input Voltage	$V_{IL}$	Full Operating Conditions	-	-	1.0	-	0.8	V
High Level Input Voltage	$V_{IH}$	Full Operating Conditions	2.5	-	-	2.7	-	V
Input Voltage Hysteresis			-	35	-	-	-	mV
Low Level Input Current	$I_{IL}$	$V_{IN} = 0V$ , Full Operating Conditions	-130	-100	-75	-135	-65	$\mu A$
High Level Input Current	$I_{IH}$	$V_{IN} = 5V$ , Full Operating Conditions	-1	-	+1	-10	+10	$\mu A$
<b>INPUT PINS: HEN</b>								
Low Level Input Voltage	$V_{IL}$	Full Operating Conditions	-	-	1.0	-	0.8	V
High Level Input Voltage	$V_{IH}$	Full Operating Conditions	2.5	-	-	2.7	-	V
Input Voltage Hysteresis			-	35	-	-	-	mV
Low Level Input Current	$I_{IL}$	$V_{IN} = 0V$ , Full Operating Conditions	-260	-200	-150	-270	-130	$\mu A$
High Level Input Current	$I_{IH}$	$V_{IN} = 5V$ , Full Operating Conditions	-1	-	+1	-10	+10	$\mu A$
<b>TURN-ON DELAY PINS: LDEL AND HDEL</b>								
LDEL, HDEL Voltage	$V_{HDEL}, V$	$I_{HDEL} = I_{LDEL} = -100\mu A$	4.9	5.1	5.3	4.8	5.4	V
<b>GATE DRIVER OUTPUT PINS: ALO, BLO, AHO, AND BHO</b>								
Low Level Output Voltage	$V_{OL}$	$I_{OUT} = 100mA$	0.7	0.85	1.0	0.5	1.1	V
High Level Output Voltage	$V_{CC} - V_{OH}$	$I_{OUT} = -100mA$	0.8	0.95	1.1	0.5	1.2	V
Peak Pullup Current	$I_{O+}$	$V_{OUT} = 0V$	1.7	2.6	3.8	1.4	4.1	A
Peak Pulldown Current	$I_{O-}$	$V_{OUT} = 12V$	1.7	2.4	3.3	1.3	3.6	A
Under Voltage, Rising Threshold	UV+		8.1	8.8	9.4	8.0	9.5	V
Under Voltage, Falling Threshold	UV-		7.6	8.3	8.9	7.5	9.0	V
Under Voltage, Hysteresis	HYS		0.25	0.4	0.65	0.2	0.7	V

**Switching Specifications**  $V_{DD} = V_{CC} = V_{AHB} = V_{BHB} = 12V$ ,  $V_{SS} = V_{ALS} = V_{BLS} = V_{AHS} = V_{BHS} = 0V$ ,  $R_{HDEL} = R_{LDEL} = 10K$ ,  $C_L = 1000pF$ , and  $T_A = +25^{\circ}C$ , Unless Otherwise Specified

PARAMETERS	SYMBOL	TEST CONDITIONS	$T_J = +25^{\circ}C$			$T_J = -40^{\circ}C$ TO $+125^{\circ}C$		UNITS
			MIN	TYP	MAX	MIN	MAX	
Lower Turn-off Propagation Delay (IN+/IN- to ALO/BLO)	$T_{LPHL}$		-	40	70	-	90	ns
Upper Turn-off Propagation Delay (IN+/IN- to AHO/BHO)	$T_{HPHL}$		-	50	80	-	110	ns
Lower Turn-on Propagation Delay (IN+/IN- to ALO/BLO)	$T_{LPLH}$		-	40	70	-	90	ns
Upper Turn-on Propagation Delay (IN+/IN- to AHO/BHO)	$T_{HPLH}$		-	70	110	-	140	ns
Rise Time	$T_R$		-	10	25	-	35	ns
Fall Time	$T_F$		-	10	25	-	35	ns
Turn-on Input Pulse Width	$T_{PWIN-ON}$		50	-	-	50	-	ns
Turn-off Input Pulse Width	$T_{PWIN-OFF}$		40	-	-	40	-	ns
Disable Turn-off Propagation Delay (DIS - Lower Outputs)	$T_{DISLOW}$		-	45	75	-	95	ns
Disable Turn-off Propagation Delay (DIS - Upper Outputs)	$T_{DISHIGH}$		-	55	85	-	105	ns
Disable to Lower Turn-on Propagation Delay (DIS - ALO and BLO)	$T_{DLPLH}$		-	45	70	-	90	ns
Refresh Pulse Width (ALO and BLO)	$T_{REF-PW}$		240	380	500	200	600	ns
Disable to Upper Enable (DIS - AHO and BHO)	$T_{UEN}$		-	480	630	-	750	ns
HEN-AHO, BHO Turn-off, Propagation Delay	$T_{HEN-PHL}$	$R_{HDEL} = R_{LDEL} = 10K$	-	40	70	-	90	ns
HEN-AHO, BHO Turn-on, Propagation Delay	$T_{HEN-PLH}$	$R_{HDEL} = R_{LDEL} = 10K$	-	60	90	-	110	ns

TRUTH TABLE

INPUT				OUTPUT			
IN+ > IN-	HEN	U/V	DIS	ALO	AHO	BLO	BHO
X	X	X	1	0	0	0	0
0	0	0	0	1	0	0	0
1	1	0	0	0	1	1	0
0	1	0	0	1	0	0	1
1	0	0	0	0	0	1	0
X	X	1	X	0	0	0	0

## Pin Descriptions

PIN NUMBER	SYMBOL	DESCRIPTION
1	BHB	B High-side Bootstrap supply. External bootstrap diode and capacitor are required. Connect cathode of bootstrap diode and positive side of bootstrap capacitor to this pin. Internal charge pump supplies 30 $\mu$ A out of this pin to maintain bootstrap supply. Internal circuitry clamps the bootstrap supply to approximately 12.8V.
2	HEN	High-side Enable input. Logic level input that when low overrides IN+/IN- (Pins 6 and 7) to put AHO and BHO drivers (Pins 11 and 20) in low output state. When HEN is high AHO and BHO are controlled by IN+/IN- inputs. The pin can be driven by signal levels of 0V to 15V (no greater than V <sub>DD</sub> ).
3	DIS	DISable input. Logic level input that when taken high sets all four outputs low. DIS high overrides all other inputs. When DIS is taken low the outputs are controlled by the other inputs. The pin can be driven by signal levels of 0V to 15V (no greater than V <sub>DD</sub> ).
4	V <sub>SS</sub>	Chip negative supply, generally will be ground.
5	OUT	OUTput of the input control comparator. This output can be used for feedback and hysteresis.
6	IN+	Noninverting input of control comparator. If IN+ is greater than IN- (Pin 7) then ALO and BHO are low level outputs and BLO and AHO are high level outputs. If IN+ is less than IN- then ALO and BHO are high level outputs and BLO and AHO are low level outputs. DIS (Pin 3) high level will override IN+/IN- control for all outputs. HEN (Pin 2) low level will override IN+/IN- control of AHO and BHO. When switching in four quadrant mode, dead time in a half bridge leg is controlled by HDEL and LDEL (Pins 8 and 9).
7	IN-	Inverting input of control comparator. See IN+ (Pin 6) description.
8	HDEL	High-side turn-on DELay. Connect resistor from this pin to V <sub>SS</sub> to set timing current that defines the turn-on delay of both high-side drivers. The low-side drivers turn-off with no adjustable delay, so the HDEL resistor guarantees no shoot-through by delaying the turn-on of the high-side drivers. HDEL reference voltage is approximately 5.1V.
9	LDEL	Low-side turn-on DELay. Connect resistor from this pin to V <sub>SS</sub> to set timing current that defines the turn-on delay of both low-side drivers. The high-side drivers turn-off with no adjustable delay, so the LDEL resistor guarantees no shoot-through by delaying the turn-on of the low-side drivers. LDEL reference voltage is approximately 5.1V.
10	AHB	A High-side Bootstrap supply. External bootstrap diode and capacitor are required. Connect cathode of bootstrap diode and positive side of bootstrap capacitor to this pin. Internal charge pump supplies 30 $\mu$ A out of this pin to maintain bootstrap supply. Internal circuitry clamps the bootstrap supply to approximately 12.8V.
11	AHO	A High-side Output. Connect to gate of A High-side power MOSFET.
12	AHS	A High-side Source connection. Connect to source of A High-side power MOSFET. Connect negative side of bootstrap capacitor to this pin.
13	ALO	A Low-side Output. Connect to gate of A Low-side power MOSFET.
14	ALS	A Low-side Source connection. Connect to source of A Low-side power MOSFET.
15	V <sub>CC</sub>	Positive supply to gate drivers. Must be same potential as V <sub>DD</sub> (Pin 16). Connect to anodes of two bootstrap diodes.
16	V <sub>DD</sub>	Positive supply to lower gate drivers. Must be same potential as V <sub>CC</sub> (Pin 15). De-couple this pin to V <sub>SS</sub> (Pin 4).
17	BLS	B Low-side Source connection. Connect to source of B Low-side power MOSFET.
18	BLO	B Low-side Output. Connect to gate of B Low-side power MOSFET.
19	BHS	B High-side Source connection. Connect to source of B High-side power MOSFET. Connect negative side of bootstrap capacitor to this pin.
20	BHO	B High-side Output. Connect to gate of B High-side power MOSFET.

Timing Diagrams

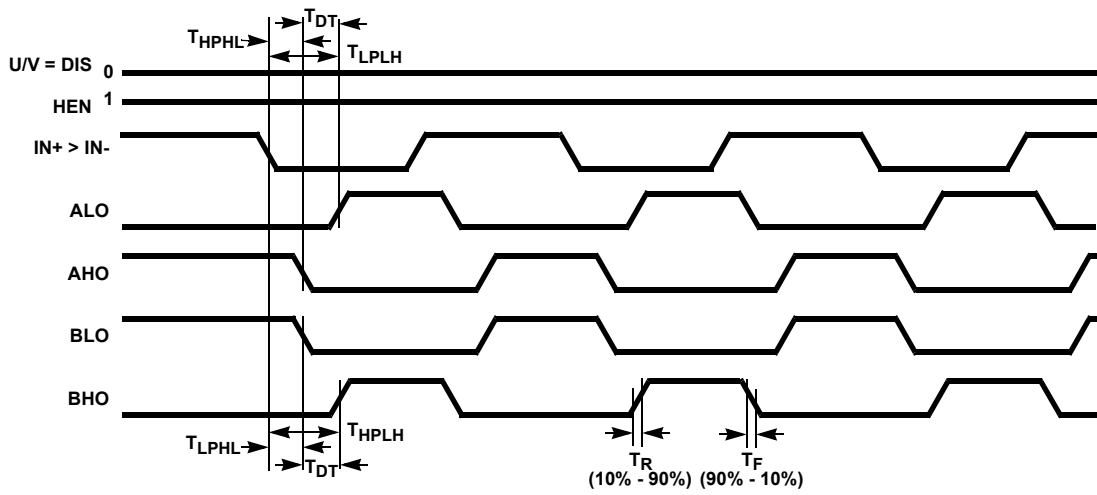

FIGURE 1. BISTATE MODE

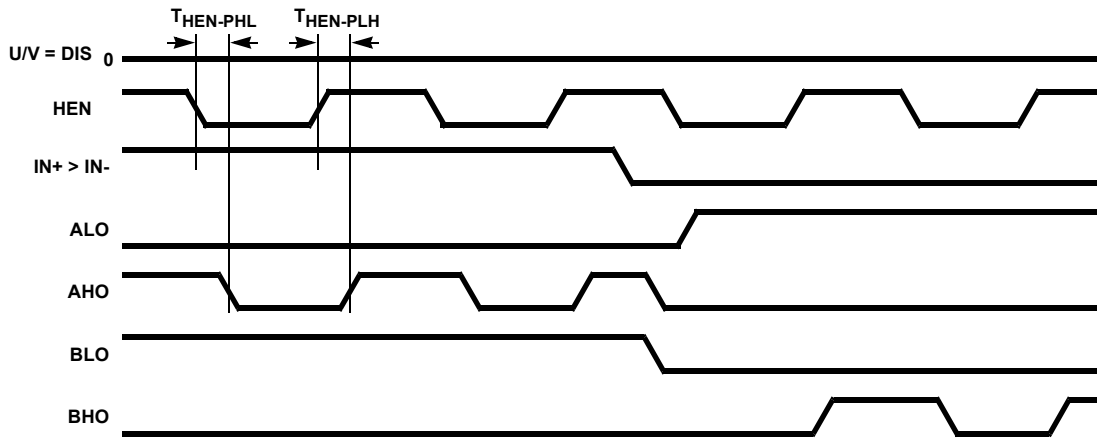

FIGURE 2. HIGH SIDE CHOP MODE

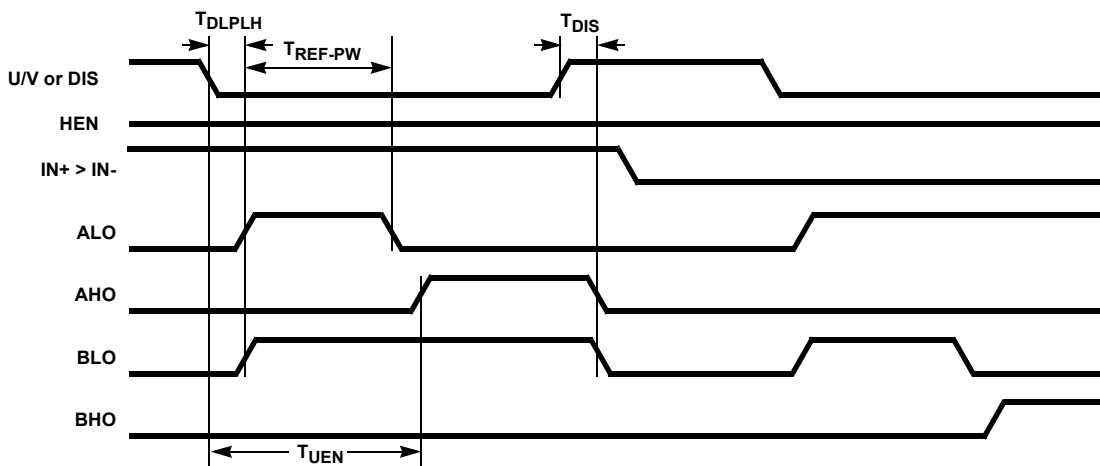

FIGURE 3. DISABLE FUNCTION



**Typical Performance Curves**  $V_{DD} = V_{CC} = V_{AHB} = V_{BHB} = 12V$ ,  $V_{SS} = V_{ALS} = V_{BLS} = V_{AHS} = V_{BHS} = 0V$ ,  $R_{HDEL} = R_{LDEL} = 100K$ , and  $T_A = +25^\circ C$ , Unless Otherwise Specified

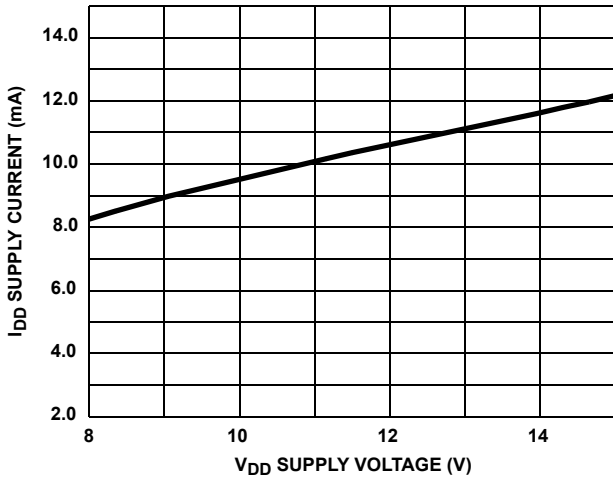

FIGURE 4. QUIESCENT I<sub>DD</sub> SUPPLY CURRENT vs V<sub>DD</sub> SUPPLY VOLTAGE

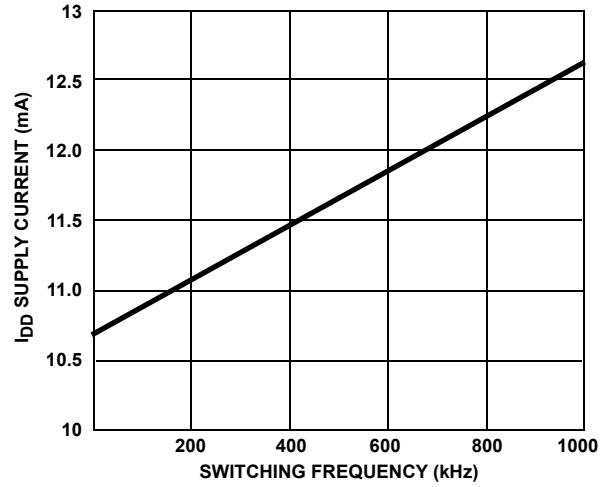

FIGURE 5. I<sub>DD0</sub> NO-LOAD I<sub>DD</sub> SUPPLY CURRENT vs FREQUENCY (kHz)

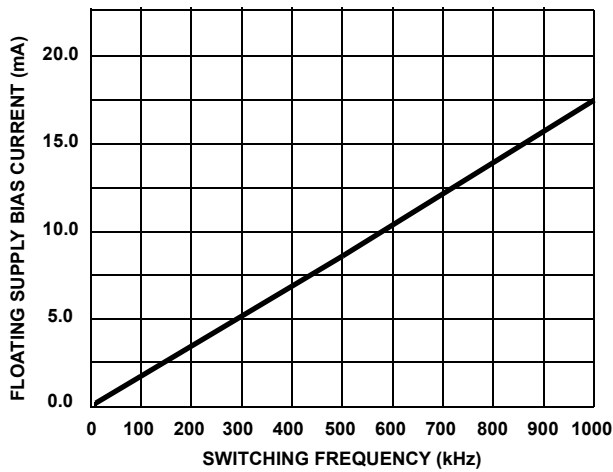

FIGURE 6. SIDE A, B FLOATING SUPPLY BIAS CURRENT vs FREQUENCY (LOAD = 1000pF)

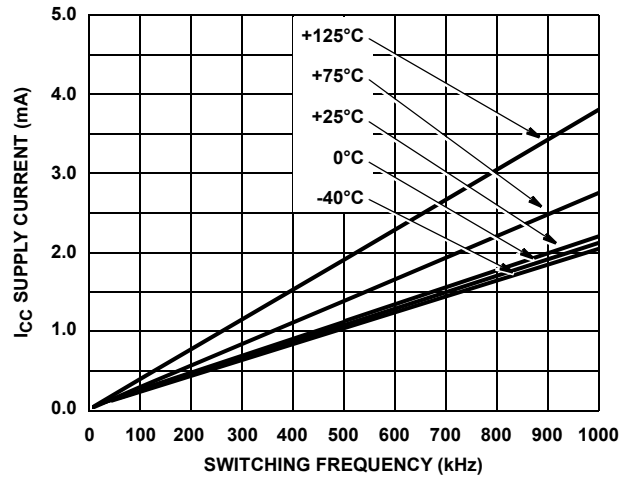

FIGURE 7. I<sub>CC0</sub>, NO-LOAD I<sub>CC</sub> SUPPLY CURRENT vs FREQUENCY (kHz) TEMPERATURE

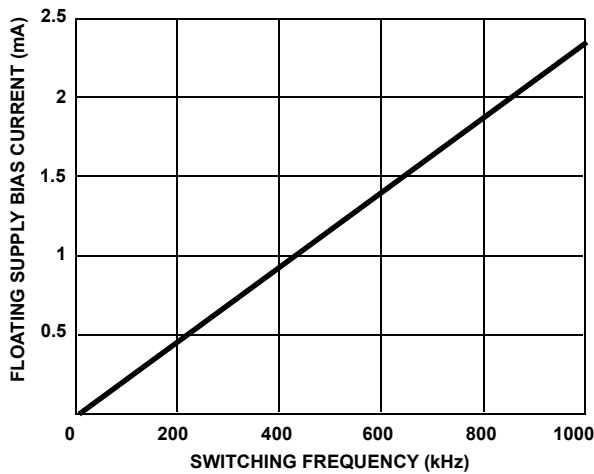

FIGURE 8. I<sub>AHB</sub>, I<sub>BHB</sub> NO-LOAD FLOATING SUPPLY BIAS CURRENT vs FREQUENCY

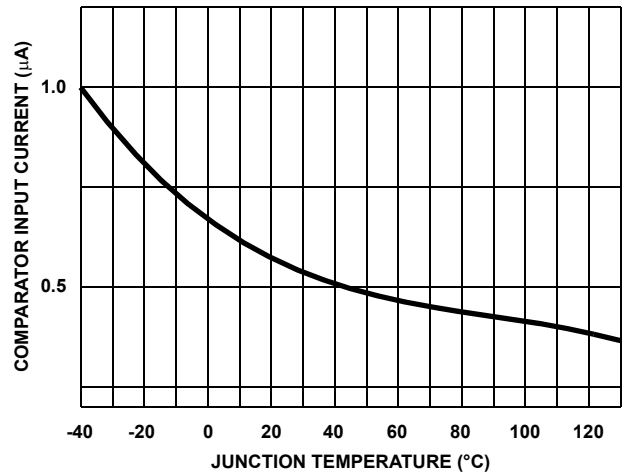

FIGURE 9. COMPARATOR INPUT CURRENT I<sub>L</sub> vs TEMPERATURE AT V<sub>CM</sub> = 5V

**Typical Performance Curves**  $V_{DD} = V_{CC} = V_{AHB} = V_{BHB} = 12V$ ,  $V_{SS} = V_{ALS} = V_{BLS} = V_{AHS} = V_{BHS} = 0V$ ,  $R_{HDEL} = R_{LDEL} = 100K$ , and  $T_A = +25^\circ C$ , Unless Otherwise Specified **(Continued)**

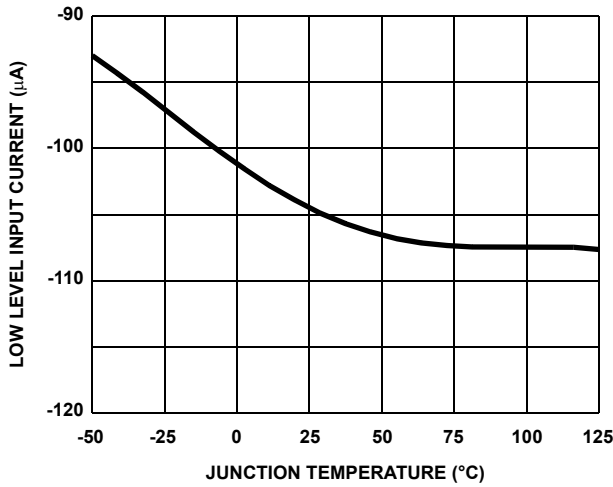

FIGURE 10. DIS LOW LEVEL INPUT CURRENT  $I_{IL}$  vs TEMPERATURE

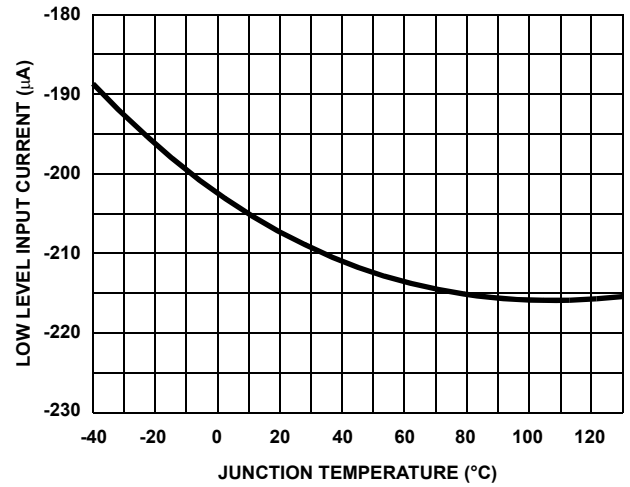

FIGURE 11. HEN LOW LEVEL INPUT CURRENT  $I_{IL}$  vs TEMPERATURE

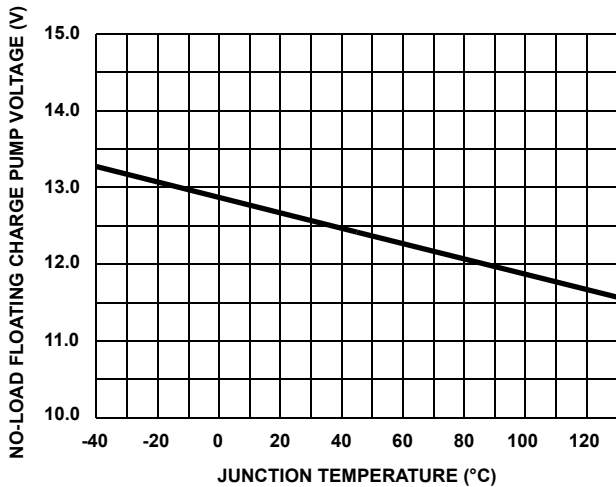

FIGURE 12. AHB - AHS, BHB - BHS NO-LOAD CHARGE PUMP VOLTAGE vs TEMPERATURE

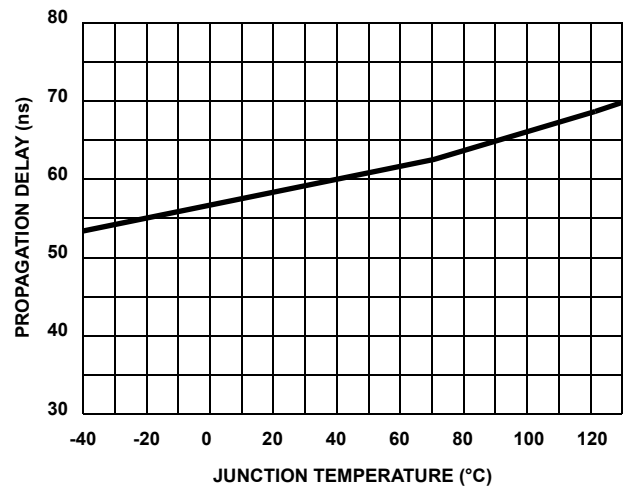

FIGURE 13. UPPER DISABLE TURN-OFF PROPAGATION DELAY  $T_{DISHIGH}$  vs TEMPERATURE

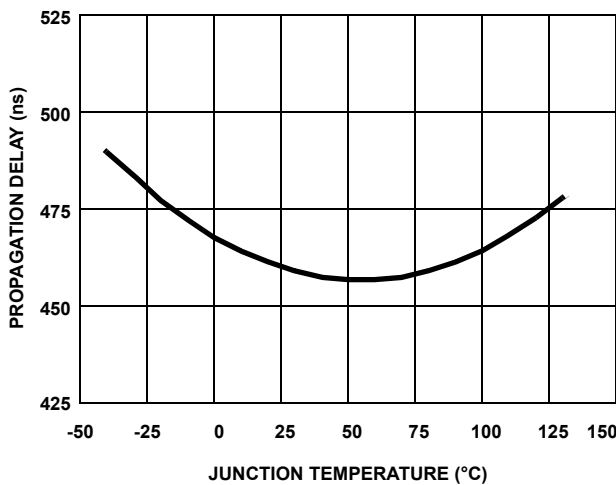

FIGURE 14. DISABLE TO UPPER ENABLE  $T_{UEN}$  PROPAGATION DELAY vs TEMPERATURE

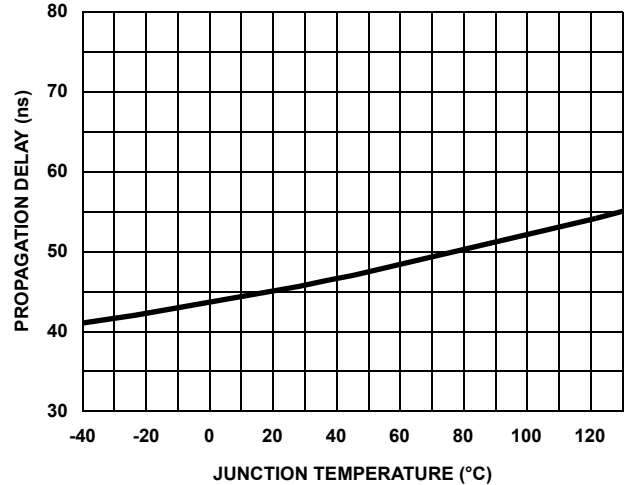

FIGURE 15. LOWER DISABLE TURN-OFF PROPAGATION DELAY  $T_{DISLOW}$  vs TEMPERATURE

**Typical Performance Curves**  $V_{DD} = V_{CC} = V_{AHB} = V_{BHB} = 12V$ ,  $V_{SS} = V_{ALS} = V_{BLS} = V_{AHS} = V_{BHS} = 0V$ ,  $R_{HDEL} = R_{LDEL} = 10K$ , and  $T_A = +25^{\circ}C$ , Unless Otherwise Specified

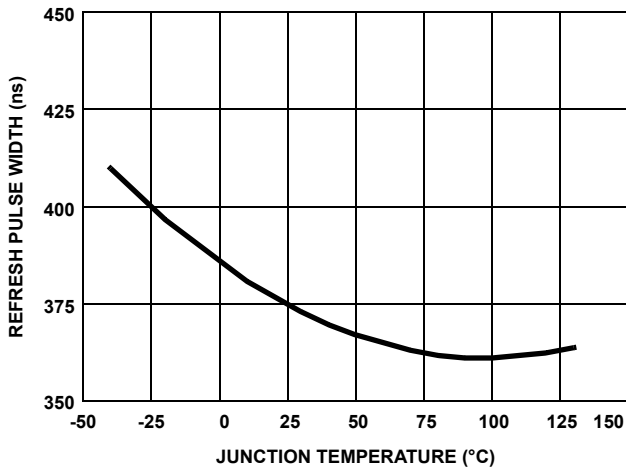

FIGURE 16.  $T_{REF-PW}$  REFRESH PULSE WIDTH vs TEMPERATURE

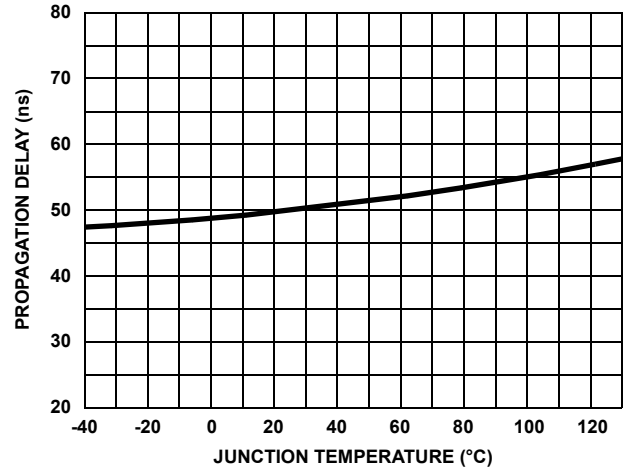

FIGURE 17. DISABLE TO LOWER ENABLE TDPLH PROPAGATION DELAY vs TEMPERATURE

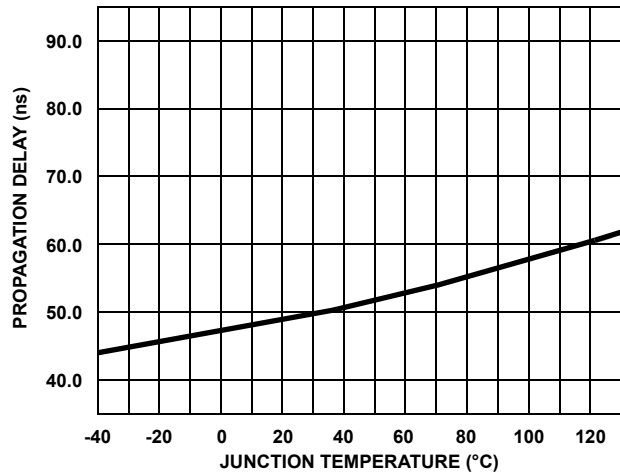

FIGURE 18. UPPER TURN-OFF PROPAGATION DELAY  $T_{HPHL}$  vs TEMPERATURE

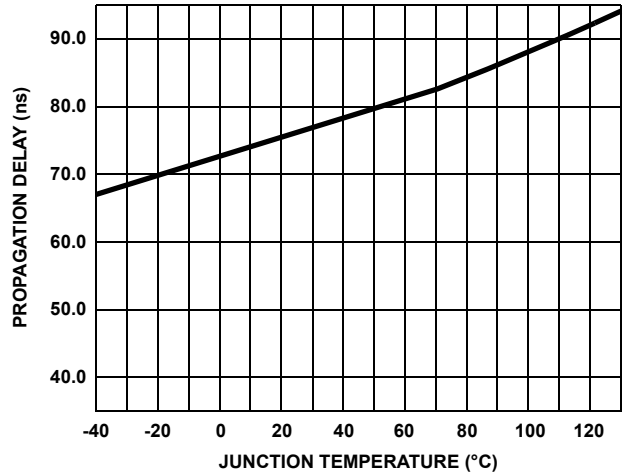

FIGURE 19. UPPER TURN-ON PROPAGATION DELAY  $T_{HPLH}$  vs TEMPERATURE

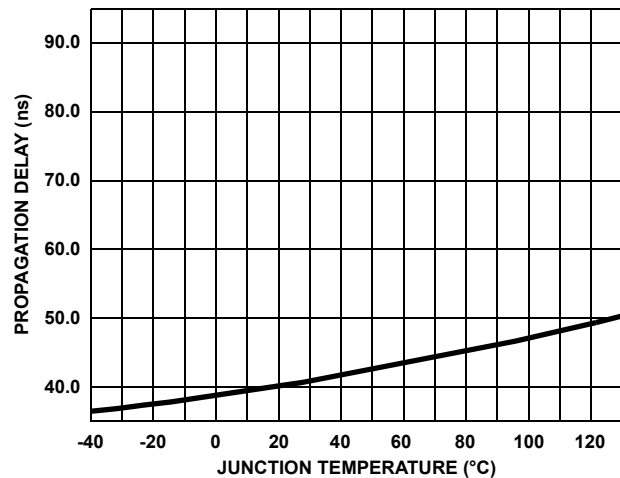

FIGURE 20. LOWER TURN-OFF PROPAGATION DELAY  $T_{LPHL}$  vs TEMPERATURE

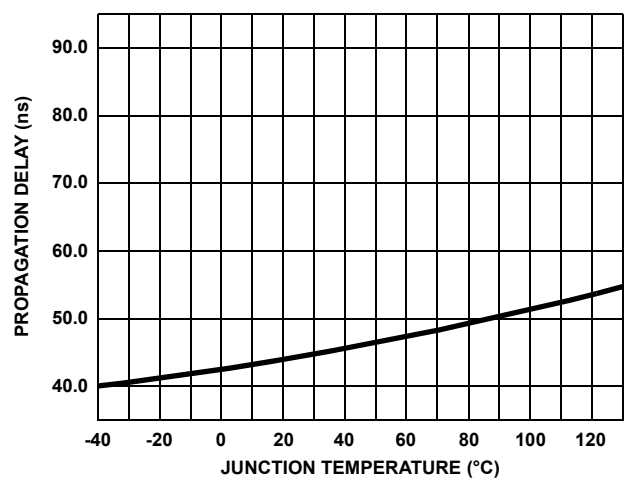

FIGURE 21. LOWER TURN-ON PROPAGATION DELAY  $T_{LPLH}$  vs TEMPERATURE

**Typical Performance Curves**  $V_{DD} = V_{CC} = V_{AHB} = V_{BHB} = 12V$ ,  $V_{SS} = V_{ALS} = V_{BLS} = V_{AHS} = V_{BHS} = 0V$ ,  $R_{HDEL} = R_{LDEL} = 100K$ , and  $T_A = +25^\circ C$ , Unless Otherwise Specified

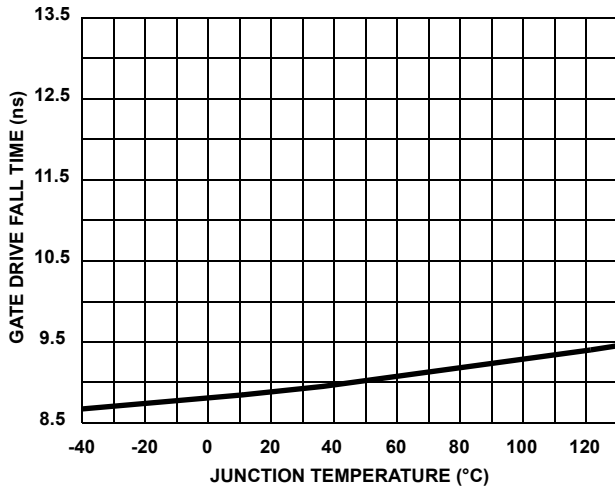

FIGURE 22. GATE DRIVE FALL TIME  $T_F$  vs TEMPERATURE

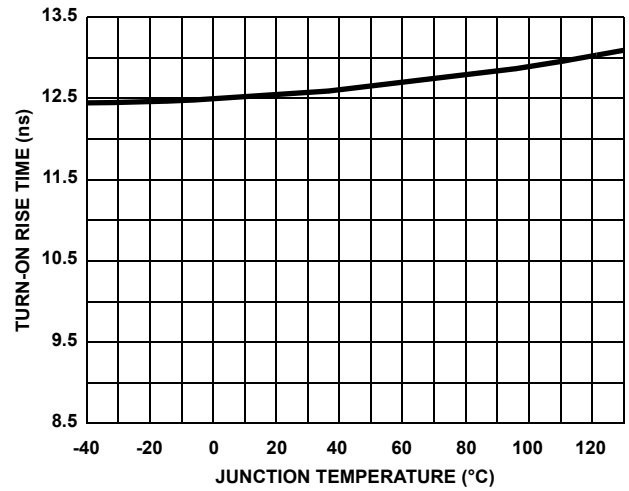

FIGURE 23. GATE DRIVE RISE TIME  $T_R$  vs TEMPERATURE

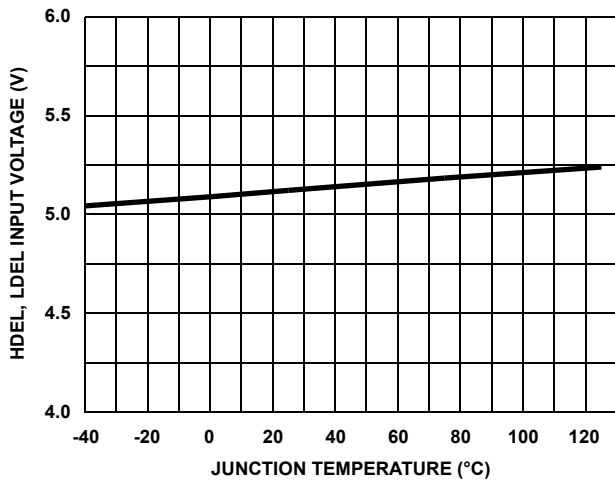

FIGURE 24.  $V_{LDEL}$ ,  $V_{HDEL}$  VOLTAGE vs TEMPERATURE

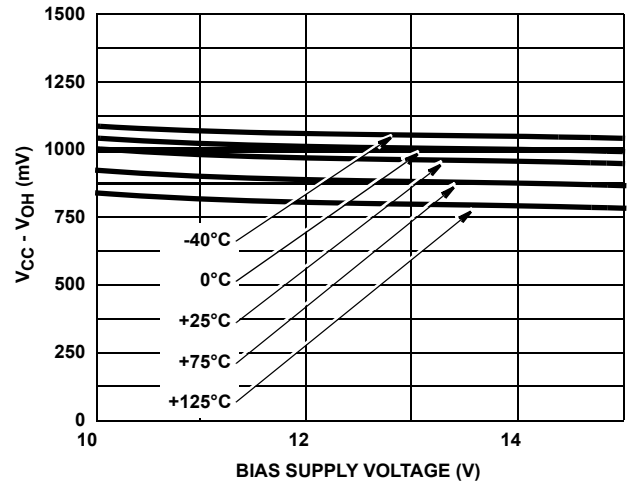

FIGURE 25. HIGH LEVEL OUTPUT VOLTAGE,  $V_{CC} - V_{OH}$  vs BIAS SUPPLY AND TEMPERATURE AT  $100\mu A$

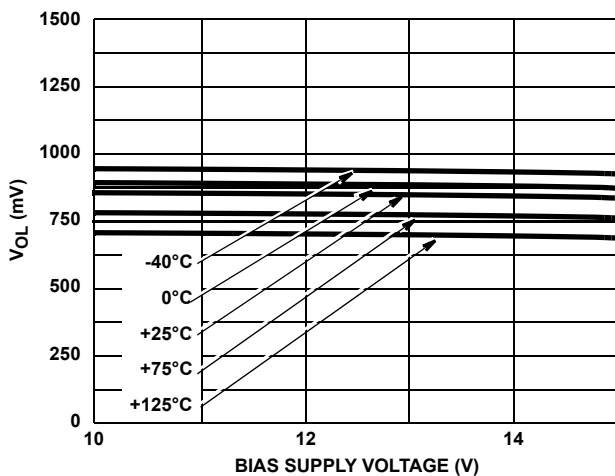

FIGURE 26. LOW LEVEL OUTPUT VOLTAGE  $V_{OL}$  vs BIAS SUPPLY AND TEMPERATURE AT  $100\mu A$

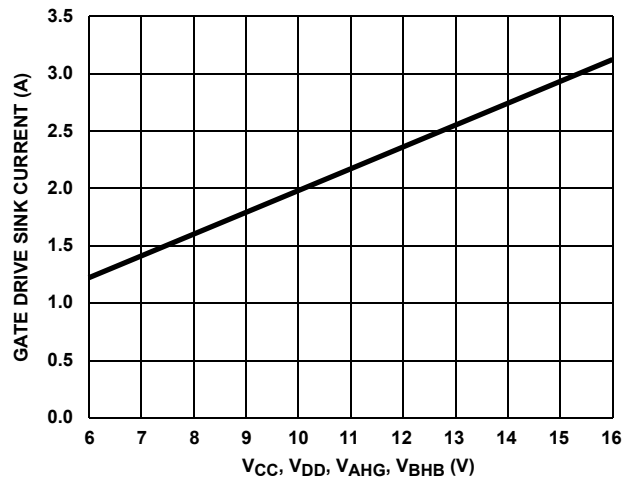

FIGURE 27. PEAK PULLDOWN CURRENT  $I_O$ . BIAS SUPPLY VOLTAGE

**Typical Performance Curves**  $V_{DD} = V_{CC} = V_{AHB} = V_{BHB} = 12V$ ,  $V_{SS} = V_{ALS} = V_{BLS} = V_{AHS} = V_{BHS} = 0V$ ,  $R_{HDEL} = R_{LDEL} = 100K$ , and  $T_A = +25^\circ C$ , Unless Otherwise Specified (Continued)

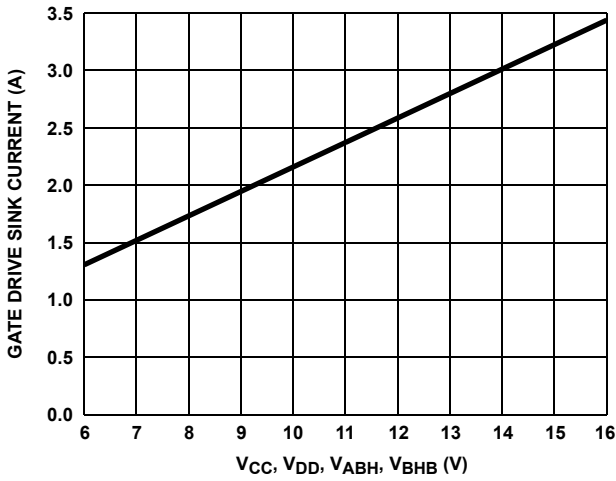

FIGURE 28. PEAK PULLUP CURRENT  $I_{O+}$  vs SUPPLY VOLTAGE

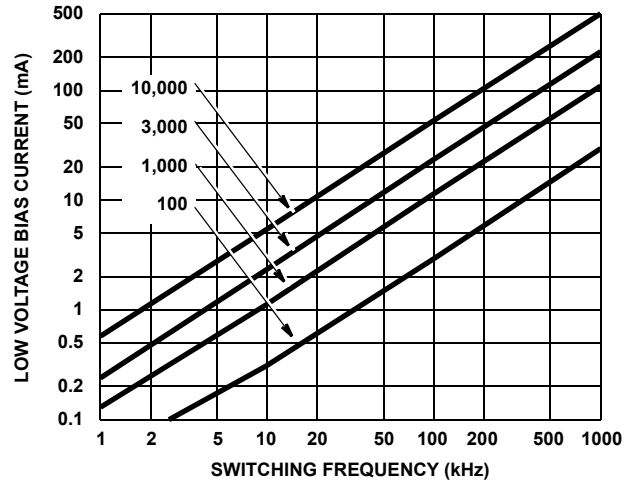

FIGURE 29. LOW VOLTAGE BIAS CURRENT  $I_{DD}$  AND  $I_{CC}$  (LESS QUIESCENT COMPONENT) vs FREQUENCY AND GATE LOAD CAPACITANCE

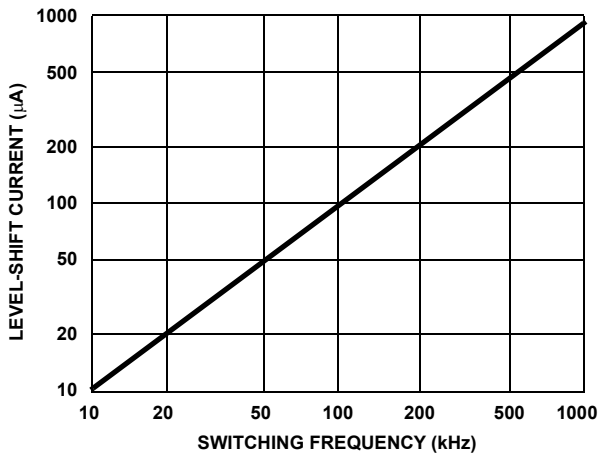

FIGURE 30. HIGH VOLTAGE LEVEL-SHIFT CURRENT vs FREQUENCY AND BUS VOLTAGE

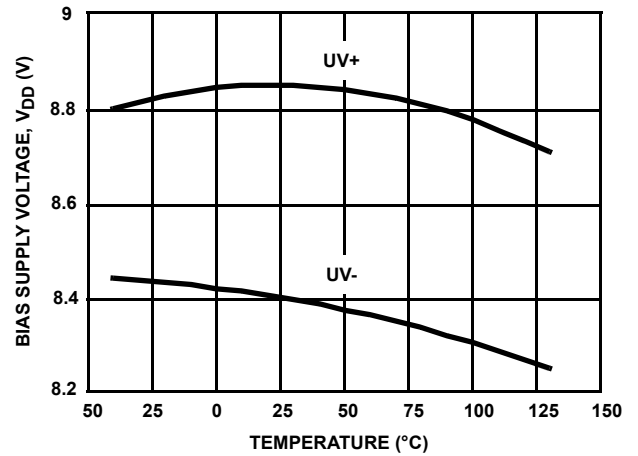

FIGURE 31. UNDERVOLTAGE LOCKOUT vs TEMPERATURE

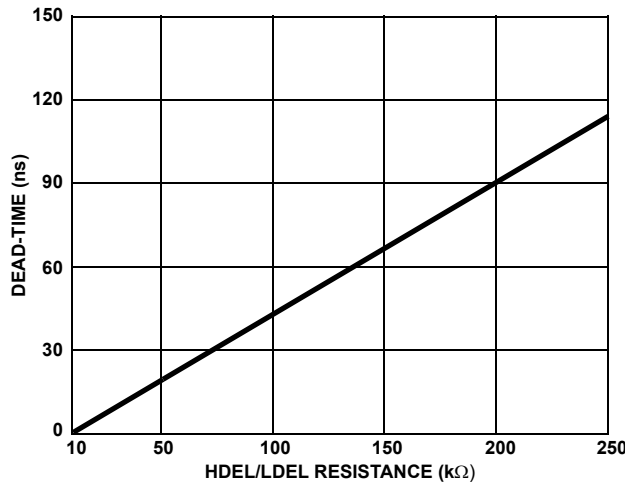
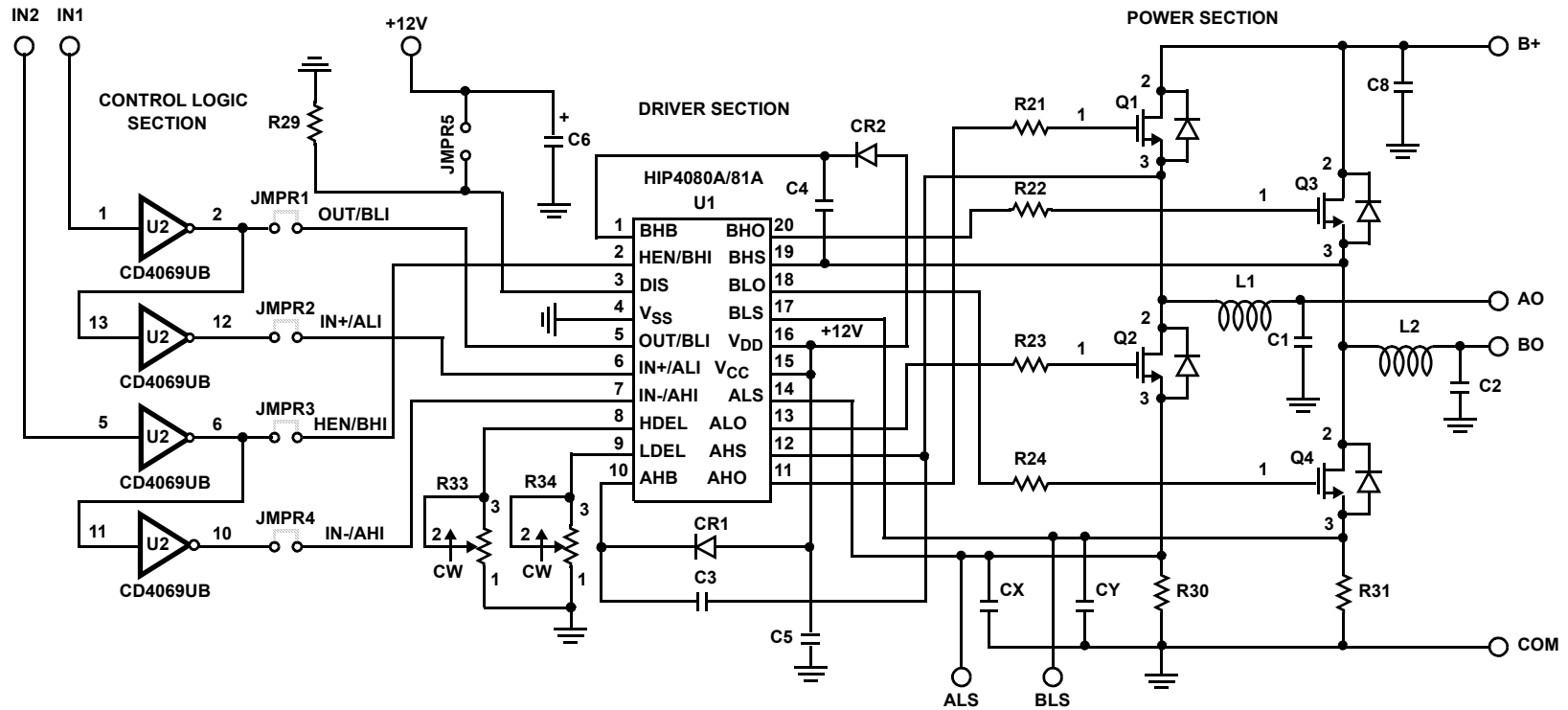

FIGURE 32. MINIMUM DEAD-TIME vs DEL RESISTANCE



NOTES:

1. DEVICE CD4069UB PIN 7 = COM. PIN 14 = +12V.
2. COMPONENTS L1, L2, C1, C2, CX, CY, R30, R31, ARE NOT SUPPLIED. REFER TO APPLICATION NOTE FOR HELP IN DETERMINING JMPR1 - JMPR4 JUMPER LOCATIONS.

FIGURE 33. HIP4080A EVALUATION PC BOARD SCHEMATIC

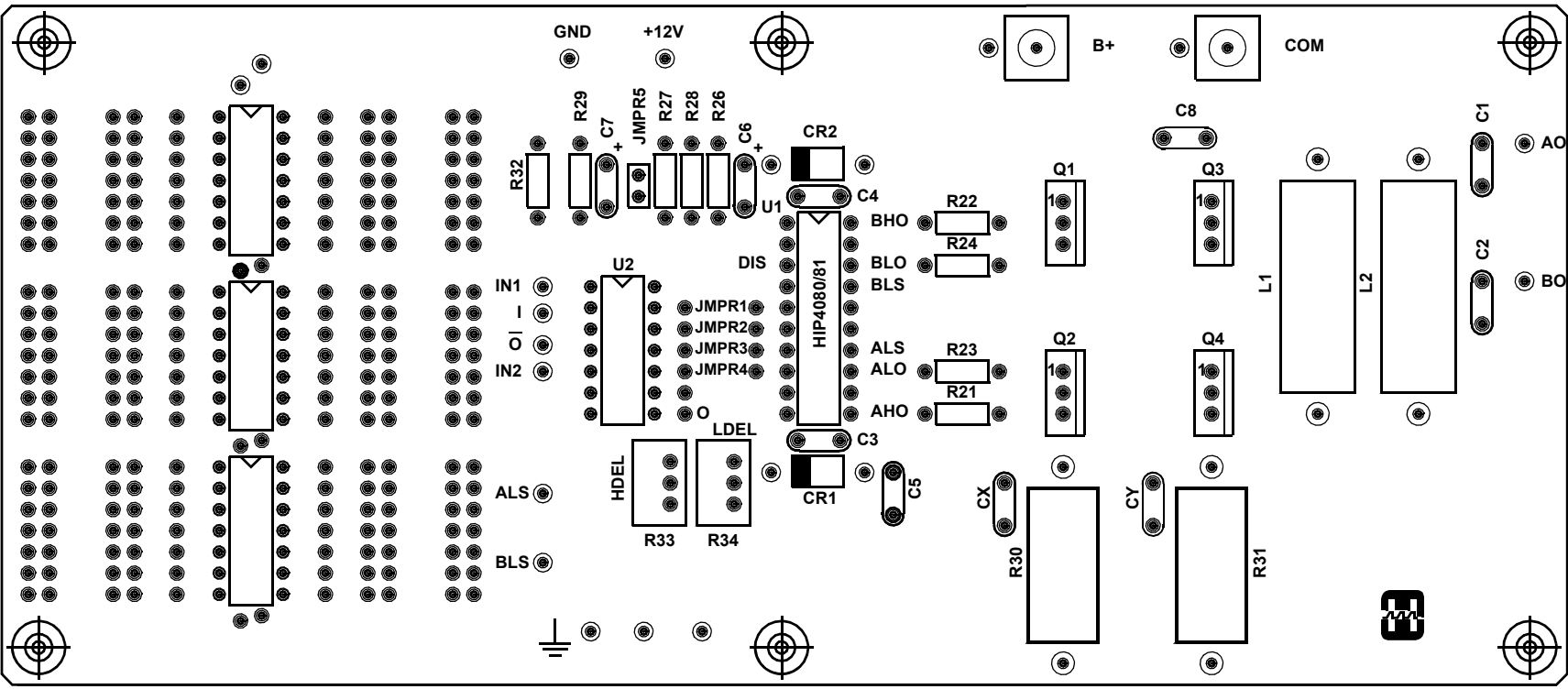

FIGURE 33. HIP4080A EVALUATION BOARD SILKSCREEN

## Revision History

The revision history provided is for informational purposes only and is believed to be accurate, but not warranted. Please visit our website to make sure you have the latest revision.

DATE	REVISION	CHANGE
Dec 11, 2019	FN3658.8	Removed retired parts. Added Revision History section. Updated POD M20.3 to the latest revision. Changes are as follows: Rev 2. - Removed "u" symbol from drawing (overlaps the "a" on Side View). Rev 3. - Top View: Corrected "7.50 BSC" to "7.60/7.40" (no change from rev 2; error was introduced in conversion) Changed "10.30 BSC" to "10.65/10.00" (no change from rev 2; error was introduced in conversion) Side View: Changed "12.80 BSC" to "13.00/12.60" (no change from rev 2; error was introduced in conversion) Changed "2.65 max" to "2.65/2.35" (no change from rev 2; error was introduced in conversion) Changed Note 1 from "ANSI Y14.5M-1982." to "ASME Y14.5M-1994" Updated to new POD format by moving dimensions from table onto drawing and adding land pattern Updated disclaimer.



**Package Outline Drawings**

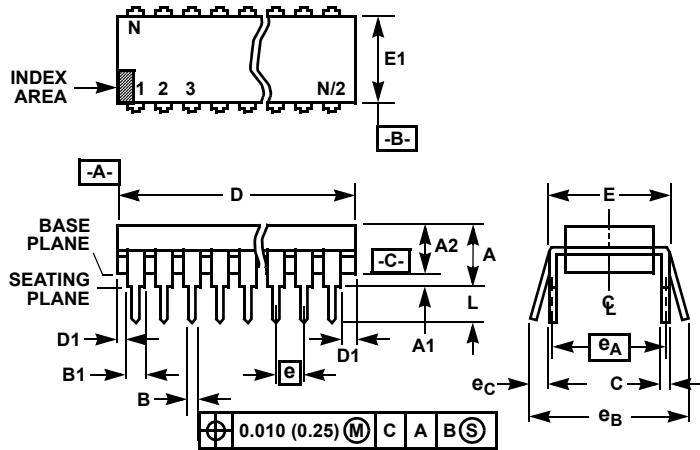

**NOTES:**

3. Controlling Dimensions: INCH. In case of conflict between English and Metric dimensions, the inch dimensions control.
4. Dimensioning and tolerancing per ANSI Y14.5M-1982.
5. Symbols are defined in the "MO Series Symbol List" in Section 2.2 of Publication No. 95.
6. Dimensions A, A1 and L are measured with the package seated in JEDEC seating plane gauge GS-3.
7. D, D1, and E1 dimensions do not include mold flash or protrusions. Mold flash or protrusions shall not exceed 0.010 inch (0.25mm).
8. E and  $e_A$  are measured with the leads constrained to be perpendicular to datum  $-C-$ .
9.  $e_B$  and  $e_C$  are measured at the lead tips with the leads unconstrained.  $e_C$  must be zero or greater.
10. B1 maximum dimensions do not include dambar protrusions. Dambar protrusions shall not exceed 0.010 inch (0.25mm).
11. N is the maximum number of terminal positions.
12. Corner leads (1, N, N/2 and N/2 + 1) for E8.3, E16.3, E18.3, E28.3, E42.6 will have a B1 dimension of 0.030 - 0.045 inch (0.76 - 1.14mm).

**E20.3 (JEDEC MS-001-AD ISSUE D)**  
20 LEAD DUAL-IN-LINE PLASTIC PACKAGE (PDIP)

SYMBOL	INCHES		MILLIMETERS		NOTES
	MIN	MAX	MIN	MAX	
A	-	0.210	-	5.33	4
A1	0.015	-	0.39	-	4
A2	0.115	0.195	2.93	4.95	-
B	0.014	0.022	0.356	0.558	-
B1	0.045	0.070	1.55	1.77	8
C	0.008	0.014	0.204	0.355	-
D	0.980	1.060	24.89	26.9	5
D1	0.005	-	0.13	-	5
E	0.300	0.325	7.62	8.25	6
E1	0.240	0.280	6.10	7.11	5
e	0.100 BSC		2.54 BSC		-
$e_A$	0.300 BSC		7.62 BSC		6
$e_B$	-	0.430	-	10.92	7
L	0.115	0.150	2.93	3.81	4
N	20		20		9

Rev. 0 12/93

**M20.3**  
**20 LEAD WIDE BODY SMALL OUTLINE PLASTIC PACKAGE (SOIC)**  
 Rev 3, 2/11

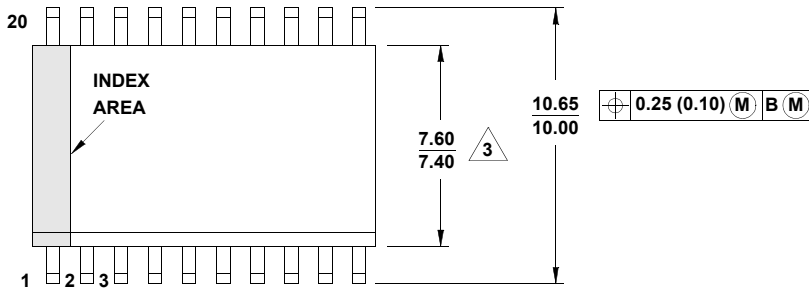

**TOP VIEW**

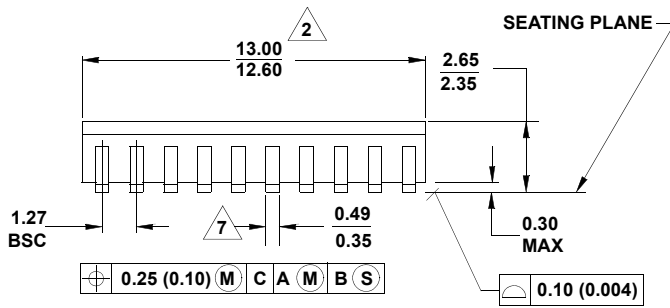

**SIDE VIEW**

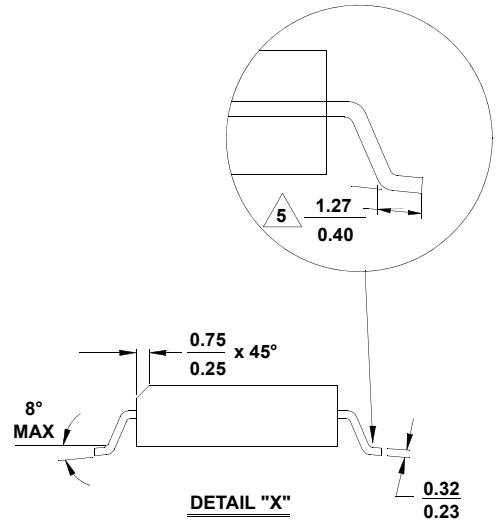

**DETAIL "X"**

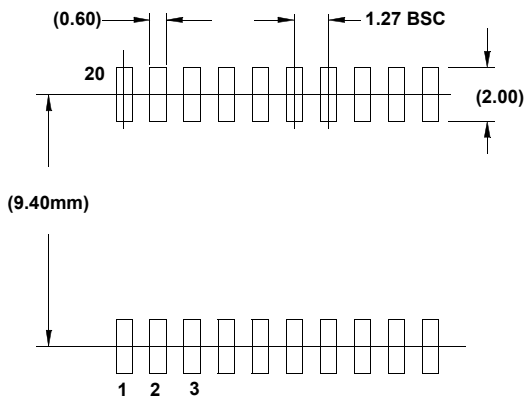

**TYPICAL RECOMMENDED LAND PATTERN**

**NOTES:**

1. Dimensioning and tolerancing per ASME Y14.5M-1994.
2. Dimension does not include mold flash, protrusions or gate burrs. Mold flash, protrusion and gate burrs shall not exceed 0.15mm (0.006 inch) per side.
3. Dimension does not include interlead lash or protrusions. Interlead flash and protrusions shall not exceed 0.25mm (0.010 inch) per side.
4. The chamfer on the body is optional. If it is not present, a visual index feature must be located within the crosshatched area.
5. Dimension is the length of terminal for soldering to a substrate.
6. Terminal numbers are shown for reference only.
7. The lead width as measured 0.36mm (0.14 inch) or greater above the seating plane, shall not exceed a maximum value of 0.61mm (0.024 inch)
8. Controlling dimension: MILLIMETER.
9. Dimensions in ( ) for reference only.
10. JEDEC reference drawing number: MS-013-AC.

## Notice

1. Descriptions of circuits, software and other related information in this document are provided only to illustrate the operation of semiconductor products and application examples. You are fully responsible for the incorporation or any other use of the circuits, software, and information in the design of your product or system. Renesas Electronics disclaims any and all liability for any losses and damages incurred by you or third parties arising from the use of these circuits, software, or information.
  2. Renesas Electronics hereby expressly disclaims any warranties against and liability for infringement or any other claims involving patents, copyrights, or other intellectual property rights of third parties, by or arising from the use of Renesas Electronics products or technical information described in this document, including but not limited to, the product data, drawings, charts, programs, algorithms, and application examples.
  3. No license, express, implied or otherwise, is granted hereby under any patents, copyrights or other intellectual property rights of Renesas Electronics or others.
  4. You shall not alter, modify, copy, or reverse engineer any Renesas Electronics product, whether in whole or in part. Renesas Electronics disclaims any and all liability for any losses or damages incurred by you or third parties arising from such alteration, modification, copying or reverse engineering.
  5. Renesas Electronics products are classified according to the following two quality grades: "Standard" and "High Quality". The intended applications for each Renesas Electronics product depends on the product's quality grade, as indicated below.
    - "Standard": Computers; office equipment; communications equipment; test and measurement equipment; audio and visual equipment; home electronic appliances; machine tools; personal electronic equipment; industrial robots; etc.
    - "High Quality": Transportation equipment (automobiles, trains, ships, etc.); traffic control (traffic lights); large-scale communication equipment; key financial terminal systems; safety control equipment; etc.Unless expressly designated as a high reliability product or a product for harsh environments in a Renesas Electronics data sheet or other Renesas Electronics document, Renesas Electronics products are not intended or authorized for use in products or systems that may pose a direct threat to human life or bodily injury (artificial life support devices or systems; surgical implantations; etc.), or may cause serious property damage (space system; undersea repeaters; nuclear power control systems; aircraft control systems; key plant systems; military equipment; etc.). Renesas Electronics disclaims any and all liability for any damages or losses incurred by you or any third parties arising from the use of any Renesas Electronics product that is inconsistent with any Renesas Electronics data sheet, user's manual or other Renesas Electronics document.
  6. When using Renesas Electronics products, refer to the latest product information (data sheets, user's manuals, application notes, "General Notes for Handling and Using Semiconductor Devices" in the reliability handbook, etc.), and ensure that usage conditions are within the ranges specified by Renesas Electronics with respect to maximum ratings, operating power supply voltage range, heat dissipation characteristics, installation, etc. Renesas Electronics disclaims any and all liability for any malfunctions, failure or accident arising out of the use of Renesas Electronics products outside of such specified ranges.
  7. Although Renesas Electronics endeavors to improve the quality and reliability of Renesas Electronics products, semiconductor products have specific characteristics, such as the occurrence of failure at a certain rate and malfunctions under certain use conditions. Unless designated as a high reliability product or a product for harsh environments in a Renesas Electronics data sheet or other Renesas Electronics document, Renesas Electronics products are not subject to radiation resistance design. You are responsible for implementing safety measures to guard against the possibility of bodily injury, injury or damage caused by fire, and/or danger to the public in the event of a failure or malfunction of Renesas Electronics products, such as safety design for hardware and software, including but not limited to redundancy, fire control and malfunction prevention, appropriate treatment for aging degradation or any other appropriate measures. Because the evaluation of microcomputer software alone is very difficult and impractical, you are responsible for evaluating the safety of the final products or systems manufactured by you.
  8. Please contact a Renesas Electronics sales office for details as to environmental matters such as the environmental compatibility of each Renesas Electronics product. You are responsible for carefully and sufficiently investigating applicable laws and regulations that regulate the inclusion or use of controlled substances, including without limitation, the EU RoHS Directive, and using Renesas Electronics products in compliance with all these applicable laws and regulations. Renesas Electronics disclaims any and all liability for damages or losses occurring as a result of your noncompliance with applicable laws and regulations.
  9. Renesas Electronics products and technologies shall not be used for or incorporated into any products or systems whose manufacture, use, or sale is prohibited under any applicable domestic or foreign laws or regulations. You shall comply with any applicable export control laws and regulations promulgated and administered by the governments of any countries asserting jurisdiction over the parties or transactions.
  10. It is the responsibility of the buyer or distributor of Renesas Electronics products, or any other party who distributes, disposes of, or otherwise sells or transfers the product to a third party, to notify such third party in advance of the contents and conditions set forth in this document.
  11. This document shall not be reprinted, reproduced or duplicated in any form, in whole or in part, without prior written consent of Renesas Electronics.
  12. Please contact a Renesas Electronics sales office if you have any questions regarding the information contained in this document or Renesas Electronics products.
- (Note1) "Renesas Electronics" as used in this document means Renesas Electronics Corporation and also includes its directly or indirectly controlled subsidiaries.
- (Note2) "Renesas Electronics product(s)" means any product developed or manufactured by or for Renesas Electronics.

(Rev.4.0-1 November 2017)

## Corporate Headquarters

TOYOSU FORESIA, 3-2-24 Toyosu,  
Koto-ku, Tokyo 135-0061, Japan  
[www.renesas.com](http://www.renesas.com)

## Contact Information

For further information on a product, technology, the most up-to-date version of a document, or your nearest sales office, please visit:  
[www.renesas.com/contact/](http://www.renesas.com/contact/)

## Trademarks

Renesas and the Renesas logo are trademarks of Renesas Electronics Corporation. All trademarks and registered trademarks are the property of their respective owners.

Компания «Океан Электроники» предлагает заключение долгосрочных отношений при поставках импортных электронных компонентов на взаимовыгодных условиях!

Наши преимущества:

- Поставка оригинальных импортных электронных компонентов напрямую с производств Америки, Европы и Азии, а так же с крупнейших складов мира;
- Широкая линейка поставок активных и пассивных импортных электронных компонентов (более 30 млн. наименований);
- Поставка сложных, дефицитных, либо снятых с производства позиций;
- Оперативные сроки поставки под заказ (от 5 рабочих дней);
- Экспресс доставка в любую точку России;
- Помощь Конструкторского Отдела и консультации квалифицированных инженеров;
- Техническая поддержка проекта, помощь в подборе аналогов, поставка прототипов;
- Поставка электронных компонентов под контролем ВП;
- Система менеджмента качества сертифицирована по Международному стандарту ISO 9001;
- При необходимости вся продукция военного и аэрокосмического назначения проходит испытания и сертификацию в лаборатории (по согласованию с заказчиком);
- Поставка специализированных компонентов военного и аэрокосмического уровня качества (Xilinx, Altera, Analog Devices, Intersil, Interpoint, Microsemi, Actel, Aeroflex, Peregrine, VPT, Syfer, Eurofarad, Texas Instruments, MS Kennedy, Miteq, Cobham, E2V, MA-COM, Hittite, Mini-Circuits, General Dynamics и др.);

Компания «Океан Электроники» является официальным дистрибьютором и эксклюзивным представителем в России одного из крупнейших производителей разъемов военного и аэрокосмического назначения «JONHON», а так же официальным дистрибьютором и эксклюзивным представителем в России производителя высокотехнологичных и надежных решений для передачи СВЧ сигналов «FORSTAR».



## JONHON

«JONHON» (основан в 1970 г.)

Разъемы специального, военного и аэрокосмического назначения:

(Применяются в военной, авиационной, аэрокосмической, морской, железнодорожной, горно- и нефтедобывающей отраслях промышленности)

«FORSTAR» (основан в 1998 г.)

ВЧ соединители, коаксиальные кабели,  
кабельные сборки и микроволновые компоненты:

(Применяются в телекоммуникациях гражданского и специального назначения, в средствах связи, РЛС, а так же военной, авиационной и аэрокосмической отраслях промышленности).



Телефон: 8 (812) 309-75-97 (многоканальный)

Факс: 8 (812) 320-03-32

Электронная почта: [ocean@oceanchips.ru](mailto:ocean@oceanchips.ru)

Web: <http://oceanchips.ru/>

Адрес: 198099, г. Санкт-Петербург, ул. Калинина, д. 2, корп. 4, лит. А