



Littelfuse®



Cole Hersee®
A Littelfuse® Brand

AFTERMARKET PRODUCTS CATALOG



Passenger and Commercial Vehicle Products

- Fuses & Fuse Holders
- Power Distribution
- Relays & Solenoids
- Switches
- Connectors



**ORIGINAL
EQUIPMENT
MANUFACTURER**

www.Littelfuse.com/aftermarket

Local Resources for a **GLOBAL** Market

Littelfuse products help protect, control and distribute vehicle electrical power in OEM and aftermarket applications for industries such as **heavy-duty truck, construction and agriculture.**

We offer a broad and reliable selection of **fuses, fuse blocks, power distribution modules, high-current switches, relays and solenoids** to fit your requirements.

For decades, we have helped OEMs, engineers and end-users select the right product for their applications. Today, Littelfuse offers the broadest range of products for protection, sensing, and control needs while providing exceptional service and support that our customers expect.



Market Focus **INDUSTRIES** and Applications



Truck & Bus

- On-Highway
- Severe Duty
- Transit Buses
- Vocational



Material Handling

- Fork Lifts
- Telehandlers
- Aerial Work Platform
- Pallet Jacks



Automotive Passenger Car

- OEM
- Motorsports
- Maintenance
- Fleets



Municipality

- Emergency
- Waste Trucks
- Fire & Rescue
- Utility



Construction & Agriculture

- Loaders
- Tractors
- Excavators
- Harvesters



Marine & Recreational

- Boats & Marine
- Golf Carts
- Recreation Vehicles
- ATV & Snowmobiles



Over 90 Years of Electrical Power Expertise



New **AFTERMARKET PRODUCTS** Now Available

MCASE+ Fuses



COLOR CODE	CURRENT RATING (A)	CARDED 1-PC
		SLOTTED PART NUMBER
Gray	15	MCAS015.XPS
Blue	20	MCAS020.XPS
White	25	MCAS025.XPS
Pink	30	MCAS030.XPS
Green	40	MCAS040.XPS

FHZ Fuse Holders



Part Number	Description	Coming Soon
0FHZ0001Z	5-Stud Assembly with Bolts and Bus Bar	
0FHZ0002Z	5-Stud Full Assembly with M10 Input	
0FHZ0003Z	5-Stud Box Only for Configuration	
0FHZ0005Z	5-Stud Full Assembly with M8 Input	
0FHZ0006Z	7-Stud Assembly with Bolts and Bus Bar	
0FHZ0007Z	7-Stud Full Assembly with M10 Input	
0FHZ0008Z	7-Stud Box Only for Configuration	
0FHZ0009Z	7-Stud Full Assembly with M8 Input	

Additional RedBox Blade Fuse Module Tray



Part Number	Description
ORBOX003ZGLO	ATO, MINI, and MAXI SmartGlow Fuses, Fuse Pullers, ATO and MINI HD In-Line Fuse Holders 272 Piece Assortment

Contact your local sales manager for more information

Updated **COLE HERSEE BRAND** Packaging



Former Design

New Design

Cole Hersee – A Littelfuse Brand joint logo promoting the relationship between the brands.



Blue and yellow Cole Hersee **brand colors** remain prominent for fast identification.

Large, **easy-to-read label with part number and description** for quick product selection.

Enhanced **installation information** and detailed descriptions included in the packaging.

Heavy-duty box packaging protects products in distribution environment.

Heavy-duty clamshell packaging protects products in retail environment.

Matching blister product for a consistent and attractive product display.



Former Design

New Design

Table of Contents

Circuit Protection - Fuses & Circuit Breakers

Fuse Selection Chart	6-7
Fuseology	8-9
Retail Information, Packaging & Part Numbers	10-12
Blade Fuses	13-15
Cartridge Fuses	16
Bolt-Down Fuses	17
Auto Link Fuses	18
Glass Fuses	19
Specialty Fuse Products	20
Fuse Assortment Kits	21-26
Circuit Breakers	27-30



Fuse Blocks & Holders

Bolt-Down Fuse Blocks	32
In-line Fuse Holders	33-34
JCASE & Glass Fuse Holders	35
Add-A-Circuit & Power Feed	36
Fuse Puller Accessories	37
Multiple Position Fuse Blocks	38-39
Terminal Blocks	40-41
New Product Spotlight	42



Power Distribution Modules

Hard-Wired Boxes	44
Power Distribution Modules	44-47
PDM IP Rating Flyer	48



Battery Management

Battery Isolators	50
Battery Combiners & FlexMod Devices	51
Low Voltage Disconnects	51
How a Smart Battery Isolator Works	52



Relays & Solenoids

Bi-Stable Relays	54
Standard High Current Relays (Solenoids)	55-57
Reversing & Latching Relays	58
Plug-In Relays & MicroRelays	59-60



Battery & Master Disconnect Switches

Sealed High Amp Battery Switches	62
Manual Battery Switches	63-65
Standard Metal Body Battery Switches	66-67
Marine-Grade Battery Switches	68
Battery Selector Disconnect Switches	69
Battery Disconnect Switch Accessories	70



Ignition Switches

Sealed Ignition Switches	72
Heavy Duty Ignition Switches	73
General Purpose Ignition Switches	74-75
Marine Grade Ignition Switches	76
Ignition Switch Accessories	77
Anti-Restart Ignition Switches	78



Rocker Switches

Sealed Rocker Switches	80-83
Rocker Switch Accessories	84
Standard Heavy Duty Rocker Switches	85
FAQ Rocker and Toggle Switches	86



Toggle Switches

Toggle Switches	88-91
Toggle Switch Accessories	92
Switch Reference Guide & Diagrams	93-94



Momentary Switches

Momentary Push-Button Switches	96-99
Door Switches	99-100



Push-Pull, Rotary & Foot Switches

Push-Pull Switches	102-103
Rotary Switches	104
Rotary Wiper Switches	105-106
Rotary Headlamp Switches	107
Foot Switches	108
Stoplamp Switches	109
Backup & Neutral Safety Ball Switches	109-110



Vehicle Connectors

Tractor-Trailer Connectors	112-116
Trailer Connectors	117
Connector Mounts & Accessories	118



Indicator Devices

LED Pilot Lights	120
Incandescent Pilot Lights	121-122
Panel Lamps and Base Sockets	122
Buzzers and Alarms	123
Why are LED Lights Better	124



Appendix

Alphanumeric Part Number Index	125-129
Schematics	130-131



Circuit Protection



What Type of Fuse do I Need?



DC (automotive) fuses are offered in two basic forms: Blade or Bolt Down.

Blade & Cartridge fuses can be hand inserted into a fuse holder. These fuses provide protection for several amperage ratings up to 80A. They are well suited to protect smaller to medium diameter wires that are usually some distance from the battery. Single blade fuse holders are often called 'In-Line' fuse holders as they are spliced into the wiring. Remember to place the fuse holder as close to the battery and as far away from the load as possible, so that it protects the wire from a short anywhere along its length. Any short between the power source and the fuse is not protected. Littelfuse blade fuses include: MICRO2®, MICRO3®, MINI®, LP MINI®, ATO®, MAXI®, MCASE+®, JCASE® and LP JCASE®.



Bolt Down fuses need to be secured to the fuse holder with a screw, nut or bolt. These fuses provide protection from 30A to 600A. They are well suited to protect medium to large diameter wires that are usually closer to the battery. Ring terminals are crimped onto cables that are connected to these holders and spliced into the wiring. Remember to place the fuse holder as close to the battery and as far away from the load as possible, so that it protects the wire from a short anywhere along its length. Any short between the power source and the fuse is not protected which is why you should have master fusing as close the battery as possible. Littelfuse bolt-down fuses include: MIDI®, MEGA®, CF8 and ZCASE®.

Also, there are still a wide variety of applications that use glass tube fuses. These are typically lower current values and are becoming less popular for most automotive applications due to their size, form factors, and lack of color coding.

It Glows When it Blows!



SmartGlow® fuse technology makes identifying an open circuit quick and easy. Inside a fuse box, it can be difficult to locate which fuse in an array has blown. You can easily identify the SmartGlow because it lights up, indicating the need for replacement. Available in MINI, ATO, and MAXI blade fuses.

Every Fuse Requires a Fuse Holder!

Littelfuse offers a wide variety of fuse holder and power distribution modules in different configurations to meet unique needs. Please see the Power Distribution Modules or Fuse Blocks & Holders sections of the catalog to select a product that fits your application requirements.

FUSE HOLDER SELECTION CHART

FUSE TYPE	ATO®				MINI®		MAXI		GLASS				
ACTUAL FUSE SIZE													
PHOTO													
Series Name	FHAC1	FHAC2	FHA1	FHA2	FHA-GLO	AFH1	AFH1	FHM1	FHM2	FHM-GLO	MAH1	FNY1	FNY2
Holder Type	In-Line	In-Line	In-Line	In-Line	In-Line	In-Line Panel Mount	In-Line	In-Line	In-Line	In-Line	In-Line	In-Line	In-Line
Max Amperage	20A	30A	20A	30A	30A	20A	30A	20A	30A	30A	60A	20A	30A
Wire Color	Black	Orange	Black	Orange	Red	Black	Red	Black	Orange	Red	Black or Red	Black	Orange
Weatherproof	•	•			•			•	•	•		•	•
Notes	Standard	Heavy Duty	Standard	Heavy Duty	Smart-Glow	Standard	Heavy Duty	Standard	Heavy Duty	Smart-Glow	Standard	Standard	Heavy Duty
FUSE TYPE	JCASE® and Low Profile JCASE®											MEGA®	
ACTUAL FUSE SIZE													
PHOTO													
Series Name	FHJC1	FHJC2	FHJ1	FHJ2	498	Compact-498	SN-MIDI	FLEX-MIDI	298	SN-MEGA	FLEX-MEGA		
Holder Type	In-Line	In-Line	In-Line	In-Line	In-Line	In-Line	Bolt-Down	Bolt-Down	Bolt-Down	Bolt-Down	Bolt-Down		
Max Amperage	40A	60A	40A	60A	200A	200A	200A	200A	500A	500A	500A		
Wire Color	Red	Red	Red	Red	—	—	—	—	—	—	—		
Weatherproof	•	•				with heat shrink	•					•	
Notes	Standard	Heavy Duty	Standard	Heavy Duty	Standard	Compact	AssureLatch & IP69K	Busbars Available	Standard	AssureLatch & IP69K	Busbars Available		

Fuseology

Understanding how circuit protection works is a key to diagnosing automotive electrical problems. When a fuse blows, that means the fuse is doing its job — sending you a message that something needs to be fixed.

WHAT IS THE PURPOSE OF A FUSE?

A fuse is a safety valve. It is designed to stop current from exceeding the rating of the wires or components. Without fuses, excessive current could cause damage to electrical systems, and even result in fires.

In general, a fuse has a simple construction. The key component is the “element” — a short piece of metal wire or strap.

WHAT CAUSES A FUSE TO BLOW?

The element is designed to melt at a specific temperature, to protect wires and equipment from overcurrents. An overcurrent is any current that exceeds the amperage rating or wiring capacity of equipment or devices under normal conditions of use.



If an overcurrent causes the current in a circuit to rise above a specific level — often the circuit’s rating — the heat produced will melt the fuse’s element, causing the fuse to “blow.” This opens the circuit and immediately stops the flow of current. Fuses are designed to blow at temperatures far below those that would cause damage or hazards.

Once a fuse is blown, it can be replaced to allow the current to flow again. **But simply replacing a fuse may not be the solution to the problem.** In fact, there is a chance the fuse will just blow again, because the fuse is signaling a problem in the system. Understanding the factors that cause a fuse to blow will help you diagnose automotive electrical problems.

There are two types of overcurrents that can cause a fuse to blow: overloads and short circuits.

Overload

What: The current exceeds the amperage at which the wires or equipment are rated.

Why: Too many devices are connected to one circuit, or a device malfunctions and draws higher than its normal operating current. Sustained overloads cause overheating of circuit components and the fuse blows.

Short Circuit

What: The current is out of its normal path.

Why: A malfunction creates an unintended path for electricity to flow from the battery or alternator to ground. This can be caused by the touching of any positive wire to a ground wire, e.g. due to frayed wire insulation, or tools laid across the positive and ground wires of a circuit. The uncontrolled current to ground then surpasses the normal resistance of the wire contained in the circuit, forcing higher and higher current to the point of the generating heat which blows the fuse.



Bold letter indicates fuse block location.

- | | |
|--------------------------|--|
| A Left fire wall | G Behind/under dash left |
| B Right fire wall | H Behind/in glove box |
| C Right fender | J Behind/under dash right |
| D Right front | K Rear compartment |
| E Left front | IL In-line with device protected |
| F Left fender | (locations may vary from car to car, see your dealer.) |

FINDING A FUSE

To be able to address fuse issues, you first must be able to locate the appropriate fuse within the vehicle. In today’s vehicles, each individual wire is protected by a circuit protection device.

Fuses are contained in fuse blocks located at various points throughout the vehicle. The diagram above illustrates typical fuse block locations.

SELECTING THE RIGHT FUSE

Once you have found the fuse that has blown, and solved the problem in the vehicle, you must replace the blown fuse with an appropriate device.

When selecting the right fuse for replacement, you should consider the following:

Physical Type

The replacement fuse must be of the same physical type as the blown fuse being replaced. It must be of the same style and have the same dimensions so that it can fit properly in the fuse block or fuse holder. Check your owner’s manual to determine the appropriate fuse type.

Installation Tip: Littelfuse holds patents for the designs on most automotive fuses. It is important to remember that the physical type of the fuse is important, but it is not the only factor affecting the fuse’s function. Although some fuses appear to be the same type and dimension as Littelfuse fuses, they do not necessarily have the same performance characteristics.

Look for the Littelfuse OEM Label

To guarantee the same level of quality in circuit protection that the major automotive manufacturers require for their original equipment fuses, look for the OEM seal on Littelfuse aftermarket products. Only Littelfuse products can guarantee this level of quality.



Fuseology

1

Beware of Counterfeit Fuses

At first glance, it's hard to tell the difference between a genuine Littelfuse blade fuse and a counterfeit. The counterfeit may have the same physical dimensions, but using it can be dangerous because it fails to perform to the stringent performance and safety specifications developed by Littelfuse and the OEMs.

In many cases, the elements in counterfeit fuses do not correspond with the amperage specification stamped on the fuse. This will prevent the elements from opening at the rated or correct amperage, which could result in a fire causing serious damage to the vehicle, its contents and its passengers.

Responding to this growing problem, the United States International Trade Commission and then President Ronald Reagan issued and approved an exclusion order in 1983 prohibiting the importation of the look-alike blade fuses into the United States. This order was initiated because many of these fuses were proven to be totally unsafe. The photos shown here indicate why counterfeit fuses are potentially unsafe and present a fire risk.

To guarantee quality and safety, look for the Littelfuse name on fuses and fuse packaging.



Current Rating – Amperage

The current rating, marked on every fuse, is the maximum current in amperes that the fuse can continuously carry under specified conditions.



Tip: When selecting a fuse, make sure the current rating of the fuse is the same amperage as the circuit. You can obtain the current rating of a circuit by looking in the owner's manual of the vehicle or checking to see if it is written on the fuse block.

Overfusing and Underfusing

Overfusing is when the fuse has a current rating higher than the rating of the circuit. In this case, the fuse will not be able to protect the circuit properly because the circuit could reach overcurrent levels, causing damage and safety hazards, before the fuse would blow.

Underfusing is when the fuse is rated at a current too far below the rating of the circuit. In this case the fuse will blow, even though the circuit is functioning normally without an overcurrent. Underfusing almost guarantees that a fuse will blow repeatedly. This is referred to as a nuisance blow.

Voltage Rating

The voltage rating, marked on every fuse, indicates the maximum voltage at which the fuse is designed to operate safely if an overcurrent occurs.

Tip: The fuse voltage rating must equal or exceed this circuit voltage where the fuse is installed. This is not a problem in fuse selection because automotive fuse applications are typically around 12 volts, while the voltage rating of the majority of Littelfuse automotive fuses including ATO Fuse, MINI Fuse, MAXI Fuse and MEGA Fuse is 32 volts.



ADDING A CIRCUIT

Always use a circuit protection device with a fuse holder or fuse block whenever adding additional circuits to ensure optimal safety. The fastest, easiest option for installers who need to add a circuit for applications such as electronic components, is the Littelfuse Add-A-Circuit Fuse Holder. Add-A-Circuit, available in ATO® and MINI® blade fuse versions, is designed to facilitate installation of fuses for accessories of 10 amps or less. The Add-A-Circuit adapts the fuse block to the installer's needs, quickly turning one slot in the fuse block into two, providing a safe, economical alternative to splicing or fusetaps.

Caution: Fusetaps are not a recommended alternative for adding circuits because they can overstress the terminals in the fuse block. This situation can create a loose fitting fuse, which in turn produces excessive heat, which can cause nuisance blows, even melting of the fuse and fuse block and possibly an expensive repair in the future. When a fusetap is used, in many cases there is no fuse protecting the new circuit, a condition which can also present a hazard.

Another alternative to adding a circuit is the Littelfuse Battery Power Feed (BPF1). This device attaches directly to the battery terminal, allowing the addition of up to three circuits. Then use an in-line fuse holder to protect the circuit properly.



Retail Information



Planogram

Updated brand packaging introduced in 2015 allowing for easy identification of product families in a retail display.

Littelfuse developed the next generation of Retail Circuit Protection with the ease of product selection as a top priority.

EASY IDENTIFICATION

of product families in color coordinated packages for an easy to use and set up planogram layout.

MORE SPACE

for higher margin kits and assortments.

INCREASE MARKET COVERAGE

with the newest Littelfuse MICRO2®, MICRO3®, MCASE+® and ZCASE® fuses.

**ORIGINAL
EQUIPMENT
MANUFACTURER**

OEM SYMBOL

Prominent on package assures consumers of quality and actual OE replacement.

COLOR CODED

for easier stocking and consumer selection.

MULTI-LINGUAL

One SKU covers US, Canadian, German and Latin American markets.

MATERIAL NUMBER	CATALOG NUMBER	DESCRIPTION
00940477Z	094477	Our 87 SKU, 510-piece pre-pack Plan-O-Gram includes full blade-fuse coverage, as well as expanded coverage into newer parts such as Low-Profile MINI, Low-Profile JCASE, MICRO2, MICRO3, MCASE and Emergency Kits. Includes blade fuses, glass fuses, circuit breakers, Assortment and Emergency kits, fuse holders and fuse tester/pullers. Measures approximately 36"x36".
00940478Z	094478	Our 103 SKU, 625-piece pre-pack Plan-O-Gram is our largest retail assortment featuring multiple facings of the most popular items. This assortment expands your line coverage to fill the needs of your DIY and professional dealer/installer customers as well. Measures approximately 48"x32".

Retail Information

Packaging / Part Numbering

1

Bulk Carton

The outer corrugated cardboard box that holds several cartons.



Carton

The outer corrugated cardboard box that holds several inner packs, or bulk fuses (no inner packs).

Blister Pack

A retail package containing one or several identical products, such as fuses, or it may contain an assortment of fuses. Blister packs are designed to fit on a peg-hook. 'Bubble pack' or 'clamshell' packages are blister packs.

Inner Pack

A small chipboard box containing several blister packs or pillboxes.

Pill Box

A small plastic box containing fuses. Pillboxes are snap-shut resealable.

Fuse Packaging

Standard Fuse Packaging

BOXED MERCHANDISE	PIECES/BOX	STANDARD PACK	ORDER
ATO, MINI Fuses	5 to a box	100 (twenty 5 packs)	by piece
Glass Ceramic Fuses	5 to a box	50 (ten 5 packs)	by piece
AGU Fuses	10 to a box	10 (one 10 pack)	by piece
MAXI, PAL, MEGA, MIDI	1 to a pack	10	by piece
Flashers, Circuit Breakers, Fuse Holders	1 to a pack	10	by piece
RETAIL PACKAGED MERCHANDISE	FUSES/CARD	STANDARD PACK	ORDER
ATO, MINI Fuses, Glass, Ceramic Fuses	5 to a card	5 cards/shelf pack	by card
MAXI, PAL, MEGA, MIDI Fuses	1 to a card	5 cards/shelf pack	by card
Plus Packs	25	5 cards/shelf pack	by card
Retail Carded Kits and Assortments	Various	5 cards/shelf pack	by card
Assortments, Jobber Boards, Merchandisers, etc.	Various	Single unit	by unit

Examples of Order Numbers

Order numbers must have between 9 characters and 15 characters. These are for added description, such as ZXPRO. When you place an order, write or type the characters without a break in the string.

0ATO 010. VP

First set of four
"ATO Fuses"

Second set of four
"10 Amps"

"Retail pack of 5"

0MIN 030. ZXPRO

First set of four
"MINI Fuses"

Second set of four
"30 Amps"

"Professional Pack"

Mandatory Characters

First set of four

These identify the product group, like LMIN (Low profile MINI fuse) or OMAX (MAXI fuses).

Second set of four

These identify the product subgroup. In fuses, this usually identifies the amperage.

The decimal point counts as one character, eg 010. = 10A, 100. = 100A, 01.5 = 1.5A.

9th character

Inner pack quantity. See list of codes below.

Inner Pack Codes

Quantity Code

1 = X	500 = U
5 = V	1,000 = M
10 = T	1,500 = D
20 = S	2,500 = E
50 = L	3,000 = W
100 = H	4,000 = Y
200 = F	5,000 = N
250 = G	10,000 = K

Optional Characters

10th Character

Packaging type. P= Retail pack, B=Blister Pack.

Last set of 5

May be used to give additional information such as, MXGLO for SmartGlow fuses

Blade Fuses

1



MINI® • 2-30A • Standard and Smart Glow Blade Fuses

The MINI fuse is quickly becoming the new standard for vehicle circuit protection. Its miniature design meets the need for more circuits to be protected while utilizing less space, and its ability to cope with high temperatures in adverse environments makes the MINI fuse the recommended choice for protection. Smart Glow fuses are innovative automotive style fuses that feature an indicator light that glows when the fuse is blown, saving time to troubleshoot an open circuit.

Additional information: littelfuse.com/MINI

Standard: Voltage Rating Characteristics: 32V AC/DC Fast-Acting, Approvals: UL listed, SAE J2077.

Smart Glow: Interrupting Rating: 1000A @ 32V DC, Voltage Rating: 32V DC, Operating Temperature Range: -40°C to +125°C, Terminals: Tin plated zinc



COLOR CODE	CURRENT RATING (A)	BOXED	CARDED	CARDED PLUS PACK	CARDED
		MATERIAL NUMBER	PACKAGING MATERIAL NUMBER	PACKAGING MATERIAL NUMBER	PACKAGING MATERIAL NUMBER
Gray	2	OMIN002.V	OMIN002.VP	-	-
Violet	3	OMIN003.V	OMIN003.VP	-	OMIN003.VPGLO
Pink	4	OMIN004.V	OMIN004.VP	-	-
Tan	5	OMIN005.V	OMIN005.VP	-	OMIN005.VPGLO
Brown	7.5	OMIN07.5V	OMIN07.5VP	-	OMIN07.5VPGLO
Red	10	OMIN010.V	OMIN010.VP	OMIN010.ZXPRO	OMIN010.VPGLO
Blue	15	OMIN015.V	OMIN015.VP	OMIN015.ZXPRO	OMIN015.VPGLO
Yellow	20	OMIN020.V	OMIN020.VP	OMIN020.ZXPRO	OMIN020.VPGLO
Clear	25	OMIN025.V	OMIN025.VP	OMIN025.ZXPRO	OMIN025.VPGLO
Green	30	OMIN030.V	OMIN030.VP	OMIN030.ZXPRO	OMIN030.VPGLO

Dimensions MINI®

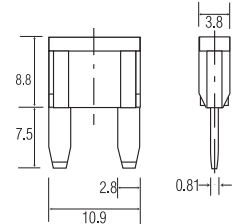

Dimensions SMART GLOW MINI®

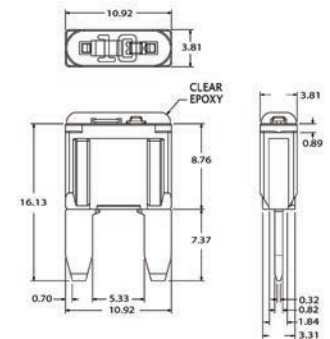

Low Profile MINI® • 2-30A • Blade Fuses

The Low Profile MINI fuse is designed to mate with tuning-fork terminals, which provides additional weight and material savings in fuse box designs by eliminating the need for female box terminals.

Additional information: littelfuse.com/LPMINI

Voltage Rating: 58V DC, Interrupting Rating: 1000A @ 58V DC, Operating Temperature Range: -40°C to +125°C, Terminals: Silver plated zinc, Housing Materials: Nylon composite



COLOR CODE	CURRENT RATING (A)	BOXED	CARDED	CARDED PLUS PACK
		MATERIAL NUMBER	PACKAGING MATERIAL NUMBER	PACKAGING MATERIAL NUMBER
Gray	2	LMIN002.V	-	-
Tan	5	LMIN005.V	LMIN005.VP	LMIN005.ZXPROA
Brown	7.5	LMIN07.5V	-	-
Red	10	LMIN010.V	LMIN010.VP	LMIN010.ZXPROA
Blue	15	LMIN015.V	LMIN015.VP	LMIN015.ZXPROA
Yellow	20	LMIN020.V	LMIN020.VP	LMIN020.ZXPROA
Clear	25	LMIN025.V	LMIN025.VP	LMIN025.ZXPROA
Green	30	LMIN030.V	LMIN030.VP	LMIN030.ZXPROA

Dimensions Low Profile MINI®

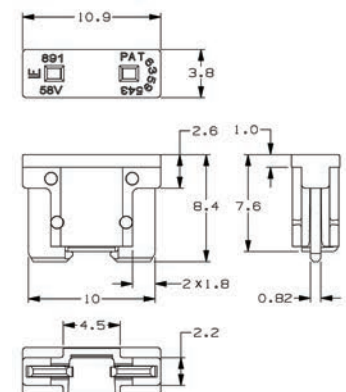

Blade Fuses



ATO® • Autofuse® • 1-40A • Standard and Smart Glow Blade Fuses

The ATO fuse is currently found on most cars, trucks, buses and off the road vehicles worldwide. Features Littelfuse designed industry standard color coding to indicate amp rating. Smart Glow fuses are innovative automotive style fuses that feature an indicator light that glows when the fuse is blown, saving time to troubleshoot an open circuit. Additional information: littelfuse.com/ATO

Standard: Voltage Rating Characteristics: 32V AC/DC Fast-Acting Approvals: UL listed, SAE J2077.

Smart Glow: Interrupting Rating: 1000A @ 32V DC Voltage Rating: 32V DC Operating Temperature Range: -40°C to +125°C Terminals: Tin plated zinc



COLOR CODE	CURRENT RATING (A)	BOXED	CARDED	CARDED PLUS PACK	CARDED
		MATERIAL NUMBER	PACKAGING MATERIAL NUMBER	PACKAGING MATERIAL NUMBER	PACKAGING MATERIAL NUMBER
Black	1	OATO001.V	OATO001.VP	-	-
Gray	2	OATO002.V	OATO002.VP	-	-
Violet	3	OATO003.V	OATO003.VP	-	OATO003.VPGLO
Pink	4	OATO004.V	OATO004.VP	-	-
Tan	5	OATO005.V	OATO005.VP	OATO005.ZXPRO	OATO005.VPGLO
Brown	7.5	OATO007.5V	OATO007.5VP	OATO007.5ZXPRO	OATO007.5VPGLO
Red	10	OATO010.V	OATO010.VP	OATO010.ZXPRO	OATO010.VPGLO
Blue	15	OATO015.V	OATO015.VP	OATO015.ZXPRO	OATO015.VPGLO
Yellow	20	OATO020.V	OATO020.VP	OATO020.ZXPRO	OATO020.VPGLO
Clear	25	OATO025.V	OATO025.VP	OATO025.ZXPRO	OATO025.VPGLO
Green	30	OATO030.V	OATO030.VP	OATO030.ZXPRO	OATO030.VPGLO
Orange	40	OATO040.V	OATO040.VP	-	-

Dimensions ATO®

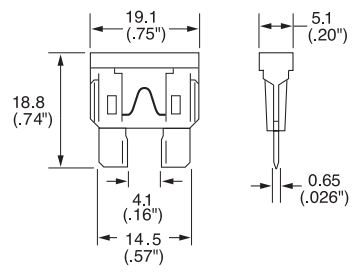

Dimensions SMART GLOW ATO®

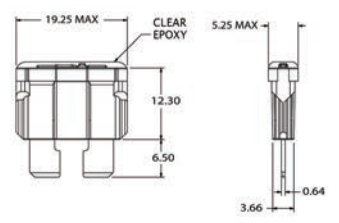

MAXI • 20-100A • Standard and Smart Glow Blade Fuses

MAXI Fuses are primarily used for under hood applications and are produced with a high temperature polymer and silver plated blades. They replace the commonly used fusible wire or fusible link to protect a high current segment or system of the wiring harness. Features Littelfuse designed industry standard color coding to indicate amp rating. Smart Glow fuses are innovative automotive style fuses that feature an indicator light that glows when the fuse is blown, saving time to troubleshoot an open circuit.

Additional information: littelfuse.com/MAXI

Standard: Voltage Rating: 32V DC, Interrupting Ratings: 1000A @ 32V DC, Operating Temperature Range: -40°C to +125°C, Terminals: Silver plated

Smart Glow: Voltage Rating: 32V DC, Interrupting Ratings: 1000A @ 32V DC, Operating Temperature Range: -40°C to +125°C, Terminals: Silver plated



COLOR CODE	CURRENT RATING (A)	BOXED	CARDED	CARDED
		MATERIAL NUMBER	PACKAGING MATERIAL NUMBER	PACKAGING MATERIAL NUMBER
Yellow	20	OMAX020.X	OMAX020.XP	OMAX020.XPGLO
Green	30	OMAX030.X	OMAX030.XP	OMAX030.XPGLO
Orange	40	OMAX040.X	OMAX040.XP	OMAX040.XPGLO
Red	50	OMAX050.X	OMAX050.XP	OMAX050.XPGLO
Blue	60	OMAX060.X	OMAX060.XP	OMAX060.XPGLO
Tan	70	OMAX070.X	-	OMAX070.XPGLO
Clear	80	OMAX080.X	OMAX080.XP	OMAX080.XPGLO
Purple	100	-	-	OMAX100.XPGLO

Dimensions MAXI

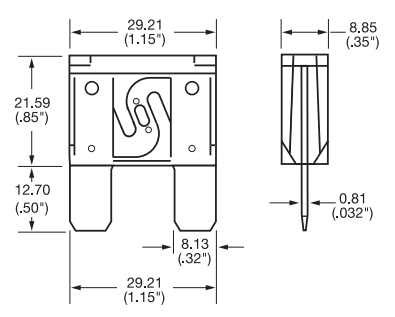

Blade Fuses

1



MICR02® • 5-30A • Blade Fuses

Its sub-miniature design meets the need for more circuits to be protected while utilizing less space and its ability to cope with high temperatures in adverse environments makes the MICR02 Fuse the recommended choice for protection.

Additional information: littelfuse.com/MICR02

Voltage Rating: 32V DC, Interrupting Ratings: 1000A @ 32V DC, Operating Temperature Range: -40°C to +125°C

COLOR CODE	CURRENT RATING (A)	BULK 50-PC	BOXED 25-PC	BOXED 5-PC	CARDED 5-PC
		MATERIAL NUMBER	MATERIAL NUMBER	MATERIAL NUMBER	MATERIAL NUMBER
Tan	5	0327005.LXS	–	MIC2005.V	MIC2005.VP
Brown	7.5	032707.5LXS	–	MIC207.5V	MIC207.5VP
Red	10	0327010.LXS	MIC2010.ZXPRO	MIC2010.V	MIC2010.VP
Blue	15	0327015.LXS	MIC2015.ZXPRO	MIC2015.V	MIC2015.VP
Yellow	20	0327020.LXS	MIC2020.ZXPRO	MIC2020.V	MIC2020.VP
Clear	25	0327025.LXS	–	MIC2025.V	MIC2025.VP
Green	30	0327030.LXS	MIC2030.ZXPRO	MIC2030.V	MIC2030.VP

Dimensions MICR02®



MICR03® • 5-15A • Blade Fuses

The MICR03 Fuse is the new standard for vehicle circuit protection. The MICR03 Fuse has 3 terminals and 2 fuse elements with a common center terminal. Its sub-miniature design meets the need for more circuits to be protected while utilizing less space and its ability to cope with high temperatures in adverse environments makes the MICR03 Fuse the recommended choice for protection.

Additional information: littelfuse.com/MICR03

Voltage Rating: 32V DC, Interrupting Ratings: 1000A @ 32V DC, Operating Temperature Range: -40°C to +125°C

COLOR CODE	CURRENT RATING (A)	BULK 50-PC	BOXED 25-PC	BOXED 5-PC	CARDED 5-PC
		MATERIAL NUMBER	MATERIAL NUMBER	MATERIAL NUMBER	MATERIAL NUMBER
Tan	5	0337005.LXS	MIC3005.ZXPRO	MIC3005.V	MIC3005.VP
Brown	7.5	033707.5LXS	MIC307.5ZXPRO	MIC307.5V	MIC307.5VP
Red	10	0337010.LXS	MIC3010.ZXPRO	MIC3010.V	MIC3010.VP
Blue	15	0337015.LXS	MIC3015.ZXPRO	MIC3015.V	MIC3015.VP

Dimensions MICR03®

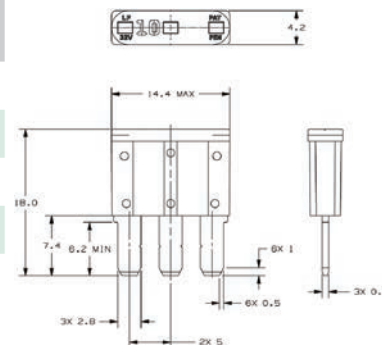

Cartridge Fuses

JCASE® • 20-60A • Cartridge Fuses

Smaller space saving footprint is being designed in by many OEM's. Patented technology provides both increased time delay and low voltage drop. Features ANSI standard OCR-A font for visual inspection systems, double spring-beam box terminal and unique secondary locking feature holds terminal firmly in place. Additional information: littelfuse.com/JCASE

Voltage Rating Characteristics: 32V AC/DC Slo-Blo®, Interrupting Ratings: 1000A @ 32V DC, Operating Temperature Range: -40°C to +125°C, Insertion Force: 53N max. (12lb), Extraction Force: 9N min. (2lb)

COLOR CODE	CURRENT RATING (A)	BOXED	CARDED
		MATERIAL NUMBER	PACKAGING MATERIAL NUMBER
Blue	20	JCAS020.X	JCAS020.XP
White	25	JCAS025.X	JCAS025.XP
Pink	30	JCAS030.X	JCAS030.XP
Green	40	JCAS040.X	JCAS040.XP
Red	50	JCAS050.X	JCAS050.XP
Yellow	60	JCAS060.X	JCAS060.XP

Dimensions JCASE®



Low Profile JCASE® • 20-60A • Cartridge Fuses

Smaller space saving footprint is being designed in by many OEM's. Patented technology provides both increased time delay and low voltage drop. Features ANSI standard OCR-A font for visual inspection systems, double spring-beam box terminal and unique secondary locking feature holds terminal firmly in place. Additional information: littelfuse.com/LPJCASE

Voltage Rating: 58V DC, Interrupting Rating: 1000A @ 58V DC, Operating Temperature Range: -40°C to +125°C, Insertion Force: 53N Max. (12 lb.), Extraction Force: 9N Min (2 lb.)

COLOR CODE	CURRENT RATING (A)	BOXED	CARDED
		MATERIAL NUMBER	PACKAGING MATERIAL NUMBER
Blue	20	LJCA020.X	LJCA020.XP
White	25	LJCA025.X	LJCA025.XPA
Pink	30	LJCA030.X	LJCA030.XP
Green	40	LJCA040.X	LJCA040.XP
Red	50	LJCA050.X	LJCA050.XP
Yellow	60	LJCA060.X	LJCA060.XP

Dimensions Low Profile JCASE®

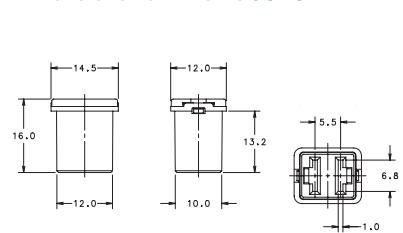

MCASE+® • 15-60A • Cartridge Fuses

The Unslotted MCASE+ Fuse is a cartridge style fuse up to 40A with female terminals for 2.8 mm male terminals. The Slotted MCASE+ Fuse is available up to 60A and can mate with larger male terminals (e.g., 6.3mm) or even mount directly to onto a busbar. Miniaturized footprint for optimal usage of space, featuring time delay and the ability to handle inrush currents. Additional information: littelfuse.com/MCASE

Voltage Rating: 32V DC, Interrupting Ratings: 1000A @ 32V DC, Operating Temperature Range: -40°C to +125°C Fuse Insertion Force: 50N (11.2lb) Typical, Extraction Force: 4N Min. (0.9 lb.) | 24.5N Max. (5.5 lb)

Dimensions MCASE+®

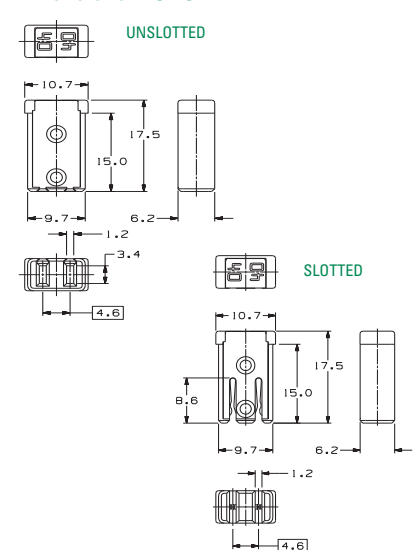

	COLOR CODE	CURRENT RATING (A)	BULK 500-PC	BOXED 50-PC	BOXED 5-PC	CARDED 1-PC
			MATERIAL NUMBER	MATERIAL NUMBER	MATERIAL NUMBER	MATERIAL NUMBER
UNSLOTTED	Gray	15	0695015.U	0695015.LPXP	MCAS015.V	MCAS015.XP
	Blue	20	0695020.U	0695020.LPXP	MCAS020.V	MCAS020.XP
	White	25	0695025.U	0695025.LPXP	MCAS025.V	MCAS025.XP
	Pink	30	0695030.U	0695030.LPXP	MCAS030.V	MCAS030.XP
	Green	40	0695040.U	0695040.LPXP	MCAS040.V	MCAS040.XP
SLOTTED	COLOR CODE	CURRENT RATING (A)	BULK 500-PC	BOXED 50-PC	BOXED 5-PC	CARDED 1-PC
			MATERIAL NUMBER	MATERIAL NUMBER	MATERIAL NUMBER	MATERIAL NUMBER
	Gray	15	0695015.US	0695015.LPXPS	MCAS015.VS	MCAS015.XPS
	Blue	20	0695020.US	0695020.LPXPS	MCAS020.VS	MCAS020.XPS
	White	25	0695025.US	0695025.LPXPS	MCAS025.VS	MCAS025.XPS
	Pink	30	0695030.US	0695030.LPXPS	MCAS030.VS	MCAS030.XPS
	Green	40	0695040.US	0695040.LPXPS	MCAS040.VS	MCAS040.XPS
Red	50	0695050.US	0695050.LPXPS	MCAS050.VS	MCAS050.XPS	
Yellow	60	0695060.US	0695060.LPXPS	MCAS060.VS	MCAS060.XPS	

* Please inquire about additional bulk quantities

Bolt-Down Fuses

1



MEGA® • 80-500A • Bolt-Down Fuses

Littelfuse patented fuse designed for high current protection up to 500A found on many OEM vehicles. Slo-Blo® feature eliminates nuisance blowing during temporary, short duration overloads. Commonly used for battery and alternator connections and other heavy gauge cables requiring ultra high current protection. Also available with a clear housing, M6 mounting hole, single mounting hole or silver plating. For details, contact Littelfuse or visit: littelfuse.com/MEGA
Voltage Rating Characteristics: 32V AC/DC, Slo-Blo®

Dimensions MEGA®



CURRENT RATING (A)	BOXED 50-PC	BOXED 1-PC	CARDED
	MATERIAL NUMBER	MATERIAL NUMBER	MATERIAL NUMBER
80	—	OMEG080.X	OMEG080.XPA
100	OMEG100.L	OMEG100.X	OMEG100.XP
125	OMEG125.L	OMEG125.X	OMEG125.XP
150	OMEG150.L	OMEG150.X	OMEG150.XP
175	OMEG175.L	OMEG175.X	OMEG175.XP
200	OMEG200.L	OMEG200.X	OMEG200.XP
225	OMEG225.L	OMEG225.X	OMEG225.XP
250	OMEG250.L	OMEG250.X	OMEG250.XP
300	OMEG300.L	OMEG300.X	—
350	OMEG350.L	OMEG350.X	—
400	OMEG400.L	OMEG400.X	—
450	OMEG450.L	OMEG450.X	—
500	OMEG500.L	OMEG500.X	—



MIDI® • 30-200A • Bolt-Down Fuses

Littelfuse patented fuse found on many OEM vehicles. Slo-Blo® feature eliminates nuisance blowing during temporary, short duration overloads. Also available with a clear housing, M6 mounting hole, single mounting hole or silver plating. For details, contact Littelfuse or visit: littelfuse.com/MIDI
Voltage Rating Characteristics: 32V AC/DC, Slo-Blo®

Dimensions MIDI®



CURRENT RATING (A)	BULK 10-PC	BOXED	CARDED
	MATERIAL NUMBER	MATERIAL NUMBER	MATERIAL NUMBER
30	0498030.TXN	—	—
40	0498040.TXN	—	—
50	0498050.TXN	0MID050.X	0MID050.XP
60	0498060.TXN	—	—
70	0498070.TXN	—	—
80	0498080.TXN	0MID080.X	0MID080.XP
100	0498100.TXN	—	—
125	0498125.TXN	—	—
150	0498150.TXN	—	0MID150.XP
200	0498200.TXN	—	—

ZCASE® • 40-600A • Bolt-Down Fuses

Designed for a one bolt connection M6 (125-250A) or M8 (300-600A) and can be used directly on a battery post or busbar connection. Additional information: littelfuse.com/ZCASE
Voltage Rating Characteristics: 32V AC/DC, Slo-Blo®

Dimensions ZCASE®



CURRENT RATING (A)	BULK 480-PC	BULK 100-PC	CARDED
	MATERIAL NUMBER	MATERIAL NUMBER	MATERIAL NUMBER
40	3298040.Z	3298040.H	—
60	3298060.Z	3298060.H	—
80	3298080.Z	3298080.H	ZCAS080.XP
100	3298100.Z	3298100.H	ZCAS100.XP
125	3298125.Z	3298125.H	ZCAS125.XP
150	3298150.Z	3298150.H	ZCAS150.XP
175	3298175.Z	3298175.H	ZCAS175.XP
200	3298200.Z	3298200.H	ZCAS200.XP
225	3298225.Z	3298225.H	ZCAS225.XP
250	3298250.Z	3298250.H	ZCAS250.XP
300	3298300.ZXSTA	3298300.H	ZCAS300.XP
350	3298350.ZXSTA	3298350.H	ZCAS350.XP
400	3298400.ZXSTA	3298400.H	ZCAS400.XP
500	3298500.ZXSTA	3298500.H	ZCAS500.XP
600	3298600.ZXSTA	3298600.H	—

Auto Link Fuses



PAL Auto Link Fuses

Commonly found on many Japanese and Domestic built vehicles in current ratings up to 140 amperes. Available with female connector, male connector, bent connector and locking female connector. Color coded to indicate amp rating.

Additional information: littelfuse.com/PAL

PAL Female Terminal



COLOR CODE	CURRENT RATING (A)	BOXED	CARDED
		MATERIAL NUMBER	PACKAGING MATERIAL NUMBER
Blue	20	OPAL020.X	OPAL020.XP
Pink	30	OPAL030.X	OPAL030.XP
Green	40	OPAL040.X	OPAL040.XP
Red	50	OPAL050.X	OPAL050.XP
Yellow	60	OPAL060.X	OPAL060.XP



PAL MINI® Female Terminal

COLOR CODE	CURRENT RATING (A)	BOXED	CARDED
		MATERIAL NUMBER	PACKAGING MATERIAL NUMBER
Pink	30A	OPAL330.X	OPAL330.XP
Green	40A	OPAL340.X	OPAL340.XP



PAL Straight Male Terminal



COLOR CODE	CURRENT RATING (A)	BOXED	CARDED
		MATERIAL NUMBER	PACKAGING MATERIAL NUMBER
Pink	30	OPAL130.X	OPAL130.XP
Yellow	60	OPAL160.X	OPAL160.XP
Black	80	OPAL180.X	OPAL180.XP
Blue	100	OPAL1100X	OPAL1100XP
Gray	120	OPAL1120X	OPAL1120XP



PAL 9/16" Bent Male Terminal

COLOR CODE	CURRENT RATING (A)	BOXED	CARDED
		MATERIAL NUMBER	PACKAGING MATERIAL NUMBER
Pink	30	OPAL430.X	OPAL430.XP
Green	40	OPAL440.X	OPAL440.XP
Red	50	OPAL450.X	OPAL450.XP
Black	80	OPAL480.X	OPAL480.XP
Blue	100	OPAL4100X	OPAL4100XP
White	120	–	OPAL4120XP
Purple	140	–	OPAL4140XP



PAL 13/16" Bent Male Terminal

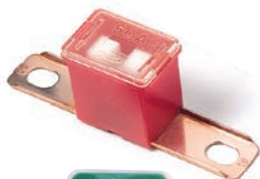

COLOR CODE	CURRENT RATING (A)	BOXED	CARDED
		MATERIAL NUMBER	PACKAGING MATERIAL NUMBER
Pink	30	OPAL230.X	OPAL230.XP
Green	40	OPAL240.X	OPAL240.XP
Red	50	OPAL250.X	OPAL250.XP
Yellow	60	OPAL260.X	OPAL260.XP
Brown	70	OPAL270.X	OPAL270.XP
Black	80	OPAL280.X	OPAL280.XP
Blue	100	OPAL2100X	OPAL2100XP
Gray	120	OPAL2120X	OPAL2120XP
Purple	140	–	OPAL2140XP



PAL Locking Female Terminal

COLOR CODE	CURRENT RATING (A)	BOXED	CARDED
		MATERIAL NUMBER	PACKAGING MATERIAL NUMBER
Brown	25	OPAL525.X	OPAL525.XP
Green	30	OPAL530.X	OPAL530.XP



Glass Fuses

1



AG • Glass Fuses

Originally stood for "all glass." The automotive industry uses the "AG" prefix (AGC, AGW) for most glass fuses. They vary in length, diameter and amperage rating.

Additional information: littelfuse.com/Glass

Voltage Rating: 32V AC/DC, 250V may be substituted

CURRENT RATING (A)	BOXED	CARDED
	MATERIAL NUMBER	PACKAGING MATERIAL NUMBER
AGA (1AG)		
1	0AGA001.V	0AGA001.VP
2	0AGA002.V	0AGA002.VP
3	0AGA003.V	0AGA003.VP
5	0AGA005.V	0AGA005.VP
6	0AGA006.V	-
7.5	0AGA007.5V	-
10	0AGA010.V	0AGA010.VP
15	0AGA015.V	0AGA015.VP
20	0AGA020.V	0AGA020.VP
25	0AGA025.V	-
30	0AGA030.V	0AGA030.VP
AGW (7AG)		
1	0AGW001.V	-
1.5	0AGW01.5V	-
2.5	0AGW02.5V	-
3	0AGW003.V	-
4	0AGW004.V	-
5	0AGW005.V	0AGW005.VP
6	0AGW006.V	-
15	0AGW015.V	0AGW015.VP
20	0AGW020.V	0AGW020.VP
30	0AGW030.V	0AGW030.VP

CURRENT RATING (A)	BOXED	CARDED
	MATERIAL NUMBER	PACKAGING MATERIAL NUMBER
AGC (3AG)		
.5	0AGC.500V	-
1	0AGC001.V	0AGC001.VP
1.5	0AGC01.5V	0AGC01.5VP
2	0AGC002.V	0AGC002.VP
2.5	0AGC02.5V	0AGC02.5VP
3	0AGC003.V	0AGC003.VP
4	0AGC004.V	0AGC004.VP
5	0AGC005.V	0AGC005.VP
6	0AGC006.V	0AGC006.VP
7.5	0AGC07.5V	0AGC07.5VP
8	0AGC008.V	-
10	0AGC010.V	0AGC010.VP
15	0AGC015.V	0AGC015.VP
20	0AGC020.V	0AGC020.VP
25	0AGC025.V	0AGC025.VP
30	0AGC030.V	0AGC030.VP
35	0AGC035.V	0AGC035.VP

CURRENT RATING (A)	BOXED	CARDED
	MATERIAL NUMBER	PACKAGING MATERIAL NUMBER
AGU (5AG)		
10	0AGU010.T	-
15	0AGU015.T	-
20	0AGU020.T	-
25	0AGU025.T	-
30	0AGU030.T	-
35	0AGU035.T	-
40	0AGU040.T	0AGU040.VPG
50	0AGU050.T	0AGU050.VPG
60	0AGU060.T	0AGU060.VPG
AGX (8AG)		
20	-	0AGX020.VP
25	-	0AGX025.VP
30	-	0AGX030.VP

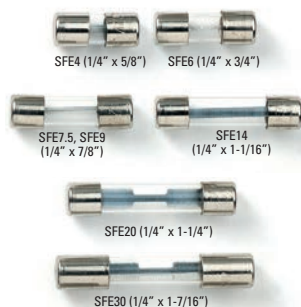

SFE • Glass Fuses

Glass fuses designed to specifications set by the Society of Fuse Engineers. All are 1/4 inch in diameter, but vary in length according to the ampere rating to ensure accurate fuse replacement.

Voltage Rating: 32V AC/DC, 250V may be substituted

Additional information: littelfuse.com/Glass

CURRENT RATING (A)	BOXED	CARDED
	MATERIAL NUMBER	PACKAGING MATERIAL NUMBER
4	0SFE004.V	0SFE004.VP
6	0SFE006.V	0SFE006.VP
7.5	0SFE07.5V	0SFE07.5VP
9	0SFE009.V	0SFE009.VP
14	0SFE014.V	0SFE014.VP
20	0SFE020.V	0SFE020.VP
30	0SFE030.V	0SFE030.VP



GBC • Torpedo Fuse

A thermoplastic type, torpedo shaped fuse that can be currently found in many European cars. Consisting of a heat resistant body, the fuse element stretches over the exterior of the body from end to end. The bodies vary in color (by amperage) to ensure proper replacement.

Voltage Rating: 32V AC/DC, 250V may be substituted

Additional information: littelfuse.com/Glass

CURRENT RATING (A)	BOXED	CARDED
	MATERIAL NUMBER	PACKAGING MATERIAL NUMBER
5	0GBC005.V	-
8	0GBC008.V	0GBC008.VP
16	0GBC016.V	0GBC016.VP
25	0GBC025.V	0GBC025.VP

Specialty Fuse Products

CNNe, CNN, CNL Forklift Type Fuses

CNNe fuses are rated for applications up to 80V DC. As fork lift trucks voltages increase, circuit protection needs to be rated higher to handle the increased voltage. The 80V CNN_E and 48V CNN are considered very fast-acting for quicker reaction time, the 32V CNL fuses are fast-acting.

- Voltage Rating: CNL: 32V DC / 32V AC
CNN: 48V DC / 125V AC
CNNe: 80V DC / 125V AC
- Ampere Range: 10-800A
- Interrupting Rating: 2,500A
- Maximum Torque: 90 lbs

Download additional information: littelfuse.com/CNN



PART NUMBER			PART NUMBER			PART NUMBER		
MATERIAL #	CATALOG #	V DC	MATERIAL #	CATALOG #	V DC	MATERIAL #	CATALOG #	V DC
OCNN035E.V	CNN035E	80	OCNN010.V	CNN010	48	OCNL035.V	CNL035	32
OCNN040E.V	CNN040E	80	OCNN035.V	CNN035	48	OCNL040.V	CNL040	32
OCNN050E.V	CNN050E	80	OCNN040.V	CNN040	48	OCNL050.V	CNL050	32
OCNN060E.V	CNN060E	80	OCNN050.V	CNN050	48	OCNL060.V	CNL060	32
OCNN080E.V	CNN080E	80	OCNN060.V	CNN060	48	OCNL080.V	CNL080	32
OCNN090E.V	CNN090E	80	OCNN080.V	CNN080	48	OCNL100.V	CNL100	32
OCNN100E.V	CNN100E	80	OCNN090.V	CNN090	48	OCNL125.V	CNL125	32
OCNN125E.V	CNN125E	80	OCNN100.V	CNN100	48	OCNL150.V	CNL150	32
OCNN150E.V	CNN150E	80	OCNN125.V	CNN125	48	OCNL175.V	CNL175	32
OCNN175E.V	CNN175E	80	OCNN150.V	CNN150	48	OCNL200.V	CNL200	32
OCNN200E.V	CNN200E	80	OCNN175.V	CNN175	48	OCNL250.V	CNL250	32
OCNN225E.V	CNN225E	80	OCNN200.V	CNN200	48	OCNL275.V	CNL275	32
OCNN250E.V	CNN250E	80	OCNN225.V	CNN225	48	OCNL300.V	CNL300	32
OCNN275E.V	CNN275E	80	OCNN250.V	CNN250	48	OCNL350.V	CNL350	32
OCNN300E.V	CNN300E	80	OCNN275.V	CNN275	48	OCNL400.V	CNL400	32
OCNN325E.V	CNN325E	80	OCNN300.V	CNN300	48	OCNL500.V	CNL500	32
OCNN350E.V	CNN350E	80	OCNN325.V	CNN325	48			
OCNN400E.V	CNN400E	80	OCNN350.V	CNN350	48			
OCNN500E.V	CNN500E	80	OCNN400.V	CNN400	48			
OCNN600E.V	CNN600E	80	OCNN500.V	CNN500	48			
OCNN700E.V	CNN700E	80	OCNN600.V	CNN600	48			
OCNN800E.V	CNN800E	80	OCNN700.V	CNN700	48			
			OCNN800.V	CNN800	48			

160/300V DC • 1-1200A • UL Class T • JLLN & JLLS Series Fuses

- Voltage Rating: JLLN: 160V DC (1-60A) • 125V DC (70-1200A except 900A)
JLLS: 300V DC (1-1200A)

Download technical information at: littelfuse.com/JLLN or littelfuse.com/JLLS



CURRENT RATING (A)	JLLN			JLLS			CURRENT RATING (A)	JLLN			JLLS		
	V DC	MATERIAL NUMBER	V DC	MATERIAL NUMBER	PACK SIZE	V DC		MATERIAL NUMBER	V DC	MATERIAL NUMBER	PACK SIZE		
1	160	JLLN001.T	300	JLLS001.T	10	125	125	JLLN125.X	300	JLLS125.X	1		
2	160	JLLN002.T	300	JLLS002.T	10	150	125	JLLN150.X	300	JLLS150.X	1		
3	160	JLLN003.T	300	JLLS003.T	10	175	125	JLLN175.X	300	JLLS175.X	1		
6	160	JLLN006.T	300	JLLS006.T	10	200	125	JLLN200.X	300	JLLS200.X	1		
10	160	JLLN010.T	300	JLLS010.T	10	225	125	JLLN225.X	300	JLLS225.X	1		
15	160	JLLN015.T	300	JLLS015.T	10	250	125	JLLN250.X	300	JLLS250.X	1		
20	160	JLLN020.T	300	JLLS020.T	10	300	125	JLLN300.X	300	JLLS300.X	1		
25	160	JLLN025.T	300	JLLS025.T	10	350	125	JLLN350.X	300	JLLS350.X	1		
30	160	JLLN030.T	300	JLLS030.T	10	400	125	JLLN400.X	300	JLLS400.X	1		
35	160	JLLN035.T	300	JLLS035.T	10	450	125	JLLN450.X	300	JLLS450.X	1		
40	160	JLLN040.T	300	JLLS040.T	10	500	125	JLLN500.X	300	JLLS500.X	1		
45	160	JLLN045.T	300	JLLS045.T	10	600	125	JLLN600.X	300	JLLS600.X	1		
50	160	JLLN050.T	300	JLLS050.T	10	700	125	JLLN700.X	300	JLLS700.X	1		
60	160	JLLN060.T	300	JLLS060.T	10	800	125	JLLN800.X	300	JLLS800.X	1		
70	125	JLLN070.V	300	JLLS070.V	5	900	-	-	300	JLLS900.X	1		
80	125	JLLN080.V	300	JLLS080.V	5	1000	125	JLLN1000X	300	JLLS1000X	1		
90	125	JLLN090.V	300	JLLS090.V	5	1100	125	JLLN1100X	300	JLLS1100X	1		
100	125	JLLN100.V	300	JLLS100.V	5	1200	125	JLLN1200X	300	JLLS1200X	1		
110	125	JLLN110.X	300	JLLS110.X	1								

Honda, Volkswagen and Universal Fusible Links

Honda

Fusible links fit Honda Civics fusible link bar. Available in 45, 55 & 65A. Carded merchandise only available in 3 piece assortment 094413.

Volkswagen

Fusible links fit Volkswagen and Universal fusible link bars. Available in 30, 40, 50, 60, 80, 110, 150 & 175 amp fuse bars.

Universal

Fusible links are OEM replacement fusible link bars. Available in 30, 50, 80 & 100A.



CARDERD PART NUMBER		DESCRIPTION
MATERIAL NUMBER	CATALOG NUMBER	
00940413ZP	094413	Fusible Link assortment - fits Honda™ vehicles
00940402ZP	0940402	Fusible Link assortment - fits Volkswagen™ vehicles
OFLC014.XP	FLC14BP	Fusible Link 14 AWG
OFLW014.XP	FLW14BP	Fusible Link 14 AWG with Terminals
OFLW016.XP	FLW16BP	Fusible Link 16 AWG with Terminals

Assortment Kits

Value Pack Kits

1

The Littelfuse Value Packs contain a complete assortment of OEM fuses. Value Packs give you the tools for the protection you need — when and where you need it! The Ultimate fuse kit for home and repair shop comes in a clear plastic, reusable package.



MATERIAL NUMBER	CATALOG NUMBER	DESCRIPTION
00940400Z	094400	ATO Super Value Pack 40pc
00940462Z	094462	MINI Super Value Pack 40pc
00940475Z	094475	ATO , MINI, MAXI Super Value Pack 21pc
00940550Z	094550	MINI /JCASE Super Value Pack 29pc
00940554Z	—	Low Profile MINI / Low Profile JCASE Super Value Pack 30pc
00940557ZXA	—	AGC Glass Super Value Pack 40pc
00940566ZXA	—	MICRO2/MICRO3 Super Value Pack 60pc

Fuse Assortment Kits

Littelfuse assortments contain a variety of a specific fuse type in assorted amperages.



MATERIAL NUMBER	CATALOG NUMBER	DESCRIPTION	CONTENTS
00940133ZP	94133	European Fuse Assortment	2 each: GBC 8A, 16A Fuses & 1 each: GBC 25 A
00940134ZP	94134	British Fuse Assortment	1 each: AGC 7.5A, 15A, 20A (SFE 20) 1 each: 03000128M Amp Fuses
00940135ZP	94135	Japanese Fuse Assortment	1 each: AGC 5A, 10A, 15A, 20A (SFE 20), 30A Fuses
00940154ZP	94154	American Fuse Assortment	1 each: AGC 10A, 15A, 30A & 1 each: SFE 9A, 14A, 20A Fuses
00940189ZP	94189	Cellular Fuse Assortment	1 each: AGC 1.5A, 3A Fuses & 3 each: AGC 2A Fuses
00940202ZP	94202	ATO Fuse Assortment 6pc	1 each: ATO 5A, 10A, 15A, 20A, 25A, 30A Fuses
00940301ZP	94301	Japanese ATO Fuse Assortment	1 each: ATO 5A, 7.5A, 10A, 15A, 20A Fuses
00940362ZP	94362	MINI Fuse Assortment	1 each: MINI 3A, 5A, 7.5A, 10A, 15A, 20A, 25A, 30A
00940408ZP	94408	Computer Fuse Assortment	1 each: AGC .5A Fuses & 2 each: AGC 1A, 2A Fuses
00940506ZP	94506	Low Profile MINI Fuse Assortment	1 each: LMIN 7.5A, 10A, 15A, 20A, 25A, 30A Fuses
00940558ZPA	94558	MICRO2 Fuse Assortment	1 each: MICRO2 5A, 10A, 15A, 20A, 25A Fuses
00940559ZPA	94559	MCASE Fuse Assortment	1 each: 15A, 20A, 25A, 30A, 40A Fuses
0AGA0001ZP	AGA1ZP	AGA Glass Fuse Assortment	1 each: AGA 1A, 2A, 3A, 5A, 7.5A, 10A, 15A, 20A, 25A, 30A Fuses
0AGA0002ZP	AGA2ZP	AGA Glass Fuse Assortment	1 each: AGA 2A, 3A, 10A Fuses & 2 each: AGA 5A Fuses NEW
0AGA0003ZP	AGA3ZP	AGA Glass Fuse Assortment	1 each: AGA 15A Fuse & 2 each: AGA 20A, 30A Fuses NEW
0AGC0001ZP	AGC1ZP	AGC Glass Fuse Assortment	1 each: AGC 1A, 2A, 2.5A, 3A, 4A, 5A, 6A, 7.5A, 8A, 10A, 15A, 20A, 25A, 30A, 35A Fuses
0AGC0002ZP	AGC2ZP	AGC Glass Fuse Assortment	1 each: AGC 1A, 2A, 2.5A Fuses & 2 each: AGC 3A Fuses NEW
0AGC0003ZP	AGC3ZP	AGC Glass Fuse Assortment	1 each: AGC 4A, 6A, 7.5A Fuses & 2 each: AGC 5A Fuses NEW
0AGC0004ZP	AGC4ZP	AGC Glass Fuse Assortment	1 each: AGC 10A Fuse & 2 each: AGC 15A, 20A Fuses NEW
0AGC0005ZP	AGC5ZP	AGC Glass Fuse Assortment	1 each: AGC 35A Fuse & 2 each: AGC 25A, 30A Fuses NEW
0AGW0001ZP	AGW1ZP	AGW/AGX Glass Fuse Assortment	1 each: AGW 3A, 4A, 5A, 15A, 20A, 30A Fuses 1 each: AGX 3A, 20A, 25A, 30A Fuses
0AGW0002ZP	AGW2ZP	AGW Glass Fuse Assortment	1 each: AGW 5A, 20A, 30A Fuses & 2 each: AGW 15A Fuses NEW
0AGX0002ZP	AGX2ZP	AGX Glass Fuse Assortment	1 each: AGX 25A, 30A Fuses & 3 each: AGX 20A Fuses NEW
OSFE0001ZP	SFE1ZP	SFE Glass Fuse Assortment	1 each: SFE 4A, 6A, 7.5A, 9A Fuses & 2 each: 14A, 20A, 30A Fuses

SMART GLOW Fuse

MATERIAL NUMBER	CATALOG NUMBER	DESCRIPTION	CONTENTS
00940202ZPGL0	10-1008	ATO SmartGlow Assortment 5 pack	1 each: ATO 10A, 15A, 20A, 25A, 30A Fuses
00940362ZPGL0	11-1008	MINI SmartGlow Assortment 5 pack	1 each: MINI 10A, 15A, 20A, 25A, 30A Fuses
00940400ZGL0	14-0000	ATO SmartGlow Assortment 42 pack	7 each: ATO GLO 5A, 10A, 15A, 20A, 25A, 30A Fuses
00940462ZGL0	15-0000	MINI SmartGlow Assortment 36 pack	6 each: MINI GLO 5A, 10A, 15A, 20A, 25A, 30A Fuses
00940555ZPGL0	—	ATO SmartGlow Assortment 5 pack w/ Flashlight	1 each: ATO GLO 10A, 15A, 20A, 25A, 30A Fuses & (1) MINI Keychain LED Flashlight
00940556ZPGL0	094556	MINI SmartGlow Assortment 5 Pack w/ Flashlight	1 each: MINI GLO 10A, 15A, 20A, 25A, 30A Fuses & (1) MINI Keychain LED Flashlight
0AGC0001ZPGL0	16-1008	AGC Glass Assortment 5 pack	1 each: AGC 5A, 10A, 15A, 20A, 30A Fuses
OSFE0001ZPGL0	—	SFE Glass SmartGlow Assortment 5 pack	1 each: SFE 7.5A, 9A, 14A & 2 each: 20A Fuses

Assortment Kits

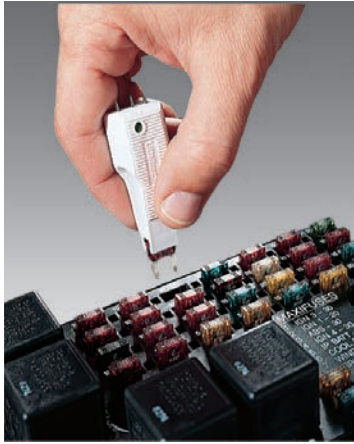

Emergency Kits

Available in OEM ATO and MINI fuse versions. The Littelfuse Emergency Diagnostic Fuse Kits are ideal for the glove box or trunk offering instant protection in the garage or on the road. Contains the most popular amperages.

Includes roadside tester/puller that tests, removes and installs fuses. Has its own power source that allows it to operate with or without voltage to a maximum of 24V DC.



MATERIAL NUMBER	CATALOG NUMBER	DESCRIPTION	CONTENTS
00940363ZP	094363	MINI Emergency Fuse Kit	1 each: MINI 3A, 5A, 7.5A, 10A, 15A, 20A, 25A, 30A Fuses (1) Puller
00940365ZP	094365	Motorcycle Glass Emergency Kit	1 each: AGX 5A, 10A, 15A, 20A Fuses 2 each: AGX 8A Fuses (1) Puller
00940366ZP	094366	Motorcycle ATO Emergency Kit	1 each: ATO 5A, 7.5A, 10A, 15A, 20A Fuses (1) Puller
00940367ZP	094367	American Glass Emergency Kit	1 each: SFE 9A, 14A, 20A 1 each: AGC 5A, 15A, 30A Fuses (1) Puller
00940368ZP	094368	European GBC Emergency Kit	1 each: GBC 5A, 16A, 25A Fuses 2 each: GBC 8A Fuses (1) Puller
00940369ZP	094369	Japanese Glass Emergency Kit	1 each: AGC 5A, 10A, 15A, 20A, 30A Fuses (1) Puller
00940370ZP	094370	ATO Emergency Kit	1 each: ATO 5A, 10A, 15A, 20A, 25A, 30A Fuses (1) Puller
00940418ZP	094418	ATO Emergency Diagnostic Kit	1 each: ATO 5A, 10A, 15A, 20A, 25A, 30A Fuses (1) ATO Puller
00940419ZP	094419	Glass Emergency Fuse Kit	1 each: AGC 7.5, 15A, 20A, 25A, 30A (1) Glass Puller
00940461ZP	094461	MINI Emergency Diagnostic Kit	1 each: MINI 3A, 4A, 7.5A, 10A, 15A, 20A, 25A, 30A Fuses (1) ATO/MINI Tester/Puller
00940479ZP	094479	ATO/MINI Emergency Diagnostic Kit	1 each: ATO 5A, 10A, 15A, 20A, 25A, 30A Fuses 1 each: MINI 3A, 5A, 7.5A, 10A, 15A, 20A, 25A, 30A Fuses (1) Puller
00940441ZP	094441	LP MINI Emergency Fuse Kit	1 each: LP MINI 2A, 5A, 7.5A, 10A, 15A, 20A, 25A, 30A Fuses, (1) Puller
00940442ZP	094442	MCASE, MICRO2, MICRO3 Emergency Kit	1 each: MCASE 15A, 20A, 25A, 30A, 40A Fuses, (1) MCCase Puller 1 each: MICRO2 5A, 7.5A, 10A, 15A, 20A, 25A, 30A Fuses 1 each: MICRO3 5A, 7.5A, 10A, 15A Fuses, (1) MICRO Puller
00940561ZPA	094561	OEM Emergency Kit - GM	1 each: MINI 7.5A, 25A, 30A Fuses 1 each: LP MINI 10A, 15A Fuses 1 each: JCASE 20A, 30A, 40A, 50A Fuses 1 each: LPJCASE 30A, 40A Fuses 2 each: MINI 20A Fuses 3 each: MINI 10A, 15A Fuses
00940562ZPA	094562	OEM Emergency Kit - Ford	1 each: MINI 7.5A, 25A, 30A Fuses 1 each: LP MINI 10A, 15A Fuses 1 each: JCASE 20A, 30A, 40A, 50A Fuses 1 each: LPJCASE 30A, 40A Fuses 2 each: MINI 20A Fuses 3 each: MINI 10A, 15A Fuses
00940563ZPA	094563	OEM Emergency Kit - Chrysler/Dodge/Jeep	1 each: MINI 7.5A, 25A, 30A Fuses 1 each: JCASE 20A, 30A, 40A, 50A Fuses 2 each: MINI 20A Fuses 3 each: MINI 10A, 15A Fuses
00940565ZPA	094565	Toyota/Lexus Emergency Fuse Kit	1 each: MICRO2 5A, 7.5A, 10A, 15A, 20A, 25A, 30A Fuses 1 each: LP MINI 5A, 7.5A, 10A, 15A, 20A, 30A Fuses (2) Pullers NEW
00940566ZPA	094566	Nissan/Infiniti Emergency Fuse Kit	1 each: MICRO2 5A, 10A, 15A, 20A, 30A Fuses 1 each: MINI 2A, 3A, 4A, 5A, 7.5A, 10A, 15A, 20A, 25A, 30A Fuses 1 each: ATO 5A, 7.5A, 10A, 15A, 20A, 30A, 40A Fuses 1 each: MCASE+ 30A, 40A, 60A, Fuses 2 each: MCASE+ 50A Fuses (3) Pullers NEW
00940567ZPA	094567	Volkswagen/Audi Emergency Fuse Kit	1 each: ATO 1A, 2A, 3A, 4A, 5A, 7.5A, 10A, 15A, 20A, 25A, 30A, 40A Fuses 1 each: MINI 2A, 3A, 5A, 7.5A, 10A, 15A, 20A, 25A, 30A Fuses 1 each: JCASE 20A, 25A, 30A, 40A, 50A, 60A Fuses 1 each: HSB 40A, 50A, 80A, 110A, 175A Fuse Strip (2) Pullers NEW
00940569ZPA	094569	Hyundai/Kia/Genesis Emergency Fuse Kit	1 each: MINI 10A, 15A, 20A, 25A, 30A Fuses 1 each: LP MINI 7.5A, 10A, 15A, 20A, 25A, 30A Fuses 1 each: JCASE 30A, 40A, 50A Fuses 1 each: LPJCASE 20A, 30A, 40A Fuses 1 each: MICRO2 10A, 15A, 20A, 25A, 30A Fuses (3) Pullers NEW

Assortment Kits

1

Commercial Assortments

Littelfuse Commercial Assortments cover all of the professional technician's circuit protection needs. Littelfuse offers the most comprehensive circuit protection kits on the market today addressing the needs of the Professional Service Center and Road Service Operation with genuine Littelfuse OEM fuses. Littelfuse Commercial Assortments are designed for the professional installer who needs a larger quantity and variety of fuses at the point of installation. Assortments are packaged in tough plastic storage containers perfect for the parts drawer, tool box, under counter or road service vehicle.

Additional information: littelfuse.com/KitAssortments



ATO® Fuse
80 Piece Commercial Assortment



CARDED	MATERIAL NUMBER	CATALOG NUMBER	CONTENT
	00940409Z	094409	ATO (10-pc): 3A, 5A, 7.5A, 10A, 15A, 20A, 25A, 30A



ATO® / MINI® Fuse
80 Piece Commercial Assortment



CARDED	MATERIAL NUMBER	CATALOG NUMBER	CONTENT
	00940422Z	094422	ATO (10-pc): 15A, 20A, 25A, 30A MINI (10-pc): 15A, 20A, 25A, 30A (1) Puller



MINI® Fuse
80 Piece Commercial Assortment



CARDED	MATERIAL NUMBER	CATALOG NUMBER	CONTENT
	00940551Z	094551	MINI (10-pc): 3A, 5A, 7.5A, 10A, 15A, 20A, 25A, 30A



Low Profile MINI® Fuse
80 Piece Commercial Assortment



CARDED	MATERIAL NUMBER	CATALOG NUMBER	CONTENT
	00940552Z	094552	LPMINI (10-pc): 3A, 5A, 7.5A, 10A, 15A, 20A, 25A, 30A



MICRO2® Fuse
70 Piece Commercial Assortment



CARDED	MATERIAL NUMBER	CATALOG NUMBER	CONTENT
	00940560ZXA	00940560	MICRO2 (10): 5A, 7.5A, 10A, 15A, 20A, 25A, 30A



MICRO2® MICRO3® MCASE® Fuse
135 Piece Commercial Assortment



CARDED	MATERIAL NUMBER	CATALOG NUMBER	CONTENT
	00940570ZXA	00940570	MICRO2 (10): 5A, 7.5A, 10A, 15A, 20A, 25A, 30A MICRO3 (10): 5A, 7.5A, 10, 15A MCASE (5): 15A, 20A, 25A, 30A, 40A



MCASE® Fuse
80 Piece Commercial Assortment



CARDED	MATERIAL NUMBER	CATALOG NUMBER	CONTENT
	00940565ZXA	00940565	MCASE (20): 15A, 20A, 25A, 30A, 40A



JCASE® Fuse
10 Piece Commercial Assortment



CARDED	MATERIAL NUMBER	CATALOG NUMBER	CONTENT
	00940480Z	094480	JCASE (2-pc): 20A, 40A, 50A JCASE (3-pc): 30A - JCASE (1-pc): 60A (1) Puller



Low Profile JCASE® Fuse
16 Piece Commercial Assortment



CARDED	MATERIAL NUMBER	CATALOG NUMBER	CONTENT
	00940553Z	094553	LPJCASE (4-pc): 20A, 30A, 40A LPJCASE (2-pc): 50A, 60A (1) Puller

Assortment Kits

SMART GLOW FUSE®



It glows when it blows.

Smart Glow Commercial Assortments

Littelfuse Commercial Assortments cover the professional technician's circuit protection needs including Smart Glow style fuses. Available in ATO and MINI fuse styles the assortments are packaged in tough plastic storage containers perfect for the parts drawer, tool box, under counter or road service vehicle.

Additional information: littelfuse.com/KitAssortments



**Smart Glow ATO® Blade Fuse
80 Piece Commercial Assortment**



**Smart Glow MINI® Blade Fuse
80 Piece Commercial Assortment**

CARDED	MATERIAL NUMBER	CONTENT
	00940509ZXGLOA	ATO (10-pc): 3A, 5A, 7.5A, 10A, 15A, 20A, 25A, 30A

CARDED	MATERIAL NUMBER	CONTENT
	00940510ZXGLOA	MINI (10-pc): 3A, 5A, 7.5A, 10A, 15A, 20A, 25A, 30A



Professional Fuse Caddy

Provides a complete assortment designed to meet the professional installer's on-the-road fuse needs. Contains 180 of the most popular fuses and installation tools (includes ATO®/MINI® Tester/ Puller) needed to service passenger cars and light trucks, heavy and medium trucks and buses.

Comes in compact handy storage box perfect for the on-the-road vehicle.

Additional information: littelfuse.com/KitAssortments

CARDED	MATERIAL NUMBER	CATALOG NUMBER	CONTENT
	00940396Z	094396	ATO (5-pc): 3A, 5A, 7.5A - ATO (10-pc): 10A, 25A - ATO (15-pc): 15A, 20A, 20A MINI (5-pc): 2A, 3A, 4A, 5A, 7.5A, 10A, 15A, 20A, 25A, 30A AGC (5-pc): 5A, 10A, 15A, 20A, 25A, 30A SFE (5-pc): 14A, 20A, 30A MAXI (1-pc): 20A, 30A, 40A, 50A, 60A (1) Fuse Tester and Puller (1) Tri-puller™ (1) MAXI Fuse Puller

Assortment Kits

1



Red Box™

Designed by Littelfuse, the kit features the exact OEM parts used for the glass, ATO, MINI, LP MINI, MAXI, PAL, JCASE, LP JCASE, MCASE, MICRO2 and MICRO3 fuses installed on over 98% of the cars, vans, light trucks and SUV's on the road today. All come packed inside one compact, portable, organized carrying case. With Red Box, your days of wasting valuable shelf space on redundant part numbers is over. Over 500 fuses inside Red Box meet over 98% of the market's circuit protection needs, giving you more coverage and more profit with a lot less inventory.

Additional information: littelfuse.com/RedBox

KIT Professional Installer Case

MATERIAL NUMBER	CATALOG NUMBER
ORED0BOXZ	REDBOX

KIT Professional Installer Case (No Glass with Module 5)

MATERIAL NUMBER	CATALOG NUMBER
ORED0BOXZNG	REDBOXNG

KIT Professional Installer Case (No Glass with Module 6)

MATERIAL NUMBER
ORED0BOXZNGA

Glass Module (Module 5)

MATERIAL NUMBER	CATALOG NUMBER	
ORBOX005Z	RBOX5	
0AGC001.V	AGC GLASS BOX 1A	10
0AGC002.V	AGC GLASS BOX 2A	10
0AGC003.V	AGC GLASS BOX 3A	10
0AGC004.V	AGC GLASS BOX 4A	10
0AGC005.V	AGC GLASS BOX 5A	10
0AGC006.V	AGC GLASS BOX 6A	10
0AGC007.5V	AGC GLASS BOX 7.5A	10
0AGC010.V	AGC GLASS BOX 10A	10
0AGC015.V	AGC GLASS BOX 15A	10
0AGC020.V	AGC GLASS BOX 20A	10
0AGC025.V	AGC GLASS BOX 25A	10
0AGC030.V	AGC GLASS BOX 30A	10
0AGW030.V	AGW GLASS BOX 30A	10
0AGX030.V	AGX GLASS BOX 30A	10
0SFE004.V	SFE GLASS BOX 4A	10
0SFE009.V	SFE GLASS BOX 9A	10
0SFE014.V	SFE GLASS BOX 14A	10
0SFE020.V	SFE GLASS BOX 20A	10
0SFE030.V	SFE GLASS BOX 30A	10
	Puller Tester	1

Low Profile MINI® Module (Module 1)

MATERIAL NUMBER	CATALOG NUMBER	
ORBOX001Z	RBOX1	
LMIN005.V	5A LOW PROFILE MINI FUSE	5
LMIN07.5V	7.5A LOW PROFILE MINI FUSE	10
LMIN010.V	10A LOW PROFILE MINI FUSE	10
LMIN015.V	15A LOW PROFILE MINI FUSE	10
LMIN020.V	20A LOW PROFILE MINI FUSE	5
LMIN025.V	25A LOW PROFILE MINI FUSE	5
LMIN030.V	30A LOW PROFILE MINI FUSE	10

JCASE® Module (Module 2)

MATERIAL NUMBER	CATALOG NUMBER	
ORBOX002Z	RBOX2	
JCAS020.V	JCASE 32V S/B BOX 20A	2
JCAS030.V	JCASE 32V S/B BOX 30A	2
JCAS040.V	JCASE 32V S/B BOX 40A	2
JCAS050.V	JCASE 32V S/B BOX 50A	2
JCAS060.V	JCASE 32V S/B BOX 60A	2

Blade Fuse Module (Module 3)

MATERIAL NUMBER	CATALOG NUMBER	
ORBOX003Z	RBOX3	
0ATO005.V	ATO BLADE FUSE BOX 5A	10
0ATO07.5V	ATO BLADE FUSE BOX 7.5A	10
0ATO010.V	ATO BLADE FUSE BOX 10A	25
0ATO015.V	ATO BLADE FUSE BOX 15A	25
0ATO020.V	ATO BLADE FUSE BOX 20A	25
0ATO025.V	ATO BLADE FUSE BOX 25A	25
0ATO030.V	ATO BLADE FUSE BOX 30A	25
0ATO040.V	ATO BLADE FUSE BOX 40A	10
0MIN005.V	MINI BLADE FUSE BOX 5A	10
0MIN07.5V	MINI BLADE FUSE BOX 7.5A	10
0MIN010.V	MINI BLADE FUSE BOX 10A	20
0MIN015.V	MINI BLADE FUSE BOX 15A	20
0MIN020.V	MINI BLADE FUSE BOX 20A	20
0MIN025.V	MINI BLADE FUSE BOX 25A	10
0MIN030.V	MINI BLADE FUSE BOX 30A	10
0MAX020.V	MAXI BLADE BOX 20A	2
0MAX030.V	MAXI BLADE BOX 30A	2
0MAX040.V	MAXI BLADE BOX 40A	2
0MAX050.V	MAXI BLADE BOX 50A	2
0MAX060.V	MAXI BLADE BOX 60A	2
0MAX070.V	MAXI BLADE BOX 70A	1
0MAX080.V	MAXI BLADE BOX 80A	1
00970019X	FUSE TESTER AND PULLER BOX	1
FHAC0002Z	ATO HD INLINE FUSE HOLDER BOX	1
0FHM0002Z	MINI HD INLINE FUSE HOLDER BOX	1

PAL Module (Module 4)

MATERIAL NUMBER	CATALOG NUMBER	
ORBOX004Z	RBOX4	
OPAL020.X	FEMALE TERM BOX 20A	1
OPAL030.X	FEMALE TERM BOX 30A	1
OPAL040.X	FEMALE TERM BOX 40A	1
OPAL050.X	FEMALE TERM BOX 50A	1
OPAL060.X	FEMALE TERM BOX 60A	1
OPAL130.X	STRAIGHT MALE TERM BOX 30A	1
OPAL160.X	STRAIGHT MALE TERM BOX 60A	1
OPAL180.X	STRAIGHT MALE TERM BOX 80A	1
OPAL1100.X	STRAIGHT MALE TERM BOX 100A	1
OPAL1120.X	STRAIGHT MALE TERM BOX 120A	1
OPAL230.X	13/16" BENT MALE TERM BOX 30A	1
OPAL240.X	13/16" BENT MALE TERM BOX 40A	1
OPAL250.X	13/16" BENT MALE TERM BOX 50A	1
OPAL260.X	13/16" BENT MALE TERM BOX 60A	1
OPAL270.X	13/16" BENT MALE TERM BOX 70A	1
OPAL280.X	13/16" BENT MALE TERM BOX 80A	1
OPAL2100.X	13/16" BENT MALE TERM BOX 100A	1
OPAL2120.X	13/16" BENT MALE TERM BOX 120A	1
OPAL330.X	MINI FEMALE TERM BOX 30A	1
OPAL340.X	MINI FEMALE TERM BOX 40A	1
OPAL430.X	9/16" BENT MALE TERM BOX 30A	1
OPAL440.X	9/16" BENT MALE TERM BOX 40A	1
OPAL450.X	9/16" BENT MALE TERM BOX 50A	1
OPAL480.X	9/16" BENT MALE TERM BOX 80A	1
OPAL4100.X	9/16" BENT MALE TERM BOX 100A	1
OPAL525.X	LOCKING FEMALE TERM BOX 25A	1
OPAL530.X	LOCKING FEMALE TERM BOX 30A	1

MICRO2®, MICRO3®, MCase®, Low Profile JCASE® Module (Module 6)

MATERIAL NUMBER	CATALOG NUMBER	
ORBOX006Z	RBOX6	
MIC2005.V	MICRO2 Fuse 5A	10
MIC207.5V	MICRO2 Fuse 7.5A	10
MIC2010.V	MICRO2 Fuse 10A	10
MIC2015.V	MICRO2 Fuse 15A	10
MIC2020.V	MICRO2 Fuse 20A	10
MIC2025.V	MICRO2 Fuse 25A	10
MIC3005.V	MICRO3 Fuse 5A	10
MIC307.5V	MICRO3 Fuse 7.5A	10
MIC3010.V	MICRO3 Fuse 10A	10
MCAS020.V	MCASE Fuse 20A	10
MCAS025.V	MCASE Fuse 25A	10
MCAS030.V	MCASE Fuse 30A	10
MCAS040.V	MCASE Fuse 40A	10
LJCA020.V	LOW PROFILE JCASE 20A	10
LJCA025.V	LOW PROFILE JCASE 25A	10
LJCA030.V	LOW PROFILE JCASE 30A	10
LJCA040.V	LOW PROFILE JCASE 40A	10
LJCA050.V	LOW PROFILE JCASE 50A	10
LJCA060.V	LOW PROFILE JCASE 60A	10

MATERIAL NUMBER	CATALOG NUMBER
ORBOX003ZGLO	RBOX3GLO

Contact your local sales manager for more information

Assortment Kits

Modular Rack Systems

The new MRS Modular Rack System is a flexible offering of fuses that can be ordered based on your needs. Each rack is sold individually and can be locked together to sit on a counter, or wall mounted. They are also available as a complete kit. Size charts, and color identification charts are included to serve as a guide for easy identification and replacement.



OMRS0007ZXA

MATERIAL NUMBER	CATALOG NUMBER	DESCRIPTION	CONTENTS
OMRS0001Z	MRS1	ATO Modular Rack System	See Table Below
OMRS0002Z	MRS2	MINI-MAXI Modular Rack System	See Table Below
OMRS0003Z	MRS3	Glass Modular Rack System	See Table Below
OMRS0004Z	MRS4	PAL / MEGA Modular Rack System	See Table Below
OMRS0005Z	MRS5	PAL / JCASE Modular Rack System	See Table Below
OMRS0006Z	MRS6	ATO / MINI Assortments Modular Rack System	See Table Below
OMRS0007Z	MRS7	Complete Modular Rack System - 6 Racks	MRS 1, 2, 3, 4, 5 & 6 - See Table Below
OMRS0007ZXA	MRS7A	Complete Modular Rack System - 7 Racks	MRS 1, 2, 3, 4, 5, 6 & 9 - See Table Below
OMRS0009ZXA	MRS9	ACS / MICRO2 / MICRO3 / MCASE Modular Rack System	See Table Below
OMRS0200Z	MRS200	ATO / MINI / MAXI Modular Rack System	MRS Racks 1 & 2 (Assembled)
OMRS0300Z	MRS300	ATO / MINI / MAXI / Glass Modular Rack System	MRS Racks 1, 2 & 3 (Assembled)

Modular Rack Systems Part Number Contents

MATERIAL NUMBER	OMRS0001Z	OMRS0002Z	OMRS0003Z	OMRS0004Z	OMRS0005Z	OMRS0006Z	OMRS0009ZXA
CATALOG NUMBER	MRS1	MRS2	MRS3	MRS4	MRS5	MRS6	MRS9
FUSE TYPE	ATO	MINI / MAXI	GLASS / CERAMIC	PAL / MEGA	PAL / JCASE	ATO / MINI ASSORTMENTS	MICRO2 / MICRO3 / MCASE
CONTENTS	(5) ATO3	(5) MIN2	(5) AGC1 (10) SFE4	(2) PAL20	(1) PAL1120 (1) PAL430	(12) 094202B	(2) MIC2 5 (3) MIC3 10
	(5) ATO4	(5) MIN3	(5) AGC2 (10) SFE7.5	(4) PAL30	(1) PAL230 (1) PAL440	(12) 094362B	(2) MIC2 7.5 (3) MIC3 15
	(10) ATO5	(5) MIN4	(10) AGC3 (10) SFE9	(3) PAL40	(1) PAL240 (1) PAL450		(4) MIC2 10 (2) MCAS 15
	(10) ATO7.5	(10) MIN5	(5) AGC5 (10) SFE14	(3) PAL50	(1) PAL250 (1) PAL480		(4) MIC2 15 (3) MCAS 20
	(15) ATO10	(10) MIN7.5	(5) AGC7.5 (30) SFE20	(2) PAL60	(1) PAL260 (1) PAL4100		(4) MIC2 20 (2) MCAS 25
	(15) ATO15	(15) MIN10	(10) AGC10 (10) SFE30	(1) PAL130	(1) PAL270 (1) PAL525		(3) MIC2 25 (4) MCAS 30
	(20) ATO20	(20) MIN15	(20) AGC15 (10) GBC8	(2) PAL160	(1) PAL280 (1) PAL530		(3) MIC2 30A (3) MCAS 40
	(10) ATO25	(20) MIN20	(20) AGC20 (10) GBC16	(3) PAL180	(1) PAL2100 (1) JCAS40		(3) MIC3 5
	(15) ATO30	(15) MIN25	(10) AGC25 (10) GBC25	(2) PAL1100	(1) PAL2120 (1) JCAS50		(3) MIC3 7.5
	(5) ATO40	(15) MIN30	(30) AGC30	(2) MEG 175	(1) JCAS20 (1) JCAS60		
		(2) MAX20	(5) AGW15		(2) JCAS30		
		(3) MAX30	(5) AGW20		(1) PAL330		
		(2) MAX40			(1) PAL340		
	(2) MAX50						
	(3) MAX60						

Circuit Breakers

1

Type I • Automatic Reset

Cycles or continuously resets until the fault is corrected. Type I circuit breakers are typically used to protect circuits which occasionally experience momentary overloads such as wiper motor and headlamp circuits where a self resetting device is preferred.

Additional information: littelfuse.com/CircuitBreakers

Type II • Modified Reset

Non-cycling, remains in open position while there is power to the circuit. Resets when ignition is turned off. Type II circuit breakers are typically used in applications where fuse replacement is objectionable, such as power window, seat and sunroof circuits.

Type III • Manual Reset

Manually resettable circuit breakers remain in the open position until a button, lever or other external reset device is manually depressed. Type III circuit breakers are typically used in applications where a manual reset is desired for safe diagnosis of a circuit fault.

MINI® Footprint Circuit Breakers

Designed to fit in a MINI Blade fuse block or panel. SAE Type II used primarily as a wiring harness protector in 12V DC automotive systems. Conforms to SAE J553C standard.



CURRENT RATING (A)	PART NUMBERS	
	BULK	BOXED
10	30419-10	—
15	30419-15	30419-15-BX
20	30419-20	30419-20-BX
25	30419-25	30419-25-BX

Wide MINI® Footprint Circuit Breakers

Direct factory replacement for many domestic OEM applications. Designed to fit either in an ATO or MINI blade fuse block or panel. Their blade configuration is of the MINI design and fit in a standard ATO fuse slot or across two MINI slots. Available in either SAE Type I cycling or SAE Type II non-cycling used primarily as a wiring harness protector in 12V DC automotive systems. Conforms to SAE J553C standard.

CURRENT RATING (A)	BOXED	APPLICATION	CYCLING	NON-CYCLING
	MATERIAL NUMBER			
15	0MMB015.X	Heavy Truck Headlamp	•	
20	0MMB020.X	Automotive Headlamp	•	
10	0MNB010.X	Heavy Duty Truck		•
15	0MNB015.X	Heavy Duty Truck		•
20	0MNB020.X	Automotive/Heavy Truck		•
25	0MNB025.X	Automotive/Heavy Truck		•
30	0MNB030.X	Automotive/Heavy Truck		•

Specialty OEM ATO® Footprint Circuit Breakers

Direct factory replacement for many domestic OEM vehicles. SAE Type I and Type II modified reset used primarily as a wiring harness protector in 12V DC automotive systems. Conforms to SAE J553C standard. Designed to mount in ATO style fuse blocks and panels.



CURRENT RATING (A)	BOXED	CARDED	APPLICATION	OEM PART NUMBER
	MATERIAL NUMBER	MATERIAL NUMBER		
20	—	0ACB020.XP	Automotive Headlamp	GM# 12040816
30	—	0ACB030.XP	Power Windows, & Locks	GM# 01252240
20	0FCB020.X	0FCB020.XP	Power Windows	Ford# 83507005
25	0CCB025.X	0CCB025.XP	Windows, Seats & Locks	Ford# D9AB-14526-BA Chrysler# 4527053

Fuse Clip Circuit Breakers

Direct replacement for many OEM applications. Designed for glass fuses without physical alteration in the system. Fits 1-1/4" fuse clips. SAE Type II non-cycling used primarily as a wiring harness protector in 12V DC automotive systems. Conforms to SAE J553C standard.



CURRENT RATING (A)	PART NUMBERS	
	BULK	BOXED
10	-	30410-10-BX
15	30410-15	30410-15-BX
20	30410-20	30410-20-BX
25	30410-25	30410-25-BX
30	30410-30	30410-30-BX

Circuit Breakers



Universal ATO® Footprint Circuit Breakers

Universal Circuit Breakers function identically and have same internal components as OEM breakers but offer the versatility of snap off terminals for greater flexibility. SAE Type II modified reset used primarily as a wiring harness protector in 12V DC automotive systems. Meets OEM requirements. Conforms to SAE J553C standard. Designed to mount in ATO style fuse blocks and panels.

CURRENT RATING (A)	BOXED	BOXED BULK	CARDED
	MATERIAL NUMBER	MATERIAL NUMBER	PACKAGING MATERIAL NUMBER
5	OUCB005.X	BUCB005.Z	OUCB005.XP
10	OUCB010.X	BUCB010.Z	OUCB010.XP
15	OUCB015.X	BUCB015.Z	OUCB015.XP
20	OUCB020.X	BUCB020.Z	OUCB020.XP
25	OUCB025.X	BUCB025.Z	OUCB025.XP
30	OUCB030.X	BUCB030.Z	OUCB030.XP

MAXI Style Circuit Breakers

Direct factory replacement for many domestic OEM applications. Designed to fit a MAXI Blade fuse block or panel. Available in either SAE Type I cycling or SAE Type II non-cycling. Used primarily as a wiring harness protector in 12V DC automotive systems. Meet OEM requirements. Conforms to SAE J553C standard.

CURRENT RATING (A)	BOXED	APPLICATION	CYCLING	NON CYCLING
	MATERIAL NUMBER			
20	OMCB020.X	Automotive Headlamp	•	
30	OMCB030.X	Automotive Headlamp, Seats & Wipers	•	
40	OMCB040.X	–	•	
20	OMXB020.X	Automotive Power Devices Heavy Truck & Auto Cooling Fan		•
30	OMXB030.X	Automotive Power Window Heavy Truck & Auto Cooling Fan & Power Window		•

Circuit Breaker Mounting Brackets & Bus Bars

Mounting brackets available in steel or nylon and accept 30056 and 30137 series breakers.

Bus bars are made from heavy solid brass or copper, with holes or slots that make it easy to connect box-type circuit breakers with studs, in order to feed a number of protected circuits.



30090-04 4-gang steel bracket



86099-5 brass busbar with holes



86126-4 copper busbar with slots

PART NUMBERS		DESCRIPTION	NUMBER OF GANGS	MATERIAL	DIMENSIONS	MOUNTING HOLE DIMENSIONS	NOTES
BULK	BOXED						
30090-2	30090-2-BX	Mounting Bracket	2	Steel	.81" x 1.29" (122.2 x 32.8 mm)	4.00" (101.6mm) on centers	For all steel breakers without a bracket. Breakers snap into position, engaging with dimples in the case of the breaker.
30090-3	30090-3-BX		3		5.71" x 1.29" (145.0 x 32.8mm)	1.90" (124.5mm) on centers	
30090-4	30090-4-BX		4		6.62" x 1.29" (160.1 x 32.8mm)	5.81" (147.6mm) on centers	
30090-6	30090-6-BX		6		8.43" x 1.29" (214.1 x 32.8mm)	7.62" (193.5mm) on centers	
30090-8	30090-8-BX		8		10.25" x 1.29" (260.4 x 32.8mm)	9.43" (239.5mm) on centers	
–	86099-2-BX	Busbar	2	Brass	1.53" long (38.9mm)	–	Holes: .910" (23.1mm) on centers, .021" (5.3mm) diameter
86099-3	86099-3-BX		3		2.43" long (61.7mm)	–	
86099-4	86099-4-BX		4		3.34" long (84.8mm)	–	
86099-5	86099-5-BX		5		4.24" long (107.7mm)	–	
86126-2	86126-2-BX		2		Copper	1.41" x .560" (35.8 x 14.2mm)	
86126-4	86126-4-BX	4	3.23" x .560" (82.1 x 14.2mm)	2.73" (69.34mm) on centers			
86126-6	86126-6-BX	6	5.05" x .560" (128.3 x 14.2mm)	4.55" (115.57mm) on centers			
86126-8	86126-8-BX	8	6.87" x .560" (174.5 x 14.2mm)	6.37" (161.79mm) on centers			
86126-12	86126-12-BX	12	10.51" x .560" (267.0 x 14.2mm)	10.01" (254.25mm) on centers			

1

Box Style Circuit Breakers

Steel or plastic housing. Steel box type is approximately 1 1/4" x 3/4" x 2/3" and comes with integral brackets (to be directly affixed with screws or bolts) or without (needs a mounting bracket). Breakers have 10-32 studs, blades or wire leads. Wire lead type has a 10" wire loop connected to studs and PVC-coated. Loop is intended to be cut, stripped and spliced into a circuit.

Additional information: littelfuse.com/CircuitBreakers



30056, 30137, 30171 - with studs, no bracket



30055, 30138, 30172 - with studs and bracket



30128 - with studs and cross-bracket



3088, 30507 - double breaker assembly

Type I Steel Case with Stud Terminals

PART NUMBERS				VOLT	AMPS	SEALED	NOTES	PART NUMBERS				VOLT	AMPS	SEALED	NOTES	PART NUMBERS				
BULK	BOXED	RETAIL	BULK					BOXED	RETAIL	BULK	BOXED					RETAIL	BULK	BOXED	RETAIL	
30056-10	30056-10-BX	-	10	-	-	Type I	30055-10	30055-10-BX	-	10	-	-	Type I with bracket	30171-10	30171-10-BX	-	10	-	Type I	
30056-15	30056-15-BX	-	15	-	-		30055-15	30055-15-BX	30055-15-BP	15	-	-		30171-15	30171-15-BX	-	15	-		
30056-20	30056-20-BX	-	20	-	-		30055-20	30055-20-BX	30055-20-BP	20	-	-		30171-20	30171-20-BX	-	20	-		
30056-25	30056-25-BX	-	25	-	-		30055-25	30055-25-BX	-	25	-	-		30171-30	30171-30-BX	-	30	-		
30056-30	30056-30-BX	-	30	-	-		30055-30	30055-30-BX	30055-30-BP	30	-	-		30172-10	-	-	24	10		-
30056-40	30056-40-BX	-	40	-	-		30055-40	30055-40-BX	30055-40-BP	40	-	-		30172-15	30172-15-BX	-	15	-		
30056-50	30056-50-BX	-	50	-	-		30055-50	30055-50-BX	30055-50-BP	50	-	-		30172-20	30172-20-BX	-	20	-		
30137-10	-	-	10	•	-		30138-10	-	-	12	10	•		30172-30	30172-30-BX	-	30	-		
30137-15	30137-15-BX	-	15	•	-		30138-15	-	-	15	15	•		3088-50	-	-	50	-		
30137-20	30137-20-BX	-	20	•	-		-	30138-30-BX	-	30	30	•		3088-60	3088-60-BX	-	60	-		
30137-30	-	-	30	•	-	30138-40	-	-	40	40	•	3088-80	3088-80-BX	-	80	-				
						30128-10	30128-10-BX	-	10	-	-	30507-60	30507-60-BX	-	60	•				
						30128-15	30128-15-BX	-	15	-	-	30507-80	30507-80-BX	-	80	•				
						30128-20	30128-20-BX	-	20	-	-									
						30128-30	30128-30-BX	-	30	-	-									
						30128-40	30128-40-BX	-	40	-	-									



30062 with wire leads, with bracket



30063 with wire leads, without bracket



Stud Type Low Voltage (6-12 V DC) Circuit Breakers

SAE Type I automatic reset provides protection in installations where it is not possible to manually reset a breaker because of location or safety requirements. Used primarily as a wiring harness protector in 12V DC automotive systems. Conforms to SAE J553C standard. Available with or without mounting bracket.

PVC-Coated Steel Case with Wire Terminals

PART NUMBERS		VOLT	AMPS	SEALED	NOTES
BULK	BOXED				
-	30062-20-BX	12	20	•	Type I with Bracket
30062-30	30062-30-BX		30	•	
30063-10	-	12	10	•	Type I
30063-20	30063-20-BX		10	•	
30063-30	-		30	•	

CURRENT RATING (A)	BOXED W/O BRACKET	BOXED W/ BRACKET	CARDED
	MATERIAL NUMBER	MATERIAL NUMBER	MATERIAL NUMBER
5	0812005.ZXST	0813005.ZXST	-
6	0812006.ZXST	-	-
8	-	0813008.ZXST	-
10	0812010.ZXST	0813010.ZXST	-
15	0812015.ZXST	0813015.ZXST	-
20	0812020.ZXST	0813020.ZXST	0813020.XP
25	0812025.ZXST	0813025.ZXST	-
30	0812030.ZXST	0813030.ZXST	0813030.XP
4	0812040.ZXST	0813040.ZXST	0813040.XP
50	0812050.ZXST	0813050.ZXST	0813050.XP

Circuit Breakers

50-150A • 32V DC • Hi-Amp Type III • Circuit Breakers

These high amp circuit breakers are typically used in auxiliary and accessory circuits for trucks, buses, RVs and marine applications in battery charger systems and DC audio systems. All high amp circuit breakers comply with the SAE J1117 and J1625 standard for ignition protection.



- Agency Approvals: UL Approved for all amp ratings at 32V DC
- Interrupting Rating: 3000A @30V DC
- Ignition Protection: SAE J1625 and J1171
- Material: Thermoset Plastic UL Rating 94VO
- Temperature Range: -32C to 92C
- RoHS Compliant
- Waterproof

CURRENT RATING (A)	BOXED PART NUMBERS		CARDED PART NUMBERS		INTERRUPTING RATING	RoHS
	MATERIAL NUMBER	CATALOG NUMBER	MATERIAL NUMBER	CATALOG NUMBER		
50	0185050.X	185050	–	–	3000A @ 30V DC	•
60	0185060.X	185060	–	–	3000A @ 30V DC	•
70	0185070.X	185070	–	–	3000A @ 30V DC	•
80	0185080.X	185080	–	–	3000A @ 30V DC	•
100	–	–	0185100.XP	185100BP	3000A @ 30V DC	•
120	–	–	0185120.XP	185120BP	3000A @ 30V DC	•
150	–	–	0185150.XP	185150BP	3000A @ 30V DC	•



MINI® Type I Circuit Breakers

Designed to fit in a MINI blade fuse block or panel. Conforms to SAE J553. Cycles or continuously resets until the fault is corrected. Type I circuit breakers are typically used to protect circuits which occasionally experience momentary overloads such as wiper motor and headlamp circuits where a self resetting device is preferred.



CURRENT RATING (A)	CARDED PART NUMBERS	
	MATERIAL NUMBER	CATALOG NUMBER
10	0211010.XP	211010BP
15	0211015.XP	211015BP
20	0211020.XP	211020BP
25	0211025.XP	211025BP
30	0211030.XP	211030BP

ATO® Circuit Breakers Series - Type I Automatic Reset

Circuit breakers and fuses are a cost-effective solution to protecting wiring, equipment and subsystems. Terminals are grooved so that they can be easily snapped off with pliers to fit the electrical blocks of different vehicles. Use as is (long terminals) for Kenworth trucks. Use with one segment snapped off each terminal for: Dodge trucks, Ford heavy trucks, Navistar trucks. Use with two segments snapped off (short terminals) for Ford pickup trucks.

Color-coded housings with rating marked on the top: 10A red, 15A blue, 20A yellow, 25A silver, 30A green.



Long terminals, as supplied One segment snapped off Two segments snapped off

CURRENT RATING (A)	PART NUMBERS			COLOR
	BULK	BOXED	RETAIL CLAMSHELL	
10	30409-10	30409-10-BX	–	Red
15	30409-15	30409-15-BX	–	Blue
20	30409-20	30409-20-BX	30409-20-BP	Yellow
25	30409-25	30409-25-BX	–	Silver
30	30409-30	30409-30-BX	30409-30-BP	Green

Fuse Blocks, Holders & Terminal Blocks



Fuse Holders accept fuses to provide electrical protection on circuits. In the following section, there is a wide range of fuse holders from lower current to higher current ratings and in various levels of sealing from moisture and dust. These are all single fuse products. For products accepting multiple fuses, refer to our Power Distribution Module (PDM) product offerings, in the next section of this catalog.

Where Do I Need a Fuse Holder?

Fuse holders allow you to install a fuse into an electrical circuit to protect the wiring from the harmful effects of excessive amount of electricity flowing through the cables. The fuse is a replaceable element that will 'blow' to stop the flow of an overload of electricity. If a fuse blows in a circuit, it is important to understand what caused the issue before replacing the fuse, otherwise there is a risk of repeated failures.

Fuses (in fuse holders) should be placed on every wire, as close to the point of the source of power (the battery) as possible. Every time a wire is split or spliced into smaller wires, each of those should be fused. Single fuse holders protect a single wire. A fuse (holder) should be properly sized. Larger diameter wires require larger fuses and smaller diameter wires get smaller rated fuses. Refer to best practices for proper selection fuses for your system

Sealed or Unsealed

Depending where on the vehicle a fuse holder is placed, it may be wise to utilize sealed fuse holders. In all instances, it is wise to try to have the most amount of physical protection of the fuse/fuse holder combination that makes sense. Fuse holders may have simple coverings (to prevent accidental shorting), all the way to completely sealing the fuse and cable to provide protection from moisture and dust in the electrical system. The more exposure to impurities the more risk to the safe and efficient performance of the electrical system as these elements can cause corrosion, and even electrical faults and failures. Some environments however are protected and it may not be necessary to use a sealed fuse holder. Littelfuse offers a wide variety of fuse holders that range from open to fully sealed.



Bolt-Down Fuse Blocks



MEGA® Bolt-Down Fuse Block

Use with MEGA fuses up to 500A. Ideal for battery and alternator connections and other heavy gauge cables requiring ultra high current protection. Includes protective cover. Features interconnecting pins on side of fuse block for multiple block configurations. Includes M8 threaded studs and hex nuts with lock washers. Fuse not included. Additional information: littelfuse.com/298

PART NUMBERS			VOLTAGE	AMPERAGE	HARDWARE MATERIAL	STUD TORQUE
BULK 70-PC	BULK 20-PC	BULK 10-PC				
02980900Z	02980900S	02980900TXN	32V DC	500A	Zinc-Plated Steel	12-18 Nm



MEGA® SN Series Assure-Latch™ Fuse Block

The SN Series is a high amperage in-line MEGA fuse block with sealed positive latching technology. The fuse holder base and cover are secured together with AssureLatch™ technology to form a water resistant and ignition protected assembly. Fuse not included. Additional information: littelfuse.com/SN

PART NUMBERS	VOLTAGE	AMPERAGE	INGRESS	HARDWARE MATERIAL	STUD TORQUE	NOTES
880014	32V DC	500A	IP66 & IP69K	Tin-Plated Steel	20 Nm	Ignition Protected



Flex-MEGA® Fuse Block

For use with MEGA bolt-down fuses, up to 500A. The Flex holder offers a flexible cover, which allows cable entry from virtually any direction, large wire size, and ring terminal stack up. Busbars are available for multiple holder applications and a dovetail feature allows interlocking of multiple Flex-MIDI and Flex-MEGA fuse holders together for a power distribution block. Fuse not included. Additional information at: littelfuse.com/FLEX-MEGA

PART NUMBERS	VOLTAGE	AMPERAGE	HARDWARE MATERIAL	STUD TORQUE	NOTES
02981001ZXT	32V DC	500A	Zinc-Plated Steel	12-18 Nm	330 PC
02981028HXFC-SS	32V DC	500A	Stainless Steel	12-18 Nm	-
02981028HXFC	32V DC	500A	Zinc-Plated Steel	12-18 Nm	-
BUSBAR PART NUMBERS	DESCRIPTION	HARDWARE MATERIAL	STUD TORQUE	NOTES	
882-839-2	2 Position Bus Bar	Tin-Plated Copper	-	For use 2 Fuse Holders	
882-839-3	3 Position Bus Bar	Tin-Plated Copper	-	For use 3 Fuse Holders	
882-839-4	4 Position Bus Bar	Tin-Plated Copper	-	For use 4 Fuse Holders	
882-839-5	5 Position Bus Bar	Tin-Plated Copper	-	For use 5 Fuse Holders	



MIDI® SN Series Assure-Latch™ Fuse Block

The SN Series is a high amperage in-line MEGA fuse block with sealed positive latching technology. The fuse holder base and cover are secured together with AssureLatch™ technology to form a water resistant and ignition protected assembly. Fuse not included. Additional information: littelfuse.com/SN

PART NUMBERS	VOLTAGE	AMPERAGE	INGRESS	HARDWARE MATERIAL	STUD TORQUE	NOTES
880015	32V DC	200A	IP66 & IP69K	Tin-Plated Steel	20 Nm	Ignition Protected



Flex-MIDI® Fuse Block

For use with MIDI bolt-down fuses, up to 200A. The Flex holder offers a flexible cover, which allows cable entry from virtually any direction, large wire size, and ring terminal stack up. Busbars are available for multiple holder applications and a dovetail feature allows interlocking of multiple Flex-MIDI and Flex-MEGA fuse holders together for a power distribution block. Fuse not included. Additional information: littelfuse.com/FLEX-MIDI

PART NUMBERS	VOLTAGE	AMPERAGE	HARDWARE MATERIAL	STUD TORQUE	NOTES
04981038HXFC	32V DC	200A	Zinc-Plated Steel	3.0-5.0 Nm	-
04982001ZXFC	32V DC	200A	Zinc-Plated Steel	3.0-5.0 Nm	2 Holders with Busbar
BUSBAR PART NUMBERS	DESCRIPTION	HARDWARE MATERIAL	STUD TORQUE	NOTES	
882-267-002	2 Position Bus Bar	Tin-Plated Copper	-	For use 2 Fuse Holders	
882-267-003	3 Position Bus Bar	Tin-Plated Copper	-	For use 3 Fuse Holders	
882-267-004	4 Position Bus Bar	Tin-Plated Copper	-	For use 4 Fuse Holders	
882-267-005	5 Position Bus Bar	Tin-Plated Copper	-	For use 5 Fuse Holders	

In-Line Fuse Holders

2



MIDI® Compact In-line Fuse Holder

Designed for use with bolt-down MIDI style fuses. It can be conveniently installed directly in-line with the cables and no mounting required. The fuse holder is easy to shrinkwrap for environmental protection and the corners of the cover are curved so that shrinkwrap will not be split.

Download additional technical information at: littelfuse.com/498-IL

PART NUMBERS		DETAILS	AMPERAGE	HARDWARE MATERIAL
BULK	BOXED			
04980921GXM5		Complete Assembly	200A	Zinc-Plated Steel



MIDI® In-line Fuse Holder

Use with MIDI fuses up to 200 amps. Includes protective cover. Features interconnecting pins on side of fuse block for multiple block configurations. Includes M5 threaded studs and hex nuts with lock washers. Fuse not included.

Download additional technical information at: littelfuse.com/498

PART NUMBERS			DETAILS	AMPERAGE	HARDWARE MATERIAL
BULK 10-PC	BULK 20-PC	BULK 330-PC			
0498900.TXN	04980900S	04980900ZXT	Complete Assembly	200A	Zinc-Plated Steel
-	-	04980903ZXT	Holder with mounting brackets	200A	Zinc-Plated Steel
-	-	04980904ZXT	Includes protective cover, threaded M5 studs, split washers, and hexnuts	200A	Zinc-Plated Steel

MAXI In-line Blade Fuse Holders with Covers - MAH Series

Use with MAXI Fuse up to 60 amps. Supplied with two 6" wire leads of 6 gauge black wire. Includes protective cover for harsh environment and mounting hole for easy firewall installation.

Download additional technical information at: littelfuse.com/MAH



BOXED PART NUMBERS		DETAILS	AMPERAGE	INGRESS	WIRE DETAILS			COVER
MATERIAL NUMBER	CATALOG NUMBER				GAUGE	LENGTH	COLOR	
MAHC0001ZXJ	MAH1	Standard	up to 60A	IP67	6	5"	Black	•
MAHC0001ZXJA	MAH1	Standard	up to 60A	IP67	6	5"	Red	•
MAHC0001TXJ	MAH1	Standard	up to 60A	IP67	6	5"	Black	•

* Please inquire about additional bulk quantities

MAXI In-line Blade Splash Resistant Fuse Holders with Covers - 152 Series

The In-line Splash Resistant Fuse Holder provides an efficient, simple installation method for MAXI fuse applications in harsh under-the-hood environments

Download additional technical information at: littelfuse.com/152



PART NUMBERS		DETAILS	AMPERAGE	INGRESS	KIT CONTENTS		
BULK	BOXED				SEALS	TERMINALS	COVER
01520003TXN941		for 4-6mm ² wire	60A	IP54	•	•	•
01520003TXN942		for 6-10mm ² wire	60A	IP54	•	•	•
01520005Z		Body with tabs	60A	IP54		•	•
01520006Z		Body without tabs	60A	IP54		•	•

MAXI In-line Fuse Holders with Optional Covers - MAB Series

Use with MAXI fuses up to 60 amps. Safe/easy replacement for hard to replace fusible link wire. Perfect for high amp audio applications. Interlocking block feature permits two pole position installation. Contains screw terminals. Optional dust cover available (Part Number: 01520007Z).

Download additional technical information at: littelfuse.com/MAB



PART NUMBERS			DETAILS	AMPERAGE	COVER
BULK	BOXED	CARDED			
0MAB0001S	0MAB0001F	0MAB0001XP	High Amp	up to 60A	Sold Separately

In-Line Blade Fuse Holders

MINI® In-line Blade Fuse Holders with Covers - FHM Series

Use with MINI 2 to 20A fuses. Supplied with two 4" wire leads of 14 gauge black wire. Includes protective cover for harsh environment. Heavy Duty MINI® In-line Blade Fuse Holders with Covers - FHM Series: Use with MINI 25 and 30A fuses. Supplied with two 4" wire leads of 12 gauge orange wire. Includes protective cover for harsh environment.

Download additional technical information at: littelfuse.com/FHM

PART NUMBERS			DETAILS	AMPERAGE	INGRESS	WIRE DETAILS			COVER
BULK 20-PC	CARDED					GAUGE	LENGTH	COLOR	
	MATERIAL NUMBER	CATALOG NUMBER							
0FHM0001SXJ	0FHM0001XP	FHM1BP	Standard	2-20A	IP67	14	4"	Black	•
0FHM0002SXJ	0FHM0002XP	FHM2BP	Heavy Duty	25-30A	IP67	12	4"	Orange	•
-	0FHM0001XPGLO	20-1020	Smart Glow	-	IP67	-	4"	Red	•

* Please inquire about additional bulk quantities

ATO® In-line Blade Fuse Holders with Covers - FHAC Series

Use with ATO 1 to 20A fuses. Supplied with two 3.5" wire leads of 16 gauge black wire. Includes protective cover for harsh environment. Heavy Duty ATO® In-line Blade Fuse Holders with Covers - FHAC Series: Use with ATO 25 and 30A fuses for air conditioner or other heavy duty applications. Supplied with two 3.5" wire leads of 12 gauge orange wire. Includes protective cover for harsh environment.

Download additional technical information at: littelfuse.com/FHAC

PART NUMBERS			DETAILS	AMPERAGE	INGRESS	WIRE DETAILS			COVER
BULK 20-PC	CARDED					GAUGE	LENGTH	COLOR	
	MATERIAL NUMBER	CATALOG NUMBER							
FHAC0001SXJ	FHAC0001XP	FHAC1BP	Standard	2-20A	IP67	16	3.5"	Black	•
FHAC0002SXJ	FHAC0002XP	FHAC2BP	Heavy Duty	25-30A	IP67	12	3.5"	Orange	•

* Please inquire about additional bulk quantities

ATO® In-line Blade Fuse Holders - FHA Series

Use with ATO 1 to 20A fuses. Supplied with two 4" wire leads of 16 gauge black wire. Heavy Duty ATO® In-line Blade Fuse Holders - FHA Series: Use with ATO 25 and 30A fuses for air conditioner or other heavy duty applications. Supplied with two 4" wire leads of 12 gauge orange wire. FHA30BP includes 30 amp fuse.

Download additional technical information at: littelfuse.com/FHA

PART NUMBERS					DETAILS	AMPERAGE	WIRE DETAILS		
BULK 20-PC	CARDED		BOXED				GAUGE	LENGTH	COLOR
	MATERIAL NUMBER	CATALOG NUMBER	MATERIAL NUMBER	CATALOG NUMBER					
0FHA0001SXJ	0FHA0001XP	FHA1BP	-	-	Standard	1-20A	16	4"	Black
0FHA0002SXJ	0FHA0002XP	FHA2BP	-	-	Heavy Duty	25-30A	12	4"	Orange
-	0FHA0030XP	FHA30BP	0FHA0030Z	FHA30	Heavy Duty with 30A Fuse	25-30A	12	4"	Orange
-	0FHA0001XPGLO	20-1010	-	-	Smart Glow	-	-	4"	Red

* Please inquire about additional bulk quantities

ATO® In-line Panel Mount Blade Fuse Holders - AFH and 155 Series

Versatile fuse holder for in-line or snap mount panel applications. Interlock body design allows fuse holders to be snapped together. Supplied with 8" loop of 14 gauge black wire. Heavy Duty ATO® In-line Panel Mount Blade Fuse Holders - AFH and 155 Series: Use with ATO 25 and 30A fuses. Supplied with 8" loop of 10 gauge orange wire.

Download additional technical information at: littelfuse.com/AFH

PART NUMBERS				DETAILS	AMPERAGE	WIRE DETAILS		
BOXED		CARDED				GAUGE	LENGTH	COLOR
MATERIAL NUMBER	CATALOG NUMBER	MATERIAL NUMBER	CATALOG NUMBER					
0AFH0001Z	AFH1	0AFH0001XP	AFH1BP	Standard	1-20A	14	8" loop	Black
-	-	0AFH0002XP	AFH2BP	Heavy Duty	25-30A	10	8" loop	Orange
01550300Z	155300	-	-	Standard	20A	14	8" loop	Black

* Please inquire about additional bulk quantities



SMART GLOW Fuses



SMART GLOW Fuses



JCASE & Glass Fuse Holders

2

JCASE® In-line Cartridge Fuse Holders - FHJC & FHJ Series

In-line fuse holders for JCASE fuses available with brackets covers or wire sizes 10AWG (up to 40A) or 8AWG (up to 60A). Additional information: littelfuse.com/FHJC



PART NUMBERS		DETAILS	AMPERAGE	INGRESS	WIRE DETAILS			BRACKET	COVER
BULK 250-PC	BULK 50-PC				GAUGE	LENGTH	COLOR		
FHJC1001G	–	Standard	up to 40A	IP67	10AWG	4"	Red	–	•
FHJC1002G	FHJC1002L	Heavy Duty	up to 60A	IP67	8AWG	4"	Red	–	•
FHJC2002G	FHJC2002L	Heavy Duty	up to 60A	IP67	8AWG	4"	Red	•	•
0FHJ1001G	–	Standard	up to 40A	–	10AWG	4"	Red	–	–
0FHJ1002G	–	Heavy Duty	up to 60A	–	8AWG	4"	Red	–	–
0FHJ2001G	–	Standard	up to 40A	–	10AWG	4"	Red	•	–
0FHJ2002G	–	Heavy Duty	up to 60A	–	8AWG	4"	Red	•	–

* Please inquire about additional bulk quantities

Glass Fuse In-line Twist-Lock Fuse Holders • FNY Series

Constructed of weather resistant nylon. Simple "twist-lock" allows easy fuse removal and replacement. Supplied with 8" loop of 14 gauge black wire and one spring. Use with Glass SFE 4, 6, 7 1/2, 9, 14, 20, AGA, AGC, AGW and AGX Fuses up to 20 amps. Additional information: littelfuse.com/FNY



CARDED PART NUMBERS		DETAILS	AMPERAGE	WIRE DETAILS		
MATERIAL	CATALOG			GAUGE	LENGTH	COLOR
0FNY0001XP	FNY1BP	Holder Only	up to 20A	14	8" loop	Black

* Please inquire about additional bulk quantities

Glass Fuse In-line Heavy Duty Fuse Holders • FNY Series

Spring loaded heavy duty glass fuse holder includes AGC 20A or 30A fuse for GM air conditioner, heater blower motors or other heavy duty applications. Supplied with two 4" wire leads of 12 gauge orange wire. FNY20BP includes 20A fuse, FNY30BP includes 30A fuse. Additional information: littelfuse.com/FNY



CARDED PART NUMBERS		DETAILS	AMPERAGE	WIRE DETAILS		
MATERIAL	CATALOG			GAUGE	LENGTH	COLOR
0FNY0020XP	FNY20BP	With 20A Fuse	20A	12	4"	Orange
0FNY0030XP	FNY30BP	With 30A Fuse	30A	12	4"	Orange

Glass Fuse In-line Bayonet Knob Fuse Holders • FHP Series

Constructed of tough black thermoset (UL94V0). Includes 3 springs for various fuse sizes and spring-locked, bayonet type knob. Supplied with 15" loop of 14 gauge red wire. Use with Glass SFE 7 1/2, 9, 14, 20, AGA, AGC, AGW and AGX Fuses up to 20 amps. Additional information: littelfuse.com/FHP



BOXED PART NUMBERS		DETAILS	AMPERAGE	WIRE DETAILS		
MATERIAL	CATALOG			GAUGE	LENGTH	COLOR
0FHP0001Z	FHP1	Holder Only	up to 20A	14	15" loop	Red

Glass Fuse In-line Fuse Holders

Holders accept SFE and AGC fuses through 30A. Supplied with wire loop which can be cut and spliced. Holder twist-locks the fuse in place. Available with the fuse. Additional information: littelfuse.com/3031



PART NUMBERS			DETAILS	AMPERAGE	WIRE DETAILS		
BULK	BOXED	RETAIL			GAUGE	LENGTH	COLOR
3031-0	3031-0-BX	3031-0-BP	Holder Only	up to 30A	14	8" loop	Black
3031-20	3031-20-BX	3031-20-BP	With 20A Fuse	20A	14	8" loop	Black
3031-30	3031-30-BX	–	With 30A Fuse	30A	14	8" loop	Black

3AG Shock-Safe Panel Mount Fuse Holders

Designed to eliminate the possibility of electrical shock, as defined in IEC standards 65 and 257. Shock-Safe fuse holders feature a low profile body, finger-grip knob and anti-tease feature that eliminates circuit interruption when knob is accidentally depressed.



CARDED MATERIAL NUMBER	VOLTAGE	AMPERAGE	TERMINALS
03453LF2XP	250V	20A	¼" straight NEMA/DIN quick connect

Add-A-Circuit® & Power Feed



ATO® Add-A-Circuit®

Allows easy installation of additional circuits without cutting or splicing. Turns one fuse slot into two while providing protection for both circuits. Maintains new car warranty. Use with ATO Fuses up to 10 amps. Carded Kit Part Numbers include ATO 3, 5, 7.5 and 10 amp fuses.

BULK PART NUMBERS		CARDED KIT PART NUMBERS	
MATERIAL NUMBER	CATALOG NUMBER	MATERIAL NUMBER	CATALOG NUMBER
0FHA0200Z	FHA200	0FHA0200ZP	FHA200BP



MINI® Add-A-Circuit®

Same as ATO Add-A-Circuit except for use with MINI Fuses up to 10 amps. Carded Kit Part Numbers include MINI 3, 5, 7.5 and 10 amp fuses.

BULK PART NUMBERS		CARDED KIT PART NUMBERS	
MATERIAL NUMBER	CATALOG NUMBER	MATERIAL NUMBER	CATALOG NUMBER
0FHM0200Z	FHM200	0FHM0200ZP	FHM200BP



LP MINI® Add-A-Circuit®

Same as ATO Add-A-Circuit except for use with LPMINI Fuses up to 10 amps. Carded Kit Part Numbers include LPMINI 3, 5, 7.5 and 10 amp fuses.

BULK PART NUMBERS	CARDED KIT PART NUMBERS
MATERIAL NUMBER	MATERIAL NUMBER
FHLM0200Z	FHLM0200ZPA



MICRO2® Add-A-Circuit®

Same as ATO Add-A-Circuit except for use with MICRO2 Fuses up to 10 amps. Carded Kit Part Numbers include MICRO2 3, 5, 7.5 and 10 amp fuses.

BULK PART NUMBERS	CARDED KIT PART NUMBERS
MATERIAL NUMBER	MATERIAL NUMBER
FHM20200Z	FHM20200ZPA



Battery Power Feed Kit

Attaches directly to battery terminal. Allows the addition of up to 3 circuits. Includes MINI fuse in-line fuse holder with protective cap. Also can be used as a frame ground. Constructed of durable brass for optimal conductivity..

CARDED PART NUMBERS	
MATERIAL NUMBER	CATALOG NUMBER
0BPF0001ZP	BPF1BP

Caution: Fusetaps are not a recommended alternative for adding circuits because they can stress the terminals in the fuse block. This situation can create a loose fitting fuse, which in turn produces excessive heat, which can cause nuisance blows, even melting of the fuse and fuse block and possibly an expensive repair in the future. When a fusetap is used, in many cases there is no fuse protecting the new circuit, a condition which can also present a hazard.

Fuse Pullers and Battery Accessories

2



Fuse Tester and Puller

Conveniently and easily tests ATO and MINI blade fuses either in or out of the fuse block, with or without vehicle battery power. Indicator light on tester glows bright green when fuse is good. Fuse puller end allows for easy fuse removal and replacement. 24V maximum.

Fuse Pullers

Fuse puller allows for easy fuse removal and replacement.



BOXED PART NUMBERS		CARDED PART NUMBERS		DESCRIPTION
MATERIAL NUMBER	CATALOG NUMBER	MATERIAL NUMBER	CATALOG NUMBER	
00970019X	097019	00970019XP	097019BP	ATO & MINI Fuse Puller / Tester
-	097023	00970023XP	097023BP	Tri-Puller™ – Glass Fuses, Ceramic Type Fuses, ATO and MINI Blade Fuse Puller
-	097026	00970026XP	097026BP	MAXI Blade Fuse Puller
-	097038	00970038XPA	-	ATO and MINI Fuse Puller
-	-	00970053XP	-	JCASE Fuse Puller
-	-	00970025XPA	-	MICRO2 / MICRO3 Fuse Puller
-	-	00970054XPA	-	MCASE Fuse Puller



Anti-Theft Battery Master Switch

- Available in two versions, Fused and Detachable.
- Fused version maintains current to all electrical circuits such as the alarm, on-board computer, central locking system and radio memory presets.
- Detachable version features a special disconnect that allows the battery to easily be removed for anti-theft protection. Perfect for seasonal storage needs or easy off vehicle battery charging for Autos, Motorcycles, RV's, Boats, etc.
- Generate sales with the lowest cost anti-theft devices available on the market today.
- A simple turn of the knob isolates the battery and makes the vehicle unable to start.
- Makes anti-theft protection affordable when compared to expensive alarm systems.
- Eliminates complicated installation — no special electrical or mechanical expertise required.
- Fits all standard Top Mount Post batteries. Can be used with Side Mount Post batteries by using a Top Mount Adapter Post (not included).
- Works on 12 to 24 volt systems up to 135 amperes.

CARDED PART NUMBERS		DESCRIPTION
MATERIAL NUMBER	CATALOG NUMBER	
0ATD0300ZBP	ATD300BP	Anti-theft Battery Master Switch – Fused

Multiple Position Fuse Blocks

BMZ Series • Battery Mount ZCASE® Fuse Holder

The BMZ fuse holder allows you to mount fusing directly to a post style battery without any special hardware. The isolated bolts eliminate the traditional need for nylon nuts and fuses can be assembled using standard M8 threaded hardware.

- Max Continuous Current: 275A
- Mounts directly to a post style of battery
- Available in 2 or 3 outputs
- Fusing directly at the battery allows location of larger power distribution boxes outside of the engine compartment while assuring protection of the supply cable

Download additional technical information at: littelfuse.com/BMZ



3-Way



2-Way



With Cover

PART NUMBERS			POSITIONS	DESCRIPTION
BULK	BOXED	RETAIL		
882-854	–	–	2	2 Way Bus Bar & Stud Assembly
882-853	–	–	3	3 Way Bus Bar & Stud Assembly
876-199	–	–	–	Battery Terminal
901-325	–	–	–	Red Rubber 2 or 3 Way Cover
–	0FHZ00854-BX	–	2	Kit: 882-854 (2 way bus bar), 876-199 (terminal mount), 901-325 (red cover), 1X M8 Bolt, 3x M8 Nuts
–	0FHZ00853-BX	–	3	Kit: 882-853 (3 way bus bar), 876-199 (terminal mount), 901-325 (red cover), 3x M8 Nuts

SMZ Series • Stud Mount ZCASE® Fuse Holder

The SMZ stud mount fuse holder allows you to mount fusing directly to a M8 or M10 stud on applications such as batteries, alternators, battery switches or electrical relays.

- Mounts directly to a M10 or M8 stud
- Uses high amp ZCASE fuses, (M8) available 40-600A
- Tin plate coating on the busbar ensures corrosion resistance

Download additional technical information at: littelfuse.com/SMZ



PART NUMBERS	MOUNTING SIZE	FUSE TERMINAL NUT (M8)	DETAILS
0FHZ0201Z	M8 (8.5mm)	•	901-525 Fuse/Stud Cover
0FHZ0202Z	M8 (8.5mm)	•	901-524 Fuse Cover
0FHZ0211Z	M10 (10.5mm)	•	901-525 Fuse/Stud Cover
0FHZ0212Z	M10 (10.5mm)	•	901-524 Fuse Cover

ATO® Fuse Blocks with Common Feed

Multi-position black thermoplastic fuse block for ATO fuses. Contacts are recessed for additional safety and a recession in the center of the block accepts a label.

- Common hot feed – stud terminal is 10-32 with hexnut, flat washer and lockwasher
- Blade terminals are .25" wide (6.4mm)
- Four .218" (5.5mm) diameter mounting holes take #10 screws
- Size: 3.375" wide x .812" high (85.7 x 20.6mm)
- Mounting holes 1.06" (27.0mm) on centers, widthwise.

Download additional technical information at: littelfuse.com/Fuseholders



PART NUMBERS			VOLTAGE	MAX CONTINUOUS CURRENT	MAX FUSE RATING PER CIRCUIT	FUSE POSITIONS	DIMENSIONS	MOUNTING HOLES ON CENTERS
BULK	BOXED	RETAIL						
46377-6	46377-6-BX	46377-6-BP	12-24V DC	150A	25A	6	2.47"L x 3.375"W x .812"H	.625"
46377-8	46377-8-BX	–	12-24V DC	150A	25A	8	3.09"L x 3.375"W x .812"H	1.25"
46377-10	46377-10-BX	–	12-24V DC	150A	25A	10	3.72"L x 3.375"W x .812"H	1.875"
46377-12	46377-12-BX	–	12-24V DC	150A	25A	12	4.34"L x 3.375"W x .812"H	2.5"
46377-18	46377-18-BX	–	12-24V DC	150A	25A	18	6.22"L x 3.375"W x .812"H	4.375"
46379-6	46379-6-BX	–	12-24V DC	150A	25A	6	–	–
46379-8	46379-8-BX	–	12-24V DC	150A	25A	8	–	–

Multiple Position Glass Fuse Blocks

2



ATO® Fuse Blocks with 1/4" Quick Connect Terminals

Use with ATO fuses up to 15 amps. Available in 5 pole unit with removable clear protective cover. Available in side or bottom positioned 1/4" Q.C. terminal configurations. Unit with bottom Q.C. terminals includes detachable side mounting brackets.

Download additional technical information at: littelfuse.com/Fuseholders

PART NUMBERS			DETAILS	AMPERAGE	PROTECTIVE COVER
BULK 10-PC	CARDED	CATALOG NUMBER			
03500417TXN	03500417XP	350417BP	1/4" Q.C. side position	2-20A	•
03500418TXN	03500418XP	350418BP	1/4" Q.C. bottom position (includes mounting brackets)	25-30A	•

* Please inquire about additional bulk quantities

Omni-Blok® Fuse Blocks with 1/4" Quick Connect Terminals

For 1/4" x 1-1/4" glass fuses. Available in one through twelve pole units. Units may be easily broken apart as needed to obtain the desired number of poles. Rated at 20A, 300 V

Download additional technical information at: littelfuse.com/Fuseholders



PART NUMBERS		POLES	VOLTAGE	AMP
BULK	CARDED			
03540801ZXGY	—	1	300V	20A
03540802ZXGY	00MN0002XP	2	300V	20A
03540804ZXGY	00MN0004XP	4	300V	20A

Common Hot Feed Glass Fuse Block

Fiber base with 11/64" (4.4mm) diameter mounting holes. Solid brass busbar, phosphor-bronze fuse clips. Brass terminals and screws.

Download additional technical information at: littelfuse.com/Fuseholders



PART NUMBERS			MAX FUSE RATING PER CIRCUIT	FUZE POSITIONS	DIMENSIONS	BUSBAR
BULK	BOXED	RETAIL				
M-414-01	—	M-414-01-BP	20A	4	2.75"L x 2.24"W x .625"H	•
M-415-01	—	—	20A	5	3.50"L x 2.24"W x .625"H	•
M-641-01	M-641-01-BX	M-641-01-BP	20A	6	4.25"L x 2.24"W x .625"H	•
M-643-01	M-643-01-BX	M-643-01-BP	20A	8	5.75"L x 2.24"W x .625"H	•
—	—	—	20A	12	8.75"L x 2.24"W x .625"H	•

M-674 • Combination Glass Fuse Block and Terminal Block

Combination Fuse Block & Terminal Block For SFE 20A or 3AG (AGC) fuses. Common hot feed to four independently-fused circuits, and common ground strip for four circuits. Solid brass busbars, terminals and terminal screws. Nickel-plated phosphor-bronze fuse clips. Two eyelet holes for mounting with 3/16" (4.8mm) screws, 2.25" (57.2mm) on centers.

Download additional technical information at: littelfuse.com/Fuseholders



PART NUMBERS			MAX FUSE RATING PER CIRCUIT	FUZE POSITIONS	DIMENSIONS	BUSBAR
BULK	BOXED	RETAIL				
—	M-674-BX	M-674-BP	20A	4	3.50"L x 2.75"W x .781"H	•

Laminated Base Fuse Block with Screw Terminals

For 1/4" x 1-1/4" glass fuses. Available in one through twelve pole units. Rated at 20A, 300V.

Download additional technical information at: littelfuse.com/Fuseholders



PART NUMBERS					PART NUMBERS				
BULK	BOXED	POLES	VOLTAGE	AMP	BULK	BOXED	POLES	VOLTAGE	AMP
03560001Z	—	1	300V	20A	03560009Z	—	9	300V	20A
03560002Z	—	2	300V	20A	03560010Z	—	10	300V	20A
03560004Z	—	4	300V	20A	03560011Z	—	11	300V	20A
03560006Z	—	6	300V	20A	03560012Z	—	12	300V	20A

Terminal Blocks



M-42X Individual Feed Screw Terminal Blocks

Moisture-resistant molded Bakelite insulator base with barrier strips. Nickel-plated brass terminal links and 8-32 binding head screws.

Download additional technical information at: littelfuse.com/TerminalBlocks

PART NUMBERS			NUMBER OF POSITIONS	TERMINALS		DIMENSIONS	MOUNTING HOLE DIMENSION
BULK	BOXED	RETAIL		MATERIAL	SIZE		
M-426	M-426-BX	M-426-BP	4	Nickel-Plated Brass	8-32	3.22"L x 1.31"W x .67"H	2.81" (71.4mm) on centers
M-427	M-427-BX	M-427-BP	6	Nickel-Plated Brass	8-32	4.33"L x 1.31"W x .67"H	3.93" (99.9mm) on centers
M-428	M-428-BX	M-428-BP	8	Nickel-Plated Brass	8-32	5.46"L x 1.31"W x .67"H	5.06" (128.5mm) on centers
M-429	M-429-BX	M-429-BP	10	Nickel-Plated Brass	8-32	6.59"L x 1.31"W x .67"H	6.19" (157.2mm) on centers
M-456	M-456-BX	-	14	Nickel-Plated Brass	8-32	8.84"L x 1.31"W x .67"H	8.44" (214.4mm) on centers



4721 Individual Feed Stud Terminal Blocks

Moisture-repellent phenolic insulator base with brass stud terminals. Hexnuts, flat washers and lockwashers included. Two mounting holes accept 3/16" (4.8mm) screws (not included).

Download additional technical information at: littelfuse.com/TerminalBlocks

PART NUMBERS			NUMBER OF POSITIONS	TERMINALS		DIMENSIONS	MOUNTING HOLE DIMENSION
BULK	BOXED	RETAIL		MATERIAL	SIZE		
4721-P2	4721-P2-BX	-	2	Brass	10-32	2.68"L x .5/8"W x 27/32"H	1.87" (47.5mm) on centers
4721-P3	4721-P3-BX	-	3	Brass	10-32	3.25"L x .5/8"W x 27/32"H	2.50" (63.5mm) on centers
4721-P4	4721-P4-BX	-	4	Brass	10-32	3.87"L x .5/8"W x 27/32"H	3.12" (79.2mm) on centers
4721-P5	4721-P5-BX	-	5	Brass	10-32	4.5"L x .5/8"W x 27/32"H	3.75" (95.3mm) on centers
4721-P6	4721-P6-BX	-	6	Brass	10-32	5.12"L x .5/8"W x 27/32"H	4.38" (111.3mm) on centers
4721-P8	4721-P8-BX	-	8	Brass	10-32	6.37"L x .5/8"W x 27/32"H	5.62" (142.7mm) on centers
4721-P10	4721-P10-BX	-	10	Brass	10-32	7.62"L x .5/8"W x 27/32"H	6.87" (174.5mm) on centers
4721-P12	4721-P12-BX	-	12	Brass	10-32	8.87"L x .5/8"W x 27/32"H	8.12" (206.2mm) on centers
4721-P14	4721-P14-BX	-	14	Brass	10-32	10.12"L x .5/8"W x 27/32"H	9.37" (238.0mm) on centers



4758 & 4755 Individual Feed Stud Terminal Blocks

Moisture-repellent molded insulator base with barrier strips. Two mounting holes accept 1/4" (6.3mm) screws. Hardware sold separately.

Download additional technical information at: littelfuse.com/TerminalBlocks

PART NUMBERS			NUMBER OF POSITIONS	TERMINALS		DIMENSIONS	MOUNTING HOLE DIMENSION
BULK	BOXED	RETAIL		MATERIAL	SIZE		
4758	4758-BX	-	4	Steel	10-24	4.5"L x .5/8"W x 27/32"H	3.75" (95.3mm) on centers
4755	4755-BX	-	5	Steel	10-24	5.25"L x .5/8"W x 27/32"H	4.5" (114.3mm) on centers

Terminal Blocks

2



M-449 & M-448 Common Busbar Terminal Blocks

Moisture-resistant molded thermoplastic insulator base with solid brass busbar that safely carries up to 50A. Two 1/4-20 brass studs with hexnuts. 8-32 round head screws for attachment of wires. Two mounting holes accept No. 10 countersink flathead screws that are 5.19" (131.5mm) on center for 10-gang version, and 8.31 (211.07mm) on center for 20-gang versions.

Download additional technical information at: littelfuse.com/TerminalBlocks

PART NUMBERS			NUMBER OF POSITIONS	TERMINALS		DIMENSIONS	BUSBAR
BULK	BOXED	RETAIL		MATERIAL	SIZE		
M-449	M-449-BX	M-449-BP	10	Brass	8-32	5.75"L x 1.25"W x 1.031"H	•
M-448	M-448-BX	-	20	Brass	8-32	5.75"L x 1.25"W x 1.031"H	•
M-448-02	-	-	20	Tin-Plated Brass	8-32	8.875"L x 1.25"W x 1.031"H	•

46206-04 Common Busbar Terminal Blocks



Moisture-repellent thermoset plastic insulator base with 3/16" (4.76mm) diameter mounting holes. Eyelets are 3.125" (79.4mm) on centers.

Download additional technical information at: littelfuse.com/TerminalBlocks

PART NUMBERS			NUMBER OF POSITIONS	TERMINALS		DIMENSIONS	BUSBAR
BULK	BOXED	RETAIL		MATERIAL	SIZE		
46206-04	46206-04-BX	-	4	Brass	10-32	3 7/8"L x 5/8"W x 27/32"H	•

86099 Brass Busbars

Solid Brass busbar meant for mounting circuit protection including fuses and circuit breakers. Busbars tested to 70A with temperature rise no greater than 55°C.

Download additional technical information at: littelfuse.com/TerminalBlocks



PART NUMBERS			NUMBER OF POSITIONS	MATERIAL	DIMENSIONS	MOUNTING HOLE DIMENSION
BULK	BOXED	RETAIL				
-	86099-2-BX	-	2	Brass	1.53" long (38.9mm)	.910" (23.1mm) on centers, .021" (5.3mm) diameter.
86099-3	86099-3-BX	-	3	Brass	2.43" long (61.7mm)	
86099-4	86099-4-BX	-	4	Brass	3.34" long (84.8mm)	
86099-5	86099-5-BX	-	5	Brass	4.24" long (107.7mm)	

86126 Copper Busbars

Solid copper busbars meant for mounting circuit protection including fuses and circuit breakers.

Download additional technical information at: littelfuse.com/TerminalBlocks



PART NUMBERS			NUMBER OF POSITIONS	MATERIAL	DIMENSIONS	MOUNTING HOLE DIMENSION
BULK	BOXED	RETAIL				
86126-2	86126-2-BX	-	2	Copper	1.41" x .560" (35.8 x 14.2mm)	.910" (23.1mm) on centers
86126-4	86126-4-BX	-	4	Copper	3.23" x .560" (82.1 x 14.2mm)	2.73" (69.34mm) on centers
86126-6	86126-6-BX	-	6	Copper	5.05" x .560" (128.3 x 14.2mm)	4.55" (115.57mm) on centers
86126-8	86126-8-BX	-	8	Copper	6.87" x .560" (174.5 x 14.2mm)	6.37" (161.79mm) on centers
86126-12	86126-12-BX	-	12	Copper	10.51" x .560" (267.0 x 14.2mm)	10.01" (254.25mm) on centers

AFTERMARKET FUSE HOLDERS

COMPACT DESIGNS SAVE SPACE & REDUCE WIRE CONNECTIONS

SMZ SERIES STUD MOUNT ZCASE® FUSE HOLDER

The SMZ stud mount fuse holder allows you to mount fusing directly to a M8 or M10 stud on applications such as batteries, alternators, battery switches or electrical relays. The SMZ stud mount fuse holder features a compact design which saves space and eliminates the need to wire in a separate fuse holder or power distribution module.

Download additional technical information at: littelfuse.com/SMZ



Specifications

Voltage Rating:	80V DC or max rating of the fuse
Max Continuous Current:	400A
Available Fuse Rating:	40- 600A
Fuse Terminal Torque:	M8 Nut: 14 ± 2 Nm
Operating Temp:	-40° to 105° C

PART NUMBERS	DESCRIPTION
OFHZ0201Z	M8 SMZ Fuse Holder with Fuse and Stud Cover
OFHZ0202Z	M8 SMZ Fuse Holder with Fuse Cover
OFHZ0211Z	M10 SMZ Fuse Holder with Fuse and Stud Cover
OFHZ0212Z	M10 SMZ Fuse Holder with Fuse Cover



BMZ SERIES BATTERY MOUNT ZCASE® FUSE HOLDER KITS

The BMZ battery post mount fuse holder allows you to mount fusing directly to a post style battery terminal. The BMZ series accepts the Littelfuse proprietary ZCASE fuse that is available in 40-600A ratings with similar characteristics to the MEGA® fuse. The BMZ post mount fuse holder mounts directly to the battery without any need for additional mounting hardware and is available in 2 or 3-pole versions.

Download additional technical information at: littelfuse.com/BMZ



Specifications

Max Voltage Rating:	32V DC or max rating of the fuse
Max Continuous Current:	275A
Available Fuse Rating:	40- 600A
Fuse Terminal Torque:	M8 Nut: 14 ± 2 Nm
Battery Terminal Torque:	5.4 ± 0.9 Nm @ 540 RPM
Operating Temp:	-40° to 125° C

PART NUMBERS	DESCRIPTION
OFHZ00854-BX	Kit: 882-854 (2 way bus bar), 876-199 (terminal mount), 901-325 (red cover), 1X M8 Bolt, 3x M8 Nuts
OFHZ00853-BX	Kit: 882-853 (3 way bus bar), 876-199 (terminal mount), 901-325 (red cover), 3x M8 Nuts



Power Distribution Modules



Power Distribution Modules (PDMs) are devices that accept electrical power from one or more wires (inputs) and then distribute it to multiple cables (outputs). The PDMs also accept power protection and control devices from one or more fuse, circuit breaker, relay, diode, or even solid state and electronic circuitry and distribute to multiple outputs.

Blade or Bolt-Down Fuse?

DC (automotive) fuses are offered in two basic forms: Blade or Bolt Down.

Blade & Cartridge fuses can be hand inserted into a fuse holder. These fuses provide protection for several amperage ratings up to 70A. They are well suited to protect smaller to medium diameter wires that are usually some distance from the battery. Single blade fuse holders are often called 'In-Line' fuse holders as they are spliced into the wiring. Remember to place the fuse holder as close to the battery and as far away from the load as possible, so that it protects the wire from a short anywhere along its length. Any short between the power source and the fuse is not protected. Littelfuse blade fuses include: MICRO2®, MICRO3®, MINI®, LP MINI®, ATO®, MAXI, MCASE®, MCASE+®, JCASE® and LP JCASE®.

Bolt Down fuses need to be secured to the fuse holder with a screw or nut/bolt. These fuses provide protection from 30A to 600A. They are well suited to protect medium to large diameter wires that are usually closer to the battery. Ring terminals are crimped onto cables that are connected to these holders and spliced into the wiring. Remember to place the fuse holder as close to the battery and as far away from the load as possible, so that it protects the wire from a short anywhere along its length. Any short between the power source and the fuse is not protected which is why you should have master fusing as close the battery as possible. Littelfuse bolt-down fuses include: MIDI®, MEGA®, CF8 and ZCASE®.

Also, there are still a wide variety of applications that use glass tube fuses. These are typically lower current values and are becoming less popular for most automotive applications due to their size, form factors, and lack of color coding.



Hard-Wired Boxes

HWB Series - Compact Sealed Hard-Wired Boxes for 2.8mm Style Fuses & Relays

The HWB series hard-wired boxes are sealed units that accept any 2.8mm style fuses, relays, circuit breakers or diodes depending on which HWB model is selected. The HWB series is the perfect fit for accessory circuits and overflow circuits from your main power distribution module.

The series features durable construction, IP67 & IP69K ratings, compact sizes, gasket sealed covers and multiple mounting types. See chart below for specific details. The HWB series eliminates the use of internal bussing allowing the user or design engineer to customize the circuitry utilizing direct wire-to-component connections. TPAs (terminal position assurance locks) give secondary locking protection of the wire leads, which aid in prevention of leads from being pulled out and snap onto the back after wires are installed.

- Accepts a combination of 2.8mm components – MINI® fuses, relays, circuit breakers or diodes. (sold separately)
- Cover tethers available to prevent loss of component during service.
- HWB60 series are modular and can be dovetailed together to expand circuit protection capacity. They can also be interlocked to other PDMs and fuse holders (FLEC Flexible Electrical Control Center and MEGA/MIDI Flex fuse holder)
- HWB60 and HWB18 series uses Delphi Metri-Pack 280 terminals, cable seals and cavity plugs. Download datasheet for specific details.
- HWB12 and HWB6 series are available with black or clear covers for easy component status identification.
- HWB12 and HWB6 series use TYCO MCP terminals, cable seals and cavity plugs. See datasheet for specific details.

Datasheet, 3D Models, 2D Prints and additional information: littelfuse.com/HWB



SERIES	PART NUMBERS		MAX CONTINUOUS CURRENT	MAX FUSE RATING PER CIRCUIT	NUMBER OF CAVITIES	MOUNTING TORQUE	INGRESS PROTECTION	DIMENSIONS	TERMINALS (sold separately)		KIT CONTENTS				
	BULK	RETAIL							DELPHI METRI-PACK	TYCO MCP	COVER	AssureLatch	GASKET	TPAs	BRACKET
HWB60-AL	PDM71001ZXM	–	250A	30A	60	4-6 Nm	IP67 & IP69K	113x52x82mm	•		Black	•	•	•	
HWB60-AL	PDM71003ZXM	–	250A	30A	60	4-6 Nm	IP67 & IP69K	113x52x82mm	•		Black	•	•	•	
HWB60	PDM21001LXM	–	250A	30A	60	4-6 Nm	IP67 & IP69K	113x52x82mm	•		Black		•	•	
HWB18	PDM31001ZXM	–	200A	30A	18	5.5-6.5 Nm	IP67 & IP69K	60x38x74mm	•		Black		•	•	•
HWB18	PDM31002ZXM	–	200A	30A	18	5.5-6.5 Nm	IP67 & IP69K	60x38x74mm	•		Black		•	•	
HWB12	PDM33001ZXM	–	130A	30A	12	5.5-6.5 Nm	IP67 & IP69K	83x70x44mm		•	Clear	•	•	•	
HWB12	PDM33003ZXM	–	130A	30A	12	5.5-6.5 Nm	IP67 & IP69K	83x70x44mm		•	Clear	•	•	•	•
HWB12	PDM33004ZXM	–	130A	30A	12	5.5-6.5 Nm	IP67 & IP69K	83x70x44mm			Black				•
HWB6	PDM32001ZXM	–	68A	30A	6	5.5-6.5 Nm	IP67 & IP69K	71x64x36mm		•	Clear	•	•	•	
HWB6	PDM32003ZXM	–	68A	30A	6	5.5-6.5 Nm	IP67 & IP69K	71x64x36mm		•	Clear	•	•	•	•
HWB6	PDM32004ZXM	–	68A	30A	6	5.5-6.5 Nm	IP67 & IP69K	71x64x36mm			Black				•

Power Distribution Modules

HWA20 Series • ATO® Fuse Hard-Wired Box



Compact hard-wired fuse holder holds up to 10 ATO blade fuses, with a combined amperage up to 210A. Perfect for accessory circuits, overflow circuits from main power distribution module, or as a main module on smaller vehicles.

- Without internal bussing: enables the user to customize the circuitry.
- Dovetail slots on the sides of the box interlock with other units.
- Easy to connect wires plug into the back of the unit using industry-standard Tyco sealed power terminals.

Download additional technical information at: littelfuse.com/HWA20

3

SERIES	PART NUMBERS		MAX CONTINUOUS CURRENT	MAX FUSE RATING PER CIRCUIT	FUSE POSITIONS	MOUNTING TORQUE	INGRESS PROTECTION	DIMENSIONS	CONTENTS		
	BULK	RETAIL							COVER	GASKET	TPAs
HWA20	PDM61001ZXM	–	210A	40A	10	4-6 Nm	IP67	161x40x52mm	•	•	•



MTR Series • (2+2) MINI® & JCASE® Fuse Hard-Wired Box

Sealed low to medium current fuse holder houses two JCASE cartridge fuses and two MINI bladed fuses. Holder is gasket-sealed to protect fuses from moisture and contamination. Fuses are internally bussed to a single main power stud – one input powers four fuse circuits. Utilizes the MINI fuse for fast-acting 2-30A circuit protection and the JCASE cartridge style fuse with increased time delay for 20-60A medium current circuits. Output circuits are designed for use with Delphi terminals.

Download additional technical information at: littelfuse.com/MTR

SERIES	PART NUMBERS		MAX CONTINUOUS CURRENT	MAX INPUT CURRENT	FUSE POSITIONS	MOUNTING TORQUE	INGRESS PROTECTION	DIMENSIONS	CONTENTS		
	BULK	RETAIL							COVER	GASKET	TPAs
MTR	BPDMA104HXF1	–	100A	2-60A	4	6-8 Nm	IP67	86x34x77mm	•	•	•



LTX Series • 4 position MEGA® & 2 position MIDI® Fuse Box

The LTX Power Distribution Module is a high current sealed primary fuse box that can be placed in the battery box, or near the battery box to fuse major feeder cables. Featuring bussed input to all 6 MEGA and 2 MIDI fuses. All bolt down connections are made inside of the seals which enhances the environmental protection of the box.

Download additional technical information at: littelfuse.com/LTX

SERIES	PART NUMBERS		VOLTAGE	MAX CONTINUOUS CURRENT	FUSE POSITIONS	MOUNTING TORQUE	INGRESS PROTECTION	DIMENSIONS	CONTENTS		
	BULK	RETAIL							COVER	GASKET	BUSBAR
LTX	07981002ZXS	–	6-32V DC	240A	6	10-12 Nm	IP66	231x312x60mm	•	•	•



SL Series • 350A • Power Distribution Module

The SL Series provides main battery shutdown from a remote location, optional manual control knob switches high-amp circuits, three switched 30A to 200A MIDI® fuse location, four unswitched 24-hour 1A-20A ATO® fuse locations and eliminates significant factory or field interconnections

- Littelfuse Remote Control Switch: 880092

Download additional technical information at: littelfuse.com/SL

SERIES	PART NUMBERS		MAX CONTINUOUS CURRENT	MAX FUSE RATING PER CIRCUIT		FUSE POSITIONS	TERMINAL STUD TORQUE	INGRESS PROTECTION	DIMENSIONS	CONTENTS	
	BULK	RETAIL		MIDI	ATO					COVER	GASKET
SL	880076	–	350A	170A	30A	7	20 Nm	IP59K	152x102x45mm	•	

Power Distribution Modules



MDB Series • MIDI® Fuse Distribution Box

Internally bussed, water-proof and dust-proof fuse holder developed for high current loads, and harsh conditions. The unit is well-suited for near-the-battery applications and can be mounted in exposed locations to fit your design. Available for 2 or 3 MIDI fuses and includes the cover seal and M5 thread bolts for a fuse installation. Kits include seals, plugs and caps. Fuses are sold separately.

- AssureLatch™ Technology keeps the cover securely in place while allowing for fast service.
- Included tether connects cover to base preventing misplacement.
- The module is internally bussed allowing for high current power distribution.
- Sealed to IP67 and IP69K for maximum flexibility in mounting location.

Download additional technical information at: littelfuse.com/MDB

PART NUMBERS		POLES	VOLTAGE	MAX CONTINUOUS CURRENT	MAX FUSE RATING PER CIRCUIT	MOUNTING TORQUE	INGRESS PROTECTION	DIMENSIONS	CONTENTS	
BULK	BOXED									
04980932ZXT	–	2	6-58V DC	200A	200A	6-8 Nm	IP67 & IP69K	131x68x38mm	2-pole box with busbar and nuts	
04980933ZXT	–	3	6-58V DC	200A	200A	6-8 Nm	IP67 & IP69K	131x68x38mm	3-pole fuse box with busbar and nuts	
–	04980932.X	2	6-58V DC	200A	200A	6-8 Nm	IP67 & IP69K	131x68x38mm	Input: 1x 25 mm² cap 1x 25 mm² seal	Output: 2x 6-10 mm² seal 3x 10-16 mm² seal 1x plug & 1x 6-16 mm² cap
–	04980933.X	3	6-58V DC	200A	200A	6-8 Nm	IP67 & IP69K	131x68x38mm		

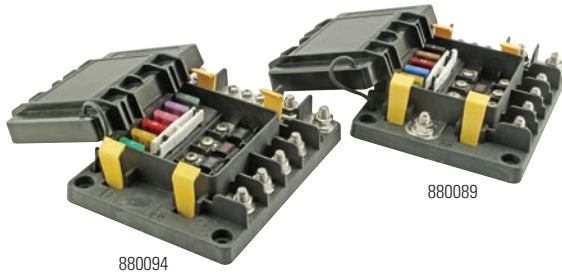

LX Series • 200A & 600A • ATO® & MIDI® Fuse PDM

Protect high and low-amp circuits while providing a collection point for ground returns, and eliminate battery box clutter and damage to battery terminals when adding circuits. Combines an ignition protected fuse block with screw termination. Holds four 30A-200A MIDI fuses and six 1A-30A ATO fuse locations. Negative bus provides common location for ground returns.

- The 880094 provides one fused input feeding the unit and other fuses while, the 880089 has an unfused input feeding the fuse circuits.

Download additional technical information at: littelfuse.com/LX

SERIES	PART NUMBERS		MAX CONT. CURRENT	MAX FUSE RATING PER CIRCUIT		FUSE POSITIONS	TERMINAL STUD TORQUE	INGRESS PROTECTION	DIMENSIONS	CONTENTS		
	BULK			MIDI	ATO					COVER	GASKET	PULLER
LX	880089		600A	170A	30A	10	20 Nm	IP59K	165x127x51mm	•	•	•
	880094		200A	170A	30A	10	20 Nm	IP59K	165x127x51mm	•	•	•



XT Series • 350A • ATO® & MIDI® Fuse PDM

The XT combines an ATO fuse block that has integrated sealed plug outputs (FCI APEX 2.8mm female 4-way connector p/n 54200409) and a MIDI fuse block that consolidates up to seven circuits from 1–200A. Three 30–200A MIDI fuse locations are ideal for high-amp circuits and four 1–40A ATO fuse locations for low-amp circuits. Tin-plated copper busbar and stainless steel studs and hardware provides superior corrosion resistance.

Download additional technical information at: littelfuse.com/XT

SERIES	PART NUMBERS		MAX CONTINUOUS CURRENT	MAX FUSE RATING PER CIRCUIT		FUSE POSITIONS	TERMINAL STUD TORQUE	INGRESS PROTECTION	DIMENSIONS	CONTENTS	
	BULK			MIDI	ATO					COVER	GASKET
XT	880073		350A	170A	30A	7	20 Nm	IP59K	152x102x45mm	•	•

Power Distribution Modules



FLEC® Series • Configurable Flexible Electrical Center

The Flexible Electrical Center (FLEC) is a power distribution module for the commercial vehicle market. It accommodates circuit protection components in a compact, sealed footprint. The PCB accepts active and passive devices. Part number below is a standard market version but FLEC is configurable to your custom electrical schematic and can be programmed to create a simple “plug-and play” system.

- High component density maximizes available space and limits the number of additional units required.
- The versatile nature of the FLEC unit means it can accept a large number of component types.
- Rugged and sealed, the unit boasts an IP67 rating which allows it to be mounted in locations susceptible to moisture and dirt without any adverse effects

Download additional technical information at: littelfuse.com/FLEC

SERIES	PART NUMBER	DESCRIPTION	VOLTAGE	MAX LOAD	MAX FUSE RATING	FUSE CAPACITY	RELAY CAPACITY	INGRESS PROTECTION	OUTPUT CONNECTORS
FLEC	FLEC3000Z-0	With MINI Fuses & Relays	12-24V DC	300A	30A	28	18	IP67	Delphi GT
FLEC	FLEC3000Z-0U	No Fuses or Relays	12-24V DC	300A	30A	28	18	IP67	Delphi GT

3



MiniFlec Series • 150A • Connectorized Power Distribution Module

The standard MiniFlec is a compact, front access, internally bussed, connectorized, sealed power distribution module, suitable for mounting in rugged commercial vehicle applications. An internally mounted Printed Circuit Board (PCB) allows bussed connections to a large number of devices.

- Designed for panel mounting (rear fed connectors). Base compression limiters prevent over-torquing when unit is mounted
- Tethered cover securely latches to base, with positive AssureLatch yellow latches

Download additional technical information at: littelfuse.com/MINIFLEC

SERIES	PART NUMBERS	MAX LOAD	FUSE RATING RANGE	INPUT STUD	MOUNTING TORQUE	INGRESS PROTECTION	DIMENSIONS	RELAY CAPACITY
	BULK							
MINIFLEC	LFMX0007Z-01	150A	MINI® Fuse: 2-30A MCASE+® Fuse: 15-60A	M8	12-15Nm	IEC 529 IP67/69K	157mm x 96mm x 126mm	3 Form C 280 Series Micro Relays, 3 Form A Ultra Micro Relays, 1 ISO Micro Relay



EPC Series • 200A • Connectorized Power Distribution Module

The standard EPC is an internally bussed, connectorized, sealed power distribution module, suitable for mounting in rugged commercial vehicle applications. The EPC is a product that has dense concentration of high power circuits and accepts plug devices like automotive fuses, diodes and relays to protect and control complex electrical systems. An internally mounted Printed Circuit Board (PCB) allows bussed connections to a large number of devices.

Download additional technical information at: littelfuse.com/EPC

SERIES	PART NUMBERS	MAX LOAD	FUSE RATING RANGE	MOUNTING TORQUE	INGRESS PROTECTION	DIMENSIONS	RELAY CAPACITY
	BULK						
EPC	LFMX0006Z-01	200A	5 to 30A	6 - 8 Nm	IP67 / IP69K	179mm x 155mm x 69 mm	Tailor to application - Up to 3 Form C 280 and 6 Form A 280 Relays



FHZ Series • 400A • Power Distribution Module

The 5 Stud ZCASE Fuse Holder uses a single power input (usually with a ZCASE shunt) and a common busbar to feed up to 4 additional ZCASE fused circuits. Freely interchangeable ZCASE fuse ratings; configurable stud size (M6, M8, or M10); and available 2-, 3-, 4-, or 5-position busbars allow for a wide range of possible configurations.

Download additional technical information at: littelfuse.com/5StudZCASE







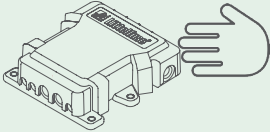
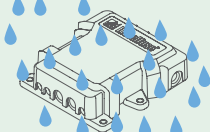
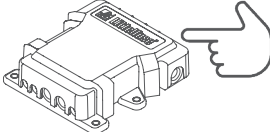

SERIES	PART NUMBER	DESCRIPTION	AMPERAGE	MAX FUSE RATING	FULL ASSEMBLY	CONTACT TEMP	DIMENSIONS
FHZ	0FHZ0001Z	Assembly with Bolts and Bus Bar	400A	40-600A		-40° to 105° C	217mm x 86mm x 59mm
FHZ	0FHZ0002Z	Full Assembly with M10 Input			•		
FHZ	0FHZ0003Z	Box Only for Configuration					
FHZ	0FHZ0005Z	Full Assembly with M8 Input			•		

Ingress Protection Explained

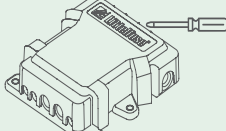
Harsh Environments and Ingress Protection Ratings

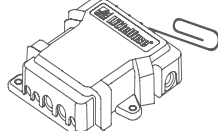
Environmental factors play a huge role in a product's ability to do its job and survive the lifetime of the equipment. Ingress Protection, or IP, indicates the degree of protection of a power distribution module. IP ratings are a measure of how resistant a part is to environmental contaminants such as debris, dust, and water. IP rating selections should be based on where the PDM will be mounted and what type of environment the equipment will be used in.

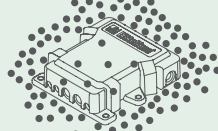
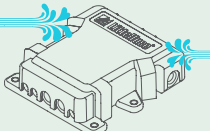
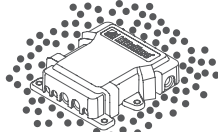
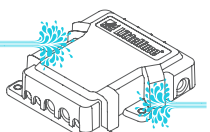
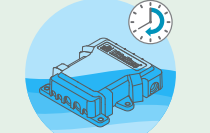
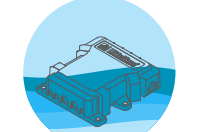
The numbers following IP represent levels of sealing and can range from no sealing (IP00) to protection against dust and continuous immersion in water (IP68). The table below provides a description of the protection at each level.

1st Digit - SOLID Degree of protection against solid objects	2nd Digit - LIQUID Degree of protection against water
 <p>1 Protected against a solid object greater than 50mm</p>	 <p>1 Protected against vertically falling water drops</p>
 <p>2 Protected against a solid object greater than 12.5mm</p>	 <p>2 Protected against vertical water drops when enclosure tilted up to 15 degree angle</p>
 <p>3 Protected against a solid object greater than 2.5mm</p>	 <p>3 Protected against spraying water from up to a 60 degree angle</p>
 <p>4 Protected against a solid object greater than 1.0mm</p>	 <p>4 Protected against splashing water</p>
 <p>5 Dust Protected. Prevents ingress of dust sufficient to cause harm</p>	 <p>5 Protected against water jets</p>
 <p>6 Dust tight. No ingress of dust.</p>	 <p>6 Protected against powerful water jets</p>
<p>Example</p> <p>IP67</p>	 <p>7 Protected against the effects of temporary immersion in water between 15cm and 1m for 30 minutes</p>
<p>Dust tight. No ingress of dust. Protected against effects of temporary submersion in water.</p>	 <p>8 Protected against the effects of continuous immersion in water under conditions agreed between manufacturer and user</p>
	 <p>9K Protected against close-range high pressure, high temperature spray downs</p>

Battery Management



Isolators or Combiners?

Battery Isolators are passive (not intelligent) devices. They are a basic technology that prevents current from draining from one battery into the other. As current passes through the internal diodes there's a loss of efficiency, that equates to a voltage loss of 10-15%. Another problem arises when battery isolators are used with the more recent 'smart alternators'. Such alternators incorporate sensors which 'read' the state of the battery, but the isolator's diodes interfere with the alternator's sensors. It is therefore important to use a battery combiner in such application.

Battery combiners provide the same function as isolators, but without the substantial voltage loss, and they work in harmony with smart alternators. They also may have additional useful features, such as boost; they are smaller and lighter; and since they are installed between the battery banks, there is no need to cut the original OEM heavy cable from alternator to battery.

No More Dead Batteries!

If you leave a fully charged battery connected in an inactive vehicle, it could be dead in as little as two months. Vehicles have electronics that continue to draw small quiescent currents to maintain their memory, even when the vehicle is off. Over an extended period of time this small current can drain the battery. Complete discharge of the battery can cause permanent damage and prevent proper battery recharging.

If your vehicle requires short or long term storage and has a lot of electronics (computer, TV, stereo, etc) a Low Voltage Disconnect can be installed to automatically disconnect these components when battery voltage falls below a critical threshold and automatically reconnects when the battery is recharged. This lengthens the storage life of your battery.

85-200A Smart Battery Isolators



Battery Combiners are hybrid electronic/electromechanical relays that prevent loads on the auxiliary battery from draining the starting battery. This type is more flexible than Diode Battery Isolators: works with all types of alternator; it is smaller and lighter; no efficiency loss due to diodes; allows bi-directional charging from the alternator or from shore power; reduces the load on the charging system by not connecting the auxiliary battery until the primary battery is charged to 13.2V.

- Works with most types of alternators
- Smaller and lighter than traditional isolators
- No efficiency losses due to diodes
- Allows bi-directional charging from the alternator or from shore power
- Reduces the load on the charging system by not connecting the auxiliary battery until the primary battery is charged to 13.2V extending the life of expensive charging components.

Datasheet, wiring diagram, and 2D prints: littelfuse.com/BatteryManagement

PART NUMBERS		AMPS	VOLTAGE	TERMINAL STUDS	INGRESS PROTECTION	CONNECT VOLTAGE	DISCONNECT VOLTAGE	QUIESCENT CURRENT	TERMINAL STUD TORQUE
BULK	BOXED								
48525	48525-BX	85A	9-16V DC	5/16-24"	IP66	13.2V typical after 2min	12.7V after 1min	5mA typical, 8mA max	35 in-lbs (3.95Nm)
48530	48530-BX	200A	9-16V DC	5/16-24"	IP66	13.2V typical after 2min	12.7V after 1min	5mA typical, 8mA max	35 in-lbs (3.95Nm)

4

3 & 4 Stud Diode Battery Isolators

For vehicles with two batteries, these devices electrically isolate the batteries to prevent the battery with the higher charge from draining into that with the lower charge. In addition, both batteries can be charged simultaneously from one source.

The solid-state components are embedded to give excellent protection from adverse conditions, such as contamination and vibration. The integral heat sink provides efficient heat dissipation. The amp rating of each item is the maximum alternator rating.

Some alternators on vehicles have an integral electronic voltage regulator that requires the use of the 4-stud battery isolator. The small 4th stud is for connection to a circuit switched by the ignition switch. These alternators were first introduced by Delco and are therefore sometimes called 'Delcotron-type alternators'. Battery Isolators have a 'per leg' rating which indicates the maximum current that it can deliver to each battery. All Battery Isolators have a per leg rating equal to half the alternator rating. Thus a 48122 battery isolator with an alternator rating of 140A has a per leg rating of 70A per leg.

Additional information: littelfuse.com/BatteryManagement

Schottky Diode - Comply to KKK-A-1822B spec for Ambulances



PART NUMBERS		AMPS	VOLTAGE	TERMINALS		DIMENSIONS	ALTERNATOR TYPE
BULK	BOXED			NUMBER OF STUDS	THREADS		
48051	48051-BX	75A	12V DC Only	2	2x 1/4"	3-1/2" x 4-15/16" x 3-11/32"	-
48161	48161-BX	250A	12-36V DC	3	3x 5/16"	8-1/2" x 4-3/16" x 3-13/32"	Delcotron-Type
48122	48122-BX	140A	12-36V DC	4	3x 5/16" & 1 #10	6" x 4-3/16" x 3-11/32"	
48162	48162-BX	200A	12-36V DC	4	3x 5/16" & 1 #10	8-1/2" x 4-3/16" x 3-13/32"	
48070	48070-BX	70A	12-36V DC	3	3x 1/4"	5" x 3-1/4" x 2-3/16"	Without Integral Electronic Voltage Regulator
48090	48090-BX	90A	12-36V DC	3	3x 1/4"	6-1/2" x 3-1/4" x 2-13/16"	
48120	48120-BX	140A	12-36V DC	3	3x 5/16"	6" x 4-3/16" x 3-11/32"	
48160	48160-BX	200A	12-36V DC	3	3x 5/16"	8-1/2" x 4-3/16" x 3-13/32"	

3- Stud Wiring Diagram

48070, 48080, 48090, 48160 and 48161



Battery Combiners & FlexMod™ Devices

FlexMod™ Electronic Devices

The FlexMod Series of products are compact, robust electronic modules with two inputs (one analog and one digital) and two solid state outputs (one 10A, one 200 mA) that can be programmed to do almost any job. Littelfuse offers standard units listed below to meet the most common application needs.

Additional technical information: Littelfuse.com/FlexMod

- Auto-ranging to automatically senses the voltage of the system (12 or 24V) and selects the presets appropriate to that voltage.
- Ultra low 1mA standby current means minimal battery drain – especially valuable when vehicle is in storage or not in use.
- Factory programmable unit is versatile with a broad range of presets available for special applications.
- Rated for more than 1,000,000 on-off cycles – unit operates for the lifetime of the vehicle. Solid state technology gives long life and low maintenance.
- Provides overvoltage and overcurrent protection to every direct load in that circuit– for extra protection.
- Small lightweight sealed design – Uses less space; mounts outside or inside. Saves money by eliminating other hardware, and provides better wire routing



4

PART NUMBERS		TYPE	HARNESS INCLUDED
BULK	BOXED		
-	48636-01-BX	Timer for Trailer Lighting	•
48610	48610-BX	Low Voltage Disconnect	
-	48541-01-BX	Voltage Sensing Relay & Timer	•
48540	-	Smart Battery Isolator Controller	
-	48540-01-BX	Smart Battery Isolator Controller	•

Low Voltage Disconnect - 48610: Preserves battery charge and protects battery banks by automatically disconnecting loads when battery voltage drops to a critical level.

Smart Battery Isolator Controller - 48540: Monitors two battery banks and controls one relay or contactor to make sure starting power is protected by isolating the starting and auxiliary battery banks.

Low Voltage Disconnect Accessories

Accessories for 48513 and 48514 series low voltage disconnects.



58326-06



55088



12804

PART NUMBERS		DETAILS	NOTES
BULK	BOXED		
48710	-	FlexMod Unit	Programmable FlexMod LVD Unit • 10A • 9V DC
58326-06	-	Rocker Switch	SPDT • On-Off-Mom On • 5 Blade Terminals • Red LED
55088	55088-BX	Toggle Switch	SPDT • On-Off-Mom On • 3 Screw Terminals
12804	-	Harness	Deutsch DT06-4S connector • 0462-201-1641 terminal • W4S wedge and wiring
12805	-	FlexMod Harness	FlexMod 8-Pin Deutsch Harness Accessory

How A Smart Battery Isolator Works

Normal Operation Sequence

1 When the vehicle has been running, the alternator charges both battery banks through the Smart Isolator.

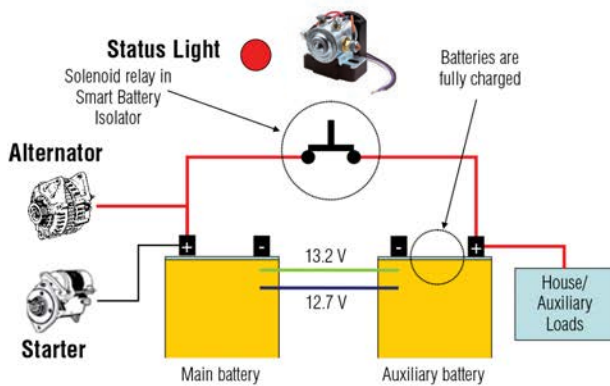

2 When the engine is turned off, the alternator no longer supplies a charge to the batteries, and the loads on the batteries begin to deplete them.

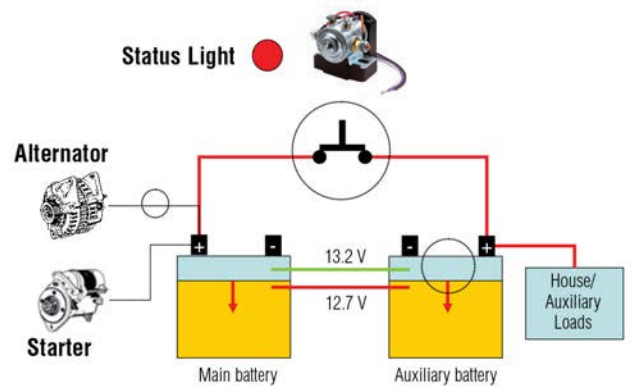

3 When batteries reach 12.7V, the Smart Battery Isolator senses it, opens the solenoid relay to separate the battery banks, and turns off the status light. This protects the starting battery while allowing the auxiliary battery to continue to power the auxiliary loads.

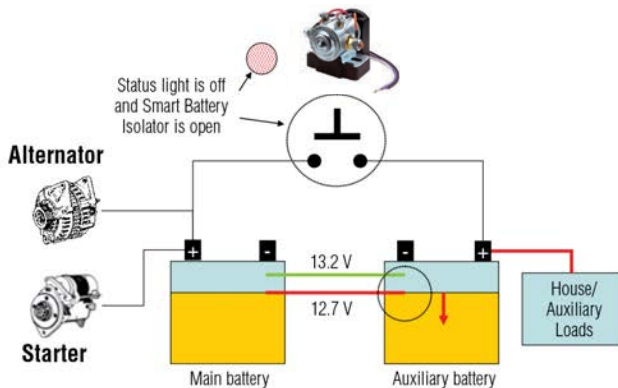

4 When the vehicle is restarted, the starting battery has enough power to crank the engine, but the auxiliary battery is significantly depleted. The Smart Battery Isolator is open and the battery banks are separated.

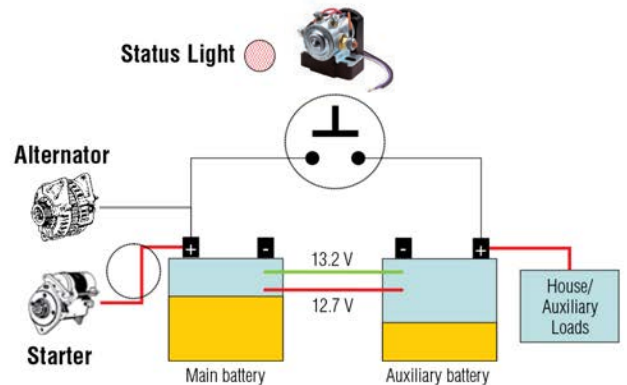

5 The engine is powering the alternator, and the starting battery has reached 13.2V. Only now does the Smart Battery Isolator reconnect, enabling the depleted auxiliary battery to be charged. By not reconnecting until the main battery is charged, the alternator is protected from excessive loads.

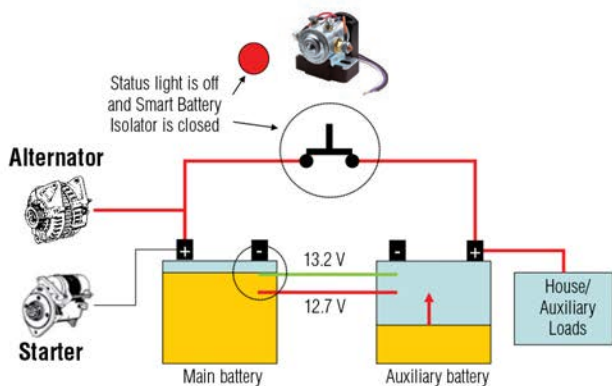

6 Now both batteries are charged again.

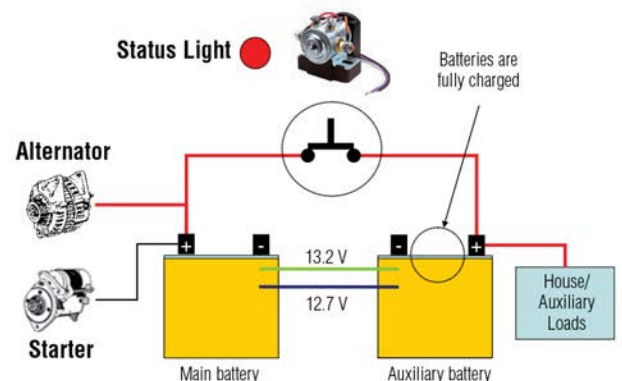

Relays & Solenoids



DC solenoids are relays used for remote switching of electrical currents from 20A to 600A. Littelfuse offers a variety of DC solenoids and relays, such as solid state relays, plug-in relays, compact relays among others.

Solenoids or Relays?

The terms solenoid and relay are interchangeable and refer to a type of remote switch. In the automotive context, solenoid refers to the metal can device. A relay refers to all other such devices including the small micro relays referenced later in this section. The word solenoid actually refers to the helical windings that create the magnetic force which pulls the plunger in the core. Littelfuse manufactures a very broad range of remote switches.



Intermittent or Continuous?

Relays are rated for Intermittent Duty or Continuous Duty. Intermittent duty relays are rated with maximum On times and minimum Off times, which is a workable situation in many applications. Exceed those specs and you run the risk of burning out the coil windings. You cannot use an Intermittent Duty relay for continuous service, but you can use a Continuous Duty relay for intermittent service – although you would be purchasing a relay that is in excess of your needs.

Bistable & Latching?

When it comes to solenoids or relays, both bi-stable and latching refer to the same function. A bi-stable state is one in which a moving contact is at rest in two configurations, either the On or Off position. This is achieved by a mechanical or magnetic latching mechanism which maintains contact in the ON or OFF position while device is not energized. A more well-known example of the mechanical style is the mechanism of a retractable ballpoint pen, where the user pushes to move the ballpoint out of the housing, and pushes again to retract the ballpoint. The point remains in either of two stable states until the user presses the actuator.

In standard solenoids or relays, a control current has to be maintained in order to keep the plunger in the On position; in a bi-stable relay, control current is only applied when changing between the two states of Off and On. This provides many advantages – no current is used in the On or Off states, and bi-stable relays generate less heat.



Bi-Stable Latching Relays



HD Series • 300A General Purpose Bi-Stable Relays

- Very low current draw to maintain closed circuit
- Remotely-operated 300A disconnect for high-amperage circuits
- Small control wires: eliminates the cost and weight of routing large copper cables
- Bi-stable (latched) operation draws no current in On or Off: eliminates a continuous demand on batteries.
- LED output wire enables remote indication of relay status – Open or Closed.
- Silver alloy contacts assure the lowest voltage drop / resistance and extends cycling life of the device.
- Stainless steel hardware and tin-plated copper contacts maximize resistance in harsh environments.

Download additional technical information at: littelfuse.com/HD-Relay

PART NUMBERS			VOLTAGE	AMPERAGE	INGRESS	NOTES
BULK	BOXED	RETAIL				
880086	–	–	12V DC	300A	IP66/IP69k	–
880088	–	–	24V DC	300A	IP66/IP69k	–



HD Time Delay Series • 250A Bi-Stable Relay

The Heavy Duty Time Delay Bi-Stable Relay is able to disconnect the battery from the electrical system of vehicles in 12V and 24V, with voltage self-recognition.

- It includes immediate switch ON, controlled switch OFF with programmable delay time and service state managing (service switch OFF and switch ON).
- This Heavy Duty Time Delay Bi-Stable Relay has a non-volatile memory, low battery alert system and is thermal protected.

Download additional technical information at: littelfuse.com/HDTimeDelay

PART NUMBERS	VOLTAGE	AMPERAGE	VOLTAGE RANGE	INGRESS	NOTES
08070900	12/24V DC	250A	8.5V to 32V @ 23°C	IP67	Light Line Current Rating: 1.3A continuous (6.5A protected)

SD Series • 300-600A Bi-Stable Relay

An all-vehicle battery disconnect, designed to support remote power switching applications. Great for high continuous current passage, large engine starting needs and high ambient temperatures.

- Small control wires: eliminates the cost and weight of routing large copper cables to an accessible switch
- Dedicated 24-hour output, thermally protected, for tachograph or other keep-alive functions.
- Supports multiple Off switch control applications.
- Ignition protected to SAE J1171 and ISO 8846 for installation in battery box or with hazardous loads.
- Auxiliary relay contacts (normally open & normally closed) for Alternator Field Disconnect (AFD) or for additional vehicle system control

Download additional technical information at: littelfuse.com/SD-Relay



PART NUMBERS			VOLTAGE	AMPERAGE	CIRCUITRY	INGRESS	NOTES
BULK	BOXED	RETAIL					
880107	880107S	–	12V DC	300A	Dual Pole	IP66/IP69k	4/0 input/output cables

48785 • 85A Electronic Relay/Switch

Fully solid-state with no moving parts to wear out that is completely sealed, ignition protected and designed to withstand vibration for harsh environments. Relays can be used in both high side and low side switching application and are suitable for high inrush demand circuits.

- Resistance: .005 Ω
- Control Current: .02A max
- Temperature Range: -40°C to +85°C
- On-Off Cycles: 20 million



PART NUMBERS			VOLTAGE	AMPERAGE		INGRESS	DIMENSIONS
BULK	BOXED	RETAIL		CONTINUOUS	INTERMITTENT		
48785	48785-BX	–	9-31V DC	85A	175A	IP67	3.0 x 5.0 x 2.9 in

Standard High Current Relays

6-36V DC • 35-200A • Continuous Duty Solenoids

- Hex nuts and lock washers are included
- Steel housing mounting holes: 5/16 x 19/32," 2 13/64" on centers (7.9 x 15.1, 56.0mm)
- Plated steel housing available with optional PVC coating available to protect critical components from environmental hazards

Datasheet, wiring diagram, and additional pack sizes: littelfuse.com/ContinuousDutySPST

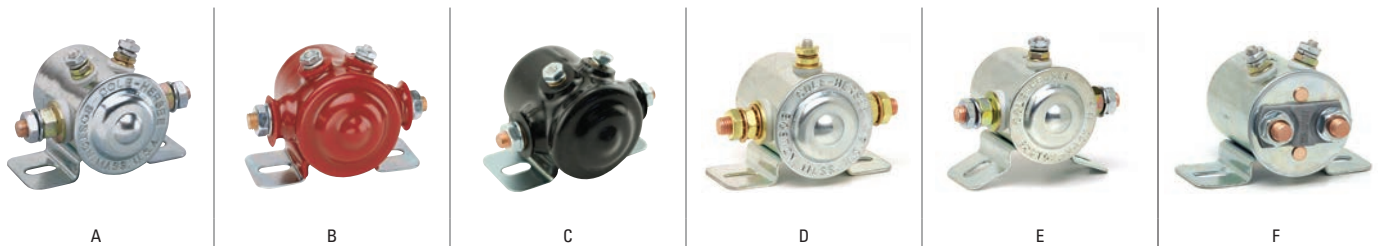

5

PART NUMBERS			VOLTAGE	AMPS	INSULATED / GROUNDED	CIRCUITRY	FORM / CONTACTS	CONTACT	TERMINALS		PVC COATED	UL LISTED	IMAGE	DIAGRAM	NOTES
BULK	BOXED	RETAIL							LARGE	SMALL					
24080	24080-BX	-	36	85	Insulated	SPST	NO	Copper					A	1	
24063	24063-BX	-		85	Insulated	SPST	NO	Copper					A	1	
24063-08	24063-08-BX	-		85	Insulated	SPST	NO	Copper			•	•	B	1	
24214	24214-BX	-	24	200	Insulated	SPST	NO	Silver					A	1	
-	24107-BX	-		85	Insulated	SPST	NO	Copper					D	2	
24124	24124-BX	-		85	Grounded	SPST	NO	Copper					D	4	
24115	24115-BX	-		85	Insulated	SPST	NO	Copper					D	3	
24059	24059-BX	-		85	Insulated	SPST	NO	Copper					A	1	
24059-15	-	-		85	Insulated	SPST	NO	Silver					A	1	
24059-08	24059-08-BX	24059-08-BP		65	Insulated	SPST	NO	Copper	Copper 5/16"-24	Steel 10-32"		•	A	1	Intermittent rating: 750A Make, 100A Break 10 sec on, 30 min off
24117	24117-BX	-		85	Insulated	SPST	NO	Copper			•		B	1	
24117-01	24117-01-BX	24117-01-BP	12	65	Insulated	SPST	NO	Copper			•	•	B	1	Intermittent rating: 750A Make, 100A Break 10 sec on, 30 min off
24213	24213-BX	-		200	Insulated	SPST	NO	Silver					A	1	
24213-01	-	-		200	Insulated	SPST	NO	Silver					A	1	Potted Coil - IP66
24213-03	-	-		200	Insulated	SPST	NO	Silver			•		C	1	Black Coating
24106	24106-BX	-		85	Grounded	SPST	NO	Copper					D	4	
24106-07	24106-BX	-		85	Grounded	SPST	NO	Copper					C	4	P/N, Date Code, Voltage ink stamped on surface
24082	24082-BX	-		85	Grounded	SPST	NO	Copper					E	4	Curved Bracket
-	24420-BX	-		35	Insulated	SPST	NC	Copper					F	5	
24097	24097-BX	-	6	85	Grounded	SPST	NO	Copper					A	1	

Continuous Duty Solenoid Wiring Diagrams

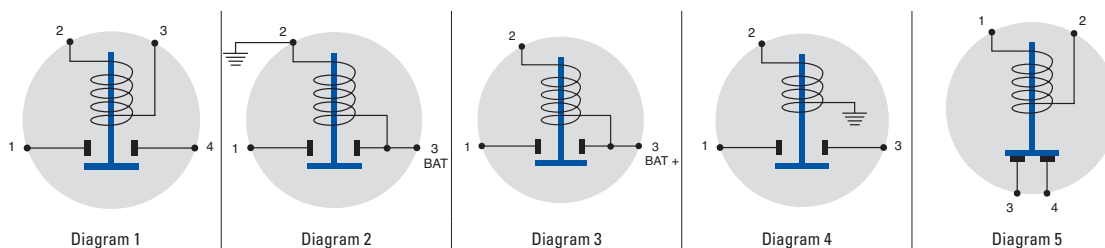

Standard High Current Relays

12V DC • Intermittent Duty Solenoids

- Hex nuts and lock washers are included
- Steel housing mounting holes: 5/16 x 19/32," 2 13/64" on centers (7.9 x 15.1, 56.0mm)
- Phenolic housing mounting holes: 9/32 x 25/64," 2 7/64" on centers (7.1 x 9.9, 53.6mm)
- Solenoids available in phenolic, plated steel or PVC coated housings to protect critical components from environmental hazards
- Resistor shorting circuit solenoids (p/n 24103/24021) feature a 3 that is normally open and becomes common with 1 and 4 when the solenoid is energized. Commonly used in engine starting applications.

Datasheet, wiring diagram, and additional information: littelfuse.com/IntermittentDutySPST



PART NUMBERS			VOLTAGE	AMPS		DUTY CYCLE	INSULATED / GROUNDED	CIRCUITRY	FORM / CONTACTS	HOUSING MATERIAL	CONTACT TERMINALS	SMALL TERMINALS	IMAGE	DIAGRAM	NOTES	
BULK	BOXED	RETAIL		MAKE	BREAK											
24037	24037-BX	-	12	750A	100A	On: 10 sec Off: 20 min	Grounded	SPST	NO	Plated Steel	Copper 5/16" -24 threads	Copper 10-32	A	1		
24071	24071-BX	-	12	750A	100A	On: 10 sec Off: 20 min	Grounded						PVC Coated	B	1	
24044	24044-BX	-	12	750A	100A	On: 10 sec Off: 20 min	Grounded						Plated Steel	C	1	Curved Bracket
24022	24022-BX	-	12	750A	100A	On: 10 sec Off: 20 min	Grounded						Phenolic	D	1	
24103	24103-BX	-	12	750A	100A	On: 10 sec Off: 20 min	Grounded						Plated Steel	E	3	Resistor Shorting Circuit
24021	24021-BX	-	12	750A	100A	On: 10 sec Off: 20 min	Grounded						Phenolic	D	3	Resistor Shorting Circuit
24047	24047-BX	-	12	750A	100A	On: 10 sec Off: 20 min	Insulated						Plated Steel	E	4	
24076	24076-BX	-	12	750A	100A	On: 10 sec Off: 20 min	Insulated						PVC Coated	F	4	
24060	24060-BX	-	12	750A	100A	On: 10 sec Off: 20 min	Insulated						Plated Steel	A	5	
-	24046-BX	-	12	750A	100A	On: 10 sec Off: 20 min	Insulated						Plated Steel	A	6	
24023	24023-BX	-	12	750A	100A	On: 10 sec Off: 20 min	Insulated						Phenolic	D	2	
24008-03	-	-	24	750A	120A	On: 10 sec Off: 20 min	Insulated						Plated Steel	E	-	Components shipped unassembled
24008	24008-BX	-	24	750A	120A	On: 10 sec Off: 20 min	Insulated						Plated Steel	E	-	Special spring for stronger contact return force
-	24041-BX	-	6	750A	100A	On: 10 sec Off: 20 min	Insulated						Plated Steel	A	-	

5

Intermittent Duty Solenoid Wiring Diagrams

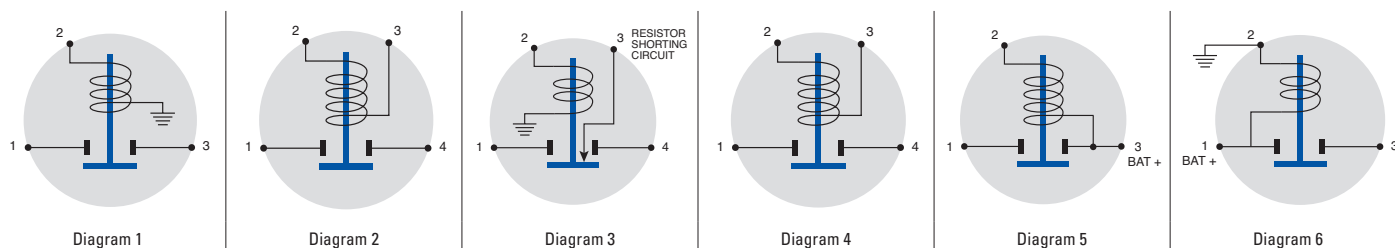

Standard High Current Relays

Continuous Duty Two Circuit Solenoids

Special applications: Forward and reverse systems in electric golf carts, garden tractors, fork lift trucks, winches, etc.

- Hex nuts and lock washers are included
- Mounting holes: 5/16 x 19/32," 2 13/64" on centers (7.9 x 15.1, 56.0mm)

Datasheet, wiring diagram, and additional information: littelfuse.com/ContinuousDutyDPST

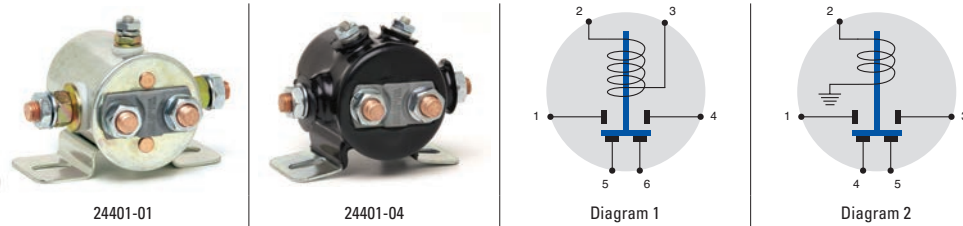

PART NUMBERS			VOLTAGE	AMPS		COIL TYPE	CIRCUITRY	PVC COATED	CONTACTS		TERMINALS	DIAGRAM
BULK	BOXED	RETAIL		NC	NO				MATERIAL	THREADS		
24402	24402-BX	-	24	35	85	Insulated	DPST	-	Copper	5/16"-24	Steel 10-32"	1
24401	24401-BX	-	12	35	85	Insulated	DPST	-	Copper	5/16"-24	Steel 10-32"	1
24401-04	24401-04-BX	-	12	35	85	Insulated	DPST	•	Copper	5/16"-24	Steel 10-32"	1
24401-01	24401-01-BX	-	12	35	85	Grounded	DPST	-	Copper	5/16"-24	Steel 10-32"	2

5

100-225A • Heavy Service Plastic Body Solenoids

For starting small engines, including lawn tractors, golf carts and sweepers.

- Small ignition and ground terminals are 10-32 thread
- Large contact terminals are 5/16" -24 thread.

Additional information: littelfuse.com/PlasticBodyRelays

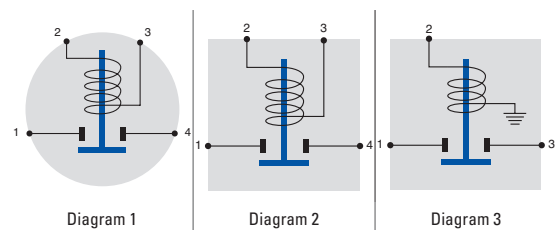

24848 - L-Bracket



24624-10 - F-Bracket



24612-10 - F-Bracket

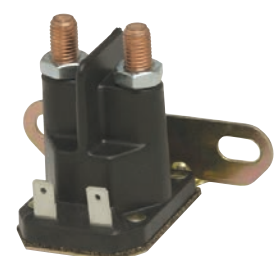

24512-10 - Bracket

PART NUMBERS			TYPE	VOLTAGE	MAX VOLTAGE	AMPS		COIL TYPE	CIRCUITRY	FORM / CONTACTS	MOUNTING BRACKET	CONTACTS	COIL TERMINALS	DIAGRAM	
BULK	BOXED	OTHER				MAKE/BREAK	INRUSH								
24848	-	-	Continuous Duty	48	48	225	600	Insulated	SPST	NO	L-Bracket	Silver 5/16"-24	10-32 studs	1	
24824-01	24824-01-BX	-		24	-	225	600	Insulated	SPST	NO	L-Bracket	Silver 5/16"-24	10-32 studs	1	
24812	24812-BX	-		12	14	225	600	Insulated	SPST	NO	L-Bracket	Copper 5/16"-24	10-32 studs	1	
24812-01	24812-01-BX	-		12	14	225	600	Insulated	SPST	NO	L-Bracket	Silver 5/16"-24	10-32 studs	1	
24624-10	24624-10-BX	-		24	27	100	400	Insulated	SPST	NO	F-Bracket	Silver 5/16"-24	10-32 studs	2	
24512-10	24512-10-BX	-		12	14	100	400	Insulated	SPST	NO	F-Bracket	Silver 5/16"-24	Blade	2	
24612	24612-BX	24610-G10-BX		12	-	225	400	Insulated	SPST	NO	L-Bracket	Silver 5/16"-24	10-32 stud	1	
24612-10	24612-10-BX	-		12	14	100	400	Grounded	SPST	NO	F-Bracket	Silver 5/16"-24	10-32 stud	3	
24612-03	24612-03-BX	-		Intermittent Duty	12	-	200	300	Insulated	SPST	NO	L-Bracket	Copper 5/16"-24	10-32 studs	2

Reversing & Latching Solenoids



70A • Forward & Reverse Relay Module

Ideal for tarp or lift applications. Also use on hoists, hatches, winches, snowplows, intake/exhaust fans, vehicle outriggers and other reversing applications. Module automatically reverses the direction of the motor when the appropriate control circuit is energized with a pulse from a control switch. Dynamic braking stops the motor when the switch returns to Off.

- Dimensions: 2.91" × 3.51" × 1.86" H (73.9 × 91.7 × 47.2mm)

Download additional technical information at: littelfuse.com/24450

PART NUMBERS			VOLTAGE	AMPERAGE		INRUSH	SEALING	CONTACTS
BULK	BOXED	RETAIL		INTERMITTENT	CONTINUOUS			
24452	24452-BX	–	12V DC	70A (On: 5 min max, Off: 3 min)	50A	150A	IP67	Silver



12-24V DC • 150A Motor Reversing Intermittent Duty Solenoid

A combination of two solenoids in one package to reduce cost and maximize space savings while also providing simpler wiring.

- 75A Make/Break: 5 min On, 5 min Off
- 125A Make/Break: 30 sec On, 5 min Off
- 150A Make/Break: 0.5 sec On, 5 min Off

Download additional technical information at: littelfuse.com/24450

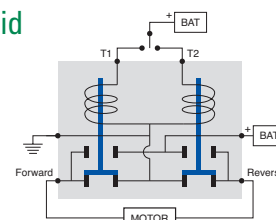

PART NUMBERS			VOLTAGE	AMPS	COIL TYPE	CIRCUITRY	CONTACTS	TERMINALS	
BULK	BOXED	RETAIL						Two Blade Coil	5/16"-24 Large Studs
24450	24450-BX	–	12V DC (14.5 max)	75-150A	Common Ground	DPDT	Copper	Two Blade Coil	5/16"-24 Large Studs
24450-02	–	–	24V DC	75-150A	Common Ground	DPDT	Copper	Two Blade Coil	5/16"-24 Large Studs



24200 • 110A Standard High Current Latching Solenoid

Requires only a momentary application of coil power to operate. Minimal heat is generated, because the coil is de-energized when the solenoid is On.

- Continuous Duty Style (Rated at 110A carry only)

Download additional technical information at: littelfuse.com/24200



PART NUMBERS			VOLTAGE	AMPS	COIL TYPE	CIRCUITRY	FORM / CONTACTS	HOUSING MATERIAL	CONTACTS	TERMINALS
BULK	BOXED	RETAIL								
24200	24200-BX	–	12V DC	110A	Insulated	SPST	NO	Plated Steel	Copper 5/16"-24	Steel 10-32"

Plug-In Relays



Heavy Duty High Power and Micro Plug-In Relays

General purpose relays fit many vehicles and applications. Typical applications include: lighting, starting, horn, heating and cooling.

Standard ISO terminal footprint for Form A, Form C and Form 2A. Relays are available sealed and unsealed (unsealed 40 & 70A relays are supplied with snap-in brackets.)

Datasheet, wiring diagram, and additional information: littelfuse.com/Plug-In-Relays

Specifications

- Pull-in voltage: 78V maximum at 12V DC, 15.6 V at 24V DC
- Release voltage: 1.2 V minimum at 12V DC, 2.4 V at 24V DC
- Temperature range: -40°C to 85°C
- Operational life: Electrical to 100,000 cycles.
Mechanical to 10,000,000 cycles
- Contact Material: Silver alloy
- Dielectric strength: 500 V rms between coil and contact
- Insulation resistance: 100 MΩ minimum (500V DC)
- Relays are rated based on a steady state resistive load. De-rate according to the type of load.
 - Motor load: Inrush can be 5 to 10 x steady state current.
 - Solenoid load: Inrush can be 10 to 20 x steady state current.
 - Incandescent lamp load: Inrush can be 10 to 15 x steady state current.
- Available with PCB terminals, contact Littelfuse for details.

Heavy Duty Relays • 40A at 12V DC

- Contact rating (Resistive load) at 20°C:
 - 12V DC: Normally Open 40A, Normally Closed 30A
 - 24V DC: Normally Open 20A, Normally Closed 15A
- Contact arrangement: Available as Form A (SPST), Form C (SPDT) and Form 2A (SPST, 2 terminals)
- Vibration resistance: 10-40Hz double amplitude 1.5mm

High Power Relays • 70A at 12V DC

- Contact rating (Resistive load) at 20°C:
 - 12V DC: Normally Open 70A, Normally Closed 60A
 - 24V DC: Normally Open 35A, Normally Closed 30A
- Contact arrangement: Available as Form A (SPST) and Form C (SPDT)
- Vibration resistance: 10-40Hz double amplitude 1.5m

Micro Relays • 25A at 12V DC

- Contact rating (Resistive load) at 20°C:
 - 12V DC: Normally Open 25A, Normally Closed 20A
- Contact arrangement: Available as Form A (SPST), and Form C (SPDT).
- Vibration resistance: 10-40Hz double amplitude 1.27mm

Part Numbering System



Relay Part Numbers

PART NUMBERS		VOLTAGE	AMPS	RELAY TYPE	FORM	BRACKET	SUPPRESSOR TYPE	SEALED
BULK	BOXED							
R2-400112-RN	-	12	40	Relay	2	SPST	•	Resistor
RA-200024-DS	-	24	20	Relay	A	SPST		Diode
RA-400012-DS	-	12	40	Relay	A	SPST		Diode
RA-400112-DN	RA-400112-DN-BX	12	40	Relay	A	SPST	•	Diode
RA-400112-NN	RA-400112-NN-BX	12	40	Relay	A	SPST	•	None
RA-400112-RN	RA-400112-RN-BX	12	40	Relay	A	SPST	•	Resistor
RA-700112-RN	RA-700112-RN-BX	12	70	Relay	A	SPST	•	Resistor
RA-700112-DN	RA-700112-DN-BX	12	70	Relay	A	SPST	•	Diode
RA-700112-NN	RA-700112-NN-BX	12	70	Relay	A	SPST	•	None
RC-200024-DS	-	24	20	Relay	C	SPDT		Diode
RC-200124-DN	RC-200124-DN-BX	24	20	Relay	C	SPDT	•	Diode
RC-200124-NN	RC-200124-NN-BX	24	20	Relay	C	SPDT	•	None
RC-200124-RN	RC-200124-RN-BX	24	20	Relay	C	SPDT	•	Resistor
RC-400012-DS	RC-400012-DS-BX	12	40	Relay	C	SPDT		Diode
RC-400112-DN	RC-400112-DN-BX	12	40	Relay	C	SPDT	•	Diode
RC-400112-NN	RC-400112-NN-BX	12	40	Relay	C	SPDT	•	None
RC-400112-RN	RC-400112-RN-BX	12	40	Relay	C	SPDT	•	Resistor
RC-700112-DN	RC-700112-DN-BX	12	70	Relay	C	SPDT	•	Diode
RC-700112-NN	RC-700112-NN-BX	12	70	Relay	C	SPDT	•	None
RC-700112-RN	RC-700112-RN-BX	12	70	Relay	C	SPDT	•	Resistor
MC-250012-DN	-	12	25	Micro	C	SPDT		Diode
MC-250012-NN	-	12	25	Micro	C	SPDT		None
MC-250012-RN	-	12	25	Micro	C	SPDT		Resistor

Modular Relay Sockets • Bi-Stable Relay

Accepts Littelfuse brand relays and standard ISO relays.



- Modular – sockets dovetail together
- Accepts standard quick-connect terminals
- Easy mount bracket
- Constructed of rugged glass-filled polyamide
- Temperature range: -40°C to 85°C

PART NUMBERS			RELAY TYPE		FORM	NOTES
BULK	BOXED	RETAIL CLAMSHELL	AMPERAGE	TERMINAL WIDTH		
99025	99025-BX	–	70A	.375"	A	Use with Tyco (AMP) terminals 280756 or 280755 (consult terminal manufacturers for full specs)
99026	99026-BX	–	40A	.250"	A or C	Use with Tyco (AMP) terminals 42281 or Ark-Les 3000H112A series (consult terminal manufacturers for full specs)

Plug-In Relay & MicroRelay Schematics and Terminal Layout

General purpose relays fit many vehicles and applications.

FORM	RELAY SCHEMATICS	RELAY TERMINAL LAYOUTS (40A .250" terminals – 70A .375" terminals)	MICRORELAY TERMINAL LAYOUTS
Form A			
Form C			
Form 2			– Not Available –

Battery & Master Disconnect Switches



Master Disconnect Switches are available for any application and suitable for 12V to 48V and up to 500A continuous (at 12V). Other features include: single or dual pole configurations, stem or flange mount, with lockout/tagout and lever or keyed actuators.

Lockouts & Tagouts

Lockouts and tagouts prevent operators, technicians and maintenance personnel from unanticipated power-ups that might cause injury or death.

According to OSHA, "A lockout device utilizes a positive means such as a lock to hold an energy isolating device in a safe position and prevent the energization of a machine." A tagout is a tag or seal that states 'Do not operate or remove this tag' and is signed by the person who places the tagout. Procedures specify that nobody but that person may remove the tag.

A lockout on a battery switch not only keeps a vehicle safe, but also immobilizes it. A locked out vehicle is less vulnerable to battery drain or theft.



What is a Hencol Key?

Hencol is a Cole Hersee brand name used to describe our non-bitted common keys. Hencol keys are often used for ignition switches installed in forklifts or equipment that will have multiple operators. The non-bitted key allows any authorized user with a Hencol key to start and operator the vehicle.

The term Hencol is named after one of the Cole Hersee founders and is a truncation of his name, Henry Cole.





TR Series • 500A Dual Pole Battery Disconnect Switch

Cuts all battery power from vehicle electrical system, or for applications needing switching of two circuits, or both positive and negative.

- 500A continuous current rating for each of the two circuits (2x 4/0 input and 2x 4/0 output cables)
- Can be used to switch two vehicle voltage circuit simultaneously (12 & 24V DC)
- Built-in lockout satisfies OSHA requirements for an energy isolation device
- Ignition protected to SAE J1171 and ISO8846 for installation in a battery box or on vehicles carrying hazardous loads
- Ingress protection to IP67 and IP69k means that the switch can be mounted in exposed locations.

For datasheet, wiring diagram, and additional pack sizes visit: littelfuse.com/TRswitch

PART NUMBERS			VOLTAGE	AMPERAGE	CIRCUITRY	INGRESS	MOUNTING METHOD
BULK	BOXED	RETAIL					
880175	880175S	–	12-24V DC	500A	DPST	IP67 & IP69K	Surface Mount



75920 Series • 400A Sealed Battery Disconnect Switch

Protects vehicles against tampering, theft and battery drain. Switch protects from hazards during vehicle servicing and provides an effective emergency power cutoff. Can be used in both positive or in negative path applications. Built-in lockout satisfies OSHA requirements for an energy isolation device.

- 400A continuous at 12V DC — 3000A intermittent at 12V DC (15sec on 5 min off)
- Waterproof and dustproof to IP68 - switch can be mounted in exposed locations
- Built-in lockout satisfies OSHA requirements for an energy isolation device
- Large red knob is easy to operate with gloves
- Large divider on base prevents accidental shorting of high energy cables

For datasheet, wiring diagram, and additional pack sizes visit: littelfuse.com/75920

PART NUMBERS			VOLTAGE	AMPERAGE	CIRCUITRY	INGRESS	MOUNTING TYPE	NOTES
BULK	BOXED	RETAIL						
75920	75920-BX	75920-BP	12-36V DC	200-400A	SPST	IP68	Through-Hole	Bezel marked "off - on"
75920-05	75920-05-BX	–	12-36V DC	200-400A	SPST	IP68	Through-Hole	Bezel marked "O - I" symbols
75920-10	75920-10-BX	–	12-36V DC	200-400A	SPST	IP68	Through-Hole	Stainless Steel Hardware
75921-10	–	–	12-36V DC	200-400A	SPST	IP68	Through-Hole	Stainless Steel Metric Hardware



SR Series • 300A Flange Mount Battery Disconnect Switches

Isolates high current DC circuits from battery sources. Available in multiple case designs with optional padlock capability.

- 300A continuous current rating
- Tin-plated copper studs provide maximum conductivity and lower contact resistance.
- Stainless steel hardware provides superior corrosion resistance.
- Ignition protected to SAE J1171 and ISO8846 for installation in a battery box or on vehicles carrying hazardous loads.

For datasheet, wiring diagram, and additional pack sizes visit: littelfuse.com/SRswitch

PART NUMBERS			MAX VOLTAGE	AMPERAGE (AT 12V DC)	CRANKING RATING (12V DC, 30sec)	INGRESS	MOUNTING METHOD	NOTES
BULK	BOXED	RETAIL						
880062	–	–	48V DC	300A	1250A (1 x 4/0 cable)	IP67 & IP69K	Through-Hole	–
880064	880064S	–	48V DC	300A	1250A (1 x 4/0 cable)	IP67 & IP69K	Surface Mount	Lock-Out
880154	–	–	36V DC	600A	2500A (1 x 4/0 cable)	IP67 & IP69K	Surface Mount	High-Cranking with Lock-Out
888842000A	–	–	12 V DC	5A	–	–	Panel Mount	–

Battery Disconnect Switches



08098700

100-150A • SPST • UP4X/IP43 • Compact Battery Disconnect Switch

08098700 is Standard Compact Manual Battery Disconnect Switch that features a removable handle with a plastic body. Rated to 100A continuous current this switch is ideal light-duty applications.

08099080 is an upgraded design with bigger contacts (M10) and improved components for heavier 150A current loads within the same compact dimensions, which make it one of the most popular products for 12V applications. This Manual Battery Disconnect Switch features a removable handle with a plastic body and rubber cap is included for protection while switch is removed from the socket.

For additional information visit: littelfuse.com/ManualBatterySwitches



08099080

Mounting Diagram

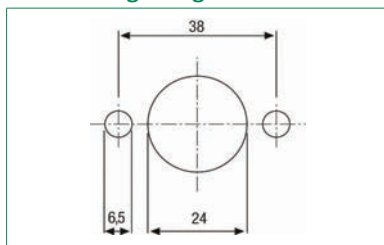

Electrical Diagram

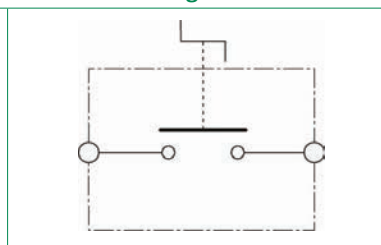

PART NUMBERS			VOLTAGE	AMPERAGE	INTERMITTENT CURRENT	CIRCUITRY	INGRESS	MOUNTING	TERMINALS	TERMINAL HARDWARE	NOTES
BULK	BOXED	RETAIL									
08098700	08098700-BX	–	12-24V DC	100A	500A at 5s	SPST	IP4X	Flange Mount	M8 Copper	Brass	–
08098780	08098780-BX	–	12-24V DC	150A	1000A at 5s	SPST	IP4X	Flange Mount	M10 Copper	Brass	–
08099080	08099080-BX	08099080-BP	12-24V DC	150A	1000A at 5s	SPST	IP43	Flange Mount	M10 Copper	Zinc-Plated Steel	Key Seal and Cap

6



08080200

150A • SPST • IP65 • M10 Studs • Push to Off Compact Battery Disconnect Switch

Manual Battery Disconnect Switch features a push button for fast push to off operation in the event where a quick reaction is necessary.

Rotate knob for ON. Switch status is indicated though a window on the top of the knob.

For additional information visit: littelfuse.com/ManualBatterySwitches

PART NUMBERS		VOLTAGE	AMPERAGE	INTERMITTENT CURRENT	CIRCUITRY	INGRESS	MOUNTING	TERMINALS	NOTES
BULK	BOXED								
08080200	08080200-BX	12-24V DC	150A	1200A at 5s	SPST	IP65	Through-Hole	M10 Silver-Plated Copper	Push to off



08081400

200A • SPST • IP67 • Marine Single Pole Main Battery Switch

Marine single pole main battery switch with a metal body. Heavy duty and resistant against corrosion, to be used on heavy trucks, farm tractors, buses, commercial vehicles end especially on boats.

Switch features 200A continuous current rating, removable handle,. the “V” shape of the terminals allows for easy cable connections, and reduces risk of arcing. This switch is also RINA ISO-8846 approved and is equipped a white rubber protection cap

For additional information visit: littelfuse.com/ManualBatterySwitches

PART NUMBERS		VOLTAGE	AMPERAGE	INTERMITTENT CURRENT	CIRCUITRY	INGRESS	MOUNTING	TERMINALS	NOTES
BULK	BOXED								
08081400	08081400-BX	24V DC	200A	1000A at 5s	SPST	IP67	Through-Hole	M10 Brass	Removable Key

Battery Disconnect Switches



08098800

250A • SPST • IP65-IP69K • M10 Studs • Battery Disconnect Switch

Manual battery switch with removable or fixed handle and available with weather protective boots. For additional information visit: littelfuse.com/ManualBatterySwitches

08098800 - Base unit with removable handle

08098881 - Unit with removable handle and chain. Red and yellow rubber boots for weather protection and to help identify different applications. Interchangeable with Bosch 0341002003 switches

08098882 - Unit with fixed handle and integrated lock-out tag-out. Red, yellow and black rubber boots for weather protection and to help identify different applications. Latest design that does not require accessory for lockout tagout. Interchangeable with Bosch 0341002003 switches



08098882

Mounting Diagram

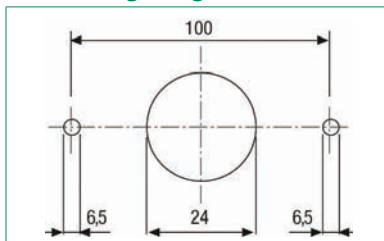

Electrical Diagram



PART NUMBERS		VOLTAGE	AMPERAGE	INTERMITTENT CURRENT	CIRCUITRY	INGRESS	MOUNTING	TERMINALS	TERMINAL HARDWARE	NOTES
BULK	BOXED									
08098800	08098800-BX	24V DC	250A	2500A at 3s	SPST	IP65	Flange Mount	M10 Copper	Zinc-Plated Steel	Removable Handle
08098881	08098881-BX	24V DC	250A	2500A at 3s	SPST	IP65/IP69k	Flange Mount	M10 Copper	Zinc-Plated Steel	Removable Handle w/ Chain, Keyhole Cover Red & Yellow Boots
08098882	08098882-BX	24V DC	250A	2500A at 3s	SPST	IP65/IP69k	Flange Mount	M10 Copper	Zinc-Plated Steel	Fixed Handle w/ Integrated Lock-Out Tag-Out Black, Red & Yellow Boots



08010200

250A • SPST • IP65 • Push to Off Battery Disconnect Switch

Manual Battery Disconnect Switch features a turn to on and a push to off operation. Easy to operate and shut off vehicle power in emergency situations.

Switch features and identical mounting pattern to metal body removable key switches so the same application has multiple options with minimal design changes.

For additional information visit: littelfuse.com/ManualBatterySwitches

PART NUMBERS		VOLTAGE	AMPERAGE	INTERMITTENT CURRENT	CIRCUITRY	INGRESS	MOUNTING	TERMINALS	NOTES
BULK	BOXED								
08010200	08010200-BX	24V DC	250A	2500A at 3s	SPST	IP65	Flange Mount	M10 Silver Plated Copper	Push-to-Off



08010100

300A • SPST • IP65 • 360° Rotation Battery Disconnect Switch

Manual Battery Disconnect Switch features a fixed handle and metal body. The handle and contacts are designed with a unique 360° operation for activating the switch ON-OFF. The handle can be rotated either left or right to switch the circuit status. Switch is ON when handle is aligned with the terminals and OFF when perpendicular with the terminals.

For additional information visit: littelfuse.com/ManualBatterySwitches

PART NUMBERS		VOLTAGE	AMPERAGE	INTERMITTENT CURRENT	CIRCUITRY	INGRESS	MOUNTING	TERMINALS	NOTES
BULK	BOXED								
08010100	08010100-BX	24V DC	300A	1000A at 10s	SPST	IP65	Flange Mount	M10 Copper	360° Handle Rotation

Battery Disconnect Switches



08098900

350A • SPST • IP65-IP69K • M12 Studs • Battery Disconnect Switch

Manual switches with a removable or fixed handle and weather protective boot depending on part number selected. For additional information visit: littelfuse.com/ManualBatterySwitches

08098900 - base unit with removable handle

08098980 - switch with removable handle with black boot and chain

08098981 - switch with fixed handle and black boot



08098980

Mounting Diagram



Electrical Diagram



PART NUMBERS		VOLTAGE	AMPERAGE	INTERMITTENT CURRENT	CIRCUITRY	INGRESS	MOUNTING	TERMINALS	TERMINAL HARDWARE	NOTES
BULK	BOXED									
08098900	08098900-BX	12-24V DC	350A	2500A at 3s	SPST	IP65	Flange Mount	M12 Silver-Plated Copper	Zinc-Plated Steel	Removable Handle
08098980	08098980-BX	12-24V DC	350A	2500A at 3s	SPST	IP65	Flange Mount	M12 Silver-Plated Copper	Zinc-Plated Steel	Removable Handle w/ Chain Keyhole Cover
08098981	08098981-BX	12-24V DC	350A	2500A at 3s	SPST	IP65/IP69K	Flange Mount	M12 Silver-Plated Copper	Zinc-Plated Steel	Fixed Handle w/ Black Boot

6



08084300 & 08084400

250-500A • DPST • IP67/IP69K • Dual Pole Battery Disconnect Switch

250A-500A Dual Pole manual battery master switch with removable or fixed handle. High performance design with industry leading mechanics and materials featuring modern advancements in the design evolution of manual battery disconnects.

- Smartkey allows handle to removable or fixed, locking it in either the OFF or ON position
- Protective rubber cap with an auto-protection feature ensures protection when the handle is removed

For additional information visit: littelfuse.com/ManualBatterySwitches

Electrical Diagram

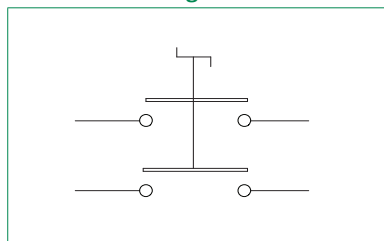

PART NUMBERS		VOLTAGE	AMPERAGE	INTERMITTENT CURRENT	CIRCUITRY	INGRESS	MOUNTING	TERMINALS	TERMINAL HARDWARE	NOTES
BULK	BOXED									
08084300	08084300-BX	24V DC	250A	1000A at 2s	DPST	IP67/IP69K	Flange Mount	M10 Silver-Plated Copper	Nickel Plated Brass	-
08084400	08084400-BX	24V DC	500A	1500A at 2s	DPST	IP67/IP69K	Flange Mount	M12 Silver-Plated Copper	Nickel Plated Brass	-

Single-Pole Battery Switches



2484 Series • 175A • SPST • Single Pole Metal Body Battery Disconnect Switches

Designed to disconnect the battery circuit on 6-36V DC systems.

- Two positions: Off-On.
- Mounting Stem: Brass, 3/4" -16 thread with one of two lengths:
 - 23/32" (18.3mm) long, fits panels up to 3/16" (4.8mm) thick
 - 17/32" (13.5mm) long, fits panels up to 1/4" (6.4mm) thick
- Torque: Mounting Stem 20 ft/lb max - 3/8" nuts 70-90 in/lbs
- Electrical ratings on UL labels are conservative

For datasheet, wiring diagram, and additional pack sizes visit: littelfuse.com/2484



2484 with steel case and diecast lever



2484-03 with steel case and Hencol lock



Dimensions

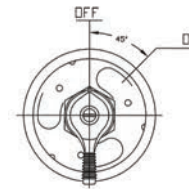

2-position lever model

PART NUMBERS			VOLTAGE	AMPERAGE		CASE	TERMINAL STUDS	MOUNTING STEM		ACTUATOR	CONTACTS	INDEXING PIN	O-RING SEAL	TERMINAL SEAL	UL LISTED				
BULK	BOXED	RETAIL		CONTINUOUS	INTERMITTENT			MATERIAL	SIZE										
2484	2484-BX	-	6V DC	40A	250A	Plated Steel	Two 3/8"-24	Brass	23/32 long	Lever	Copper				•				
			12V DC	20A	125A						Silver				•				
2484-16	2484-16-BX	-	6-36V DC	175A	800A (15s On-5m Off)					Hencol Key	Brass		•						
24024	-	-									Silver								
2484-A	2484-A-BX	-								Lever	Silver		•	•					
2484-06	2484-06-BX	-									Copper								
2484-09	2484-09-BX	-								17/32 long	1000A (15s On-5m Off)	Hencol Key	Silver		•				
2484-02	2484-02-BX	-											Silver		•	•			
2484-03	2484-03-BX	-										Silver		•	•				
2484-19	2484-19-BX	-										Silver		•	•	•			

6

SPST Wiring Diagram



75908

75908 Series • 300A • SPST • Single Pole High Current Battery Switches

Designed to disconnect the battery circuit on 6-36V DC systems. Two positions: Off-On.

- Mounting Stem: Brass, 3/4" -16 thread, 17/32" (13.5mm) long fits panels up to 1/4" (6.4mm) thick
- Torque: Mounting Stem 20 ft/lb max - 3/8" nuts 70-90 in/lbs

For additional information visit: littelfuse.com/75908

PART NUMBERS			VOLTAGE	AMPERAGE		CASE	TERMINAL STUDS	MOUNTING STEM		ACTUATOR	CONTACTS	INDEXING PIN	O-RING SEAL	TERMINAL SEAL	UL LISTED
BULK	BOXED	RETAIL		CONTINUOUS	INTERMITTENT			MATERIAL	SIZE						
75908	75908-BX	-	12V DC	300A	2000A (30s On-3m Off)	Plated Steel	Two 1/2"-20	-	3/4-16 17/32" long	Lever	Copper			•	

Double-Pole Battery Switches



75900 Series • 125A • DPST • Double Pole Metal Body Battery Switches

Designed to disconnect the battery circuit and the alternator or generator field circuit on 6-36V DC systems.

- Mounting Stem: Brass, 3/4" -16 thread with one of two lengths:
 23/32" (18.3mm) long, fits panels up to 3/16" (4.8mm) thick
 17/32" (13.5mm) long, fits panels up to 1/4" (6.4mm) thick

- Torque: Mounting Stem 20 ft/lb max - 3/8" nuts 70-90 in-lbs

For datasheet, wiring diagram, and additional pack sizes visit: littelfuse.com/75900



2-position lever model



75903 / 75904



75904-02 / 75904-03



75912

PART NUMBERS			VOLTAGE	AMPERAGE			CASE	TERMINAL STUDS	MOUNTING STEM		ACTUATOR	CONTACTS	INDEXING PIN	O-RING SEAL	TERMINAL SEAL	UL LISTED
BULK	BOXED	RETAIL		LARGE STUDS		SMALL STUDS			MATERIAL	SIZE						
				CONTINUOUS	INTERMITTENT	CONTINUOUS										
75903	75903-BX	-	6-36V DC	125A	1000A 15s On 5m Off	20A	Plated Steel	Two 3/8"-24 Two 10-32	Brass	Chrome Lever	Brass					
75904	75904-BX	-									Silver					
75904-01	75904-01-BX	-									Silver	•	•	•		
75904-02	75904-02-BX	-									Hencol Key	Silver	•			
75904-03	75904-03-BX	-									Silver	•	•			
75912	75912-BX	-			750A 15s On 5m Off	-		Four 3/8-24	-	Chrome Lever	Silver	•	•	•		

Note: 75912 has epoxy seal at case, mounting stem and indexing pin. Operating Temp: -40° to 85°F

DPST Wiring Diagram



75912 Wiring Diagram (For two high current loads)



75907

75907 Series • 300A • DPST • Double Pole High Current Battery Switches

Designed to disconnect the battery circuit and the alternator or generator field circuit on 6-36V DC systems. Two positions: Off-On.

- Mounting Stem: 3/4" -16 thread, 23/32" (18.3mm) long, fits panels up to 3/16" (4.8mm) thick
- Torque: Mounting Stem 20 ft/lb max - 3/8" nuts 70-90 in-lbs

For datasheet, wiring diagram, and additional pack sizes visit: littelfuse.com/75907

PART NUMBERS			VOLTAGE	AMPERAGE			CASE	TERMINAL STUDS	MOUNTING STEM		ACTUATOR	CONTACTS	INDEXING PIN	O-RING SEAL	TERMINAL SEAL	UL LISTED
BULK	BOXED	RETAIL		LARGE STUDS		SMALL STUDS			MATERIAL	SIZE						
				CONTINUOUS	INTERMITTENT	CONTINUOUS										
75907	75907-BX	-	6-36V DC	300A	2000A (30s On-3m Off)	20A	Plated Steel	Two 1/2"-20 & Two 10-32	-	3/4-16 23/32 long	Diecast Lever	Copper	•	•		

Marine Battery Switches



M-284 Series • 175A • SPST • Single Pole Brass Marine Battery Switches



M-284-01

Designed to disconnect the battery circuit on 6-36V DC systems.

- Mounting Stem: Brass, 3/4" -16 thread, 1 13/32" (46.1mm) long
fits panels up to 15/16" (23.8mm) thick
- Torque: Mounting Stem 20 ft/lb max - 3/8" nuts 70-90 in/lbs
- M-284-09BP includes Faceplate 82065
- Electrical ratings on UL labels are conservative

For additional information visit: littelfuse.com/M-284

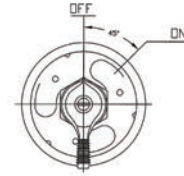

2-position lever model

PART NUMBERS			VOLTAGE	AMPERAGE		CASE	TERMINAL STUDS	MOUNTING STEM		ACTUATOR	CONTACTS	INDEXING PIN	O-RING SEAL	TERMINAL SEAL	UL LISTED
BULK	BOXED	RETAIL		CONTINUOUS	INTERMITTENT			MATERIAL	SIZE						
M-284	M-284-BX	M-284-BP	6-36V DC	175A	1000A (15s On-5m Off)	Brass	Two 3/8" (9.5mm Ø)	Brass	3/4-16 1 13/32" long	Lever	Copper				
M-284-A	M-284-A-BX	-			Lever					Silver					
M-284-01	M-284-01-BX	M-284-01-BP			800A (15s On-5m Off)					Lever	Silver				•
M-284-02	M-284-02-BX	-			Dichromate Lever					Silver		•	•		
-	-	M-284-09-BP			Dichromate Lever					Silver		•	•		
M-284-26	-	-			Lever					Silver					
-	M-289-BX	-			Lever					Silver					

*M-284-09-BP Kit includes M-284-02 Switch and 82065 Faceplate.

6

M-290 Series • 125A • DPST • Double Pole Brass Marine Battery Switches



M-290-05

Designed to disconnect the battery circuit and the alternator or generator field circuit on 6-36V DC systems. Two positions: Off-On.

- Mounting Stem: Brass, 3/4" -16 thread with 1 13/32" (46.1mm) long,
fits panels up to 15/16" (23.8mm) thick
- Torque: Mounting Stem 20 ft/lb max - 3/8" nuts 70-90 in-lbs
- M-290-05 is UL Listed to 707B

For datasheet, wiring diagram, and additional pack sizes visit: littelfuse.com/7590X

PART NUMBERS			VOLTAGE	AMPERAGE			CASE	TERMINAL STUDS	MOUNTING STEM		ACTUATOR	CONTACTS	INDEXING PIN	O-RING SEAL	TERMINAL SEAL	UL LISTED
BULK	BOXED	RETAIL		LARGE STUDS		SMALL STUDS			MATERIAL	SIZE						
				CONTINUOUS	INTERMITTENT	CONTINUOUS										
M-290	M-290-BX	-	6-36V DC	125A			Brass	Two 3/8"-24 & Two 10-32	Brass	3/4-16 1 13/32" long	Lever	Silver				
M-290-01	M-290-01-BX	-	6-36V DC	125A	1000A (15s On-5m Off)	20A						Silver		•		
M-290-05	M-290-05-BX	-	6-36V DC	125A								Silver			•	

Battery Selector Disconnect Switches



M-750 • Dual Battery Selector / Master Disconnect Switch

For any vehicle that needs to use two batteries where one battery is used for starting the engine, while the other is used to power auxiliary loads. This is a common situation in trucks, boats, RVs, police and rescue vehicles, and in ambulances and fire equipment.

A selector switch allows use of the first battery, the second battery, or both batteries simultaneously. This provides back-up starting power in an emergency. Either or both batteries can be selected to supply power.

These switches combine the functions of Battery Selector and Master Disconnect Switches to give four battery power options:

- Power cut off at the source.
- Power On, Battery 1.
- Power On, Battery 2.
- Power On, both Batteries.

Electrical Ratings

Labeled UL 707B. Rating: 500A intermittent, 310A continuous, 6-36V DC
 Electrical ratings on UL labels are conservative. Use with either alternators or generators. Make before break design permits operation through the three On positions with the engines running. Engines should always be shut down before turning to Off. Wiring instructions are included.

Heavy-Duty Construction

- Vaporproof, weather-, dust- and corrosion-resistant.
- Durable, fracture-resistant high temperature plastic case, knob and insulator.
- Switches conform to USCG section 183.410 for ignition protection. Resistant to impact, and temperature extremes.
- Heavy duty copper stud terminals, with brass hexnuts. Can be surface mounted, or installed through a 3 5/16" diameter hole in the panel
- Dimensions: Flange: 6" (152.4mm) diameter, overall height 2 5/8" (66.7mm).
 Terminals: 3 copper studs, 3/8" (9.5mm) diameter..
- Alternator field disconnect circuit switch. Prevents possible alternator diode failure if the switch is accidentally turned to Off with the engines running.

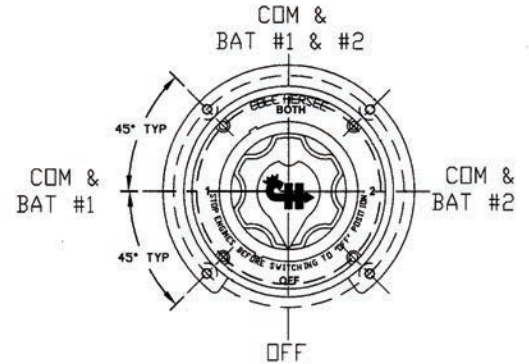

For datasheet, wiring diagram, and additional pack sizes visit: littelfuse.com/M750



M-750 Standard Switch



M-754 Back

M-754 Back is shown. Three small terminals in the middle are for connection to the pilot light circuit.

M-752 has two small terminals in the middle marked F1 and F2 for connection to the Alternator Field Disconnect circuit.

M-750 has no small terminals in the middle.

Full wiring instructions are included.

PART NUMBERS			VOLTAGE	AMPERAGE	TERMINALS	MOUNTING TYPE	SEALING	CERTIFICATION	ALTERNATOR FIELD DISCONNECT	PILOT CIRCUIT
BULK	BOXED	RETAIL CLAMSHELL								
M-750	-	M-750-BP	6-36V DC	500A intermittent 310A continuous	Copper Studs 3/8" (9.5mm) Brass hexnuts	Surface Mount Panel Mount (3 5/16" Ø hole)	Vaporproof, Weather-Resistant, Dust-Resistant, and Corrosion-Resistant	UL 707B		•
M-754	-	M-754-BP								

Metal Body Master Disconnect Switches - Accessories

Replacement levers, faceplates, terminal caps and lockout kits for Battery Disconnect Switches.



PART NUMBERS			DESCRIPTION	DESCRIPTION
BULK	BOX	RETAIL		
24505	24505-BX	-	Lockout Lever Kit	Lever and flange plate accept a padlock to securely lock a Disconnect Switch in the Off position. For use with lever actuated switches with a 3/4" Ø diameter mounting stem. Use a padlock with a 5/16" Ø shackle
24505-01	-	-	Lever	Battery Disconnect Switch Lock Out Kit w/Mounting Panel and Lever
80101-B	80101-B-BX	-	Lever	Replacement chrome-plated diecast lever
83353	83353-BX	-	Hencol Key	Replacement Hencol Key - Heavy gauge plated steel resists corrosion
82065	82065-BX	-	Faceplate	Polished aluminum with enamel finish - 2 1/2" (63.5mm) Ø
82065-02	82065-02-BX	-	Faceplate	With indexing hole - Polished aluminum with enamel finish - 2 1/2" (63.5mm) Ø

Battery Jumper Terminals and Feeder Studs

Battery Jumper Terminals are used to make easily-accessible battery connections, inside or outside the vehicle. They can be used individually or in pairs and are easy to install. Featuring solid brass posts, including a brass hexnut and lockwasher.

Feeder Studs bring power through bulkheads or firewalls and feature an impact-resistant plastic insulator/mounting bushing.

6



PART NUMBERS		VOLTAGE	DESCRIPTION	COLOR	TERMINAL/STUD SIZE	DIMENSIONS	NOTES
BULK	BOXED						
46210-02	46210-02-BX	6-48V DC	Terminal Post	Red	Terminal: 13/16" (20.6mm) Ø	-	Replacement Cap: 97846-A
46210-03	46210-03-BX	6-48V DC	Terminal Post	Black	1-1/8" (29.9mm) long	-	Replacement Cap: 97846-B
46211-R	46211-R-BX	6-36V DC	Feeder Stud	Red	Two 3/8" -16 threads	1 17/64" (32.1mm) Ø	-
46211-01	46211-01-BX	6-36V DC	Feeder Stud	Black	5/8" (15.9mm) long	5/8" (15.9mm) long	-



JBPT Single Stud Junction Blocks

Connection points for distribution of power in feed-thru and non-feed-thru styles. Simplifies cabling and serves as convenient tap points. Stainless steel studs of various threads and sizes, in red or black thermoplastic body. 3/8" zinc-plated steel studs have electrical rating of 400A and low resistance due to large contact area. High installation torque values allow the use of large cable sizes for high current applications.

PART NUMBERS			COLOR	FEED TYPE	STUD SIZE	MOUNTING BASE
BULK	BOXED	RETAIL				
JBPT2P01ZX	-	-	Red	Feed-Thru	1/2"-13	69.8 x 47.6mm
JBPT2N02ZX	-	-	Black	Non-Feed-Thru	1/2"-13	69.8 x 47.6mm
JBPT3P01ZX	-	-	Black	Feed-Thru	3/8"-18	52.4 x 19.1mm
JBPT3P02ZX	-	-	Black	Non-Feed-Thru	3/8"-18	52.4 x 19.1mm
JBPT3N03ZX	-	-	Black	Feed-Thru	3/8"-18	-
JBPT0001Z	-	-	Red	Feed-Thru	-	-

Ignition Switches



Littelfuse offers the broadest range of 12V to 48V Ignition Switches which are suitable for any application. Variations include those with plastic or traditional metal body, lever-actuated, tumbler keyed, or patented Hencol keyed.

Benefits of Anti-Restart Feature

Several ignition switches, including the 95060 series, feature an anti-restart mechanism. An operator can damage the starter motor if the ignition switch is inadvertently turned the when the engine is running. This can happen in noisy environments where it may be difficult to hear the engine. The switch must be turned to the Off position before the start circuit can be re-energized.

95060 – Not Just for Ignitions

The 95060 series is widely used in ignition systems. However, there are many other applications where a keyed, water-resistant rotary switch (two, three, or four positions) is required for 12V, 24V, or 36V systems

What is a Hencol Key?

Hencol is a Cole Hersee brand name used to describe our non-bitted common keys. Hencol keys are often used for ignition switches installed in forklifts or equipment that will have multiple operators. The non-bitted key allows any authorized user with a Hencol key to start and operator the vehicle.



The term Hencol is named after one of the Cole Hersee founders and is a mash-up of their name, Henry Cole.



Sealed Ignition Switches

95060 Series • 12-48V DC • Sealed Ignition Switches

Durable engineering thermoplastic construction withstands impact, and will not corrode, even on continual exposure to road salt. 95060 switches have integrated Deutsch-type connector for easy installs.

- Voltages: 10A at 12V, 5A at 24V, 3A at 36V and 2A at 48V
- Options: key boot, anti-restart, or spring return
- Sealing: contacts are sealed front and back to IP67 standard, with connector (p/n 31101) installed
- Ignition Protection: Tested to SAE J259 and UL-Recognized
- Deutsch connectors & Wires Part Number: 31101 (included in -50, -51 and -60 items)

- Actuators: single or multiple key codes, lever, knob or D-shaft.
 - Keyed switches ship with 2 keys (removable in Off position)
 - Replacement blanks: 83451-6 (600 series) or 83451-7 (700 series).
 - › CH601: Single tumbler code - all locks are identical
 - › Mixed: 200 random key codes
 - › 10 code: 10 random key codes
 - Lever: Chrome-plated diecast lever p/n 81254
 - Soft touch knob: p/n 81397
 - D-shaft: 1/4" D-shaft to accept customer's actuator

2D Prints and additional information: littelfuse.com/95060



95060 Series



95061 Series



95062 Series

PART NUMBERS			TOTAL	POSITIONS				ACTUATOR	KEYS		HARNES	SPRING RETURN	ANTI-RESTART	SWITCH W/ HARNES (P/N 31101)	REPLACEMENT ACTUATOR OR KEY BLANK
BULK	BOXED	RETAIL		1	2	3	4		CODE	BOOT					
95060	95060-BX	-	4	Acc	Off	Ign/Acc	Start	Keys	Mixed	•	•	•		83451-6 or 83451-7	
95060-01	95060-01-BX	-		Acc	Off	Ign/Acc	Start	Keys	Mixed	•	•	•		83451-6 or 83451-7	
95060-02	-	-		Acc	Off	Ign/Acc	Start	Keys	Mixed	•				83451-6 or 83451-7	
95060-23	95060-23-BX	-		Acc	Off	Ign/Acc	Start	Keys	CH601			•		83451-6	
95060-24	-	-		Acc	Off	Ign/Acc	Start	Keys	CH601			•		83451-6	
95060-34	95060-34-BX	-		Acc	Off	Ign/Acc	Start	Keys	10 Codes			•		83451-6 or 83451-7	
-	-	95060-50-BP		Acc	Off	Ign/Acc	Start	Keys	10 Codes	•	•	•	95060	83451-6 or 83451-7	
-	95061-BX	-		Acc	Off	Ign/Acc	Start	Lever	-			•		81254	
-	95061-50-BX	-		Acc	Off	Ign/Acc	Start	Lever	-			•		81254	
95061-01	-	-		Acc	Off	Ign/Acc	Start	Lever	-			•	•	81254	
95062-10	-	-	Acc	Off	Ign/Acc	Start	Knob	-			•		81397		
-	95062-50-BX	-	Acc	Off	Ign/Acc	Start	Knob	-			•		81397		
95060-03	95060-03-BX	-	3	Off	Ign/Acc	Start	-	Keys	Mixed	•	•			83451-6 or 83451-7	
-	-	95060-60-BP		Off	Ign/Acc	Start	-	Keys	Mixed	•	•	•	95060-03	83451-6 or 83451-7	
95060-04	95060-04-BX	-		Off	Ign/Acc	Start	-	Keys	Mixed	•	•	•		83451-6 or 83451-7	
95060-21	-	-		Off	Ign/Acc	Start	-	Keys	10 Codes	•	•			83451-6 or 83451-7	
95060-26	-	-		Off	Ign/Acc	Start	-	Keys	CH601	•	•			83451-6 - no logo	
95060-36	-	-		Mom On 1	Off	Mom On 2	-	Keys	CH545			•		Yale Y13	
95060-43	-	-		Mom On 1	Off	Mom On 2	-	Keys	Mixed	•	•			83451-6 or 83451-7	
95061-04	95061-04-BX	-		Off	Ign/Acc	Start	-	Lever	-			•	•	81254	
95061-05	-	-		Off	Ign/Acc	Start	-	Lever	-			•		81254	
-	95061-60-BX	-		Off	Ign/Acc	Start	-	Lever	-			•	•	81254	
95061-36	95061-36-BX	-	Mom On 1	Off	Mom On 2	-	Lever	-			•		81254		
95062-13	-	-	Off	Ign/Acc	Start	-	Knob	-			•		81254		
95060-07	95060-07-BX	-	2	Off	Ign/Acc	-	-	Keys	Mixed	•				83451-6 or 83451-7	
95060-29	-	-		Off	Ign/Acc	-	-	Keys	CH601	•				83451-6	
95061-07	-	-		Off	Ign/Acc	-	-	Lever	-					81254	
95062-17	-	-		Off	Ign/Start	-	-	Knob	-					81397	
-	95062-57-BX	-		Off	Ign/Start	-	-	Knob	-			•		81397	

Technical Details

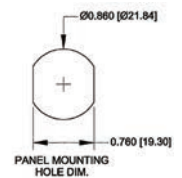
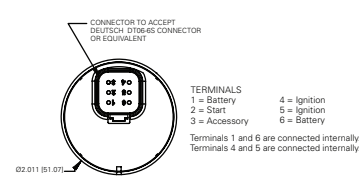

Heavy Duty Ignition Switches

956 Series • Heavy Duty General Purpose Metal Body Ignition Switches

Dependable diecast zinc housing switches with an array of options for every application. Switches mount through the panel and have lever action or are keyed (hencol key or coded tumbler lock). On keyed switches the key is removable at Off position only.

- Two Terminal Options: Brass blade 1/4" (6.4mm) wide accept Delphi (Packard) connector 2962912 or equivalent
Screw Terminals include lock washers

- Two Mounting Sizes: 1"-24 bushings fit panels .030" - .090" (.76mm - 2.3mm)
3/4"-24 bushings fit panels .060" - .110" (1.5mm - 2.7mm)

2D Prints and additional information: littelfuse.com/IgnitionSwitches



Coded tumbler lock with 2 keys



Patented Hencol lock with 2 keys (83357)



Short handle lever (81254)



Military Lever (956-5109)

PART NUMBERS			AMP RATING (12V DC)					POSITIONS				ACTUATOR / KEY TYPE	TERMINALS	SPRING RETURN	ANTI-RESTART	GROUND TERMINAL	SEAL TYPE			BUSHING SIZE	REPLACEMENT KEY BLANK	
BULK	BOXED	RETAIL	ACC	IGN	START	GROUND	TOTAL	1	2	3	4						SILVER CONTACTS	SHUTTER LOCK	GASKET			O-RING
956-4100	956-4100-BX	-	10	10	5	1	4	Acc	Off	Ign/Acc	Ign/Start	Coded	4 blade	•				•			1"-24	Unavailable - OB
956-4107	956-4107-BX	-	10	10	5	1		Acc	Off	Ign/Acc	Ign/Start	Hencol	4 screw	•				•	•	•	1"-24	83357
-	956-4111-BX	-	10	10	5	1		Acc	Off	Ign/Acc	Ign/Start	S. Lever	4 blade	•							1"-24	81254
956-4113	-	-	30	10	5	-		Acc	Off	Ign/Acc	Ign/Start	Hencol	4 blade	•				•		•	1"-24	83357
956-4124	956-4124-BX	-	10	10	5	1		Acc	Off	Ign/Acc	Ign/Start	S. Lever	4 screw	•					•	•	1"-24	81254
956-4138	956-4138-BX	-	30	20	10	-		Acc	Off	Ign/Acc	Ign/Start	Coded	4 blade	•							1"-24	Unavailable - OB
956-4141	956-4141-BX	-	30	20	10	-		Acc	Off	Ign/Acc	Ign/Start	Hencol	4 screw	•			•	•	•	•	1"-24	83357
956-4154	956-4154-BX	-	10	10	5	1		Acc	Off	Ign/Acc	Ign/Start	Coded	5 screw	•		•		•			1"-24	Unavailable - OB
956-4307	956-4307-BX	-	10	10	5	1		Acc	Off	Ign/Acc	Ign/Start	Hencol	4 screw	•				•	•	•	3/4"-24	83357
956-4311	956-4311-BX	-	10	10	5	1		Acc	Off	Ign/Acc	Ign/Start	Coded	4 blade	•						•	3/4"-24	Unavailable - OB
956-9100	956-9100-BX	-	10	5	5	-		Fuel	Off	Ign/Acc	Ign/Start	Hencol	5 screw	•					•	•	1"-24	83357
956-3122	956-3122-BX	-	10	10	5	-	3	Off	Ign/Acc	Ign/Start	-	Coded	5 screw	•	•	•		•	•	•	1"-24	Unavailable - OB
956-3124	956-3124-BX	-	10	10	5	-		Off	Ign/Acc	Ign/Start	-	S. Lever	5 screw	•	•	•				•	1"-24	81254
956-3125	956-3125-BX	-	30	10	10	-		Off	Ign/Acc	Ign/Start	-	Coded	4 screw	•	•				•		1"-24	Unavailable - OB
956-3126	956-3126-BX	-	10	10	5	-		Off	Ign/Acc	Ign/Start	-	Hencol	4 screw	•	•				•		1"-24	83357
956-3127	956-3127-BX	-	30	10	10	-		Off	Ign/Acc	Ign/Start	-	S. Lever	3 screw	•	•				•	•	1"-24	81254
956-3135	-	-	10	10	5	1		Off	Ign/Acc	Ign/Start	-	S. Lever	5 screw	•							1"-24	n/a
956-5109	956-5109-BX	-	20	10	10	-		Off	Ign/Acc	Ign/Start	-	Mil. Lever	4 screw	•			•		•		1"-24	n/a
956-5124	-	-	10	10	5	-		Off	Ign/Acc	Ign/Start	-	Hencol	4 screw	•					•	•	3/4"-24	83357
956-5307	956-5307-BX	-	10	10	5	1		Acc	Off	Ign/Acc	-	Hencol	3 screw	•					•	•	3/4"-24	83357
956-6307	-	-	10	10	-	-		Acc	Off	Ign/Acc	-	Hencol	3 screw	•					•	•	3/4"-24	83357
956-6310	-	-	30	10	-	-		Acc	Off	Ign/Acc	-	Hencol	3 screw	•					•	•	3/4"-24	83357

Typical Hencol Switch Dimensions

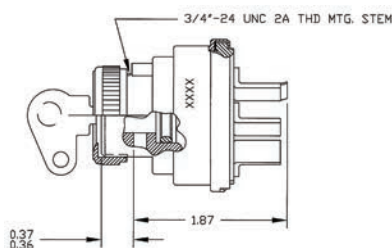

5 Screw Terminals

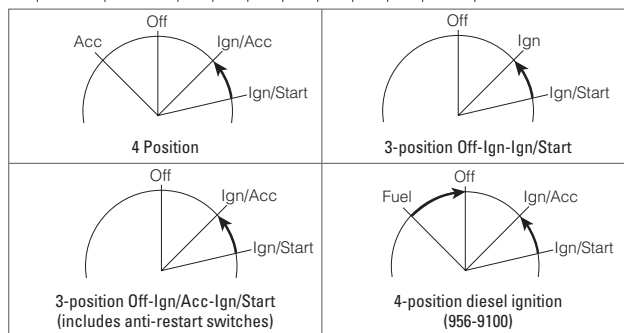
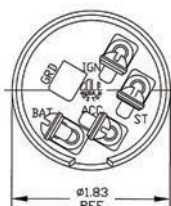

General Purpose Ignition Switches

95 Series • General Purpose Metal Body Ignition Switches



- Zinc diecast housing
- Coded tumbler locks (2 keys)
- Screw terminals with lock washers
- Fit panels up to 3/8" (9.5mm)
- Key removable at Off positions (except 9518)
- Spring return to IGN or IGN/ACC on all switches.† (except 9578)

2D Prints and additional information: littelfuse.com/IgnitionSwitches

PART NUMBERS			AMP RATING (12V DC)				POSITIONS				ACTUATOR / KEY TYPE	TERMINALS	O-RING SEAL	BUSHING SIZE	NOTES	REPLACEMENT KEY BLANK
BULK	BOXED	RETAIL	ACC	IGN	START	TOTAL	1	2	3	4						
9579	9579-BX	9579-BP	10	10	5	4	Acc	Off	Ign/Acc	Ign/Start	Coded	4 screw		3/4"-20	-	-
9579-02	9579-02-BX	-	10	10	5	4	Acc	Off	Ign/Acc	Ign/Start	Coded	4 screw		3/4"-20	Key code CH-505	-
9513	9513-BX	-	-	10	5	3	Off	Ign	Ign/Start	-	Coded	3 screw		3/4"-20	-	-
9578	9578-BX	-	10	10	-	3	Acc	Off	Ign/Acc	-	Coded	3 screw		3/4"-20	-	-
95539	95539-BX	-	10	1	5	3	Off	Run	Start	-	Coded	4 screw		3/4"-20	1A Magneto	-
95582	95582-BX	-	-	10	5	3	Off	Ign	Ign/Start	-	Coded	3 screw	•	3/4"-20	-	-
9577	9577-BX	-	10	-	-	2	Off	On (Ign)	-	-	Coded	2 screw		3/4"-20	-	-
95535	95535-BX	-	10	5	5	-	Acc	Off	Ign/Acc	Ign/Start	Key	4 screw		13/16"	-	-
95593	95593-BX	-	10	10	-	-	Rev	Off	Run	-	Key	3 screw		3/4"	-	-

† Switch does not have a spring return to IGN or IGN/ACC feature.

95 Series • General Purpose Metal Body Ignition Switches



- Zinc diecast housing
- Military style lever
- Screw terminals with lock washers
- Fit panels up to 11/64" (4.4mm)
- Spring return to IGN or IGN/ACC on all switches

2D Prints and additional information: littelfuse.com/IgnitionSwitches

PART NUMBERS			AMP RATING (12V DC)				POSITIONS				ACTUATOR / KEY TYPE	TERMINALS	O-RING SEAL	BUSHING SIZE	NOTES
BULK	BOXED	RETAIL	ACC	IGN	START	TOTAL	1	2	3	4					
95634-01	95634-01-BX	-		10	5	3	Off	Ign	Ign/Start	-	Mil. Lever	3 screw	•	3/4"-20	-
95633-A	95633-A-BX	-	10	10		2	Off	Ign/Acc	-	-	Mil. Lever	3 screw		3/4"-20	Moisture & fungus-resistant per MIL-JAN-T-152

95 Series • General Purpose Metal Body Ignition Switches



- Plated steel housing
- Hencol locks (2 keys)
- Screw terminals with lock washers
- Fit panels up to 1/8" (3.2mm)
- Key removable at Off positions
- Spring return to IGN or IGN/ACC on all switches

2D Prints and additional information: littelfuse.com/IgnitionSwitches

PART NUMBERS			AMP RATING (12V DC)				POSITIONS				ACTUATOR / KEY TYPE	TERMINALS	SILVER CONTACTS	O-RING SEAL	BUSHING SIZE	REPLACEMENT KEY BLANK
BULK	BOXED	RETAIL	ACC	IGN	START	TOTAL	1	2	3	4						
95525-A	95525-A-BX	-	10	10	5	4	Acc	Off	Ign/Acc	Ign/Start	Hencol	4 screw		•	5/8"-32	83357
95524-A	95524-A-BX	-	-	10	5	3	Off	Ign	Ign/Start	-	Hencol	3 screw		•	5/8"-32	83357
95522-A	-	-	-	10	-	2	Off	On/Ign	-	-	Hencol	2 screw		•	5/8"-32	83357

General Purpose Ignition Switches



95 Series • General Purpose Metal Body Ignition Switches

- Plated steel housing
- Lever actuator (short or long)
- Fit panels up to 1/8" (3.2mm)
- Spring return to IGN or IGN/ACC on all switches

2D Prints and additional information: littelfuse.com/IgnitionSwitches

PART NUMBERS			AMP RATING (12V DC)			POSITIONS			ACTUATOR / KEY TYPE	TERMINALS	SILVER CONTACTS	O-RING SEAL	BUSHING SIZE	NOTES
BULK	BOXED	RETAIL	IGN	START	TOTAL	1	2	3						
95591	95591-BX	–	10	5	3	Off	Ign/Acc	Ign/Start	Lever	4 screw	•	•	5/8"-32	Zinc Diecast Lever
95610	95610-BX	–	25	20	3	Off	Ign	Ign/Acc	Short Lever	3 screw	•	•	5/8"-32	Short Chrome Lever
95612	95612-BX	–	25	20	3	Off	Ign	Ign/Acc	Short Lever	3 screw	•	•	5/8"-32	Short Chrome Lever
–	95613-BX	–	20	20	3	Off	Ign	Ign/Acc	Short Lever	3 blade	•	•	5/8"-32	Short Chrome Lever



95 Series • General Purpose Metal Body Ignition Switches

- Plated steel housing
- Hencol locks come with 2 keys
- Screw terminals come with lock washers
- Fit panels up to 1/4" (6.4mm)
- Key removable at Off positions
- Spring return to IGN or IGN/ACC on all switches

2D Prints and additional information: littelfuse.com/IgnitionSwitches

7

PART NUMBERS			AMP RATING (12V DC)			POSITIONS			ACTUATOR / KEY TYPE	TERMINALS	SILVER CONTACTS	O-RING SEAL	BUSHING SIZE	NOTES	REPLACEMENT KEY BLANK
BULK	BOXED	RETAIL	IGN	START	TOTAL	1	2	3							
95521-B	95521-B-BX	–	25	70	3	Off	Ign	Start	Long Hencol	3 screw	•	•	5/8"-32	–	83353
95521-01	95521-01-BX	–	25	70	3	Off	Ign	Start	Lever	3 screw	•	•	5/8"-32	Dichromate Lever	80101-A
95033	95033-BX	–	50	10	3	Glow	Off	Glow/Start	Lever	3 screw	•	•	5/8"-32	50A Glow - Diesel	80101-A
95597	95597-BX	–	50	–	2	Off	On (Ign)	–	Long Hencol	2 screw	•	•	5/8"-32	Heavy-Duty	83353
M-288	M-288-BX	–	50	–	2	Off	On (Ign)	–	Lever	2 screw	•	•	5/8"-32	Heavy-Duty	–



Level Lock Ignition Switch (9500)



Coded tumbler lock with 2 keys (9622-01)

5A-10A Compact Ignition Switches

- Key removable at Off and On
- 3/4" -24 mounting stem fits panels to 3/4" (19.1mm)
- Compact - Plated steel case, stainless steel bezel & face washer

PART NUMBERS			RATING	POSITIONS			ACTUATOR / KEY TYPE	TERMINALS	MOUNTING STEM
BULK	BOXED	RETAIL		TOTAL	1	2			
9500	9500-BX	–	10A at 12V DC	2	Off	On (Ign)	Lever	2 screw	1/2"-20 fits panels to 13/64" (5.2mm)
9622-01	9622-01-BX	–	5A at 12V DC	2	Off	On (Ign)	Tumbler Key Coded	2 screw	3/4"-24



10A Reversing Switch with Tumbler Key

Reversing Switch in a plated steel case. Key is removable in Off position only with Spring return to Off. O-ring seal in mounting stem.

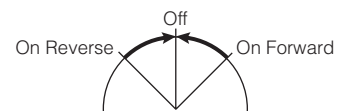

PART NUMBERS			RATING	POSITIONS			ACTUATOR / KEY TYPE	TERMINALS	BUSHING SIZE	
BULK	BOXED	RETAIL		TOTAL	1	2				3
75705-01	75705-01-BX	–	10A at 12V DC	3	Mom Forward	Off	Mom Reverse	Coded	3 screw	13/16"-24



M-712 • M-550 • M-489



M-712-09 • M-550-14

Marine or General Purpose Brass Body Keyed Ignition Switches

Marine switches are highly suitable for harsh environments on land or at sea. They are corrosion-resistant, with brass cases. Moisture-repellent insulators, coded locks with 2 brass keys.

- Brass housing and mounting hardware, chrome-plated brass facenut.
- Coded tumbler locks (2 keys)
- Screw terminals with lock washers
- Fit panels up to 1" (25.4mm)
- Key removable at Off positions
- Spring return to IGN or IGN/ACC on all switches

2D Prints and additional information: littelfuse.com/IgnitionSwitches

PART NUMBERS			AMP RATING (12V DC)				POSITIONS				ACTUATOR / KEY TYPE	TERMINALS	BUSHING SIZE	NOTES	REPLACEMENT KEY BLANK
BULK	BOXED	RETAIL	ACC	IGN	START	TOTAL	1	2	3	4					
M-6110-05	-	-	-	10	5	3	Off	Ign	Ign/Start	-	Coded Key	3 screw	13/16"-24	Bitted CH-523 Code	
M-700	M-700-BX	-	-	5	5	4	Acc	Off	Ign/ACC	Ign/Start	Coded Key	4 screw	3/4"	Bitted Mixed Codes	
M-712	M-712-BX	M-712-BP	10	5	5	4	Acc	Off	Ign/ACC	Ign/Start	Coded Key	4 screw	13/16"-24		
M-712-09	M-712-09-BX	M-712-09-BP	10	5	5	4	Acc	Off	Ign/ACC	Ign/Start	Coded Key	4 screw	13/16"-24	Rubber Boot	
M-550	M-550-BX	M-550-BP	-	10	5	3	Off	Ign	Ign/Start	-	Coded Key	3 screw	13/16"-24		
M-550-14	M-550-14-BX	M-550-14-BP	-	10	5	3	Off	Ign	Ign/Start	-	Coded Key	3 screw	13/16"-24	Rubber Boot	
M-489	M-489-BX	M-489-BP	-	10	-	2	Off	On/Ign	-	-	Coded Key	2 screw	13/16"-24		
M-489-03	-	-	-	10	-	2	Off	On/Ign	-	-	Coded Key	2 screw	13/16"-24	Keyhole shutter	



M-497

Marine or General Purpose Brass Body Lever Ignition Switches

Marine switches are highly suitable for harsh environments on land or at sea. They are corrosion-resistant, with brass cases.

- Brass housing and mounting hardware, chrome-plated diecast long lever.
- Fit panels up to 7/8" (22.2mm)

2D Prints and additional information: littelfuse.com/IgnitionSwitches

PART NUMBERS			AMP RATING (12V DC)		POSITIONS		ACTUATOR / KEY TYPE	TERMINALS	BUSHING SIZE
BULK	BOXED	RETAIL	IGNITION	TOTAL	1	2			
M-497	M-497-BX	-	10	2	Off	On/Ign	Lever	2 screw	1/2'-20



M-850

15A Marine Plastic Body Ignition Switches

Durable plastic case and stem with PVC boot for added weather protection. Key is removable only in the Off position. Off-Run-Start Spring return to IGN.

- Electrical ratings at 6-36V DC: 15A ignition, 5A start
- Mounting stem fits panels up to 7/8" (22.2mm) thick, with 7/8" diameter hole

2D Prints and additional information: littelfuse.com/IgnitionSwitches

PART NUMBERS			POSITIONS			ACTUATOR	TERMINALS	SPRING RETURN	MOUNTING STEM	REPLACEMENT KEY
BULK	BOXED	RETAIL	1	2	3					
M-850	M-850-BX	M-850-BP	Off	Run	Ign/Start	Key	3 screw	•	Fits panels to 7/8" (22.2mm) with 7/8" Ø hole	-

Ignition Switches

Delco Replacement Ignition and Start Switches

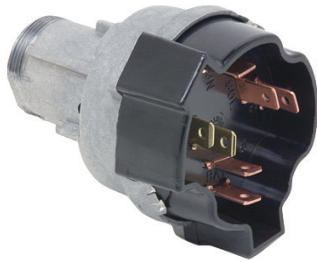

Replacement switches sold without a lock cylinder. To receive a new lock cylinder and 2 keys order part number 95874. Both part numbers feature a 1"-24 UNS-2A thread and key is only removable in Off position.



- 7 Blade Terminals accept Delphi (Packard) 6288702. Includes 2 ground terminals for checking indicator bulbs. 1 additional battery terminal provides continuous hotfeed for optional equipment.
- Replaces Delco D-1403-A, D-1406-A, D-1480, D-1498-A, • Chevrolet Trucks 67-83, 85-89, GMC 1116712, 1116683, 1116695, 1116704, 1116709, 1116711, 2234285 • GMC Trucks 67-83, 85-89

2D Prints and additional information: littelfuse.com/IgnitionSwitches

PART NUMBERS			POSITIONS				ACTUATOR	TERMINALS	SPRING RETURN	GROUND TERMINAL	O-RING
BULK	BOXED	RETAIL	1	2	3	4					
95410	-	-	Acc	Off	Ign/Acc	Ign/Start/Ground	None	7 screw	•	•	•

Ignition Switch Keys, Protective Boots, Caps, Facenuts and Cover Accessories



83353 - Long Hencol Key



83357 - Short Hencol Key



83379 - 500 Series Blank Tumbler Key



83285-01 & 83288 - Protective Boot



8367 - Face nut



98635-01 - Key Cover

PART NUMBERS			MATERIAL	DESCRIPTION
BULK	BOX	RETAIL		
31101	31101-BX	-	Harness	Harness populated with Wires that mates to the 95060 Series Switches
83353	83353-BX	-	Heavy Gauge Steel Plated	Hencol L Long Key
83357	83357-BX	-	Heavy Gauge Steel Plated	Hencol S Short Key
83274	-	-	Aluminum	Face Nut
83379	83379-BX	-	Brass	Design for 95 Series & M-XXX Marine Switches
83285-01	-	-	Aluminum	Mounting nut containing a rubber self-closing key slot - 3/4"-20 threads 7/16" thick
-	83288-BX	83288-BP	Chrome Brass	Mounting nut containing a rubber self-closing key slot - 13/16"-24 thread 7/32" thick
8367	8367-BX	-	Aluminum	Face Nut Knurled Edges - 3/4"-20 thread 19/64" thick - Clears 5/8" Hole
98635-01	-	-	Plastic	Black Slip-On Cover for Tumbler Keys 83379

Anti-Restart Ignition Switches

What Are They, and Where Should They Be Used?



The 95060 and 956 Series Ignition Switches include an Anti-Restart safety feature. On occasion, vehicle operators do not realize the engine is running and turn on the ignition resulting in a squealing and grinding of gears. If this happens repeatedly, the starter motor will likely burn out. Cole Hersee Anti-Restart Ignition Switches prevent this from happening.



95060

How They Work

Most regular Ignition Switches have three positions.



Off: key can be removed. Ignition and accessories (radio, lights etc) are activated when the key is in.

Momentary Start position runs the starter motor. This position is spring-loaded to return to position 2 once the engine is running. If the Ignition Switch is in position 2 and you think it's in position 1, you may be tempted to turn it to position 3 while thinking it is in position 2. This results in the grinding sound. Cole Hersee Anti Restart Ignition Switches prevent the operator from turning to Position 3 when the engine is

running. This safeguard against burnt-out motors can be retrofitted into any kind of vehicle, such as forklifts or mining vehicles where the ambient noise is high. This kind of 'lockout ignition' is available with a standard ignition key or with a lever for off-road applications.

For additional information, 2D Prints and more: littelfuse.com/IgnitionSwitches



956-3122



95061



956-3124



95062

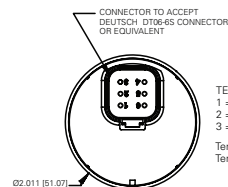
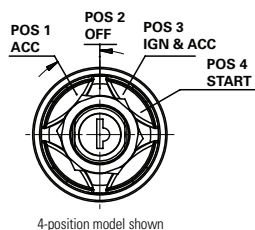

TERMINALS
1 = Battery
2 = Start
3 = Accessory
4 = Ignition
5 = Ignition
6 = Battery
Terminals 1 and 6 are connected internally.
Terminals 4 and 5 are connected internally.

Rocker Switches



What is Dependent and Independent Illumination?

Dependent:

The actuator is illuminated only when the switch is turned on.

Independent:

Illumination is not affected by the actuation of the switch. The illumination can be switched on or off by another switch, such as headlight or interior lighting controls. This is especially useful when locating switches in the dark.



What Does SPST or DPST Mean?

The first two letters, SP or DP, refer to single pole or double pole. The second two letters, ST or DT refer to single throw or double throw.

Pole refers to the number of circuits controlled by the switch. SP switches control one circuit and DP switches control two independent circuits (which act like two identical switches that are mechanically linked). Pole is often confused with terminal, which is a common mistake. Terminals are used for wire connections on the back of the unit and are specified separately.

Throw refers to the extreme position of the actuator. ST switches close a circuit at only one position and the other position is off. DT switches close a circuit in the Up position, as well as the down position and can be configured with two positions (On-On) or three positions (On-Off-On).



Sealed Rocker Switches

25A LED Sealed Rocker Switches

- Weather-resistant with contact areas sealed to IP66 (high pressure wash resistant)
- Super-bright LED illumination and high-visibility wrap-around lenses
- LEDs give visibility, even in sunlight and have a long life
- Silver contacts and corrosion-resistant nickel-plated brass blades for superior performance and electrical contact

2D Prints and additional information: littelfuse.com/RockerSwitches



58312-A2 & A4



58312-R2 & R4



58312-C4



58312-G4



58312-AG

PART NUMBERS			RATING	POLE & THROW	ACTION	ILLUMINATION	LED PILOT LIGHTS		TERMINALS	CONTACTS	SEALING
BULK	BOXED	RETAIL CLAMSHELL					LENS COLOR 1	LENS COLOR 2			
58312-R2	-	-	25A at 12V DC	SPST	On-Off	Independent	Red	-	4 blade	Silver	IP66
58312-A4	58312-A4-BX	-	25A at 12V DC	SPST	On-Off	Dependent	Amber	-	3 blade	Silver	IP66
58312-C4	-	-	25A at 12V DC	SPST	On-Off	Dependent	Clear	-	3 blade	Silver	IP66
58312-G4	58312-G4-BX	-	25A at 12V DC	SPST	On-Off	Dependent	Green	-	3 blade	Silver	IP66
58312-R4	58312-R4-BX	-	25A at 12V DC	SPST	On-Off	Dependent	Red	-	3 blade	Silver	IP66
58312-AG	58312-AG-BX	-	25A at 12V DC	SPDT	On-Off-On	Dependent	Amber	Green	4 blade	Silver	IP66

Note: 24V DC versions can be made available for volume exceeding 1000 pieces. Please contact Littelfuse for more details.



25A & 15A Non-Illuminated Sealed Rocker Switches

- Weather-resistant with contact areas sealed to IP66 (high pressure wash resistant)
- Silver contacts and corrosion-resistant nickel-plated brass blades for superior performance and electrical contact

PART NUMBERS			RATING	POLE & THROW	ACTION	TERMINALS	CONTACTS	SEALING	NOTES
BULK	BOXED	RETAIL CLAMSHELL							
58311-01	-	-	25A at 12V DC 15A at 24V DC	SPST	On-Off	2 blade	Silver	IP66	
58311-02	-	-		SPST	Mom On-Off	2 blade	Silver	IP66	
58311-07	-	-		DPDT	On-Off-On	6 blade	Silver	IP66	
58311-08	-	-		DPDT	On-On	6 blade	Silver	IP66	
58311-11	-	58311-11-BP		DPDT	On-Off-On	4 blade	Silver	IP66	Forward & Reverse
58311-13	58311-13-BX	-		DPDT	Off-On-Mom On	4 blade	Silver	IP66	Ignition & Start
58311-18	-	58311-18-BP		DPDT	Mom On-Off-Mom On	4 blade	Silver	IP66	Forward & Reverse
58336	-	-		SPST	On-Off (Lockable)	2 blade	Silver	IP66	Black Rocker and Orange Lock
58337	-	-		DPDT	Open-Off-Close	2 blade	Silver	IP66	Black Rocker with White Text "Open - TARP - Close"

Sealed Rocker Switches



58328-01



58328-02

58328 Series • 25A Incandescent Pilot Light Rocker Switches

- Series available with small pilot lights, large pilot lights or unlit
- Dependent or independent illumination
- Faceted lenses are on the actuator
- Matte black finish on the plastic housing, bezel and actuator
- Brass blade or screw terminals available
- See accessories section for bezels and mounting kits

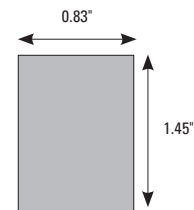

Standard mounting hole

2D Prints and additional information: littelfuse.com/RockerSwitches

PART NUMBERS			RATING	POLE & THROW	ACTION	ILLUMINATION	LED PILOT LIGHTS		TERMINALS	CONTACTS	SEALING
BULK	BOXED	RETAIL CLAMSHELL					LENS COLOR 1	LENS COLOR 2			
58328-01	58328-01-BX	–	25A at 12V DC	SPST	On-Off	Independent	Red	–	4 blade	Silver	IP66
58328-02	–	–		SPST	On-Off	Independent	Green	–	4 blade	Silver	IP66
–	–	58328-101-BP		SPST	On-Off	Independent	One lens of each color	–	4 blade	Silver	IP66
58328-04	58328-04-BX	–		SPST	On-Off	Dependent	Red	–	3 blade	Silver	IP66
58328-11	58328-11-BX	–		SPST	On-Off	Dependent	Green	–	3 blade	Silver	IP66
–	58328-12-BX	–		SPST	On-Off	Dependent	Clear	–	3 blade	Silver	IP66
58328-13	58328-13-BX	–		SPST	On-Off	Dependent	Amber	–	3 blade	Silver	IP66
58328-55	–	–		SPST	On-Off	Dependent	Blue	–	3 blade	Silver	IP66
58328-58	–	–		SPST	On-Off	Dependent	Red	–	3 blade	Silver	IP66
58328-62	–	–		SPST	On-Off	Dependent	Amber	–	3 blade	Silver	IP66
–	–	58328-100-BP		SPST	On-Off	Dependent	One lens of each color	–	3 blade	Silver	IP66
58328-35	58328-35-BX	–		SPDT	On-Off-On	Dependent	Red	Amber	4 blade	Silver	IP66
–	–	58328-103-BP		SPDT	On-Off-On	Dependent	One lens of each color	–	4 blade	Silver	IP66

58332 Series • 20A Sealed Rocker Switches

58332 switches are supplied in retail BP only and are supplied with one black and one gray snap-on actuator. These general-purpose switches are suitable for all kinds of applications.

- They are weather-resistant with contact areas sealed to IP66 (high pressure wash-resistant).
- Recognized at UL 1500 (Ignition protection for marine products). With neoprene gasket/panel seal.
- Conveniently snap into a standard rectangular mounting hole 1.48" x 0.83" (36.8 x 21.1mm) in panels from 0.09" to 0.19" thick (2.4 x 4.7mm).
- Plastic housing, bezel and actuator.
- Silver contacts, Brass blade terminals.

2D Prints and additional information: littelfuse.com/RockerSwitches

PART NUMBERS BOXED	RATING	POLE & THROW	ACTION	ILLUMINATION	LED PILOT LIGHTS		TERMINALS	CONTACTS	SEALING
					LENS COLOR 1	LENS COLOR 2			
58332-04-BP	25A at 12V DC	SPST	On-Off	Independent	Green	Red	4 Blade	Silver	UL1500 IP66
58332-20-BP		SPST	Mom On-Off		–	–	2 Blade		
58332-21-BP		SPDT	On-Off-On		Amber	Amber	4 Blade		
58332-22-BP		SPDT	Mom On-Off-Mom On		–	–	3 Blade		
58332-23-BP		SPDT	On-Off-Mom On		Amber	–	3 Blade		
58332-25-BP		DPDT	On-Off-Mom On		Amber	–	7 Blade		
58332-26-BP		DPDT	On-Off-On		Amber	Amber	7 Blade		
58332-27-BP		DPDT	Mom On-Off-Mom On		–	–	6 Blade		
58332-28-BP		DPST	Mom On-Off		–	–	5 Blade		
58332-29-BP		DPST	On-Off		Amber	–	5 Blade		
58332-30-BP		SPDT	On-Off-On		Amber	Amber	4 Blade		
58332-31-BP		SPDT	On-Off-Mom On		Amber	–	4 Blade		
58332-32-BP		DPDT	On-Off-Mom On		Amber	–	7 Blade		
58332-33-BP		DPDT	On-Off-On		Amber	Amber	7 Blade		
58332-34-BP		DPDT	On-Off		Amber	–	5 Blade		

Sealed Rocker Switches

56327 & 58327 Series • 25A Small Round Lens Pilot Light Rocker Switches



56327-01



58327-06

- Series available with small pilot lights, large pilot lights or unlit
- Dependent or independent illumination
- Faceted lenses are on the actuator
- Matte black finish on the plastic housing, bezel and actuator
- Brass blade or screw terminals available
- See accessories section for bezels and mounting kits

2D Prints and additional information: littelfuse.com/RockerSwitches

PART NUMBERS			RATING	POLE & THROW	ACTION	ILLUMINATION	LED PILOT LIGHTS		TERMINALS	CONTACTS	SEALING	DIAGRAM page 82
BULK	BOXED	RETAIL CLAMSHELL					LENS COLOR 1	LENS COLOR 2				
56327-01	56327-01-BX	56327-01-BP	25A at 12V DC	SPST	On-Off	Dependent	Red		3 screw	Silver	IP66	F
58327-01	58327-01-BX	58327-01-BP		SPST	On-Off	Dependent	Red		3 blade	Silver	IP66	F
58327-06	58327-06-BX	58327-06-BP		SPDT	On-Off-On	Dependent	Red	Red	4 blade	Silver	IP66	J



56027-01

56027 & 58027 Series • 25A Non-Illuminated Rocker Switches

- Series available with small pilot lights, large pilot lights or unlit
- Matte black finish on the plastic housing, bezel and actuator
- Brass blade or screw terminals available
- See accessories section for bezels and mounting kits

2D Prints and additional information: littelfuse.com/RockerSwitches



Forward-Reverse switch

PART NUMBERS			RATING	POLE & THROW	ACTION	TERMINALS	CONTACTS	SEALING	NOTES
BULK	BOXED	RETAIL CLAMSHELL							
56027-01	56027-01-BX	56027-01-BP	25A at 12V DC	SPST	On-Off	2 screw	Silver	IP66	-
58027-01	58027-01-BX	-		SPST	On-Off	2 blade	Silver	IP66	-
58027-02	58027-02-BX	58027-02-BP		SPST	Mom On-Off	2 blade	Silver	IP66	-
58027-03	58027-03-BX	58027-03-BP		SPDT	On-Off-On	3 blade	Silver	IP66	-
58027-04	58027-04-BX	58027-04-BP		SPDT	Mom On-Off-Mom On	3 blade	Silver	IP66	-
58027-06	58027-06-BX	-		DPST	On-Off	4 blade	Silver	IP66	-
58027-07	58027-07-BX	58027-07-BP		DPDT	On-Off-On	6 blade	Silver	IP66	-
58027-08	-	-		DPDT	On-On	6 blade	Silver	IP66	-
58027-11	58027-11-BX	58027-11-BP		DPDT	Mom On-Off-Mom On	6 blade	Silver	IP66	-
58027-18	58027-18-BX	-		DPDT	Mom On-Off-Mom On	4 blade	Silver	IP66	Forward & Reverse

Dual & Wide Body Rocker Switches

25A Wide Body Dual Rocker Switches



- Two Single Pole switches in one body
- Universal application switches
- Snap-in mounting
- Silver contacts, copper blade terminals
- Black or white actuators, imprinted in contrasting black or white
- Snaps into panel hole 1.0" x 1.125" (25.4x28.6mm) and fits panels .030" thru .250" thick (.76 - 6.35mm)

2D Prints and additional information: littelfuse.com/RockerSwitches

PART NUMBERS			RATING	LEFT SWITCH			RIGHT SWITCH			TERMINALS	BEZEL WIDTH
BULK	BOXED	RETAIL CLAMSHELL		ACTION	ACTUATOR	PRINT	ACTION	ACTUATOR	PRINT		
54204-01	-	-	10A at 12V DC	On1-Off-On2	Black Rocker	Hi, Lo	On1-Off-On2	Black Rocker	Hi, Lo	6 Blade	Wide

Sealed Rocker Switches



M-58031 Series • 20A Rocker Switches

- Certified to IP66 for protection against dust and prolonged spray
- Recognized at UL 1500: Ignition Protection for Marine Products
- Neoprene gasket/panel seal with black nylon bezel and black plastic housing
- 20A at 12V DC. Blade terminals, silver contacts

2D Prints and additional information: littelfuse.com/RockerSwitches

PART NUMBERS			RATING	POLE & THROW	ACTION	TERMINALS	CONTACTS	SEALING
BULK	BOX	RETAIL CLAMSHELL						
M-58031-01	M-58031-01-BX	M-58031-01-BP	20A at 12V DC	SPST	On-Off	2 Blade	Silver	IP66
M-58031-02	–	M-58031-02-BP	20A at 12V DC	SPDT	On-Off-On	3 Blade	Silver	IP66
M-58031-04	–	M-58031-04-BP	20A at 12V DC	DPST	On-Off	4 Blade	Silver	IP66
M-58031-07	–	M-58031-07-BP	20A at 12V DC	SPST	Mom On-Off	2 Blade	Silver	IP66
M-58031-08	–	–	20A at 12V DC	SPDT	Mom On-Off-Mom On	3 Blade	Silver	IP66
M-58031-09	M-58031-09-BX	–	20A at 12V DC	DPDT	Mom On-Off-Mom On	6 Blade	Silver	IP66

58326 Series • 20A Rocker Switches with Pilot Lights

Single or dual pilot lights. Faceted lenses inset into the actuator. Matte black plastic housing, bezel and actuator. Silver contacts. Internal seal.

- Certified to IP66 for protection against dust and prolonged spray
- Neoprene gasket/panel seal with black nylon bezel and black plastic housing
- 20A at 12V DC. Blade terminals, silver contacts
- Other imprints available upon request. Contact Littelfuse for details

2D Prints and additional information: littelfuse.com/RockerSwitches



58326-01



58326-06



58326-11

PART NUMBERS		RATING	POLE & THROW	ACTION	ILLUMINATION	LED PILOT LIGHT	IMPRINT		TERMINALS	CONTACTS	SEALING
BULK	BOX						ACTUATOR	LENS SYMBOL			
–	58326-01-BX	20A at 12V DC	SPST	Off-On	Independent	Red	None	None	4 Blade	Silver	IP66
58326-06	–	20A at 12V DC	SPDT	On-Off-Mom On	Independent	Red	Override - LVD Auto Mode - System Off	Battery	5 Blade	Silver	IP66
58326-11	58326-11-BX	20A at 12V DC	DPST	Off-On-Mom On	Independent	White	Amber - Warning (On) - Off	SAE lamp symbol	6 Blade	Silver	IP66
58326-15	–	20A at 12V DC	SPST	On-Off	Independent	White	On-Interior-Off	Dome Light	4 Blade	Silver	IP66
58326-27	58326-27-BX	20A at 12V DC	DPDT	On-On-On	Independent	White	Lo/Hi-Pass Heater-Off	Fan	8 Blade	Silver	IP66
58326-29	58326-29-BX	20A at 12V DC	DPDT	On-On-On	Independent	White	Lo/Hi-Fan-Off	Fan	8 Blade	Silver	IP66



10A Narrow Body Curved Rocker Switches

- Curved matte finish narrow body rocker switches
- Fits panels .025" through .200" (.64 to 5.2mm)
- Universal application switches
- Snap-in mounting

2D Prints and additional information: littelfuse.com/RockerSwitches

PART NUMBERS			RATING	POLE & THROW	ACTION	TERMINALS	ACTUATOR	
BULK	BOXED	RETAIL CLAMSHELL					COLOR	ILLUMINATION
54003	54003-BX	–	10A at 12V DC	SPST	On-Off	3 Blade	Red	–
54007	–	54007-BP	10A at 12V DC	SPDT	On-On	3 Blade	Black Face - Red Edges	–
54010	54010-BX	–	10A at 12V DC	SPDT	On-On	3 Blade	Black	–
54012	54012-BX	–	10A at 12V DC	SPST	Off-On	3 Blade	Red	Lit in ON Position



Rocker Switch Bezel and Mounting Accessories

Snap-in mounting of any regular size switch such as 56027, 58030, 58332, 58311, 58312 or 58328 series.

- Bezels can be arranged in a parallel array of any length. Bezels themselves can snap into a panel, or be mounted with the bracket mounting kit.
- Mounting hole in panel should be 2.02"W x 1.90"H (51.3 x 48.3mm) for two bezels. Add 1.03"W (26.2mm) for each additional unit.

Additional information: littelfuse.com/RockerSwitches



82159-1

82159-2

82159-3

98628

82159-02-BP

87167-01-BP

Assembled Example

PART NUMBERS			DETAILS	NOTES	DIMENSIONS
BULK	BOXED	RETAIL CLAMSHELL			
82159-1	82159-1-BX	82159-1-BP	End Bezel	Can be used as left or right end	Two units are 2.37"W x 2.30"H (60.2 x 58.4mm)
82159-2	82159-2-BX	–	Center Bezel	Can be ganged and used with end bezels	Two units are 2.37"W x 2.30"H (60.2 x 58.4mm)
82159-3	82159-3-BX	–	Independent Bezel	Fits Panel Openings: 1.90" x 0.984" (48.3 x 25.0mm)	–
98628	98628-BX	–	Bezel Panel Plug	Fits Panel Hole: .83" x 1.45" (21.1 x 36.8mm)	Face Dimensions: 1.91" x 0.96" (24.4 x 48.8mm)
–	–	82159-02-BP	2 End Bezels, 1 Center Bezel, 1 Plug	Bezel Retail Kit	–
–	–	87167-01-BP	2 Brackets, 1 Brass Stabilizing Rod	Bracket Mounting Retail Kit (holds 2 to 6 bezels)	Assembled kit mounts on top of or under the panel. Mounting holes .710" x .235" (18.0 x 6.7mm)

Standard Heavy Duty Rocker Switches



25A Standard Heavy-Duty Rocker Switches with and without Pilot Lights

- Narrow or wide, moisture-resistant plastic, nickel plate or black housings, bezels and actuators
- Snap-in mounting to fit panels
- Brass blade or screw terminals

2D Prints and additional information: littelfuse.com/RockerSwitches

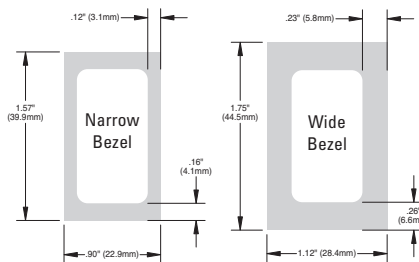

Metal Body Part Numbers



56000-01



56300-01



57000-01



57000-04



57000-10

PART NUMBERS		RATING	POLE & THROW	ACTION	TERMINALS	WIDTH	COLOR	ACTUATOR	PILOT LIGHT	CONTACTS
BULK	BOXED									
56000-01	-	25A at 12V DC	SPST	On-Off	2 Screw	Narrow	Nickel Plated	White		Silver
56000-04	56000-04-BX		SPST	On-Off	2 Screw	Narrow	Nickel Plated	Black		Silver
56300-01	56300-01-BX		SPST	On-Off	3 Screw	Narrow	Nickel Plated	White	•	Silver
57000-01	57000-01-BX		SPST	On-Off	2 Blade	Narrow	Nickel Plated	White		Silver
57000-04	-		SPST	On-Off	2 Blade	Narrow	Black	Black		Silver
57000-10	-		SPST	On-Off	2 Blade	Narrow	Black	Black		Silver
57003-01	57003-01-BX		SPDT	On-Off-On	3 Blade	Narrow	Nickel Plated	White		Silver
57004-10	57004-10-BX		SPDT	Mom-Off-Mom	3 Blade	Narrow	Black	White		Silver
57006-01	-		DPDT	On-Off-On	6 Blade	Narrow	Nickel Plated	White		Silver
57006-07	57006-07-BX		DPDT	On-Off-On	6 Blade	Narrow	Black	White		Silver
57007-11	-		SPDT	On-On-Off	3 Blade	Narrow	Black	Black		Silver
57014-03	57014-03-BX		DPDT	Mom-Off-Mom	4 Blade	Narrow	Black	White		Silver
57300-01	57300-01-BX		SPST	On-Off	3 Blade	Narrow	Nickel Plated	White	•	Silver
57300-22	57300-22-BX		SPST	On-Off	3 Blade	Narrow	Black	White		Silver
57300-11	57300-11-BX		SPST	On-Off-On	4 Blade	Narrow	Black	White	•	Silver
57300-03	57300-03-BX		SPST	On-Off	3 Blade	Narrow	Nickel Plated	Black	•	Silver
57300-02	-		SPST	On-Off	3 Blade	Wide	Nickel Plated	White	•	Silver

Plastic Body Part Numbers



57000-08



57000-23

PART NUMBERS		RATING	POLE & THROW	ACTION	TERMINALS	ACTUATOR	CONTACTS
BULK	BOXED						
56000-08	-	25A at 12V DC	SPST	On-Off	2 Screw	White	Silver
57000-23	57000-23-BX	25A at 12V DC	SPST	On-Off	2 Blade	White	Silver
57013-08	57013-08-BX	25A at 12V DC	DPDT	Mom On-Off-Mom On	6 Blade	White	Silver

FAQ's Rocker & Toggle Switches

Can I replace the bulb in any of your Toggle or Rocker Switches?

The bulbs are wired inside the Switch and therefore cannot be replaced. We use a long lasting bulb so the need for bulb replacement is unlikely in a normal automotive application. We also have LED switches such as 58312 Series that never need replacement. 58312 Series can be found on page 80.

Can I use your Non-Lighted Toggle or Rocker Switches in 110V AC applications?

Except for Switches M-493, 5507 and similar Switches, none of our Switches are officially rated for AC voltage application. While we are confident some of them can, it is entirely up to the end user to determine their suitability for such application. M-493 and 5507 can be found on page 90.

Can I use your Lighted Rocker and Toggle Switches at 110V AC?

No. The lamps inside the Switches have specific voltage ratings.

Can I use your Lighted Rocker and Toggle Switches at 24V DC?

You need to select only the ones rated for 24V because the lights function only at the designed voltage.

Can I use your Non-Lighted Toggle and Rocker switches at 24V DC?

Yes. If they are rated at 12V, you must reduce the current rating by half to obtain the same durability.

Can I get any of your Toggle or Rocker Switches modified to meet my special application?

Yes, in most cases. It is possible we make a suitable item already that isn't listed because of its specialized use. Alternatively, we can make it for you. We have a minimum quantity requirement for special orders.

Do your Lighted Toggle or Rocker Switches have incandescent or LED lamps?

We have both. Contact us if you need a special order with LEDs.

Can I have my company's imprinting placed on a rocker switch?

Yes. Contact us. If it's a standard legend or SAE symbol, there's a chance that it's already available.



5507



54007



58312-A2 & A4



58312-R2 & R4



M-58031-01

Toggle Switches



Dependent or Independent Illumination?

Dependent:

The actuator is illuminated only when the switch is turned on.

Independent:

Illumination is not affected by the actuation of the switch. The illumination can be switched on or off by another switch, such as headlight or interior lighting controls. This is especially useful when locating switches in the dark.



What Does SPST or DPST Mean?

The first two letters, SP or DP, refer to single pole or double pole. The second two letters, ST or DT refer to single throw or double throw.

Pole refers to the number of circuits controlled by the switch. SP switches control one circuit and DP switches control two independent circuits (which act like two identical switches that are mechanically linked). Pole is often confused with terminal, which is a common mistake. Terminals are used for wire connections on the back of the unit and are specified separately.

Throw refers to the extreme position of the actuator. ST switches close a circuit at only one position and the other position is off. DT switches close a circuit in the Up position, as well as the down position and can be configured with two positions (On-Off) or three positions (On-Off-On).

12V, 24V, 36V Ratings

Generally, our 12V non-illuminated toggle switches can be used at higher voltages (and lower current ratings). By proportional calculation a 25A 12V can be used at 8.3A at 36V or 12.5A at 24V. This 'de-rating' actually gives a conservative result. 25A at 12V toggles can actually be used at 15A at 24V and 10A at 36V.

Warning: Switches with pilot lights must be used only at the stated voltage, since the lighting elements function at a specific voltage.



55025 Series • 25A Sealed Toggle



- Waterproof and dustproof to IP68 standard – allows mounting in demanding or harsh locations
- Bushing, handle and hardware – nickel-plated brass
- Standard handle, 0.60" long (15.3mm)
- Standard mounting panel hole 0.468 – 0.474" diameter (11.9-12.0mm)
- Standard bushing diameter 0.47 (12.0mm) 15/32" thread, 0.32" long (5.8mm)
- Wires: 14AWG (2mm²), 12" long (304.8mm)
- Switch body: 1.24" deep x 0.87" wide x 1.46" high (31.6 x 22.0 x 37.1mm)

2D Prints and additional information: littelfuse.com/55025

PART NUMBERS			RATING	POLE & THROW	ACTUATOR	ACTION	TERMINALS	CONTACTS	SEALING
BULK	BOXED	RETAIL CLAMSHELL							
55025	55025-BX	55025-BP	25A at 12V DC	SPST	Nickel-plated brass handle	On-Off	2 wire	Silver	IP68
55025-01	55025-01-BX	55025-01-BP		SPST		Mom On-Off	2 wire		IP68
55025-02	55025-02-BX	55025-02-BP	15A at 24V DC	SPDT		On-Off-On	3 wire		IP68
55025-03	55025-03-BX	55025-03-BP	SPDT	On-On		3 wire	IP68		
55025-04	55025-04-BX	55025-04-BP		SPDT		Mom On-Off-Mom On	3 wire		IP68



Standard Switch



Illuminated Switch

54100 Series • 25A Standard or Illuminated Toggle Switches

Available in a standard black nylon handle or a lighted clear plastic handle, that is 1 1/16" (17.5mm) long.

- Mounting stem 15/32"-32 thread, 15/32" (11.9mm) long, fits panels up to 1/8" (31.8mm) thick
- Includes mounting hardware: black metal facenut and nickel-plated hexnut
- Terminals: .250" blade or 6-32 screw

2D Prints and additional information: littelfuse.com/54100



PART NUMBERS			RATING	POLE & THROW	ACTUATOR	ACTION	ILLUMINATION	ILLUMINATION COLOR			TERMINALS	CONTACTS	SEALING
BULK	BOXED	RETAIL CLAMSHELL						DOWN	CENTER	UP			
54100	54100-BX	54100-BP	25A at 12V DC	SPST	Black Plastic Paddle	On-Off	-	-	-	-	2 screw	Silver	-
54100-01	-	54100-01-BP		SPST	Black Plastic Paddle	On-Off	-	-	-	-	2 blade		O-ring in bushing
54101-01	-	-		SPST	Black Plastic Paddle	Mom On-Off	-	-	-	-	2 blade		-
54109	54109-BX	54109-BP		SPST	Clear Plastic Paddle	On-Off	Independent or Dependent	White	-	Red	4 screw		O-ring in bushing
54109-01	54109-01-BX	-		SPST	Black Plastic Paddle	On-Off	Independent or Dependent	White	-	Red	4 blade		O-ring in bushing
54103	-	54103-BP		SPDT	Black Plastic Paddle	On-Off-On	-	-	-	-	3 screw		-
54104	54104-BX	54104-BP		SPDT	Black Plastic Paddle	Mom On-Off-Mom On	-	-	-	-	3 screw		-
54110	-	-		SPDT	Clear Plastic Paddle	On-Off-On	Independent or Dependent	White	White	Red	4 screw		O-ring in bushing
54107-01	-	54107-01-BP		DPDT	Black Plastic Paddle	On-Off-On	-	-	-	-	6 screw		-

Toggle Switches

25A Heavy Duty Toggle Switches

Standard or long handle. Universal application. Mounting stem is nickel-plated brass 15/32"-32 thread, 15/32" (11.9mm) long, and fits panels up to 9/32" (7.1mm) except where stated otherwise. Phenolic housing, with plated steel cap.

2D Prints and additional information: littelfuse.com/ToggleSwitches



Standard handle, 11/16" (17.5mm) long.



Long handle, 1 1/2" (38.1mm) long.



PVC coated housing with wire leads.

PART NUMBERS			RATING	POLE & THROW	ACTUATOR LENGTH	MATERIAL	ACTION	TERMINALS	CONTACTS	PVC COATED	O-RING SEAL
BULK	BOXED	RETAIL									
5520	5520-BX	5520-BP	25A at 12V DC, 15A at 24V DC	SPST	Standard	Nickel-Plated Brass	On-Off	2 screw	Silver		•
5582	5582-BX	5582-BP		SPST	Standard		On-Off	2 screw			
-	-	5582-30-BP		SPST	Standard		On-Off	2 wire			
5582-36	-	-		SPST	Standard		On-Off	Aptiv 12010973			
5582-10	5582-10-BX	-		SPST	Standard		On-Off	2 wire			•
55014	55014-BX	55014-BP		SPST	Standard		On-Off	2 blade			•
55014-05	55014-05-BX	-		SPST	Standard		On-Off	2 blade			•
55016-06	-	55016-06-BP		SPDT	Standard		On-Off-On	3 blade			
55023	55023-BX	-		SPST	Standard		On-Off	2 screw			
55055	55055-BX	55055-BP		SPST	Long		On-Off	2 blade			
55020	55020-BX	55020-BP		SPST	Standard		Off-Mom On	2 screw			
55020-02	-	55020-20-BP		SPST	Standard		Off-Mom On	2 blade			
55020-04	55020-04-BX	55020-04-BP		SPST	Standard		Off-Mom On	2 wire		•	•
5584	5584-BX	-		SPDT	Standard		On-On	3 screw			
5584-15	-	-		SPDT	Standard		On-On	3 wire			
5586	5586-BX	5586-BP		SPDT	Standard		On-Off-On	3 screw			
55015	55015-BX	-		SPDT	Standard		On-On	3 blade			
55016	55016-BX	-		SPDT	Standard		On-Off-On	3 blade			
55036	55036-BX	-		SPDT	Standard		On-Off-On	3 wire		•	•
55021	55021-BX	55021-BP		SPDT	Standard		Mom On-Off-Mom On	3 screw			
55021-04	55021-04-BX	55021-04-BP		SPDT	Standard		Mom On-Off-Mom On	3 blade			
55021-07	55021-07-BX	55021-07-BP		SPDT	Standard		Mom On-Off-Mom On	3 wire		•	•
55033-01	55033-01-BX	-		SPDT	Standard		Mom On-Off-Mom On	3 blade			
55033-02	55033-02-BX	-		SPDT	Long		Mom On-Off-Mom On	3 blade			
55088	55088-BX	55088-BP		SPDT	Standard		On-Off-Mom On	3 screw			
5588	5588-BX	5588-BP		DPST	Standard		On-Off	4 screw			
55017	55017-BX	-		DPST	Standard		On-Off	4 blade			
55017-02	55017-02-BX	-		DPST	Long		On-Off	4 blade			
5590	5590-BX	-		DPDT	Standard		On-On	6 screw			
5592	5592-BX	5592-BP		DPDT	Standard		On-Off-On	6 screw			
55018	55018-BX	-		DPDT	Standard		On-On	6 blade			
55019	55019-BX	55019-BP		DPDT	Standard		On-Off-On	6 blade			
55054	55054-BX	55054-BP	DPDT	Standard	Mom On-Off-Mom On	6 screw					
55054-04	55054-04-BX	-	DPDT	Long	Mom On-Off-Mom On	6 screw					
55065-02	55065-02-BX	-	DPDT	Long	Mom On-Off-Mom On	6 blade					
55065-03	55065-03-BX	-	DPDT	Standard	Mom On-Off-Mom On	6 blade					
55046	55046-BX	-	DPDT	Standard	Mom On-Off-Mom On	4 blade					
55046-04	55046-04-BX	-	DPDT	Long	Mom On-Off-Mom On	4 blade					
55049-01	55049-01-BX	-	SPST	Long	On-Mon-Off	2 blade					
-	55107-01-BX	-	SPDT	Standard	On-On	9 blade					

* Please inquire about additional bulk quantities



5507 - Ball Handle



5558 - Standard Handle

10A Light Duty Toggle Switches

- Standard handle: 11/16" (17.46mm) long
- Ball handle: 3/8" (9.52mm) long
- Mounting stem has 15/32"-32 thread, 15/32" (11.9mm) long, and fits panels up to 9/32" (7.2mm) thick

2D Prints and additional information: littelfuse.com/ToggleSwitches

PART NUMBERS			RATING	POLE & THROW	ACTUATOR		ACTION	TERMINALS	CONTACTS
BULK	BOXED	RETAIL			TYPE	MATERIAL			
5507	5507-BX	—	10A at 12V DC	SPST	Ball	Nickel-Plated Brass	Off-On	2 screw	Silver
5558	5558-BX	5558-BP	10A at 12V DC	SPST	Standard	Nickel-Plated Brass	Off-On	2 screw	Silver
5568	5568-BX	—	10A at 12V DC	SPST	Ball	Nickel-Plated Brass	Off-On	2x 6" wire leads	Silver
5570	5570-BX	—	10A at 12V DC	SPST	Standard	Nickel-Plated Brass	Off-On	2x 6" wire leads	Silver
55013	55013-BX	—	10A at 12V DC	SPST	Standard	Nickel-Plated Brass	Off-On	2 blade	Silver
M-484	M-484-BX	M-484-BP	10A at 12V DC	SPST	Standard	Chrome-Plated Brass	Off-On	2 screw	Silver
M-493	—	M-493-BP	10A at 12V DC	SPST	Ball	Chrome-Plated Brass	Off-On	2 screw	Silver
M-584	M-584-BX	M-584-BP	10A at 12V DC	SPST	Standard	Chrome-Plated Brass	Off-On	2x 6" wire leads	Silver

551800 Series • 30A Extra Heavy Duty Toggle Switches

Universal application. Diecast housing. For stem- or bracket-mounting. 15/32"-32 thread mounting stem, with keyway.

- Brackets: .170" (4.3mm) diameter holes, 1.72" (43.7mm) on centers
- Fits panels up to 3/16" (4.8mm) thick
- Chrome plated brass handle, 1 1/16" long (27.0mm)

2D Prints and additional information: littelfuse.com/ToggleSwitches



PART NUMBERS			RATING	POLE & THROW	ACTION	ACTUATOR	TERMINALS	CONTACTS
BULK	BOXED	RETAIL						
—	551001-BX	—	20A at 6-12V DC	SPST	Mom On-Off	Chrome-plated brass handle	2 blade	Silver
—	551800-BX	—		SPST	On-Off		2 screw	
551802	—	—		SPDT	On-Off-On		3 screw	
551840	551840-BX	551840-BP	30A at 6-12V DC 15A at 24-36V DC	SPST	On-Off		2 screw	
551841	551841-BX	—		SPST	Mom On-Off		2 screw	
551842	551842-BX	—		SPDT	On-Off-On		3 screw	
551844	551844-BX	—		SPDT	Mom On-Off-Mom On		3 screw	
—	551846-BX	—		DPDT	On-Off-On		6 screw	
551849	—	—		SP3C	On-On-Off		4 screw	



M-54111 Series • 25A Lighted Tip Toggles

Tip of handle is illuminated Red in the On position, illuminated Clear in the Off position.

2D Prints and additional information: littelfuse.com/ToggleSwitches



PART NUMBERS			RATING	POLE & THROW	ACTION	ACTUATOR	ILLUMINATION	ILLUMINATION COLOR		TERMINALS	CONTACTS
BULK	BOXED	RETAIL CLAMSHELL						ON	OFF		
M-54111-01	M-54111-01-BX	M-54111-01-BP	25A at 12V DC	SPST	On-Off	Black plastic handle w/ illuminated tip	Independent or Dependent	Red	White	4 blade	Silver
M-54111-02	M-54111-02-BX	M-54111-02-BP	25A at 12V DC	SPDT	On-Off-On	Black plastic handle w/ illuminated tip	Independent or Dependent	Red	White	5 blade	Silver

Toggle Switches



59024 Series • 25A Long Handle "Duck Bill" Toggle Switches

- 15/32"-32 thread mounting stem
- Fits panels up to 1/4" (6.4mm) thick
- Includes mounting hardware: black knurled facenut, hexnut
- Keyway is in the down position. 1" (25.4mm) handle, black plastic, matte finish
- Terminals: .250" blade or 8-32 screw

2D Prints and additional information: littelfuse.com/ToggleSwitches

PART NUMBERS			RATING	POLE & THROW	ACTION	ACTUATOR	TERMINALS	CONTACTS	SEALING
BULK	BOXED	RETAIL CLAMSHELL							
59024-100	59024-100-BX	–	25A at 12V DC	SPST	On-Off	Black Plastic Duck Bill Paddle	2 blade	Silver	–
59024-104	–	–		SPDT	On-On		3 blade		–
59024-106	59024-106-BX	–		SPDT	On-Off-On		3 blade		–
–	59024-108-BX	–		SPDT	Mom On-Off-Mom On		3 blade		–
59024-110	59024-110-BX	–		DPST	On-Off		4 blade		–
59024-116	–	–		DPDT	On-On		6 blade		–
59024-118	–	–		DPDT	On-Off-On		6 blade		–
59024-200	59024-200-BX	–		SPST	On-Off		2 screw		–
59024-218	–	–		DPDT	On-Off-On		6 screw		–



59024-00 Series • Freightliner Replacement "Duck Bill" Toggle Switches

Black phenolic switch housing with metal cap. Terminals are arranged to match OEM wiring connectors with or without brackets.

- Fits panels to .093" (2.4mm) with spacer provided, or to .25" (6.4mm) without spacer
- 15/32"-32 thread mounting stem
- Includes mounting hardware: black metal facenut. Keyway is in the down position
- Black plastic 1" (25.4mm) handle, matte finish
- Dual contacts for extra durability

2D Prints and additional information: littelfuse.com/ToggleSwitches

PART NUMBERS			RATING	POLE & THROW	ACTION	ACTUATOR	TERMINALS	CONTACTS	DUAL CONTACTS	MOUNTING BRACKET
BULK	BOXED	RETAIL CLAMSHELL								
59024-33	59024-33-BX	–	25A at 12V DC	SPST	On-Off	Black Plastic Duck Bill Paddle	2 blade	Silver	•	•
59024-35	59024-35-BX	–		DPST	On-Off		4 blade		•	•
59024-36	59024-36-BX	–		DPDT	On-Off-On		6 blade		•	•
59024-38	59024-38-BX	–		DPDT	Mom On-On-Mom On		6 blade		•	•
59024-12	59024-12-BX	–		SPST	On-Off		2 blade		•	•
59024-14	59024-14-BX	–		DPST	On-Off		4 blade		•	•
59024-15	59024-15-BX	–		DPDT	On-Off-On		6 blade		•	•

Toggle Switches & Accessories



Specialized Application Toggle Switches

- Specialized toggle switches have specific functions and applications. See the "APPLICATION NOTES" column below for details
 - 15/32"-32 thread mounting stem, .46" (11.9mm) long, mounts in panels up to 9/32" (7.1mm) thick
 - Nickel-plated brass handle: standard .687" (17.5mm) or long 1.5" (38.1mm)
- 2D Prints and additional information: littelfuse.com/ToggleSwitches

PART NUMBERS		RATING	POLE & THROW	ACTION			ACTUATOR		TERMINALS	CONTACTS	APPLICATION NOTES
BULK	BOXED/BP			UP	CENTER	DOWN	HANDLE LENGTH	MATERIAL			
55064	55064-BX	25A at 12V DC	DPDT 4-circuit	Park, Tail & Headlamps	Off	Park, Tail & Auxiliary Lamps	Long	Nickel-Plated Brass	6 blade	Silver	4-Circuit Headlamp Switch
55071	-	25A at 12V DC	DP 2-circuit	Mom On B, 1&2 (Day Signaling)	On 1&2	Mom Off (Night Signaling)	Standard	Nickel-Plated Brass	3 blade	Silver	2-Circuit Marker Lamp Switch
55015-03	55015-03-BX	25A at 12V DC	SPDT	On	-	On	Standard	Nickel-Plated Brass	3 blade	Silver	3-way Lighting Switch See Diagrams Below
59071	59071-BX	25A at 12V DC	DP	Mom On 1, 4&5	On 4&5	Off	Standard	White Plastic	3 blade	Silver	Ignition/Start
55093	55093-BX		SPDT	On	On	Off	Standard	Nickel-Plated Brass	3 blade	Silver	Two Speed Heater Fan Toggle Switch
M-597	M-597-BP		SPST	On	-	Mom On	Standard	Nickel-Plated Brass	3 Leads	Silver	Marine Safety Switch

3- and 4-way Lighting

3-way lighting permits a light (or a set of lights) to be controlled from two switches usually mounted in different locations. Similarly, 4-way lighting enables control from three switch locations.



Toggle Accessories



PART NUMBERS			DESCRIPTION
BULK	BOXED	RETAIL	
82468	82468-BX	-	Flip Cover Switch Guard
5543	5543-BX	-	5558 switch mounted in 5543-15 Recessed Faceplate Switch Guard
5543-15	5543-15-BX	-	Recessed Faceplate Switch Guard
81255	81255-BX	81255-BP	Half-Boot Seal
81264	81264-BX	81264-BP	Grey Boot Seal (other colors available, please contact Littelfuse)
81264-01	81264-01-BX	81264-01-BP	Black Boot Seal (other colors available, please contact Littelfuse)
81264-05	81264-05-BX	-	Red Boot Seal (other colors available, please contact Littelfuse)
5543-09	-	-	55015-12 switch mounted Recessed Faceplate Switch Guard
81264-02	81264-02-BX	-	Blue Boot Seal (other colors available, please contact Littelfuse)
81264-07	81264-07-BX	-	Yellow Boot Seal (other colors available, please contact Littelfuse)
8250	8250-BX	-	Toggle Switch "ON - OFF" Face Plate Cover
M-598	-	M-598-BP	Toggle Marine Emergency Lanyard

* Please inquire about additional bulk quantities

Switch Diagrams

Switch Reference Guide - SPST, SPDT, DPST, DPDT

SP and DP refer to single pole and double pole, ST and DT refer to single throw and Double throw.

SP: Single Pole, one circuit controlled by the switch.

DP: Double Pole, two independent circuits controlled by the switch which are mechanically linked.

Note: "Pole" should not be confused with "Terminal". The DPST switch, for example has four terminals however it is a Double Pole (DP) and not a four pole (4P) switch.

ST: Single Throw, closes a circuit at only one position and with one throw.

DT: Double Throw, closes a circuit in the up or down position (On-On). A Double Throw switch can also have a center position such as On-Off-On.

The following switch diagrams illustrate the most common types of toggle and rocker switch.

SPST On-Off



DPST On-Off

Both load terminals can be energized at the same time. They are independent of each other and could be of different voltages.



SPDT On-On

Only one of the loads can be energized at a time.



DPDT On-On

Functions like two separate SPDT switches operated by the same actuator. Only two loads can be On at a time.

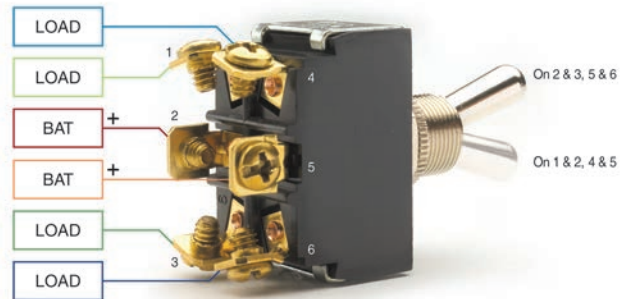

SPDT On-Off-On

Only one of the loads can be energized at a time.



DPDT On-Off-On

Functions like two separate SPDT switches operated by the same actuator. Only two loads can be On at a time.

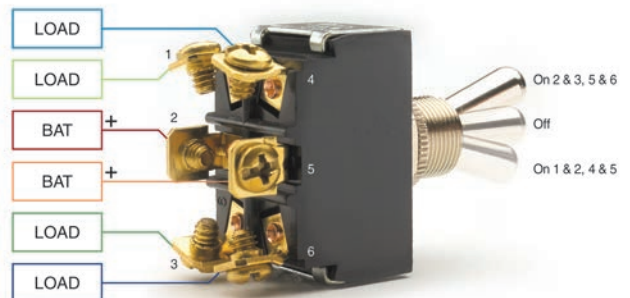

Switch Diagrams

Single-Pole (SP) & Double-Pole (DP) Switch Wiring Diagrams

Diagrams represent both momentary contact or maintained contact switches.

Switches without Pilot Lights

SPST Off-ON (2 terminals)

Diagram A

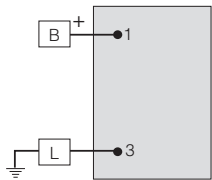
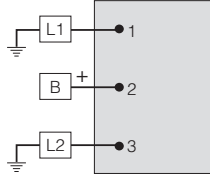

Diagram A1



SPDT On-Off-On (3 terminals)

Diagram B



-

-

DPST Off-On (4 terminals)

Diagram C

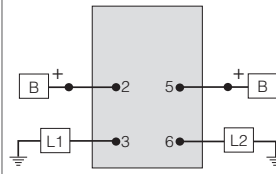
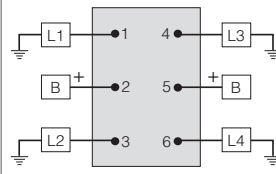

Diagram C1



DPDT On-On (6 terminals)

Diagram D



-

-

DPDT On-Off-On (6 terminals)

Diagram E

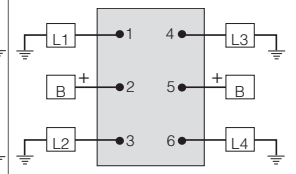

-

-

Switches with One Pilot Light

SPST Off-ON – Dependent Illumination (Three terminals)

Diagram F

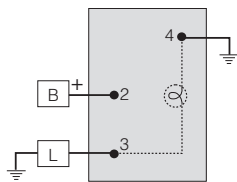

SPST Off-On – Independent Illumination (Four terminals)

Diagram G1



SPST Off-On – Independent converted to Dependent (4 terminals)
Connect jumper wire from T3 to T6 and connect T4 to ground

Diagram G2

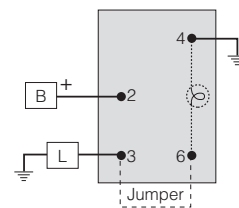

Switches with Two Pilot Lights

SPST Off-On with Dependent & Independent Lights (Four terminals)

Diagram H

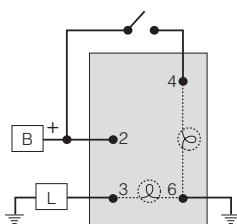

SPDT On-Off-On or On-On with Dependent & Independent Lights (Four terminals)

Diagram J

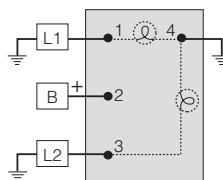

SPDT On-Off-On or On-On with 2 Independent Lights (Four terminals)

Diagram K

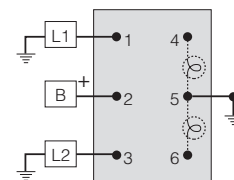

Momentary Switches



Momentary switches operate by pushing a button either by thumb or by the closing of a door and will remain in their switched state as long as they are being actuated. Momentary Switches are either “normally Off, spring return to Off” or “normally On, spring return to On.”

What Does Momentary Mean?

A momentary switch, also known as a “mom,” is spring-loaded. When pressed the actuator moves, remove your finger and it returns to its original position. Opposite of a momentary switch is a maintained contact switch. When the actuator is pressed it stays in the position until it is pressed in the other direction.

More Momentary Switches in Other Sections

Find more momentary switches (moms) in the following catalog sections.

- Ignition Switches
- Rocker Switches
- Toggle Switches
- Push-Pull Switches
- Rotary Switches
- Foot Operated Switches

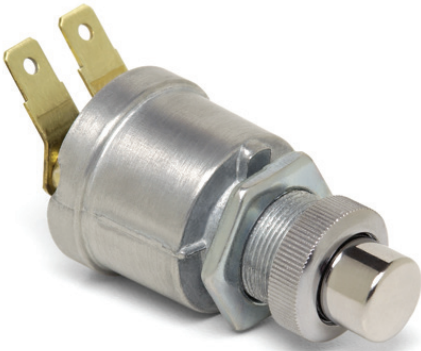

Momentary Push-Button Switches

35A • Heavy Duty Cylindrical Housing Push-Button Switches

For applications to 36V DC. On with button depressed, spring return to Off.

Additional information: littelfuse.com/Push-Button-Switches



PART NUMBERS			RATING	POLE & THROW	NORMAL POSITION	ACTUATOR		TERMINALS	CONTACTS	MOUNTING STEM	NOTES
BULK	BOXED	RETAIL CLAMSHELL				DETAIL	CAP				
9095	9095-BX	-	35A at 12V DC 20A at 24V DC	SPST	Normally Off	Chrome Plated Button	-	2 Screw	Silver	5/8"-32 thread 21/32" long	-
9245	9245-BX	9245-BP			Normally Off	Black Plastic Button	Snap-On Black Rubber	2 Screw		5/8"-32 thread 21/32" long	O-ring Seal
-	90036-02-BX	-			Normally Off	Chrome Plated Button	-	2 Blade		5/8"-32 thread 21/32" long	Fits Delphi (Packard) 2-way Connector 2973407
9231	9231-BX	-			Normally Off	Recessed Chrome Plated Button	-	2 Screw		5/8"-32 thread 21/32" long	Protected Button with Recessed Design
90030	90030-BX	90030-BP			Normally Off	Black Plastic Button	Screw-On Black Rubber	2 Screw		5/8"-32 thread 21/32" long	-
90030-01	90030-01-BX	-			Normally Off	Black Plastic Button	Screw-On Brown Oil-Resistant Rubber	2 Screw		5/8"-32 thread 21/32" long	-
90030-04	90030-04-BX	-			Normally Off	Black Plastic Button	Screw-On Red Rubber	2 Screw		5/8"-32 thread 21/32" long	-
90030-12	-	-			Normally Off	Chrome Plated Button	Black Cap	2 Terminal Wire		5/8"-32 thread 5/8" long	-
90030-24	-	-			Normally Off	Chrome Plated Button	Black Cap	2 Screw		5/8"-32 thread 5/8" long	-
90030-33	-	-			Normally Off	Chrome Plated Button	Black "Push" Cap	2 Screw		5/8"-32 thread 5/8" long	-
90030-43	-	-			Normally Off	Chrome Plated Button	Black Cap	2 Screw		5/8"-32 thread 5/8" long	-
90030-53	-	-			Normally Off	Chrome Plated Button	Black Cap	2 Screw		5/8"-32 thread 5/8" long	Assembled
90036-10	-	-			Normally Off	Chrome Plated Button	Black Cap	2 Blade		5/8"-32 thread 5/8" long	Horn Imprinted
9216-03	9216-03-BX	-			Normally Off	Chrome Plated Button	Screw-On Black Rubber	2 Screw		5/8"-32 thread 5/8" long	Gold Dichromate Dipped Case
9100	9100-BX	-			Normally Off	Chrome Plated Plunger	-	2 Screw		15/32"-32 thread 9/16" long	-
9216-10	-	-			Normally Off	Chrome Plated Button	Black Cap	Aptiv 12010973 (Sealed)		5/8"-32 thread 5/8" long	Sealed Gold Dichromate Dipped Case
9216	9216-BX	-			Normally Off	Chrome Plated Button	-	2 Screw		5/8"-32 thread 5/8" long	Sealed Gold Dichromate Dipped Case
9276-09	9276-09-BX	-			Normally Off	Black Plastic Button	Screw-On Black Rubber	2 Screw		5/8"-32 thread 21/32" long	Two circuits simultaneously energized
9238-07	-	-			Normally Off	Chrome Plated Button	-	2 Blade		5/8"-32 thread 7/8" long	-
90018	-	-			Normally Off	Chrome Plated Button	-	2 Screw		5/8"-32 thread 5/8" long	-

10

Momentary Push-Button Switches

10A • Heavy Duty Rectangular Housing Push-Button Switches

For applications up to 36V DC. On with button depressed, spring return to Off.

Additional information: littelfuse.com/Push-Button-Switches



PART NUMBERS		RATING	POLE & THROW	ACTION	NORMAL POSITION	ACTUATOR		TERMINALS	MOUNTING STEM	NOTES
BULK	BOXED					DETAIL	CAP			
-	9044-BX	10A at 12V DC	SPST	Off-On	Off	Chrome Plated Button	-	2 Screw	5/8"-32 thread 1.06" long	Gasket Seal
9023	9023-BX	15A Resistive, 10A Inductive at 12V DC 8A Resistive, 5A Inductive at 24V DC	SPST	Off-On	Off	Chrome Plated Button	-	2 Screw	5/8"-32 thread .87" long	-
9238	9238-BX	15A Resistive, 10A Inductive at 12V DC 8A Resistive, 5A Inductive at 24V DC	SPST	Off-On	Off	Chrome Plated Button	-	2 Blade	5/8"-32 thread .87" long	-
9115	9115-BX	10A at 12V DC	SPST	On-Off	On	Chrome Plated Button	-	2 Screw	5/8"-32 thread 7/8" long	-
9211	9211-BX	10A at 12V DC	DPST	On-Off	On	White Plastic .33"Ø Button	-	4 Blade	7/16"-20 thread	Commonly used in school bus stepwell and door control
9109	9109-BX	10A at 12V DC	SPST	Off-On	Off	Shaft has 3/32" hole for cable or lever attachment	-	2 Screw	1/2"-20 thread 5/8" long	Pull On, Spring Return to Off
9212	9212-BX	10A at 12V DC	SPST	On-Off	On	1/2" Plunger	Nylon Cap	2 Blade	7/16"-20 thread 1/2" long	Brass Contacts
9165	9165-BX	10A at 12V DC	DPST	Off-On	Off	Chrome Plated Button	-	3 Screw	5/8"-32 thread 21/32" long	2 steel hexnuts and facenet on stem
91126	91126-BX	10A at 12V DC	SPST	Off-Mom On	Off	Chrome Plated Plunger	-	2 Wire	7/16"-20 thread 7/16" long	-
92116	92116-BX	10A at 12V DC	SPST	Off-On	Off	Chrome Plated Plunger	Black Cap	2 Blade	5/8"-32 thread 1" long	Hencol Sealed
90002	90002-BX	10A at 12V DC	SPST	On-Mom Off	On	Chrome Plated Button	-	2 Screw	5/8"-32 thread 1.25" long	-
91109-03	-	20A at 12V DC 10A at 24V DC	DPST	On-On	On	Chrome Plated Button	Black Cap	4 Wire	5/8"-32 thread 3/4" long	Cir. A Normally On, Cir. A Off/ Cir. B On when depressed (spring return to A On).

20A • Heavy Duty Rectangular Housing Push-Button Switches for Mechanical Activation

10A at 24V DC, 20A at 12V DC. On with button depressed, spring return to Off.

- Steel button protrudes through the cap. Black rubber cap snaps into a special groove on the nut, which is deep-threaded and gives a positive seal
- Steel button feature is ideal for mechanical actuation

Additional information: littelfuse.com/Push-Button-Switches



90043



90043-07

PART NUMBERS			RATING	POLE & THROW	ACTION	NORMAL POSITION	ACTUATOR		TERMINALS	MOUNTING STEM	GASKET SEAL	NOTES
BULK	BOXED	RETAIL CLAMSHELL					DETAIL	CAP				
90043	90043-BX	-	20A at 12V DC 10A at 24V DC	SPST	Off-On	Off	Steel Plunger	Snap-On Black Rubber	2 Blade	5/8"-32 thread .625" long	•	Fits Delphi (Packard) 2-Pole Connector 2977647
90043-07	90043-07-BX	-	20A at 12V DC 10A at 24V DC	SPST	Off-On	Off	Steel Plunger	Snap-On Black Rubber	2x 7" wire leads	5/8"-32 thread .625" long	•	PVC-Coated
90043-31	90043-31-BX	-	20A at 12V DC 10A at 24V DC	SPST	Off-On	Off	Steel Plunger	Snap-On Black Rubber	2 Wire	5/8"-32 thread .625" long	•	Hencol Sealed Body

Horn Push Buttons



96101

Surface and clamp mount push-button horn switches. Clamp mount allows attachment on a steering column up to 1-1/2" (38.1mm) diameter.

PART NUMBERS			RATING	TYPE	SIZE	DETAIL	TERMINALS
BULK	BOXED	RETAIL					
96101	96101-BX	-	5A at 12V DC	Surface Mount	13/16"Ø	Black Plastic	2 Screw

Momentary Push-Button Switches

35-10A • Heavy Duty Marine-Grade Push-Button Switches

For applications to 36V DC. On with button depressed, spring return to Off

Designed for universal applications within harsh environments. Their mounting, body, and actuator features are designed for ease-of-use and extended product lifecycle. With heavy duty brass bodies, the Marine Push Pull Switches are designed for circuit control within the Marine environment.



M-626



M-485

PART NUMBERS			RATING	POLE & THROW	ACTION	NORMAL POSITION	ACTUATOR	TERMINALS	MOUNTING STEM	FITS PANELS	NOTES
BULK	BOXED	RETAIL CLAMSHELL									
M-490	M-490-BX	M-490-BP	35A at 12V DC 20A at 24V DC 10A at 36V DC	SPST	Off-On	Off	Chrome Plated Button	2 screw	5/8"-32 thread 1-3/8" long	1" (25.4mm) thick	-
M-612	M-612-BX	M-612-BP		SPST	Off-On	Off	Chrome Plated Button	2 screw	5/8"-32 thread 1-3/8" long	1" (25.4mm) thick	With Protected Bezel
M-626	M-626-BX	M-626-BP		SPST	Off-On	Off	Black Rubber Cap (407-03)	2 screw	5/8"-32 thread 1-3/8" long	1" (25.4mm) thick	Same as M-490, but with snap-on cap
M-626-02	M-626-02-BX	M-626-02-BP		SPST	Off-On	Off	Black Rubber Cap (83280-03)	2 screw	5/8"-32 thread 1-3/8" long	1" (25.4mm) thick	-
M-485	M-485-BX	M-485-BP	10A at 12V DC	SPST	Off-On	Off	Chrome Plated Button	2 Screw	5/8"-32 thread 1.0" long	3/4" (19.1mm) thick	Gasket Seal
M-492	M-492-BX	M-492-BP		SPST	Off-On	Off	Chrome Plated Button	2 Screw	5/8"-32 thread 1.0" long	1" (25.4mm) thick	-
M-524	-	-		SPST	Off-On	Off	Black Rubber Cap (407-03)	2 Screw	5/8"-32 thread 1.0" long	3/4" (19.1mm) thick	Gasket Seal
M-914-01	M-914-01-BX	-		SPST	Off-On	On	Chrome Plated Button	2 Screw	5/8"-32 thread 1.0" long	3/4" (19.1mm) thick	-



90047

Engine Start / Engine Stop Buttons

- Diecast housing, with knurled aluminum facenut
- Two screw terminals with lockwashers
- Mounting stem 7/8"-24 thread, keyed to prevent turning, fits panels .04" - .10" thick (1.0 - 2.5mm)
- Impact-resistant molded plastic button with white imprint, repels oil, water and other liquids
- 2 7/32" L x 1 1/8" D (50.8 x 28.6 x 3.18mm)

PART NUMBERS		RATING	POLE & THROW	ACTION	NORMAL POSITION	DETAIL	IMPRINT	TERMINALS	CONTACTS	MOUNTING STEM	SEALING
BULK	BOXED										
90047	90047-BX	35A at 12V DC	SPST	Off-On	Off	Black Plastic Button	Start	2 Screw	Silver	7/8"-24 thread	-
90047-01	90047-01-BX		SPST	Off-On	Off	Black Plastic Button	Start	2 Screw	Silver	7/8"-24 thread	Built-In Seal Around Lip
90048	90048-BX	20A at 24V DC	SPST	Off-On	Off	Red Plastic Button	Stop	2 Screw	Silver	7/8"-24 thread	-
90048-01	90048-01-BX		SPST	Off-On	Off	Red Plastic Button	Stop	2 Screw	Silver	7/8"-24 thread	Built-In Seal Around Lip



10A • PVC-Coated Heavy Duty Rectangular Housing Push-Button Switches

For applications to 36V DC. On with button depressed, spring return to Off.

- Corrosion-resistant brass case
- PVC-Coated body sealed against moisture and dirt, with black rubber snap-on cap (407-03)
- Fits panels up to 1/2" (12.7mm) thick

Additional information: littelfuse.com/Push-Button-Switches

PART NUMBERS			RATING	POLE & THROW	ACTION	NORMAL POSITION	ACTUATOR		TERMINALS	MOUNTING STEM	PVC-COATED
BULK	BOXED	RETAIL CLAMSHELL					DETAIL	CAP			
M-608	M-608-BX	M-608-BP	10A at 12V DC	SPST	Off-On	Off	Brass Button	Rubber	2 wire leads	5/8"-32 thread 15/16" long	•

5A • Compact Design Buttons

- Moisture-resistant molded plastic case
- Snaps into .80 - .85" (20.3 - 21.6mm) diameter hole. Fits panels .03 - .07" thick (.76 - 1.8mm)
- Normally off black, white or red button compact switch



9075

PART NUMBERS			RATING	POLE & THROW	ACTION	NORMAL POSITION	DETAIL	TERMINALS
BULK	BOXED	RETAIL						
9075	9075-BX	-	5A at 12V DC	SPST	On-Mom Off	On	Black Plastic 9/16" long	2 Female Bullet
9187-02	-	9187-02-BP			Off-Mom On	Off	Red Button	2 Blade
9187	9187-BX	9187-BP			Off-Mom On	Off	Black Button	2 Blade

Momentary Push-Button Switches



Threaded and Push Button Caps

- Threaded rubber cap is permanently fastened to the integral mounting nut by a rolled brass bezel
- Snap-on rubber caps feature ribs on the inside of the rubber cap engage with the switch facenut

PART NUMBERS			TYPE	COLOR	IMPRINT	NOTES
BULK	BOXED	RETAIL				
83280	83280-BX	-	Screw-On - 5/8"-32 threads	Grey	PUSH	-
83280-02	83280-02-BX	-	Screw-On - 5/8"-32 threads	Red	PUSH	-
83280-03	83280-03-BX	83280-03-BP	Screw-On - 5/8"-32 threads	Black	PUSH	-
83280-05	83280-05-BX	-	Screw-On - 5/8"-32 threads	Brown	PUSH	Molded from Hydrin which is more resistant to fuel and oils
407-01	-	-	Snap-On	Grey	PUSH	Snaps on to 83261 face nut
407-02	-	-	Snap-On	Red	PUSH	Snaps on to 83261 face nut
407-03	407-03-BX	407-03-BP	Snap-On	Black	PUSH	Snaps on to 83261 face nut

Momentary Door Switches

10A • Specialized Door Momentary Switches



91811



91800

- Designed for 8 light warning systems in school buses.
- 91811: Two circuits, progressive plunger travel alternates the circuits.
- 91800: Pull out feature permits circuit to be shut off manually when the door must remain open but flashing lights operation is not required.

Additional information: littelfuse.com/Door-Switches



PART NUMBERS		RATING	POLE & THROW	POSITIONS	ACTION	NORMAL POSITION	ACTUATOR		TERMINALS	CASE	CONTACTS	MOUNTING
BULK	BOXED						DETAIL	LENGTH				
91800	91800-BX	10A at 12V DC	SPST	3	Mom Off-On-Pull Off	On	Button	7/32" On 3/4" Off	2 Screw	Plated Steel	Silver	7/16"-20 thread, 7/16" long Two Flats for Double-D Mounting
91050	91050-BX	-	TPTT	2	On-Mom Off	On	Button	3/10"	8 Blade	Plated Steel	Silver	7/16"-20 thread, 7/16" long Two Flats for Double-D Mounting

10

5A • Door Momentary Switches with Faceplate

Additional information: littelfuse.com/Door-Switches



9001 / 9002

9087



9270 / 9269

PART NUMBERS		RATING	POLE & THROW	ACTION	NORMAL POSITION	ACTUATOR			TERMINALS	CASE	CONTACTS	MOUNTING
BULK	BOXED					DETAIL	LENGTH	D/A.				
9001	9001-BX	5A at 12V DC	SPST	On-Mom Off	Normally On	Rounded	7/16"	45/64"	2 Screw	Plated Steel	Silver	Two 9/64"Ø Mounting Holes 1-3/8" on Center
9050-01	9050-01-BX								1 Screw			Two 9/64"Ø Mounting Holes 1-3/8" on Center
9270	9270-BX								2 Blade			Two 9/64"Ø Mounting Holes 1-3/8" on Center
-	9087-BX			2 Screw	Four 3/16"Ø Mounting Holes 1-3/8" and 2-1/16" on Center							
-	9002-BX			2 Screw	Two 9/64"Ø Mounting Holes 1-3/8" on Center							
9269	9269-BX			2 Blade	Two 9/64"Ø Mounting Holes 1-1/2" on Center							

Momentary Door Switches

10-5A • SPST • Door Momentary Switches

Additional information: littelfuse.com/Door-Switches



9264



9003

PART NUMBERS		RATING	POLE & THROW	POSITIONS	ACTION	NORMAL POSITION	ACTUATOR		TERMINALS	CASE	CONTACTS	MOUNTING
BULK	BOXED						DETAIL	LENGTH				
9055	9055-BX	10A at 12V DC	SPST	2	On-Mom Off	On	Shaft	1/2"	2 Screw	Plated Steel	Silver	7/16"-20 thread, 7/16" long Two Flats for Double-D Mounting
9264	9264-BX	10A at 12V DC					Button	1/2"				7/16"-20 thread, 7/16" long Two Flats for Double-D Mounting
9264-04	-	-					Button	7/16"				-
9264-02	9264-02-BX	10A at 12V DC					Button	1/2"				7/16"-20 thread, 7/8" long Two Flats for Double-D Mounting
9003	9003-BX	5A at 12V DC					Rounded	3/32"				1/2"-20 thread 1/14" long
9055-08	-	20A at 12V DC					Shaft	1/2"	2 Blade 7/16"-20 thread, 7/8" long Two Flats for Double-D Mounting			

10A • DPST • Door Momentary Switches

- Energizes two circuit simultaneously.
- Popular for use in school bus stepwell and door control.

Additional information: littelfuse.com/Door-Switches



9118/9180



91801

PART NUMBERS		RATING	POLE & THROW	POSITIONS	ACTION	NORMAL POSITION	ACTUATOR		TERMINALS	CASE	CONTACTS	MOUNTING
BULK	BOXED						DETAIL	LENGTH				
9118	9118-BX	10A at 12V DC	DPST	2	On-Mom Off	On	Button	19/64"	4 Screw	Plated Steel	Silver	7/16"-20 thread, 7/16" long Two Flats for Double-D Mounting
91801	91801-BX	10A at 12V DC	DPST	2	On-Mom Off	On	Button	19/64"	4 Blade			
9180	9180-BX	10A at 12V DC	DPST	2	Off-Mom On	Off	Button	15/32"	4 Screw			
9118-04	9118-04-BX	10A at 12V DC	DPST	2	On-Mom Off	On	Button	19/64"	4 Screw			7/8"-20 thread, 7/8" long Two Flats for Double-D Mounting

5A • Normally Grounded Single Circuit Door Momentary Switches

Additional information: littelfuse.com/Door-Switches



91812

PART NUMBERS		RATING	POLE & THROW	ACTION	NORMAL POSITION	ACTUATOR		TERMINALS	CASE	CONTACTS	MOUNTING
BULK	BOXED					DETAIL	LENGTH				
91812	91812-BX	5A at 12V DC	SPST	On-Mom Off	Normally Grounded	Rounded	33/64"	1 Blade	Plated Steel	Silver	7/16"-20 thread, 7/16" long Two Flats for Double-D Mounting
91812-02	-					Chrome Plated Plunger	1 Blade 1Wire				

10

5A • Sealed Door Momentary Switches with Faceplate

- Sealed Plunger and wire leads.

Additional information: littelfuse.com/Door-Switches



9270-01

PART NUMBERS		RATING	POLE & THROW	ACTION	NORMAL POSITION	ACTUATOR			TERMINALS	CASE	CONTACTS	MOUNTING
BULK	BOXED					DETAIL	LENGTH	DIA.				
9270-01	9270-01-BX	5A at 12V DC	SPST	On-Mom Off	Normally On	Round Black Rubber Cap	.436"	.70"	2 PVC Coated 8" Wire Leads	Plated Steel	Silver	Two .144"Ø Mounting Holes 1-1/2" on Center

Push-Pull, Rotary & Foot Switches



What is the Difference Between Push-Pull, Rotary & Foot Switches?

Push-Pull switches operate by pushing or pulling the actuator depending on the configuration of the switch.

Rotary switches are activated by a manual rotation of the actuator into two or three positions.

Foot switches are mounted on or through the floorboard for hands free operation of the application

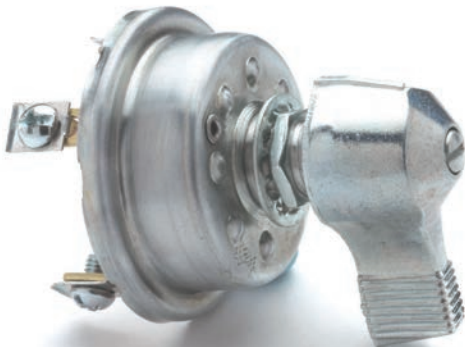

What is Dynamic Parking in Wiper Switches?

Windshield wiper switch engineers call the feature 'dynamic parking' when the windshield wiper switch actively returns the wiper to home position, rather than waiting until the cycle reaches home.

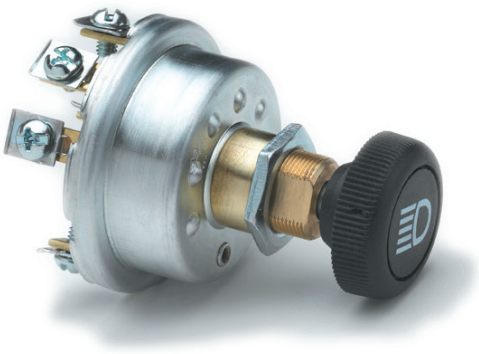

Push-Pull Switches

One and Two Circuit Push-Pull Switches



PART NUMBERS		VOLTAGE	RATING	CIRCUITRY	TYPE	NORMAL POSITION	ACTUATOR KNOB	TERMINALS	CONTACTS	HOUSING	MOUNTING STEM		NOTES
BULK	BOXED										MATERIAL	SIZE	
5007	5007-BX	6-36V DC	10A at 12V DC	SPST	Off-On	Off	Tan Plastic (10-32 metal thread)	2 screw	Copper	Plated Steel	Aluminum	3/8"-32 thread 5/8" long	-
5011	5011-BX		10A at 12V DC	SPST	Off-On	Off	Chrome	2 screw	Copper	Plated Steel	Steel	1/2"-20 thread 5/8" long	-
50070	50070-BX		10A at 12V DC	SPST	Off-On	Off	Chrome	2 blade	Silver	Plated Steel	Steel	1/2"-20 thread 5/8" long	-
50001	50001-BX		10A at 12V DC	SPST	Off-On	Off	Black Plastic (10-32 metal thread)	2 screw	Silver	Plated Steel	Brass	1/2"-20 thread 5/8" long	-
50002	50002-BX		20A at 12V DC	SPST	Off-On	Off	Integral Chrome Brass	2 screw	Silver	Plated Steel	Brass	1/2"-20 thread 5/8" long	-
50066	50066-BX		20A at 12V DC	SPST	Off-On	Off	Black Plastic (10-32 metal thread)	2 screw	Silver	Plated Steel	Brass	1/2"-20 thread 5/8" long	O-Ring stem seal & Gasket Sealed Terminal Insulator
50046	50046-BX		10A at 12V DC	SPST	On-Off	On	Black Plastic (10-32 metal thread)	2 screw	Copper	Plated Steel	Aluminum	3/8"-32 thread 5/8" long	-
50046-09	-		10A at 12V DC	SPST	On-Off	On	Plunger	2 screw	Copper	Plated Steel	Aluminum	3/8"-32 thread 5/8" long	-
5050	-		20A at 12V DC	DPST	On-Off	Off	Black Plastic "Lights" (10-32 metal thread)	2 screw & 1 stud	Silver	Plated Steel	Steel	1/2"-20 thread 5/8" long	Includes 30A Circuit Breaker
50082	50082-BX		8A at 12V DC	SPDT	Off-On1-On2	-	Integral Chrome	3 blade	Copper	Plated Steel	Steel	1/2"-20 thread 5/8" long	Energize two circuits from a common feed
50088	50088-BX		8A at 12V DC	TPTT	Off-On-Off	On	Steel Plunger	3 screw	Silver	Plated Steel	Aluminum	7/16"-28 thread 5/16" long	-
91812-02	-		5A at 12V DC	SPST	On-Mom Off	On	Chrome Plunger	1 blade & 1 wire	Silver	Plated Steel	Steel	7/16"-20 thread 7/16" long	-

Marine Grade • One, Two & Three Circuit Push-Pull Switches

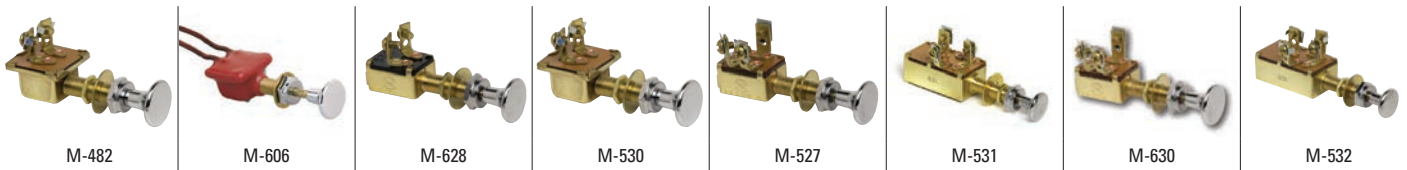

PART NUMBERS			VOLTAGE	RATING	CIRCUITRY	TYPE	NORMAL POSITION	ACTUATOR KNOB	TERMINALS	CONTACTS	HOUSING	GASKET SEALED	MOUNTING STEM	
BULK	BOXED	RETAIL											MATERIAL	SIZE
M-482	M-482-BX	M-482-BP	6-36V DC	10A at 12V DC	SPST	Off-On	Off	Chrome Brass	2 screw	-	Brass	•	Brass	3/8"-32 1 1/4" long
M-606	M-606-BX	M-606-BP	6-36V DC	10A at 12V DC	SPST	Off-On	Off	Chrome Brass (10-32 thread)	2 copper 12" wires	-	Brass - PVC Coated		Brass	3/8"-32 1 1/4" long
M-628	M-628-BX	M-628-BP	6-36V DC	10A at 12V DC	SPST	Off-On	Off	Chrome Brass (10-32 thread)	2 screw	-	Brass		Brass	3/8"-32 1 1/4" long
M-530	M-530-BX	-	6-36V DC	10A at 12V DC	SPST	On-Off	On	Chrome Brass	2 screw	-	Brass	•	Brass	3/8"-32 1 1/4" long
M-527	-	M-527-BP	6-36V DC	10A at 12V DC	SPST	On-Off	Off	Chrome Brass	3 screw	-	Brass		Brass	3/8"-32 1 1/4" long
M-531	M-531-BX	M-531-BP	6-36V DC	10A at 12V DC	SPST	On-On-Off	Off	Chrome Brass (10-32 thread)	3 screw	-	Brass		Brass	3/8"-32 1 1/4" long
M-630	M-630-BX	-	6-36V DC	10A at 12V DC	SPDT	On-On	Off	Chrome Brass	3 screw	-	Brass		Brass	3/8"-32 1 1/4" long
M-532	M-532-BX	M-532-BP	6-36V DC	10A at 12V DC	SPDT	Off-On1-On2	Off	Chrome Brass (10-32 thread)	4 screw	-	Brass		Brass	3/8"-32 1 1/4" long
M-476	M-476-BX	M-476-BP	6-36V DC	10A at 12V DC	SPDT	Off-On1-On1&2	Off	Chrome Brass	3 screw	-	Brass		Brass	3/8"-32 1 1/4" long

Push-Pull Switches

Push-Pull Headlamp Switches

- Three knob pull positions: In – Mid – Out
- In = Headlamps Off
- Mid = Parking Lights and Tail Lights On
- Out = Headlights and Tail Lights On



Additional information: littelfuse.com/PushPullSwitches



PART NUMBERS		RATING PER CIRCUIT	POSITIONS	TYPE	ACTUATOR		TERMINALS	CONTACTS	HOUSING	MOUNTING STEM	NOTES
BULK	BOXED				KNOB	IMPRINT					
7124	7124-BX	15A at 12V DC	3	In-Mid-Out	Black Plastic	Lights	4 screw	Copper	Plated Steel	7/16"-28	-
7124-06	7124-06-BX			In-Mid-Out	Black Plastic	Lights	4 screw	Bronze	Plated Steel	7/16"-28	
72100	72100-BX	20A at 12V DC		In-Mid-Out	Black Plastic	Lights	4 screw	Silver	Diecast	7/16"-28	O-Ring Seal in Stem & Gasket Sealed Terminal Insulator
7152	7152-BX	15A at 12V DC		In-Mid-Out	Ivory Plastic	Lights	4 screw	Silver	Plated Steel	3/8"-24	-
7157	7157-BX	30A at 12V DC with Breaker		In-Mid-Out	Ivory Plastic	Lights	3 screw	Silver	Plated Steel	7/16"-28	Includes 30A Circuit Breaker
7127	7127-BX	20A at 12V DC with Fuse		In-Mid-Out	Black Plastic	Lights	4 screw	Copper	Plated Steel	7/16"-28	Includes 20A Glass Fuse
71092	71092-BX	15A at 12V DC with Internal Breaker		In-Mid-Out	None	None	8 blade†	-	Plated Steel	7/16"-28	4.5 Ω with Internal 15A Circuit Breaker
71092-02	71092-02-BX	15A at 12V DC with Internal Breaker	In-Mid-Out	None	None	8 blade†	-	Plated Steel	7/16"-28	4.5 Ω with Internal 15A Circuit Breaker	
7112	7112-BX	10A at 12V DC	4	In-Mid1-Mid2-Out	Tan Plastic	Lights	5 screw	Copper	Plated Steel	3/8"-24	-

†Accepts Delphi 2977645 or 2984169

Specialized Push-Pull Switches



68028



50036



50203



9576

PART NUMBERS		VOLTAGE	POSITIONS	TYPE	ACTUATOR KNOB	TERMINALS	CONTACTS	HOUSING	MOUNTING STEM		NOTES
BULK	BOXED								MATERIAL	SIZE	
68028	68028-BX	12V DC	3	Off-Hi-Lo	Ivory Plastic (10-32 Metal Thread) Gold Imprint: Lights	2 screw	Copper	Plated Steel (1-13/16"x 1-19/32"x 1/2")	Steel	7/16"-28 thread 5/16" long	Heater switch 3Ω coil resistance
50036	50036-BX	12V DC	2	On-On (DPST)	Red Plastic 1-1/4" Ø	3 female bullet	Copper	Zinc with Rubber Boot	-	-	Two-speed axle switch to mount on gear shift lever Accepts 40102 connector
50203	-	10A at 12V 36V DC max	2	In-Off (Magneto Switch Grounded) Out-Run (Magneto Switch Open)	Integral Nickel Plated	1 screw	Copper	Plated Steel	Aluminum	3/8"-32 thread 5/8" long	Magneto Switch, Out-Run
9576	9576-BX	12V DC	2	Off-Ign/Acc-Ign/Start 10A Acc, 5A Ign, 5A Start	Black Plastic	4 screw	Copper	Plated Steel	Steel	3/8"-24 thread	Battery ignition and starter switch - spring return to Ign/Acc
9011	9011-BX	-	2	Off-Start	Chrome Plated Button	2 screw	Copper	Plated Steel	Steel	1"-22 thread 17/32" long	Engine Start / Engine Stop Button

Rotary Switches

Universal Rotary Switches

In a full range of styles and circuitries for lighting, ignition and similar applications.

- For forward-reverse operation of a motor, to give a motion such as Up/Down, Left/Right, In/Out, Rotate/Counter-rotate
- Suitable for control of tailgates, winches, windlasses, snowplows and other applications

Additional information: littelfuse.com/RotarySwitches



PART NUMBERS		RATING	CIRCUITRY	POSITIONS	SWITCH TYPE	TYPE	ACTUATOR	TERMINALS	HOUSING	MOUNTING STEM	NOTES
BULK	BOXED										
9500	9500-BX	10A at 12V DC	SPST	2	–	Off-On	Lever	2 screw	Plated Steel	½"-20	Compact Case
24054	–	10A at 12V DC	SPST	3	–	On1-Off-On2	Lever	3 screw	Plated Steel	½"-20	–
75701	75701-BX	20A at 12V DC	–	3	Reverse	On1-Off-On2	Lever	3 screw	Plated Steel	7/16"-28	–
72171-02	–	20A at 12V DC	–	3	Rotary	Off-On-On	Black Knob (Fan Icon)	6 blade	Copper	11/32"-12	Universal rotary or fan control types of products
75602-10	–	24V DC	–	4	–	–	Aptiv 2977042	6 Way Male Connector	Diecast	13/16"-24	–
90005-01	90005-01-BX	15A at 12V DC	DPDT	3	Reverse	On (Reverse); Off; On (Forward)	Lever	4 screw	Plated Steel	½"-20	Spring Return to Off
75705-01	75705-01-BX	10A at 12V DC	–	3	Momentary	Mom On1-Off-Mom On2	Key with Coded Tumbler Lock	3 screw	Plated Steel	13/16"-24	Internal O-Ring Seal; Spring Return to Off from Both Positions
90005-03	90005-03-BX	15A at 12V DC	DPDT	3	Reversing	Off (Reverse)-Off-On (Forward)	Key with Coded Tumbler Lock	4 screw	Plated Steel	13/16"-24	O-Ring Seal in Stem
75712-04	75712-04-BX	50A at 12V DC	DPDT	3	Momentary Reversing	Mom Off (Reverse)-Off-Mom On (Forward)	Lever	4 screw 3/32" thick	Plated Steel	½"-20	High Amp Silver Contacts

Rheostat Switches



Ceramic insulator with embedded coil for effective heat dissipation.

Additional information: littelfuse.com/RotarySwitches

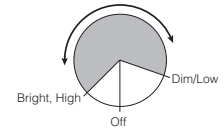

PART NUMBERS		VOLTAGE	RESISTANCE	POSITIONS	ACTUATOR		TERMINALS	HOUSING	MOUNTING STEM	DIMENSIONS
BULK	BOXED				KNOB	IMPRINT				
7493	7493-BX	12V DC	8 Ohms	3	Black Plastic Bar Knob	–	2 screw	Plated Steel	7/16"-28	1.32"Ø .88" long (33.5mm Ø 22.4mm long)
7493-07	–	12V DC	8 Ohms	3	Black Plastic Bar Knob	Panel Lamps	2 screw	Plated Steel	15/32" long	



Heater-Defroster Switches

Coil embedded in ceramic insulator for effective heat dissipation.

PART NUMBERS		VOLTAGE	RESISTANCE	POSITIONS	TYPE	ACTUATOR	TERMINALS	MOUNTING HOLE
BULK	BOXED							
68362	68362-BX	12V DC	3 Ohms	4	Off-High-Medium-Low	Black Plastic Bar Knob	2 screw	5/8" Through-Hole

Rotary Wiper Switches

Electronic Windshield Wiper Switches

Universal application. For stem- or bracket-mounting. 15/32"-32 thread mounting stem, with keyway.

- Intermittent delay feature for permanent magnet electric wiper motors
- Negative ground only
- Four positions: Off/Park - Intermittent Range - Low - High
- 7/16"-28 x .45" (11.3mm)
- Round black plastic, white imprinted knob with metal insert and set screw included unless noted otherwise
- Controls single motor unless noted otherwise
- Conforms to SAE J1455, SAE J112a, and SAE J234

Additional information: littelfuse.com/WiperSwitches



PART NUMBERS			VOLTAGE	POSITIONS	CONNECTOR	HOUSING	DIMENSIONS	DYNAMIC PARKING	PUSH-TO-WASH	NOTES	
BULK	BOXED	RETAIL									
75600	-	-	12V DC	4	Delphi 2965977 8-way female connector	Diecast	2 7/32" x 2 7/32" x 1 13/16" (56.4mm x 56.4mm x 46.0mm)	•	•	-	
75600-01	75600-01-BX	-	12V DC		Delphi 6294544 4-way male and Delphi 2977042 6-way male connectors			•†	•	Controls two motors in phase at the same speed	
75600-02	75600-02-BX	-	12V DC		Delphi 2977042 6-way male connector			•	•	-	
75600-04	75600-04-BX	-	12V DC		Color-coded leads			•	•	-	
75600-05	-	-	12V DC		Delphi 6294544 4-way male and Delphi 2977048 4-way female connectors			•	•	-	
75600-07	75600-07-BX	-	12V DC		7 pole connector			•	•	-	
75602-02	-	-	24V DC		Delphi 6294544 4-way male and Delphi 2977042 6-way male connectors			•†	•	Controls two motors in phase at the same speed	
75600-25	-	-	12V DC		6			Six Pin AMP Connector #640585-1	•	•	-
75601-14	75601-14-BX	-	12V DC		5			Delphi (Packard) 8-way male connector 2965972 (mates with 2965977).	•	•	Controls one or two motors
75603-09	-	-	24C DC		5			Nine Pin AMP 1-480707-0 Connector	•	•	-

† = with or without dynamic parking (based on motor capabilities)

Electric Windshield Wiper Switches

Universal application. For through hole and panel mounting. 15/32"-32 thread mounting stem, with keyway.

- Three positions: Off/Park - Low - High
- 7/16"-28 x .45" (11.3mm) mounting stem unless noted otherwise
- Round black plastic, white imprinted knob with metal insert and set screw included unless noted otherwise
- Controls single motor unless noted otherwise

Additional information: littelfuse.com/WiperSwitches



PART NUMBERS			VOLTAGE	POSITIONS	TERMINALS	HOUSING	MOUNTING STEM	DIMENSIONS	DYNAMIC PARKING	PUSH-TO-WASH	NOTES
BULK	BOXED	RETAIL									
68159-05	68159-05-BX	—	12V DC	3	5 blade	Plated steel	7/16"-28 x .38" (9.6mm)	1 3/8" Ø x 3/8" (34.9mm Ø x 9.5mm)			No electrical break between positions
75212-04	75212-04-BX	—	12V or 24V DC	3	4 blade	Plated steel	7/16"-28 x .38" (9.6mm)	1 3/8" Ø x 3/8" (34.9mm Ø x 9.5mm)		•	—
75217-04	—	—	12V or 24V DC	3	6 blade	Plated steel	7/16"-28 x .38" (9.6mm)	1 3/8" Ø x 3/8" (34.9mm Ø x 9.5mm)			Controls two motors
75221-06	75221-06-BX	—	12V DC	3	4 blade	Plated steel	7/16"-28 x .38" (9.6mm)	1 3/8" Ø x 3/8" (34.9mm Ø x 9.5mm)			Internal 6A circuit breaker
75221-09	75221-09-BX	—	12V DC	3	5 blade	Plated steel	7/16"-28 x .38" (9.6mm)	1 3/8" Ø x 3/8" (34.9mm Ø x 9.5mm)		•	Internal 6A circuit breaker
75226	75226-BX	—	12V or 24V DC	3	7 blade	Plated steel	7/16"-28 x .38" (9.6mm)	1 3/8" Ø x 3/8" (34.9mm Ø x 9.5mm)		•	Controls two motors
75228-03	75228-03-BX	—	12V or 24V DC	3	6 blade	Diecast	7/16"-28 x .38" (9.6mm)	1 5/8" Ø (41.3mm Ø)	•	•	—
75228-04	75228-04-BX	—	12V or 24V DC	3	5 blade	Diecast	7/16"-28 x .38" (9.6mm)	1 5/8" Ø (41.3mm Ø)	•		—
75236	75236-BX	—	12V or 24V DC	3	8 blade	Diecast	7/16"-28 x .38" (9.6mm)	1 5/8" Ø (41.3mm Ø)	•	•	Controls two motors

Wiper Switch Accessories



81298-02



81298-34

PART NUMBERS		IMPRINT	FACE DIAMETER	MATERIAL
BULK	BOXED			
81298-02	81298-02-BX	SAE wiper symbol	1 3/16" Ø	Black plastic
81298-34	81298-34-BX	SAE wiper-washer symbol	1 3/16" Ø	Black plastic

Rotary Headlamp Switches

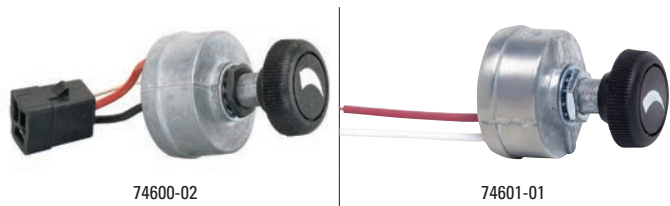

Headlamp Dimmer Switches

- For variable intensity control of lighting applications
- For use in negative ground systems
- Black plastic knob with metal insert and set screw
- Knob imprinted in white with SAE variable symbol
- Diecast case: 1 9/16" Ø (39.7mm) by .883" (22.4mm) long

Additional information: littelfuse.com/RotarySwitches

PART NUMBERS			RATING	DUTY CYCLE	CONNECTOR	CASE		MOUNTING STEM
BULK	BOXED	RETAIL				MATERIAL	DIMENSIONS	
74600-02	-	74600-02-BP	4A at 12V DC	0-100%	3 wire (Load, Battery & Ground) Delphi 2984378 connector on 3" (76.2mm) leads	Diecast	1 9/16" Ø x .883" 39.7mm Ø x 22.4mm	7/16"-28 thread .45" (11.4mm) long
74601-01	74601-01-BX	74601-01-BP	7A at 12V DC	1-99%	2 wires (Load & Battery) 1 25/32" (45.2mm) long	Diecast	1 9/16" Ø x .883" 39.7mm Ø x 22.4mm	7/16"-28 thread .45" (11.4mm) long
74603	74603-BX	-	6A at 12V DC	1-99%	2 wires 2" (50.8mm) long two AMP connectors (load 480054-3, battery 480053-3)	Diecast	1 9/16" Ø x .883" 39.7mm Ø x 22.4mm	7/16"-28 thread .45" (11.4mm) long
74601-06	-	-	7A at 14.7V DC	18% - 45% +/- 5%	TYCO Terminal #3-520106-2	Plated Steel	1 9/16" Ø x .883" 39.7mm Ø x 22.4mm	7/16"-28 thread .45" (11.4mm) long
74601-12	-	-	7A at 14.7V DC	-	2 Terminated Wire TE Connectivity 3-520106-2	Plated Steel	1 9/16" Ø x .883" 39.7mm Ø x 22.4mm	7/16"-28 thread .45" (11.4mm) long



72079-01

Rotary Headlamp Switches

Additional information: littelfuse.com/RotarySwitches



PART NUMBERS		RATING PER CIRCUIT	POSITIONS	ACTUATOR		TERMINALS	CONTACTS	HOUSING	MOUNTING STEM	NOTES
BULK	BOXED			KNOB	IMPRINT					
72079-01		20A at 12V DC	4	Black Plastic	SAE Headlight Symbol	5 screw	Silver	Plated Steel	5/8"-32 thread	O-Ring Seal in Stem

Foot Operated Switches



7785

7792

Foot Operated Turn Switches

Depress to On, spring return to Off. Two switches are needed for left and right turn signals. Plastic-coated, providing protection against moisture, dust and roadsplash.

Additional information: littelfuse.com/FootSwitches

PART NUMBERS		CIRCUITRY	TYPE	NORMAL POSITION	TERMINALS	HOUSING	MOUNTING		STEM SIZE	NOTES
BULK	BOXED						TYPE	HOLES		
7792	7792-BX	SPST	Off-On	Normally Off	2 screw	Diecast PVC Coated	Through-Floorboard	3x 1/4"-20 tapped holes 3/4" and 1-3/4" on centers	7/8" Ø	Sealed
7792-01	7792-01-BX		Depress to On, spring return to Off.	Normally Open	2 Screw	Diecast PVC Coated	Through-Floorboard	3x 1/4"-20 tapped holes 3/4" and 1-3/4" on centers	7/8" Ø	-
7792-03	-		On-Off	Normally Open	2 Wire Leads	Diecast PVC Coated	Through-Floorboard	3x 1/4"-20 tapped holes 3/4" and 1-3/4" on centers	7/8" Ø	-

Foot Operated Switches

Foot Operated Headlamp Dimmer Switches

Depress-release for low beam, depress-release for high beam. Corrosion-resistant diecast metal housings, moisture-repellent insulators.

Additional information: littelfuse.com/FootSwitches



7700



7786



7787



7762

PART NUMBERS		CIRCUITRY	TYPE	TERMINALS	CONNECTOR	HOUSING	MOUNTING		STEM SIZE
BULK	BOXED						TYPE	HOLES	
7700	7700-BX	SPDT	On-On	3x 16 AWG (5.75" long)	-	PVC Coated Diecast	Through-Floorboard	3x 1/4"-20 tapped holes 3/4" and 1-3/4" on centers	27/32" Ø
7786	7786-BX		-	3 screw	-	Diecast		3x 1/4"-20 tapped holes 3/4" and 1-3/4" on centers	1-1/16" Ø
7784	7784-BX		On-On	3 screw	-	Diecast		3x 1/4"-20 tapped holes 3/4" and 1-3/4" on centers	7/8" Ø
7785-01	-		On-Off	-	Packard Connector 12015792	PVC Coated Diecast		3x 1/4"-20 tapped holes 3/4" and 1-3/4" on centers	7/8" Ø
7786-01	-		On-On	-	Aptiv 12015793	PVC Coated Diecast		3x 1/4"-20 tapped holes 3/4" and 1-3/4" on centers	7/8" Ø
7786-03	-		-	3 wire leads	-	Diecast		3x 1/4"-20 tapped holes 3/4" and 1-3/4" on centers	-
7789-02	7789-02-BX		-	3 blade	-	Diecast		3x 1/4"-20 tapped holes 3/4" and 1-3/4" on centers	55/64"
7787	7787-BX		-	3 screw	-	Diecast	2x 1/4"-20 tapped holes 1-3/4" on centers	7/8" Ø	
7762	7762-BX		-	3 blade	30155	Diecast	On-Floorboard	2x 9/32"Ø holes 1-3/4" on centers	-



9060



9183

Foot Operated Starter Switches

Off-On, normally Off. Depress to On, spring return to Off.

Additional information: littelfuse.com/FootSwitches

PART NUMBERS		CIRCUITRY	TYPE	NORMAL POSITION	TERMINALS	MOUNTING		PLUNGER	NOTES	
BULK	BOXED					TYPE	HOLES			
9060	9060-BX	SPST	Off-On	Normally Off	2x 5/16"-24 studs with hexnuts & washers	Through-Floorboard	2x 9/32"Ø holes 1-3/4" on centers	1.83" Long	Autolite SW-40001 (15-47), 15-50, 401A, 4002, 4005, 4010, 4015 (15-51)	Delco D900 (405C)
9183	9183-BX						2x 9/32"Ø holes 1-3/4" on centers	1" Long	Autolite SW-4012 (15-49)	Delco 1996478
91001	91001-BX						2x 7/32" tapped holes 23/32" on center	21/32" long	16 thread and 32 thread terminal posts on body of switch	

Specialty Switches

Backup Switches

- See table below for replacement suitability
- Normally off, on with plunger depressed, spring return to Off

Additional information: littelfuse.com/BackupSwitches



91113



75125



9052

PART NUMBERS		RATING	POLE & THROW	ACTION	NORMAL POSITION	ACTUATOR	MOUNTING	DETAIL	TERMINALS
BULK	BOXED								
91113	91113-BX	20A at 12V DC	SPST	Off-On	Normally Off	Ball	On vehicle transmission	Spring return to Off	2 screw
75125	–	–	SPST	Off-On	Normally Off	5" lever	Two 13/64" (5.2mm) Ø mounting holes, 1/2" (12.7mm) on centers	Back-up alarm switch Spring return to Off	2 screw
9052	9052-BX	10A at 12V DC	SPST	Off-On	–	Button-Head 1/2" (12.7mm) long	7/16" (7.9mm) Ø mounting stem, 7/16" –20 (7.9mm) long, with two flats for mounting in double-D hole	Spring return to Off	2 screw
91105	91105-BX	10A at 12V DC	SPST	Off-On	Normally Off	Button-head actuator, 3/8" (9.5mm) long	3/8 (9.5mm) long. 7/16 -20 (7.9mm) diameter mounting stem	On with plunger depressed, spring return to Off	2 - 18AWG Wire Leads

Stoplamp Switches

- See table below for replacement suitability

Additional information: littelfuse.com/StoplampSwitches

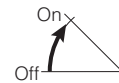

8626



8629



8645



8715



8487

PART NUMBERS		HYDRAULIC	MECHANICAL	POLE & THROW	NORMAL POSITION	DETAIL	MOUNTING	TERMINALS	NOTES
BULK	BOXED								
8486	8486-BX		•	SPST	Normally On	–	2 - Tapped 10-32 mounting holes 5/8" on centers	2 blade	Lever actuated to Off spring return to On
8486-05	8486-05-BX				Normally Off	–	2 - Tapped 10-32 mounting holes 5/8" on centers	2 bullet	Lever actuated to On spring return to Off
8626	8626-BX	•			Normally Off	–	1/8" -27 thread 11/32" (8.73mm) long	2 6-32 screw	Operates at 60-120 psi (414-827 kPa); NPTF dry-seal thread for use without sealant
8629	8629-BX	•			Normally Off	–	1/8" -27 thread 11/32" (8.73mm) long	2 male bullet	Operates at 60-120 psi (414-827 kPa); NPTF dry-seal thread for use without sealant
8715	8715-BX		•		Normally On	Moisture-resistant plastic body	1/2" Ø 1 5/32" long	2 blade	Spring return to normal position.
8487	8487-BX		•		Normally On	Lever is 2 7/8" overall length	Tapped 10-32 mounting holes 5/8" on centers	2 bullet	Spring return to normal position.

11

Neutral Safety Ball Switches

- Spring return to normal position
- Moisture-resistant insulators
- Corrosion-resistant metal housings
- Silver contacts

Additional information: littelfuse.com/NeutralSafetySwitches



PART NUMBERS		RATING	POLE & THROW	NORMAL POSITION	MOUNTING	DETAIL	TERMINALS
BULK	BOXED						
9242	9242-BX	35A at 12V DC 20A at 24V DC	SPST	Normally Off	9/16" -18 UNF-2A thread, 5/16" (7.9mm) long	–	2 screw
9242-01	9242-01-BX	35A at 12V DC 20A at 24V DC	SPST	Normally Off	9/16" -18 UNF-2A thread, 5/16" (7.9mm) long	Same as 9242 but with brass gasket/washer	2 screw
92102	92102-BX	35A at 12V DC 20A at 24V DC	SPST	Normally Off	9/16" -18 UNF-2A thread, 21/32" (16.7mm) long	Accepts female blade terminals or Delphi 2962679 2-pole connector	2 button head
92107-04	92107-04-BX	20A at 12V DC	SPST	Normally Off	3/4" -16 UNF-2A thread, 31/64" (12.3mm) long	–	2 screw
9162-03	–	35A at 12V DC	SPST	Normally Off	3/4" -16 UNF-2A thread, 31/64" (12.3mm) long	Gasket on mounting stem	2 female bullet
9224	9224-BX	5A at 12V DC 3A at 24V DC	SPST	Normally On	3/4" -16 UNF-2A thread, 31/64" (12.3mm) long	Aluminum gasket/washer	2 screw
9224-07	9224-07-BX	5A at 12V DC	SPST	Normally On	1/4"-32 thread 1/4" long	–	2 screw

Neutral Safety and Backup Lamp Switch Accessories

For Neutral Safety and Back-up Lamp Switches. Molded of durable PVC to resist moisture and dirt. Internal ring forms a seal with the groove around the switch housing.



PART NUMBERS		DETAIL	MOUNTING
BULK	BOXED		
83377	83377-BX	Protective boot for switches with 1 1/8" hex housing. Part Numbers: 9224, 9242, 9242-07, 92102, 92103, 92105, 92107-04.	Internal ring forms seal with switch housing groove



Vehicle Connectors

Heavy duty sockets, plugs and assemblies that withstand the rigors of trucking in dust, dirt, rain and snow, heat and cold, yet maintain electrical continuity between tractor unit and trailer.

Best Practices for Connectors

Properly installed tractor-trailer connectors are critical to the safe performance of a rig so connectors are routinely subjected to vibration, extreme weather conditions, as well as mechanical forces. We highly recommend that a trained technician performs the installation. It is the responsibility of the end-user to take into account the mounting location and environment, conductor type, size, flexibility and other installation parameters.

Review the assembly procedure before assembly. A common error is to not slide a clamp, boot or housing onto the cable before connecting the wires. Recommended tools: screwdriver (preferably with torque limiter); soldering iron (preferably a solder pot), solder and flux; wire stripper and cutter; and ruler. Cut the cable, and strip the jacket to the recommended length. Strip the wires to the recommended length, and tin them. Maintain a tight strand bundle before tinning, so that there are no loose strands. Re-tin if necessary. This makes it easier to insert the wires into the terminal, and helps to properly position the tinned strands at the right depth.

Slide the housing, spring coil or boot over the cable. Properly insert and position the tinned conductor into each terminal. Locate the tinned portion under the terminal screw before tightening the screw. Tighten the termination screws to the appropriate torques.

Inspect the terminated connection for cut or loose strands, fragments of wire insulation between the terminal/conductor connection, bent terminals, loose or stripped terminal screws and other visible problems.

Check that the correct connections have been made, by re-checking that the conductor jacket color matches the insulator coding.

Carefully slide the insulator into the connector housing, making sure that the insulator is fully seated. Don't twist or lever the terminated conductor after it has been inserted and locked into the insulator. This may damage the terminal and put stress on the terminated connection. Finally tighten the housing screw or cable clamp.

In order to keep a plug clean when not inserted in a socket, we recommend the use of the 11750 Stor-A-Way Plug Holder.



12300 & 12301 - 13-Pole Connectors



12300



12301

The 13-pole sockets and plugs provide six additional tractor-trailer circuits within the dimensions of traditional 7-pole connectors. The connectors are adaptable to a wide variety of wiring combinations, including multiplexed circuits. 13-Pole connectors surpass SAE J560b performance standards, by conforming to interchangeability between 7-pole and 13-pole connectors. The connectors are a bright yellow so that the 13 pole configuration is easily identifiable. They are constructed of robust glass-filled plastic housings that cannot rust or corrode. The ground terminals accept up to 8AWG wire, 7 pole terminals up to 10AWG, smaller 6 pole terminals up to 14AWG.

12300, Socket

- Gasket-sealed socket door is spring-loaded and locks onto the plug.
- Rain hood extends beyond the pins to protect the interior. The 5° downward pitch drain channel inside the socket reduces water retention.
- Three mounting holes on the flange: .33" (8.4mm) diameter, 2.93" (74.6mm) on centers.
- Includes six 31784 crimp-on connectors to mate with the six smaller pole terminals.

12301, Plug

- Plug locks into the socket, utilizing the spring-loaded socket door.
- Spring-grip contacts have self-adjusting spring bands to maintain long-term uniform electrical contact with socket pins. They also feature strain relief and grommet seals to isolate the contacts from mechanical strain and provides water protection.
- Cable retainer maintains secure cable connection.
- O-ring at the plug end prevents water from reaching the contacts.
- Includes six 31784 crimp-on connectors to mate with the six smaller pole terminals.

Additional information: littelfuse.com/VehicleConnectors

PART NUMBERS			POLES	TYPE	MATERIAL	COLOR	TERMINALS		MOUNTING HOLES	NOTES
BULK	BOXED	RETAIL					PIN TYPE	MATERIAL		
12300	12300-BX	–	13	Socket	Glass-Filled Plastic	Yellow	Solid	Brass	3	Spring Loaded Door
12301	12301-BX	–	13	Plug	Glass-Filled Plastic	Yellow	Solid	Brass	–	O-ring in plug end



81356

81356 - Protective Boot for 3-Bolt Flange Sockets

Protect against road splash, dirt and moisture. Fits over the back of the flange, and covers the terminal connectors. Designed for 12310 7-pole socket and 12300 13-pole socket.

PART NUMBERS			POLES	MATERIAL	NOTES
BULK	BOXED	RETAIL			
81356	81356-BX	–	7 & 13	Rubber	Fits Sockets: 12300 and 12310

Typical RV 7-Pole Wiring Color Codes

WIRE COLOR	FUNCTION
White	Ground
Black	Auxiliary power/battery charge
Yellow	Auxiliary
Red	Left turn and brake lights
Green	Taillights and clearance lights
Brown	Right turn and brake lights
Blue	Electric trailer brakes

SAE Coding Convention for 7-Pole Connectors

WIRE COLOR	CONDUCTOR NUMBER	LITTELFUSE TERMINAL MARKING	FUNCTION
White	1	W	Ground return to towing vehicle
Black	2	BK	Clearance, side marker, and identification lamps
Yellow	3	Y	Left turn signal and hazard lamps
Red	4	R	Stop lamps and antilock device
Green	5	G	Right turn signal and hazard lamps
Brown	6	BR	Tail and license plate lamps
Blue	7	BL	Continuous ABS power/Auxiliary

Tractor-Trailer Connectors

7-Pole Connector Sockets

Sockets and plugs conform to ATA, RCCC (RP-102), SAE (J560b), FMVSS-121, FIEI TTMA (RP 40-73) standards or recommendations, and are compatible with other standard (J560b) connectors.

Ground terminal accepts wires up to 8AWG, other terminals up to 10AWG. Solid brass contacts are aligned to assure proper contact and minimal voltage drop. Wiring codes are embossed on the insulator.

The door is spring-loaded and fits over a mating ridge on the socket face to minimize penetration of dirt and moisture. Housings are constructed from corrosion-resistant diecast metal or rugged glass-filled plastic. Contacts are either self-grounding or insulated.

Additional information: littelfuse.com/VehicleConnectors



PART NUMBERS		POLES	MOUNTING HOLES	MATERIAL	COLOR	TERMINALS		DIMENSIONS		SPRING LOADED DOOR	NOTES
BULK	BOXED					PIN TYPE	MATERIAL	MOUNTING FLANGE	THROUGH-HOLE		
12310	12310-BX	7	3	Glass-Filled Plastic	Black	Solid	Brass	0.33" (8.4mm) Ø 2.93" (74.6mm) on centers	—	•	Gasket-Sealed with Rain Hood
—	12080-BX			Glass-Filled Plastic	Black	Solid	Brass	0.488" x 0.328" (12.4x8.3mm) oval 2.93" (74.6mm) on centers	2" (50.8mm) Ø	•	Insulated
—	12080-11-BX			Glass-Filled Plastic	Green	Solid	Brass	0.488" x 0.328" (12.4x8.3mm) oval 2.93" (74.6mm) on centers	2" (50.8mm) Ø	•	Door marked "Trailer ABS"
12063	12063-BX		2	Diecast Metal	—	Solid	Brass	0.488" x 0.328" (12.4x8.3mm) oval 2.93" (74.6mm) on centers	2" (50.8mm) Ø	•	Self-Grounding
12063-11	—			Diecast Metal	Silver	Solid	Brass	0.488" x 0.328" (12.4x8.3mm) oval 2.93" (74.6mm) on centers	2" (50.8mm) Ø	•	—
12063-01	12063-01-BX			Diecast Metal	—	Split	Brass	0.488" x 0.328" (12.4x8.3mm) oval 2.93" (74.6mm) on centers	2" (50.8mm) Ø	•	Self-Grounding
12077-01 [†]	12077-01-BX			Diecast Metal	—	1x Spring Grip Female 6x Solid Male	Brass	0.488" x 0.328" (12.4x8.3mm) oval 2.93" (74.6mm) on centers	2" (50.8mm) Ø	•	For ISO-Type Polarized ground terminal - Insulated Mates with 11100-02 and 11100-01

[†] Polarized ground terminal, insulated. Replacement for ISO 3731-1976 (E) road vehicles, type 24S (supplementary).

Typical RV 7-Pole Wiring Color Codes

WIRE COLOR	FUNCTION
White	Ground
Black	Auxiliary power/battery charge
Yellow	Auxiliary
Red	Left turn and brake lights
Green	Taillights and clearance lights
Brown	Right turn and brake lights
Blue	Electric trailer brakes

SAE Coding Convention for 7-Pole Connectors

WIRE COLOR	CONDUCTOR NUMBER	LITTELFUSE TERMINAL MARKING	FUNCTION
White	1	W	Ground return to towing vehicle
Black	2	BK	Clearance, side marker, and identification lamps
Yellow	3	Y	Left turn signal and hazard lamps
Red	4	R	Stop lamps and antilock device
Green	5	G	Right turn signal and hazard lamps
Brown	6	BR	Tail and license plate lamps
Blue	7	BL	Continuous ABS power/Auxiliary

7-Pole Connector Plugs – High Performance



12311

Ground terminal accepts wires up to 8AWG, other terminals up to 10AWG. Cable protectors are constructed of plated steel, and provide strain relief and protection against abrasion.

- High-Performance Plug Surpasses SAE J560b performance standards. Superior environmental protection gives extended product life. Black glass-filled plastic housing cannot rust or corrode
- Plug locks onto opening on spring-loaded socket door. Spring-grip contacts have self-adjusting spring bands to maintain long-term uniform electrical contact with socket pins. O-ring at the plug end prevents water from reaching the contacts.
- Strain relief and grommet seal isolates the contacts from mechanical strain, and provides extra moisture protection. Cable retainer maintains secure cable connection. Replaceable interior.
- Connects with all SAE J560b sockets, and Littelfuse brand 13-pole sockets.

Additional information: littelfuse.com/VehicleConnectors

PART NUMBERS		POLES	CABLE PROTECTOR	MATERIAL	COLOR	O-RING
BULK	BOXED					
12311	12311-BX	7	–	Glass-Filled Plastic	Black	•

7-Pole Connector Plugs – Quick Release Interiors



12091/12092

Quick Release Plug Interiors can be readily removed by loosening the single set screw in the cable clamp, and then depressing on the spring clip release with a screwdriver. The interior then readily slides out. The interior slides back into the housing and locks securely into place with a high-tension metal clip. After the cable clamp is tightened, the plug is ready for use.

- Plated steel cable protectors are available to provide strain relief and protection against abrasion
- Ground terminal accepts wires up to 8AWG, other terminals up to 10AWG.

Additional information: littelfuse.com/VehicleConnectors



12081/12082

PART NUMBERS			POLES	CABLE PROTECTOR	MATERIAL	COLOR
BULK	BOXED	RETAIL				
12091	–	–	7	–	Diecast Metal	–
12092	12092-BX	–	7	•	Diecast Metal	–
12081	–	–	7	–	Glass-Filled Plastic	Black
12082	12082-BX	–	7	•	Glass-Filled Plastic	Black

7-Pole Connector Plugs – Spring Grip Electrical Contacts



1255

Spring Grip Electrical Contacts contain a self-adjusting spring band that maintains contact pressure from socket to pin. Greater contact pressure not only gives greater electrical efficiency, but also makes coupling and uncoupling uniform, and minimizes buildup of dirt. In competitive plugs, conventional contacts tend to widen after repeated use. These plugs feature individually sprung sockets to insure maximum contact year after year.

- Plated steel cable protectors are available to provide strain relief and protection against abrasion
- Ground terminal accepts wires up to 8AWG, other terminals up to 10AWG
- Diecast metal housing
- Replaceable interior
- Wiring codes are identified on the insulator
- Cable clamp holds all wires securely

Additional information: littelfuse.com/VehicleConnectors

PART NUMBERS			POLES	CABLE PROTECTOR	MATERIAL	COLOR
BULK	BOXED	RETAIL				
1222	1222-BX	–	7	–	Diecast Metal	–
1255	1255-BX	–	7	•	Diecast Metal	–

Tractor-Trailer Connectors

4 & 6 Pole Connector Sockets

Normally used with a trailer where limited functionality (taillights, brake lights) is needed. Ideal for boat trailers, or RVs towing a car on a flatbed trailer. Diecast metal housings. Screw terminals accept up to 12AWG wire. Replaceable interiors.

Brass split-pin contacts are aligned to assure proper contact and minimal voltage drop. Spring-loaded socket doors, plug locks securely into the opening. Wiring codes are identified on the insulator. Two mounting holes on the flange 17/64" (6.7mm) diameter, 2 15/16" (74.6mm) on centers. Mount through 1 3/8" (34.9mm) diameter hole.

Additional information: littelfuse.com/VehicleConnectors



1258



1235



1257/1232

PART NUMBERS			POLES	MOUNTING HOLES	MATERIAL	TERMINALS		DIMENSIONS		SPRING LOADED DOOR	PROTECTIVE HOUSING	NOTES
BULK	BOXED	RETAIL				PIN TYPE	MATERIAL	MOUNTING FLANGE	THROUGH-HOLE			
1258	1258-BX	-	6	2	Diecast Metal	Split	Brass	17/67 (6.7mm) Ø 2 15/16" (74.6mm) on centers	1 3/8" Ø (34.9mm) Ø	•		Exposed terminal screws
1235	1235-BX	-		2	Diecast Metal	Split	Brass	17/67 (6.7mm) Ø 2 15/16" (74.6mm) on centers	1 3/8" Ø (34.9mm) Ø	•	•	-
1257	1257-BX	-	4	2	Diecast Metal	Split	Brass	17/67 (6.7mm) Ø 2 15/16" (74.6mm) on centers	1 3/8" Ø (34.9mm) Ø	•		Exposed terminal screws
1232	1232-BX	-		2	Diecast Metal	Split	Brass	17/67 (6.7mm) Ø 2 15/16" (74.6mm) on centers	1 3/8" Ø (34.9mm) Ø	•	•	-

4 & 6 Pole Connector Plugs

Contacts float for best alignment and connection. Cable clamps hold all size cables firmly in place. Cable protectors (where present) are constructed from plated steel, and provide strain relief and protection against abrasion.

Additional information: littelfuse.com/VehicleConnectors



1236



1254



1233



1253

PART NUMBERS			POLES	CABLE PROTECTOR	MATERIAL	TERMINALS		CABLE CLAMPS	NOTES
BULK	BOXED	RETAIL				PIN TYPE	MATERIAL		
1236	1236-BX	-	6		Diecast Metal	Split	Brass	•	Exposed terminal screws
1254	1254-BX	-		•	Diecast Metal	Split	Brass	•	
1233	1233-BX	-	4		Diecast Metal	Split	Brass	•	
1253	1253-BX	-		•	Diecast Metal	Split	Brass	•	Exposed terminal screws



11041-06



11041-05

2-Pole Power Take-Off Connectors

Suitable replacement for connectors in tarping applications. Provides a high-integrity two-circuit path for on- and off-road vehicles and in agricultural applications. Plug latches solidly with the socket cover.

- Vertically-aligned machined brass contacts
- Diecast zinc plug and socket housings with engineering-grade plastic interior
- Terminations accept 6AWG wire
- Polarized connections

Additional information: littelfuse.com/VehicleConnectors

PART NUMBERS			POLES	CABLE PROTECTOR	MATERIAL	NOTES
BULK	BOXED	RETAIL				
11041-06	11041-06-BX	–	2	–	Diecast Metal	Gasket-sealed socket keeps out dirt and moisture when not in use
11042-05	11042-05-BX	–	2	•	Diecast Metal	Durable, flexible spring coil protects the cable



11041



11042

1-Pole Power Take-Off Connectors

Diecast metal plug and socket housings with engineering-grade plastic interior provides power to auxiliary equipment. Electrical conductors and connections are designed for maximum efficiency and long life and terminations accept up to 0AWG wire.

- 11041 - Socket: Self-grounding. Solid brass 3/8" (9.5mm) Ø male contact, with insulated tip to prevent short circuits. Rubber boot protects terminals and connections from moisture and dirt. Fits 2" (50.8mm) Ø hole. Two mounting holes on the flange 21/64" (8.6mm) Ø, 2 15/16" (74.6mm) on centers
- 11042 - Plug: With ground return terminal. Brass female contact with spring grip tension provides solid engagement with the mating socket. Cable clamp holds cable firmly in place.

Additional information: littelfuse.com/VehicleConnectors

PART NUMBERS			POLES	TYPE	MATERIAL	CONTACTS
BULK	BOXED	RETAIL				
11042	11042-BX	–	1	Plug	Diecast Metal	Brass



1282



1283-325

Farm Equipment Connectors

Two-pole breakaway unit: plug automatically releases at approximately 20lbs pull. Mate with all connectors of comparable design. Polarized. 20A maximum capacity.

- 1282 - Socket with Mounting Bracket: Plated steel housing. High impact-resistant molded insulator. Brass contacts and brass screw terminals. Stainless steel spring on the cover locks the plug in place. Integral mounting bracket with two .218" (5.6mm) diameter mounting holes, 1.25" (31.8mm) on centers.
- 1283-325, Plug: Plated brass housing. Threaded cable grip.

Additional information: littelfuse.com/VehicleConnectors

PART NUMBERS			POLES	TYPE	MATERIAL	CONTACTS	TERMINALS	POLARIZED
BULK	BOXED	RETAIL						
1282	1282-BX	–	2	Socket	Plated Steel	Brass	Brass Screw	•
1283-325	1283-325-BX	–	2	Plug	Plated Brass	Brass	Brass Screw	•

Trailer Connectors

In-Line Universal Connector

Flat profile design provides a robust 7-pole or 12-pole connection. Housings are molded thermoplastic material, resistant to ultraviolet solar radiation. Nickel-plated brass terminals with split contact pins give a positive connection. Insulators between each terminal provide protection from short circuits. Spring-loaded socket lid protects the terminals when not in use. Insulated cable clamp secures the cable, minimizing vibration and strain. Terminal covers are easily removed for access to terminals. Additional information: littelfuse.com/VehicleConnectors

- Circuit Identification:**
- | | | |
|----------------------|---|---------------|
| 1. Left turn signal | 5. Accessory | 9. Accessory |
| 2. Accessory | 6. Brake lights | 10. Ground |
| 3. Ground | 7. Rear-clearance and side marker lamps | 11. Accessory |
| 4. Right turn signal | 8. Accessory | 12. Accessory |



PART NUMBERS			POLES	TYPE	MATERIAL	TERMINALS	WIRE SIZE	NOTES
BULK	BOXED	RETAIL						
12400	12400-BX	–	7	Socket	Thermoplastic	Nickel-Plated Brass	14AWG Max	–
12401	12401-BX	–		Plug				–
12500	12500-BX	–	12	Socket	Thermoplastic	Nickel-Plated Brass	Pins 1-7: 14AWG max Pins 8-12: 8AWG max	Accepts 12- or 7-pole plug
12501	12501-BX	–		Plug				–

Plug & Socket Connectors with Rubber Caps

Polarized to assure proper mating of circuits. Molded insulator bodies. Precision-machined brass contacts. Rubber caps protect connectors. Additional information: littelfuse.com/VehicleConnectors



PART NUMBERS			POLES	TYPE	MATERIAL	CONTACTS	TERMINALS	COLOR	POLARIZED
BULK	BOXED	RETAIL							
M-121	M-121-BX	M-121-BP	2	Plug & Socket	Thermoplastic	Brass	Brass Screws	Black	•
M-115	M-115-BX	M-115-BP	4	Plug & Socket	Thermoplastic	Brass	Brass Screws	Black	•

Universal Trailer Connectors

Weatherproof connectors & wire lead assemblies. Polarized to assure proper mating of circuits. Molded bodies. Color-coded 16AWG wire, 6" long (152.4mm). Conductors are properly aligned and bonded into the insulation, to assure minimal voltage drop, and for ease in connecting. Additional information: littelfuse.com/VehicleConnectors



PART NUMBERS			POLES	POLARIZED
BULK	BOXED	RETAIL		
11134	11134-BX	11134-BP	4	•
11173	11173-BX	11173-BP	3	•
11172	11172-BX	11172-BP	2	•
11172-02	–	–	2	•
11172-03	–	–	2	•



11750

11750 - Stor-A-Way Plug Holder

Patented by Littelfuse–Cole Hersee. Designed to keep plugs clean when not in use, and extends life by protecting electrical contacts from dirt and roadsplash.

For all SAE J560b 7-pole plugs and 13-pole plugs. Spring-loaded for secure locking.

PART NUMBERS		POLES	MATERIAL	NOTES
BULK	BOXED			
11750	11750-BX	7 or 13	Heavy duty glass-filled plastic	Fits Plugs: 12311, 1222, 1255, 12091, 12092, 12081, 12082, 12301, 11042 and 11042-05.
11750-03	–	7	Heavy duty glass-filled plastic	Fits Plugs: 12311, 1222, 1255, 12091, 12092, 12081, 12082, 12301, 11042 and 11042-05.



1160

1160 - License Holder Tube

Weatherproof tube protects important papers. 5" x 1 1/8" (127.0 x 28.6mm).

PART NUMBERS			MATERIAL			MOUNTING
BULK	BOXED	RETAIL	BODY	CAP	FLANGE	
1160	–	–	Aluminum	Captive Brass	Brass	Three 3/16" (4.8mm) Ø mounting holes in flange



81192

81192 - Cable Protector

Protects against strain and kinking.

PART NUMBERS			MATERIAL	NOTES
BULK	BOXED	RETAIL		
–	81192-BX	–	Plated Steel	Fits Plugs: 11042-05, 12081, 12082, 12091, 12092



11178

11178 - Protective Boot for 7-Pole Sockets

Protect against road splash, dirt and moisture. Inner ridge locks over the heads of the terminal screws and to the edge of the casting.

PART NUMBERS			POLES	MATERIAL	NOTES
BULK	BOXED	RETAIL			
11178	11178-BX	–	7	Rubber	Fits Sockets: 12063, 12063-01, 12080, 12080-01, 12080-11, 12077-01 and other 7-pole sockets with similar design



11165



11164

Surface Mounting Socket Accessories

For attachment of 4-, 6-, and 7-pole sockets of standard design (without integral circuit breakers).

- 11165 - Mounting Bracket: Eliminates the need for cutting a hole in the trailer to accept a socket. Mounting hardware included. Center hole is 2" (50.8mm) diameter.
- 11164 - Mounting Gasket: Neoprene gasket for plastic or metal sockets.

PART NUMBERS			TYPE	MATERIAL	NOTES
BULK	BOXED	RETAIL			
11165	11165-BX	–	Bracket	Steel	Mounting hardware included
11164	11164-BX	–	Gasket	Neoprene	Fits Sockets: 12063, 12063-01, 12080, 12080-01

98647 - 13-Conductor Cable

Straight cable, available in 500' lengths. Conductor wires are color-coded for easy recognition. Durable insulation resists abrasion and will not crack or stiffen at -70°F (-57°C)

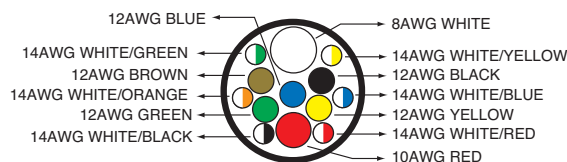

98647

PART NUMBERS		MATERIAL	13 TOTAL WIRE CONDUCTOR SIZES			
500' LENGTH			ONE WIRE	ONE WIRE	FIVE WIRES	SIX WIRES
98647		100% Copper	8AWG	10AWG	12AWG	14AWG

Indicator Devices



Indicators are used for remote monitoring or indication of system status. Pilot lights are frequently used as signal indicators for accessories or aftermarket add-ons.

What Are the Benefits of LEDs?

LED lights are solid-state, so they last longer and may never need servicing. This means that replacement builds are not needed, and time is saved in applications with maintenance personnel.

LEDs are unaffected by on-off cycling, and their brightness does not diminish over time. LEDs can also function over a wider range of temperatures making them ideal for harsh environments from desert conditions to frigid cold temperatures.

LEDs can be safer because they produce less heat. The build up of heat is undesirable because it can create potential fire risks. LEDs operate at a very cool temperature and the lens is not vulnerable to breakage from water-splash.



12V LED Pilot Lights

Rugged light-emitting diode that ensures long hours of service, never needing bulb replacement. Additional information: littelfuse.com/PilotLights

PL-521 Series • 12V LED Pilot Lights

- Approx. 1" bezel, fits 11/16" diameter hole (17.2mm).



PART NUMBERS			RATING	COLOR	TERMINALS	BEZEL SIZE	HOLE SIZE
BULK	BOXED	RETAIL					
PL-521-RC	PL-521-RC-BX	–	12V DC	Red	¼" blade	1"	11/16" Ø
PL-521-AC	PL-521-AC-BX	–	12V DC	Amber	¼" blade	1"	11/16" Ø
PL-521-GC	PL-521-GC-BX	–	12V DC	Green	¼" blade	1"	11/16" Ø

PL-522 Series • 12V LED Pilot Lights

- Approx. 3/4" bezel, fits 5/8" diameter hole (15.9mm).



PART NUMBERS			RATING	COLOR	TERMINALS	BEZEL SIZE	HOLE SIZE
BULK	BOXED	RETAIL					
PL-522-RC	PL-522-RC-BX	–	12V DC	Red	¼" blade	¾"	5/8" Ø
PL-522-AC	PL-522-AC-BX	–	12V DC	Amber	¼" blade	¾"	5/8" Ø
PL-522-GC	PL-522-GC-BX	–	12V DC	Green	¼" blade	¾"	5/8" Ø

PL-523 Series • 12V LED Pilot Lights

- Approx. 3/4" bezel, fits 5/8" diameter hole (15.9mm).



PART NUMBERS			RATING	COLOR	TERMINALS	BEZEL SIZE	HOLE SIZE
BULK	BOXED	RETAIL					
PL-523-RC	PL-523-RC-BX	–	12V DC	Red	¼" blade	¾"	5/8" Ø
PL-523-AC	PL-523-AC-BX	–	12V DC	Amber	¼" blade	¾"	5/8" Ø
PL-523-GC	PL-523-GC-BX	–	12V DC	Green	¼" blade	¾"	5/8" Ø
PL-523-BC	PL-523-BC-BX	–	12V DC	Blue	¼" blade	¾"	5/8" Ø
PL-523-CC	PL-523-CC-BX	–	12V DC	Clear	¼" blade	¾"	5/8" Ø

PL-524 Series • 12V LED Pilot Lights

- Approx. 5/8" bezel, fits 1/2" diameter hole (15.9mm), 0.5 to 5.5mm thick.



PART NUMBERS			RATING	COLOR	TERMINALS	BEZEL SIZE	HOLE SIZE
BULK	BOXED	RETAIL					
PL-524-RC	PL-524-RC-BX	–	12V DC	Red	¼" blade	5/8"	½" Ø
PL-524-AC	PL-524-AC-BX	–	12V DC	Amber	¼" blade	5/8"	½" Ø
PL-524-GC	PL-524-GC-BX	–	12V DC	Green	¼" blade	5/8"	½" Ø

PL-525 & PL-526 Series • 12V LED Pilot Lights

- Approx. 3/8" bezel, snaps into 21/64" diameter hole (8.3mm), 0.5 to 2.0mm thick. 6-3/4" wire leads.
- PL-525 series is maintained illuminations; PL-526 series in blinking illumination.



PART NUMBERS			RATING	COLOR	TERMINALS	BEZEL SIZE	HOLE SIZE	BLINKING ILLUMINATION
BULK	BOXED	RETAIL						
PL-525-RC	–	–	12V DC	Red	6 ¾" wire leads	3/8"	21/64" Ø	
PL-525-AC	–	–	12V DC	Amber	6 ¾" wire leads	3/8"	21/64" Ø	
PL-525-GC	–	–	12V DC	Green	6 ¾" wire leads	3/8"	21/64" Ø	
PL-526-RC	–	–	12V DC	Red	6 ¾" wire leads	3/8"	21/64" Ø	•
PL-526-AC	–	–	12V DC	Amber	6 ¾" wire leads	3/8"	21/64" Ø	•
PL-526-GC	–	–	12V DC	Green	6 ¾" wire leads	3/8"	21/64" Ø	•

PL-612 & PL-624 Series • 12V & 24V LED Pilot Lights

- 0.63" bezel diameter, fits panels 5.1 to 7.6mm thick. 1.25" (31.7mm) body length.



PART NUMBERS			RATING	COLOR	TERMINALS	BEZEL SIZE	BODY LENGTH
BULK	BOXED	RETAIL					
PL-612-R	PL-612-R-BX	PL-612-R-BP	12V DC	Red	¼" blade	0.63"	1.25"
PL-612-A	PL-612-A-BX	PL-612-A-BP	12V DC	Amber	¼" blade	0.63"	1.25"
PL-612-G	PL-612-G-BX	PL-612-G-BP	12V DC	Green	¼" blade	0.63"	1.25"
PL-612-B	PL-612-B-BX	PL-612-B-BP	12V DC	Blue	¼" blade	0.63"	1.25"
PL-624-R	PL-624-R-BX	–	24V DC	Red	¼" blade	0.63"	1.25"
PL-624-A	PL-624-A-BX	–	24V DC	Amber	¼" blade	0.63"	1.25"
PL-624-G	PL-624-G-BX	–	24V DC	Green	¼" blade	0.63"	1.25"
PL-624-B	PL-624-B-BX	–	24V DC	Blue	¼" blade	0.63"	1.25"

Incandescent Pilot Lights

12V Incandescent Pilot Lights

Corrosion-resistant construction. Spring-actuated brass contacts assure proper contact with the bulb. 16AWG (1.0mm²) insulated stranded copper leads, 8" (203mm) long. Additional information: littelfuse.com/PilotLights

PL-2 Series • 12V Single Contact, Insulated Pilot Lights

- #53 bulb supplied, Plated brass bezel, satin finish.
- 5/16" (7.9mm) diameter mounting stem, 3/8" (9.5mm) long.



PART NUMBERS			RATING	LENS COLOR	TERMINALS	BEZEL SIZE	LENS SIZE
BULK	BOXED	RETAIL					
–	PL-2-RC000-BX	–	12V DC	Red	2x 8" wire leads	½" (12.7mm) Ø	3/16" (4.76mm) Ø
PL-2-GC000	PL-2-GC000-BX	–	12V DC	Green	2x 8" wire leads	½" (12.7mm) Ø	3/16" (4.76mm) Ø
PL-2-BC000	–	–	12V DC	Blue	2x 8" wire leads	½" (12.7mm) Ø	3/16" (4.76mm) Ø

PL-20 Series • 12V Single Contact, Insulated Pilot Lights

- #53 bulb supplied, Chrome-plated brass bezel.
- 3/4" (19.1mm) diameter mounting stem, 11/16" (17.5mm) long.



PART NUMBERS			RATING	LENS COLOR	TERMINALS	BEZEL SIZE	LENS SIZE
BULK	BOXED	RETAIL					
PL-20-RC000	PL-20-RC000-BX	–	12V DC	Red	2x 8" wire leads	7/8" (22.2mm) Ø	17/32" (13.5mm) Ø
PL-20-GC000	PL-20-GC000-BX	–	12V DC	Green	2x 8" wire leads	7/8" (22.2mm) Ø	17/32" (13.5mm) Ø
PL-20-AC000	PL-20-AC000-BX	–	12V DC	Amber	2x 8" wire leads	7/8" (22.2mm) Ø	17/32" (13.5mm) Ø

PL-36 Series • 12V Single Contact, Insulated with Faceted Lens Pilot Lights

- Lenses have honeycomb pattern on the internal side, smooth on the outside.
- #53 bulb supplied, Satin finish stainless steel bezel.
- 1/2" (12.7mm) diameter mounting stem, 3/8" (9.5mm) long.



PART NUMBERS			RATING	COLOR	TERMINALS	BEZEL SIZE	LENS SIZE
BULK	BOXED	RETAIL					
PL-36-RC000	PL-36-RC000-BX	–	12V DC	Red	2x 8" wire leads	¾" (19.1mm) Ø	5/16" (8.0mm) Ø
PL-36-GC000	PL-36-GC000-BX	–	12V DC	Green	2x 8" wire leads	¾" (19.1mm) Ø	5/16" (8.0mm) Ø
–	PL-36-AC000-BX	–	12V DC	Amber	2x 8" wire leads	¾" (19.1mm) Ø	5/16" (8.0mm) Ø

PL-85 Series • 12V Single Contact with Faceted Lens

- #67 bulb supplied, Plated brass bezel.
- 7/8" (22.2mm) diameter mounting stem, ¾" (19.1mm) long.
- Faceted outer lens surface.
- Gasket sealed.



PART NUMBERS			RATING	LENS COLOR	TERMINALS	BEZEL SIZE	LENS SIZE
BULK	BOXED	RETAIL					
PL-85-RC000	PL-85-RC000-BX	–	12V DC	Red	1x 8" wire leads	1¼" (31.8mm) Ø	15/16" (23.8mm) Ø
PL-85-GC000	PL-85-GC000-BX	–	12V DC	Green	1x 8" wire leads	1¼" (31.8mm) Ø	15/16" (23.8mm) Ø
PL-85-AC000	PL-85-AC000-BX	–	12V DC	Amber	1x 8" wire leads	1¼" (31.8mm) Ø	15/16" (23.8mm) Ø

PL-86 Series • 12V Double Contact, Insulated

- #68 bulb supplied, Plated brass bezel.
- 7/8" (22.2mm) diameter mounting stem, ¾" (19.1mm) long.
- Gasket sealed.



PART NUMBERS			RATING	LENS COLOR	TERMINALS	BEZEL SIZE	LENS SIZE
BULK	BOXED	RETAIL					
PL-86-RC000	PL-86-RC000-BX	–	12V DC	Red	2x 8" wire leads	1¼" (31.8mm) Ø	15/16" (23.8mm) Ø
PL-86-GC000	PL-86-GC000-BX	–	12V DC	Green	2x 8" wire leads	1¼" (31.8mm) Ø	15/16" (23.8mm) Ø
PL-86-AC000	PL-86-AC000-BX	–	12V DC	Amber	2x 8" wire leads	1¼" (31.8mm) Ø	15/16" (23.8mm) Ø

Incandescent Pilot Lights



PL-116 Series • 12V Single Contact, Insulated Pilot Light

- #1893 bulb supplied, Aluminum bezel
- Plastic socket

PART NUMBERS			RATING	LENS COLOR	TERMINALS	BEZEL SIZE	LENS SIZE
BULK	BOXED	RETAIL					
–	PL-116-RC000-BX	–	12V DC	Red	None	15/16" (23.8mm) Ø	5/8" (15.9mm) Ø



PL-118 Series • 12V Single Contact, Insulated Pilot Lights

- Mounts through rear of the panel. #1893 bulb supplied. Satin finish or black aluminum bezel.
- 11/16" (7.5mm) diameter mounting stem, 1/4" (6.4mm) long.

PART NUMBERS			RATING	LENS COLOR	BEZEL COLOR	TERMINALS	BEZEL SIZE	LENS SIZE
BULK	BOXED	RETAIL						
PL-118-RC000	PL-118-RC000-BX	–	12V DC	Red	Satin Silver	2x 8" wire leads	15/16" (23.8mm) Ø	5/8" (15.9mm) Ø
PL-118-RC001	PL-118-RC001-BX	–	12V DC	Red	Black	2x 8" wire leads	15/16" (23.8mm) Ø	5/8" (15.9mm) Ø
PL-118-GC001	PL-118-GC001-BX	–	12V DC	Green	Black	2x 8" wire leads	15/16" (23.8mm) Ø	5/8" (15.9mm) Ø
PL-118-AC001	–	–	12V DC	Amber	Black	2x 8" wire leads	15/16" (23.8mm) Ø	5/8" (15.9mm) Ø



M-320 Series • 12V Single Contact, Insulated with Smooth Lens

- #53 bulb supplied, Chrome-plated brass bezel
- Plastic socket
- 3/4" (19.1mm) diameter mounting stem, 1 1/16" (27.0mm) long.

PART NUMBERS			RATING	LENS COLOR	TERMINALS	BEZEL SIZE	LENS SIZE
BULK	BOXED	RETAIL					
–	M-320-RC000-BX	–	12V DC	Red	2x 8" wire leads	7/8" (22.2mm) Ø	17/32" (13.5mm) Ø

Panel Lamps and Base Sockets

12V Bayonet Base Sockets

- Accept incandescent or LED bulbs with corresponding bases.
- Suggested lamp numbers for BA15s sockets: 63, 67, 81, 87, 93, 97,103, 209,1073, 1129, 1133, 1141, 1156.
- 16AWG insulated stranded copper leads 8" (203mm) long



26145



26100



2609



3575



2611

PART NUMBERS			RATING	LAMPS ACCEPTED	MOUNTING	TERMINALS	CONTACT TYPE	NOTES
BULK	BOXED	RETAIL						
–	–	26100-BP	12V DC	BA15d	Without Flange	2x Wire	Double	11/16" outside diameter Molded plastic insulator
2609	2609-BX	–			Side bracket with 3/16" (4.8mm) Ø hole	1x Wire	Single	–
M-432	M-432-BX	M-432-BP			Standard Base	2 Screw	Double	Marine Socket
M-458	M-458-BX	–			Standard Base	2 Wire	Double	Marine Dash Assembly



DL Series • 12V Single Contact, Grounding Panel Lamps

- Self-grounding to metal panels
- For illumination of maps or other items, with minimal interference of driving visibility
- Hood can be rotated to direct the light beam
- 11/16" (17.5mm) diameter mounting stem, 3/8" (9.5mm) long; mount through the panel.
- 16AWG insulated stranded copper leads



PART NUMBERS			RATING	COLOR	MATERIAL	TERMINALS
BULK	BOXED	RETAIL				
DL-13	DL-13-BX	–	12V DC	Chrome-plated	Brass	1x 8" wire leads
DL-21	DL-21-BX	–	12V DC	Black	Steel	1x 8" wire leads

Buzzers and Alarms



4099 • 12 & 24V DC Universal Buzzer

Hundreds of uses; for 'door ajar' warning, bus driver alert, low air pressure, temperature, etc. Works with any temperature, pressure, door or momentary switch. Electrical contacts are designed for instant response and uninterrupted signal.

- Impact resistant ABS resin case
- Moisture repellent insulator

Additional information: littelfuse.com/Alarms

PART NUMBERS			VOLTAGE	DIMENSIONS	TERMINALS
BULK	BOXED	RETAIL			
4099	4099-BX	4099-BP	12V DC	1 7/8" x 2 1/2" x 2 17/32" (30.9 x 63.2 x 64.3mm)	2 Screw
40151	40151-BX	—	24V DC		

40100 • Buzzer Pull Switch



For use by passengers in buses and rapid transit vehicles, the end of the switch attaches to a cord. Use with Littelfuse buzzers or buzzer/flashers: 4099, 4112 RC, 4124-RD.

SPST Off-Mom. On. Normally Off, pull to On, spring return to Off. Neutral gray enamel finish cover. Operates with a pull cord.

Additional information: littelfuse.com/Alarms

PART NUMBERS			VOLTAGE	TERMINALS
BULK	BOXED	RETAIL		
40100	40100-BX	—	Up to 36V DC	2 Screw



4112-RC • 12 & 24V DC Buzzer and LED Indicator "Dual Alarm"

Rugged combination warning light and buzzer gives audible and visible alert. Device is a universal application and can be used with any electrical switch. Red lens, long-life LED. 11/16" (17.46mm) diameter mounting stem, 17/32" (13.88mm) long.

Additional information: littelfuse.com/Alarms

PART NUMBERS			VOLTAGE	DIMENSIONS	TERMINALS
BULK	BOXED	RETAIL			
4112-RC000	4112-RC000-BX	4112-RC-BP	12V DC	1 7/8" x 1" x 1 11/32" (47.6 x 25.4 x 34.1mm)	2 Screw

40212 • 12V DC Dual Rate Electronic Alarm

Utilizes advanced integrated circuit surface mount technology. Negative ground. Use with two input sources to warn of two different hazardous conditions. Sounds at two different rates: one sensor triggers a fast-rate alarm, the second actuates a slower rate alarm tone.

- Minimum sound level: 90dB
- Lightweight molded plastic housing
- Solid-state circuitry
- Plugs into Littelfuse connector 3032 or 3029, Delphi (Packard) 12033871, or accepts connectors for 1/4" (6.4mm) blades

Additional information: littelfuse.com/Alarms



PART NUMBERS			VOLTAGE	DIMENSIONS	TERMINALS	NOTES
BULK	BOXED	RETAIL				
40212	40212-BX	—	12V DC	2.005" x 1.185" x .930" (50.4 x 30.3 x 23.66mm)	1/4" Blades	Minimum sound level: 90dB



Why Are LED Lights Better For My Vehicle?

THEY ARE SOLID-STATE, SO THEY LAST LONGER, AND MAY NEVER NEED REPLACING

You don't need to purchase replacement bulbs and keep a stock of them. You won't need to use the valuable time of your maintenance staff. Less downtime for your vehicles means more revenue-producing hours per vehicle. LEDs are unaffected by the on-off cycling. Their brightness doesn't diminish over time. LEDs can function over a wider range of temperatures, from desert conditions to frigid weather.

LEDs LAST LONGER BECAUSE THEY ARE UNAFFECTED BY VIBRATION

Incandescent bulbs contain a small filament which is vulnerable to the shock experienced by vehicles as they travel. LEDs are solid state and don't have filaments or bulbs that can work loose.

LEDs PRODUCE LESS HEAT

LEDs are safer. A buildup of heat is undesirable since the potential exists to cause fires. LEDs run far cooler. The heated glass of conventional bulbs is vulnerable to splash – and more likely to fail prematurely.

LEDs ARE MORE EFFICIENT

Less battery drain. Up to 90% of the power used in an incandescent bulb is converted into wasted heat energy. For the amount of light emitted, LEDs draw fewer watts from your batteries. LEDs are not susceptible to the corrosion that may occur in bulb bases and sockets.



PL-85 Series



PL-118 Series



M-320 Series



PL-2 Series



PL-612 Series

Alphanumeric Part Number Index

Use index as a quick resource to find the page number of a specific part you are looking for.

Cole Hersee Packaging

Retail packaging products are designated by the BP and BX suffixes.



BX and **BP** suffixes are not individually listed, but represented by their bulk part number.

Example:

Retail packaging toggle switch 5558-BP will be listed as 5558

5558-BP

"Bulk Part Number" "Blister Pack"

Littelfuse Packaging

Order numbers must have between 9 characters and 15 characters.



NOTE:

Products with the amperage used in their part number are not individually listed.

Example:

10 Amp ATO Fuse, 0ATO010.VP = 0ATO0xx.VP

0ATO 010.VP

First set of four
"ATO Fuses"

Second set of four
"10 Amps"

"Retail pack
of 5"

0MIN 030.ZXPRO

First set of four
"MINI Fuses"

Second set of four
"30 Amps"

"Plus Pack"

Inner Pack Codes - Quantity Code

1 = X	50 = L	500 = U	3,000 = W
5 = V	100 = H	1,000 = M	4,000 = Y
10 = T	200 = F	1,500 = D	5,000 = N
20 = S	250 = G	2,500 = E	10,000 = K

Part Number	Page	Part Number	Page	Part Number	Page	Part Number	Page	Part Number	Page
00940133ZP	21	00940402ZP	20	00940550Z	21	00940570ZXA	23	02981001ZXT	32
00940134ZP	21	00940408ZP	21	00940551Z	23	00970019X	37	02981028HXFC	32
00940135ZP	21	00940409Z	23	00940552Z	23	00970019XP	37	02981028HXFC-SS	32
00940154ZP	21	00940413ZP	20	00940553Z	23	00970023XP	37	0327xxx.LXS	15
00940189ZP	21	00940418ZP	22	00940554Z	21	00970025XPA	37	0337xxx.LXS	15
00940202ZP	21	00940419ZP	22	00940555ZPGLO	21	00970026XP	37	03453LF2XP	35
00940202ZPGLO	21	00940422Z	23	00940556ZPGLO	21	00970038XPA	37	03500417TXN	39
00940301ZP	21	00940441ZP	22	00940557ZXA	21	00970053XP	37	03500417XP	39
00940362ZP	21	00940442ZP	22	00940558ZPA	21	00970054XPA	37	03500418TXN	39
00940362ZPGLO	21	00940461ZP	22	00940559ZPA	21	01520003TXN941	33	03500418XP	39
00940363ZP	22	00940462Z	21	00940560ZXA	23	01520003TXN942	33	03540801ZXGY	39
00940365ZP	22	00940462ZGLO	21	00940561ZPA	22	01520005Z	33	03540802ZXGY	39
00940366ZP	22	00940475Z	21	00940562ZPA	22	01520006Z	33	03540804ZXGY	39
00940367ZP	22	00940477Z	10	00940563ZPA	22	01550300Z	34	03560001Z	39
00940368ZP	22	00940478Z	10	00940565ZPA	22	0185xxx.X	30	03560002Z	39
00940369ZP	22	00940479ZP	22	00940565ZXA	23	0185xxx.XP	30	03560004Z	39
00940370ZP	22	00940480Z	23	00940566ZPA	22	0211xxx.XP	30	03560006Z	39
00940396Z	24	00940506ZP	21	00940566ZXA	21	02980900S	32	04980900S	33
00940400Z	21	00940509ZXGLOA	24	00940567ZPA	22	02980900TXN	32	04980900ZXT	33
00940400ZGLO	21	00940510ZXGLOA	24	00940569ZPA	22	02980900Z	32	04980903ZXT	33

Alphanumeric Part Number Index

Part Number	Page	Part Number	Page	Part Number	Page	Part Number	Page	Part Number	Page
04980904ZXT	33	0AGWxxx.V	19	0MAB0001XP	33	1257	115	5592	89
04980921GXM5	33	0AGWxxx.VP	19	0MAXxxx.X	14	1258	115	7112	103
04980932.X	46	0AGX0002ZP	21	0MAXxxx.XP	14	1282	116	7124	103
04980932ZXT	46	0AGXxxx.VP	19	0MAXxxx.XPGLO	14	1283-325	116	7124-06	103
04980933.X	46	0ATD0300ZBP	37	0MCBxxx.X	28	2484	66	7127	103
04980933ZXT	46	0ATOxxx.V	14	0MEGxxx.L	17	2484-02	66	7152	103
04981038HXFC	32	0ATOxxx.VP	14	0MEGxxx.X	17	2484-03	66	7157	103
04982001ZXFC	32	0ATOxxx.VPGLO	14	0MEGxxx.XP	17	2484-06	66	7493	104
0498900.TXN	33	0ATOxxx.ZXPRO	14	0MIDxxx.X	17	2484-09	66	7493-07	104
0498xxx.TXN	17	0BPF0001ZP	36	0MIDxxx.XP	17	2484-16	66	7700	108
0695xxx.LPXP	16	0CCBxxx.X	27	0MINxxx.V	13	2484-19	66	7762	108
0695xxx.LPXPS	16	0CCBxxx.XP	27	0MINxxx.VP	13	2484-A	66	7784	108
0695xxx.U	16	0CNLxxx.V	20	0MINxxx.VPGLO	13	2609	122	7785-01	108
0695xxx.US	16	0CNNxxx.V	20	0MINxxx.ZXPRO	13	3031-0	35	7786	108
07981002ZXS	45	0CNNxxxE.V	20	0MMBxxx.X	27	3031-20	35	7786-01	108
08010100	64	0FCBxxx.X	27	0MNBxxx.X	27	3031-30	35	7786-03	108
08010200	64	0FCBxxx.XP	27	0MRS0001Z	26	3088-50	29	7787	108
08070900	54	0FHA0001SXJ	34	0MRS0002Z	26	3088-60	29	7789-02	108
08080200	63	0FHA0001XP	34	0MRS0003Z	26	3088-80	29	7792	107
08081400	63	0FHA0001XPGLO	34	0MRS0004Z	26	407-01	99	7792-01	107
08084300	65	0FHA0002SXJ	34	0MRS0005Z	26	407-02	99	7792-03	107
08084400	65	0FHA0002XP	34	0MRS0006Z	26	407-03	99	876-199	38
08098700	63	0FHA0030XP	34	0MRS0007Z	26	4099	123	882-267-002	32
08098780	63	0FHA0200Z	36	0MRS0007ZXA	26	4112-RC000	123	882-267-003	32
08098800	64	0FHA0200ZP	36	0MRS0009ZXA	26	4721-P10	40	882-267-004	32
08098881	64	0FHJ1001G	35	0MRS0200Z	26	4721-P12	40	882-267-005	32
08098882	64	0FHJ1002G	35	0MRS0300Z	26	4721-P14	40	882-839-2	32
08098900	65	0FHJ2001G	35	0MXBxxx.X	28	4721-P2	40	882-839-3	32
08098980	65	0FHJ2002G	35	0OMN0xxxXP	39	4721-P3	40	882-839-4	32
08098981	65	0FHM0001SXJ	34	0PALxxx.X	18	4721-P4	40	882-839-5	32
08099080	63	0FHM0001XP	34	0PALxxx.XP	18	4721-P5	40	882-853	38
0812xxx.ZXST	29	0FHM0001XPGLO	34	0RBOX001Z	25	4721-P6	40	882-854	38
0813xxx.XP	29	0FHM0002SXJ	34	0RBOX002Z	25	4721-P8	40	8250	92
0813xxx.ZXST	29	0FHM0002XP	34	0RBOX003Z	25	4755	40	8367	77
0ACBxxx.XP	27	0FHM0200Z	36	0RBOX004Z	25	4758	40	8486	109
0AFH0001XP	34	0FHM0200ZP	36	0RBOX005Z	25	5007	102	8486-05	109
0AFH0001Z	34	0FHP0001Z	35	0RBOX006Z	25	5011	102	8487	109
0AFH0002XP	34	0FHZ0001Z	47	0RED0BOXZ	25	5050	102	8626	109
0AGA0001ZP	21	0FHZ0002Z	47	0RED0BOXZXNG	25	5507	90	8629	109
0AGA0002ZP	21	0FHZ0003Z	47	0RED0BOXZXNGA	25	5520	89	8715	109
0AGA0003ZP	21	0FHZ0005Z	47	0SFE0001ZP	21	5543	92	901-325	38
0AGAxxx.V	19	0FHZ00853-BX	38	0SFE0001ZPGLO	21	5543-09	92	956-3122	73
0AGAxxx.VP	19	0FHZ00854-BX	38	0SFExxx.V	19	5543-15	92	956-3124	73
0AGC0001ZP	21	0FHZ0201Z	38	0SFExxx.VP	19	5558	90	956-3125	73
0AGC0001ZPGLO	21	0FHZ0202Z	38	0UCBxxx.X	28	5568	90	956-3126	73
0AGC0002ZP	21	0FHZ0211Z	38	0UCBxxx.XP	28	5570	90	956-3127	73
0AGC0003ZP	21	0FHZ0212Z	38	1160	118	5582	89	956-3135	73
0AGC0004ZP	21	0FLC014.XP	20	1222	114	5582-10	89	956-4100	73
0AGC0005ZP	21	0FLW014.XP	20	1232	115	5582-30-BP	89	956-4107	73
0AGCxxx.VP	19	0FLW016.XP	20	1233	115	5582-36	89	956-4111-BX	73
0AGCxxxV	19	0FNY0xxxXP	35	1235	115	5584	89	956-4113	73
0AGUxxx.T	19	0GBCxxx.V	19	1236	115	5584-15	89	956-4124	73
0AGUxxx.VPG	19	0GBCxxx.VP	19	1253	115	5586	89	956-4138	73
0AGW0001ZP	21	0MAB0001F	33	1254	115	5588	89	956-4141	73
0AGW0002ZP	21	0MAB0001S	33	1255	114	5590	89	956-4154	73

Alphanumeric Part Number Index

Part Number	Page	Part Number	Page	Part Number	Page	Part Number	Page	Part Number	Page
956-4307	73	9513	74	24214	55	55023	89	92102	110
956-4311	73	9576	103	24401	57	55025	88	92116	97
956-5109	73	9577	74	24402	57	55036	89	95033	75
956-5124	73	9578	74	24450	58	55046	89	95060	72
956-5307	73	9579	74	24452	58	55054	89	95410	77
956-6307	73	9579-02	74	24505	70	55055	89	95535	74
956-6310	73	9622-01	75	24612	57	55064	92	95539	74
956-9100	73	11042	116	24812	57	55071	92	95582	74
9001	99	11134	117	24848	57	55088	89	95591	75
9002-BX	99	11164	118	31101	77	55093	92	95593	74
9003	100	11165	118	40100	123	58336	80	95597	75
9011	103	11172	117	40151	123	58337	80	95610	75
9023	97	11173	117	40212	123	59071	92	95612	75
9044-BX	97	11178	118	48051	50	68028	103	96101	97
9050-01	99	11750	118	48070	50	68362	104	98628	84
9052	109	12063	113	48090	50	71092	103	98647	118
9055	100	12081	114	48120	50	72100	103	99025	60
9055-08	100	12082	114	48122	50	74603	107	99026	60
9060	108	12091	114	48160	50	75125	109	551802	90
9075	98	12092	114	48161	50	75226	106	551840	90
9087-BX	99	12300	112	48162	50	75236	106	551841	90
9095	96	12301	112	48525	50	75600	105	551842	90
9100	96	12310	113	48530	50	75701	104	551844	90
9109	97	12311	114	48540	51	75903	67	551849	90
9115	97	12400	117	48610	51	75904	67	880014	32
9118	100	12401	117	48710	51	75907	67	880015	32
9118-04	100	12500	117	48785	54	75908	66	880062	62
9162-03	110	12501	117	50001	102	75912	67	880064	62
9165	97	12804	51	50002	102	75920	62	880073	46
9180	100	12805	51	50036	103	81255	92	880076	45
9183	108	24008	56	50046	102	81264	92	880086	54
9187	98	24021	56	50066	102	81356	112	880088	54
9187-02	98	24022	56	50070	102	82065	70	880089	46
9211	97	24023	56	50082	102	82468	92	880094	46
9212	97	24024	66	50088	102	83274	77	880107	54
9216	96	24037	56	50203	103	83280	99	880154	62
9216-03	96	24044	56	54003	84	83353	70	880175	62
9216-10	96	24047	56	54007	84	83357	77	11041-06	116
9224	110	24054	104	54010	84	83377	110	11042-05	116
9224-07	110	24059	55	54012	84	83379	77	11172-02	117
9231	96	24060	56	54100	88	90002	97	11172-03	117
9238	97	24063	55	54103	88	90018	96	11750-03	118
9238-07	96	24071	56	54104	88	90030	96	12063-01	113
9242	110	24076	56	54109	88	90043	97	12063-11	113
9242-01	110	24080	55	54110	88	90047	98	12077-01	113
9245	96	24082	55	55013	90	90048	98	12077-01-BX	113
9264	100	24097	55	55014	89	91001	108	12080-11-BX	113
9264-02	100	24103	56	55015	89	91050	99	12080-BX	113
9264-04	100	24106	55	55016	89	91105	109	24008-03	56
9269	99	24115	55	55017	89	91113	109	24041-BX	56
9270	99	24117	55	55018	89	91126	97	24046-BX	56
9270-01	100	24124	55	55019	89	91800	99	24059-08	55
9276-09	96	24200	58	55020	89	91801	100	24059-15	55
9500	104	24213	55	55021	89	91812	100	24063-08	55

Alphanumeric Part Number Index

Part Number	Page	Part Number	Page	Part Number	Page	Part Number	Page	Part Number	Page
24106-07	55	30138-40	29	55020-04	89	58311-13	80	59024-200	91
24107-BX	55	30171-10	29	55020-20-BP	89	58311-18	80	59024-218	91
24117-01	55	30171-15	29	55021-04	89	58312-A4	80	59024-33	91
24213-01	55	30171-20	29	55021-07	89	58312-AG	80	59024-35	91
24213-03	55	30171-30	29	55025-01	88	58312-C4	80	59024-36	91
24401-01	57	30172-10	29	55025-02	88	58312-G4	80	59024-38	91
24401-04	57	30172-15	29	55025-03	88	58312-R2	80	68159-05	106
24420-BX	55	30172-20	29	55025-04	88	58312-R4	80	71092-02	103
24450-02	58	30172-30	29	55033-01	89	58326-01-BX	83	72079-01	107
24505-01	70	30409-10	30	55033-02	89	58326-06	83	72171-02	104
24512-10	57	30409-15	30	55046-04	89	58326-11	83	74600-02	107
24610-G10-BX	57	30409-20	30	55049-01	89	58326-15	83	74601-01	107
24612-03	57	30409-25	30	55054-04	89	58326-27	83	74601-06	107
24612-10	57	30409-30	30	55065-02	89	58326-29	83	74601-12	107
24624-10	57	30410-10-BX	27	55065-03	89	58327-01	82	75212-04	106
24812-01	57	30410-15	27	551001-BX	90	58327-06	82	75217-04	106
24824-01	57	30410-20	27	551800-BX	90	58328-01	81	75221-06	106
26100-BP	122	30410-25	27	551846-BX	90	58328-02	81	75221-09	106
30055-10	29	30410-30	27	56000-01	85	58328-04	81	75228-03	106
30055-15	29	30419-10	27	56000-04	85	58328-100-BP	81	75228-04	106
30055-20	29	30419-15	27	56000-08	85	58328-101-BP	81	75600-01	105
30055-25	29	30419-20	27	56027-01	82	58328-103-BP	81	75600-02	105
30055-30	29	30419-25	27	56300-01	85	58328-11	81	75600-04	105
30055-40	29	30507-60	29	56327-01	82	58328-12-BX	81	75600-05	105
30055-50	29	30507-80	29	57000-01	85	58328-13	81	75600-07	105
30056-10	29	3298xxx.H	17	57000-04	85	58328-35	81	75600-25	105
30056-15	29	3298xxx.Z	17	57000-10	85	58328-55	81	75601-14	105
30056-20	29	3298xxx.ZXSTA	17	57000-23	85	58328-58	81	75602-02	105
30056-25	29	46206-04	41	57003-01	85	58328-62	81	75602-10	104
30056-30	29	46210-02	70	57004-10	85	58332-04-BP	81	75603-09	105
30056-40	29	46210-03	70	57006-01	85	58332-20-BP	81	75705-01	104
30056-50	29	46211-01	70	57006-07	85	58332-21-BP	81	75712-04	104
30062-20-BX	29	46211-R	70	57007-11	85	58332-22-BP	81	75904-01	67
30062-30	29	46377-10	38	57013-08	85	58332-23-BP	81	75904-02	67
30063-10	29	46377-12	38	57014-03	85	58332-25-BP	81	75904-03	67
30063-20	29	46377-18	38	57300-01	85	58332-26-BP	81	75920-05	62
30063-30	29	46377-6	38	57300-02	85	58332-27-BP	81	75920-10	62
30090-2	28	46377-8	38	57300-03	85	58332-28-BP	81	75921-10	62
30090-3	28	46379-6	38	57300-11	85	58332-29-BP	81	80101-B	70
30090-4	28	46379-8	38	57300-22	85	58332-30-BP	81	81192-BX	118
30090-6	28	48540-01-BX	51	58027-01	82	58332-31-BP	81	81264-01	92
30090-8	28	48541-01-BX	51	58027-02	82	58332-32-BP	81	81264-02	92
30128-10	29	48636-01-BX	51	58027-03	82	58332-33-BP	81	81264-05	92
30128-15	29	50046-09	102	58027-04	82	58332-34-BP	81	81264-07	92
30128-20	29	54100-01	88	58027-06	82	59024-100	91	81298-02	106
30128-30	29	54101-01	88	58027-07	82	59024-104	91	81298-34	106
30128-40	29	54107-01	88	58027-08	82	59024-106	91	82065-02	70
30137-10	29	54109-01	88	58027-11	82	59024-108-BX	91	82159-02-BP	84
30137-15	29	54204-01	82	58027-18	82	59024-110	91	82159-1	84
30137-20	29	55014-05	89	58311-01	80	59024-116	91	82159-2	84
30137-30	29	55015-03	92	58311-02	80	59024-118	91	82159-3	84
30138-10	29	55016-06	89	58311-07	80	59024-12	91	83280-02	99
30138-15	29	55017-02	89	58311-08	80	59024-14	91	83280-03	99
30138-30-BX	29	55020-02	89	58311-11	80	59024-15	91	83280-05	99

Alphanumeric Part Number Index

Part Number	Page	Part Number	Page	Part Number	Page	Part Number	Page	Part Number	Page
83285-01	77	95061-BX	72	M-121	117	M-612	98	PL-521-AC	120
83288-BX	77	95062-10	72	M-284	68	M-626	98	PL-521-GC	120
86099-2-BX	28	95062-13	72	M-284-01	68	M-626-02	98	PL-521-RC	120
86099-3	28	95062-17	72	M-284-02	68	M-628	102	PL-522-AC	120
86099-4	28	95062-50-BX	72	M-284-09-BP	68	M-630	102	PL-522-GC	120
86099-5	28	95062-57-BX	72	M-284-26	68	M-641-01	39	PL-522-RC	120
86126-12	28	95521-01	75	M-284-A	68	M-643-01	39	PL-523-AC	120
86126-2	28	95521-B	75	M-288	75	M-674-BX	39	PL-523-BC	120
86126-4	28	95522-A	74	M-289-BX	68	M-700	76	PL-523-CC	120
86126-6	28	95524-A	74	M-290	68	M-712	76	PL-523-GC	120
86126-8	28	95525-A	74	M-290-01	68	M-712-09	76	PL-523-RC	120
87167-01-BP	84	95613-BX	75	M-290-05	68	M-750	69	PL-524-AC	120
880064S	62	95633-A	74	M-320-RC000-BX	122	M-754	69	PL-524-GC	120
880107S	54	95634-01	74	M-414-01	39	M-850	76	PL-524-RC	120
880175S	62	98635-01	77	M-415-01	39	M-914-01	98	PL-525-AC	120
888842000A	62	BPDMA104HXF1	45	M-426	40	MAHC0001TXJ	33	PL-525-GC	120
90005-01	104	BUCBxxx.Z	28	M-427	40	MAHC0001ZXJ	33	PL-525-RC	120
90005-03	104	DL-13	122	M-428	40	MAHC0001ZXJA	33	PL-526-AC	120
90030-01	96	DL-21	122	M-429	40	MC-250012-DN	59	PL-526-GC	120
90030-04	96	FHAC0001SXJ	34	M-432	122	MC-250012-NN	59	PL-526-RC	120
90030-12	96	FHAC0001XP	34	M-448	41	MC-250012-RN	59	PL-612-A	120
90030-24	96	FHAC0002SXJ	34	M-448-02	41	MCASxxx.V	16	PL-612-B	120
90030-33	96	FHAC0002XP	34	M-449	41	MCASxxx.VS	16	PL-612-G	120
90030-43	96	FHJC1001G	35	M-456	40	MCASxxx.XP	16	PL-612-R	120
90030-53	96	FHJC1002G	35	M-458	122	MCASxxx.XPS	16	PL-624-A	120
90036-02-BX	96	FHJC1002L	35	M-476	102	MIC2xxx.V	15	PL-624-B	120
90036-10	96	FHJC2002G	35	M-482	102	MIC2xxx.VP	15	PL-624-G	120
90043-07	97	FHJC2002L	35	M-484	90	MIC2xxx.ZXPRO	15	PL-624-R	120
90043-31	97	FHLM0200Z	36	M-485	98	MIC3xxx.VP	15	PL-85-AC000	121
90047-01	98	FHLM0200ZPA	36	M-489	76	MIC3xxx.ZXPRO	15	PL-85-GC000	121
90048-01	98	FHM20200Z	36	M-489-03	76	PDM21001LXM	44	PL-85-RC000	121
91109-03	97	FHM20200ZPA	36	M-490	98	PDM31001ZXM	44	PL-86-AC000	121
91812-02	100	FLEC3000Z-0	47	M-492	98	PDM31002ZXM	44	PL-86-GC000	121
92107-04	110	FLEC3000Z-0U	47	M-493	90	PDM32001ZXM	44	PL-86-RC000	121
95060-01	72	JBPT0001Z	70	M-497	76	PDM32003ZXM	44	R2-400112-RN	59
95060-02	72	JBPT2N02ZXB	70	M-524	98	PDM32004ZXM	44	RA-200024-DS	59
95060-03	72	JBPT2P01ZXR	70	M-527	102	PDM33001ZXM	44	RA-400012-DS	59
95060-04	72	JBPT3N03ZXB	70	M-530	102	PDM33003ZXM	44	RA-400112-DN	59
95060-07	72	JBPT3P01ZXB	70	M-531	102	PDM33004ZXM	44	RA-400112-NN	59
95060-21	72	JBPT3P02ZXB	70	M-532	102	PDM61001ZXM	45	RA-400112-RN	59
95060-23	72	JCASxxx.X	16	M-54111-01	90	PDM71001ZXM	44	RA-700112-DN	59
95060-24	72	JCASxxx.XP	16	M-54111-02	90	PDM71003ZXM	44	RA-700112-NN	59
95060-26	72	JLLNxxx.T	20	M-550	76	PL-116-RC000-BX	122	RA-700112-RN	59
95060-29	72	JLLNxxx.V	20	M-550-14	76	PL-118-AC001	122	RC-200024-DS	59
95060-34	72	JLLNxxx.X	20	M-58031-01	83	PL-118-GC001	122	RC-200124-DN	59
95060-36	72	JLLSxxx.T	20	M-58031-02	83	PL-118-RC000	122	RC-200124-NN	59
95060-43	72	JLLSxxx.V	20	M-58031-04	83	PL-118-RC001	122	RC-200124-RN	59
95060-50-BP	72	JLLSxxx.X	20	M-58031-07	83	PL-2-BC000	121	RC-400012-DS	59
95060-60-BP	72	LFMX0006Z-01	47	M-58031-08	83	PL-2-GC000	121	RC-400112-DN	59
95061-01	72	LFMX0007Z-01	47	M-58031-09	83	PL-2-RC000-BX	121	RC-400112-NN	59
95061-04	72	LJCAxxx.X	16	M-584	90	PL-20-AC000	121	RC-400112-RN	59
95061-05	72	LJCAxxx.XP	16	M-597	92	PL-20-GC000	121	RC-700112-DN	59
95061-07	72	LMINxxx.V	13	M-598	92	PL-20-RC000	121	RC-700112-NN	59
95061-36	72	LMINxxx.VP	13	M-606	102	PL-36-AC000-BX	121	RC-700112-RN	59
95061-50-BX	72	LMINxxx.ZXPROA	13	M-608	98	PL-36-GC000	121	ZCASxxx.XP	17
95061-60-BX	72	M-115	117	M-6110-05	76	PL-36-RC000	121		

Entire Vehicle **ELECTRICAL POWER** Expertise

Littelfuse manufactures products for your entire vehicle electrical system with components that help distribute, protect and control vehicle power. Review this schematic to learn how you can streamline your design and sourcing requirements.



1 Mixed Current Power Distribution

Custom Product



2 Battery Power Control

880086 - HD Series Relay



3 Primary Power Distribution

FLEC3000Z-0 - FLEC Series



4 Auxiliary Power Distribution

PDM71001ZX-M - HWB60-AL



5 Power Conversion

880211 - Liftgate Battery Charger

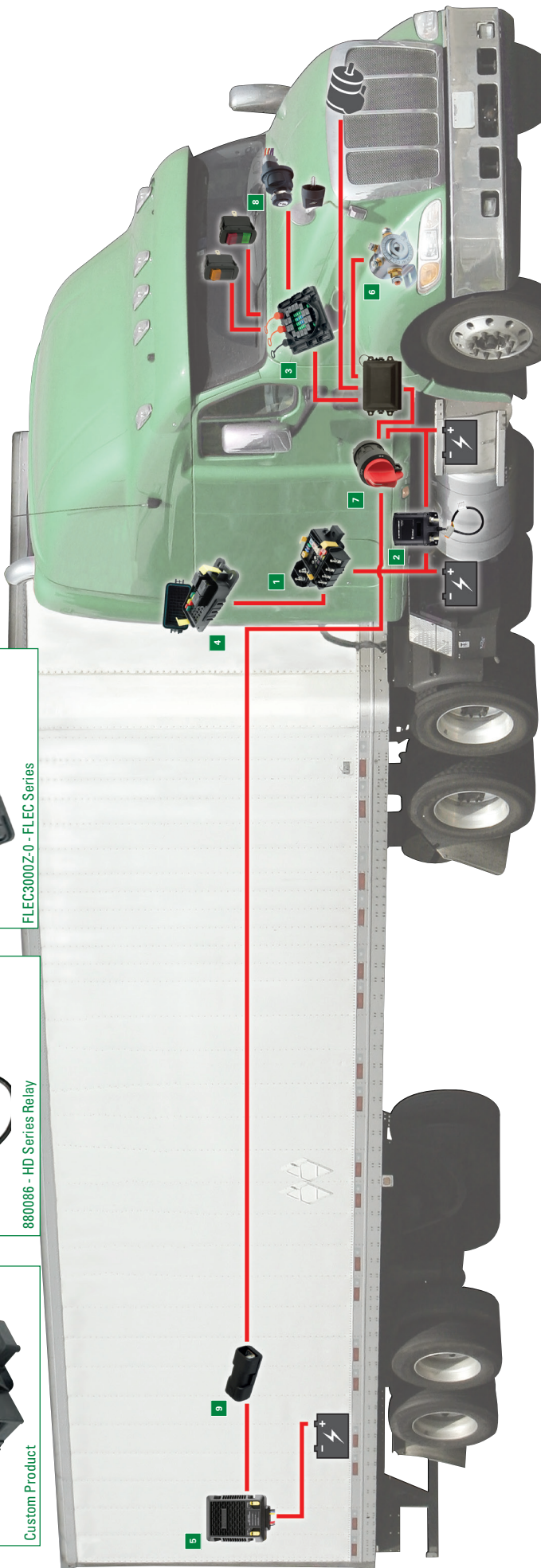

6 Relays & Solenoids

24059 - Continuous Duty Solenoid



7 Master Disconnect

75920 Series - Battery Switches



8 Switches

95060 Series - Ignition Switches



9 In-Line Fuse Holders

FHAC0001ZX-J - 04980921GXM5

Electrical Power Expertise For Material Handling

Littelfuse manufactures products for your entire vehicle electrical system with components that help distribute, protect and control vehicle power. Review this schematic to learn how you can streamline your design and sourcing requirements.



1 Sealed and Unsealed Fuses and Fuse Holders

Sealed ZCASE Fuse
0FH2020Z
LFFB003
Unsealed ZCASE Fuse

2 Master Power Distribution Units

0FH20001Z

3 Integrated Power Relays

4 High and Low Current Fuses for Various Voltage Levels

MEGA Fuse
MINI Fuse
ZCASE Fuse
MAXI Fuse
CNN-E Fuse

5 Fuse and Relay Centers

880039
HWB60-AL

6 Ignition, Rocker, Toggle, and Momentary Switches

58328-35
95060-01

7 Active/Passive Electronics and Power Semi-Conductors

Need **MORE INFORMATION** about Commercial Vehicle Products?

Littelfuse publishes technical documents to help in the design and selection of products for your electrical systems. To learn more about a specific product or application, visit our online library at:

Littelfuse.com/Commercial-Vehicle-Technical-Center

- Extended Datasheets
- Application Notes
- CAD Drawings
- 2D Outlines
- 3D Models
- Glossary
- FAQ



Littelfuse.com/Catalogs

Littelfuse offers digital and printed catalogs, to request a copy, please contact Littelfuse or download the digital version on our website.

Our product catalogs feature circuit protection, power control and sensing products for OEM and aftermarket applications.

- Commercial Vehicle Aftermarket Catalog
- Automotive Passenger Car Catalog
- Automotive Fuse & Fuse Holder Selection Guide

Littelfuse.com/ContactUs

Contact Littelfuse support or find a local representative or distributor.



Littelfuse Aftermarket Products
Chicago, Illinois USA
+1 800 365 2653
cvp_info@Littelfuse.com

To learn more about specific
products or applications visit:
Littelfuse.com/Aftermarket



Компания «Океан Электроники» предлагает заключение долгосрочных отношений при поставках импортных электронных компонентов на взаимовыгодных условиях!

Наши преимущества:

- Поставка оригинальных импортных электронных компонентов напрямую с производств Америки, Европы и Азии, а так же с крупнейших складов мира;
- Широкая линейка поставок активных и пассивных импортных электронных компонентов (более 30 млн. наименований);
- Поставка сложных, дефицитных, либо снятых с производства позиций;
- Оперативные сроки поставки под заказ (от 5 рабочих дней);
- Экспресс доставка в любую точку России;
- Помощь Конструкторского Отдела и консультации квалифицированных инженеров;
- Техническая поддержка проекта, помощь в подборе аналогов, поставка прототипов;
- Поставка электронных компонентов под контролем ВП;
- Система менеджмента качества сертифицирована по Международному стандарту ISO 9001;
- При необходимости вся продукция военного и аэрокосмического назначения проходит испытания и сертификацию в лаборатории (по согласованию с заказчиком);
- Поставка специализированных компонентов военного и аэрокосмического уровня качества (Xilinx, Altera, Analog Devices, Intersil, Interpoint, Microsemi, Actel, Aeroflex, Peregrine, VPT, Syfer, Eurofarad, Texas Instruments, MS Kennedy, Miteq, Cobham, E2V, MA-COM, Hittite, Mini-Circuits, General Dynamics и др.);

Компания «Океан Электроники» является официальным дистрибьютором и эксклюзивным представителем в России одного из крупнейших производителей разъемов военного и аэрокосмического назначения «JONHON», а так же официальным дистрибьютором и эксклюзивным представителем в России производителя высокотехнологичных и надежных решений для передачи СВЧ сигналов «FORSTAR».



JONHON

«JONHON» (основан в 1970 г.)

Разъемы специального, военного и аэрокосмического назначения:

(Применяются в военной, авиационной, аэрокосмической, морской, железнодорожной, горно- и нефтедобывающей отраслях промышленности)

«FORSTAR» (основан в 1998 г.)

ВЧ соединители, коаксиальные кабели, кабельные сборки и микроволновые компоненты:

(Применяются в телекоммуникациях гражданского и специального назначения, в средствах связи, РЛС, а так же военной, авиационной и аэрокосмической отраслях промышленности).



Телефон: 8 (812) 309-75-97 (многоканальный)

Факс: 8 (812) 320-03-32

Электронная почта: ocean@oceanchips.ru

Web: <http://oceanchips.ru/>

Адрес: 198099, г. Санкт-Петербург, ул. Калинина, д. 2, корп. 4, лит. А