

Micropower Voltage Detector

Features

- Ultra-low supply current: 1.75 μA (max.)
- Precision monitoring options of:
 - 1.90V, 2.32V, 2.63V, 2.90V, 2.93V, 3.08V, 4.38V and 4.63V
- Resets microcontroller in a power-loss event
- Active-low V_{OUT} pin:
 - **MCP111** active-low, open-drain
 - **MCP112** active-low, push-pull
- Available in SOT23-3, TO-92, SC-70 and SOT-89-3 packages
- Temperature Range:
 - Extended: -40°C to $+125^{\circ}\text{C}$ (except MCP1XX-195)
 - Industrial: -40°C to $+85^{\circ}\text{C}$ (MCP1XX-195 only)
- Pb-free devices

Applications

- Critical Microcontroller and Microprocessor Power-Monitoring Applications
- Computers
- Intelligent Instruments
- Portable Battery-Powered Equipment

Description

The MCP111/112 are voltage-detecting devices designed to keep a microcontroller in reset until the system voltage has stabilized at the appropriate level for reliable system operation. These devices also operate as protection from brown-out conditions when the system supply voltage drops below the specified threshold voltage level. Eight different trip voltages are available.

Package Types



Block Diagram



TABLE 1: DEVICE FEATURES

Device	Output		Reset Delay (typ)	Package Pin Out (Pin # 1, 2, 3)	Comment
	Type	Pull-up Resistor			
MCP111	Open-drain	External	No	$V_{\text{OUT}}, V_{\text{SS}}, V_{\text{DD}}$	
MCP112	Push-pull	No	No	$V_{\text{OUT}}, V_{\text{SS}}, V_{\text{DD}}$	
MCP102	Push-pull	No	120 ms	$\overline{\text{RST}}, V_{\text{DD}}, V_{\text{SS}}$	See MCP102/103/121/131 Data Sheet (DS21906)
MCP103	Push-pull	No	120 ms	$V_{\text{SS}}, \overline{\text{RST}}, V_{\text{DD}}$	See MCP102/103/121/131 Data Sheet (DS21906)
MCP121	Open-drain	External	120 ms	$\overline{\text{RST}}, V_{\text{DD}}, V_{\text{SS}}$	See MCP102/103/121/131 Data Sheet (DS21906)
MCP131	Open-Drain	Internal (~95 k Ω)	120 ms	$\overline{\text{RST}}, V_{\text{DD}}, V_{\text{SS}}$	See MCP102/103/121/131 Data Sheet (DS21906)

MCP111/112

1.0 ELECTRICAL CHARACTERISTICS

Absolute Maximum Ratings†

V_{DD}	7.0V
Input current (V_{DD})	10 mA
Output current (\overline{RST})	10 mA
Rated Rise Time of V_{DD}	100V/ μ s
All inputs and outputs (except \overline{RST}) w.r.t. V_{SS}	-0.6V to ($V_{DD} + 1.0V$)
\overline{RST} output w.r.t. V_{SS}	-0.6V to 13.5V
Storage temperature	-65°C to +150°C
Ambient temp. with power applied	-40°C to +125°C
Maximum Junction temp. with power applied	150°C
ESD protection on all pins	≥ 2 kV

† **Notice:** Stresses above those listed under "Maximum Ratings" may cause permanent damage to the device. This is a stress rating only and functional operation of the device at those or any other conditions above those indicated in the operational listings of this specification is not implied. Exposure to maximum rating conditions for extended periods may affect device reliability.

DC CHARACTERISTICS

Electrical Specifications: Unless otherwise indicated, all limits are specified for $V_{DD} = 1V$ to 5.5V, $R_{PU} = 100$ k Ω (only **MCP111**), $T_A = -40^\circ\text{C}$ to $+125^\circ\text{C}$.

Parameters		Sym	Min	Typ	Max	Units	Conditions
Operating Voltage Range		V_{DD}	1.0	—	5.5	V	
Specified V_{DD} Value to V_{OUT} low		V_{DD}	1.0	—		V	$I_{\overline{RST}} = 10 \mu\text{A}$, $V_{\overline{RST}} < 0.2V$
Operating Current		I_{DD}	—	< 1	1.75	μA	
V_{DD} Trip Point	MCP1XX-195	V_{TRIP}	1.872	1.900	1.929	V	$T_A = +25^\circ\text{C}$ (Note 1)
			1.853	1.900	1.948	V	$T_A = -40^\circ\text{C}$ to $+85^\circ\text{C}$ (Note 2)
	MCP1XX-240		2.285	2.320	2.355	V	$T_A = +25^\circ\text{C}$ (Note 1)
			2.262	2.320	2.378	V	Note 2
	MCP1XX-270		2.591	2.630	2.670	V	$T_A = +25^\circ\text{C}$ (Note 1)
			2.564	2.630	2.696	V	Note 2
	MCP1XX-290		2.857	2.900	2.944	V	$T_A = +25^\circ\text{C}$ (Note 1)
			2.828	2.900	2.973	V	Note 2
	MCP1XX-300		2.886	2.930	2.974	V	$T_A = +25^\circ\text{C}$ (Note 1)
			2.857	2.930	3.003	V	Note 2
	MCP1XX-315		3.034	3.080	3.126	V	$T_A = +25^\circ\text{C}$ (Note 1)
			3.003	3.080	3.157	V	Note 2
	MCP1XX-450		4.314	4.380	4.446	V	$T_A = +25^\circ\text{C}$ (Note 1)
			4.271	4.380	4.490	V	Note 2
MCP1XX-475	4.561	4.630	4.700	V	$T_A = +25^\circ\text{C}$ (Note 1)		
	4.514	4.630	4.746	V	Note 2		
V_{DD} Trip Point Tempco		T_{TPCO}	—	± 100	—	ppm/ $^\circ\text{C}$	

- Note 1:** Trip point is $\pm 1.5\%$ from typical value.
Note 2: Trip point is $\pm 2.5\%$ from typical value.
Note 3: This specification allows this device to be used in PIC[®] microcontroller applications that require the In-Circuit Serial Programming[™] (ICSP[™]) feature (see device-specific programming specifications for voltage requirements). This specification DOES NOT allow a continuous high voltage to be present on the open-drain output pin (V_{OUT}). The total time that the V_{OUT} pin can be above the maximum device operational voltage (5.5V) is 100 sec. Current into the V_{OUT} pin should be limited to 2 mA. It is recommended that the device operational temperature be maintained between 0°C to 70°C (+25°C preferred). For additional information, please refer to Figure 2-28.
Note 4: This parameter is established by characterization and is not 100% tested.

DC CHARACTERISTICS (CONTINUED)

Electrical Specifications: Unless otherwise indicated, all limits are specified for $V_{DD} = 1V$ to $5.5V$, $R_{PU} = 100\text{ k}\Omega$ (only MCP111), $T_A = -40^\circ\text{C}$ to $+125^\circ\text{C}$.							
Parameters	Sym	Min	Typ	Max	Units	Conditions	
Threshold Hysteresis (min. = 1%, max = 6%)	MCP1XX-195	V_{HYS}	0.019	—	0.114	V	$T_A = +25^\circ\text{C}$
	MCP1XX-240		0.023	—	0.139	V	
	MCP1XX-270		0.026	—	0.158	V	
	MCP1XX-290		0.029	—	0.174	V	
	MCP1XX-300		0.029	—	0.176	V	
	MCP1XX-315		0.031	—	0.185	V	
	MCP1XX-450		0.044	—	0.263	V	
	MCP1XX-475		0.046	—	0.278	V	
V_{OUT} Low-level Output Voltage	V_{OL}	—	—	0.4	V	$I_{OL} = 500\text{ }\mu\text{A}$, $V_{DD} = V_{TRIP(MIN)}$	
V_{OUT} High-level Output Voltage	V_{OH}	$V_{DD} - 0.6$	—	—	V	$I_{OH} = 1\text{ mA}$, For only MCP112 (push-pull output)	
Open-drain High Voltage on Output	V_{ODH}	—	—	13.5 ⁽³⁾	V	MCP111 only, $V_{DD} = 3.0V$, Time voltage > 5.5V applied $\leq 100s$, current into pin limited to 2 mA, $+25^\circ\text{C}$ operation recommended Note 3, Note 4	
Open-drain Output Leakage Current (MCP111 only)	I_{OD}	—	0.1	—	μA		

- Note 1:** Trip point is $\pm 1.5\%$ from typical value.
- Note 2:** Trip point is $\pm 2.5\%$ from typical value.
- Note 3:** This specification allows this device to be used in PIC[®] microcontroller applications that require the In-Circuit Serial Programming[™] (ICSP[™]) feature (see device-specific programming specifications for voltage requirements). This specification DOES NOT allow a continuous high voltage to be present on the open-drain output pin (V_{OUT}). The total time that the V_{OUT} pin can be above the maximum device operational voltage (5.5V) is 100 sec. Current into the V_{OUT} pin should be limited to 2 mA. It is recommended that the device operational temperature be maintained between 0°C to 70°C ($+25^\circ\text{C}$ preferred). For additional information, please refer to Figure 2-28.
- Note 4:** This parameter is established by characterization and is not 100% tested.

MCP111/112



FIGURE 1-1: Timing Diagram.

AC CHARACTERISTICS

Electrical Specifications: Unless otherwise indicated, all limits are specified for $V_{DD} = 1V$ to $5.5V$, $R_{PU} = 100\text{ k}\Omega$ (only **MCP111**), $T_A = -40^\circ\text{C}$ to $+125^\circ\text{C}$.

Parameters	Sym	Min	Typ	Max	Units	Conditions
V_{DD} Detect to V_{OUT} Inactive	t_{RPU}	—	90	—	μs	Figure 1-1 and $C_L = 50\text{ pF}$ (Note 1)
V_{DD} Detect to V_{OUT} Active	t_{RPD}	—	130	—	μs	V_{DD} ramped from $V_{TRIP(MAX)} + 250\text{ mV}$ down to $V_{TRIP(MIN)} - 250\text{ mV}$, per Figure 1-1, $C_L = 50\text{ pF}$ (Note 1)
V_{OUT} Rise Time After V_{OUT} Active	t_{RT}	—	5	—	μs	For V_{OUT} 10% to 90% of final value per Figure 1-1, $C_L = 50\text{ pF}$ (Note 1)

Note 1: These parameters are for design guidance only and are not 100% tested.

TEMPERATURE CHARACTERISTICS

Electrical Specifications: Unless otherwise noted, all limits are specified for $V_{DD} = 1V$ to $5.5V$, $R_{PU} = 100\text{ k}\Omega$ (only **MCP111**), $T_A = -40^\circ\text{C}$ to $+125^\circ\text{C}$.

Parameters	Sym	Min	Typ	Max	Units	Conditions
Temperature Ranges						
Specified Temperature Range	T_A	-40	—	+85	$^\circ\text{C}$	MCP1XX-195
Specified Temperature Range	T_A	-40	—	+125	$^\circ\text{C}$	Except MCP1XX-195
Maximum Junction Temperature	T_J	—	—	+150	$^\circ\text{C}$	
Storage Temperature Range	T_A	-65	—	+150	$^\circ\text{C}$	
Package Thermal Resistances						
Thermal Resistance, 3L-SOT23	θ_{JA}	—	336	—	$^\circ\text{C}/\text{W}$	
Thermal Resistance, 3L-SC-70	θ_{JA}	—	340	—	$^\circ\text{C}/\text{W}$	
Thermal Resistance, 3L-TO-92	θ_{JA}	—	131.9	—	$^\circ\text{C}/\text{W}$	
Thermal Resistance, 3L-SOT-89	θ_{JA}	—	110	—	$^\circ\text{C}/\text{W}$	

2.0 TYPICAL PERFORMANCE CURVES

Note: The graphs and tables provided following this note are a statistical summary based on a limited number of samples and are provided for informational purposes only. The performance characteristics listed herein are not tested or guaranteed. In some graphs or tables, the data presented may be outside the specified operating range (e.g., outside specified power supply range) and therefore outside the warranted range.

Note: Unless otherwise indicated, all limits are specified for $V_{DD} = 1V$ to $5.5V$, $R_{PU} = 100\text{ k}\Omega$ (only **MCP111**; see **Figure 4-1**), $T_A = -40^\circ\text{C}$ to $+125^\circ\text{C}$.



FIGURE 2-1: I_{DD} vs. Temperature (MCP111-195).



FIGURE 2-4: I_{DD} vs. V_{DD} (MCP111-195).

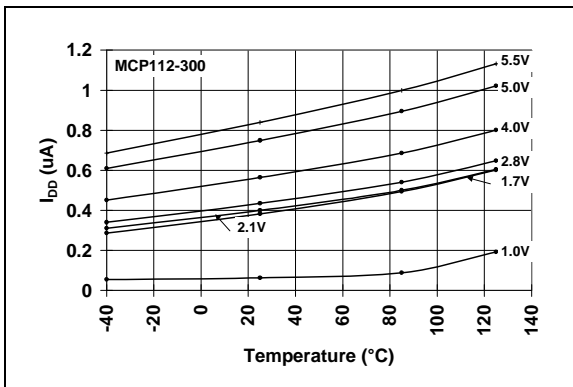

FIGURE 2-2: I_{DD} vs. Temperature (MCP112-300).

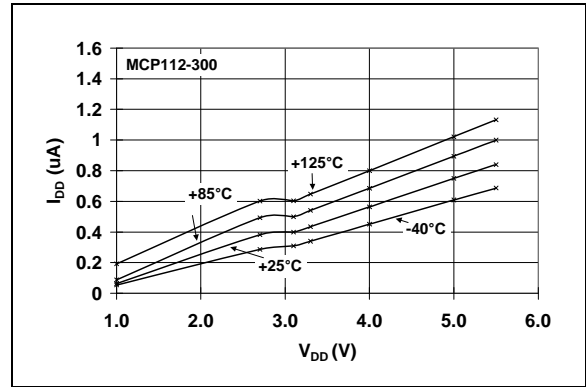

FIGURE 2-5: I_{DD} vs. V_{DD} (MCP112-300).



FIGURE 2-3: I_{DD} vs. Temperature (MCP112-475).



FIGURE 2-6: I_{DD} vs. V_{DD} (MCP112-475).

MCP111/112

Note: Unless otherwise indicated, all limits are specified for $V_{DD} = 1V$ to $5.5V$, $R_{PU} = 100\text{ k}\Omega$ (only **MCP111**); see **Figure 4-1**), $T_A = -40^\circ\text{C}$ to $+125^\circ\text{C}$.



FIGURE 2-7: V_{TRIP} and V_{HYST} vs. Temperature (**MCP111-195**).



FIGURE 2-10: V_{OL} vs. I_{OL} (**MCP111-195** @ $V_{DD} = 1.7V$).



FIGURE 2-8: V_{TRIP} and V_{HYST} vs. Temperature (**MCP112-300**).



FIGURE 2-11: V_{OL} vs. I_{OL} (**MCP112-300** @ $V_{DD} = 2.7V$).



FIGURE 2-9: V_{TRIP} and V_{HYST} vs. Temperature (**MCP112-475**).



FIGURE 2-12: V_{OL} vs. I_{OL} (**MCP112-475** @ $V_{DD} = 4.4V$).

Note: Unless otherwise indicated, all limits are specified for $V_{DD} = 1V$ to $5.5V$, $R_{PU} = 100\text{ k}\Omega$ (only MCP111; see Figure 4-1), $T_A = -40^\circ\text{C}$ to $+125^\circ\text{C}$.



FIGURE 2-13: V_{OL} vs. Temperature (MCP111-195 @ $V_{DD} = 1.7V$).



FIGURE 2-16: V_{OH} vs. I_{OH} (MCP112-300 @ $V_{DD} = 3.1V$).



FIGURE 2-14: V_{OL} vs. Temperature (MCP112-300 @ $V_{DD} = 2.7V$).



FIGURE 2-17: V_{OH} vs. I_{OH} (MCP112-475 @ $V_{DD} = 4.8V$).



FIGURE 2-15: V_{OL} vs. Temperature (MCP112-475 @ $V_{DD} = 4.4V$).



FIGURE 2-18: Typical Transient Response (25°C).

MCP111/112

Note: Unless otherwise indicated, all limits are specified for $V_{DD} = 1V$ to $5.5V$, $R_{PU} = 100\text{ k}\Omega$ (only MCP111; see Figure 4-1), $T_A = -40^\circ\text{C}$ to $+125^\circ\text{C}$.



FIGURE 2-19: t_{RPD} vs. Temperature (MCP111-195).



FIGURE 2-22: t_{RPU} vs. Temperature (MCP111-195).



FIGURE 2-20: t_{RPD} vs. Temperature (MCP112-300).



FIGURE 2-23: t_{RPU} vs. Temperature (MCP112-300).



FIGURE 2-21: t_{RPD} vs. Temperature (MCP112-475).



FIGURE 2-24: t_{RPU} vs. Temperature (MCP112-475).

Note: Unless otherwise indicated, all limits are specified for $V_{DD} = 1V$ to $5.5V$, $R_{PU} = 100\text{ k}\Omega$ (only MCP111; see Figure 4-1), $T_A = -40^\circ\text{C}$ to $+125^\circ\text{C}$.



FIGURE 2-25: t_{RT} vs. Temperature (MCP111-195).



FIGURE 2-27: t_{RT} vs. Temperature (MCP112-475).



FIGURE 2-26: t_{RT} vs. Temperature (MCP112-300).



FIGURE 2-28: Open-Drain Leakage Current vs. Voltage Applied to V_{OUT} Pin (MCP111-195).

MCP111/112

3.0 PIN DESCRIPTION

The descriptions of the pins are listed in Table 3-1.

TABLE 3-1: PIN FUNCTION TABLE

Pin No.			Symbol	Function
SOT-23-3 SC-70	SOT-89-3	T0-92		
1	1	1	V_{OUT}	Output State V_{DD} Falling: $H = V_{DD} > V_{TRIP}$ $L = V_{DD} < V_{TRIP}$ V_{DD} Rising: $H = V_{DD} > V_{TRIP} + V_{HYS}$ $L = V_{DD} < V_{TRIP} + V_{HYS}$
2	2	3	V_{SS}	Ground reference
3	3	2	V_{DD}	Positive power supply
—	4	—	V_{DD}	Positive power supply

4.0 APPLICATION INFORMATION

For many of today's microcontroller applications, care must be taken to prevent low-power conditions that can cause many different system-power problems. The most common causes are brown-out conditions, where the system supply drops below the operating level momentarily. The second most common cause is when a slowly decaying power supply causes the microcontroller to begin executing instructions without sufficient voltage to sustain SRAM, thus producing indeterminate results. Figure 4-1 shows a typical application circuit.



FIGURE 4-1: Typical Application Circuit.

4.1 V_{TRIP} Operation

The voltage trip point (V_{TRIP}) is determined on the falling edge of V_{DD} . The actual voltage trip point (V_{TRIPAC}) will be between the minimum trip point ($V_{TRIPMIN}$) and the maximum trip point ($V_{TRIPMAX}$). There is a hysteresis on this trip point to remove any "jitter" that would occur on the V_{OUT} pin when the device V_{DD} is at the trip point.

Figure 4-2 shows the state of the V_{OUT} pin as determined by the V_{DD} voltage. The V_{TRIP} specification is for falling V_{DD} voltages. When the V_{DD} voltage is rising, the V_{OUT} pin will not be driven high until V_{DD} is at $V_{TRIP} + V_{HYS}$.



MCP111/112

4.2 Negative Going V_{DD} Transients

The minimum pulse width (time) required to cause a reset may be an important criteria in the implementation of a Power-on Reset (POR) circuit. This time is referred to as transient duration, defined as the amount of time needed for these supervisory devices to respond to a drop in V_{DD} . The transient duration time is dependant on the magnitude of $V_{TRIP} - V_{DD}$. Generally speaking, the transient duration decreases with increases in $V_{TRIP} - V_{DD}$.

Figure 4-3 shows a typical transient duration vs. reset comparator overdrive for which the MCP111/112 will not generate a reset pulse. It shows that the farther below the trip point the transient pulse goes, the duration of the pulse required to cause a reset gets shorter. Figure 2-18 shows the transient response characteristics for the MCP111/112.

A 0.1 μF bypass capacitor, mounted as close as possible to the V_{DD} pin, provides additional transient immunity (refer to Figure 4-1).



FIGURE 4-3: Example of Typical Transient Duration Waveform.

4.3 Effect of Temperature on Time-out Period (t_{RPU})

The time-out period (t_{RPU}) determines how long the device remains in the reset condition. This is affected by both V_{DD} and temperature. The graph shown in Figures 2-22, 2-23 and 2-24 show the typical response for different V_{DD} values and temperatures.

4.4 Using in PIC[®] Microcontroller ICSP[™] Applications (MCP111 only)

Figure 4-4 shows the typical application circuit for using the MCP111 for voltage supervisory function when the PIC microcontroller will be programmed via the In-Circuit Serial Programming[™] (ICSP) feature. Additional information is available in TB087, "Using Voltage Supervisors with PIC[®] Microcontroller Systems which Implement In-Circuit Serial Programming[™]", DS91087.

Note: It is recommended that the current into the $\overline{\text{RST}}$ pin be current limited by a 1 k Ω resistor.

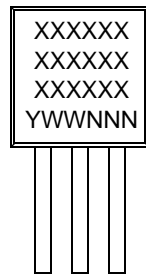

FIGURE 4-4: Typical Application Circuit for PIC[®] Microcontroller with the ICSP[™] feature.

5.0 PACKAGING INFORMATION

5.1 Package Marking Information

3-Lead TO-92



Example:



3-Pin SOT-23

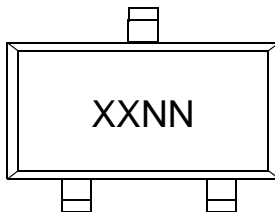

Example:

Part Number	SOT-23	Part Number	SOT-23
MCP111T-195I/TT	MPNN	MCP112T-195I/TT	MRNN
MCP111T-240ETT	MQNN	MCP112T-240ETT	MSNN
MCP111T-270E/TT	MGNN	MCP112T-270E/TT	MANN
MCP111T-290E/TT	NHNN	MCP112T-290E/TT	MBNN
MCP111T-300E/TT	MJNN	MCP112T-300E/TT	MCNN
MCP111T-315E/TT	MKNN	MCP112T-315E/TT	MDNN
MCP111T-450E/TT	MLNN	MCP112T-450E/TT	MENN
MCP111T-475E/TT	MMNN	MCP112T-475E/TT	MFNN

3-Pin SOT-89

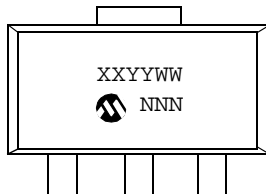

Example:

Part Number	SOT-89	Part Number	SOT-89
MCP111T-195I/MB	MP	MCP112T-195I/MB	MR
MCP111T-240EMB	MQ	MCP112T-240EMB	MS
MCP111T-270E/MB	MG	MCP112T-270E/MB	MA
MCP111T-290E/MB	NH	MCP112T-290E/MB	MB
MCP111T-300E/MB	MJ	MCP112T-300E/MB	MC
MCP111T-315E/MB	MK	MCP112T-315E/MB	MD
MCP111T-450E/MB	ML	MCP112T-450E/MB	ME
MCP111T-475E/MB	MM	MCP112T-475E/MB	MF

Legend: XX...X Customer-specific information
 Y Year code (last digit of calendar year)
 WW Week code (week of January 1 is week '01')
 NNN Alphanumeric traceability code
 (e3) Pb-free JEDEC designator for Matte Tin (Sn)
 * This package is Pb-free. The Pb-free JEDEC designator (e3) can be found on the outer packaging for this package.

Note: In the event the full Microchip part number cannot be marked on one line, it will be carried over to the next line, thus limiting the number of available characters for customer-specific information.

MCP111/112

Package Marking Information (Continued)

3-Pin SC-70



Top Side

OR



Top Side

Example:

Part Number	SC-70	Part Number	SC-70
MCP111T-195I/LB	EPN	MCP112T-195I/LB	ERN
MCP111T-240E/LB	EQN	MCP112T-240E/LB	ESN
MCP111T-270E/LB	EGN	MCP112T-270E/LB	EAN
MCP111T-290E/LB	EHN	MCP112T-290E/LB	EBN
MCP111T-300E/LB	EJN	MCP112T-300E/LB	ECN
MCP111T-315E/LB	EKN	MCP112T-315E/LB	EDN
MCP111T-450E/LB	ELN	MCP112T-450E/LB	EEN
MCP111T-475E/LB	EMN	MCP112T-475E/LB	EFN

Example:

Part Number	SC-70	Part Number	SC-70
MCP111T-195I/LB	EPNN	MCP112T-195I/LB	ERNN
MCP111T-240E/LB	EQNN	MCP112T-240E/LB	ESNN
MCP111T-270E/LB	EGNN	MCP112T-270E/LB	EANN
MCP111T-290E/LB	EHNN	MCP112T-290E/LB	EBNN
MCP111T-300E/LB	EJNN	MCP112T-300E/LB	ECNN
MCP111T-315E/LB	EKNN	MCP112T-315E/LB	EDNN
MCP111T-450E/LB	ELNN	MCP112T-450E/LB	EENN
MCP111T-475E/LB	EMNN	MCP112T-475E/LB	EFNN

3-Lead Plastic Small Outline Transistor (MB) (SOT89)

Note: For the most current package drawings, please see the Microchip Packaging Specification located at <http://www.microchip.com/packaging>



Dimension Limits	Units	INCHES		MILLIMETERS*	
		MIN	MAX	MIN	MAX
Pitch	p	.059 BSC		1.50 BSC	
Outside lead pitch (basic)	p1	.118 BSC		3.00 BSC	
Overall Height	A	.055	.063	1.40	1.60
Overall Width	H	.155	.167	3.94	4.25
Molded Package Width at Base	E	.090	.102	2.29	2.60
Molded Package Width at Top	E1	.084	.090	2.13	2.29
Overall Length	D	.173	.181	4.40	4.60
Tab Length	D1	.064	.072	1.62	1.83
Tab Corner Radii	R	.010		0.254	
Foot Length	L	.035	.047	0.89	1.20
Lead Thickness	c	.014	.017	0.35	0.44
Lead 2 Width	B	.017	.022	0.43	0.56
Leads 1 & 3 Width	B1	.014	.019	0.36	0.48

*Controlling Parameter

Notes:

Dimensions D and E1 do not include mold or flash protrusions. Mold flash or protrusions shall not exceed .005" (0.127mm) per side.

JEDEC Equivalent: TO-243

Drawing No. C04-29

Revised 07-24-03

MCP111/112

3-Lead Plastic Small Outline Transistor (TT) (SOT-23)

Note: For the most current package drawings, please see the Microchip Packaging Specification located at <http://www.microchip.com/packaging>



Dimension Limits	Units	INCHES*			MILLIMETERS		
		MIN	NOM	MAX	MIN	NOM	MAX
Number of Pins	n		3			3	
Pitch	p		.038			0.96	
Outside lead pitch (basic)	p1		.076			1.92	
Overall Height	A	.035	.040	.044	0.89	1.01	1.12
Molded Package Thickness	A2	.035	.037	.040	0.88	0.95	1.02
Standoff §	A1	.000	.002	.004	0.01	0.06	0.10
Overall Width	E	.083	.093	.104	2.10	2.37	2.64
Molded Package Width	E1	.047	.051	.055	1.20	1.30	1.40
Overall Length	D	.110	.115	.120	2.80	2.92	3.04
Foot Length	L	.014	.018	.022	0.35	0.45	0.55
Foot Angle	φ	0	5	10	0	5	10
Lead Thickness	c	.004	.006	.007	0.09	0.14	0.18
Lead Width	B	.015	.017	.020	0.37	0.44	0.51
Mold Draft Angle Top	α	0	5	10	0	5	10
Mold Draft Angle Bottom	β	0	5	10	0	5	10

* Controlling Parameter

§ Significant Characteristic

Notes:

Dimensions D and E1 do not include mold flash or protrusions. Mold flash or protrusions shall not exceed .010" (0.254mm) per side.

JEDEC Equivalent: TO-236

Drawing No. C04-104

3-Lead Plastic Small Outline Transistor (LB) (SC-70)

Note: For the most current package drawings, please see the Microchip Packaging Specification located at <http://www.microchip.com/packaging>



Dimension Limits	Units	INCHES		MILLIMETERS*	
		MIN	MAX	MIN	MAX
Number of Pins		3		3	
Pitch	P	.026 BSC.		0.65 BSC.	
Outside lead pitch (basic)	p1	.051 BSC.		1.30 BSC.	
Overall Height	A	.031	.043	0.80	1.10
Molded Package Thickness	A2	.031	.039	0.80	1.00
Standoff	A1	.000	.0004	0.00	.010
Overall Width	E	.071	.094	1.80	2.40
Molded Package Width	E1	.045	.053	1.15	1.35
Overall Length	D	.071	.089	1.80	2.25
Foot Length	L	.004	.016	0.10	0.41
Lead Thickness	c	.003	.010	0.08	0.25
Lead Width	B	.006	.016	0.15	0.40
Mold Draft Angle Top	a	8°	12°	8°	12°
Mold Draft Angle Bottom	b	8°	12°	8°	12°

*Controlling Parameter

Notes:

Dimensions D and E1 do not include mold flash or protrusions. Mold flash or protrusions shall not exceed .005" (0.127mm) per side.

JEITA (EIAJ) Equivalent: SC70

Drawing No. C04-104

MCP111/112

3-Lead Plastic Transistor Outline (TO) (TO-92)

Note: For the most current package drawings, please see the Microchip Packaging Specification located at <http://www.microchip.com/packaging>



Dimension Limits	Units	INCHES*			MILLIMETERS		
		MIN	NOM	MAX	MIN	NOM	MAX
Number of Pins	n		3			3	
Pitch	p		.050			1.27	
Bottom to Package Flat	A	.130	.143	.155	3.30	3.62	3.94
Overall Width	E1	.175	.186	.195	4.45	4.71	4.95
Overall Length	D	.170	.183	.195	4.32	4.64	4.95
Molded Package Radius	R	.085	.090	.095	2.16	2.29	2.41
Tip to Seating Plane	L	.500	.555	.610	12.70	14.10	15.49
Lead Thickness	c	.014	.017	.020	0.36	0.43	0.51
Lead Width	B	.016	.019	.022	0.41	0.48	0.56
Mold Draft Angle Top	α	4	5	6	4	5	6
Mold Draft Angle Bottom	β	2	3	4	2	3	4

*Controlling Parameter

Notes:

Dimensions D and E1 do not include mold flash or protrusions. Mold flash or protrusions shall not exceed .010" (0.254mm) per side.

JEDEC Equivalent: TO-92

Drawing No. C04-101

5.2 Product Tape and Reel Specifications

FIGURE 5-1: EMBOSSED CARRIER DIMENSIONS (8, 12, 16 AND 24 MM TAPE ONLY)

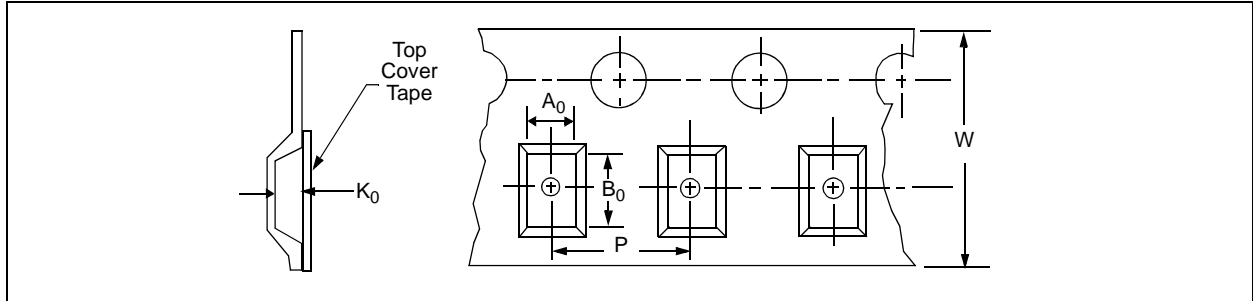
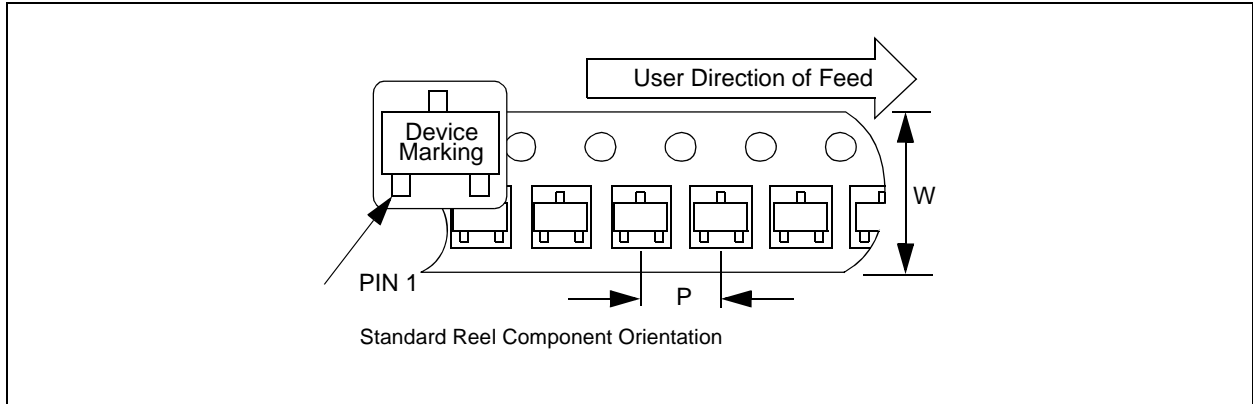

TABLE 1: CARRIER TAPE/CAVITY DIMENSIONS

Case Outline	Package Type		Carrier Dimensions		Cavity Dimensions			Output Quantity Units	Reel Diameter in mm
			W mm	P mm	A0 mm	B0 mm	K0 mm		
TT	SOT-23B	3L	8	4	3.15	2.77	1.22	3000	180
LB	SC-70	3L	8	4	2.4	2.4	1.19	3000	180

FIGURE 5-2: 3-LEAD SOT-23/SC70 DEVICE TAPE AND REEL SPECIFICATIONS



MCP111/112

FIGURE 5-3: TO-92 DEVICES



FIGURE 5-4: SOT-89 DEVICES



APPENDIX A: REVISION HISTORY

Revision E (January 2013)

- Added a note to each package outline drawing.

Revision D (June 2005)

1. Added SOT-89-3 package information throughout.

Revision C (March 2005)

The following is the list of modifications:

1. Added **Section 4.4 “Using in PIC® Microcontroller ICSP™ Applications (MCP111 only)”** on using the MCP111 in PIC microcontroller ICSP applications.
2. Added V_{ODH} specifications in **Section 1.0 “Electrical Characteristics”** (for ICSP applications).
3. Added Figure 2-28.
4. Added devices features table to page 1.
5. Updated SC-70 package markings and added Pb-free marking information to **Section 5.0 “Packaging information”**.
6. Added **Appendix A: “Revision History”**.

Revision B (August 2004)

1. Corrected package marking information in **Section 5.0 “Packaging information”**

Revision A (May 2004)

- Original Release of this Document.

MCP111/112

NOTES:

PRODUCT IDENTIFICATION SYSTEM

To order or obtain information, e.g., on pricing or delivery, refer to the factory or the listed sales office.

<u>PART NO.</u>	<u>X</u>	<u>XXX</u>	<u>X</u>	<u>XX</u>
Device	Tape/Reel Option	Monitoring Options	Temperature Range	Package
Device:				
		MCP111: MicroPower Voltage Detector, open-drain		
		MCP111T: MicroPower Voltage Detector, open-drain (Tape and Reel)		
		MCP112: MicroPower Voltage Detector, push-pull		
		MCP112T: MicroPower Voltage Detector, push-pull (Tape and Reel)		
Monitoring Options:		195 = 1.90V		
		240 = 2.32V		
		270 = 2.63V		
		290 = 2.90V		
		300 = 2.93V		
		315 = 3.08V		
		450 = 4.38V		
		475 = 4.63V		
Temperature Range:			I = -40°C to +85°C (MCP11X-195 only)	
			E = -40°C to +125°C (Except MCP11X-195 only)	
Package:				LB = SC-70, 3-lead
				MB = SOT-89, 3-lead
				TO = TO-92, 3-lead
				TT = SOT-23B, 3-lead
Examples:				
a)	MCP111T-195I/TT:	Tape and Reel, 1.95V option, open-drain, -40°C to +85°C, SOT-23B package.		
b)	MCP111T-315E/LB:	Tape and Reel, 3.15V option, open-drain, -40°C to +125°C, SC-70-3 package.		
c)	MCP111-300E/TO:	3.00V option, open-drain, -40°C to +125°C, TO-92-3 package.		
d)	MCP111-315E/MB:	3.15V option, open-drain, -40°C to +125°C, SOT-89-3 package.		
a)	MCP112T-290E/TT:	Tape and Reel, 2.90V option, push-pull, -40°C to +125°C, SOT-23B-3 package.		
b)	MCP112T-475E/LB:	Tape and Reel, 4.75V option, push-pull, -40°C to +125°C, SC-70-3 package.		
c)	MCP112-450E/TO:	4.5V option, push-pull, -40°C to +125°C, TO-92-3 package.		
d)	MCP112-315E/MB:	3.15V option, push-pull, -40°C to +125°C, SOT-89-3 package.		

MCP111/112

NOTES:

Note the following details of the code protection feature on Microchip devices:

- Microchip products meet the specification contained in their particular Microchip Data Sheet.
- Microchip believes that its family of products is one of the most secure families of its kind on the market today, when used in the intended manner and under normal conditions.
- There are dishonest and possibly illegal methods used to breach the code protection feature. All of these methods, to our knowledge, require using the Microchip products in a manner outside the operating specifications contained in Microchip's Data Sheets. Most likely, the person doing so is engaged in theft of intellectual property.
- Microchip is willing to work with the customer who is concerned about the integrity of their code.
- Neither Microchip nor any other semiconductor manufacturer can guarantee the security of their code. Code protection does not mean that we are guaranteeing the product as “unbreakable.”

Code protection is constantly evolving. We at Microchip are committed to continuously improving the code protection features of our products. Attempts to break Microchip's code protection feature may be a violation of the Digital Millennium Copyright Act. If such acts allow unauthorized access to your software or other copyrighted work, you may have a right to sue for relief under that Act.

Information contained in this publication regarding device applications and the like is provided only for your convenience and may be superseded by updates. It is your responsibility to ensure that your application meets with your specifications. MICROCHIP MAKES NO REPRESENTATIONS OR WARRANTIES OF ANY KIND WHETHER EXPRESS OR IMPLIED, WRITTEN OR ORAL, STATUTORY OR OTHERWISE, RELATED TO THE INFORMATION, INCLUDING BUT NOT LIMITED TO ITS CONDITION, QUALITY, PERFORMANCE, MERCHANTABILITY OR FITNESS FOR PURPOSE. Microchip disclaims all liability arising from this information and its use. Use of Microchip devices in life support and/or safety applications is entirely at the buyer's risk, and the buyer agrees to defend, indemnify and hold harmless Microchip from any and all damages, claims, suits, or expenses resulting from such use. No licenses are conveyed, implicitly or otherwise, under any Microchip intellectual property rights.

Trademarks

The Microchip name and logo, the Microchip logo, dsPIC, FlashFlex, KEELOQ, KEELOQ logo, MPLAB, PIC, PICmicro, PICSTART, PIC³² logo, rPIC, SST, SST Logo, SuperFlash and UNI/O are registered trademarks of Microchip Technology Incorporated in the U.S.A. and other countries.

FilterLab, Hampshire, HI-TECH C, Linear Active Thermistor, MTP, SEEVAL and The Embedded Control Solutions Company are registered trademarks of Microchip Technology Incorporated in the U.S.A.

Silicon Storage Technology is a registered trademark of Microchip Technology Inc. in other countries.

Analog-for-the-Digital Age, Application Maestro, BodyCom, chipKIT, chipKIT logo, CodeGuard, dsPICDEM, dsPICDEM.net, dsPICworks, dsSPEAK, ECAN, ECONOMONITOR, FanSense, HI-TIDE, In-Circuit Serial Programming, ICSP, Mindi, MiWi, MPASM, MPF, MPLAB Certified logo, MPLIB, MPLINK, mTouch, Omniclient Code Generation, PICC, PICC-18, PICDEM, PICDEM.net, PICkit, PICtail, REAL ICE, rLAB, Select Mode, SQI, Serial Quad I/O, Total Endurance, TSHARC, UniWinDriver, WiperLock, ZENA and Z-Scale are trademarks of Microchip Technology Incorporated in the U.S.A. and other countries.

SQTP is a service mark of Microchip Technology Incorporated in the U.S.A.

GestIC and ULPP are registered trademarks of Microchip Technology Germany II GmbH & Co. & KG, a subsidiary of Microchip Technology Inc., in other countries.

All other trademarks mentioned herein are property of their respective companies.

© 2004-2013, Microchip Technology Incorporated, Printed in the U.S.A., All Rights Reserved.

 Printed on recycled paper.

ISBN: 9781620769133

QUALITY MANAGEMENT SYSTEM
CERTIFIED BY DNV
== ISO/TS 16949 ==

Microchip received ISO/TS-16949:2009 certification for its worldwide headquarters, design and wafer fabrication facilities in Chandler and Tempe, Arizona; Gresham, Oregon and design centers in California and India. The Company's quality system processes and procedures are for its PIC[®] MCUs and dsPIC[®] DSCs, KEELOQ[®] code hopping devices, Serial EEPROMs, microperipherals, nonvolatile memory and analog products. In addition, Microchip's quality system for the design and manufacture of development systems is ISO 9001:2000 certified.



MICROCHIP

Worldwide Sales and Service

AMERICAS

Corporate Office
2355 West Chandler Blvd.
Chandler, AZ 85224-6199
Tel: 480-792-7200
Fax: 480-792-7277
Technical Support:
<http://www.microchip.com/support>
Web Address:
www.microchip.com

Atlanta
Duluth, GA
Tel: 678-957-9614
Fax: 678-957-1455

Boston
Westborough, MA
Tel: 774-760-0087
Fax: 774-760-0088

Chicago
Itasca, IL
Tel: 630-285-0071
Fax: 630-285-0075

Cleveland
Independence, OH
Tel: 216-447-0464
Fax: 216-447-0643

Dallas
Addison, TX
Tel: 972-818-7423
Fax: 972-818-2924

Detroit
Farmington Hills, MI
Tel: 248-538-2250
Fax: 248-538-2260

Indianapolis
Noblesville, IN
Tel: 317-773-8323
Fax: 317-773-5453

Los Angeles
Mission Viejo, CA
Tel: 949-462-9523
Fax: 949-462-9608

Santa Clara
Santa Clara, CA
Tel: 408-961-6444
Fax: 408-961-6445

Toronto
Mississauga, Ontario,
Canada
Tel: 905-673-0699
Fax: 905-673-6509

ASIA/PACIFIC

Asia Pacific Office
Suites 3707-14, 37th Floor
Tower 6, The Gateway
Harbour City, Kowloon
Hong Kong
Tel: 852-2401-1200
Fax: 852-2401-3431

Australia - Sydney
Tel: 61-2-9868-6733
Fax: 61-2-9868-6755

China - Beijing
Tel: 86-10-8569-7000
Fax: 86-10-8528-2104

China - Chengdu
Tel: 86-28-8665-5511
Fax: 86-28-8665-7889

China - Chongqing
Tel: 86-23-8980-9588
Fax: 86-23-8980-9500

China - Hangzhou
Tel: 86-571-2819-3187
Fax: 86-571-2819-3189

China - Hong Kong SAR
Tel: 852-2943-5100
Fax: 852-2401-3431

China - Nanjing
Tel: 86-25-8473-2460
Fax: 86-25-8473-2470

China - Qingdao
Tel: 86-532-8502-7355
Fax: 86-532-8502-7205

China - Shanghai
Tel: 86-21-5407-5533
Fax: 86-21-5407-5066

China - Shenyang
Tel: 86-24-2334-2829
Fax: 86-24-2334-2393

China - Shenzhen
Tel: 86-755-8864-2200
Fax: 86-755-8203-1760

China - Wuhan
Tel: 86-27-5980-5300
Fax: 86-27-5980-5118

China - Xian
Tel: 86-29-8833-7252
Fax: 86-29-8833-7256

China - Xiamen
Tel: 86-592-2388138
Fax: 86-592-2388130

China - Zhuhai
Tel: 86-756-3210040
Fax: 86-756-3210049

ASIA/PACIFIC

India - Bangalore
Tel: 91-80-3090-4444
Fax: 91-80-3090-4123

India - New Delhi
Tel: 91-11-4160-8631
Fax: 91-11-4160-8632

India - Pune
Tel: 91-20-2566-1512
Fax: 91-20-2566-1513

Japan - Osaka
Tel: 81-6-6152-7160
Fax: 81-6-6152-9310

Japan - Tokyo
Tel: 81-3-6880-3770
Fax: 81-3-6880-3771

Korea - Daegu
Tel: 82-53-744-4301
Fax: 82-53-744-4302

Korea - Seoul
Tel: 82-2-554-7200
Fax: 82-2-558-5932 or
82-2-558-5934

Malaysia - Kuala Lumpur
Tel: 60-3-6201-9857
Fax: 60-3-6201-9859

Malaysia - Penang
Tel: 60-4-227-8870
Fax: 60-4-227-4068

Philippines - Manila
Tel: 63-2-634-9065
Fax: 63-2-634-9069

Singapore
Tel: 65-6334-8870
Fax: 65-6334-8850

Taiwan - Hsin Chu
Tel: 886-3-5778-366
Fax: 886-3-5770-955

Taiwan - Kaohsiung
Tel: 886-7-213-7828
Fax: 886-7-330-9305

Taiwan - Taipei
Tel: 886-2-2508-8600
Fax: 886-2-2508-0102

Thailand - Bangkok
Tel: 66-2-694-1351
Fax: 66-2-694-1350

EUROPE

Austria - Wels
Tel: 43-7242-2244-39
Fax: 43-7242-2244-393

Denmark - Copenhagen
Tel: 45-4450-2828
Fax: 45-4485-2829

France - Paris
Tel: 33-1-69-53-63-20
Fax: 33-1-69-30-90-79

Germany - Munich
Tel: 49-89-627-144-0
Fax: 49-89-627-144-44

Italy - Milan
Tel: 39-0331-742611
Fax: 39-0331-466781

Netherlands - Drunen
Tel: 31-416-690399
Fax: 31-416-690340

Spain - Madrid
Tel: 34-91-708-08-90
Fax: 34-91-708-08-91

UK - Wokingham
Tel: 44-118-921-5869
Fax: 44-118-921-5820

11/29/12

Компания «Океан Электроники» предлагает заключение долгосрочных отношений при поставках импортных электронных компонентов на взаимовыгодных условиях!

Наши преимущества:

- Поставка оригинальных импортных электронных компонентов напрямую с производств Америки, Европы и Азии, а так же с крупнейших складов мира;
- Широкая линейка поставок активных и пассивных импортных электронных компонентов (более 30 млн. наименований);
- Поставка сложных, дефицитных, либо снятых с производства позиций;
- Оперативные сроки поставки под заказ (от 5 рабочих дней);
- Экспресс доставка в любую точку России;
- Помощь Конструкторского Отдела и консультации квалифицированных инженеров;
- Техническая поддержка проекта, помощь в подборе аналогов, поставка прототипов;
- Поставка электронных компонентов под контролем ВП;
- Система менеджмента качества сертифицирована по Международному стандарту ISO 9001;
- При необходимости вся продукция военного и аэрокосмического назначения проходит испытания и сертификацию в лаборатории (по согласованию с заказчиком);
- Поставка специализированных компонентов военного и аэрокосмического уровня качества (Xilinx, Altera, Analog Devices, Intersil, Interpoint, Microsemi, Actel, Aeroflex, Peregrine, VPT, Syfer, Eurofarad, Texas Instruments, MS Kennedy, Miteq, Cobham, E2V, MA-COM, Hittite, Mini-Circuits, General Dynamics и др.);

Компания «Океан Электроники» является официальным дистрибьютором и эксклюзивным представителем в России одного из крупнейших производителей разъемов военного и аэрокосмического назначения «JONHON», а так же официальным дистрибьютором и эксклюзивным представителем в России производителя высокотехнологичных и надежных решений для передачи СВЧ сигналов «FORSTAR».



JONHON

«JONHON» (основан в 1970 г.)

Разъемы специального, военного и аэрокосмического назначения:

(Применяются в военной, авиационной, аэрокосмической, морской, железнодорожной, горно- и нефтедобывающей отраслях промышленности)

«FORSTAR» (основан в 1998 г.)

ВЧ соединители, коаксиальные кабели, кабельные сборки и микроволновые компоненты:

(Применяются в телекоммуникациях гражданского и специального назначения, в средствах связи, РЛС, а так же военной, авиационной и аэрокосмической отраслях промышленности).



Телефон: 8 (812) 309-75-97 (многоканальный)

Факс: 8 (812) 320-03-32

Электронная почта: ocean@oceanchips.ru

Web: <http://oceanchips.ru/>

Адрес: 198099, г. Санкт-Петербург, ул. Калинина, д. 2, корп. 4, лит. А