

## Micropower Voltage Detector

### Features

- Ultra-low supply current: 1.75  $\mu\text{A}$  (max.)
- Precision monitoring options of:
  - 1.90V, 2.32V, 2.63V, 2.90V, 2.93V, 3.08V, 4.38V and 4.63V
- Resets microcontroller in a power-loss event
- Active-low  $V_{\text{OUT}}$  pin:
  - **MCP111** active-low, open-drain
  - **MCP112** active-low, push-pull
- Available in SOT23-3, TO-92, SC-70 and SOT-89-3 packages
- Temperature Range:
  - Extended:  $-40^{\circ}\text{C}$  to  $+125^{\circ}\text{C}$  (except **MCP1XX-195**)
  - Industrial:  $-40^{\circ}\text{C}$  to  $+85^{\circ}\text{C}$  (**MCP1XX-195** only)
- Pb-free devices

### Applications

- Critical Microcontroller and Microprocessor Power-Monitoring Applications
- Computers
- Intelligent Instruments
- Portable Battery-Powered Equipment

### Description

The MCP111/112 are voltage-detecting devices designed to keep a microcontroller in reset until the system voltage has stabilized at the appropriate level for reliable system operation. These devices also operate as protection from brown-out conditions when the system supply voltage drops below the specified threshold voltage level. Eight different trip voltages are available.

### Package Types



### Block Diagram



**TABLE 1: DEVICE FEATURES**

Device	Output		Reset Delay (typ)	Package Pin Out (Pin # 1, 2, 3)	Comment
	Type	Pull-up Resistor			
<b>MCP111</b>	Open-drain	External	No	$V_{\text{OUT}}, V_{\text{SS}}, V_{\text{DD}}$	
<b>MCP112</b>	Push-pull	No	No	$V_{\text{OUT}}, V_{\text{SS}}, V_{\text{DD}}$	
<b>MCP102</b>	Push-pull	No	120 ms	$\overline{\text{RST}}, V_{\text{DD}}, V_{\text{SS}}$	See <b>MCP102/103/121/131</b> Data Sheet (DS21906)
<b>MCP103</b>	Push-pull	No	120 ms	$V_{\text{SS}}, \overline{\text{RST}}, V_{\text{DD}}$	See <b>MCP102/103/121/131</b> Data Sheet (DS21906)
<b>MCP121</b>	Open-drain	External	120 ms	$\overline{\text{RST}}, V_{\text{DD}}, V_{\text{SS}}$	See <b>MCP102/103/121/131</b> Data Sheet (DS21906)
<b>MCP131</b>	Open-Drain	Internal (~95 $\text{k}\Omega$ )	120 ms	$\overline{\text{RST}}, V_{\text{DD}}, V_{\text{SS}}$	See <b>MCP102/103/121/131</b> Data Sheet (DS21906)

# MCP111/112

## 1.0 ELECTRICAL CHARACTERISTICS

### Absolute Maximum Ratings†

$V_{DD}$ .....	7.0V
Input current ( $V_{DD}$ ) .....	10 mA
Output current ( $\overline{RST}$ ) .....	10 mA
Rated Rise Time of $V_{DD}$ .....	100V/ $\mu$ s
All inputs and outputs (except $\overline{RST}$ ) w.r.t. $V_{SS}$ .....	-0.6V to ( $V_{DD} + 1.0V$ )
$\overline{RST}$ output w.r.t. $V_{SS}$ .....	-0.6V to 13.5V
Storage temperature .....	-65°C to +150°C
Ambient temp. with power applied .....	-40°C to +125°C
Maximum Junction temp. with power applied .....	150°C
ESD protection on all pins .....	$\geq 2$ kV

† **Notice:** Stresses above those listed under “Maximum Ratings” may cause permanent damage to the device. This is a stress rating only and functional operation of the device at those or any other conditions above those indicated in the operational listings of this specification is not implied. Exposure to maximum rating conditions for extended periods may affect device reliability.

### DC CHARACTERISTICS

<b>Electrical Specifications:</b> Unless otherwise indicated, all limits are specified for $V_{DD} = 1V$ to 5.5V, $R_{PU} = 100$ k $\Omega$ (only MCP111), $T_A = -40^\circ\text{C}$ to $+125^\circ\text{C}$ .							
Parameters	Sym	Min	Typ	Max	Units	Conditions	
Operating Voltage Range	$V_{DD}$	1.0	—	5.5	V		
Specified $V_{DD}$ Value to $V_{OUT}$ low	$V_{DD}$	1.0	—		V	$I_{\overline{RST}} = 10 \mu\text{A}$ , $V_{\overline{RST}} < 0.2V$	
Operating Current	$I_{DD}$	—	< 1	1.75	$\mu\text{A}$		
$V_{DD}$ Trip Point	MCP1XX-195	$V_{TRIP}$	1.872	1.900	1.929	V	$T_A = +25^\circ\text{C}$ (Note 1)
			1.853	1.900	1.948	V	$T_A = -40^\circ\text{C}$ to $+85^\circ\text{C}$ (Note 2)
			2.285	2.320	2.355	V	$T_A = +25^\circ\text{C}$ (Note 1)
			2.262	2.320	2.378	V	Note 2
			2.591	2.630	2.670	V	$T_A = +25^\circ\text{C}$ (Note 1)
			2.564	2.630	2.696	V	Note 2
			2.857	2.900	2.944	V	$T_A = +25^\circ\text{C}$ (Note 1)
			2.828	2.900	2.973	V	Note 2
			2.886	2.930	2.974	V	$T_A = +25^\circ\text{C}$ (Note 1)
			2.857	2.930	3.003	V	Note 2
			3.034	3.080	3.126	V	$T_A = +25^\circ\text{C}$ (Note 1)
			3.003	3.080	3.157	V	Note 2
			4.314	4.380	4.446	V	$T_A = +25^\circ\text{C}$ (Note 1)
			4.271	4.380	4.490	V	Note 2
4.561	4.630	4.700	V	$T_A = +25^\circ\text{C}$ (Note 1)			
4.514	4.630	4.746	V	Note 2			
$V_{DD}$ Trip Point Tempco	$T_{TPCO}$	—	$\pm 100$	—	ppm/ $^\circ\text{C}$		

- Note 1:** Trip point is  $\pm 1.5\%$  from typical value.  
**Note 2:** Trip point is  $\pm 2.5\%$  from typical value.  
**3:** This specification allows this device to be used in PIC<sup>®</sup> microcontroller applications that require the In-Circuit Serial Programming™ (ICSP™) feature (see device-specific programming specifications for voltage requirements). This specification DOES NOT allow a continuous high voltage to be present on the open-drain output pin ( $V_{OUT}$ ). The total time that the  $V_{OUT}$  pin can be above the maximum device operational voltage (5.5V) is 100 sec. Current into the  $V_{OUT}$  pin should be limited to 2 mA. It is recommended that the device operational temperature be maintained between 0°C to 70°C (+25°C preferred). For additional information, please refer to Figure 2-28.  
**4:** This parameter is established by characterization and is not 100% tested.

## DC CHARACTERISTICS (CONTINUED)

Electrical Specifications: Unless otherwise indicated, all limits are specified for $V_{DD} = 1V$ to $5.5V$ , $R_{PU} = 100\text{ k}\Omega$ (only <b>MCP111</b> ), $T_A = -40^\circ\text{C}$ to $+125^\circ\text{C}$ .							
Parameters	Sym	Min	Typ	Max	Units	Conditions	
Threshold Hysteresis (min. = 1%, max = 6%)	<b>MCP1XX-195</b>	$V_{HYS}$	0.019	—	0.114	V	$T_A = +25^\circ\text{C}$
	<b>MCP1XX-240</b>		0.023	—	0.139	V	
	<b>MCP1XX-270</b>		0.026	—	0.158	V	
	<b>MCP1XX-290</b>		0.029	—	0.174	V	
	<b>MCP1XX-300</b>		0.029	—	0.176	V	
	<b>MCP1XX-315</b>		0.031	—	0.185	V	
	<b>MCP1XX-450</b>		0.044	—	0.263	V	
	<b>MCP1XX-475</b>		0.046	—	0.278	V	
$V_{OUT}$ Low-level Output Voltage	$V_{OL}$	—	—	0.4	V	$I_{OL} = 500\text{ }\mu\text{A}$ , $V_{DD} = V_{TRIP(MIN)}$	
$V_{OUT}$ High-level Output Voltage	$V_{OH}$	$V_{DD} - 0.6$	—	—	V	$I_{OH} = 1\text{ mA}$ , For only <b>MCP112</b> (push-pull output)	
Open-drain High Voltage on Output	$V_{ODH}$	—	—	13.5 <sup>(3)</sup>	V	<b>MCP111</b> only, $V_{DD} = 3.0V$ , Time voltage > 5.5V applied $\leq 100s$ , current into pin limited to 2 mA, $+25^\circ\text{C}$ operation recommended <b>Note 3, Note 4</b>	
Open-drain Output Leakage Current ( <b>MCP111</b> only)	$I_{OD}$	—	0.1	—	$\mu\text{A}$		

**Note 1:** Trip point is  $\pm 1.5\%$  from typical value.

**Note 2:** Trip point is  $\pm 2.5\%$  from typical value.

**Note 3:** This specification allows this device to be used in PIC<sup>®</sup> microcontroller applications that require the In-Circuit Serial Programming<sup>™</sup> (ICSP<sup>™</sup>) feature (see device-specific programming specifications for voltage requirements). This specification DOES NOT allow a continuous high voltage to be present on the open-drain output pin ( $V_{OUT}$ ). The total time that the  $V_{OUT}$  pin can be above the maximum device operational voltage (5.5V) is 100 sec. Current into the  $V_{OUT}$  pin should be limited to 2 mA. It is recommended that the device operational temperature be maintained between  $0^\circ\text{C}$  to  $70^\circ\text{C}$  ( $+25^\circ\text{C}$  preferred). For additional information, please refer to Figure 2-28.

**Note 4:** This parameter is established by characterization and is not 100% tested.

# MCP111/112

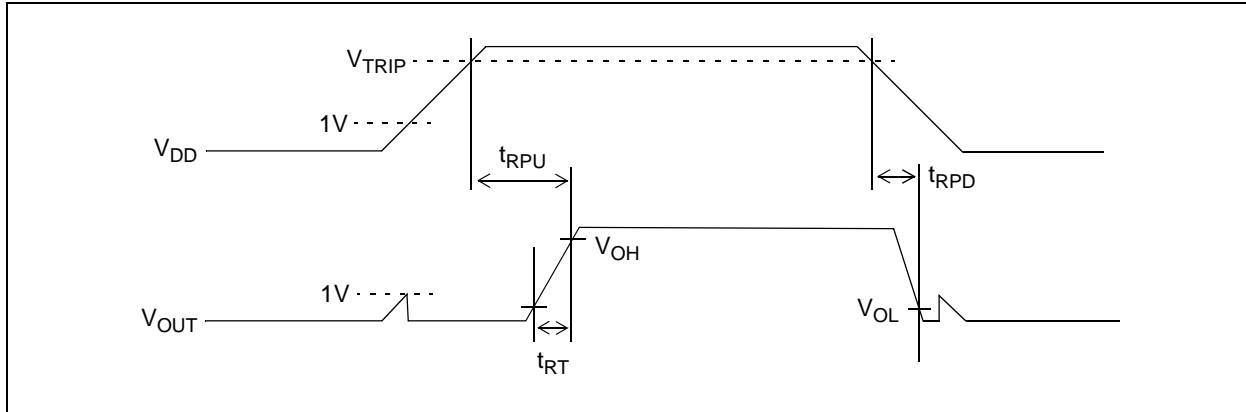

**FIGURE 1-1:** Timing Diagram.

## AC CHARACTERISTICS

**Electrical Specifications:** Unless otherwise indicated, all limits are specified for  $V_{DD} = 1V$  to  $5.5V$ ,  $R_{PU} = 100\text{ k}\Omega$  (only **MCP111**),  $T_A = -40^\circ\text{C}$  to  $+125^\circ\text{C}$ .

Parameters	Sym	Min	Typ	Max	Units	Conditions
$V_{DD}$ Detect to $V_{OUT}$ Inactive	$t_{RPU}$	—	90	—	$\mu\text{s}$	Figure 1-1 and $C_L = 50\text{ pF}$ (Note 1)
$V_{DD}$ Detect to $V_{OUT}$ Active	$t_{RPD}$	—	130	—	$\mu\text{s}$	$V_{DD}$ ramped from $V_{TRIP(MAX)} + 250\text{ mV}$ down to $V_{TRIP(MIN)} - 250\text{ mV}$ , per Figure 1-1, $C_L = 50\text{ pF}$ (Note 1)
$V_{OUT}$ Rise Time After $V_{OUT}$ Active	$t_{RT}$	—	5	—	$\mu\text{s}$	For $V_{OUT}$ 10% to 90% of final value per Figure 1-1, $C_L = 50\text{ pF}$ (Note 1)

**Note 1:** These parameters are for design guidance only and are not 100% tested.

## TEMPERATURE CHARACTERISTICS

**Electrical Specifications:** Unless otherwise noted, all limits are specified for  $V_{DD} = 1V$  to  $5.5V$ ,  $R_{PU} = 100\text{ k}\Omega$  (only **MCP111**),  $T_A = -40^\circ\text{C}$  to  $+125^\circ\text{C}$ .

Parameters	Sym	Min	Typ	Max	Units	Conditions
<b>Temperature Ranges</b>						
Specified Temperature Range	$T_A$	-40	—	+85	$^\circ\text{C}$	<b>MCP1XX-195</b>
Specified Temperature Range	$T_A$	-40	—	+125	$^\circ\text{C}$	Except <b>MCP1XX-195</b>
Maximum Junction Temperature	$T_J$	—	—	+150	$^\circ\text{C}$	
Storage Temperature Range	$T_A$	-65	—	+150	$^\circ\text{C}$	
<b>Package Thermal Resistances</b>						
Thermal Resistance, 3L-SOT23	$\theta_{JA}$	—	336	—	$^\circ\text{C/W}$	
Thermal Resistance, 3L-SC-70	$\theta_{JA}$	—	340	—	$^\circ\text{C/W}$	
Thermal Resistance, 3L-TO-92	$\theta_{JA}$	—	131.9	—	$^\circ\text{C/W}$	
Thermal Resistance, 3L-SOT-89	$\theta_{JA}$	—	110	—	$^\circ\text{C/W}$	

## 2.0 TYPICAL PERFORMANCE CURVES

**Note:** The graphs and tables provided following this note are a statistical summary based on a limited number of samples and are provided for informational purposes only. The performance characteristics listed herein are not tested or guaranteed. In some graphs or tables, the data presented may be outside the specified operating range (e.g., outside specified power supply range) and therefore outside the warranted range.

**Note:** Unless otherwise indicated, all limits are specified for  $V_{DD} = 1V$  to  $5.5V$ ,  $R_{PU} = 100\text{ k}\Omega$  (only **MCP111**; see **Figure 4-1**),  $T_A = -40^\circ\text{C}$  to  $+125^\circ\text{C}$ .

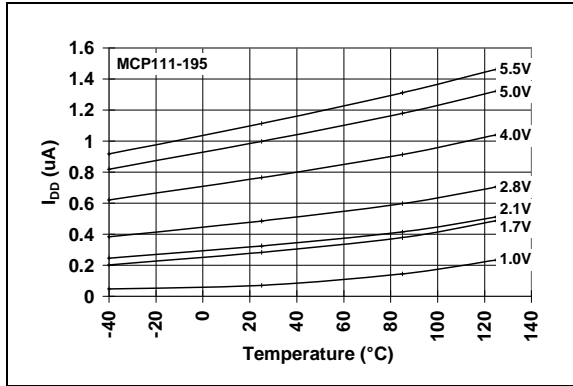

**FIGURE 2-1:**  $I_{DD}$  vs. Temperature (MCP111-195).

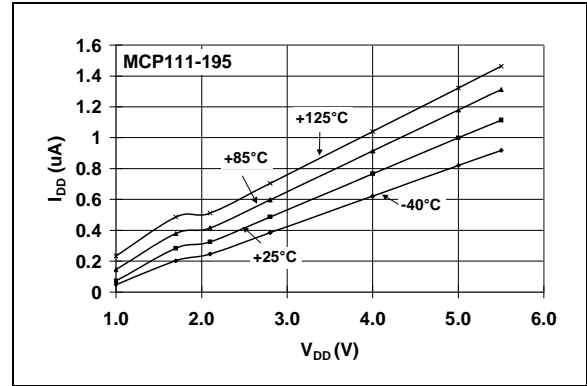

**FIGURE 2-4:**  $I_{DD}$  vs.  $V_{DD}$  (MCP111-195).

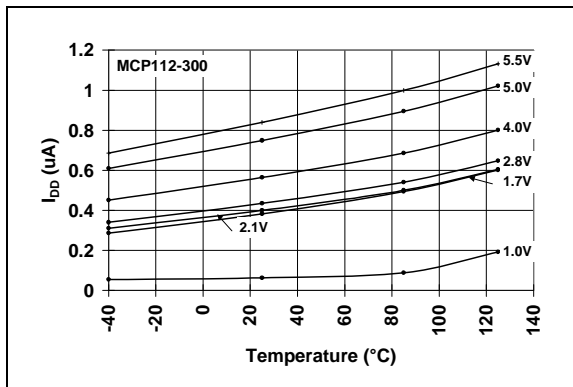

**FIGURE 2-2:**  $I_{DD}$  vs. Temperature (MCP112-300).

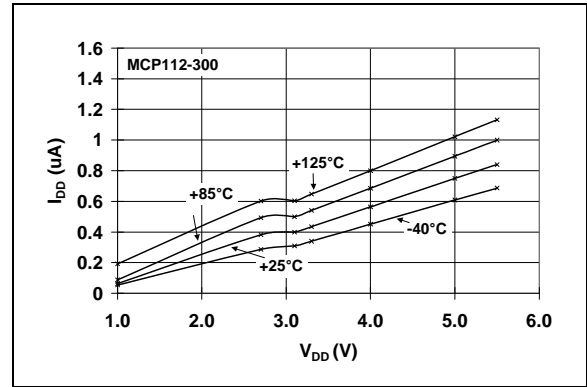

**FIGURE 2-5:**  $I_{DD}$  vs.  $V_{DD}$  (MCP112-300).

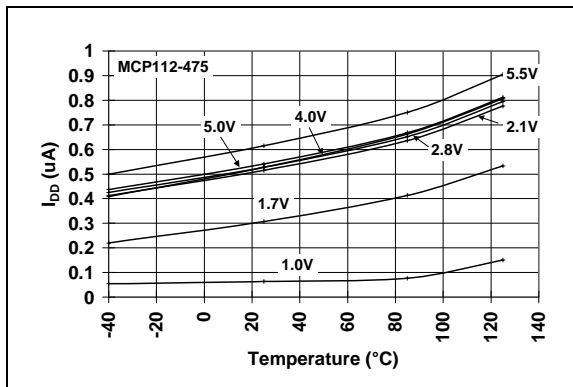

**FIGURE 2-3:**  $I_{DD}$  vs. Temperature (MCP112-475).

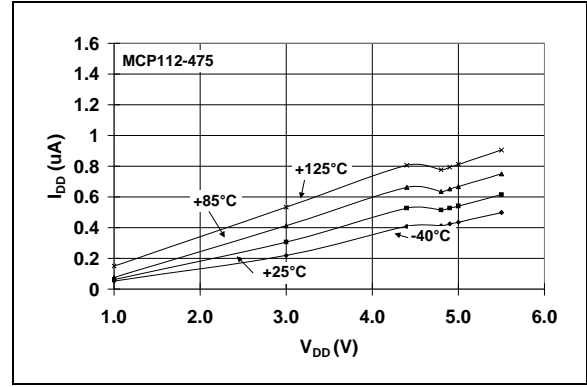

**FIGURE 2-6:**  $I_{DD}$  vs.  $V_{DD}$  (MCP112-475).

# MCP111/112

**Note:** Unless otherwise indicated, all limits are specified for  $V_{DD} = 1V$  to  $5.5V$ ,  $R_{PU} = 100\text{ k}\Omega$  (only **MCP111**); see **Figure 4-1**),  $T_A = -40^\circ\text{C}$  to  $+125^\circ\text{C}$ .



**FIGURE 2-7:**  $V_{TRIP}$  and  $V_{HYST}$  vs. Temperature (**MCP111-195**).



**FIGURE 2-10:**  $V_{OL}$  vs.  $I_{OL}$  (**MCP111-195** @  $V_{DD} = 1.7V$ ).

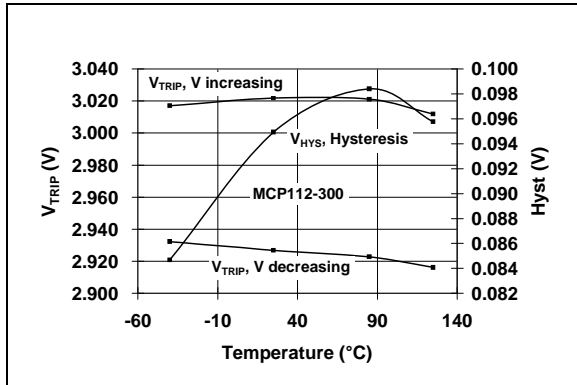

**FIGURE 2-8:**  $V_{TRIP}$  and  $V_{HYST}$  vs. Temperature (**MCP112-300**).

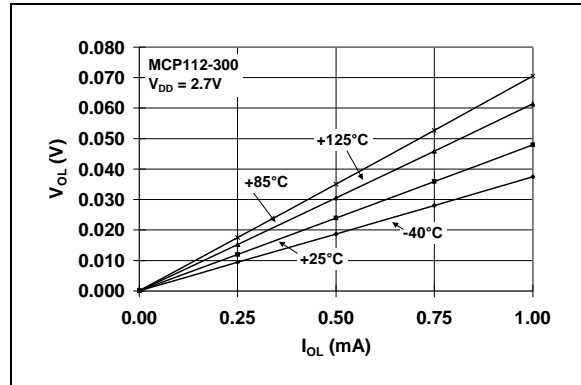

**FIGURE 2-11:**  $V_{OL}$  vs.  $I_{OL}$  (**MCP112-300** @  $V_{DD} = 2.7V$ ).



**FIGURE 2-9:**  $V_{TRIP}$  and  $V_{HYST}$  vs. Temperature (**MCP112-475**).

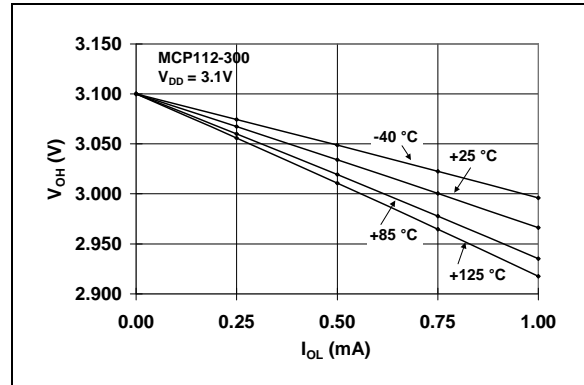

**FIGURE 2-12:**  $V_{OL}$  vs.  $I_{OL}$  (**MCP112-475** @  $V_{DD} = 4.4V$ ).

**Note:** Unless otherwise indicated, all limits are specified for  $V_{DD} = 1V$  to  $5.5V$ ,  $R_{PU} = 100\text{ k}\Omega$  (only MCP111; see Figure 4-1),  $T_A = -40^\circ\text{C}$  to  $+125^\circ\text{C}$ .



**FIGURE 2-13:**  $V_{OL}$  vs. Temperature (MCP111-195 @  $V_{DD} = 1.7V$ ).



**FIGURE 2-16:**  $V_{OH}$  vs.  $I_{OH}$  (MCP112-300 @  $V_{DD} = 3.1V$ ).



**FIGURE 2-14:**  $V_{OL}$  vs. Temperature (MCP112-300 @  $V_{DD} = 2.7V$ ).

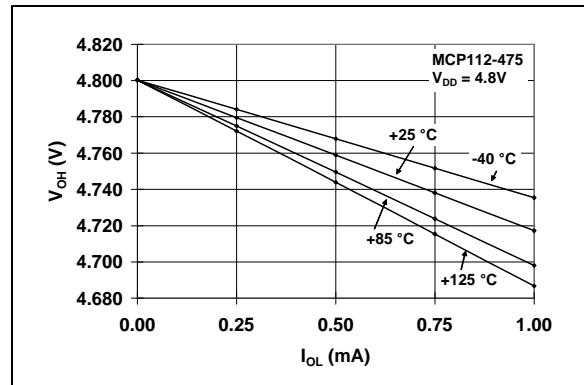

**FIGURE 2-17:**  $V_{OH}$  vs.  $I_{OH}$  (MCP112-475 @  $V_{DD} = 4.8V$ ).



**FIGURE 2-15:**  $V_{OL}$  vs. Temperature (MCP112-475 @  $V_{DD} = 4.4V$ ).

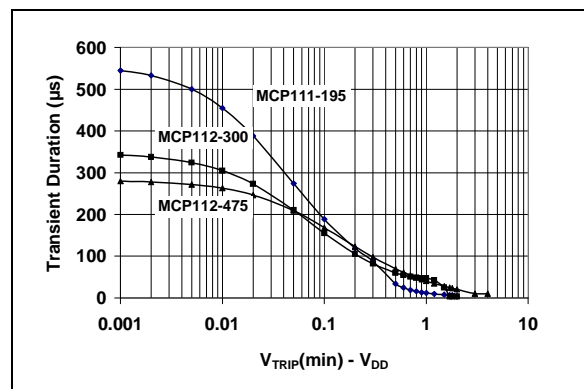

**FIGURE 2-18:** Typical Transient Response ( $25^\circ\text{C}$ ).

# MCP111/112

**Note:** Unless otherwise indicated, all limits are specified for  $V_{DD} = 1V$  to  $5.5V$ ,  $R_{PU} = 100\text{ k}\Omega$  (only MCP111; see Figure 4-1),  $T_A = -40^\circ\text{C}$  to  $+125^\circ\text{C}$ .

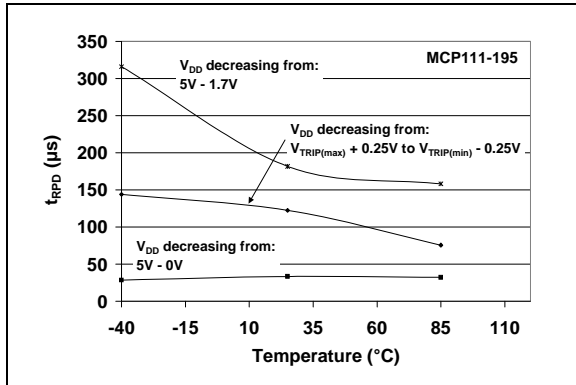

**FIGURE 2-19:**  $t_{RPD}$  vs. Temperature (MCP111-195).



**FIGURE 2-22:**  $t_{RPU}$  vs. Temperature (MCP111-195).

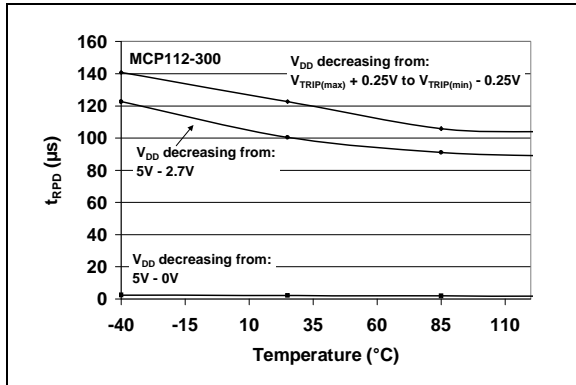

**FIGURE 2-20:**  $t_{RPD}$  vs. Temperature (MCP112-300).



**FIGURE 2-23:**  $t_{RPU}$  vs. Temperature (MCP112-300).

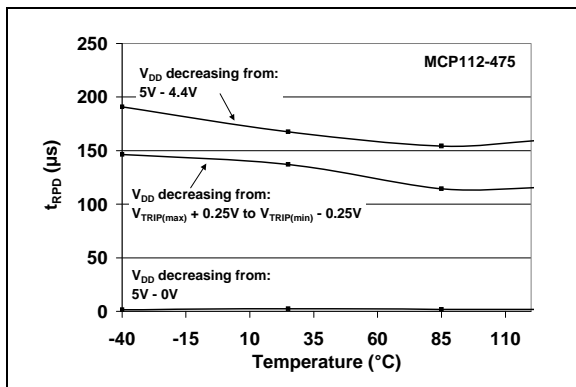

**FIGURE 2-21:**  $t_{RPD}$  vs. Temperature (MCP112-475).



**FIGURE 2-24:**  $t_{RPU}$  vs. Temperature (MCP112-475).



**Note:** Unless otherwise indicated, all limits are specified for  $V_{DD} = 1V$  to  $5.5V$ ,  $R_{PU} = 100\text{ k}\Omega$  (only MCP111; see Figure 4-1),  $T_A = -40^\circ\text{C}$  to  $+125^\circ\text{C}$ .



**FIGURE 2-25:**  $t_{RT}$  vs. Temperature (MCP111-195).



**FIGURE 2-27:**  $t_{RT}$  vs. Temperature (MCP112-475).



**FIGURE 2-26:**  $t_{RT}$  vs. Temperature (MCP112-300).



**FIGURE 2-28:** Open-Drain Leakage Current vs. Voltage Applied to  $V_{OUT}$  Pin (MCP111-195).

# MCP111/112

## 3.0 PIN DESCRIPTION

The descriptions of the pins are listed in Table 3-1.

TABLE 3-1: PIN FUNCTION TABLE

Pin No.			Symbol	Function
SOT-23-3 SC-70	SOT-89-3	T0-92		
1	1	1	$V_{OUT}$	<b>Output State</b> <b><math>V_{DD}</math> Falling:</b> $H = V_{DD} > V_{TRIP}$ $L = V_{DD} < V_{TRIP}$  <b><math>V_{DD}</math> Rising:</b> $H = V_{DD} > V_{TRIP} + V_{HYS}$ $L = V_{DD} < V_{TRIP} + V_{HYS}$
2	2	3	$V_{SS}$	Ground reference
3	3	2	$V_{DD}$	Positive power supply
—	4	—	$V_{DD}$	Positive power supply

## 4.0 APPLICATION INFORMATION

For many of today's microcontroller applications, care must be taken to prevent low-power conditions that can cause many different system-power problems. The most common causes are brown-out conditions, where the system supply drops below the operating level momentarily. The second most common cause is when a slowly decaying power supply causes the microcontroller to begin executing instructions without sufficient voltage to sustain SRAM, thus producing indeterminate results. Figure 4-1 shows a typical application circuit.



**FIGURE 4-1:** Typical Application Circuit.

## 4.1 $V_{TRIP}$ Operation

The voltage trip point ( $V_{TRIP}$ ) is determined on the falling edge of  $V_{DD}$ . The actual voltage trip point ( $V_{TRIPAC}$ ) will be between the minimum trip point ( $V_{TRIPMIN}$ ) and the maximum trip point ( $V_{TRIPMAX}$ ). There is a hysteresis on this trip point to remove any "jitter" that would occur on the  $V_{OUT}$  pin when the device  $V_{DD}$  is at the trip point.

Figure 4-2 shows the state of the  $V_{OUT}$  pin as determined by the  $V_{DD}$  voltage. The  $V_{TRIP}$  specification is for falling  $V_{DD}$  voltages. When the  $V_{DD}$  voltage is rising, the  $V_{OUT}$  pin will not be driven high until  $V_{DD}$  is at  $V_{TRIP} + V_{HYS}$ .



**FIGURE 4-2:**  $V_{OUT}$  Operation as Determined by the  $V_{TRIP}$  and  $V_{HYS}$ .

# MCP111/112

## 4.2 Negative Going $V_{DD}$ Transients

The minimum pulse width (time) required to cause a reset may be an important criteria in the implementation of a Power-on Reset (POR) circuit. This time is referred to as transient duration, defined as the amount of time needed for these supervisory devices to respond to a drop in  $V_{DD}$ . The transient duration time is dependant on the magnitude of  $V_{TRIP} - V_{DD}$ . Generally speaking, the transient duration decreases with increases in  $V_{TRIP} - V_{DD}$ .

Figure 4-3 shows a typical transient duration vs. reset comparator overdrive for which the MCP111/112 will not generate a reset pulse. It shows that the farther below the trip point the transient pulse goes, the duration of the pulse required to cause a reset gets shorter. Figure 2-18 shows the transient response characteristics for the MCP111/112.

A 0.1  $\mu\text{F}$  bypass capacitor, mounted as close as possible to the  $V_{DD}$  pin, provides additional transient immunity (refer to Figure 4-1).



**FIGURE 4-3:** Example of Typical Transient Duration Waveform.

## 4.3 Effect of Temperature on Time-out Period ( $t_{RPU}$ )

The time-out period ( $t_{RPU}$ ) determines how long the device remains in the reset condition. This is affected by both  $V_{DD}$  and temperature. The graph shown in Figures 2-22, 2-23 and 2-24 show the typical response for different  $V_{DD}$  values and temperatures.

## 4.4 Using in PIC<sup>®</sup> Microcontroller ICSP<sup>™</sup> Applications (MCP111 only)

Figure 4-4 shows the typical application circuit for using the MCP111 for voltage supervisory function when the PIC microcontroller will be programmed via the In-Circuit Serial Programming<sup>™</sup> (ICSP) feature. Additional information is available in TB087, "Using Voltage Supervisors with PIC<sup>®</sup> Microcontroller Systems which Implement In-Circuit Serial Programming<sup>™</sup>", DS91087.

**Note:** It is recommended that the current into the  $\overline{\text{RST}}$  pin be current limited by a 1 k $\Omega$  resistor.

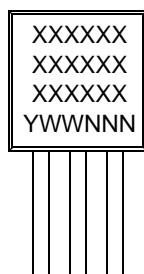

**FIGURE 4-4:** Typical Application Circuit for PIC<sup>®</sup> Microcontroller with the ICSP<sup>™</sup> feature.

## 5.0 PACKAGING INFORMATION

### 5.1 Package Marking Information

3-Lead TO-92



Example:

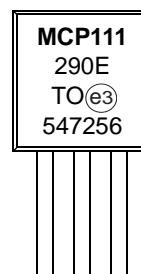

3-Pin SOT-23

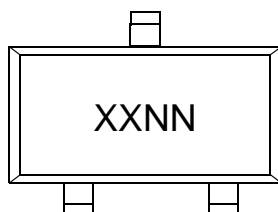

Example:

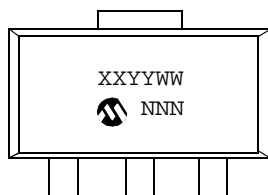

Part Number	SOT-23	Part Number	SOT-23
MCP111T-195I/TT	MPNN	MCP112T-195I/TT	MRNN
MCP111T-240ETT	MQNN	MCP112T-240ETT	MSNN
MCP111T-270E/TT	MGNN	MCP112T-270E/TT	MANN
MCP111T-290E/TT	NHNN	MCP112T-290E/TT	MBNN
MCP111T-300E/TT	MJNN	MCP112T-300E/TT	MCNN
MCP111T-315E/TT	MKNN	MCP112T-315E/TT	MDNN
MCP111T-450E/TT	MLNN	MCP112T-450E/TT	MENN
MCP111T-475E/TT	MMNN	MCP112T-475E/TT	MFNN

3-Pin SOT-89



Example:

Part Number	SOT-89	Part Number	SOT-89
MCP111T-195I/MB	MP	MCP112T-195I/MB	MR
MCP111T-240EMB	MQ	MCP112T-240EMB	MS
MCP111T-270E/MB	MG	MCP112T-270E/MB	MA
MCP111T-290E/MB	NH	MCP112T-290E/MB	MB
MCP111T-300E/MB	MJ	MCP112T-300E/MB	MC
MCP111T-315E/MB	MK	MCP112T-315E/MB	MD
MCP111T-450E/MB	ML	MCP112T-450E/MB	ME
MCP111T-475E/MB	MM	MCP112T-475E/MB	MF

**Legend:** XX...X Customer-specific information  
 Y Year code (last digit of calendar year)  
 WW Week code (week of January 1 is week '01')  
 NNN Alphanumeric traceability code  
 Pb-free JEDEC designator for Matte Tin (Sn)  
 \* This package is Pb-free. The Pb-free JEDEC designator () can be found on the outer packaging for this package.

**Note:** In the event the full Microchip part number cannot be marked on one line, it will be carried over to the next line, thus limiting the number of available characters for customer-specific information.

# MCP111/112

## Package Marking Information (Continued)

3-Pin SC-70

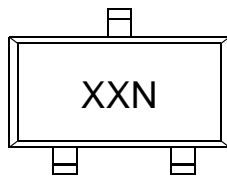

Top Side

**OR**

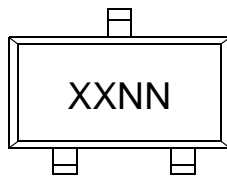

Top Side

Example:

Part Number	SC-70	Part Number	SC-70
MCP111T-195I/LB	EPN	MCP112T-195I/LB	ERN
MCP111T-240E/LB	EQN	MCP112T-240E/LB	ESN
MCP111T-270E/LB	EGN	MCP112T-270E/LB	EAN
MCP111T-290E/LB	EHN	MCP112T-290E/LB	EBN
MCP111T-300E/LB	EJN	MCP112T-300E/LB	ECN
MCP111T-315E/LB	EKN	MCP112T-315E/LB	EDN
MCP111T-450E/LB	ELN	MCP112T-450E/LB	EEN
MCP111T-475E/LB	EMN	MCP112T-475E/LB	EFN

Example:

Part Number	SC-70	Part Number	SC-70
MCP111T-195I/LB	EPNN	MCP112T-195I/LB	ERNN
MCP111T-240E/LB	EQNN	MCP112T-240E/LB	ESNN
MCP111T-270E/LB	EGNN	MCP112T-270E/LB	EANN
MCP111T-290E/LB	EHNN	MCP112T-290E/LB	EBNN
MCP111T-300E/LB	EJNN	MCP112T-300E/LB	ECNN
MCP111T-315E/LB	EKNN	MCP112T-315E/LB	EDNN
MCP111T-450E/LB	ELNN	MCP112T-450E/LB	EENN
MCP111T-475E/LB	EMNN	MCP112T-475E/LB	EFNN

## 3-Lead Plastic Small Outline Transistor (MB) (SOT89)

**Note:** For the most current package drawings, please see the Microchip Packaging Specification located at <http://www.microchip.com/packaging>



Dimension Limits	Units	INCHES		MILLIMETERS*	
		MIN	MAX	MIN	MAX
Pitch	p	.059 BSC		1.50 BSC	
Outside lead pitch (basic)	p1	.118 BSC		3.00 BSC	
Overall Height	A	.055	.063	1.40	1.60
Overall Width	H	.155	.167	3.94	4.25
Molded Package Width at Base	E	.090	.102	2.29	2.60
Molded Package Width at Top	E1	.084	.090	2.13	2.29
Overall Length	D	.173	.181	4.40	4.60
Tab Length	D1	.064	.072	1.62	1.83
Tab Corner Radii	R	.010		0.254	
Foot Length	L	.035	.047	0.89	1.20
Lead Thickness	c	.014	.017	0.35	0.44
Lead 2 Width	B	.017	.022	0.43	0.56
Leads 1 & 3 Width	B1	.014	.019	0.36	0.48

\*Controlling Parameter

Notes:

Dimensions D and E1 do not include mold or flash protrusions. Mold flash or protrusions shall not exceed .005" (0.127mm) per side.

JEDEC Equivalent: TO-243

Drawing No. C04-29

Revised 07-24-03

# MCP111/112

## 3-Lead Plastic Small Outline Transistor (TT) (SOT-23)

**Note:** For the most current package drawings, please see the Microchip Packaging Specification located at <http://www.microchip.com/packaging>



Dimension Limits	Units	INCHES*			MILLIMETERS		
		MIN	NOM	MAX	MIN	NOM	MAX
Number of Pins	n		3			3	
Pitch	p		.038			0.96	
Outside lead pitch (basic)	p1		.076			1.92	
Overall Height	A	.035	.040	.044	0.89	1.01	1.12
Molded Package Thickness	A2	.035	.037	.040	0.88	0.95	1.02
Standoff §	A1	.000	.002	.004	0.01	0.06	0.10
Overall Width	E	.083	.093	.104	2.10	2.37	2.64
Molded Package Width	E1	.047	.051	.055	1.20	1.30	1.40
Overall Length	D	.110	.115	.120	2.80	2.92	3.04
Foot Length	L	.014	.018	.022	0.35	0.45	0.55
Foot Angle	φ	0	5	10	0	5	10
Lead Thickness	c	.004	.006	.007	0.09	0.14	0.18
Lead Width	B	.015	.017	.020	0.37	0.44	0.51
Mold Draft Angle Top	α	0	5	10	0	5	10
Mold Draft Angle Bottom	β	0	5	10	0	5	10

\* Controlling Parameter

§ Significant Characteristic

Notes:

Dimensions D and E1 do not include mold flash or protrusions. Mold flash or protrusions shall not exceed .010" (0.254mm) per side.

JEDEC Equivalent: TO-236

Drawing No. C04-104



## 3-Lead Plastic Small Outline Transistor (LB) (SC-70)

**Note:** For the most current package drawings, please see the Microchip Packaging Specification located at <http://www.microchip.com/packaging>



Dimension Limits	Units	INCHES		MILLIMETERS*	
		MIN	MAX	MIN	MAX
Number of Pins		3		3	
Pitch	P	.026 BSC.		0.65 BSC.	
Outside lead pitch (basic)	p1	.051 BSC.		1.30 BSC.	
Overall Height	A	.031	.043	0.80	1.10
Molded Package Thickness	A2	.031	.039	0.80	1.00
Standoff	A1	.000	.0004	0.00	.010
Overall Width	E	.071	.094	1.80	2.40
Molded Package Width	E1	.045	.053	1.15	1.35
Overall Length	D	.071	.089	1.80	2.25
Foot Length	L	.004	.016	0.10	0.41
Lead Thickness	c	.003	.010	0.08	0.25
Lead Width	B	.006	.016	0.15	0.40
Mold Draft Angle Top	a	8°	12°	8°	12°
Mold Draft Angle Bottom	b	8°	12°	8°	12°

\*Controlling Parameter

Notes:

Dimensions D and E1 do not include mold flash or protrusions. Mold flash or protrusions shall not exceed .005" (0.127mm) per side.

JEITA (EIAJ) Equivalent: SC70

Drawing No. C04-104

# MCP111/112

## 3-Lead Plastic Transistor Outline (TO) (TO-92)

**Note:** For the most current package drawings, please see the Microchip Packaging Specification located at <http://www.microchip.com/packaging>

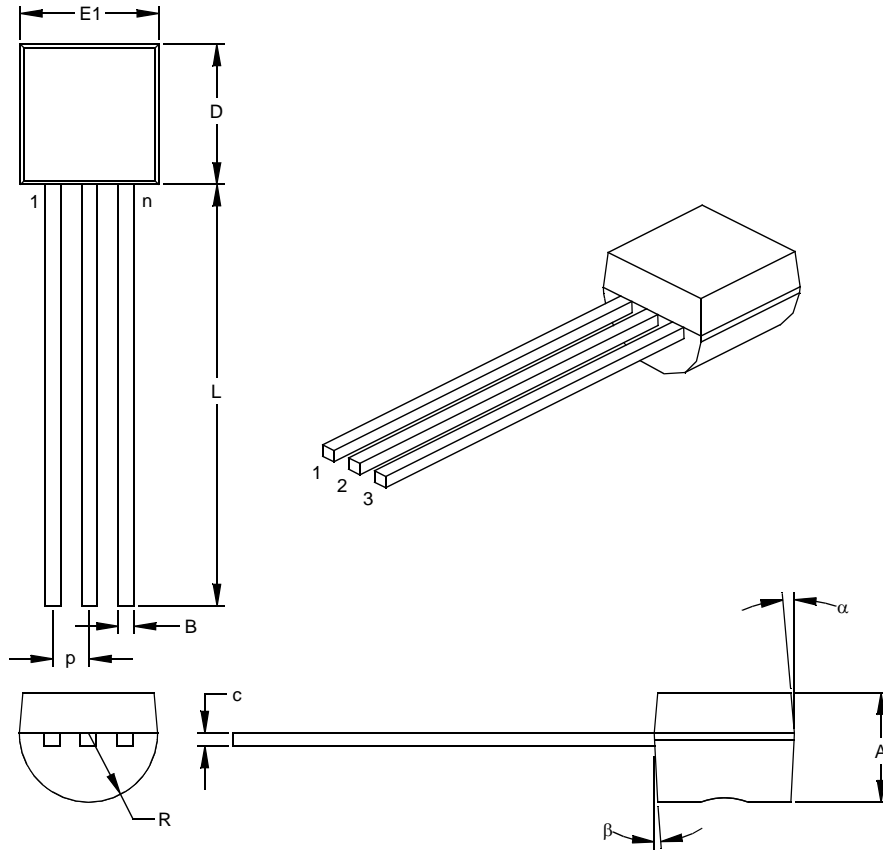

Dimension Limits	Units	INCHES*			MILLIMETERS		
		MIN	NOM	MAX	MIN	NOM	MAX
Number of Pins	n		3			3	
Pitch	p		.050			1.27	
Bottom to Package Flat	A	.130	.143	.155	3.30	3.62	3.94
Overall Width	E1	.175	.186	.195	4.45	4.71	4.95
Overall Length	D	.170	.183	.195	4.32	4.64	4.95
Molded Package Radius	R	.085	.090	.095	2.16	2.29	2.41
Tip to Seating Plane	L	.500	.555	.610	12.70	14.10	15.49
Lead Thickness	c	.014	.017	.020	0.36	0.43	0.51
Lead Width	B	.016	.019	.022	0.41	0.48	0.56
Mold Draft Angle Top	$\alpha$	4	5	6	4	5	6
Mold Draft Angle Bottom	$\beta$	2	3	4	2	3	4

\*Controlling Parameter

Notes:

Dimensions D and E1 do not include mold flash or protrusions. Mold flash or protrusions shall not exceed .010" (0.254mm) per side.

JEDEC Equivalent: TO-92

Drawing No. C04-101

## 5.2 Product Tape and Reel Specifications

**FIGURE 5-1: EMBOSSED CARRIER DIMENSIONS (8, 12, 16 AND 24 MM TAPE ONLY)**

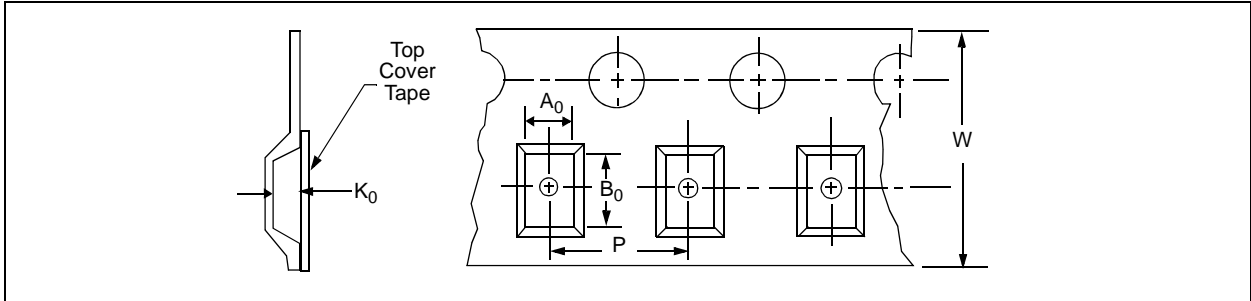

**TABLE 1: CARRIER TAPE/CAVITY DIMENSIONS**

Case Outline	Package Type		Carrier Dimensions		Cavity Dimensions			Output Quantity Units	Reel Diameter in mm
			W mm	P mm	A0 mm	B0 mm	K0 mm		
TT	SOT-23B	3L	8	4	3.15	2.77	1.22	3000	180
LB	SC-70	3L	8	4	2.4	2.4	1.19	3000	180

**FIGURE 5-2: 3-LEAD SOT-23/SC70 DEVICE TAPE AND REEL SPECIFICATIONS**

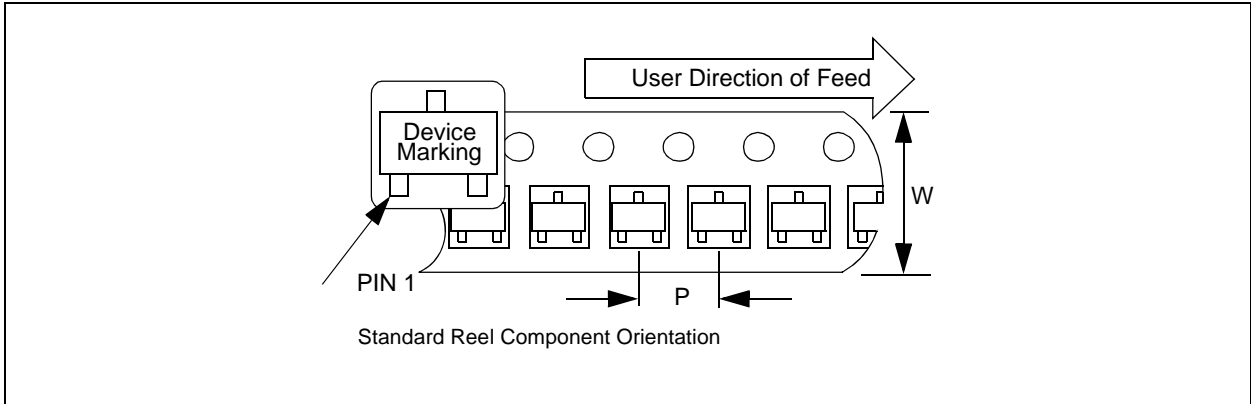

# MCP111/112

FIGURE 5-3: TO-92 DEVICES



FIGURE 5-4: SOT-89 DEVICES

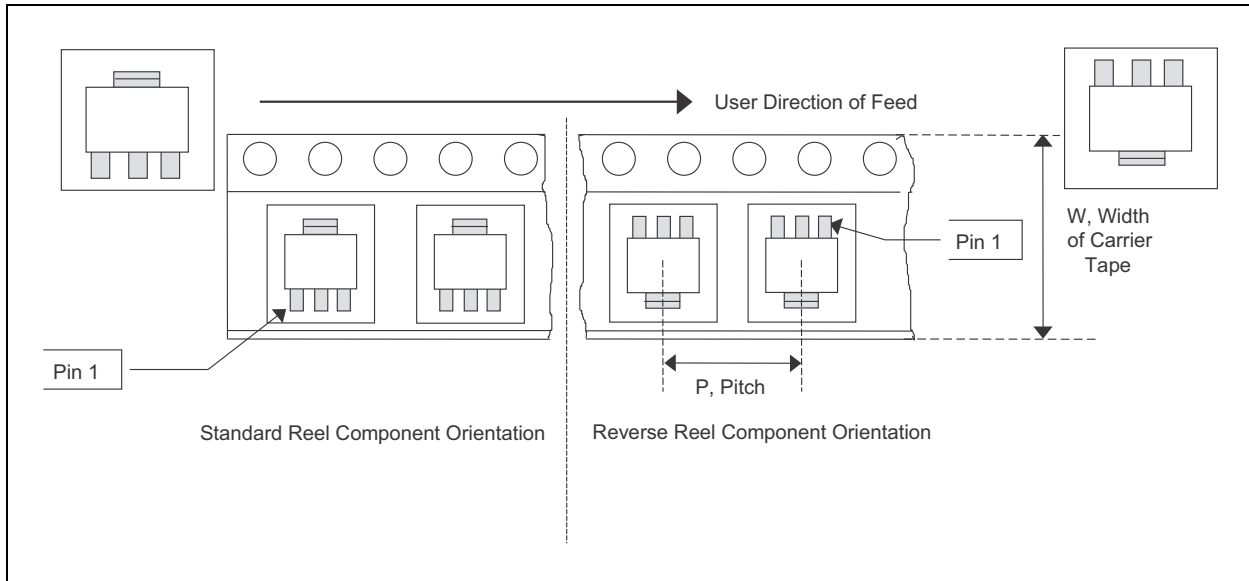

## APPENDIX A: REVISION HISTORY

### Revision E (January 2013)

- Added a note to each package outline drawing.

### Revision D (June 2005)

1. Added SOT-89-3 package information throughout.

### Revision C (March 2005)

The following is the list of modifications:

1. Added **Section 4.4 “Using in PIC® Microcontroller ICSP™ Applications (MCP111 only)”** on using the MCP111 in PIC microcontroller ICSP applications.
2. Added  $V_{ODH}$  specifications in **Section 1.0 “Electrical Characteristics”** (for ICSP applications).
3. Added Figure 2-28.
4. Added devices features table to page 1.
5. Updated SC-70 package markings and added Pb-free marking information to **Section 5.0 “Packaging information”**.
6. Added **Appendix A: “Revision History”**.

### Revision B (August 2004)

1. Corrected package marking information in **Section 5.0 “Packaging information”**

### Revision A (May 2004)

- Original Release of this Document.

# MCP111/112

---

NOTES:

## PRODUCT IDENTIFICATION SYSTEM

To order or obtain information, e.g., on pricing or delivery, refer to the factory or the listed sales office.

<u>PART NO.</u>	<u>X</u>	<u>XXX</u>	<u>X</u>	<u>XX</u>
Device	Tape/Reel Option	Monitoring Options	Temperature Range	Package
Device:				
		MCP111: MicroPower Voltage Detector, open-drain		
		MCP111T: MicroPower Voltage Detector, open-drain (Tape and Reel)		
		MCP112: MicroPower Voltage Detector, push-pull		
		MCP112T: MicroPower Voltage Detector, push-pull (Tape and Reel)		
Monitoring Options:		195 = 1.90V		
		240 = 2.32V		
		270 = 2.63V		
		290 = 2.90V		
		300 = 2.93V		
		315 = 3.08V		
		450 = 4.38V		
		475 = 4.63V		
Temperature Range:			I = -40°C to +85°C (MCP11X-195 only)	
			E = -40°C to +125°C (Except MCP11X-195 only)	
Package:				LB = SC-70, 3-lead
				MB = SOT-89, 3-lead
				TO = TO-92, 3-lead
				TT = SOT-23B, 3-lead
<b>Examples:</b>				
a)	MCP111T-195I/TT:	Tape and Reel, 1.95V option, open-drain, -40°C to +85°C, SOT-23B package.		
b)	MCP111T-315E/LB:	Tape and Reel, 3.15V option, open-drain, -40°C to +125°C, SC-70-3 package.		
c)	MCP111-300E/TO:	3.00V option, open-drain, -40°C to +125°C, TO-92-3 package.		
d)	MCP111-315E/MB:	3.15V option, open-drain, -40°C to +125°C, SOT-89-3 package.		
a)	MCP112T-290E/TT:	Tape and Reel, 2.90V option, push-pull, -40°C to +125°C, SOT-23B-3 package.		
b)	MCP112T-475E/LB:	Tape and Reel, 4.75V option, push-pull, -40°C to +125°C, SC-70-3 package.		
c)	MCP112-450E/TO:	4.5V option, push-pull, -40°C to +125°C, TO-92-3 package.		
d)	MCP112-315E/MB:	3.15V option, push-pull, -40°C to +125°C, SOT-89-3 package.		

# MCP111/112

---

NOTES:



---

**Note the following details of the code protection feature on Microchip devices:**

- Microchip products meet the specification contained in their particular Microchip Data Sheet.
- Microchip believes that its family of products is one of the most secure families of its kind on the market today, when used in the intended manner and under normal conditions.
- There are dishonest and possibly illegal methods used to breach the code protection feature. All of these methods, to our knowledge, require using the Microchip products in a manner outside the operating specifications contained in Microchip's Data Sheets. Most likely, the person doing so is engaged in theft of intellectual property.
- Microchip is willing to work with the customer who is concerned about the integrity of their code.
- Neither Microchip nor any other semiconductor manufacturer can guarantee the security of their code. Code protection does not mean that we are guaranteeing the product as “unbreakable.”

Code protection is constantly evolving. We at Microchip are committed to continuously improving the code protection features of our products. Attempts to break Microchip's code protection feature may be a violation of the Digital Millennium Copyright Act. If such acts allow unauthorized access to your software or other copyrighted work, you may have a right to sue for relief under that Act.

---

Information contained in this publication regarding device applications and the like is provided only for your convenience and may be superseded by updates. It is your responsibility to ensure that your application meets with your specifications. MICROCHIP MAKES NO REPRESENTATIONS OR WARRANTIES OF ANY KIND WHETHER EXPRESS OR IMPLIED, WRITTEN OR ORAL, STATUTORY OR OTHERWISE, RELATED TO THE INFORMATION, INCLUDING BUT NOT LIMITED TO ITS CONDITION, QUALITY, PERFORMANCE, MERCHANTABILITY OR FITNESS FOR PURPOSE. Microchip disclaims all liability arising from this information and its use. Use of Microchip devices in life support and/or safety applications is entirely at the buyer's risk, and the buyer agrees to defend, indemnify and hold harmless Microchip from any and all damages, claims, suits, or expenses resulting from such use. No licenses are conveyed, implicitly or otherwise, under any Microchip intellectual property rights.

#### **Trademarks**

The Microchip name and logo, the Microchip logo, dsPIC, FlashFlex, KEELOQ, KEELOQ logo, MPLAB, PIC, PICmicro, PICSTART, PIC<sup>32</sup> logo, rPIC, SST, SST Logo, SuperFlash and UNI/O are registered trademarks of Microchip Technology Incorporated in the U.S.A. and other countries.

FilterLab, Hampshire, HI-TECH C, Linear Active Thermistor, MTP, SEEVAL and The Embedded Control Solutions Company are registered trademarks of Microchip Technology Incorporated in the U.S.A.

Silicon Storage Technology is a registered trademark of Microchip Technology Inc. in other countries.

Analog-for-the-Digital Age, Application Maestro, BodyCom, chipKIT, chipKIT logo, CodeGuard, dsPICDEM, dsPICDEM.net, dsPICworks, dsSPEAK, ECAN, ECONOMONITOR, FanSense, HI-TIDE, In-Circuit Serial Programming, ICSP, Mindi, MiWi, MPASM, MPF, MPLAB Certified logo, MPLIB, MPLINK, mTouch, Omniclient Code Generation, PICC, PICC-18, PICDEM, PICDEM.net, PICkit, PICTail, REAL ICE, rLAB, Select Mode, SQI, Serial Quad I/O, Total Endurance, TSHARC, UniWinDriver, WiperLock, ZENA and Z-Scale are trademarks of Microchip Technology Incorporated in the U.S.A. and other countries.

SQTP is a service mark of Microchip Technology Incorporated in the U.S.A.

GestIC and ULPP are registered trademarks of Microchip Technology Germany II GmbH & Co. & KG, a subsidiary of Microchip Technology Inc., in other countries.

All other trademarks mentioned herein are property of their respective companies.

© 2004-2013, Microchip Technology Incorporated, Printed in the U.S.A., All Rights Reserved.

 Printed on recycled paper.

ISBN: 9781620769133

*Microchip received ISO/TS-16949:2009 certification for its worldwide headquarters, design and wafer fabrication facilities in Chandler and Tempe, Arizona; Gresham, Oregon and design centers in California and India. The Company's quality system processes and procedures are for its PIC<sup>®</sup> MCUs and dsPIC<sup>®</sup> DSCs, KEELOQ<sup>®</sup> code hopping devices, Serial EEPROMs, microperipherals, nonvolatile memory and analog products. In addition, Microchip's quality system for the design and manufacture of development systems is ISO 9001:2000 certified.*

**QUALITY MANAGEMENT SYSTEM  
CERTIFIED BY DNV  
= ISO/TS 16949 =**



# MICROCHIP

## Worldwide Sales and Service

### AMERICAS

**Corporate Office**  
2355 West Chandler Blvd.  
Chandler, AZ 85224-6199  
Tel: 480-792-7200  
Fax: 480-792-7277  
Technical Support:  
<http://www.microchip.com/support>  
Web Address:  
[www.microchip.com](http://www.microchip.com)

**Atlanta**  
Duluth, GA  
Tel: 678-957-9614  
Fax: 678-957-1455

**Boston**  
Westborough, MA  
Tel: 774-760-0087  
Fax: 774-760-0088

**Chicago**  
Itasca, IL  
Tel: 630-285-0071  
Fax: 630-285-0075

**Cleveland**  
Independence, OH  
Tel: 216-447-0464  
Fax: 216-447-0643

**Dallas**  
Addison, TX  
Tel: 972-818-7423  
Fax: 972-818-2924

**Detroit**  
Farmington Hills, MI  
Tel: 248-538-2250  
Fax: 248-538-2260

**Indianapolis**  
Noblesville, IN  
Tel: 317-773-8323  
Fax: 317-773-5453

**Los Angeles**  
Mission Viejo, CA  
Tel: 949-462-9523  
Fax: 949-462-9608

**Santa Clara**  
Santa Clara, CA  
Tel: 408-961-6444  
Fax: 408-961-6445

**Toronto**  
Mississauga, Ontario,  
Canada  
Tel: 905-673-0699  
Fax: 905-673-6509

### ASIA/PACIFIC

**Asia Pacific Office**  
Suites 3707-14, 37th Floor  
Tower 6, The Gateway  
Harbour City, Kowloon  
Hong Kong  
Tel: 852-2401-1200  
Fax: 852-2401-3431

**Australia - Sydney**  
Tel: 61-2-9868-6733  
Fax: 61-2-9868-6755

**China - Beijing**  
Tel: 86-10-8569-7000  
Fax: 86-10-8528-2104

**China - Chengdu**  
Tel: 86-28-8665-5511  
Fax: 86-28-8665-7889

**China - Chongqing**  
Tel: 86-23-8980-9588  
Fax: 86-23-8980-9500

**China - Hangzhou**  
Tel: 86-571-2819-3187  
Fax: 86-571-2819-3189

**China - Hong Kong SAR**  
Tel: 852-2943-5100  
Fax: 852-2401-3431

**China - Nanjing**  
Tel: 86-25-8473-2460  
Fax: 86-25-8473-2470

**China - Qingdao**  
Tel: 86-532-8502-7355  
Fax: 86-532-8502-7205

**China - Shanghai**  
Tel: 86-21-5407-5533  
Fax: 86-21-5407-5066

**China - Shenyang**  
Tel: 86-24-2334-2829  
Fax: 86-24-2334-2393

**China - Shenzhen**  
Tel: 86-755-8864-2200  
Fax: 86-755-8203-1760

**China - Wuhan**  
Tel: 86-27-5980-5300  
Fax: 86-27-5980-5118

**China - Xian**  
Tel: 86-29-8833-7252  
Fax: 86-29-8833-7256

**China - Xiamen**  
Tel: 86-592-2388138  
Fax: 86-592-2388130

**China - Zhuhai**  
Tel: 86-756-3210040  
Fax: 86-756-3210049

### ASIA/PACIFIC

**India - Bangalore**  
Tel: 91-80-3090-4444  
Fax: 91-80-3090-4123

**India - New Delhi**  
Tel: 91-11-4160-8631  
Fax: 91-11-4160-8632

**India - Pune**  
Tel: 91-20-2566-1512  
Fax: 91-20-2566-1513

**Japan - Osaka**  
Tel: 81-6-6152-7160  
Fax: 81-6-6152-9310

**Japan - Tokyo**  
Tel: 81-3-6880-3770  
Fax: 81-3-6880-3771

**Korea - Daegu**  
Tel: 82-53-744-4301  
Fax: 82-53-744-4302

**Korea - Seoul**  
Tel: 82-2-554-7200  
Fax: 82-2-558-5932 or  
82-2-558-5934

**Malaysia - Kuala Lumpur**  
Tel: 60-3-6201-9857  
Fax: 60-3-6201-9859

**Malaysia - Penang**  
Tel: 60-4-227-8870  
Fax: 60-4-227-4068

**Philippines - Manila**  
Tel: 63-2-634-9065  
Fax: 63-2-634-9069

**Singapore**  
Tel: 65-6334-8870  
Fax: 65-6334-8850

**Taiwan - Hsin Chu**  
Tel: 886-3-5778-366  
Fax: 886-3-5770-955

**Taiwan - Kaohsiung**  
Tel: 886-7-213-7828  
Fax: 886-7-330-9305

**Taiwan - Taipei**  
Tel: 886-2-2508-8600  
Fax: 886-2-2508-0102

**Thailand - Bangkok**  
Tel: 66-2-694-1351  
Fax: 66-2-694-1350

### EUROPE

**Austria - Wels**  
Tel: 43-7242-2244-39  
Fax: 43-7242-2244-393

**Denmark - Copenhagen**  
Tel: 45-4450-2828  
Fax: 45-4485-2829

**France - Paris**  
Tel: 33-1-69-53-63-20  
Fax: 33-1-69-30-90-79

**Germany - Munich**  
Tel: 49-89-627-144-0  
Fax: 49-89-627-144-44

**Italy - Milan**  
Tel: 39-0331-742611  
Fax: 39-0331-466781

**Netherlands - Drunen**  
Tel: 31-416-690399  
Fax: 31-416-690340

**Spain - Madrid**  
Tel: 34-91-708-08-90  
Fax: 34-91-708-08-91

**UK - Wokingham**  
Tel: 44-118-921-5869  
Fax: 44-118-921-5820

11/29/12

Компания «Океан Электроники» предлагает заключение долгосрочных отношений при поставках импортных электронных компонентов на взаимовыгодных условиях!

Наши преимущества:

- Поставка оригинальных импортных электронных компонентов напрямую с производств Америки, Европы и Азии, а так же с крупнейших складов мира;
- Широкая линейка поставок активных и пассивных импортных электронных компонентов (более 30 млн. наименований);
- Поставка сложных, дефицитных, либо снятых с производства позиций;
- Оперативные сроки поставки под заказ (от 5 рабочих дней);
- Экспресс доставка в любую точку России;
- Помощь Конструкторского Отдела и консультации квалифицированных инженеров;
- Техническая поддержка проекта, помощь в подборе аналогов, поставка прототипов;
- Поставка электронных компонентов под контролем ВП;
- Система менеджмента качества сертифицирована по Международному стандарту ISO 9001;
- При необходимости вся продукция военного и аэрокосмического назначения проходит испытания и сертификацию в лаборатории (по согласованию с заказчиком);
- Поставка специализированных компонентов военного и аэрокосмического уровня качества (Xilinx, Altera, Analog Devices, Intersil, Interpoint, Microsemi, Actel, Aeroflex, Peregrine, VPT, Syfer, Eurofarad, Texas Instruments, MS Kennedy, Miteq, Cobham, E2V, MA-COM, Hittite, Mini-Circuits, General Dynamics и др.);

Компания «Океан Электроники» является официальным дистрибьютором и эксклюзивным представителем в России одного из крупнейших производителей разъемов военного и аэрокосмического назначения «JONHON», а так же официальным дистрибьютором и эксклюзивным представителем в России производителя высокотехнологичных и надежных решений для передачи СВЧ сигналов «FORSTAR».



## JONHON

«JONHON» (основан в 1970 г.)

Разъемы специального, военного и аэрокосмического назначения:

(Применяются в военной, авиационной, аэрокосмической, морской, железнодорожной, горно- и нефтедобывающей отраслях промышленности)

«FORSTAR» (основан в 1998 г.)

ВЧ соединители, коаксиальные кабели, кабельные сборки и микроволновые компоненты:

(Применяются в телекоммуникациях гражданского и специального назначения, в средствах связи, РЛС, а так же военной, авиационной и аэрокосмической отраслях промышленности).



Телефон: 8 (812) 309-75-97 (многоканальный)

Факс: 8 (812) 320-03-32

Электронная почта: [ocean@oceanchips.ru](mailto:ocean@oceanchips.ru)

Web: <http://oceanchips.ru/>

Адрес: 198099, г. Санкт-Петербург, ул. Калинина, д. 2, корп. 4, лит. А