



# TGA4030-SM

## 17–37 GHz GaAs MPA/Multiplier

### General Description

The Qorvo TGA4030-SM is a Medium Power Amplifier and Multiplier for wide band 17–37 GHz applications. The part is designed using Qorvo's 0.15 um power pHEMT process.

The TGA4030-SM provides a nominal 20 dB small signal gain with 22 dBm maximum output power. For 2x and 3x Multiplier Function, TGA4030-SM provides 15 dBm typical output power @ 9 dBm P<sub>IN</sub>.

This part is ideally suited for applications such as Point-to-Point Radio, EW, instrumentation and frequency multipliers.

### Product Features

- RF Output Frequency Range: 17-37 GHz
- 20 dB Nominal Gain
- 22 dBm Nominal Output Maximum Power
- 2x and 3x Multiplier Function
- Bias: V<sub>D</sub> = 5 V, I<sub>D</sub> = 140 mA
- Package Dimensions: 3.0 x 3.0 x 0.85 mm

### Applications

- Point-to-Point Radio
- EW
- Instrumentation
- Frequency Multiplier



### Measured Performance

Bias at V<sub>D</sub> = 5 V, I<sub>D</sub> = 140 mA and V<sub>G</sub> = -0.75 V (Typical)

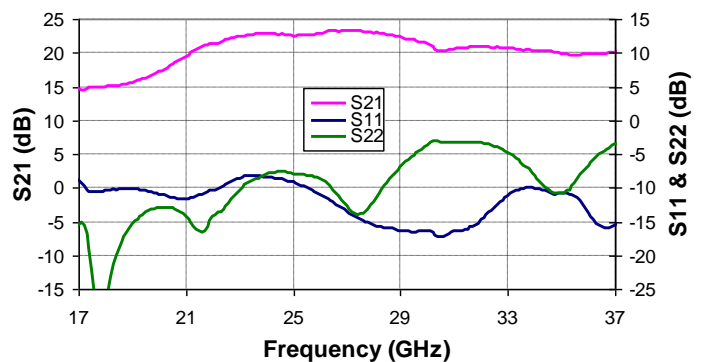

Bias at V<sub>D</sub> = 5 V, I<sub>D</sub> = 140 mA and V<sub>G</sub> = -0.75 V (Typical)

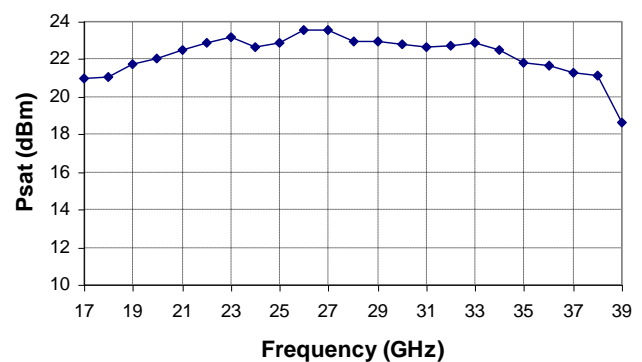

### Ordering Information

| Part          | Description                        |
|---------------|------------------------------------|
| TGA4030-SM    | Amplifier, Waffle Pack, Qty 100    |
| TGA4030-SMEVB | TGA4030-SM Evaluation Board, Qty 1 |

### Absolute Maximum Ratings

| Symbol      | Parameter                   | Value/Range | Notes |
|-------------|-----------------------------|-------------|-------|
| $V_{D-V_G}$ | Drain to Gate Voltage       | 8           | V     |
| $V_D$       | Drain Supply Voltage Range  | 6           | V     |
| $V_G$       | Gate Supply Voltage Range   | -3 – 0      | V     |
| $I_D$       | Drain Current               | 400         | mA    |
| $I_G$       | Gate Current                | 1.38        | mA    |
| $P_{IN}$    | Input Continuous Wave Power | 20          | dBm   |
| $T_S$       | Storage Temperature         | -55 to +150 | °C    |

Operation of this device outside the parameter ranges given above may cause permanent damage. These are stress ratings only, and functional operation of the device at these conditions is not implied. Extended application of Absolute Maximum Rating conditions to the device may reduce device reliability.

### Recommended Operating Conditions

See application pages for amplifier, 2x multiplier and 3x multiplier bias conditions

| Symbol   | Parameter          | Value/Range, Amp | Value/Range, x2 Multi | Value/Range, x3 Multi | Units |
|----------|--------------------|------------------|-----------------------|-----------------------|-------|
| $V_D$    | Drain Voltage      | 5                | 5                     | 5                     | V     |
| $I_D$    | Drain Current      | 140              | 120                   | 160                   | mA    |
| $V_G$    | Gate Voltage (Typ) | -0.75            | -0.75                 | -0.75                 | V     |
| $V_{D1}$ | Drain Voltage      | 5                | 5                     | 1                     | V     |
| $V_{G1}$ | Gate Voltage       | same as $V_G$    | -1.1                  | same as $V_G$         | V     |

### RF Characterization Table

See application pages for amplifier, 2x multiplier and 3x multiplier bias conditions,  $T_A = 25\text{ }^\circ\text{C}$

Data de-embedded to reference lines

| Parameter                                  | Amplifier | 2x Multiplier | 3x Multiplier | Units |
|--|-----------|---------------|---------------|-------|
| RF Output Frequencies                      | 17-37     | 22-38         | 23-31         | GHz   |
| S21, Small Signal Gain                     | 20        |               |               | dB    |
| S11, Input Return Loss                     | 10        |               |               | dB    |
| S22, Output Return Loss                    | 5         | 5             | 5             | dB    |
| $P_{SAT}$ , Maximum Output Power           | 22        |               |               | dBm   |
| P1dB, Output Power @ 1 dB Gain Compression | 18        |               |               | dBm   |
| IMD3@ 11 dBm $P_{OUT}$ /Tone               | 30        |               |               | dBc   |
| Output Power @ $P_{IN} = 9\text{ dBm}$     |           | 15            | 15            | dBm   |
| Conversion Gain                            |           | 9             | 5             | dB    |
| Gain Temperature coefficient               | -0.04     |               |               | dB/°C |

Measured Data, Amplifier

Bias Conditions:  $V_D = 5\text{ V}$ ,  $I_{DQ} = 140\text{ mA}$ ,  $V_G = -0.75\text{ V}$  (Typical),  $25\text{ }^\circ\text{C}$

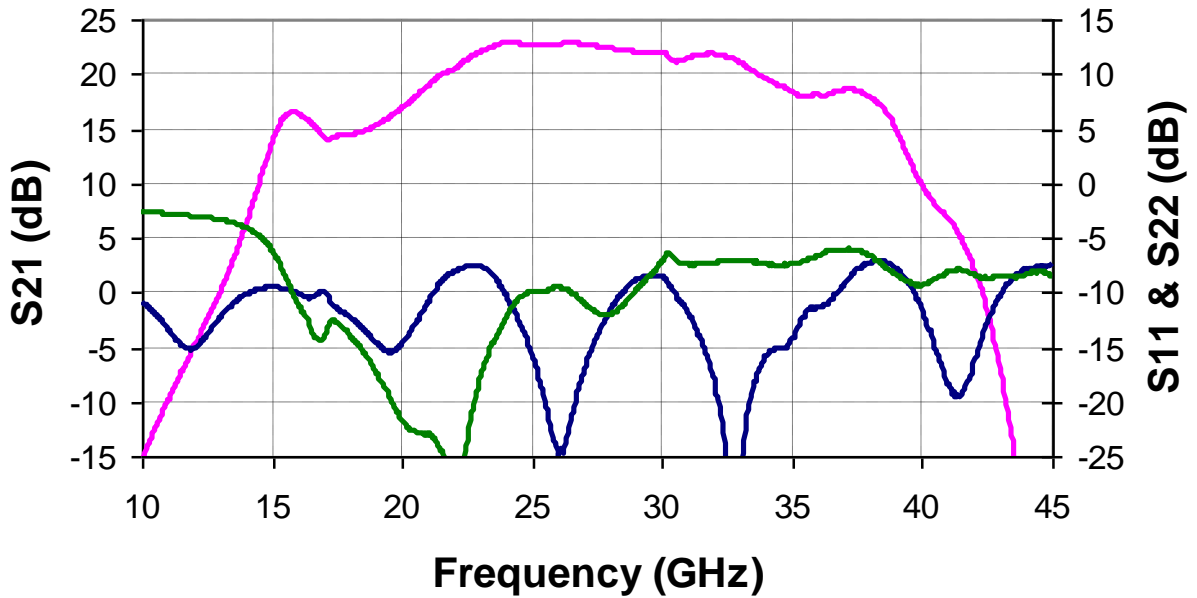

This is device s-parameter

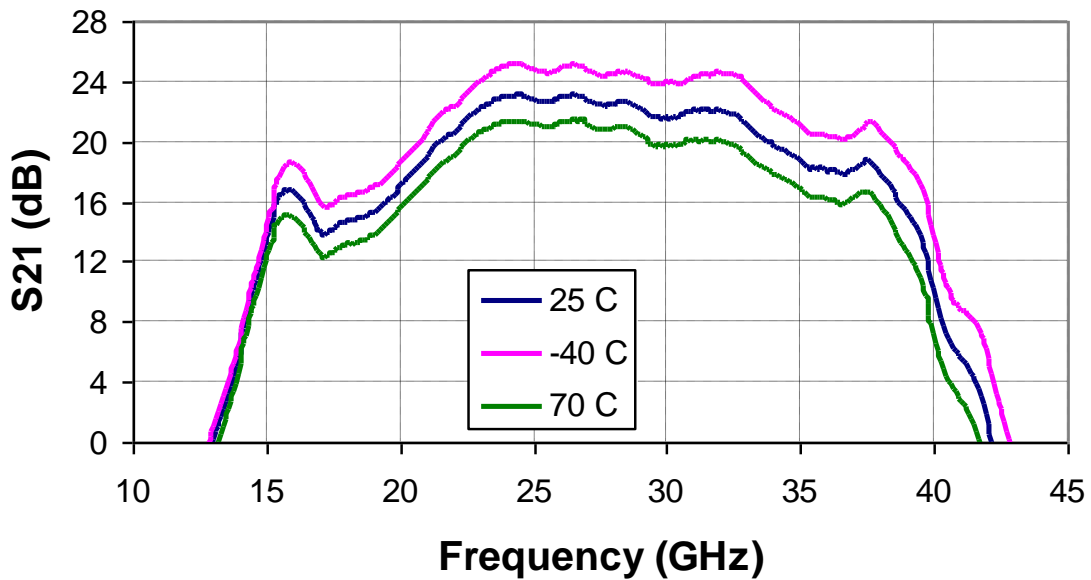

This is evaluation board s-parameter

Measured Data, Amplifier

Bias Conditions:  $V_D = 5\text{ V}$ ,  $I_{DQ} = 140\text{ mA}$ ,  $V_G = -0.75\text{ V}$  (Typical),  $25\text{ }^\circ\text{C}$

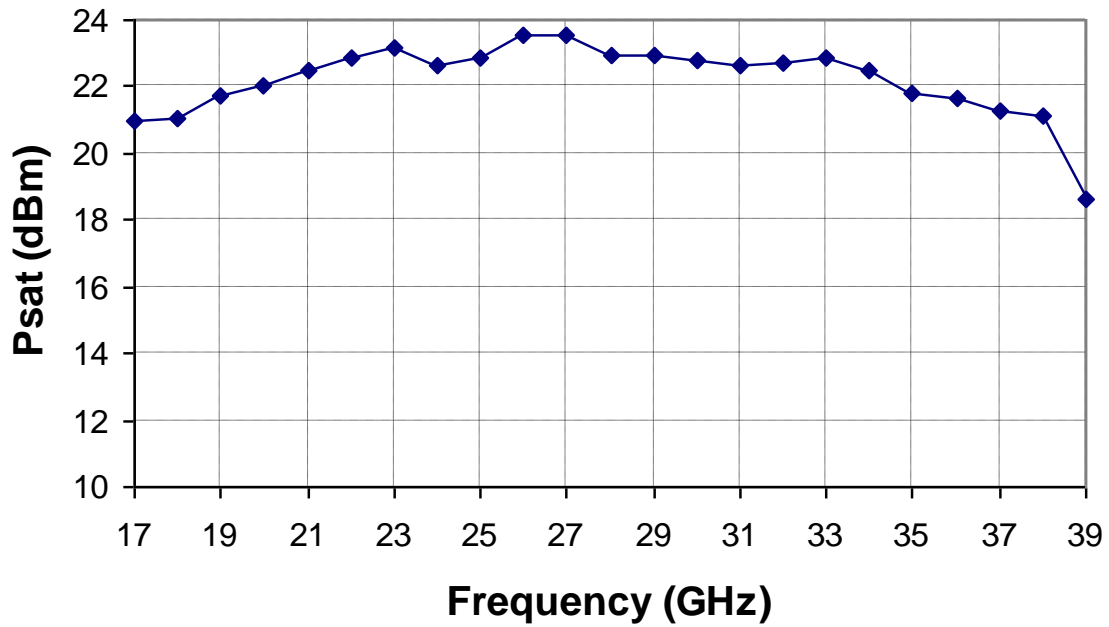
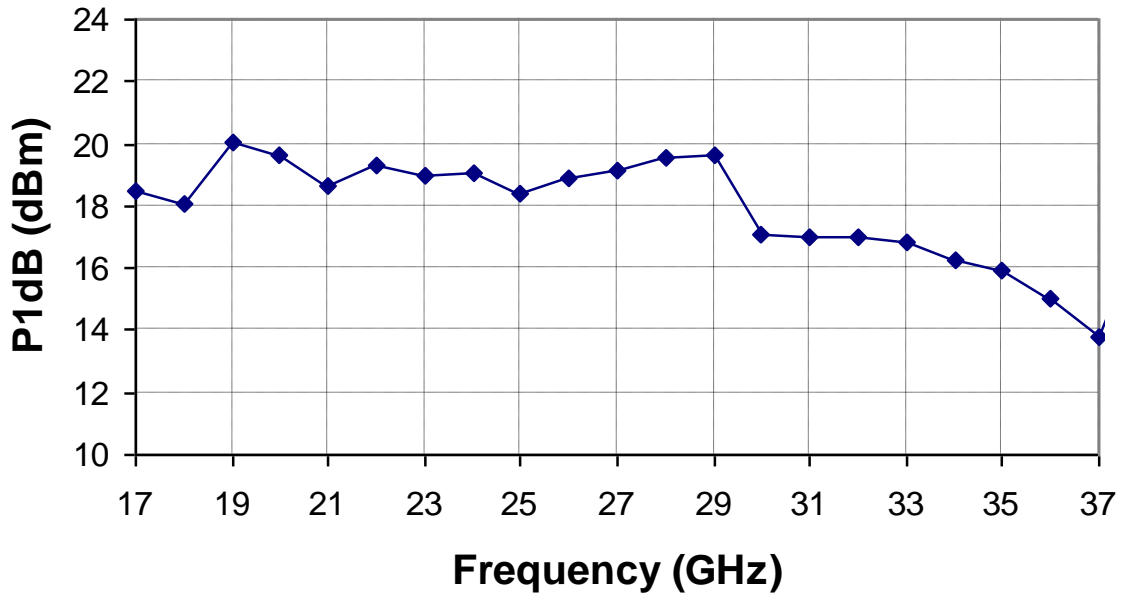

Measured Data, Amplifier

Bias Conditions:  $V_D = 5\text{ V}$ ,  $I_{DQ} = 140\text{ mA}$ ,  $V_G = -0.75\text{ V}$  (Typical),  $25\text{ }^\circ\text{C}$

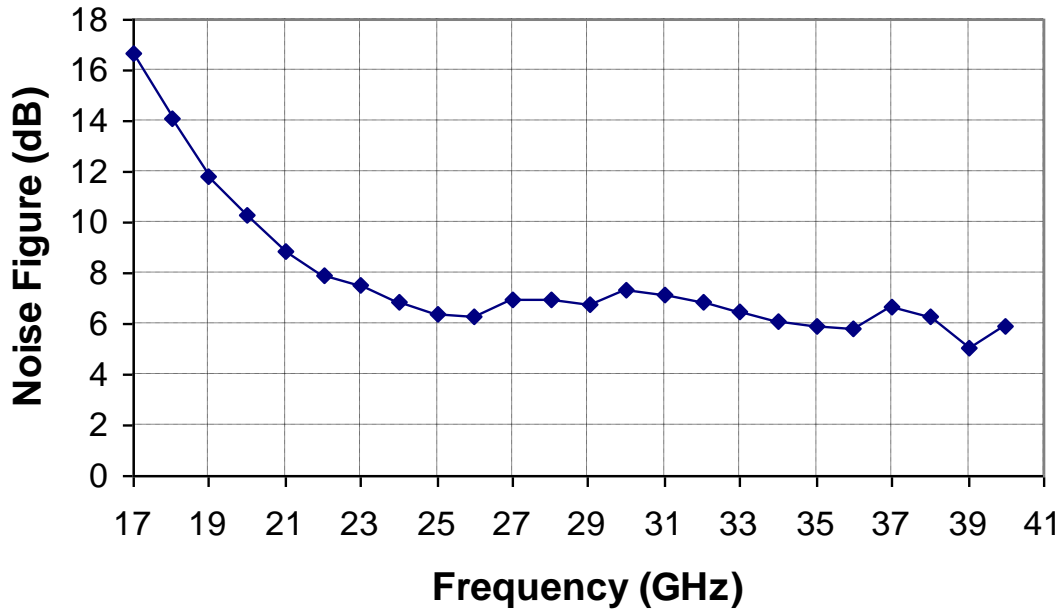
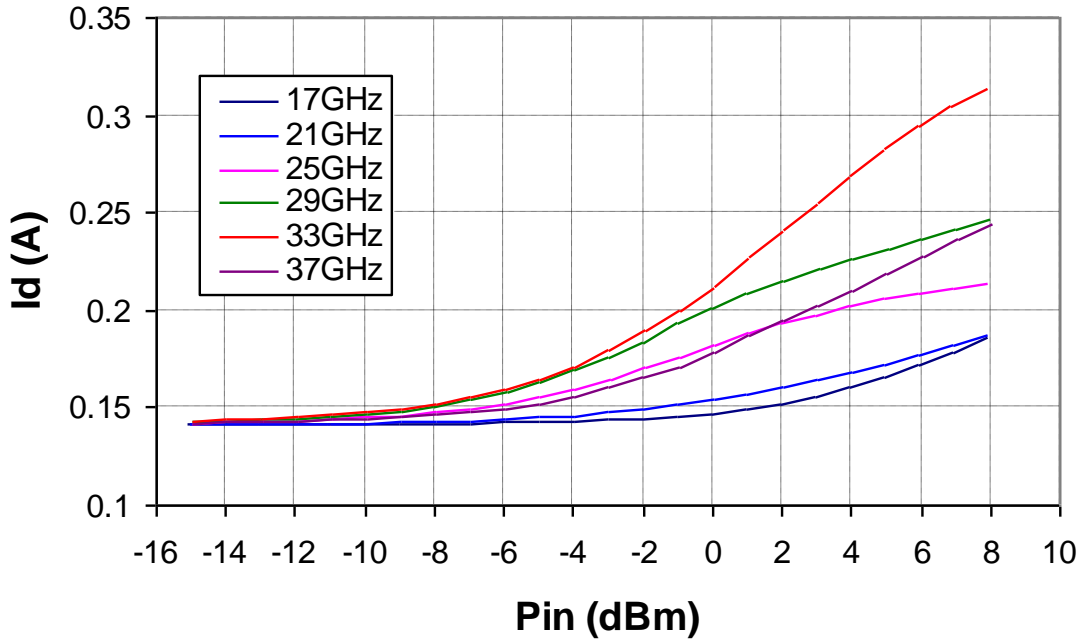

Measured Data, Amplifier

Bias Conditions:  $V_D = 5\text{ V}$ ,  $I_{DQ} = 140\text{ mA}$ ,  $V_G = -0.75\text{ V}$  (Typical),  $25\text{ }^\circ\text{C}$

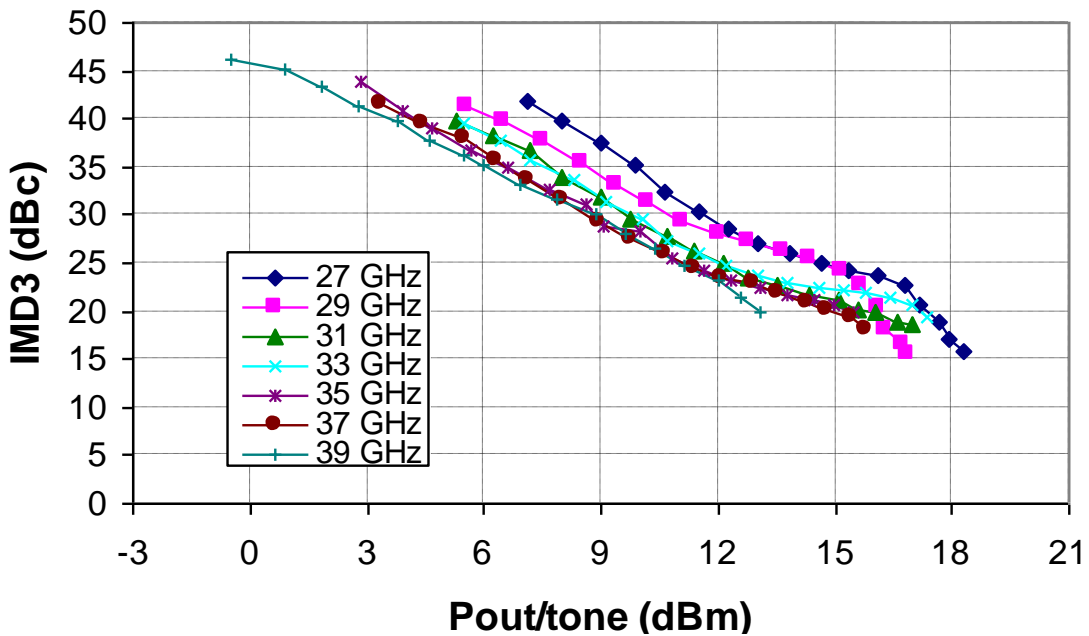
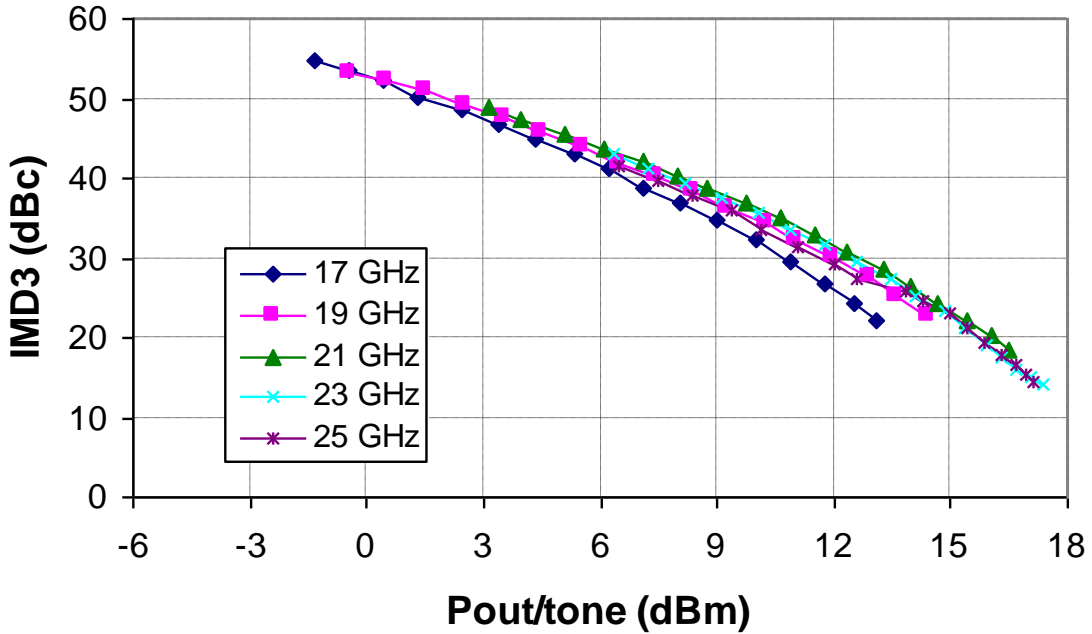

Measured Data, Amplifier

Bias Conditions:  $V_D = 5\text{ V}$ ,  $I_{DQ} = 140\text{ mA}$ ,  $V_G = -0.75\text{ V}$  (Typical),  $25\text{ }^\circ\text{C}$

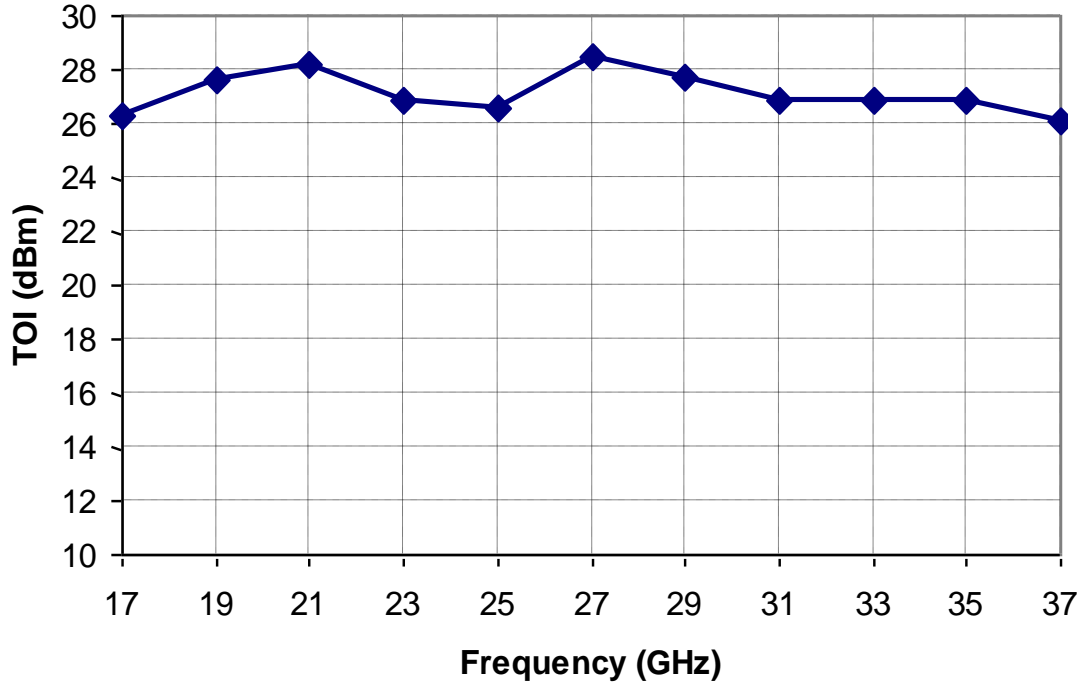

Measured Data, 2X Multiplier

Bias Conditions:  $V_D = 5\text{ V}$ ,  $I_{DQ} = 120\text{ mA}$ ,  $V_{G1} = -1.1\text{ V}$ ,  $P_{IN} = 9\text{ dBm}$ ,  $25\text{ }^\circ\text{C}$

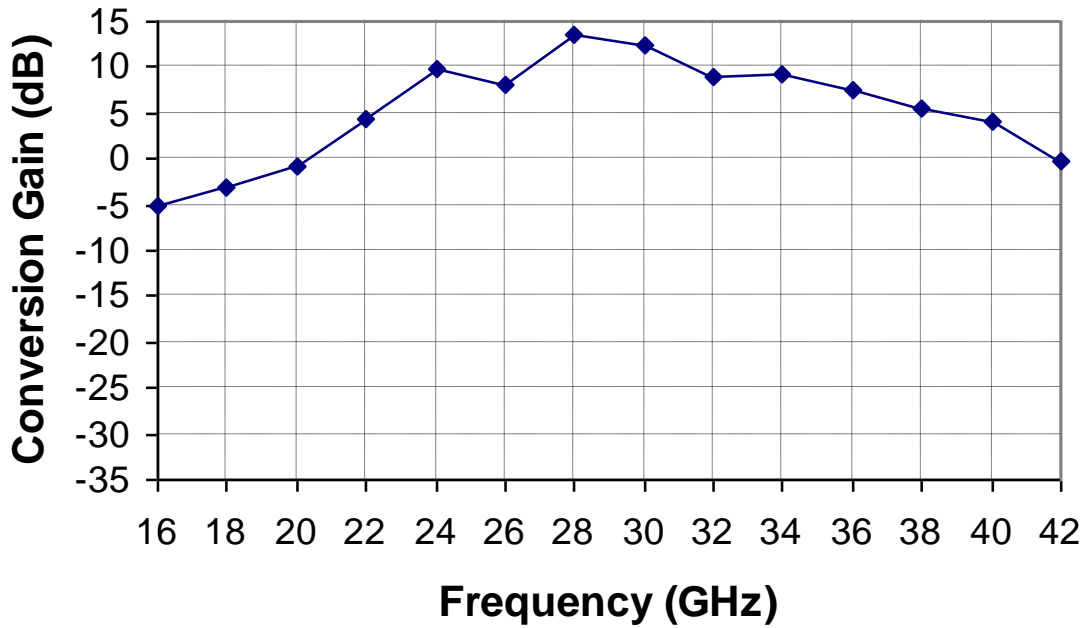
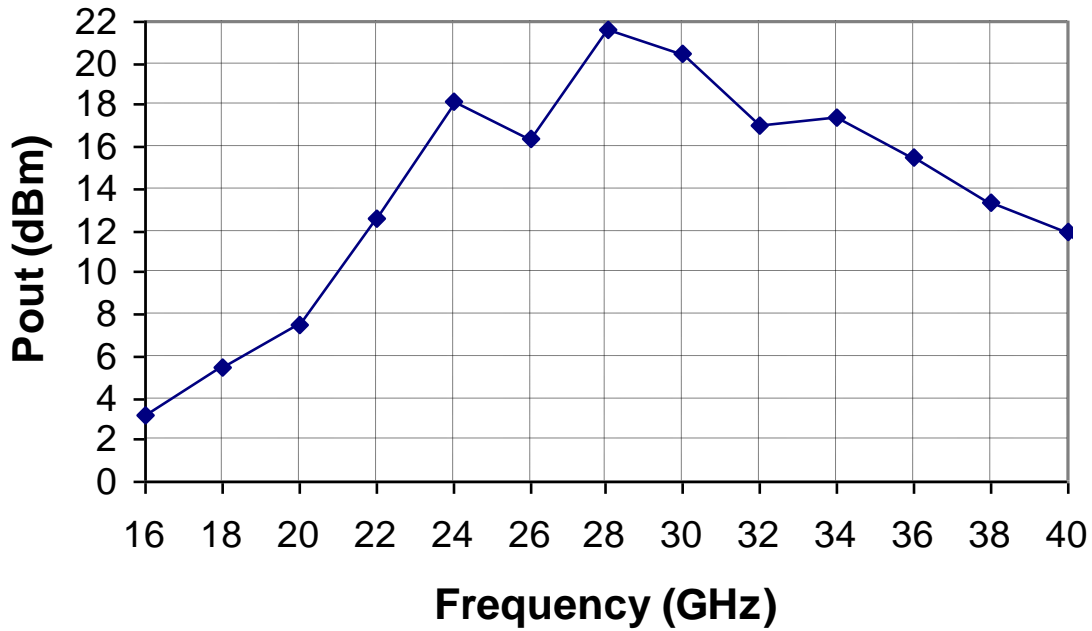



**Measured Data, 3X Multiplier**

Bias Conditions:  $V_D = 5\text{ V}$ ,  $V_{D1} = 1\text{ V}$ ,  $I_{DQ} = 160\text{ mA}$ ,  $P_{IN} = 9\text{ dBm}$ ,  $25\text{ }^\circ\text{C}$

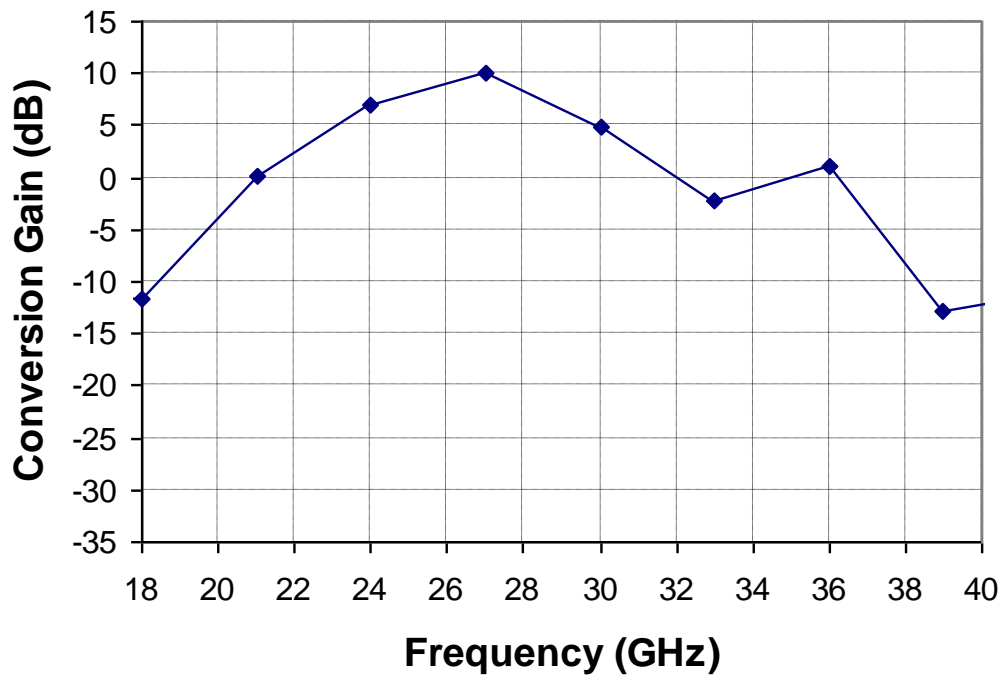
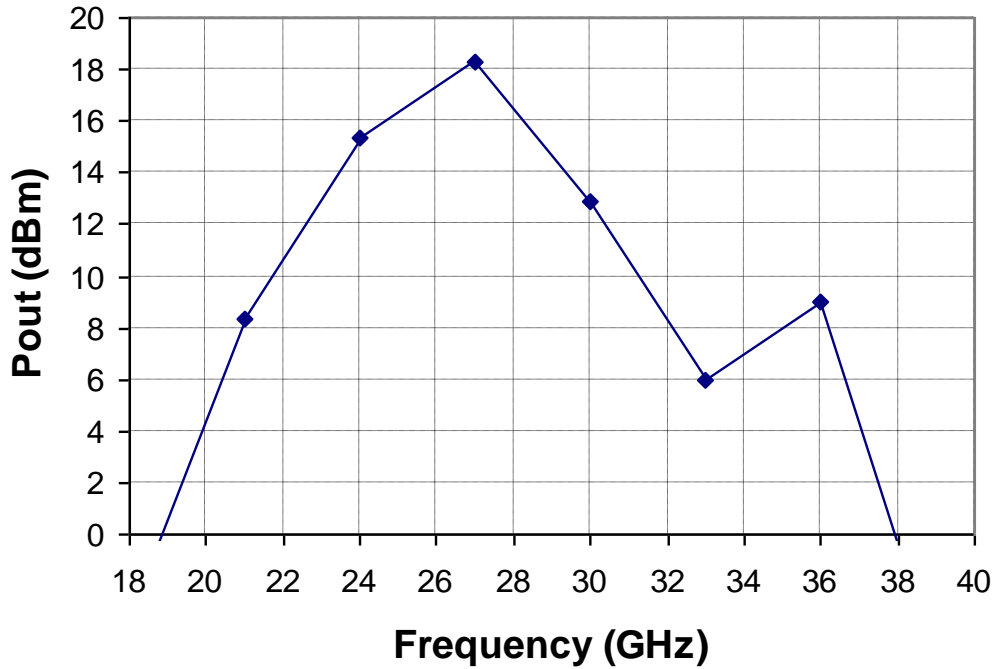

**Power Dissipation and Thermal Properties**

| Parameter                                       | Test Conditions  | Value       | Units              |
|---|--|-------------|--------------------|
| Thermal Resistance ( $\theta_{JC}$ )            | Under RF Drive<br>$P_D = 1.2\text{ W}$<br>$T_{BASEPLATE} = 70\text{ }^\circ\text{C}$   | 66.7        | $^\circ\text{C/W}$ |
| Channel Temperature ( $T_{CH}$ ) <sup>(2)</sup> |  | 150         | $^\circ\text{C}$   |
| Median Lifetime ( $T_M$ ) <sup>(1)</sup>        |  | 1.0 E + 6   | Hrs                |
| Thermal Resistance ( $\theta_{JC}$ )            | Quiescent, Small Signal<br>$V_D = 5\text{ V}$ , $I_D = 140\text{ mA}$ , $P_D = 0.7\text{ W}$<br>$T_{BASEPLATE} = 70\text{ }^\circ\text{C}$ | 65.7        | $^\circ\text{C/W}$ |
| Channel Temperature ( $T_{CH}$ ) <sup>(2)</sup> |  | 116         | $^\circ\text{C}$   |
| Median Lifetime ( $T_M$ ) <sup>(1)</sup>        |  | 2.4 E+7 Hrs | Hrs                |

Notes:

- For a median life,  $T_m$ , of 1 E+6 hours, power dissipation is limited to  $P_D(\text{max}) = (T_{\text{CHANNEL}}\text{ }^\circ\text{C} - T_{\text{BASE}}\text{ }^\circ\text{C})/\theta_{JC}$
- Channel operating temperature will directly affect the device median time to failure (MTTF). For maximum life, it is recommended that channel temperatures be maintained at the lowest possible levels.

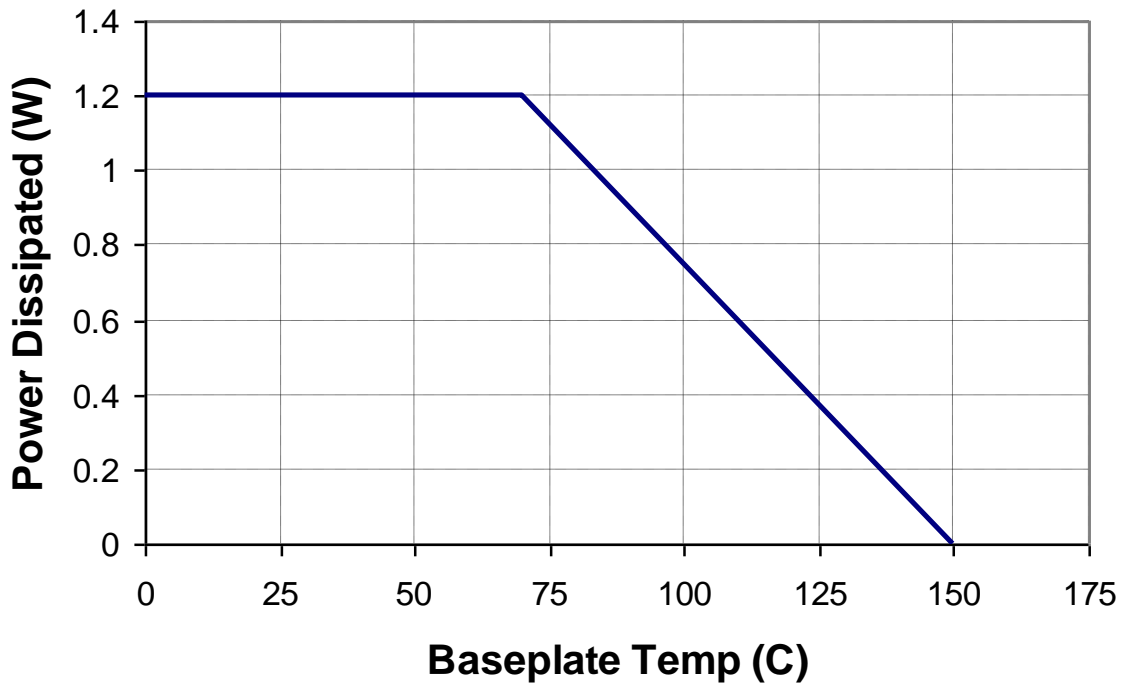

Mechanical Drawing & Pad Description

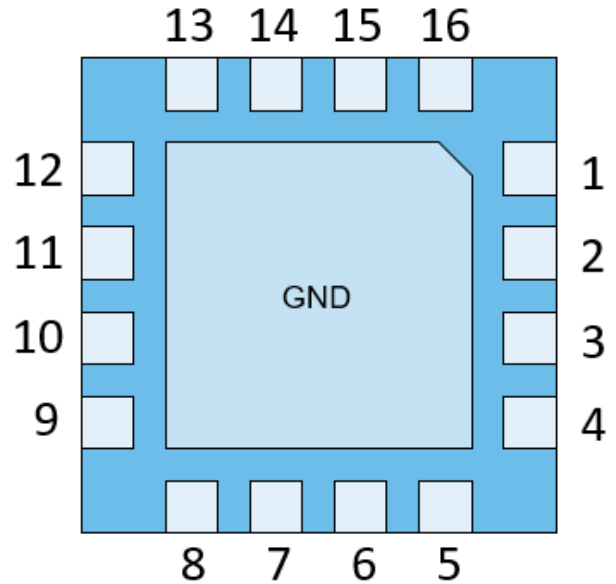

| Pin Number                | Label     | Description   |
|---------------------------|-----------|---|
| 1, 2, 4, 9, 11, 12 (slug) | GND       | Ground  |
| 3                         | RF Input  | Matched to 50 ohms, DC blocked                            |
| 5                         | VG1       | Stage 1 Gate Voltage                                      |
| 7                         | VG        | Other Stages Gate Voltage                                 |
| 10                        | RF Output | Matched to 50 ohms, DC blocked                            |
| 14                        | VD        | Other Stages Drain Voltage                                |
| 16                        | VD1       | Stage 1 Drain Voltage                                     |
| 6, 8, 13, 15              | N/C       | No internal connection. Recommend to GND at the PCB level |

**Mechanical Drawing**

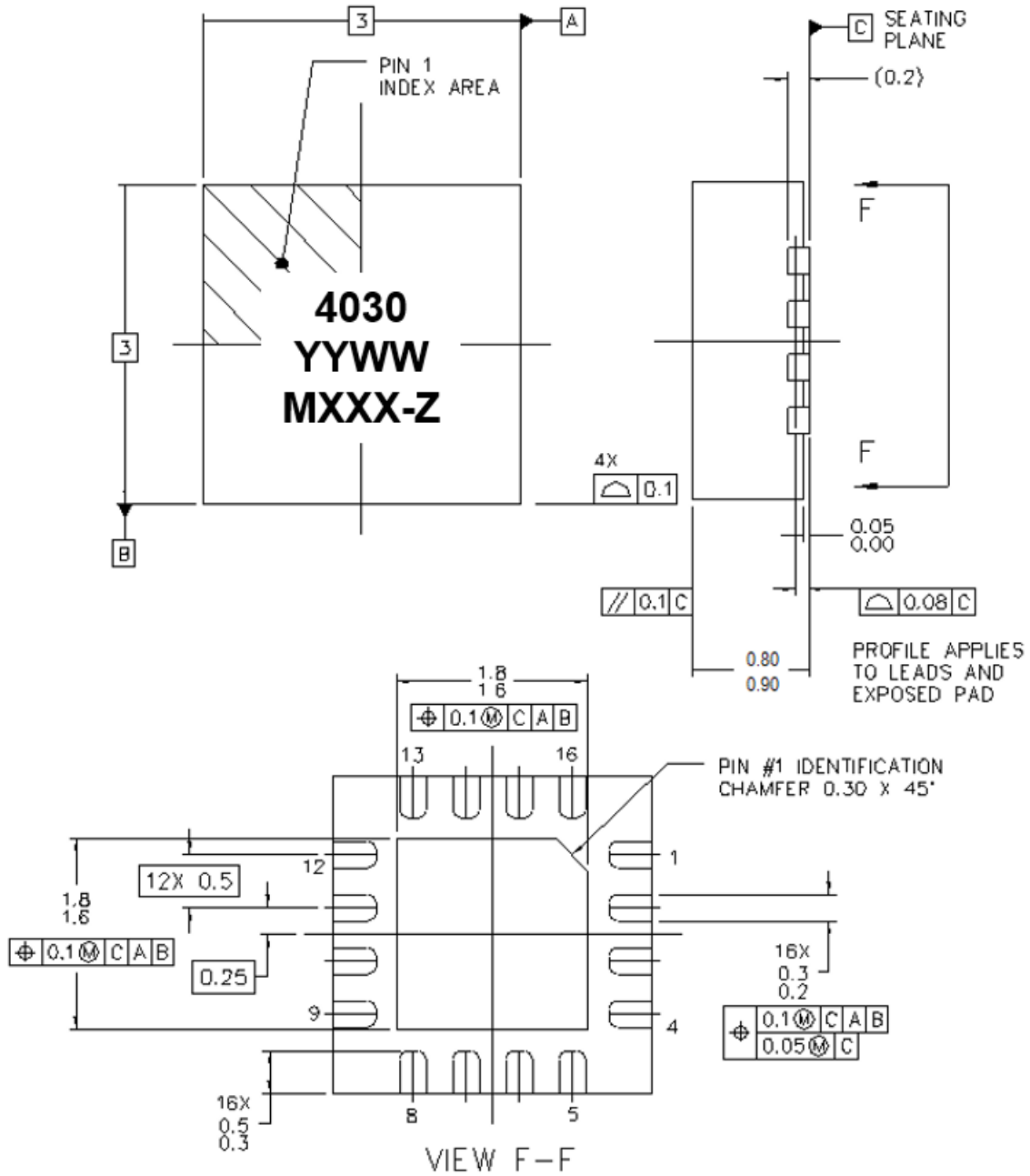

Dimensions in mm, package is mold encapsulated with Tin plated lead finish  
 Part Marking: 4030 = Part Number, YY = Part Assembly Year  
 WW = Part Assembly Week, MXXX-Z = Batch ID

Evaluation Board

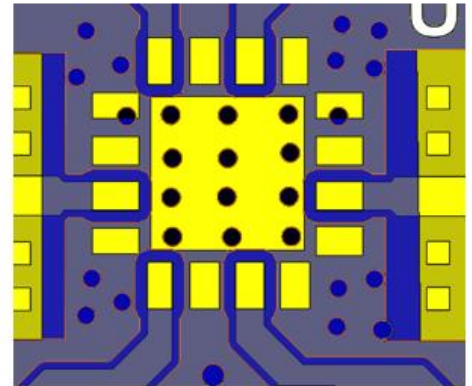
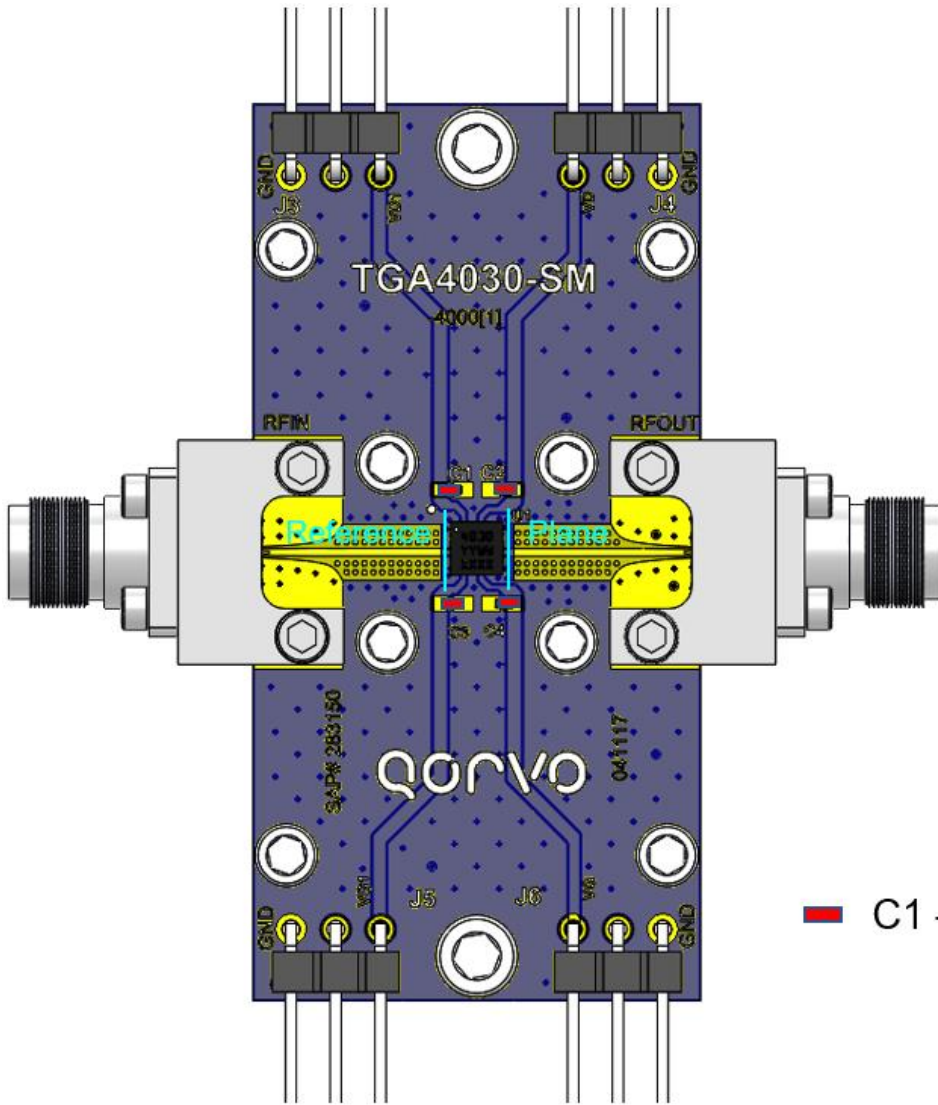

Mounting Pad Details

■ C1 – C4, 0.01 uF

Notes:

1. C1 – C4 0402 0.01 uF capacitors
2. Board material is 8 mil ROGERS RO4003

Application Circuit, Device as Amplifier

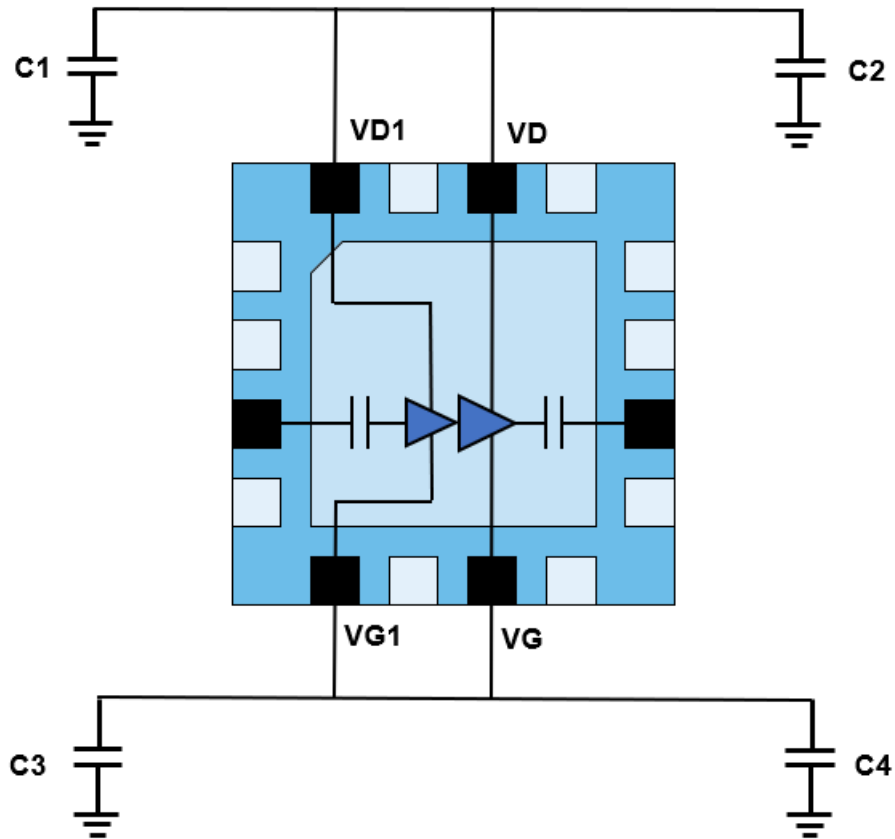

**Bias-up Procedure**

1. Set  $I_D$  limit to 400 mA,  $I_G$  limit to 2 mA
2. Set  $V_G$  to  $-1.5$  V
3. Set  $V_D$  +5 V
4. Adjust  $V_G$  more positive until  $I_{DQ} = 140$  mA
5. Apply RF signal

**Bias-down Procedure**

1. Turn off RF signal
2. Reduce  $V_G$  to  $-1.5$  V. Ensure  $I_{DQ} \sim 0$  mA
3. Set  $V_D$  to 0 V
4. Turn off  $V_D$  supply
5. Turn off  $V_G$  supply

Application Circuit, Device as x2 Multiplier

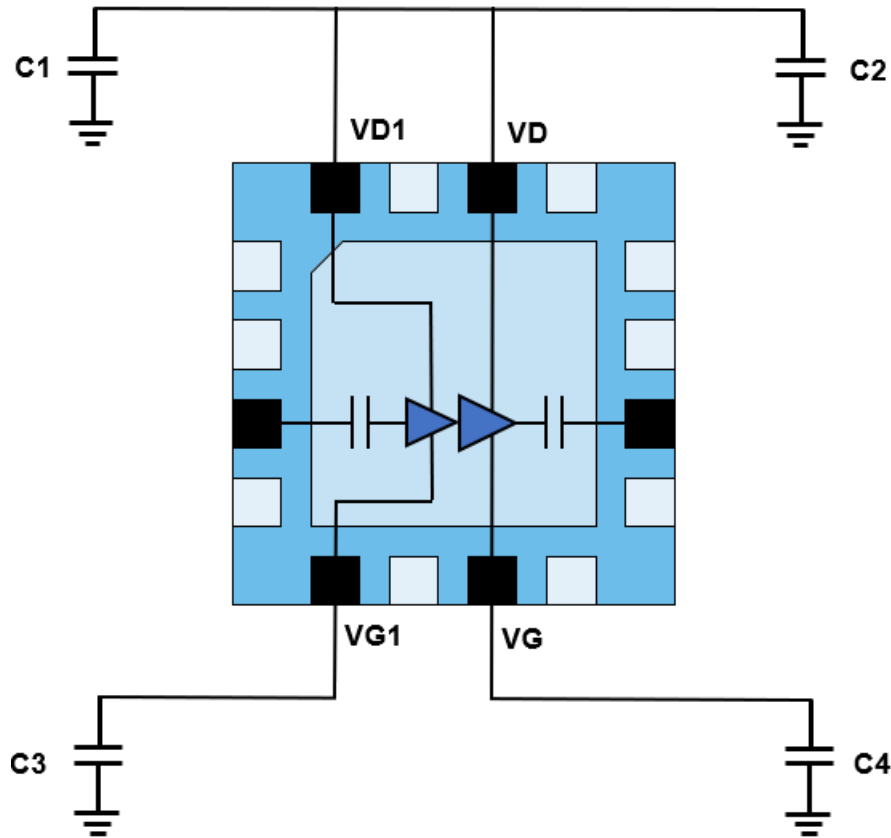

**Bias-up Procedure**

1. Set  $I_D$  limit to 400 mA,  $I_G$  and  $I_{G1}$  limit to 2 mA each.
2. Set  $V_G$  to  $-1.5$  V, Set  $V_{G1} = -1.1$  V (fixed)
3. Set  $V_D +5$  V
4. Adjust  $V_G$  more positive until  $I_{DQ} = 120$  mA
5. Apply RF signal

**Bias-down Procedure**

1. Turn off RF signal
2. Reduce  $V_G$  to  $-1.5$  V. Ensure  $I_{DQ} \sim 0$  mA
3. Set  $V_D$  to 0 V
4. Turn off  $V_D$  supply
5. Turn off  $V_G$  and  $V_{G1}$  supply

Application Circuit, Device as x3 Multiplier

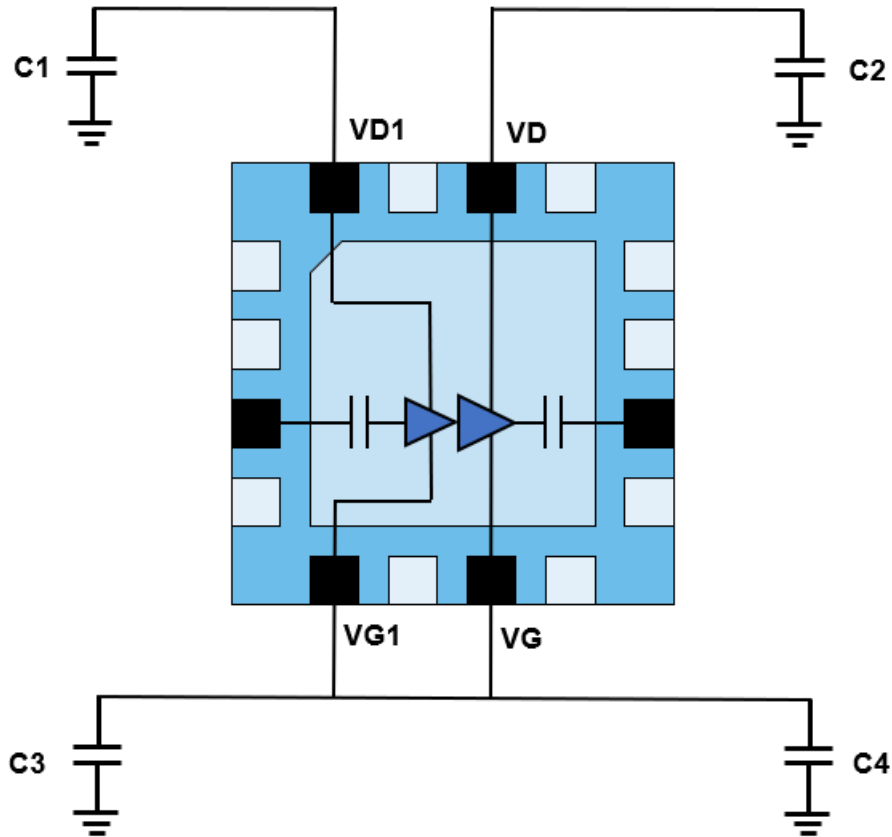

**Bias-up Procedure**

1. Set  $I_D$  limit to 400 mA, Set  $I_{D1}$  Limit to 50 mA,  $I_G$  limit to 2 mA
2. Set  $V_G$  to  $-1.5$  V
3. Set  $V_D = +5$  V, Set  $V_{D1} = +1$  V
4. Adjust  $V_G$  more positive until  $I_{D1} + I_D = 160$  mA
5. Apply RF signal

**Bias-down Procedure**

1. Turn off RF signal
2. Reduce  $V_G$  to  $-1.5$  V. Ensure  $I_{DQ} \sim 0$  mA
3. Set  $V_{D1}$  and  $V_D$  to 0 V
4. Turn off  $V_{D1}$  and  $V_D$  supply
5. Turn off  $V_G$  supply



### Recommended Surface Mount Package Assembly

Clean the board with acetone. Rinse with alcohol. Allow the circuit to fully dry.

Qorvo recommends using a conductive solder paste for attachment. Follow solder paste and reflow oven vendors' recommendations when developing a solder reflow profile.

Hand soldering is not recommended. Solder paste can be applied using a stencil printer or dot placement. The volume of solder paste depends on PCB and component layout and should be well controlled to ensure consistent mechanical and electrical performance

### Typical Solder Reflow Profiles

| Reflow Profiles                      | SnPb                    | Pb Free                 |
|--------------------------------------|-------------------------|-------------------------|
| Ramp-up rate                         | 3 °C/sec                | 3 °C/sec                |
| Activation Time and Temperature      | 60-120 sec @ 140-160 °C | 60-180 sec @ 150-200 °C |
| Time above Melting point             | 60-150 sec              | 60-150 sec              |
| Max Peak Temperature                 | 240 °C                  | 260 °C                  |
| Time within 5 °C of Peak Temperature | 10-20 sec               | 10-20 sec               |
| Ramp-down Rate                       | 4-6 °C/sec              | 4-6 °C/sec              |

### Handling Precautions

| Parameter                        | Rating | Standard                           |
|----------------------------------|--------|------------------------------------|
| ESD – Human Body Model (HBM)     | 0B     | ESDA / JEDEC JS-001-2017           |
| ESD – Charged Device Model (CDM) | C3     | ESDA / JEDEC JS-002-2014           |
| MSL – Moisture Sensitivity Level | 3      | JEDEC standard IPC/JEDEC J-STD-020 |



Caution!  
ESD-Sensitive Device

### RoHS Compliance

This product is compliant with the 2011/65/EU RoHS directive (Restrictions on the Use of Certain Hazardous Substances in Electrical and Electronic Equipment), as amended by Directive 2015/863/EU.

This product also has the following attributes:

- Lead Free
- Halogen Free (Chlorine, Bromine)
- Antimony Free
- TBBP-A (C<sub>15</sub>H<sub>12</sub>Br<sub>4</sub>O<sub>2</sub>) Free
- PFOS Free
- SVHC Free

### Contact Information

For the latest specifications, additional product information, worldwide sales and distribution locations.

Web: [www.qorvo.com](http://www.qorvo.com)

Tel: 1-844-890-8163

Email: [customer.support@qorvo.com](mailto:customer.support@qorvo.com)

### Important Notice

The information contained herein is believed to be reliable; however, Qorvo makes no warranties regarding the information contained herein and assumes no responsibility or liability whatsoever for the use of the information contained herein. All information contained herein is subject to change without notice. Customers should obtain and verify the latest relevant information before placing orders for Qorvo products. The information contained herein or any use of such information does not grant, explicitly or implicitly, to any party any patent rights, licenses, or any other intellectual property rights, whether with regard to such information itself or anything described by such information. **THIS INFORMATION DOES NOT CONSTITUTE A WARRANTY WITH RESPECT TO THE PRODUCTS DESCRIBED HEREIN, AND QORVO HEREBY DISCLAIMS ANY AND ALL WARRANTIES WITH RESPECT TO SUCH PRODUCTS WHETHER EXPRESS OR IMPLIED BY LAW, COURSE OF DEALING, COURSE OF PERFORMANCE, USAGE OF TRADE OR OTHERWISE, INCLUDING THE IMPLIED WARRANTIES OF MERCHANTABILITY AND FITNESS FOR A PARTICULAR PURPOSE.**

Without limiting the generality of the foregoing, Qorvo products are not warranted or authorized for use as critical components in medical, life-saving, or life-sustaining applications, or other applications where a failure would reasonably be expected to cause severe personal injury or death.

Copyright 2019 © Qorvo, Inc. | Qorvo is a registered trademark of Qorvo, Inc.

Компания «Океан Электроники» предлагает заключение долгосрочных отношений при поставках импортных электронных компонентов на взаимовыгодных условиях!

Наши преимущества:

- Поставка оригинальных импортных электронных компонентов напрямую с производств Америки, Европы и Азии, а так же с крупнейших складов мира;
- Широкая линейка поставок активных и пассивных импортных электронных компонентов (более 30 млн. наименований);
- Поставка сложных, дефицитных, либо снятых с производства позиций;
- Оперативные сроки поставки под заказ (от 5 рабочих дней);
- Экспресс доставка в любую точку России;
- Помощь Конструкторского Отдела и консультации квалифицированных инженеров;
- Техническая поддержка проекта, помощь в подборе аналогов, поставка прототипов;
- Поставка электронных компонентов под контролем ВП;
- Система менеджмента качества сертифицирована по Международному стандарту ISO 9001;
- При необходимости вся продукция военного и аэрокосмического назначения проходит испытания и сертификацию в лаборатории (по согласованию с заказчиком);
- Поставка специализированных компонентов военного и аэрокосмического уровня качества (Xilinx, Altera, Analog Devices, Intersil, Interpoint, Microsemi, Actel, Aeroflex, Peregrine, VPT, Syfer, Eurofarad, Texas Instruments, MS Kennedy, Miteq, Cobham, E2V, MA-COM, Hittite, Mini-Circuits, General Dynamics и др.);

Компания «Океан Электроники» является официальным дистрибьютором и эксклюзивным представителем в России одного из крупнейших производителей разъемов военного и аэрокосмического назначения «JONHON», а так же официальным дистрибьютором и эксклюзивным представителем в России производителя высокотехнологичных и надежных решений для передачи СВЧ сигналов «FORSTAR».



## JONHON

«JONHON» (основан в 1970 г.)

Разъемы специального, военного и аэрокосмического назначения:

(Применяются в военной, авиационной, аэрокосмической, морской, железнодорожной, горно- и нефтедобывающей отраслях промышленности)

«FORSTAR» (основан в 1998 г.)

ВЧ соединители, коаксиальные кабели, кабельные сборки и микроволновые компоненты:

(Применяются в телекоммуникациях гражданского и специального назначения, в средствах связи, РЛС, а так же военной, авиационной и аэрокосмической отраслях промышленности).



Телефон: 8 (812) 309-75-97 (многоканальный)

Факс: 8 (812) 320-03-32

Электронная почта: [ocean@oceanchips.ru](mailto:ocean@oceanchips.ru)

Web: <http://oceanchips.ru/>

Адрес: 198099, г. Санкт-Петербург, ул. Калинина, д. 2, корп. 4, лит. А