

# preci-dip

swiss world connects

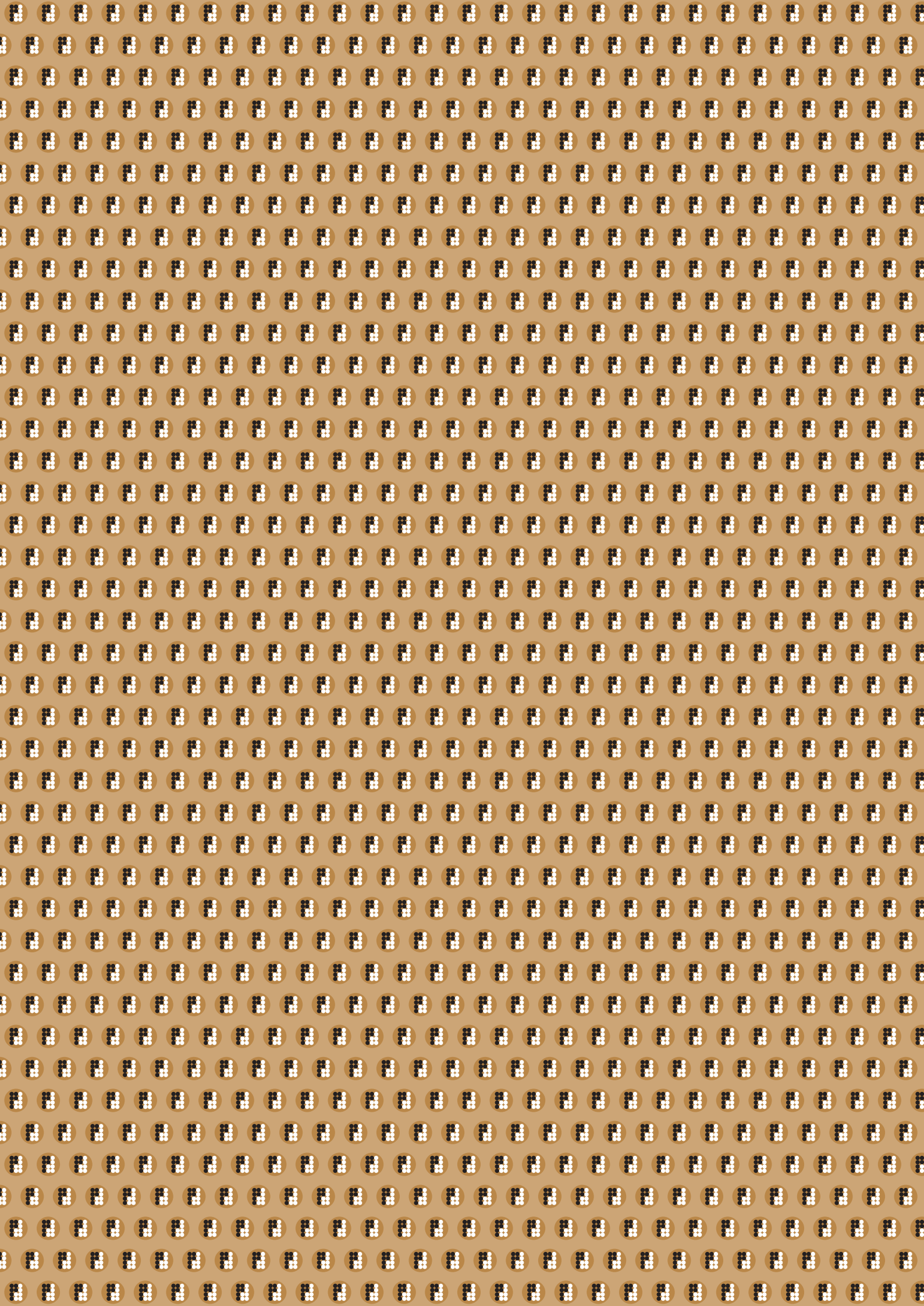

**PRECI-DIP**  
**SWISS QUALITY**  
**CONNECTION**  
**TECHNOLOGY**

**INTERCONNECT COMPONENTS**  
**FROM STANDARD PRODUCTS**  
**TO CUSTOM DESIGN**



FIND A WORLD  
OF SWISS QUALITY

# UNDER ONE ROOF

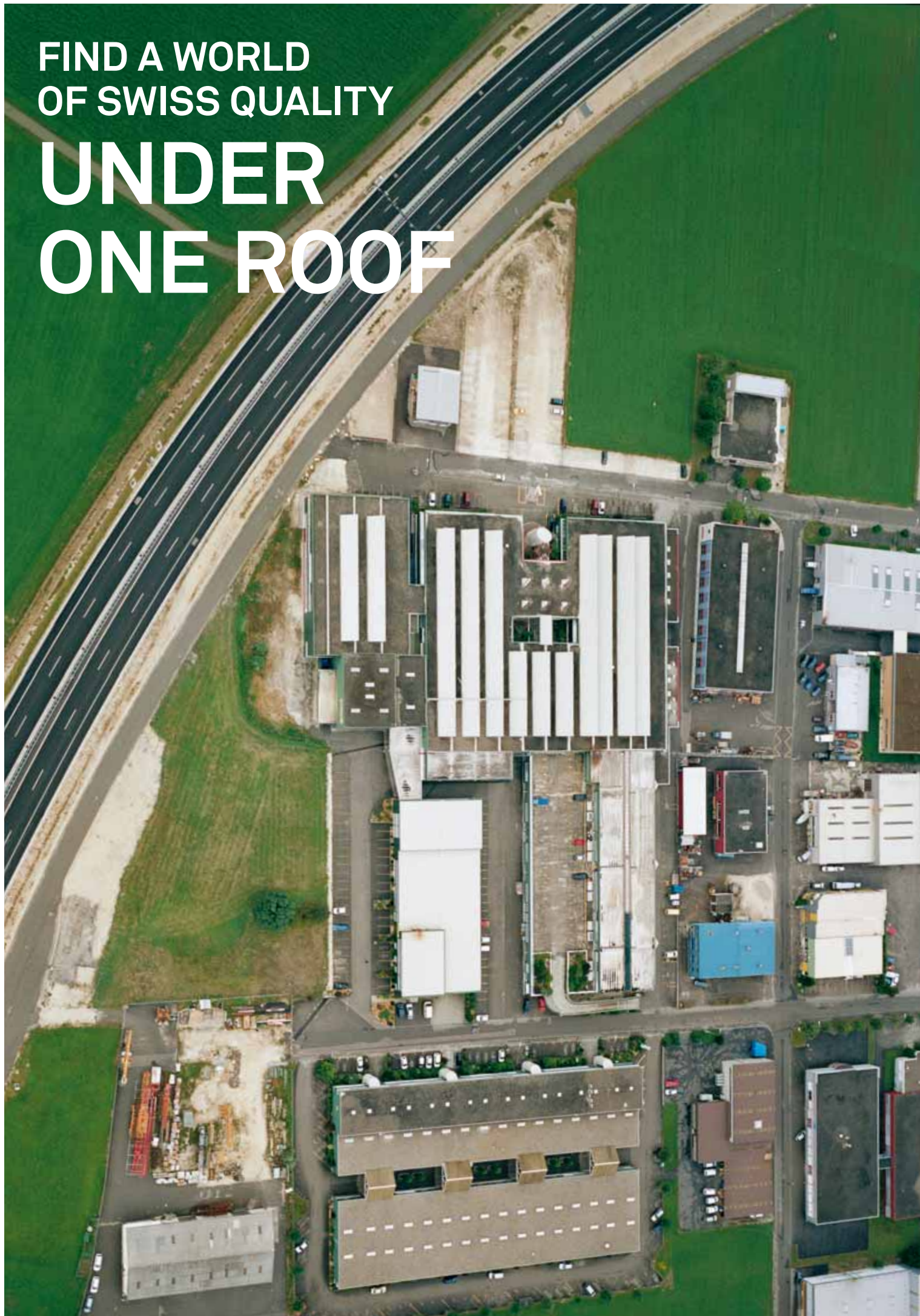







**FULL CONTROL OF THE ENTIRE  
MANUFACTURING PROCESS.  
FROM RAW MATERIAL TO FINISHED  
PRODUCT, FROM PRODUCT  
DEVELOPMENT TO SALES.  
HOME TO SUCH UNIQUE QUALITY  
IS DELEMONT, SWITZERLAND.  
SINCE 1976.**

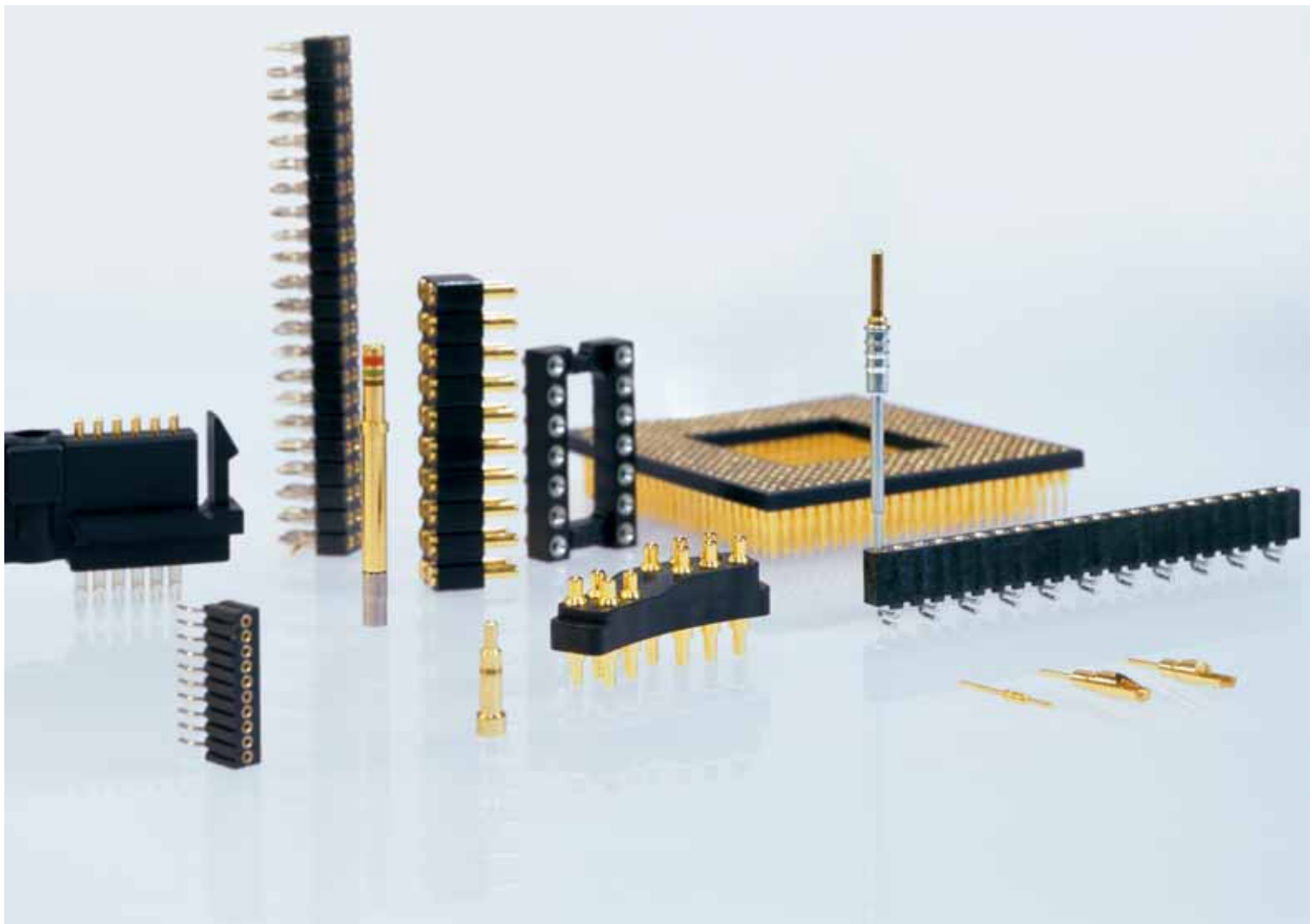

PRECI-DIP packs unequalled expertise into cutting-edge interconnect components. Advanced designs, top materials, incomparable Swiss precision. Developed by men and women driven by passion and know-how.

Key data for one of the world's leading producers of screw-machined contacts: 25,000 m<sup>2</sup>, more than 20,000 different products, R&D supported by state-of-the-art CAD systems and 3D projections. Compliance with the Standards ISO 9001, EN 9100, ISO 14001, ISO/TS 16949 and MIL Standard 790 verified in our own test laboratory.

ISO 14001 Environmental Management Systems. Ahead of its time, PRECI-DIP exceeds the world's most stringent environmental standards (Switzerland, California). State-of-the-art filter systems help preserve the atmosphere, a closed water circuit protects the ground water and saves valuable resources. These are but some of the accomplishments the Company can be proud of. Environmental responsibility is a core value embraced by all PRECI-DIP employees.

Precision tools and contact assembly machines are developed, designed and produced by PRECI-DIP experts. Principle of vertical single-site command structure put into practice – from raw material to finished product. Each step under control.

300 high-speed turning machines for producing precision contacts made of various copper alloys. Capacity: more than 150 million pieces/week.

PRECI-DIP is also a leader in spring-loaded contacts – a top-quality industrial production.

Custom-made insulators for special requirements – 150 contact assembly machines for high-speed clip insertion in the contact body.

Custom-designed products developed in close partnership with the client – a welcome challenge for the PRECI-DIP Team.

SAP-supported production controls for short lead times.

Expertise, qualifications and commitment for high output, flexibility and customer orientation. Under one and the same roof. Supported by a worldwide logistic network.

PRECI-DIP: Come and visit us. On the Internet. Or in person. Experience for yourself what it means to rely on Swiss quality.



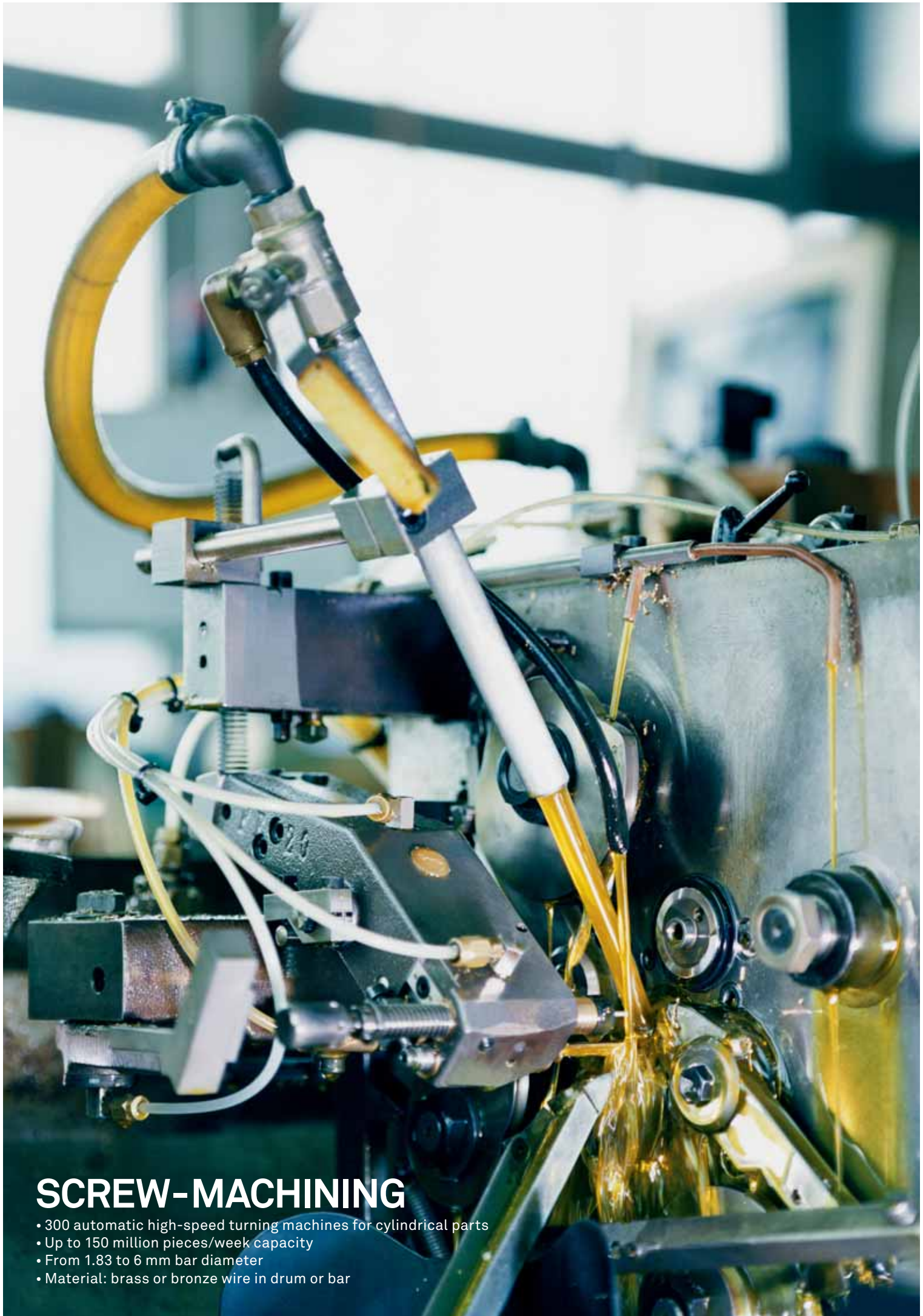

## SCREW-MACHINING

- 300 automatic high-speed turning machines for cylindrical parts
- Up to 150 million pieces/week capacity
- From 1.83 to 6 mm bar diameter
- Material: brass or bronze wire in drum or bar

# CLIP STAMPING

- 10 high-speed stamping presses
- 130 million clips/week capacity
- BeCu material, heat treated and deburred
- More than 40 multi-finger clip references

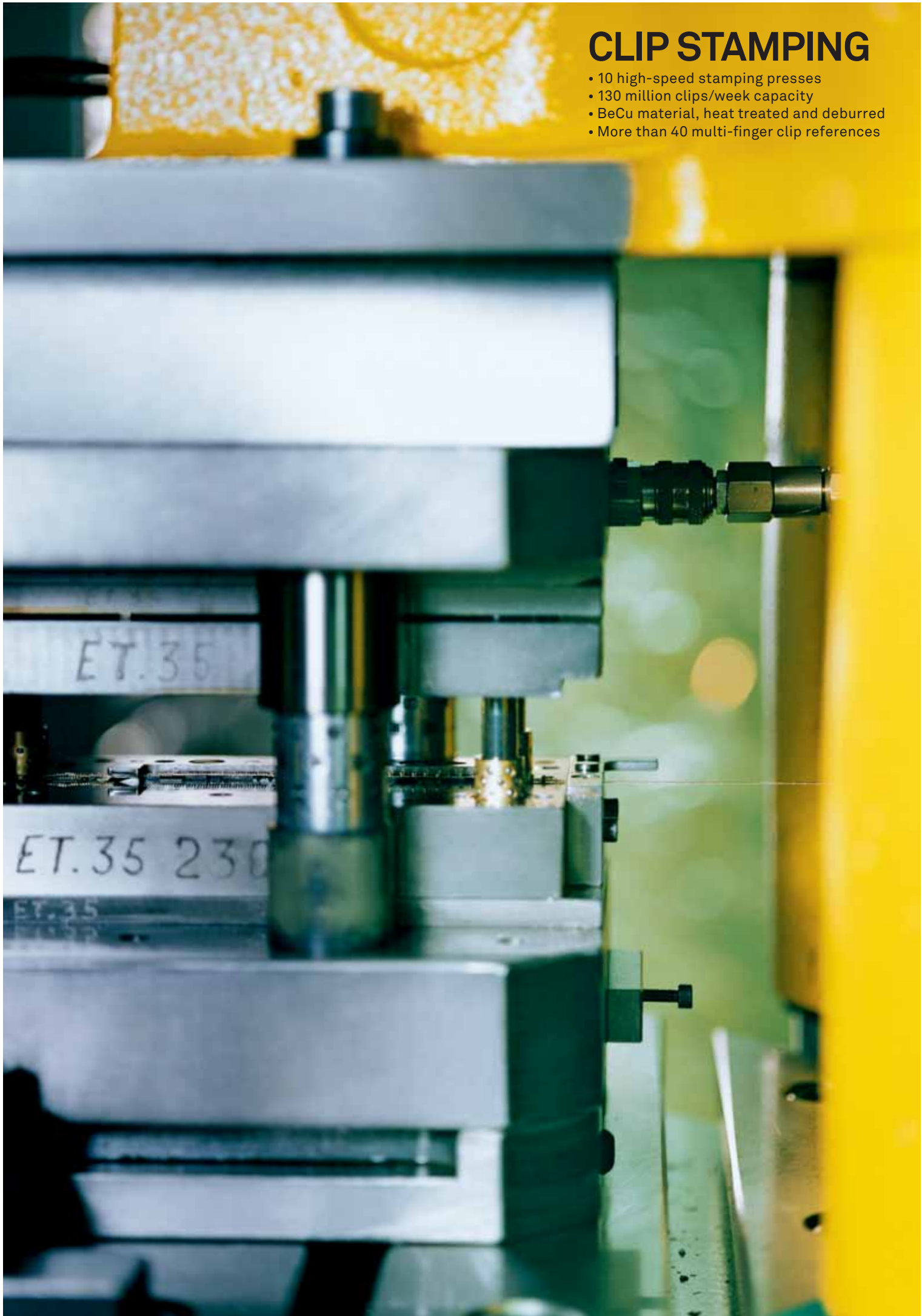





## CONTACTS ASSEMBLY

- 150 contact assembly machines for the insertion of the clip in the contact body
- 150 million contacts per week assembly capacity



## CONNECTOR ASSEMBLY

- Final assembly of the contact in the insulator
- 150 assembly machines and equipment
- Assembly PCB connectors, IC and PGA sockets
- Capacity 80 million assembled contacts per week





# SPRING-LOADED CONTACTS ASSEMBLY

- Over 10 million contacts per week assembly capacity
- Multi-station rotary table:
  - Components loading
  - Crimping press
  - In-line functionality checks

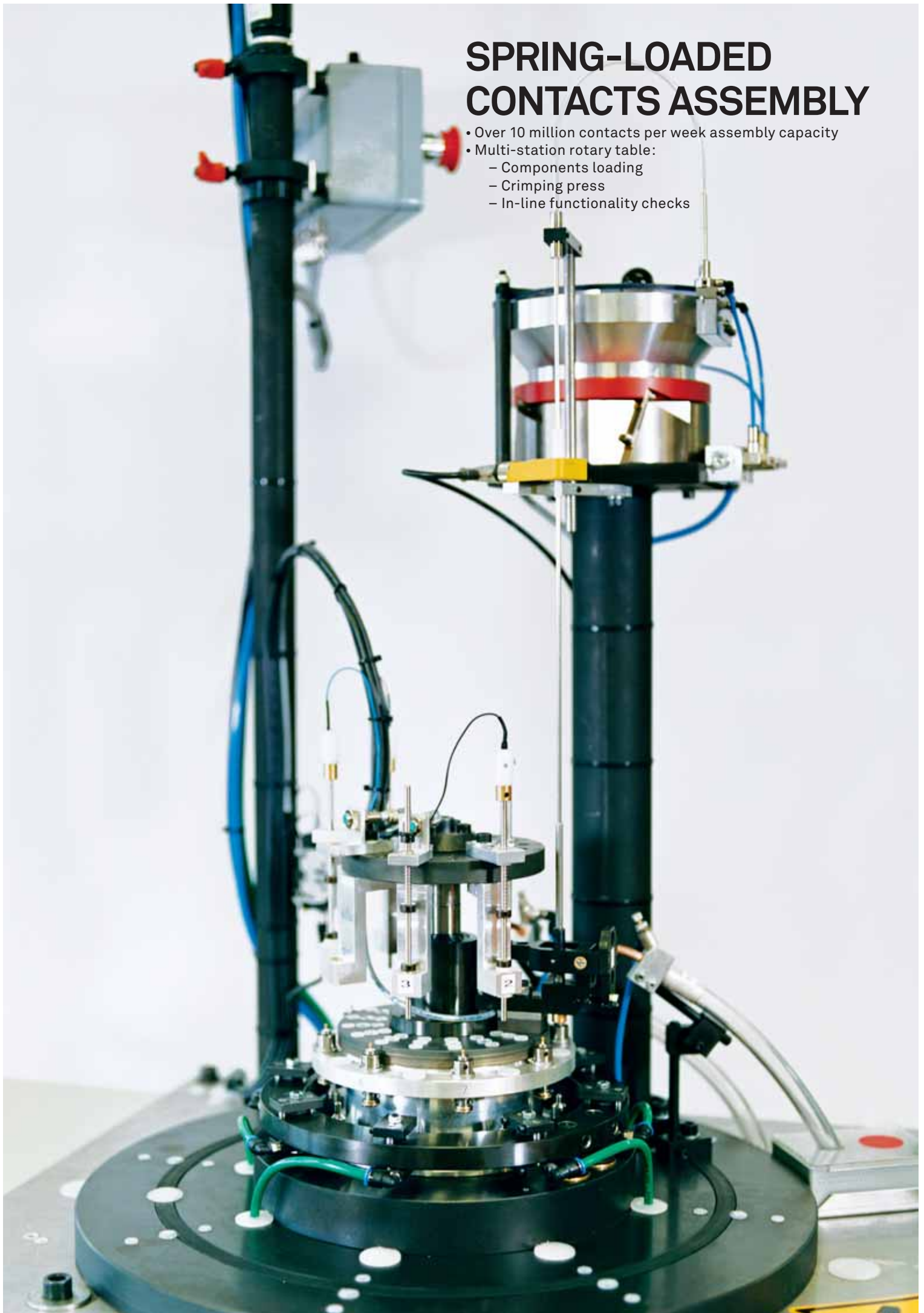

# PLATING LINES

- 6 fully automated plating lines of the vibratory basket type
- 180 million parts / week capacity
- Layer deposition: electro nickel, chemical nickel, tin lead, gold, lead-free tin
- Chemical lab for plating bathes and waste water treatment analysis and maintenance
- Waste water treatment installation with ultra filtration system





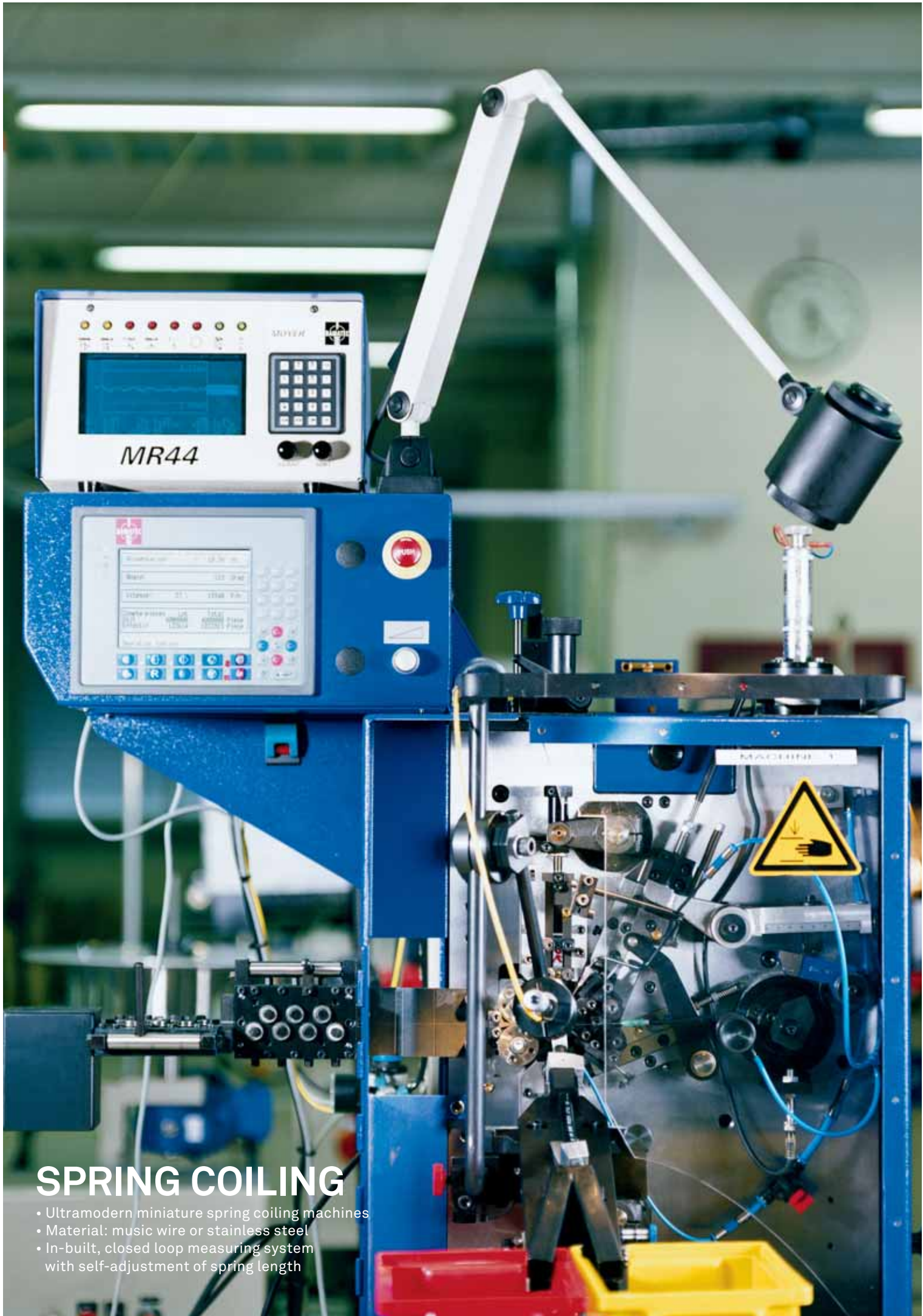

## SPRING COILING

- Ultramodern miniature spring coiling machines
- Material: music wire or stainless steel
- In-built, closed loop measuring system with self-adjustment of spring length



# INJECTION MOULDING

- 25 machines including latest fully programmable control
- Over 2 million parts per week
- Material: thermoplastic PBT, PCT, PA, LCP
- Epoxy plate machining for prototypes and small series

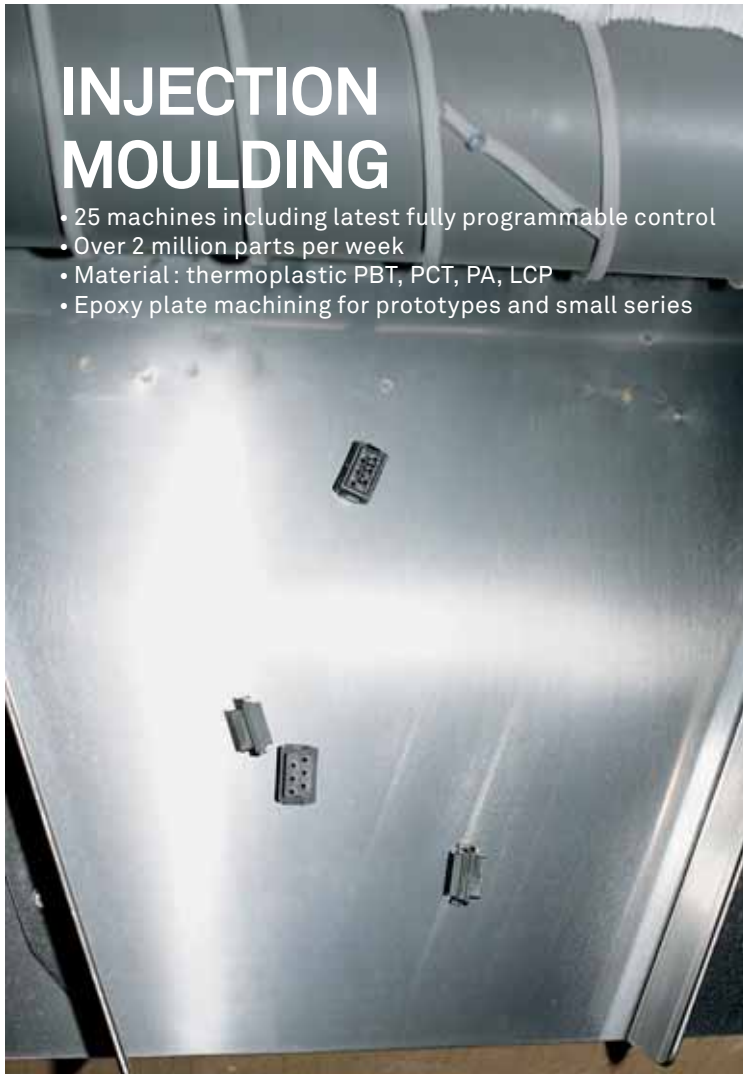

# RAW MATERIAL STOCK

- Brass, bronze and beryllium copper
- Injection moulding plastics
- 36 tons raw material consumption per week
- 1,200 km of brass wire per week

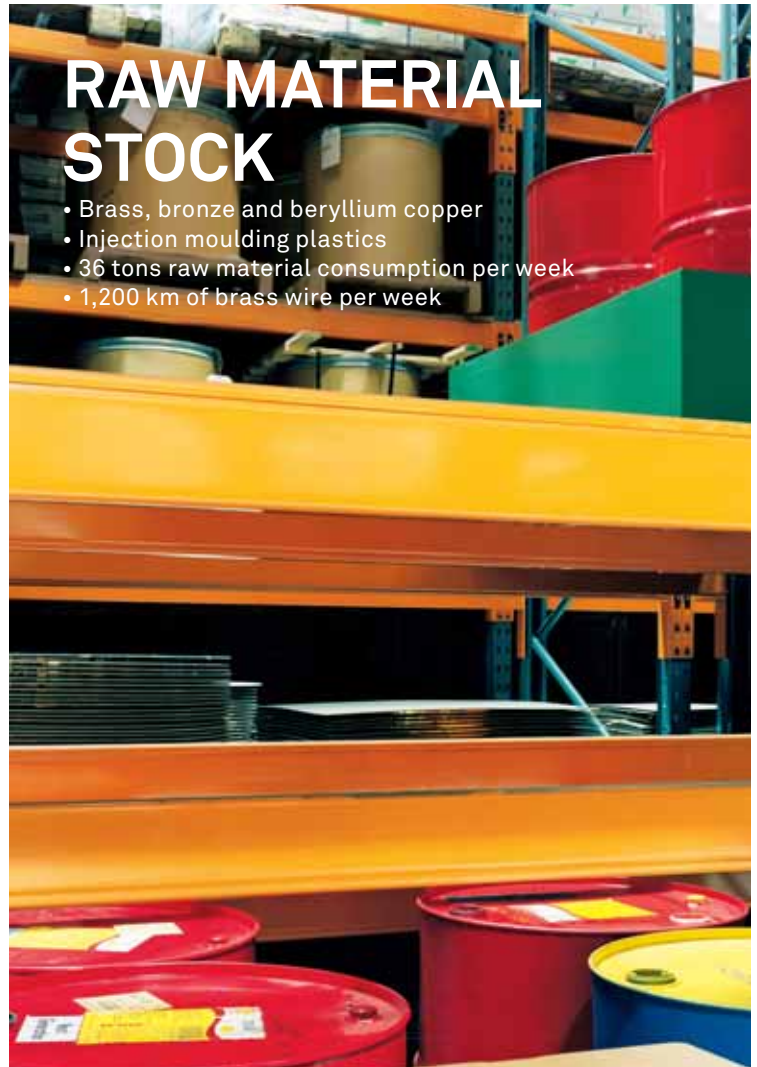

# SECONDARY OPERATIONS

- 85 machines to complement machining of elaborated turned parts
- Typical operations: bleeding hole, solder cup, press-fit, slanted face, polarizing flat, wire wrap
- Multi-station rotary table machines





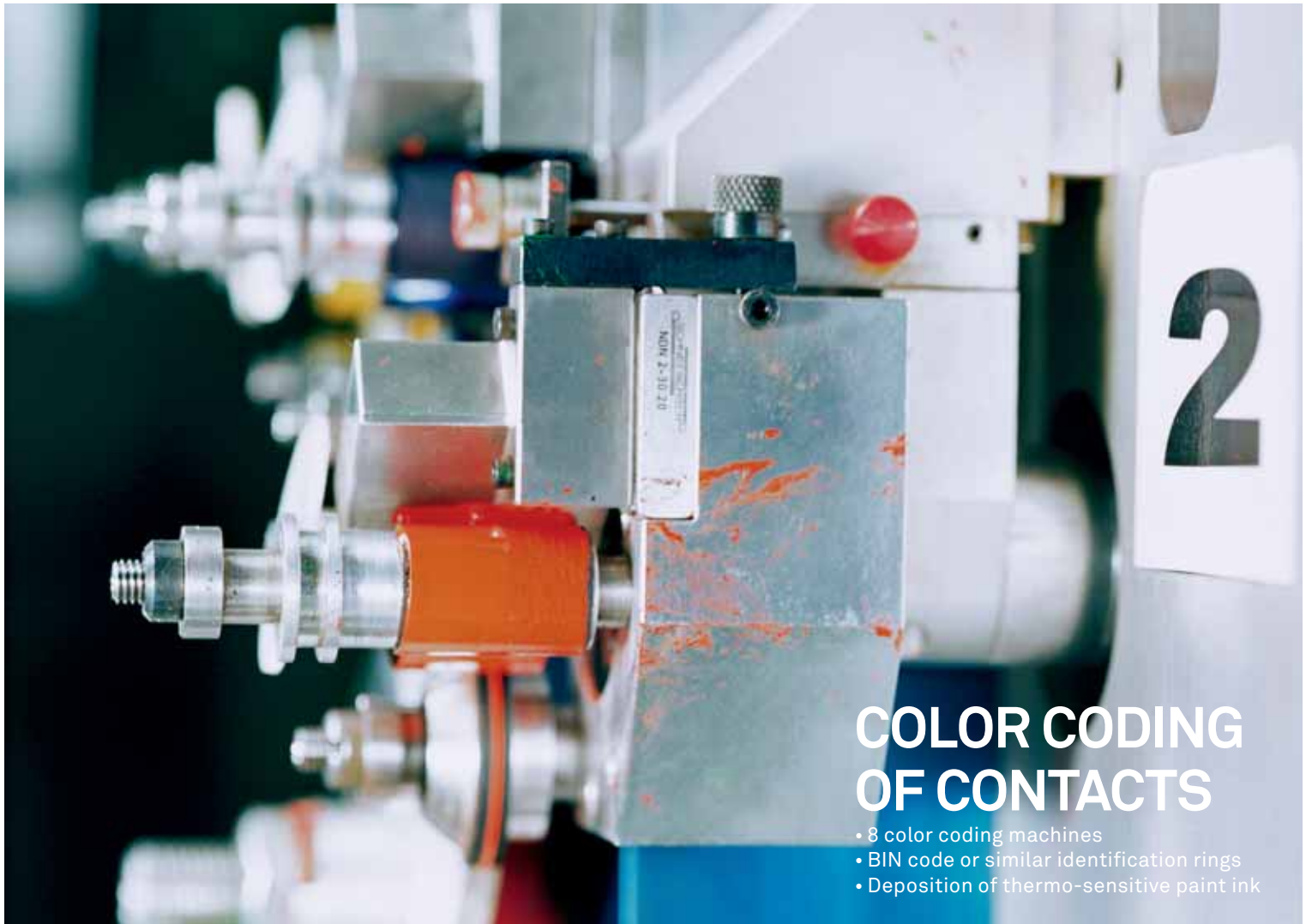

## COLOR CODING OF CONTACTS

- 8 color coding machines
- BIN code or similar identification rings
- Deposition of thermo-sensitive paint ink



## MECHANICAL WORKSHOP

- Development and realization of automatic assembling equipment
- Construction of mould tools
- Maintenance team for production equipment

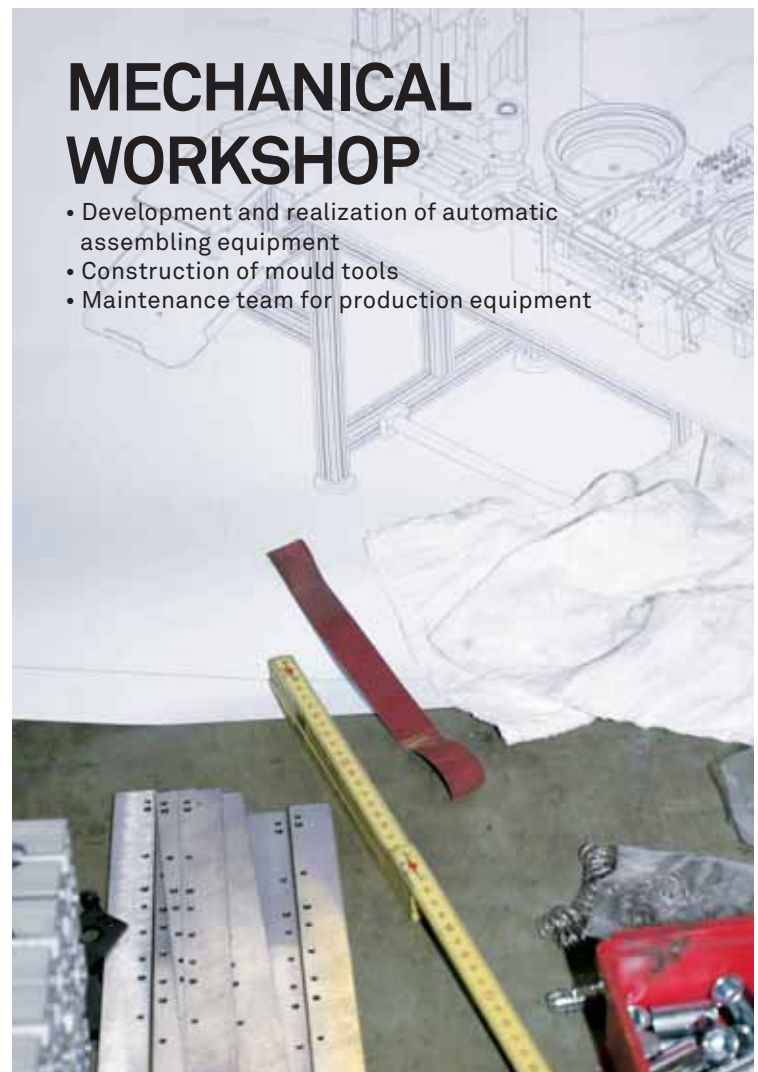

# INSPECTION AND TEST LAB

- Laboratory for dimensional, mechanical, electrical and environmental testing
- First article inspection and new product qualification

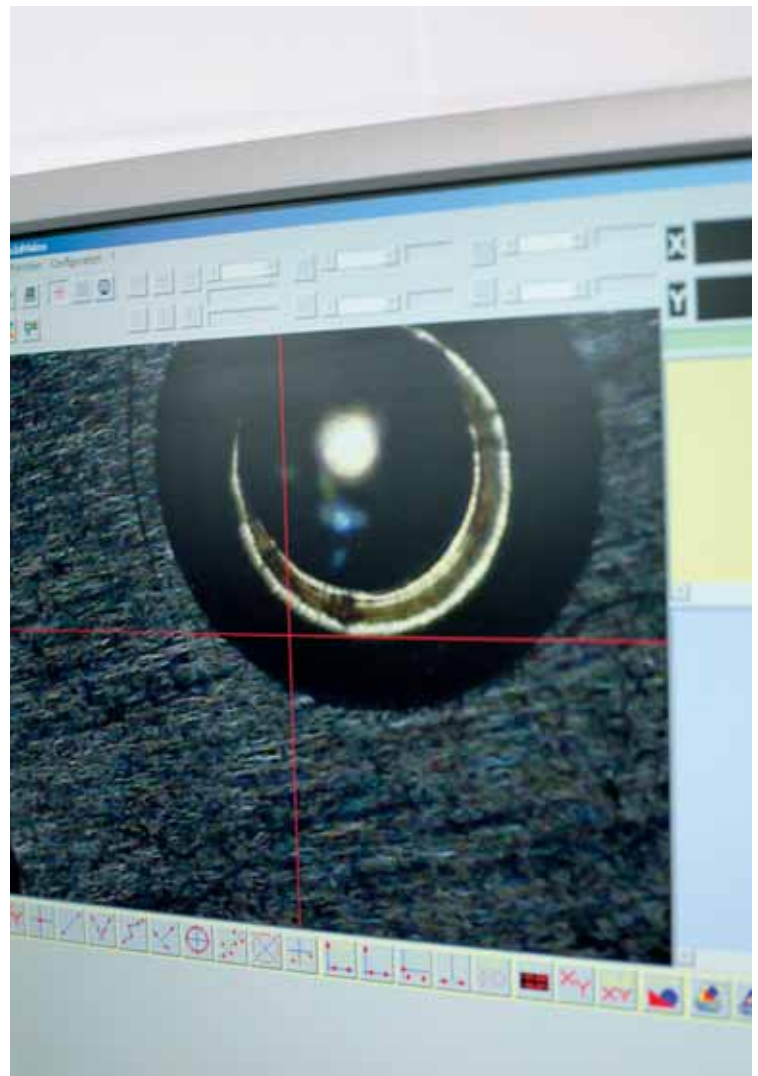
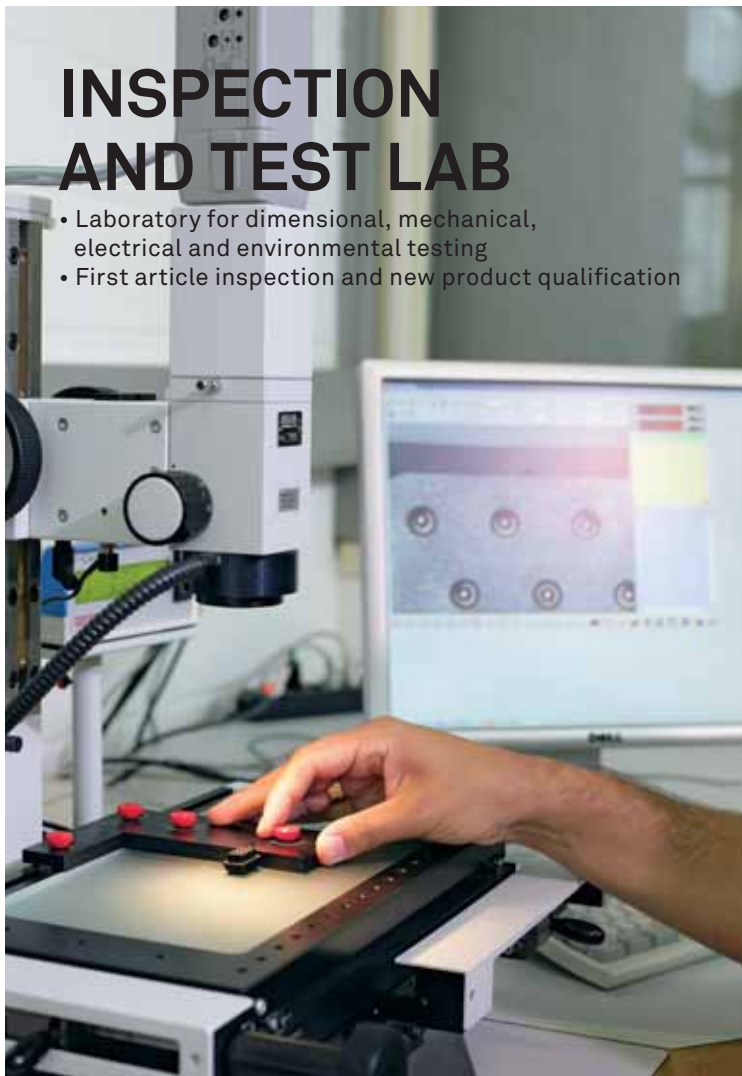

# SALES AND MARKETING DEPARTMENT

- Highly experienced sales force (Key Account Managers – Sales Assistants)
- Languages spoken: French, English, German, Spanish, Italian, Japanese, Finnish, Chinese, Korean



**preci-dip**





# PROFIT FROM OUR WORLDWIDE RECOGNITION

# ADVANTAGE CLIENT

Awards from prestigious institutions and customers. Major certifications. Worldwide recognition. For ongoing innovation, perfect teamwork, environmental responsibility as well as entrepreneurial excellence and sustained growth. In short, for swiss quality.



Excellence and sustained growth – the reason why PRECI-DIP received the Entrepreneur of the Year Award for Western Switzerland.

**DEMAND THE BEST SOLUTIONS  
FOR YOUR IDEAS**

# **OUR CUSTOM DESIGN**

A competitive edge, the ability to innovate, and high productivity are some of the core values at PRECI-DIP. When it comes to Custom Design, there's an additional value: Teamwork.

Time and again, turning customer ideas and imagination into reality is a very special challenge. This is one of PRECI-DIP's core strengths.

Everything under one roof: the incomparable advantage of PRECI-DIP becomes even more obvious when it comes to Custom Design. Ready access to material resources is as critical as the expertise of our engineers and the art of developing and designing our own production equipment.

Our experience with countless standard products and more than 20,000 references underlie the incessant development of new top-quality products designed with cost-effectiveness and efficiency in mind. PRECI-DIP has integrated Product Development and Product Engineering into one Design Office to create the necessary synergies for best results and top product quality.

Companies in all industrial sectors value their collaboration with PRECI-DIP for complete product and component solutions – today and tomorrow.

Your PRECI-DIP Team welcomes your Custom Design challenge!



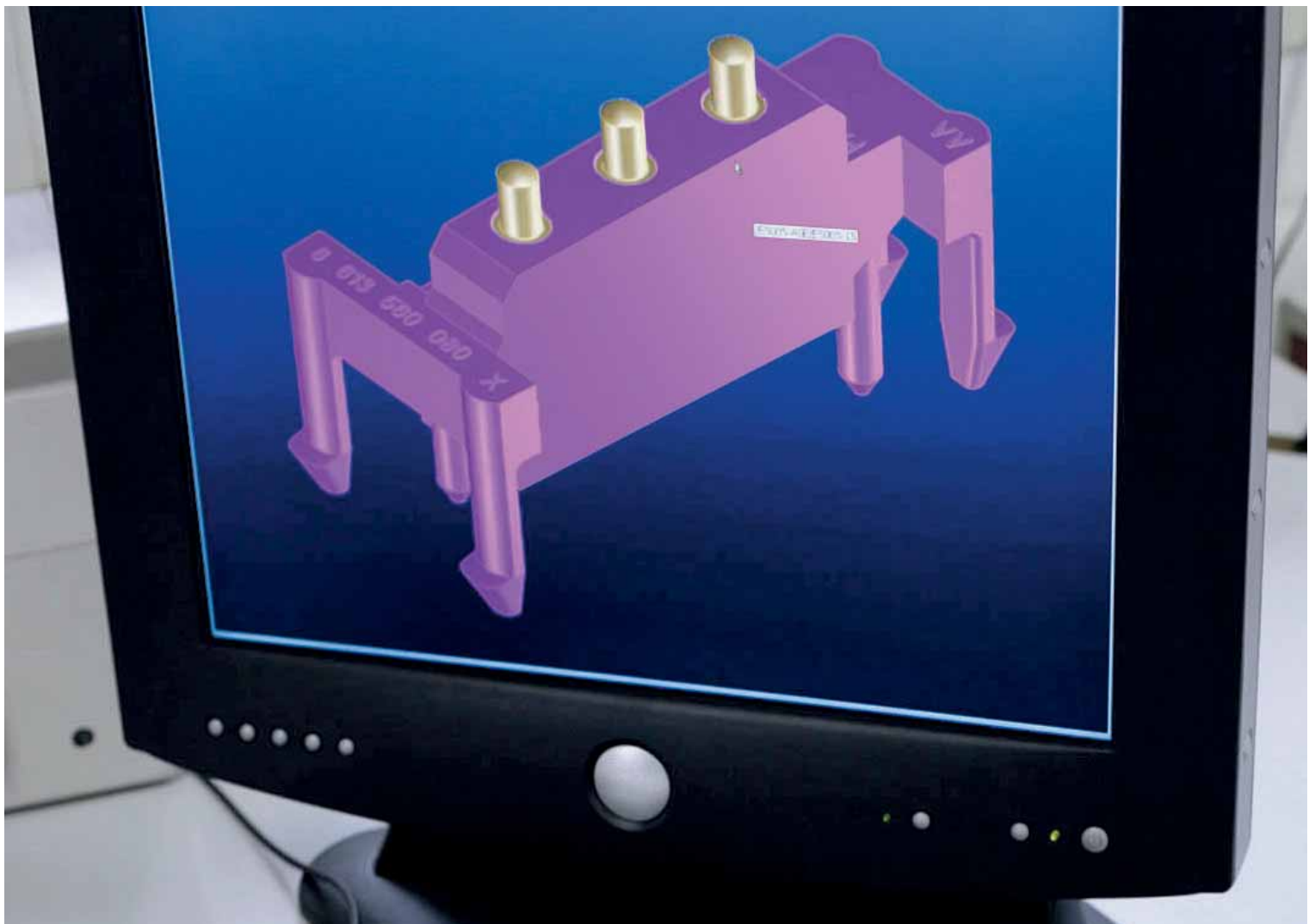

# CHOOSE THE BEST CONNECTION AROUND THE WORLD

More than 100 Distributors around the world distribute PRECI-DIP products across the five continents



## EUROPE

4 x AUSTRIA  
4 x BELGIUM  
2 x BULGARIA  
2 x BYELORUSSIA  
1 x CROATIA  
4 x CZECH REPUBLIC  
4 x DENMARK  
4 x ESTONIA  
4 x FINLAND  
6 x FRANCE  
5 x GERMANY  
2 x GREECE  
4 x HUNGARY  
1 x IRELAND  
2 x ISRAEL  
4 x ITALY  
1 x LATVIA  
3 x LITHUANIA  
4 x NETHERLANDS  
4 x NORWAY  
4 x POLAND  
3 x PORTUGAL  
2 x ROMANIA  
4 x RUSSIA  
2 x SERBIA  
4 x SLOVAKIA  
4 x SPAIN  
3 x SWEDEN  
4 x SWITZERLAND  
2 x TURKEY  
5 x UNITED KINGDOM  
2 x UKRAINE

## USA AND CANADA

17 x USA AND CANADA  
4 x MIL DISTRIBUTORS

## ASIA

13 x CHINA  
2 x INDIA  
2 x INDONESIA  
3 x JAPAN  
1 x SOUTH KOREA  
2 x MALAYSIA  
2 x SINGAPORE  
1 x TAIWAN  
2 x THAILAND  
1 x VIETNAM

## OCEANIA

1 x AUSTRALIA  
1 x NEW ZEALAND

## AFRICA

1 x SOUTH AFRICA



**ENJOY THE BENEFITS**

# **HEADED FOR SUCCESS**

- **COMPLETE RANGE OF HIGHLY RELIABLE INTERCONNECT COMPONENTS**
- **DIVERSE FIELDS OF APPLICATION**
- **IN-HOUSE MANUFACTURING – FROM RAW MATERIAL TO FINISHED PRODUCT**
- **EFFECTIVE MANAGEMENT SYSTEM**
- **HIGHLY SKILLED AND MOTIVATED WORKFORCE**
- **STRONG CUSTOMER SUPPORT**
- **CUSTOM DESIGN**
- **COMPETITIVE PRICING, FLEXIBILITY AND SWISS QUALITY**
- **WORLDWIDE PRESENCE**
- **PRESTIGIOUS CLIENT BASE**





# **PRECI-DIP**

# **INTERCONNECT**

# **COMPONENTS**

- **SPRING-LOADED CONNECTORS**
- **PCB CONNECTORS**
- **DIL SOCKETS**
- **PGA / BGA / PLCC SOCKETS**
- **SCREW-MACHINED CONTACTS**
- **CUSTOM DESIGN CONNECTORS**







preci-dip

WWW.PRECIDIP.COM TEL +41 32 421 04 00 SALES@PRECIDIP.COM

**GENERAL INFORMATION**

NUMERICAL INDEX

25

26

# STANDARD PRODUCTS

<b>SPRING - LOADED CONNECTORS</b>	<b>28</b>
GENERAL SPECIFICATIONS	31
FINE PITCH CONNECTORS	32
LOW RESISTANCE MODULAR CONNECTORS	33, 35
BASIC MODULAR CONNECTORS	34, 36
FLOATING MOUNT CONNECTORS	38
PAD CONNECTORS	39

<b>PCB CONNECTORS</b>	<b>40</b>
GENERAL SPECIFICATIONS	43
1 mm	44
1.27 mm	46
1.778 mm	55
1.8 mm	55
2 mm	57
2.54 mm	69
JUMPERS	122

<b>DIL SOCKETS</b>	<b>124</b>
GENERAL SPECIFICATIONS	127
DIL SOCKETS AND CARRIERS	128
TO SOCKETS	149
STAGGERED DIL SOCKETS	150
DISPLAY SOCKETS	144, 151

<b>PGA / BGA / PLCC SOCKETS</b>	<b>152</b>
GENERAL SPECIFICATIONS	155
1 mm	169
1.27 mm	165
INTERSTITIAL	161
2.54 mm	156

# CONTACTS

<b>CONTACTS</b>	<b>174</b>
SOCKET CONTACT SELECTOR	177
GENERAL TECHNICAL SPECIFICATIONS	178
SOCKET + PIN CONTACTS	179
SPRING-LOADED CONTACTS	180
MIL CONTACTS	182
DATA SHEET CLIP CONTACTS	185

# CUSTOM DESIGN

<b>CUSTOM DESIGN</b>	<b>192</b>
APPLICATION FIELDS FOR TELECOMMUNICATION	
DATA PROCESSING, TRANSPORTATION	
MIL / AERO, AUTOMATION, TEST AND MEASUREMENT	
MEDICAL, PROFESSIONAL AND CONSUMER GOODS	194



preci-dip

WWW.PRECIDIP.COM TEL +41 32 421 04 00 SALES@PRECIDIP.COM

# INTERNET

## INTERNET PRODUCT SEARCH ENGINE

Welcome to our new website. Just click the product tabs and follow the selection steps for the search result to appear.

The login function is intended for authorized dealers and allows for an easy search of inventory.

For more information, please visit our website : [www.precidip.com](http://www.precidip.com)

**DEALERS ZONE**

**PRODUCTS SEARCH ENGINE**

**PCB CONNECTORS**  
 SPRING-LOADED CONNECTORS / POGO PIN CONNECTORS  
 SLC connectors, PAD connectors

**PCB CONNECTORS**  
 Socket connectors, Pin connectors  
 Square Pin connectors, Headers  
 Jumpers

**MIL CONTACTS**  
 DIL / SIL / TO SOCKETS  
 DIL Sockets, DIL Headers  
 SIL Sockets, TO Sockets

**PGA / BGA / PLCC SOCKETS**

**CONTACTS**  
 Sockets Contacts, Pin Contacts  
 Spring-loaded contacts

**MIL CONTACTS**  
 Spring-loaded connector 2mm pitch

**MARKETS**  
 EFFECTIVE SOLUTIONS FOR THE ENGINEERING INDUSTRY

**NEWS**  
**GLOBAL ELECTRONICS**  
 Global Electronics Corp : authorized distributor in Japan

**OUR PRODUCTS**

- Contacts
- Spring-Loaded Connectors / Pogo Pin Connectors
- PCB Connectors
- Custom Design
- DIL / SIL / TO Sockets
- PGA / BGA / PLCC Sockets

Discover our products

**RESOURCES**  
 Literature  
 Catalog  
 CAD catalog

**ABOUT PRECI-DIP**  
 Career  
 Contact us

**OTHER INFO**  
 Feedback  
 Legal disclaimer  
 Cross references

**NEWSLETTER**  
 Stay informed!

Company

Last name, first name

Email

**subscription**

© 2014 - PRECI-DIP SA. All rights reserved

powered by **artionet**





preci-dip

WWW.PRECIDIP.COM TEL +41 32 421 04 00 SALES@PRECIDIP.COM

# GENERAL INFORMATION

## PART NUMBERS AND PRODUCT IDENTIFICATION

PRECI-DIP products are all identified with a unique part number. These numbers are built with up to 5 groups of digits separated by dashes. Each of these groups has its own signification, making it possible to identify the major characteristics of the product from the part number.

Please find below a brief explanation of PRECI-DIP identification codes for connectors and sockets:

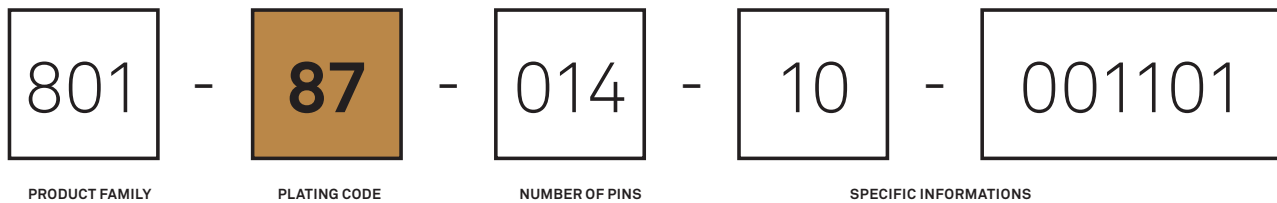

### PRODUCT FAMILY

- 81 x, 8Px Spring-loaded connectors
- 1 xx, 2xx DIL sockets
- 3xx, 4xx, 8xx PCB connectors
- 5xx BGA, PGA and PLCC sockets
- 6xx, 7xx Carriers
- 9xx Circular connectors, TO sockets

### PLATING CODE

The standard plating codes are listed and specified in the catalog section Contacts under General technical specifications at page 178. Tin-plated PRECI-DIP products had to be changed to become RoHS compliant and have received a new part number to allow clear identification. Tin-lead plating was replaced by pure tin plating and the old plating code 9x was replaced by 8x.

### NUMBER OF PINS

These figures indicate always the total number of contacts of the product.

### SPECIFIC INFORMATIONS

The last two groups of digits can have different significations depending on the product family:

- Type of terminations (PCB connectors):
 

10	Straight solder pin
20	Right angle solder pin
30 and 40	SMD
5x	Wire-wrap
6x	Solderless press fit
- Type of clip (DIL sockets):
 

00	no clip	4x	4 finger
31	3 finger	6x	6 finger
- Packaging versions:
 

003101	for box or tube packaging
003191	for Tape and Reel packaging

### EXAMPLES

- 114-87-628-41-134191: DIL socket, 28 pins, 4 finger clip, tape and reel packaging
- 803-87-014-10-003101: PCB connectors, 14 pins, with straight solder pins, box packaging

## ROHS-COMPLIANT PLATING

All products displayed in this catalog are compliant with the European Directive 2002/95/EC on the restriction of the use of certain hazardous substances in electrical and electronic equipment (RoHS).



precidip

WWW.PRECIDIP.COM TEL +41 32 421 04 00 SALES@PRECIDIP.COM

# INDEX

REFERENCE	PAGE	REFERENCE	PAGE	REFERENCE	PAGE	REFERENCE	PAGE
110...01-505101	150	315...01-881101	69	422...41-001101	81	612...41-001101	143
110...01-XXX101	151	315...41-001101	69	423...41-001101	81	614...XX-XXX101	143
110...10-XXX101	151	315...41-003101	69	426...41-XXX101	82	614...XX-XXX112	158
110...41-001101	129	316...41-XXX101	74			614...XX-XXX144	162
110...41-001151	129	317...01-687101	55				
110...41-005101	129	317...41-005101	55	446...41-035101	79		
110...41-105101	132	317...41-022101	55	446...41-036101	79	712...41-001101	83
110...41-105161	133	317...41-026101	55			714...31-008101	84
110...41-605101	130					714...31-012101	84
110...41-801101	131			450...00-001101	101	714...31-018101	84
111...41-001101	129	322...41-001101	81	450...00-006101	100	714...41-001101	83
114...41-117101	134	323...41-001101	81	450...00-013101	102	714...41-014101	83
114...41-134161	135	326...41-XXX101	82	450...00-018101	109		
115...41-001101	137			450...00-106101	105		
115...41-003101	137			450...01-899101	105	800...10-001101	108
116...41-XXX101	138	346...41-035101	79	451...00-XXX101	103	800...10-002101	108
117...41-005101	141	346...41-036101	79	453...00-001101	121	800...12-002101	110
117...41-105101	141			456...00-014101	107	800...12-422101	110
						800...20-001101	111
		350...00-001101	101			800...20-004101	112
121...41-001101	139	350...00-006101	100	460...00-001101	120	800...20-101101	111
122...41-001101	139	350...00-012101	56	463...00-001101	121	800...22-002101	112
123...41-001101	139	350...00-013101	102	470...00-001101	120	800...30-001101	113
124...41-002101	139	350...00-018101	109	473...00-001101	121	800...30-480101	113
		350...00-019101	100	480...00-001101	120	800...30-507101	39
		350...00-024101	100	483...00-001101	121	800...32-002101	114
146...41-XXX101	142	350...00-106101	105			800...40-001101	115
		350...00-206101	106			800...65-001101	116
		350...01-609101	102	499...10-003101	76	800...66-001101	116
150...00-012101	141	350...01-666101	101	499...10-009101	104	800...6B-002101	117
150...00-106101	146	350...01-714101	101				
150...00-106161	147	350...01-899101	105	510...01-504101	151		
150...01-899161	147	351...00-XXX101	103	510...XX-XXX101	156	801...10-001101	87
150...00-XXX101	145	353...00-001101	121	514...XX-XXX117	156	801...10-003101	89
151...00-XXX101	145	356...00-014101	107	514...XX-XXX148	166	801...10-004101	99
				514...XX-XXX154	161	801...10-005101	90
				514...XX-XXX159	169	801...10-012101	86
160...00-001101	148	360...00-001101	120	517...XX-XXX111	161	801...10-101101	88
170...00-001101	148	363...00-001101	121	518...XX-XXX105	165	801...10-132101	75
180...00-001101	148	370...00-001101	120	518...XX-XXX106	165	801...10-143101	88
		373...00-001101	121			801...10-173101	75
		380...00-001101	120			801...10-216101	91
210...41-001101	129	383...00-001101	121	540...XXX-17-400	172	801...10-268101	85
217...41-005101	141			540...XXX-24-008	173	801...10-458101	86
				546...XX-XXX135	157		
		399...10-003101	76	546...XX-XXX136	157		
299...10-001101	144	399...10-009101	104	546...XX-XXX147	161	801...20-001101	92
299...10-002101	144					801...20-002101	92
299...XX-001101	144					801...20-101101	93
						801...20-442101	92
		410...01-640101	72	550...XX-XXX101	158	801...30-001101	95
310...01-609101	70	410...10-001101	150	550...XX-XXX135	162	801...30-002101	94
310...01-640101	72	410...10-002101	150	550...XX-XXX152	167	801...30-480101	94
310...01-666101	70	410...41-001101	70	550...XX-XXX166	166	801...40-001101	96
310...01-754101	72	410...41-105101	77	558...XX-XXX101	165	801...40-002101	96
310...41-001101	70	411...41-001101	71	558...XX-XXX102	169	801...53-001101	98
310...41-105101	77	414...41-134101	77	558...XX-XXX103	169	801...65-001101	97
310...41-205101	78	415...41-001101	69	558...XX-XXX104	167	801...65-410101	80
311...41-001101	71	416...41-XXX101	74			801...66-001101	97
314...01-899101	77						



precip-dip

WWW.PRECIPDIP.COM TEL +41 32 421 04 00 SALES@PRECIPDIP.COM

# INDEX

REFERENCE	PAGE	REFERENCE	PAGE	REFERENCE	PAGE	REFERENCE	PAGE
802...10-001101	108	811...30-014101	36	831...30-001101	61	860...10-001101	45
802...10-002101	108	811...30-015101	36	831...30-242101	61	860...40-001101	45
802...10-193101	109	811...30-016101	36	831...40-001101	62	861...10-001101	44
802...12-002101	110	811...30-017101	36	831...64-001101	63	861...40-001101	44
802...20-001101	111	811...30-021101	37	831...64-242101	63		
802...22-002101	112	811...30-022101	37	832...10-001101	64		
802...30-001101	113	811...30-023101	37	832...12-002101	64	880...10-001101	68
802...30-480101	113	811...30-024101	37	832...20-001101	65	880...20-001101	68
802...30-507101	39	811...30-025101	37	832...22-002101	65	882...10-001101	68
802...32-002101	114	811...30-026101	37	832...30-001101	66	882...20-001101	68
802...65-001101	116	811...30-027101	37	832...32-002101	66		
802...66-001101	116			833...10-001101	57		
802...6B-002101	117			833...10-245101	59	890...10-XXX101	118
		813...10-014101	34	833...10-273101	57	890...20-XXX101	119
		813...10-015101	34	833...10-287101	58	892...10-XXX101	118
803...10-001101	87	813...10-016101	34	833...10-453101	58	892...20-XXX101	119
803...10-003101	89	813...10-017101	34	833...10-457101	58	894...10-001101	118
803...10-004101	99	813...10-474101	34	833...20-001101	60	894...20-001101	119
803...10-005101	90	813...30-001101	35	833...30-001101	61		
803...10-012101	86	813...30-002101	35	833...30-245101	61		
803...10-132101	75	813...30-003101	35	833...64-001101	63	8FM...02-146	96
803...10-216101	91	813...30-004101	35	833...64-245101	63	8FM...02-278	96
803...10-249101	91	813...30-005101	35	837...30-291101	62	8MM...02-131	39
803...10-268101	85	813...30-006101	35			8MM...02-279	115
803...10-269101	90	813...30-007101	35			8PC...01-828	32
803...20-001101	92	813...30-014101	36	850...10-001101	51	8PD...01-812	32
803...30-001101	95	813...30-015101	36	850...20-001101	52	8PM...02-219	38
803...30-002101	94	813...30-016101	36	850...30-001101	53	8PM...02-131	38
803...30-480101	94	813...30-017101	36	850...30-135101	53	8PM...02-260	38
803...53-001101	98	813...30-021101	37	850...40-001101	54		
803...65-001101	97	813...30-022101	37	850...40-251101	54		
803...65-410101	80	813...30-023101	37			917...41-005101	149
803...66-001101	97	813...30-024101	37			917...41-053101	149
		813...30-025101	37	851...10-001101	46		
		813...30-026101	37	851...10-477101	47		
		813...30-027101	37	851...20-001101	48	999-11-110-10	122
804...10-193101	109			851...30-001101	49	999-11-112-10	122
804...12-002101	110			851...30-136101	49	999-11-113-10	122
804...22-002101	112			851...40-001101	50	999-11-210-10	122
804...6B-002101	117	821...30-012101	33	851...40-252101	50	999-11-210-11	122
805...10-001101	87	821...30-013101	33			999-11-220-10	122
805...10-003101	89	821...30-014101	33			999-11-220-11	122
805...10-005101	90	821...30-015101	33			999-11-230-10	122
805...10-012101	86	823...30-012101	33	852...10-001101	51	999-11-230-11	122
805...10-132101	75	823...30-013101	33	852...10-002101	51		
805...10-229101	73	823...30-014101	33	852...20-001101	52		
		823...30-015101	33	852...20-002101	52		
				852...30-001101	53	999-19-210-00	123
811...10-014101	34			852...30-002101	53	999-19-210-02	123
811...10-015101	34	830...10-001101	64	852...30-051101	54	999-19-210-06	123
811...10-016101	34	830...12-002101	64	853...10-001101	46	999-19-220-00	123
811...10-017101	34	830...20-001101	65	853...10-002101	46	999-19-310-00	123
811...30-001101	35	830...22-002101	65	853...20-001101	48	999-19-310-02	123
811...30-002101	35	830...30-001101	66	853...20-002101	48	999-19-310-06	123
811...30-003101	35	830...32-002101	66	853...30-001101	49	999-19-320-00	123
811...30-004101	35	830...40-001101	67	853...30-002101	49		
811...30-005101	35	831...10-001101	57	853...30-051101	50		
811...30-006101	35	831...10-230101	58	854...10-001101	51	999-51-110-10	122
811...30-007101	35	831...10-242101	59	854...20-001101	52	999-51-112-10	122
811...30-008101	35	831...10-273101	57	855...10-001101	46	999-51-113-10	122
		831...20-001101	60	855...20-001101	48		



# SPRING-LOADED CONNECTORS

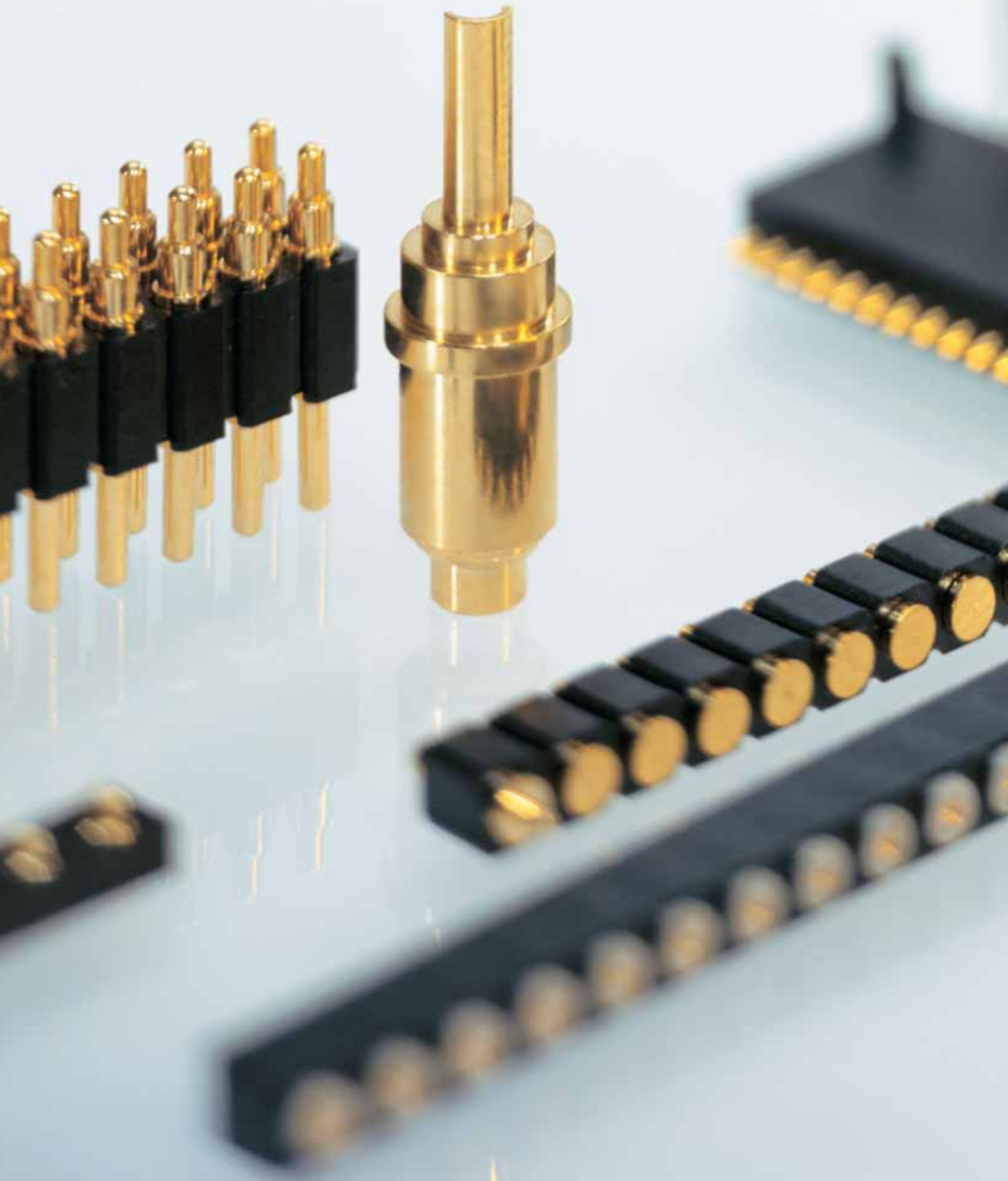

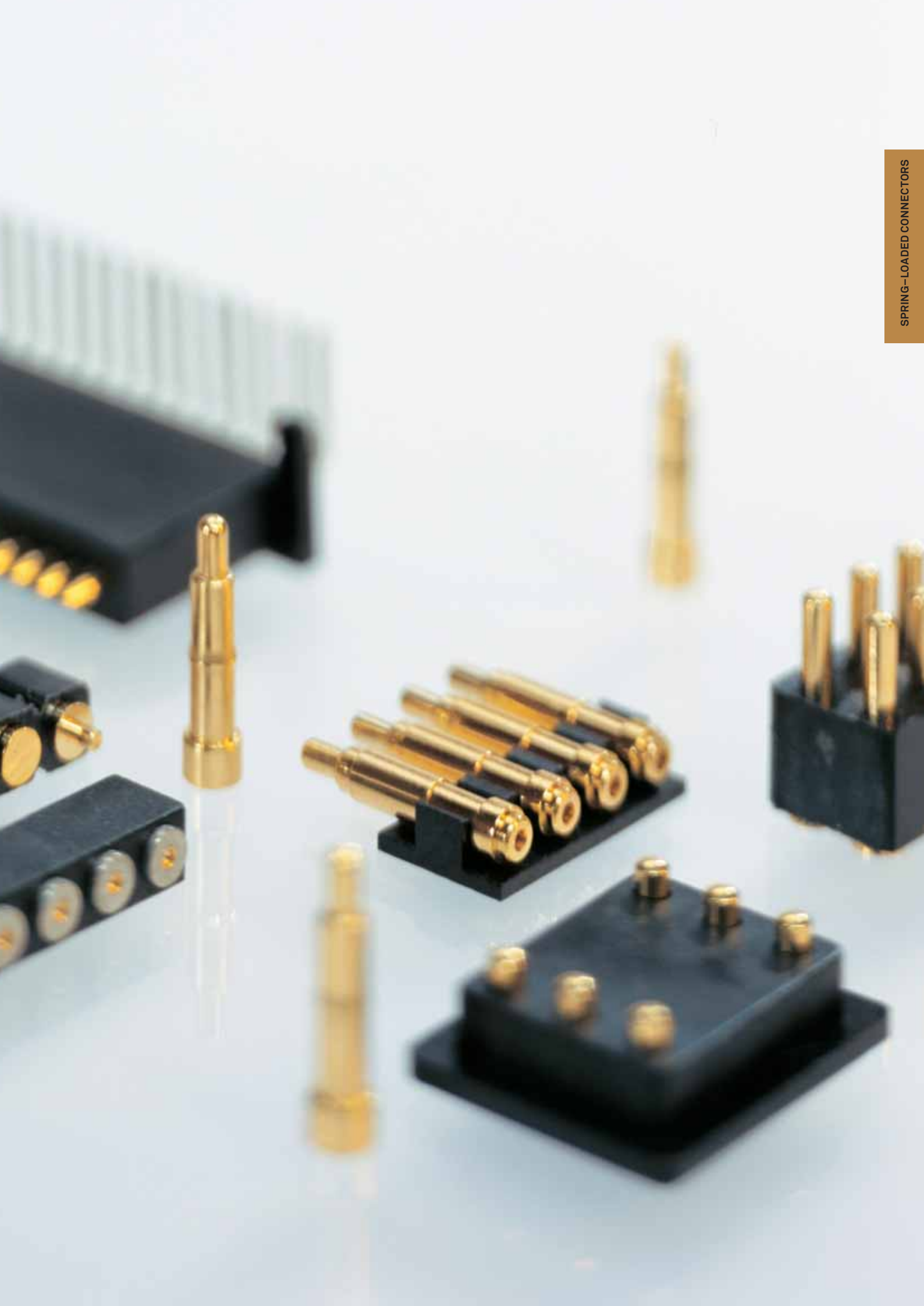



precip-dip

WWW.PRECIDIP.COM TEL +41 32 421 04 00 SALES@PRECIDIP.COM

# QUICK SELECTOR CHART

SPRING-LOADED CONNECTORS AND PAD CONNECTORS

## GRID

1.25 mm	2 mm	2.54 mm
SINGLE ROW	SINGLE ROW	SINGLE ROW
	DOUBLE ROW	DOUBLE ROW

## SLC CONNECTORS

SEE PAGE

Straight solder tail		32		34	34
Right angle solder tail		32			
Surface mount perpendicular			33	33	35, 36
Surface mount perpendicular with positioning pins					37
Surface mount parallel					38
SIM card socket					38

## PAD CONNECTORS

Surface mount perpendicular				39	39
Surface mount parallel				39	





preci-dip

WWW.PRECIDIP.COM TEL +41 32 421 04 00 SALES@PRECIDIP.COM

# SPRING-LOADED CONNECTORS PAD CONNECTORS

## GENERAL SPECIFICATIONS

The values listed below are general specs applying for PRECI-DIP spring-loaded connectors. Please see individual catalog page for additional and product specific technical data.

<b>OPERATING TEMPERATURE RANGE</b>	-55 ... +125 °C (-55 °... +85 °C with music wire spring)
<b>CLIMATIC CATEGORY (IEC)</b>	55/85/21
<b>OPERATING HUMIDITY RANGE</b>	Annual mean 75%
<b>MAX. WORKING VOLTAGE</b>	100 V <sub>RMS</sub> /150 V <sub>DC</sub> (2.54 mm grid)



PRECI-DIP connectors designated « Series Preci-Dip Connector » are recognized by UL LLC and listed under « Connectors for Use in Data, Signal, Control and Power Applications », File Nr. E174442.

## MECHANICAL CHARACTERISTICS

	BASIC HOLLOW PISTON TYPE	LOW RESISTANCE SHAPED PISTON TYPE	LOW RESISTANCE CLIP IN-LINE DESIGN TYPE
<b>MIN. INITIAL HEIGHT</b>	3 mm	6 mm	10 mm
<b>STROKE/HEIGHT RATIO</b>	Max. 0.3	Max. 0.2	Max. 0.15
<b>MAX STROKE</b>	2 mm	2 mm	1.5 mm
<b>MIN. INITIAL SPRING FORCE</b>	0.2 N	0.2 N	0.2 N

## ELECTRICAL CHARACTERISTICS

<b>INSULATION RESISTANCE BETWEEN ANY TWO ADJACENT CONTACTS</b>	Min. 10'000 MΩ at 500 V <sub>AC</sub>
<b>CAPACITANCE BETWEEN ANY TWO ADJACENT CONTACTS</b>	Max. 1 pF

## ENVIRONMENTAL CHARACTERISTICS

The sockets withstand the following environmental tests without mechanical and electrical defects:

- Dry heat steady state IEC 60512-11-9.11i / 60068-2-2.Bb: 125 °C, 16 h
  - Damp heat cyclic IEC 60512-11-12.11m / 60068-2-30.Db: 25/55 °C, 90 – 100 %rH, 1 cycle of 24 h
  - Cold steady state IEC 60512-11-10.11j / 60068-2-1.A: -55 °C, 2 h
  - Thermal shock IEC 60512-11-4.11d / 60068-2-14.Na: -55/125 °C, 5 cycles 30 min
  - Sinusoidal vibrations IEC 60512-6-4.6d / 60068-2-6.Fc: 10 to 500 Hz, 10 g, 1 octave/min, 10 cycles for each axis
  - Shock IEC 60512-6-3.6c / 60068-2-27.Ea: 50 g, 11 ms, 3 shocks in three axis
- During the above two tests, no contact interruption >50 ns does appear.

- Solderability J-STD-002A, Test A, 245 °C, 5 s, solder alloy SnAg3.8Cu0.7
- Resistance to soldering heat J-STD-020C, 260 °C, 20 s
- Moisture sensitivity J-STD-020C level 1



preci-dip

WWW.PRECIDIP.COM TEL +41 32 421 04 00 SALES@PRECIDIP.COM

# SPRING-LOADED CONNECTORS

1.25 mm GRID / SINGLE ROW / SOLDER TAIL

Fine pitch connectors with spring-loaded contacts (SLC), solder tail. High-rel contacts with clip, patented in-line design.

## TECHNICAL SPECIFICATIONS (FOR GENERAL SPECS, SEE PAGE 31)

<b>INSULATOR</b>	Black glass filled polyester PCT-GF30-FR	
<b>FLAMMABILITY</b>	UL 94V-0	
<b>PISTON AND BARREL</b>	Brass CuZn36Pb3 (C36000)	
<b>CONTACT CLIP</b>	Beryllium copper (C17200)	
<b>SPRING</b>	Stainless steel X12 CrNi177, DIN 17224	
<b>MAX. STROKE</b>	1.4 mm	
<b>FORCES</b>	0.2 N initial	0.36 N at 1/2 stroke
<b>MECHANICAL LIFE</b>	40'000 cycles	
<b>OPERATING CURRENT</b>	Max. 2 A	
<b>CONTACT RESISTANCE</b>	20 mΩ (static measurement, halfway position)	

## ORDERING INFORMATION ROHS COMPLIANT PARTS

PLATING CODE	PIN	PISTON
28	Tin	0.3 μm min. gold

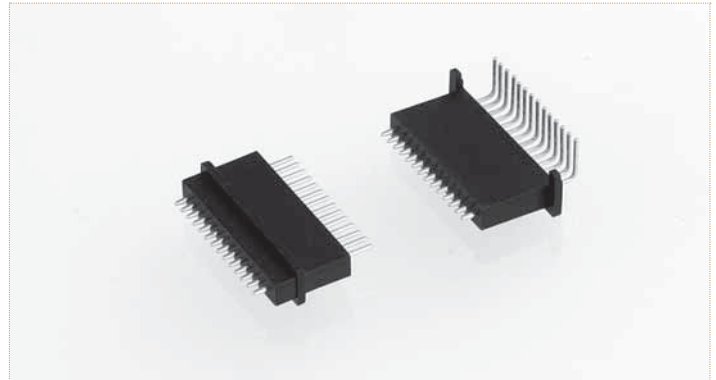

See page 178 for plating specs.

Surface mount miniature SLC connectors available on request.

Please consult.

### 8PD-28-0014-01-812

Straight SLC connector, solder tail, single row

Standard number of contacts: 14

Please consult for other pin number or partially equipped connectors

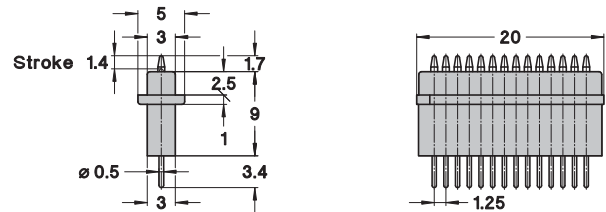

### 8PC-28-0014-01-828

Right angle SLC connector, solder tail, single row

Standard number of contacts: 14

Please consult for other pin number or partially equipped connectors

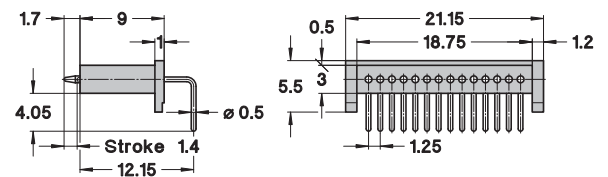



preci-dip

WWW.PRECIDIP.COM TEL +41 32 421 04 00 SALES@PRECIDIP.COM

# SPRING-LOADED CONNECTORS

2 mm GRID / SINGLE ROW / DOUBLE ROW / SURFACE MOUNT

Basic modular connectors with spring-loaded contacts (SLC), surface mount. Contacts with shaped piston design for low profile.

## TECHNICAL SPECIFICATIONS (FOR GENERAL SPECS, SEE PAGE 31)

<b>INSULATOR</b>	Black glass filled polyester LCP-GF30-FR
<b>FLAMMABILITY</b>	UL 94V-0
<b>PISTON AND BARREL</b>	Brass CuZn36Pb3 (C36000)
<b>SPRING</b>	Stainless steel X12 CrNi177, DIN 17224
<b>MAX. STROKE</b>	1.1 / 1.4 mm according to total height
<b>FORCES</b>	0.25 N initial                      0.7 N at 0.7 mm stroke
<b>MECHANICAL LIFE</b>	50'000 cycles
<b>OPERATING CURRENT</b>	Max. 3.5 A / 7A peak
<b>CONTACT RESISTANCE</b>	10 mΩ (static measurement, halfway position)
<b>COPLANARITY</b>	
<b>SMD TERMINATIONS</b>	Max. 0.1 mm (measured on 25 mm long connectors)

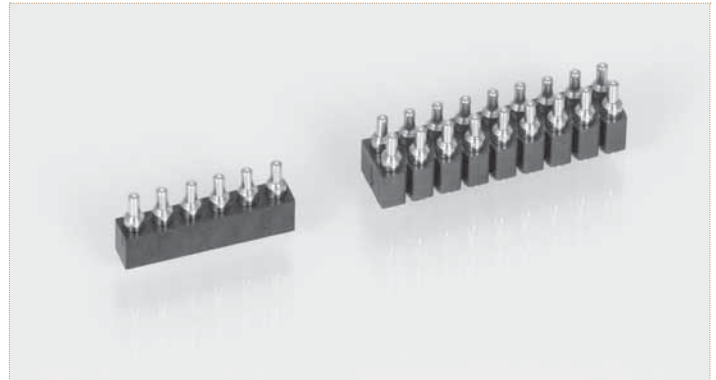

SPRING-LOADED CONNECTORS

## ORDERING INFORMATION ROHS COMPLIANT PARTS

<b>PLATING CODE</b>	<b>BARREL</b>	<b>PISTON</b>
S1	0.25 μm gold	0.5 μm gold

See page 178 for plating specs.

**NNN number of poles.** Replace **NNN** with the requested number of poles, e.g. 821-SS-**NNN**-30-012101 for a single row version with 16 pins becomes 821-SS-**016**-30-012101.

**Bulk:** **T & R Packaging with pick & place cap\* :**

821-S1-**NNN**-30-**XXX**101    821-S1-**NNN**-30-**XXX**191

Surface mount SLC connector, low profile, single row

**AVAILABILITY FROM**    2 to 10 contacts  
(standard number of contacts: 10)

\*Please consult [www.precidip.com](http://www.precidip.com) for availability size of tape, size of reel, number of components per reel and packing units.

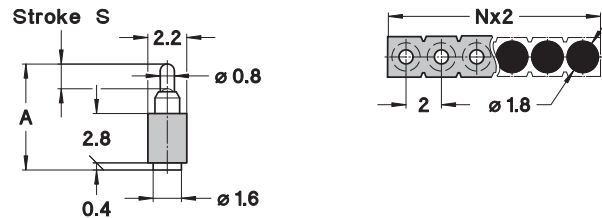

**Bulk:** **T & R Packaging with pick & place cap\* :**

823-S1-**NNN**-30-**XXX**101    823-S1-**NNN**-30-**XXX**191

Surface mount SLC connector, low profile, double row

**AVAILABILITY FROM**    4 to 20 contacts  
(standard number of contacts: 20)

\*Please consult [www.precidip.com](http://www.precidip.com) for availability size of tape, size of reel, number of components per reel and packing units.

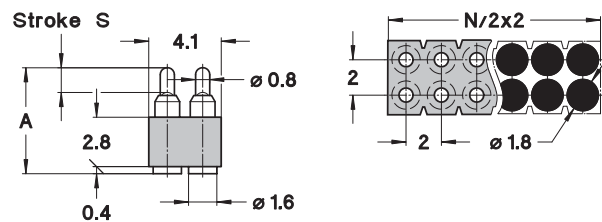

## AVAILABLE CONNECTOR HEIGHTS

INITIAL HEIGHT A (mm)	STROKE S (mm)	XXX CODE
5	1.1	012
5.5	1.1	013
6	1.4	014
6.5	1.4	015





preci-dip

WWW.PRECIDIP.COM TEL +41 32 421 04 00 SALES@PRECIDIP.COM

# SPRING-LOADED CONNECTORS

2.54 mm GRID / SINGLE ROW / DOUBLE ROW / SOLDER TAIL

Low resistance modular connectors with spring-loaded contacts (SLC), solder tail. Contacts with improved, shaped piston design.

## TECHNICAL SPECIFICATIONS (FOR GENERAL SPECS, SEE PAGE 31)

INSULATOR	Black glass filled polyester PCT-GF30-FR	
FLAMMABILITY	UL 94V-0	
PISTON AND BARREL	Brass CuZn36Pb3 (C36000)	
SPRING	Music wire DIN 17223, gold plated	
MAX. STROKE	1.4 mm	
FORCES	0.25 N initial	0.85 N at 1/2 stroke
MECHANICAL LIFE	50'000 cycles	
OPERATING CURRENT	Max. 3.5 A	
CONTACT RESISTANCE	10 mΩ (static measurement, halfway position)	

## ORDERING INFORMATION ROHS COMPLIANT PARTS

PLATING CODE	BARREL	PISTON
S1	0.25 μm gold	0.5 μm gold
SS	0.5 μm gold	0.5 μm gold

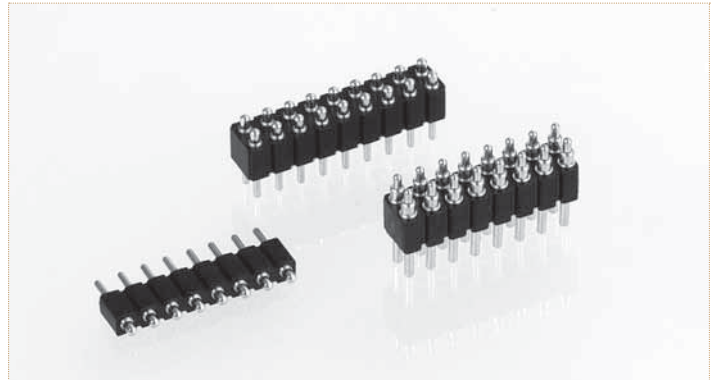

See page 178 for plating specs.

**NNN number of poles:** Replace **NNN** with the requested number of poles, e.g. 813-S1-**NNN**-10-014101 for a double row version with 16 pins becomes 813-S1-**016**-10-014101.

### 811-S1-**NNN**-10-**XXX**101

Straight SLC connector, low profile, solder tail, single row

AVAILABILITY FROM 2 to 64 contacts  
(standard number of contacts: 64)

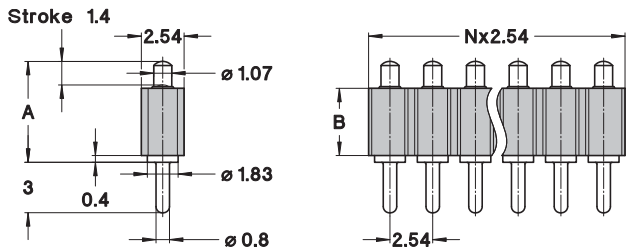

### 813-S1-**NNN**-10-**XXX**101

Straight SLC connector, low profile, solder tail, double row

AVAILABILITY FROM 4 to 72 contacts  
(standard number of contacts: 72)

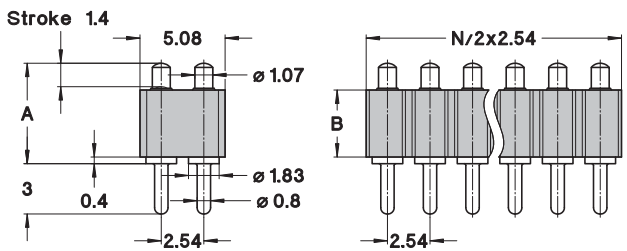

### 813-SS-**NNN**-10-474101

Straight SLC connector, solder tail, double row

AVAILABILITY FROM 4 to 64 contacts  
(standard number of contacts: 64)

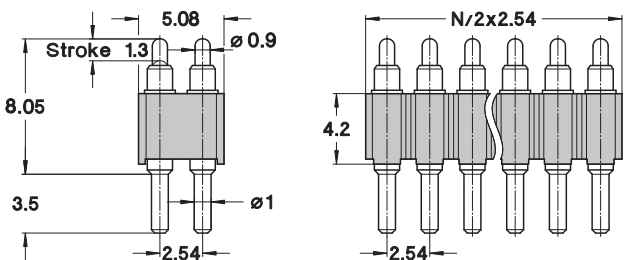

## AVAILABLE CONNECTOR HEIGHTS

INITIAL HEIGHT A (mm)	PLASTIC BODY HEIGHT B (mm)	XXX CODE
6	4	014
6.5	4	015
7	4	016
7.5	4	017



preci-dip

WWW.PRECIDIP.COM TEL +41 32 421 04 00 SALES@PRECIDIP.COM

# SPRING-LOADED CONNECTORS

2.54 mm GRID / SINGLE ROW / DOUBLE ROW / SURFACE MOUNT

Basic modular connectors with spring-loaded contacts (SLC), surface mount. Contacts with hollow piston design for low profile.

## TECHNICAL SPECIFICATIONS (FOR GENERAL SPECS, SEE PAGE 31)

<b>INSULATOR</b>	Black glass filled polyester PCT-GF30-FR	
<b>FLAMMABILITY</b>	UL 94V-0	
<b>PISTON AND BARREL</b>	Brass CuZn36Pb3 (C36000)	
<b>SPRING</b>	Stainless steel X12 CrNi177, DIN 17224 (Music wire DIN 17223, gold plated for 811...008101)	
<b>MAX. STROKE</b>	1.4 mm (1 mm for 811-...-008101 and 1.15 mm for 811/813-...-001101)	
<b>FORCES</b>	0.25 N initial	0.6 N at 1/2 stroke
<b>MECHANICAL LIFE</b>	100'000 cycles	
<b>OPERATING CURRENT</b>	Max. 3.5 A	
<b>CONTACT RESISTANCE</b>	15 mΩ (static measurement, halfway position)	
<b>COPLANARITY SMD TERMINATIONS</b>	Max. 0.1 mm (measured on 25 mm long connectors)	

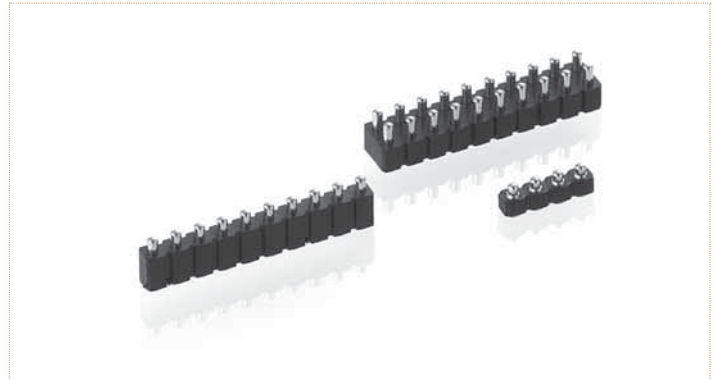

## ORDERING INFORMATION ROHS COMPLIANT PARTS

<b>PLATING CODE</b>	<b>BARREL</b>	<b>PISTON</b>
SS	0.5 μm gold	0.5 μm gold

See page 178 for plating specs.

**NNN number of poles.** Replace **NNN** with the requested number of poles, e.g. 811-SS-**NNN**-30-002101 for a single row version with 16 pins becomes 811-SS-**016**-30-002101.

**Bulk:** **T & R Packaging with pick & place cap\* :**

811-SS-**NNN**-30-008101 811-SS-**NNN**-30-008191

Surface mount SLC connector, very low profile, single row

**AVAILABILITY FROM** 2 to 10 contacts  
(standard number of contacts: 10)

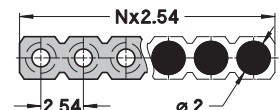
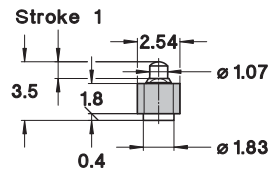

\*Please consult [www.precidip.com](http://www.precidip.com) for availability size of tape, size of reel, number of components per reel and packing units.

**Bulk:** **T & R Packaging with pick & place cap\* :**

811-SS-**NNN**-30-**XXX**101 811-SS-**NNN**-30-**XXX**191

Surface mount SLC connector, low profile, single row

**AVAILABILITY FROM** 2 to 10 contacts  
(standard number of contacts: 10)

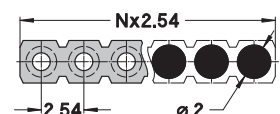
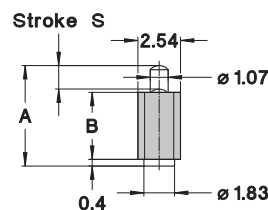

\*Please consult [www.precidip.com](http://www.precidip.com) for availability size of tape, size of reel, number of components per reel and packing units.

**Bulk:** **T & R Packaging with pick & place cap\* :**

813-SS-**NNN**-30-**XXX**101 811-SS-**NNN**-30-**XXX**191

Surface mount SLC connector, low profile, double row

**AVAILABILITY FROM** 4 to 20 contacts  
(standard number of contacts: 20)

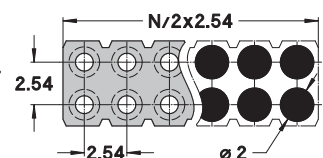
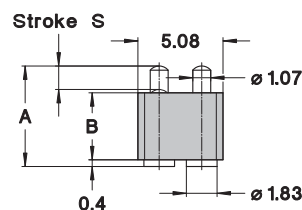

\*Please consult [www.precidip.com](http://www.precidip.com) for availability size of tape, size of reel, number of components per reel and packing units.

## AVAILABLE CONNECTOR HEIGHTS

INITIAL HEIGHT A (mm)	STROKE S (mm)	PLASTIC BODY HEIGHT B (mm)	XXX CODE
4.5	1.15	2.95	001
5	1.4	2.95	002
5.5	1.4	2.95	003
6	1.4	4	004
6.5	1.4	4	005
7	1.4	4	006
7.5	1.4	4	007



preci-dip

WWW.PRECIDIP.COM TEL +41 32 421 04 00 SALES@PRECIDIP.COM

# SPRING-LOADED CONNECTORS

2.54 mm GRID / SINGLE ROW / DOUBLE ROW / SURFACE MOUNT

Low resistance modular connectors with spring-loaded contacts (SLC), surface mount. Contacts with improved shaped piston design.

## TECHNICAL SPECIFICATIONS (FOR GENERAL SPECS, SEE PAGE 31)

<b>INSULATOR</b>	Black glass filled polyester PCT-GF30-FR	
<b>FLAMMABILITY</b>	UL 94V-0	
<b>PISTON AND BARREL</b>	Brass CuZn36Pb3 (C36000)	
<b>SPRING</b>	Music wire DIN 17223, gold plated	
<b>MAX. STROKE</b>	1.4 mm	
<b>FORCES</b>	0.25 N initial	0.85 N at 1/2 stroke
<b>MECHANICAL LIFE</b>	50'000 cycles	
<b>OPERATING CURRENT</b>	Max. 3.5 A	
<b>CONTACT RESISTANCE</b>	10 mΩ (static measurement, halfway position)	
<b>COPLANARITY</b>	Max. 0.1 mm (measured on 25 mm long connectors)	
<b>SMD TERMINATIONS</b>		

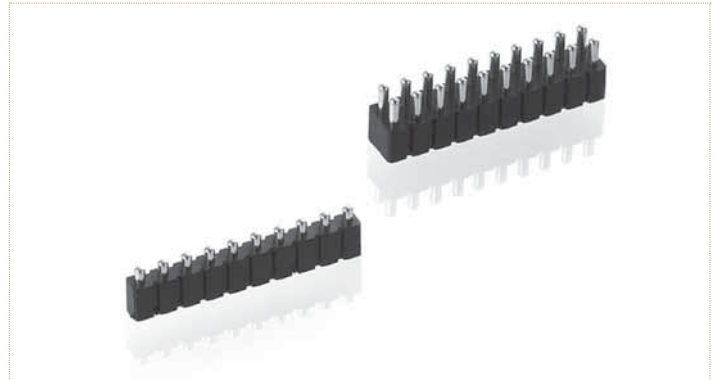

## ORDERING INFORMATION ROHS COMPLIANT PARTS

<b>PLATING CODE</b>	<b>BARREL</b>	<b>PISTON</b>
S1	0.25 μm gold	0.5 μm gold

See page 178 for plating specs.

**NNN number of poles.** Replace **NNN** with the requested number of poles, e.g. 813-S1-**NNN**-30-014101 for a double row version with 16 pins becomes 813-S1-**016**-30-014101.

**Bulk:** **T & R Packaging with pick & place cap\* :**

811-S1-**NNN**-30-**XXX**101 811-S1-**NNN**-30-**XXX**191

Surface mount SLC connector, low profile, single row

**AVAILABILITY FROM** 2 to 10 contacts  
(standard number of contacts: 10)

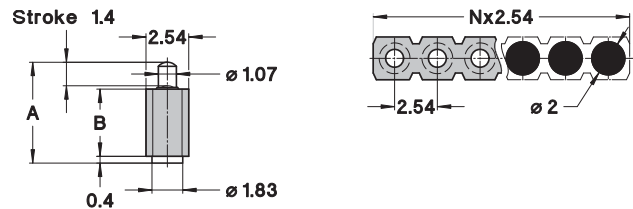

\*Please consult [www.precidip.com](http://www.precidip.com) for availability size of tape, size of reel, number of components per reel and packing units.

**Bulk:** **T & R Packaging with pick & place cap\* :**

813-S1-**NNN**-30-**XXX**101 813-S1-**NNN**-30-**XXX**191

Surface mount SLC connector, low profile, double row

**AVAILABILITY FROM** 4 to 20 contacts  
(standard number of contacts: 20)

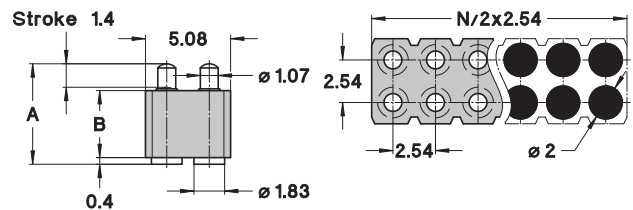

\*Please consult [www.precidip.com](http://www.precidip.com) for availability size of tape, size of reel, number of components per reel and packing units.

## AVAILABLE CONNECTOR HEIGHTS

INITIAL HEIGHT A (mm)	PLASTIC BODY HEIGHT B (mm)	XXX CODE
6	4	014
6.5	4	015
7	4	016
7.5	4	017





preci-dip

WWW.PRECIDIP.COM TEL +41 32 421 04 00 SALES@PRECIDIP.COM

# SPRING-LOADED CONNECTORS

2.54 mm GRID / SINGLE ROW / DOUBLE ROW / SURFACE MOUNT

Basic modular connectors with spring-loaded contacts (SLC), surface mount with positioning pins. Contacts with hollow piston design for low profile.

## TECHNICAL SPECIFICATIONS (FOR GENERAL SPECS, SEE PAGE 31)

<b>INSULATOR</b>	Black glass filled polyester PCT-GF30-FR
<b>FLAMMABILITY</b>	UL 94V-0
<b>PISTON AND BARREL</b>	Brass CuZn36Pb3 (C36000)
<b>SPRING</b>	Stainless steel X12 CrNi177, DIN 17224
<b>MAX. STROKE</b>	1.4 mm (1.15 mm for 811/813-...-021101)
<b>FORCES</b>	0.25 N initial                      0.6 N at 1/2 stroke
<b>MECHANICAL LIFE</b>	100'000 cycles
<b>OPERATING CURRENT</b>	Max. 3.5 A
<b>CONTACT RESISTANCE</b>	15 mΩ (static measurement, halfway position)
<b>COPLANARITY</b>	
<b>SMD TERMINATIONS</b>	Max. 0.1 mm (measured on 25 mm long connectors)

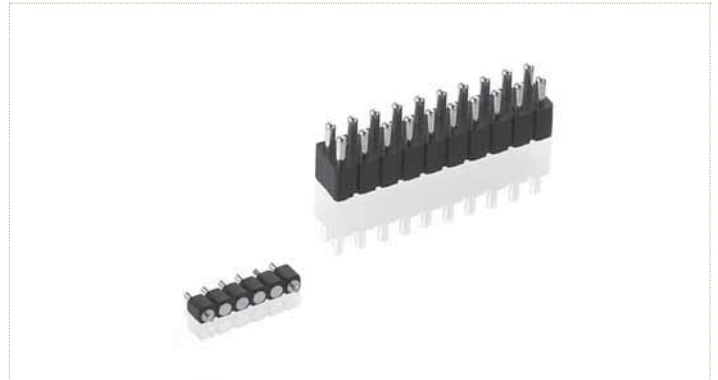

## ORDERING INFORMATION ROHS COMPLIANT PARTS

<b>PLATING CODE</b>	<b>BARREL</b>	<b>PISTON</b>
SS	0.5 μm gold	0.5 μm gold

See page 178 for plating specs.

**NNN number of poles.** Replace **NNN** with the requested number of poles, e.g. 813-SS-**NNN**-30-021101 for a double row version with 16 pins becomes 813-SS-**016**-30-021101.

### 811-SS-**NNN**-30-**XXX**101

Surface mount SLC connector, low profile, single row, with 2 positioning pins

**AVAILABILITY FROM** 2 to 10 contacts  
(standard number of contacts: 10)

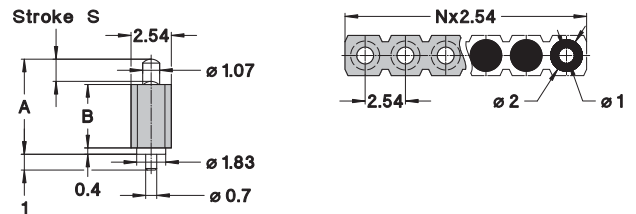

### 813-SS-**NNN**-30-**XXX**101

Surface mount SLC connector, double row, with 4 positioning pins

**AVAILABILITY FROM** 4 to 20 contacts  
(standard number of contacts: 20)

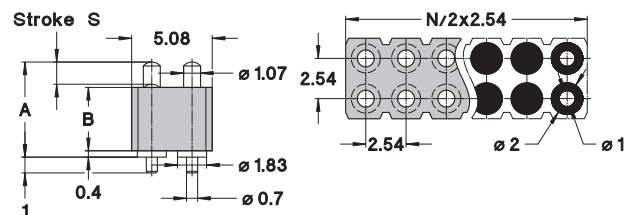

## AVAILABLE CONNECTOR HEIGHTS

INITIAL HEIGHT A (mm)	STROKE S (mm)	PLASTIC BODY HEIGHT B (mm)	XXX CODE
4.5	1.15	2.95	021
5	1.4	2.95	022
5.5	1.4	2.95	023
6	1.4	4	024
6.5	1.4	4	025
7	1.4	4	026
7.5	1.4	4	027



preci-dip

WWW.PRECIDIP.COM TEL +41 32 421 04 00 SALES@PRECIDIP.COM

# SPRING-LOADED CONNECTORS

2.54 mm GRID / SINGLE ROW / DOUBLE ROW / SURFACE MOUNT

Connectors with spring-loaded contacts (SLC), surface mount.

## TECHNICAL SPECIFICATIONS (FOR GENERAL SPECS, SEE PAGE 31)

<b>INSULATOR</b>	Black glass filled polyester PCT-GF30-FR		
<b>FLAMMABILITY</b>	UL 94V-0		
<b>PISTON AND BARREL</b>	Brass CuZn36Pb3 (C36000)		
	<b>8PM...131</b>	<b>8PM...260</b>	<b>8PM...219</b>
<b>SPRING</b>	Music wire DIN 17723, gold plated	Stainless steel X12 CrNi177, DIN 17224	Stainless steel X12 CrNi177, DIN 17224
<b>MAX. STROKE</b>	1.5 mm	1.5 mm	1 mm
<b>FORCES</b>	0.2 N initial 0.9 N at 1/2 stroke	0.25 N initial 0.95 N at 1/2 stroke	0.25 N initial 0.6 N at 1/2 stroke
<b>MECHANICAL LIFE</b>	50'000 cycles	50'000 cycles	100'000 cycles
<b>OPERATING CURRENT</b>	Max. 3 A	Max. 3 A	Max. 3 A
<b>CONTACT RESISTANCE</b>	10 mΩ (static measurement, halfway position)	10 mΩ	15 mΩ
<b>COPLANARITY</b>	Max 0.1 mm (measured on 25 mm long connectors)		

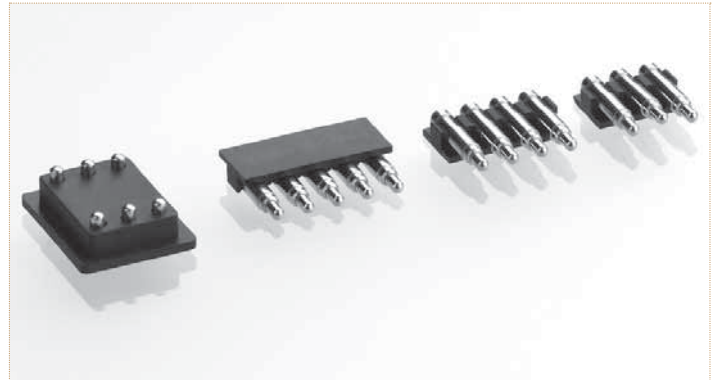

Other plating on request (see page 178 for plating specs).

**NN number of poles.** Replace **NN** with the requested number of poles, e.g. 8PM-11-00**NN**-02-131 with 5 pins becomes 8PM-11-00**005**-02-131.

## ORDERING INFORMATION ROHS COMPLIANT PARTS

PLATING CODE	BARREL	PISTON
11	0.25 µm gold	0.25 µm gold
SS	0.5 µm gold	0.5 µm gold

**Bulk:** 8PM-11-00**NN**-02-260  
**T & R Packaging\*:** 8PM-11-00**NN**-02-260191

Parallel surface mount SLC connector for pick & place automatic assembly

**AVAILABILITY FROM** 2 to 10 contacts  
(standard number of contacts: 10)

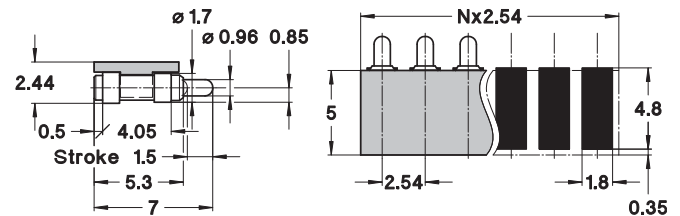

\*Please consult [www.precidip.com](http://www.precidip.com) for availability size of tape, size of reel, number of components per reel and packing units.

**Bulk:** 8PM-11-00**NN**-02-131  
**T & R Packaging\*:** 8PM-11-00**NN**-02-131191

Parallel surface mount SLC connector for pick & place automatic assembly

**AVAILABILITY FROM** 2 to 10 contacts  
(standard number of contacts: 10)

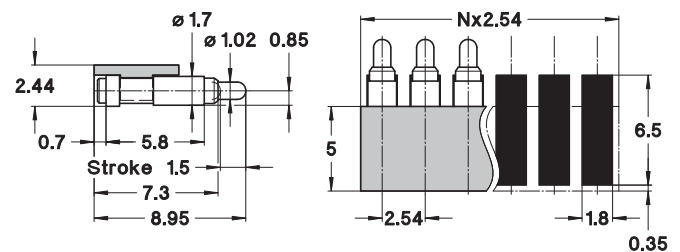

\*Please consult [www.precidip.com](http://www.precidip.com) for availability size of tape, size of reel, number of components per reel and packing units.

**Bulk:** 8PM-SS-0006-02-219  
**T & R Packaging\*:** 8PM-SS-0006-02-219191

SLC connector for chipcards with contacting pads acc. to ISO 7816

Standard number of contacts: 6

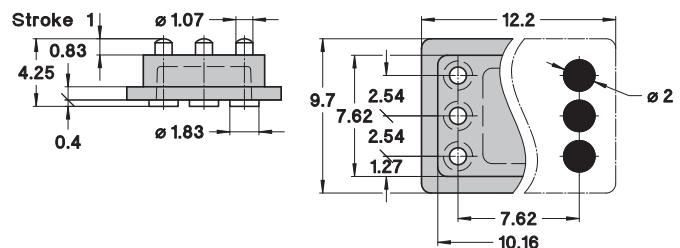

\*Please consult [www.precidip.com](http://www.precidip.com) for availability size of tape, size of reel, number of components per reel and packing units.



preci-dip

WWW.PRECIDIP.COM TEL +41 32 421 04 00 SALES@PRECIDIP.COM

# PAD CONNECTORS

SINGLE ROW / DOUBLE ROW / SURFACE MOUNT

Pad connectors with fixed contacts, counterparts for spring-loaded connectors.

## TECHNICAL SPECIFICATIONS (FOR GENERAL SPECS, SEE PAGE 31)

INSULATOR	Black glass filled polyester PCT-GF30-FR
FLAMMABILITY	UL 94V-0
CONTACT	Brass CuZn36Pb3 (C36000)
CONTACTING AREA Ø	1.5 mm
OPERATING CURRENT	Max. 3.5 A
DIELECTRIC STRENGTH	Min. 1'000 V <sub>RMS</sub>
COPLANARITY	
SMD TERMINATIONS	Max. 0.1 mm (measured on 25 mm long connectors)

## ORDERING INFORMATION ROHS COMPLIANT PARTS

PLATING CODE	TERMINATION	CONTACTING AREA
10, 11	0.25 µm gold	0.25 µm gold

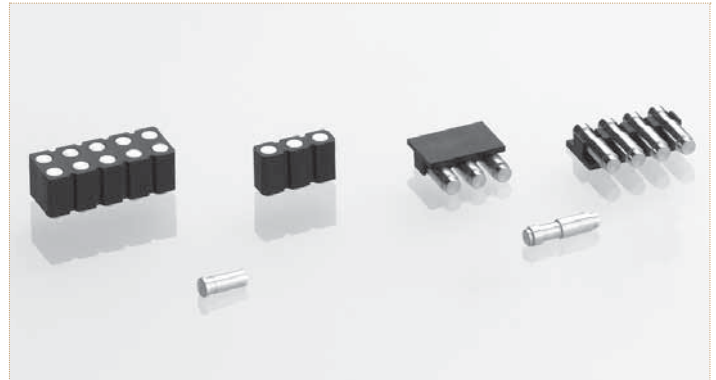

See page 178 for plating specs.

**NNN / NN number of poles.** Replace **NNN** or **NN** with the requested number of poles, e.g. 802-10-**NNN**-30-507101 for a double row version with 20 pins becomes 802-10-**020**-30-507101.

**Bulk:** 800-10-**NNN**-30-507101  
**T & R Packaging\*:** 800-10-**NNN**-30-507191  
 SMD pad connector, single row, perpendicular mount  
**AVAILABILITY FROM** 2 to 10 contacts  
 (standard number of contacts: 10)

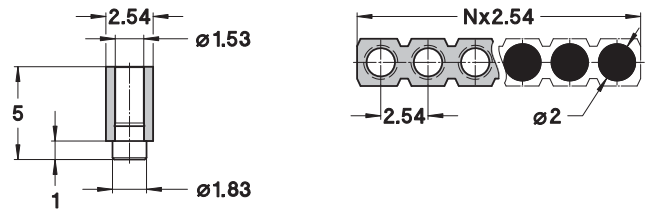

\*Please consult [www.precidip.com](http://www.precidip.com) for availability size of tape, size of reel, number of components per reel and packing units.

**Bulk:** 802-10-**NNN**-30-507101  
**T & R Packaging\*:** 802-10-**NNN**-30-507191  
 SMD pad connector, double row, perpendicular mount  
**AVAILABILITY FROM** 4 to 20 contacts  
 (standard number of contacts: 20)

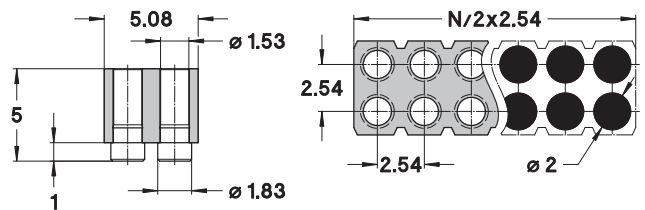

\*Please consult [www.precidip.com](http://www.precidip.com) for availability size of tape, size of reel, number of components per reel and packing units.

**Bulk:** 8MM-11-00**NN**-02-131  
**T & R Packaging\*:** 8MM-11-00**NN**-02-131191  
 SMD pad connector, single row, parallel mount  
**AVAILABILITY FROM** 2 to 10 contacts  
 (standard number of contacts: 10)

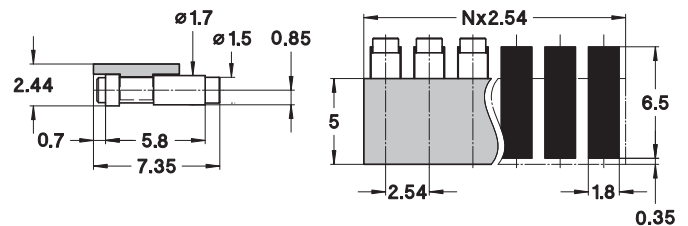

\*Please consult [www.precidip.com](http://www.precidip.com) for availability size of tape, size of reel, number of components per reel and packing units.



# PCB CONNECTORS

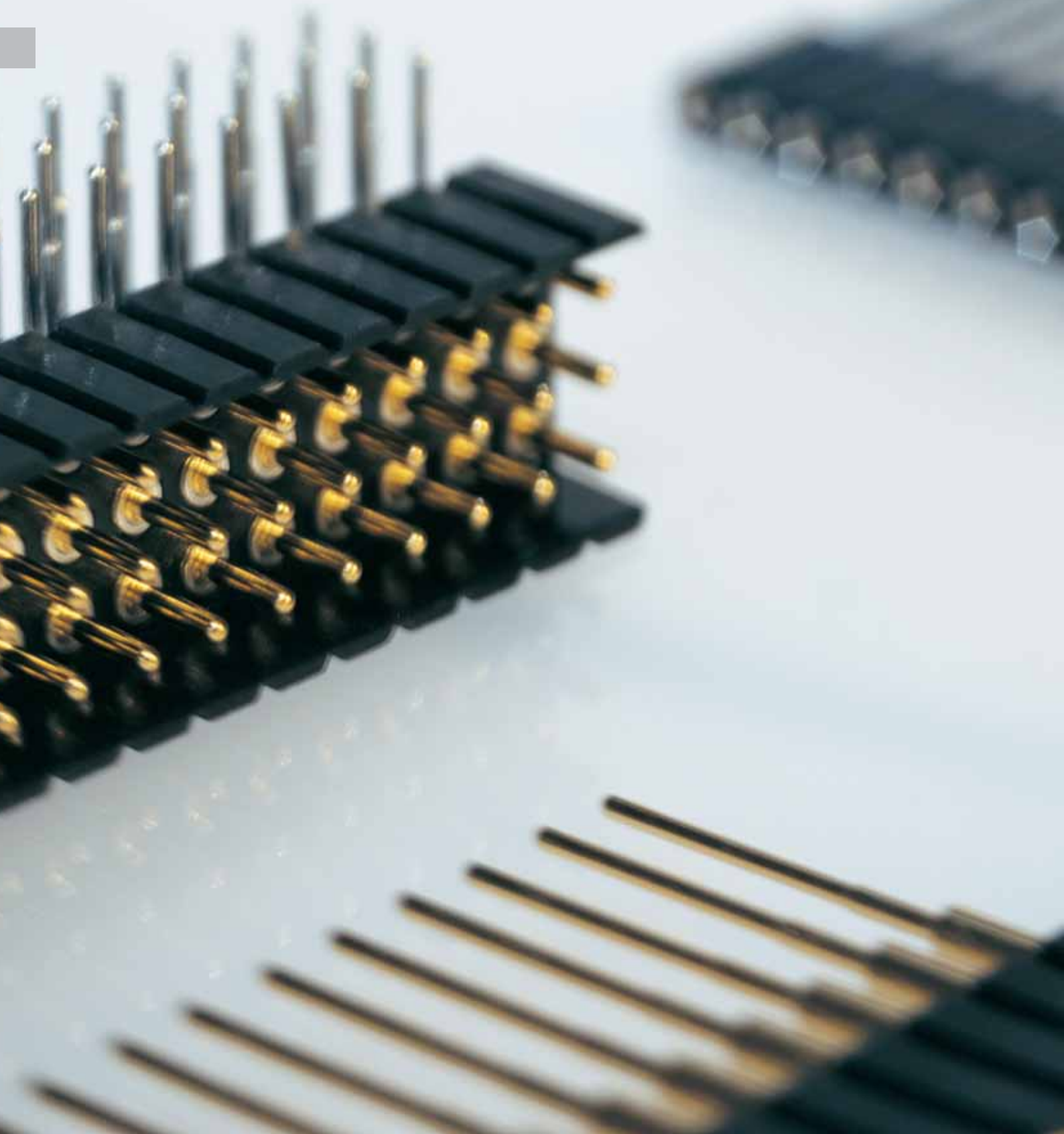

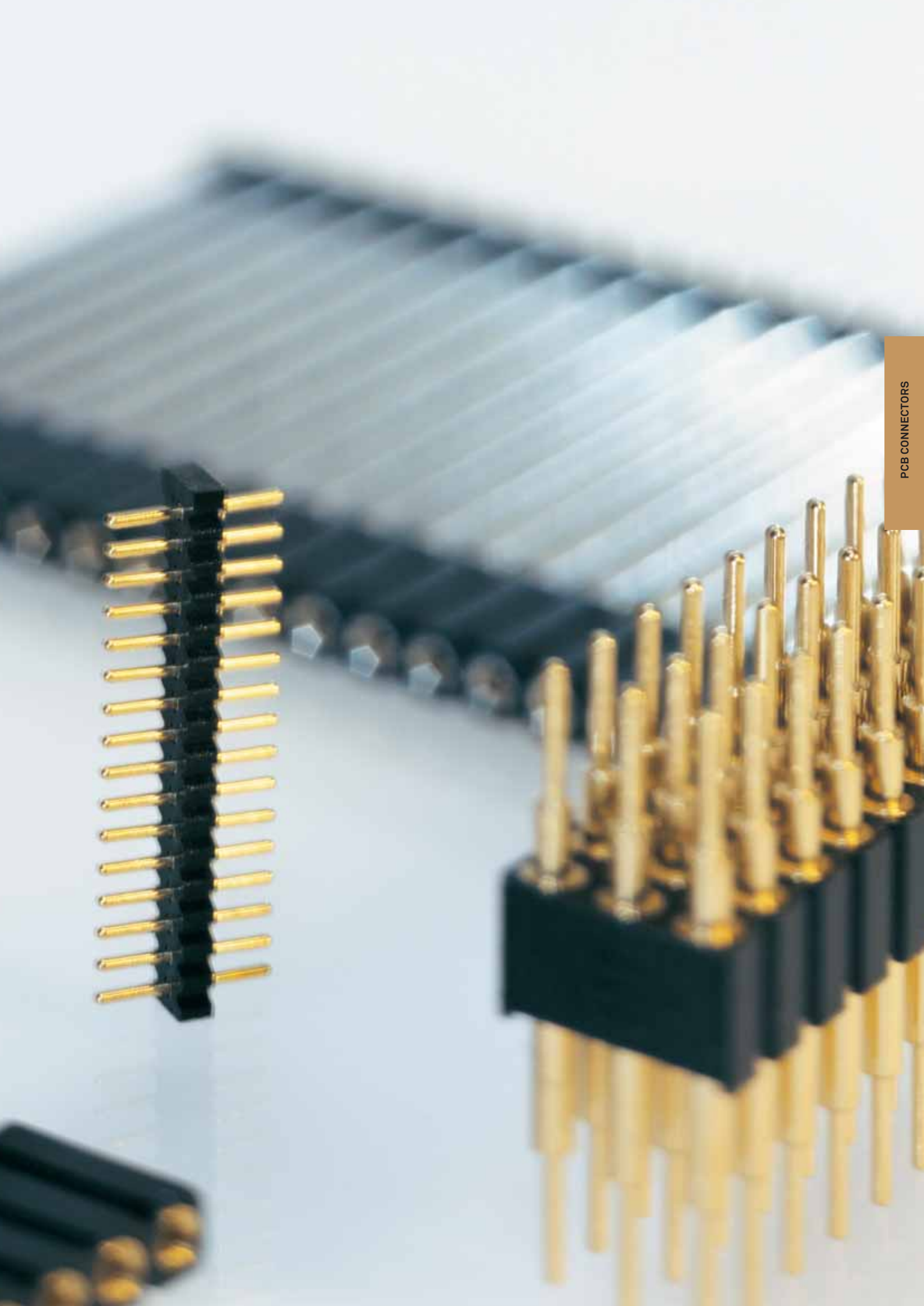











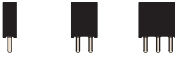







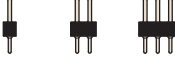
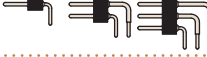

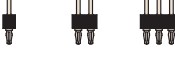

preci-dip

WWW.PRECIDIP.COM TEL +41 32 421 04 00 SALES@PRECIDIP.COM

# QUICK SELECTOR CHART

PCB CONNECTORS

GRID	1 mm			1.27 mm			2 mm (* 1.778 / 1.8 mm)			2.54 mm MATING PIN dia. 0.47 mm			2.54 mm MATING PIN dia. 0.76 mm (* 0.1 mm)		
	SINGLE ROW	SINGLE ROW	DOUBLE ROW	TRIPLE ROW	SINGLE ROW	DOUBLE ROW	QUAD ROW	SINGLE ROW	DOUBLE ROW	TRIPLE ROW	SINGLE ROW	DOUBLE ROW	TRIPLE ROW		
<b>SOCKET CONNECTORS</b>	<b>SEE PAGE</b>														
Straight solder tail 	44	46 47	46	46	55*, 57 58, 59	57 58, 59		69, 70 71, 72 74, 75	69, 70 71, 72 73, 74 75	72 75	85, 86 87, 88 89, 90 91, 100*	85, 86 87, 89 90, 91 100*	86, 87 89, 90		
Right angle solder tail 		48	48	48	60	60		76	76		92, 93	92			
Surface mount perpendicular floating pin 							62	77	77		94	94			
Surface mount perpendicular gull-wing 		49	49, 50		61	61		77	77		94, 95	94, 95			
Surface mount parallel 	44	50			62			78			96				
Solderless compliant press-fit 					63	63		79, 80	79, 80		97, 98	97			
Wire-wrap 								81, 82	81, 82		98	98			
Carrier 								83, 84							
<b>PIN CONNECTORS</b>															
Straight solder tail 	45	51	51	51	56*, 64	65		100 to 103	100 to 103		108 to 110	108 to 110	109 110		
Right angle solder tail 		52	52	52	65	65		104	104		111 112*	111 112	112		
Surface mount perpendicular floating pin 								105	105		113	113			
Surface mount perpendicular gull-wing 		53	53, 54		66	66		105	105		113 114	113 114			
Surface mount parallel 	45	54			67			106			115				
Solderless compliant press-fit 								107	107		116 117	116 117	117		
<b>SQUARE PIN CONNECTORS</b>															
Straight solder tail 					$\varnothing 0.5$ mm			68	68		$\varnothing 0.635$ mm				
Right angle solder tail 					68	68					118	118	118		
Right angle solder tail 					68	68					119	119	119		
<b>HEADERS / JUMPERS</b>															
• Slotted head 											120	120			
• Turret head 											121	121			
• Solder cup 															
• Male jumpers 								123					122		
• Female jumpers 													123		





preci-dip

WWW.PRECIDIP.COM TEL +41 32 421 04 00 SALES@PRECIDIP.COM

# PCB CONNECTORS

## GENERAL SPECIFICATIONS

The values listed below are general specs applying for PRECI-DIP socket and pin connectors. Please see individual catalog page for additional and product specific technical data.

<b>OPERATING TEMPERATURE RANGE</b>	-55 ... +125 °C
<b>CLIMATIC CATEGORY (IEC)</b>	55/125/21
<b>OPERATING HUMIDITY RANGE</b>	Annual mean 75%
<b>MAX. WORKING VOLTAGE</b>	100 V <sub>RMS</sub> /150 V <sub>DC</sub> (2.54 mm grid)



PRECI-DIP connectors designated « Series Preci-Dip Connector » are recognized by UL LLC and listed under « Connectors for Use in Data, Signal, Control and Power Applications », File Nr. E174442.

### MECHANICAL CHARACTERISTICS

<b>CLIP RETENTION</b>	Min. 40 N (no displacement under axial force applied)
<b>CONTACT (SLEEVE / CLIP) RETENTION</b>	Min. 3.3 N acc. to MIL-DTL-83734, pt 4.6.4.2

### ELECTRICAL CHARACTERISTICS

<b>INSULATION RESISTANCE BETWEEN ANY TWO ADJACENT CONTACTS</b>	Min. 10'000 MΩ at 500 V <sub>AC</sub>				
<b>CAPACITANCE BETWEEN ANY TWO ADJACENT CONTACTS</b>	Max. 1 pF				
<b>AIR AND CREEPAGE DISTANCES BETWEEN ANY TWO ADJACENT CONTACTS</b>					
SERIE	3xx/4xx/7xx	80x	83x	85x	86x
mm	0.7	0.85 / 0.7	0.5	0.4 / 0.5	0.5

### ENVIRONMENTAL CHARACTERISTICS

The sockets withstand the following environmental tests without mechanical and electrical defects:

- Dry heat steady state IEC 60512-11-9.11i / 60068-2-2.Bb: 125 °C, 16 h
  - Damp heat cyclic IEC 60512-11-12.11m / 60068-2-30.Db: 25/55 °C, 90 – 100 %rH, 1 cycle of 24 h
  - Cold steady state IEC 60512-11-10.11j / 60068-2-1.A: -55 °C, 2 h
  - Thermal shock IEC 60512-11-4.11d / 60068-2-14.Na: -55/125 °C, 5 cycles 30 min.
  - Sinusoidal vibrations IEC 60512-6-4.6d / 60068-2-6.Fc: 10 to 500 Hz, 10 g, 1 octave/min., 10 cycles for each axis
  - Shock IEC 60512-6-3.6c / 60068-2-27.Ea: 50 g, 11 ms, 3 shocks in three axis
- During the above two tests, no contact interruption >50 ns does appear.

- Solderability J-STD-002A, Test A, 245 °C, 5 s, solder alloy SnAg3.8Cu0.7
- Resistance to soldering heat J-STD-020C, 260 °C, 20 s
- Moisture sensitivity J-STD-020C level 1

### SOLDERLESS COMPLIANT PRESS-FIT CHARACTERISTICS

#### PRESS-FIT CHARACTERISTICS MEASURED ACC. TO IEC 60352-5

- Press-in force: 90 N max. (at min. hole dia.) / 65 N typ.
- Push-out force: 30 N min. (at max. hole dia.) / 50 N typ.
- Push-out 3<sup>rd</sup> cycle: 20 N min. (at max. hole dia.)

#### PCB HOLE DIMENSIONS

- 2 mm grid  
Finished hole Ø: 0.7 + 0.09/-0.06 mm  
Drilled hole Ø: 0.8 ± 0.02 mm
- 2.54 mm grid  
Finished hole Ø: 1 + 0.09/-0.06 mm  
Drilled hole Ø: 1.15 ± 0.02 mm

#### PCB HOLE PLATING

- |                    |  |
|--------------------|--|
| PCB surface finish | Hole plating   |
| • Tin              | 5-15 µm tin over min. 25 µm copper                           |
| • Copper           | min. 25 µm copper  |
| • Gold over nickel | 0.05-0.2 µm gold over 2.5-5 µm nickel over min. 25 µm copper |



preci-dip

WWW.PRECIDIP.COM TEL +41 32 421 04 00 SALES@PRECIDIP.COM

# SOCKET CONNECTORS 1 mm

SINGLE ROW / SOLDER TAIL / SURFACE MOUNT

Ultraminiature PCB socket connectors, solder tail and SMD parallel mount.

## TECHNICAL SPECIFICATIONS (FOR GENERAL SPECS, SEE PAGE 43)

INSULATOR	Black glass filled polyester PCT-GF30-FR
FLAMMABILITY	UL 94V-0
SLEEVE	Brass CuZn36Pb3 (C36000)
CONTACT CLIP (4 FINGER)	Beryllium copper (C17200)
MATING PIN Ø	0.36 to 0.46 mm
FORCES	0.25 N typ. insertion      0.15 N typ. withdrawal (polished steel gauge Ø 0.40 mm)
MECHANICAL LIFE	Min. 500 cycles
RATED CURRENT	1 A
CONTACT RESISTANCE	Max. 10 mΩ
DIELECTRIC STRENGTH	Min. 500 V <sub>RMS</sub>
COPLANARITY SMD TERMINATIONS	Max. 0.1 mm (measured on 25 mm long connectors)

For corresponding pin connectors, see page 45.

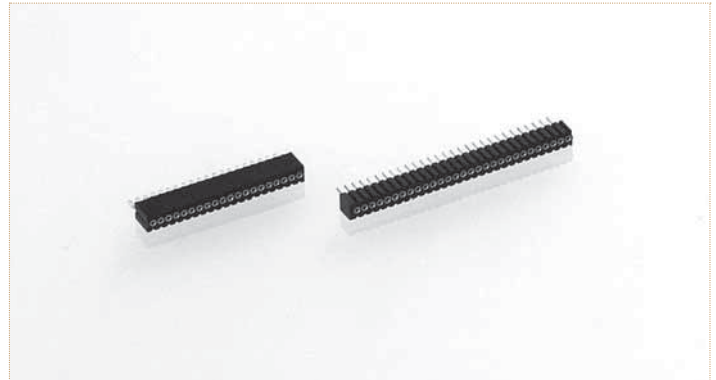

Other plating on request (see page 178 for plating specs).

**NNN number of poles.** Replace **NNN** with the requested number of poles, e.g. 861-87-**NNN**-10-001101 for a single row version with 8 pins becomes 861-87-**008**-10-001101.

## ORDERING INFORMATION ROHS COMPLIANT PARTS

PP PLATING CODE	SLEEVE	CLIP
87	Tin	Flash gold
83	Tin	0.75 µm gold

### 861-PP-NNN-10-001101

Straight socket connector low profile, solder tail, single row

AVAILABILITY FROM 2 to 50 contacts  
(standard number of contacts: 50)

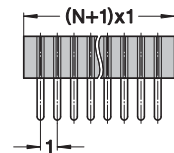
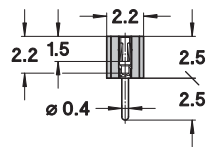

### Bulk: T & R Packaging\*:

861-PP-NNN-40-001101 861-PP-NNN-40-001191

SMD socket connector, single row, parallel mount

AVAILABILITY FROM 2 to 50 contacts  
(standard number of contacts: 50)  
For connectors having more than 24 contacts,  
the coplanarity issue is to be addressed specifically

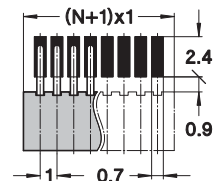
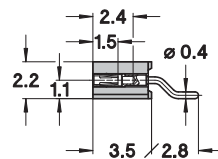

\*Please consult [www.precidip.com](http://www.precidip.com) for availability size of tape, size of reel, number of components per reel and packing units.



preci-dip

WWW.PRECIDIP.COM TEL +41 32 421 04 00 SALES@PRECIDIP.COM

# PIN CONNECTORS 1 mm

SINGLE ROW / SOLDER TAIL / SURFACE MOUNT

Ultraminiature PCB pin connectors, solder tail and SMD parallel mount.

## TECHNICAL SPECIFICATIONS (FOR GENERAL SPECS, SEE PAGE 43)

INSULATOR	Black glass filled polyester PCT-GF30-FR
FLAMMABILITY	UL 94V-0
CONTACT	Brass CuZn36Pb3 (C36000)
CONNECTING PIN Ø	0.40 mm
MECHANICAL LIFE	Min. 500 cycles
RATED CURRENT	1 A
DIELECTRIC STRENGTH	Min. 500 V <sub>RMS</sub>
COPLANARITY	
SMD TERMINATIONS	Max. 0.1 mm (measured on 25 mm long connectors)

For corresponding socket connectors, see page 44.

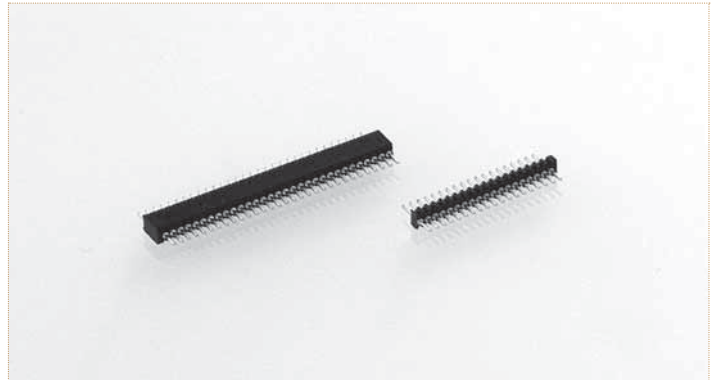

## ORDERING INFORMATION ROHS COMPLIANT PARTS

PP PLATING CODE	TERMINATION	CONNECTING PIN
10	0.25 µm gold	0.25 µm gold

Other plating on request (see page 178 for plating specs).

**NNN number of poles.** Replace **NNN** with the requested number of poles, e.g. 860-10-**NNN**-10-001101 for a single row version with 8 pins becomes 860-10-**008**-10-001101.

### 860-10-**NNN**-10-001101

Straight pin connector low profile, solder tail, single row

AVAILABILITY FROM	2 to 50 contacts
	(standard number of contacts: 50)

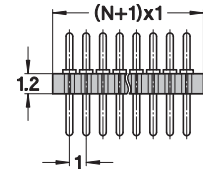
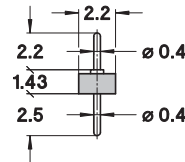

### Bulk: T & R Packaging\* :

860-10-**NNN**-40-001101 860-10-**NNN**-40-001191

SMD pin connector, single row, parallel mount

AVAILABILITY FROM	2 to 50 contacts
	(standard number of contacts: 50)
	For connectors having more than 24 contacts, the coplanarity issue is to be addressed specifically

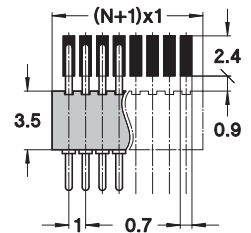
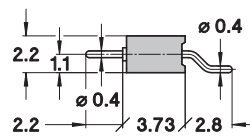

\*Please consult [www.precidip.com](http://www.precidip.com) for availability size of tape, size of reel, number of components per reel and packing units.





preci-dip

WWW.PRECIDIP.COM TEL +41 32 421 04 00 SALES@PRECIDIP.COM

# SOCKET CONNECTORS 1.27 mm

SINGLE ROW / DOUBLE ROW / TRIPLE ROW / SOLDER TAIL

Ultraminiature PCB socket connectors, solder tail

## TECHNICAL SPECIFICATIONS (FOR GENERAL SPECS, SEE PAGE 43)

INSULATOR	Black glass filled polyester PCT-GF30-FR
FLAMMABILITY	UL 94V-0
SLEEVE	Brass CuZn36Pb3 (C36000)
CONTACT CLIP (3 FINGER)	Beryllium copper (C17200)
MATING PIN Ø	0.38 to 0.50 mm
FORCES	0.5 N typ. insertion      0.2 N typ. withdrawal (polished steel gauge Ø 0.41 mm)
MECHANICAL LIFE	Min. 500 cycles
RATED CURRENT	1 A
CONTACT RESISTANCE	Max. 20 mΩ
DIELECTRIC STRENGTH	Min. 500 V <sub>RMS</sub>

For corresponding pin connectors, see pages 51-54.

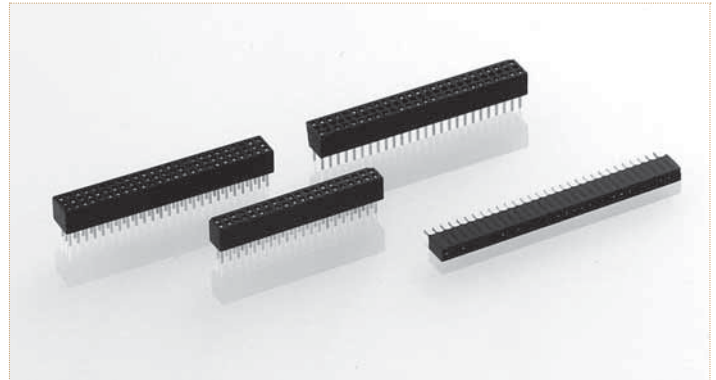

## ORDERING INFORMATION ROHS COMPLIANT PARTS

PP PLATING CODE	SLEEVE	CLIP
87	Tin	Flash gold
83	Tin	0.75 µm gold

Other plating on request (see page 178 for plating specs).

**NNN number of poles.** Replace **NNN** with the requested number of poles, e.g. 851-87-**NNN**-10-001101 for a single row version with 8 pins becomes 851-87-**008**-10-001101

### 851-PP-NNN-10-001101

Straight socket connector, solder tail, single row

AVAILABILITY FROM 2 to 50 contacts  
(standard number of contacts: 25 and 50)

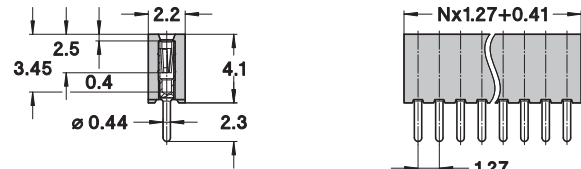

### 853-PP-NNN-10-001101

Straight socket connector, solder tail, double row

AVAILABILITY FROM 4 to 100 contacts  
(standard number of contacts: 50 and 100)

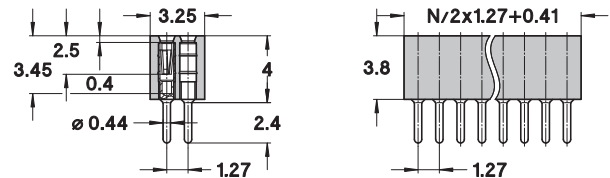

### 853-PP-NNN-10-002101

Straight socket connector, solder tail, double row with 2.54 mm row to row distance

AVAILABILITY FROM 4 to 100 contacts  
(standard number of contacts: 100)

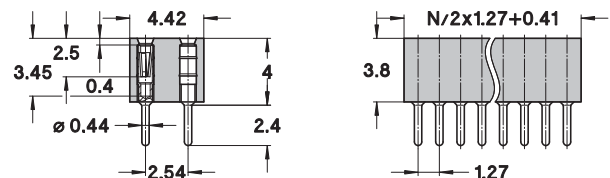

### 855-PP-NNN-10-001101

Straight socket connector, solder tail, triple row

AVAILABILITY FROM 9 to 150 contacts  
(standard number of contacts: 150)

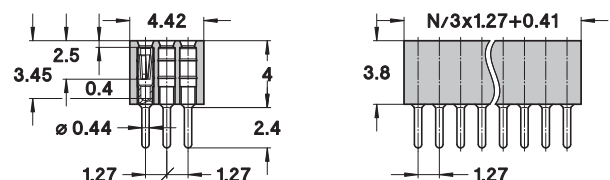



preci-dip

WWW.PRECIDIP.COM TEL +41 32 421 04 00 SALES@PRECIDIP.COM

# SOCKET CONNECTORS 1.27 mm

SINGLE ROW / SOLDER TAIL

Ultraminiature PCB socket connectors, solder tail

## TECHNICAL SPECIFICATIONS (FOR GENERAL SPECS, SEE PAGE 43)

INSULATOR	Black glass filled polyester PCT-GF30-FR
FLAMMABILITY	UL 94V-0
SLEEVE	Brass CuZn36Pb3 (C36000)
CONTACT CLIP (3 FINGER)	Beryllium copper (C17200)
MATING PIN Ø	0.38 to 0.50 mm
FORCES	0.5 N typ. insertion      0.2 N typ. withdrawal (polished steel gauge Ø 0.41 mm)
MECHANICAL LIFE	Min. 500 cycles
RATED CURRENT	1 A
CONTACT RESISTANCE	Max. 20 mΩ
DIELECTRIC STRENGTH	Min. 500 V <sub>RMS</sub>

For corresponding pin connectors, see pages 51-54.

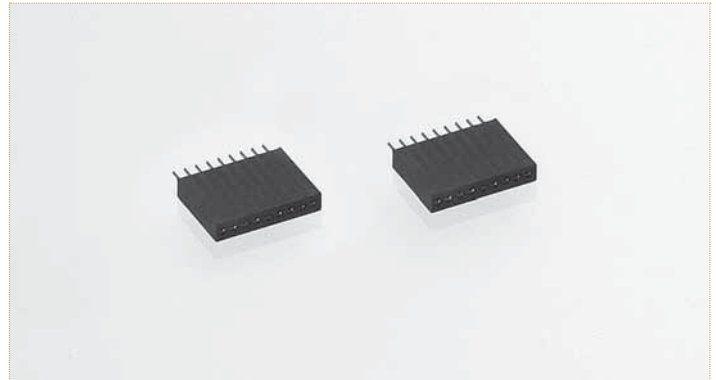

Other plating on request (see page 178 for plating specs).

## ORDERING INFORMATION ROHS COMPLIANT PARTS

PP PLATING CODE	SLEEVE	CLIP
87	Tin	Flash gold
83	Tin	0.75 µm gold

### 851-PP-009-10-477101

Straight socket connector height 8.8 mm, solder tail, single row

Standard number of contacts: 9

Please consult for other pin number

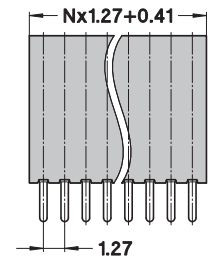
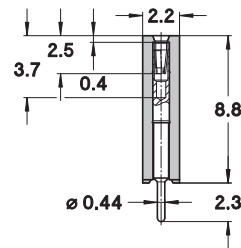



preci-dip

WWW.PRECIDIP.COM TEL +41 32 421 04 00 SALES@PRECIDIP.COM

# SOCKET CONNECTORS 1.27 mm

SINGLE ROW / DOUBLE ROW / TRIPLE ROW / SOLDER TAIL, RIGHT ANGLE

Ultraminiature PCB socket connectors, solder tail right angle.

## TECHNICAL SPECIFICATIONS (FOR GENERAL SPECS, SEE PAGE 43)

<b>INSULATOR</b>	Black glass filled polyester PCT-GF30-FR	
<b>FLAMMABILITY</b>	UL 94V-0	
<b>SLEEVE</b>	Brass CuZn36Pb3 (C36000)	
<b>CONTACT CLIP (3 FINGER)</b>	Beryllium copper (C17200)	
<b>MATING PIN Ø</b>	0.38 to 0.50 mm	
<b>FORCES</b>	0.5 N typ. insertion	0.2 N typ. withdrawal (polished steel gauge Ø 0.41 mm)
<b>MECHANICAL LIFE</b>	Min. 500 cycles	
<b>RATED CURRENT</b>	1 A	
<b>CONTACT RESISTANCE</b>	Max. 20 mΩ	
<b>DIELECTRIC STRENGTH</b>	Min. 500 V <sub>RMS</sub>	

For corresponding pin connectors, see pages 51-54.

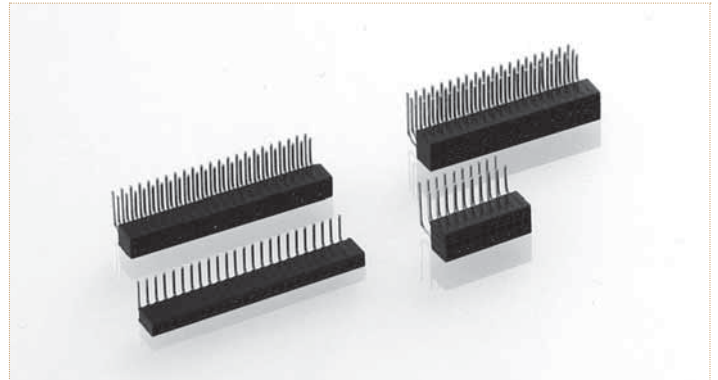

## ORDERING INFORMATION ROHS COMPLIANT PARTS

PP PLATING CODE	SLEEVE	CLIP
87	Tin	Flash gold
83	Tin	0.75 µm gold

Other plating on request (see page 178 for plating specs).

**NNN number of poles.** Replace **NNN** with the requested number of poles, e.g. 851-87-**NNN**-20-001101 for a single row version with 8 pins becomes 851-87-**008**-20-001101.

### 851-PP-NNN-20-001101

Right angle socket connector, solder tail, single row

**AVAILABILITY FROM** 2 to 50 contacts  
(standard number of contacts: 25 and 50)

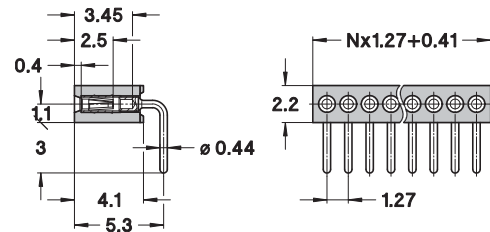

### 853-PP-NNN-20-001101

Right angle socket connector, solder tail, double row

**AVAILABILITY FROM** 4 to 100 contacts  
(standard number of contacts: 50 and 100)

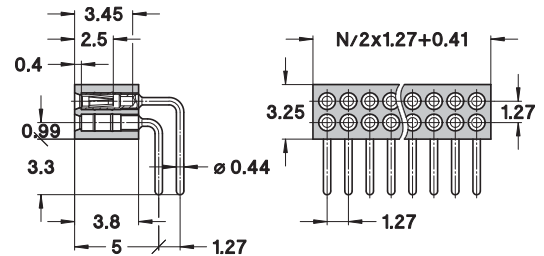

### 853-PP-NNN-20-002101

Right angle socket connector, solder tail, double row with 2.54 mm row to row distance

**AVAILABILITY FROM** 4 to 100 contacts  
(standard number of contacts: 100)

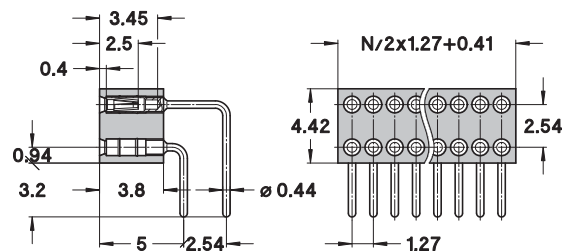

### 855-PP-NNN-20-001101

Right angle receptacle, solder tail, triple row

**AVAILABILITY FROM** 9 to 150 contacts  
(standard number of contacts: 150)

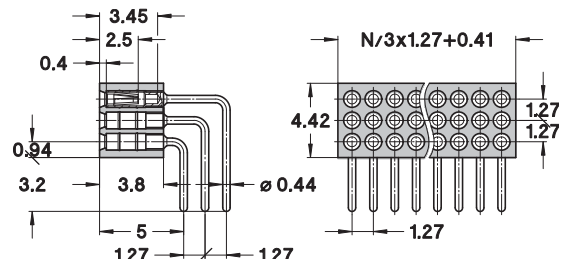





preci-dip

WWW.PRECIDIP.COM TEL +41 32 421 04 00 SALES@PRECIDIP.COM

# SOCKET CONNECTORS 1.27 mm

SINGLE ROW / DOUBLE ROW / TRIPLE ROW / SURFACE MOUNT

Ultraminiature PCB socket connectors, SMD mount.

## TECHNICAL SPECIFICATIONS (FOR GENERAL SPECS, SEE PAGE 43)

<b>INSULATOR</b>	Black glass filled polyester PCT-GF30-FR
<b>FLAMMABILITY</b>	UL 94V-0
<b>SLEEVE</b>	Brass CuZn36Pb3 (C36000)
<b>CONTACT CLIP (3 FINGER)</b>	Beryllium copper (C17200)
<b>MATING PIN Ø</b>	0.35 to 0.50 mm
<b>FORCES</b>	0.5 N typ. insertion      0.2 N typ. withdrawal (polished steel gauge Ø 0.41 mm)
<b>MECHANICAL LIFE</b>	Min. 500 cycles
<b>RATED CURRENT</b>	1 A
<b>CONTACT RESISTANCE</b>	Max. 20 mΩ
<b>DIELECTRIC STRENGTH</b>	Min. 500 V <sub>RMS</sub>
<b>COPLANARITY SMD TERMINATIONS</b>	Max. 0.1 mm (measured on 25 mm long connectors)

For corresponding pin connectors, see pages 51-54.

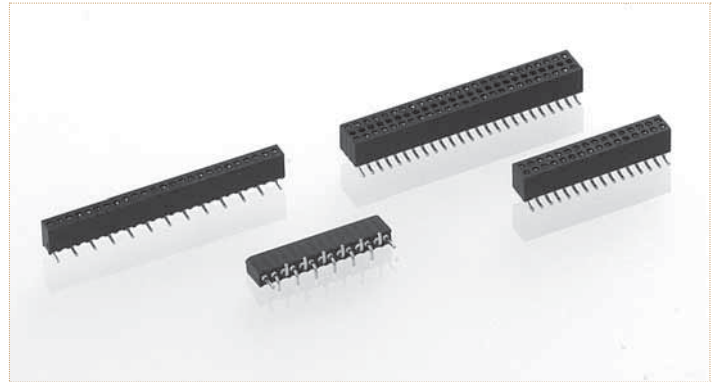

Other plating on request (see page 178 for plating specs).

**NNN number of poles.** Replace **NNN** with the requested number of poles, e.g. 851-83-**NNN**-30-001101 for a single row version with 8 pins becomes 851-83-**008**-30-001101.

## ORDERING INFORMATION ROHS COMPLIANT PARTS

PP PLATING CODE	SLEEVE	CLIP
87	Tin	Flash gold
83	Tin	0.75 µm gold

### Bulk: T & R Packaging with pick & place cap\* :

851-PP-NNN-30-001101    851-PP-NNN-30-001191

SMD socket connector, single row, perpendicular mount

**AVAILABILITY FROM** 3 to 50 contacts  
(standard number of contacts: 25 and 50)  
For connectors having more than 19 contacts, the coplanarity issue is to be addressed specifically

\*Please consult [www.precidip.com](http://www.precidip.com) for availability size of tape, size of reel, number of components per reel and packing units.

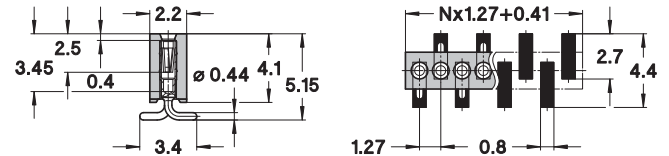

### Bulk: T & R Packaging with pick & place cap\* :

853-PP-NNN-30-001101    853-PP-NNN-30-001191

SMD socket connector, double row, perpendicular mount

**AVAILABILITY FROM** 4 to 100 contacts  
(standard number of contacts: 50 and 100)  
For connectors having more than 19 contacts per row, the coplanarity issue is to be addressed specifically

\*Please consult [www.precidip.com](http://www.precidip.com) for availability size of tape, size of reel, number of components per reel and packing units.

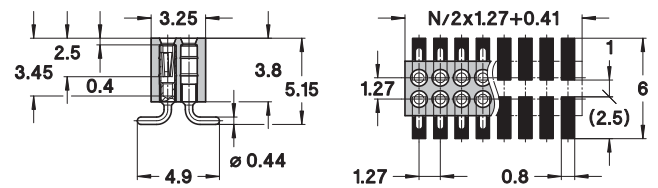

### Bulk: T & R Packaging with pick & place cap\* :

853-PP-NNN-30-002101    853-PP-NNN-30-002191

SMD socket connector, double row with 2.54 mm row to row distance, perpendicular mount

**AVAILABILITY FROM** 4 to 100 contacts  
(standard number of contacts: 100)  
For connectors having more than 19 contacts per row, the coplanarity issue is to be addressed specifically

\*Please consult [www.precidip.com](http://www.precidip.com) for availability size of tape, size of reel, number of components per reel and packing units.

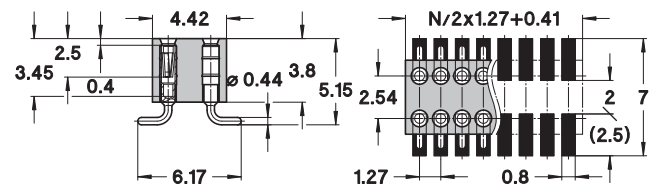

### 851-PP-NNN-30-136101

SMD socket connector, single row, perpendicular mount with 2 positioning pins

**AVAILABILITY FROM** 5 to 50 contacts  
(standard number of contacts: 25 and 50)  
For connectors having more than 19 contacts, the coplanarity issue is to be addressed specifically

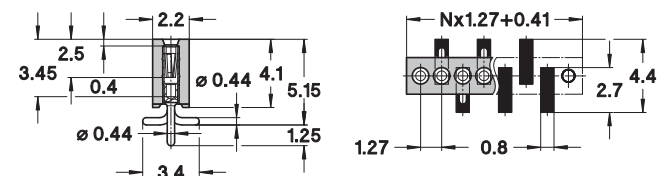



preci-dip

WWW.PRECIDIP.COM TEL +41 32 421 04 00 SALES@PRECIDIP.COM

# SOCKET CONNECTORS 1.27 mm

SINGLE ROW / DOUBLE ROW / SURFACE MOUNT

Ultraminiature PCB socket connectors, SMD mount.

## TECHNICAL SPECIFICATIONS (FOR GENERAL SPECS, SEE PAGE 43)

<b>INSULATOR</b>	Black glass filled polyester PCT-GF30-FR
<b>FLAMMABILITY</b>	UL 94V-0
<b>SLEEVE</b>	Brass CuZn36Pb3 (C36000)
<b>CONTACT CLIP (4 FINGER)</b>	Beryllium copper (C17200)
<b>MATING PIN Ø</b>	0.38 to 0.50 mm
<b>FORCES</b>	0.5 N typ. insertion      0.2 N typ. withdrawal (polished steel gauge Ø 0.41 mm)
<b>MECHANICAL LIFE</b>	Min. 500 cycles
<b>RATED CURRENT</b>	1 A
<b>CONTACT RESISTANCE</b>	Max. 20 mΩ
<b>DIELECTRIC STRENGTH</b>	Min. 500 V <sub>RMS</sub>
<b>COPLANARITY</b>	
<b>SMD TERMINATIONS</b>	Max. 0.1 mm (measured on 25 mm long connectors)

For corresponding pin connectors, see pages 51-54.



Other plating on request (see page 178 for plating specs).

**NNN number of poles.** Replace **NNN** with the requested number of poles, e.g. 851-83-**NNN**-40-001101 for a single row version with 8 pins becomes 851-83-**008**-40-001101.

## ORDERING INFORMATION ROHS COMPLIANT PARTS

PP PLATING CODE	SLEEVE	CLIP
87	Tin	Flash gold
83	Tin	0.75 µm gold

### 853-PP-NNN-30-051101

SMD socket connector, double row with 2.54 mm row to row distance, perpendicular mount with 2 positioning pins

**AVAILABILITY FROM** 4 to 100 contacts  
(standard number of contacts: 100)  
For connectors having more than 19 contacts per row, the coplanarity issue is to be addressed specifically

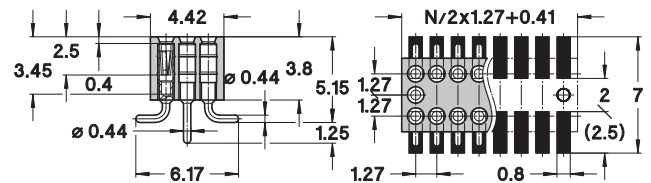

### 851-PP-NNN-40-001101

SMD socket connector, single row, parallel mount with long solder termination

**AVAILABILITY FROM** 2 to 50 contacts  
(standard number of contacts: 25 and 50)  
For connectors having more than 19 contacts, the coplanarity issue is to be addressed specifically

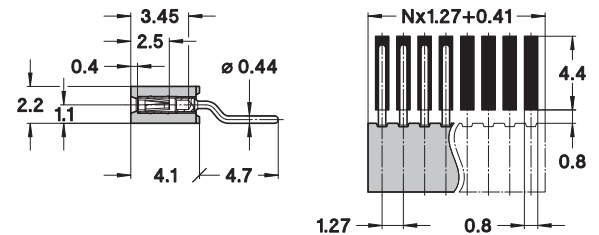

**Bulk:** 851-PP-NNN-40-252101      **T & R Packaging\*:** 851-PP-NNN-40-252191

SMD socket connector, single row, parallel mount

**AVAILABILITY FROM** 2 to 50 contacts  
(standard number of contacts: 25 and 50)  
For connectors having more than 19 contacts, the coplanarity issue is to be addressed specifically

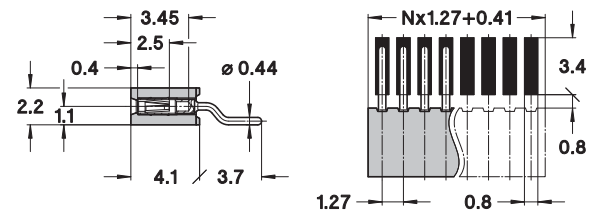

\*Please consult [www.precidip.com](http://www.precidip.com) for availability size of tape, size of reel, number of components per reel and packing units.



preci-dip

WWW.PRECIDIP.COM TEL +41 32 421 04 00 SALES@PRECIDIP.COM

# PIN CONNECTORS 1.27 mm

SINGLE ROW / DOUBLE ROW / TRIPLE ROW / SOLDER TAIL

Ultraminiature PCB pin connectors, solder tail.

## TECHNICAL SPECIFICATIONS (FOR GENERAL SPECS, SEE PAGE 43)

INSULATOR	Black glass filled polyester PCT-GF30-FR
FLAMMABILITY	UL 94V-0
CONTACT	Brass CuZn36Pb3 (C36000)
CONNECTING PIN Ø	0.41 mm
MECHANICAL LIFE	Min. 500 cycles
RATED CURRENT	1 A
DIELECTRIC STRENGTH	Min. 1'000 V <sub>RMS</sub>

For corresponding socket connectors, see pages 46-50.

## ORDERING INFORMATION ROHS COMPLIANT PARTS

PP PLATING CODE	TERMINATION	CONNECTING PIN
10	0.25 µm gold	0.25 µm gold
80	Tin	Tin



Other plating on request (see page 178 for plating specs).

**NNN number of poles.** Replace **NNN** with the requested number of poles, e.g. 852-10-**NNN**-10-001101 for a double row version with 16 pins becomes 852-10-**016**-10-001101.

### 850-PP-NNN-10-001101

Straight pin connector, solder tail, single row

AVAILABILITY FROM 2 to 50 contacts  
(standard number of contacts: 25 and 50)

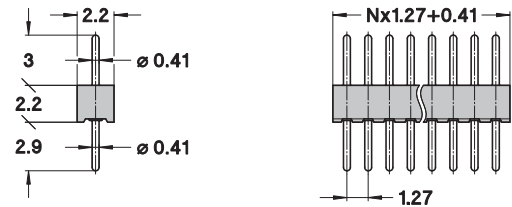

### 852-PP-NNN-10-001101

Straight pin connector, solder tail, double row

AVAILABILITY FROM 4 to 100 contacts  
(standard number of contacts: 50 and 100)

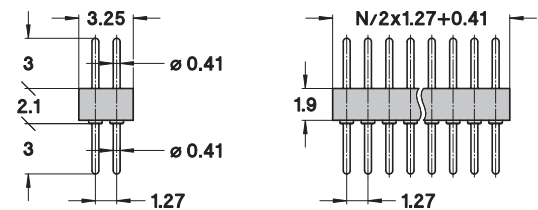

### 852-PP-NNN-10-002101

Straight pin connector, solder tail, double row with 2.54 mm row to row distance

AVAILABILITY FROM 4 to 100 contacts  
(standard number of contacts: 100)

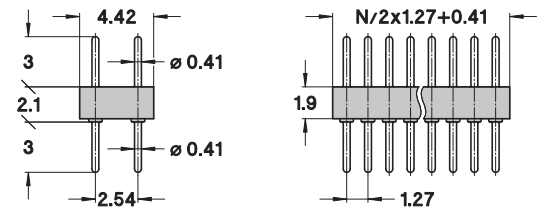

### 854-PP-NNN-10-001101

Straight pin connector, solder tail, triple row

AVAILABILITY FROM 9 to 150 contacts  
(standard number of contacts: 150)

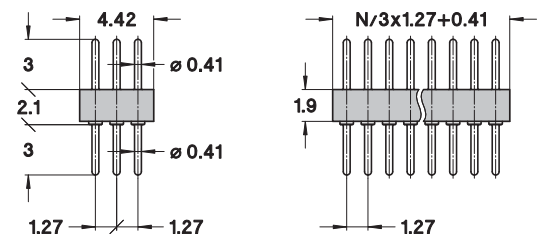



preci-dip

WWW.PRECIDIP.COM TEL +41 32 421 04 00 SALES@PRECIDIP.COM

# PIN CONNECTORS 1.27 mm

SINGLE ROW / DOUBLE ROW / TRIPLE ROW / SOLDER TAIL, RIGHT ANGLE

Ultraminiature PCB pin connectors, solder tail, right angle.

## TECHNICAL SPECIFICATIONS (FOR GENERAL SPECS, SEE PAGE 43)

<b>INSULATOR</b>	Black glass filled polyester PCT-GF30-FR
<b>FLAMMABILITY</b>	UL 94V-0
<b>CONTACT</b>	Brass CuZn36Pb3 (C36000)
<b>CONNECTING PIN Ø</b>	0.41 mm
<b>MECHANICAL LIFE</b>	Min. 500 cycles
<b>RATED CURRENT</b>	1 A
<b>DIELECTRIC STRENGTH</b>	Min. 1'000 V <sub>RMS</sub>

For corresponding socket connectors, see pages 46-50.

## ORDERING INFORMATION ROHS COMPLIANT PARTS

PP PLATING CODE	TERMINATION	CONNECTING PIN
10	0.25 µm gold	0.25 µm gold
80	Tin	Tin



Other plating on request (see page 178 for plating specs).

**NNN number of poles.** Replace **NNN** with the requested number of poles, e.g. 852-10-**NNN**-20-001101 for a double row version with 16 pins becomes 852-10-**016**-20-001101.

### 850-PP-NNN-20-001101

Right angle pin connector, solder tail, single row

**AVAILABILITY FROM** 2 to 50 contacts  
(standard number of contacts: 25 and 50)

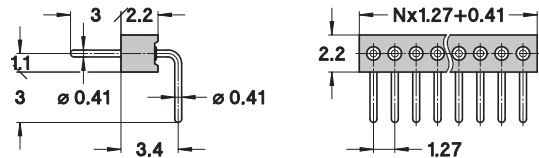

### 852-PP-NNN-20-001101

Right angle pin connector, solder tail, double row

**AVAILABILITY FROM** 4 to 100 contacts  
(standard number of contacts: 50 and 100)

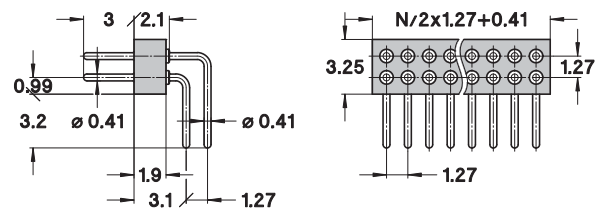

### 852-PP-NNN-20-002101

Right angle pin connector, solder tail, double row with 2.54 mm row to row distance

**AVAILABILITY FROM** 4 to 100 contacts  
(standard number of contacts: 100)

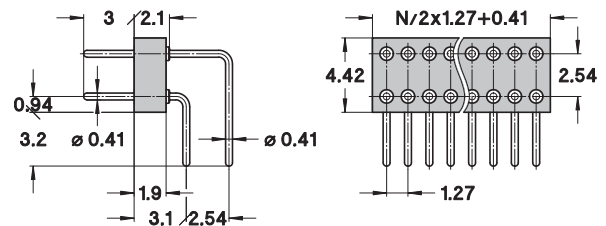

### 854-PP-NNN-20-001101

Right angle pin connector, solder tail, triple row

**AVAILABILITY FROM** 9 to 150 contacts  
(standard number of contacts: 150)

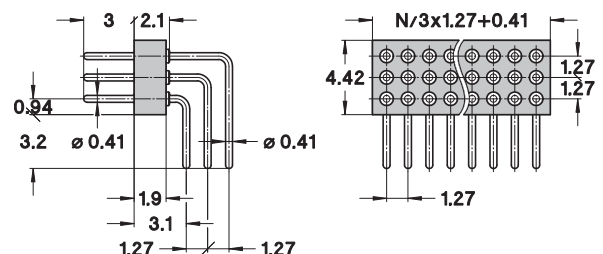





preci-dip

WWW.PRECIDIP.COM TEL +41 32 421 04 00 SALES@PRECIDIP.COM

# PIN CONNECTORS 1.27 mm

SINGLE ROW / DOUBLE ROW / SURFACE MOUNT

Ultraminiature PCB pin connectors, SMD mount.

## TECHNICAL SPECIFICATIONS (FOR GENERAL SPECS, SEE PAGE 43)

<b>INSULATOR</b>	Black glass filled polyester PCT-GF30-FR
<b>FLAMMABILITY</b>	UL 94V-0
<b>CONTACT</b>	Brass CuZn36Pb3 (C36000)
<b>CONNECTING PIN Ø</b>	0.41 mm
<b>MECHANICAL LIFE</b>	Min. 500 cycles
<b>RATED CURRENT</b>	1 A
<b>DIELECTRIC STRENGTH</b>	Min. 1'000 V <sub>RMS</sub>
<b>COPLANARITY SMD TERMINATIONS</b>	Max. 0.1 mm (measured on 25 mm long connectors)

For corresponding socket connectors, see pages 46-50.

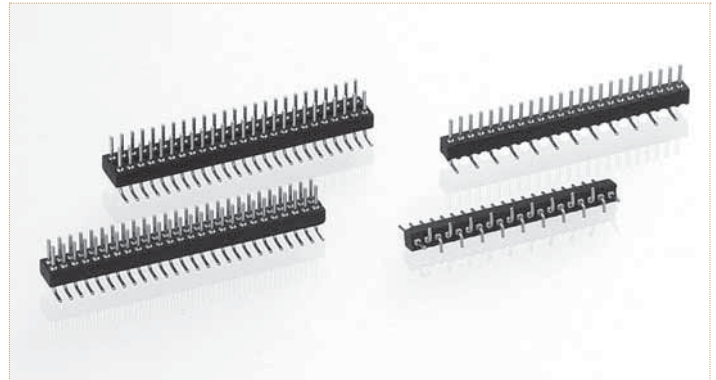

Other plating on request (see page 178 for plating specs).

**NNN number of poles.** Replace **NNN** with the requested number of poles, e.g. 852-10-**NNN**-30-001101 for a double row version with 16 pins becomes 852-10-**016**-30-001101.

## ORDERING INFORMATION ROHS COMPLIANT PARTS

PP PLATING CODE	TERMINATION	CONNECTING PIN
10	0.25 µm gold	0.25 µm gold
80	Tin	Tin

### Bulk: T & R Packaging with pick & place cap\* :

850-PP-**NNN**-30-001101 850-PP-**NNN**-30-001191

SMD pin connector, single row, perpendicular mount

**AVAILABILITY FROM** 3 to 50 contacts  
(standard number of contacts: 25 and 50)  
For connectors having more than 19 contacts, the coplanarity issue is to be addressed specifically

\*Please consult [www.precidip.com](http://www.precidip.com) for availability size of tape, size of reel, number of components per reel and packing units.

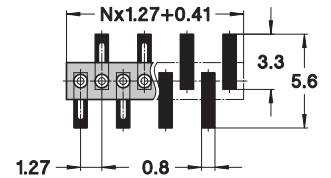
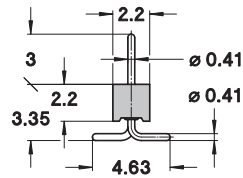

### Bulk: T & R Packaging with pick & place cap\* :

852-PP-**NNN**-30-001101 852-PP-**NNN**-30-001191

SMD pin connector, double row, perpendicular mount

**AVAILABILITY FROM** 4 to 100 contacts  
(standard number of contacts: 50 and 100)  
For connectors having more than 19 contacts per row, the coplanarity issue is to be addressed specifically

\*Please consult [www.precidip.com](http://www.precidip.com) for availability size of tape, size of reel, number of components per reel and packing units.

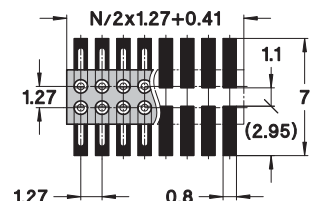
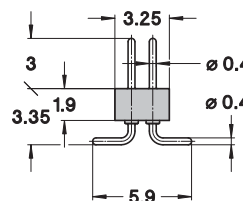

### Bulk: T & R Packaging with pick & place cap\* :

852-PP-**NNN**-30-002101 852-PP-**NNN**-30-002191

SMD pin connector, double row with 2.54 mm row to row distance, perpendicular mount

**AVAILABILITY FROM** 4 to 100 contacts  
(standard number of contacts: 100)  
For connectors having more than 19 contacts per row, the coplanarity issue is to be addressed specifically

\*Please consult [www.precidip.com](http://www.precidip.com) for availability size of tape, size of reel, number of components per reel and packing units.

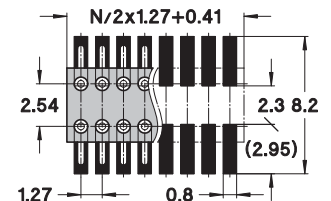
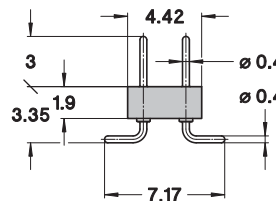

### 850-PP-**NNN**-30-135101

SMD pin connector, single row, perpendicular mount with 2 positioning pins

**AVAILABILITY FROM** 5 to 50 contacts  
(standard number of contacts: 25 and 50)  
For connectors having more than 19 contacts, the coplanarity issue is to be addressed specifically

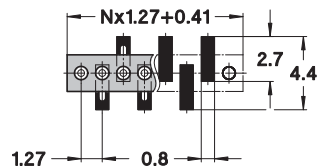
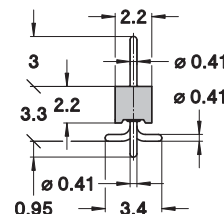



preci-dip

WWW.PRECIDIP.COM TEL +41 32 421 04 00 SALES@PRECIDIP.COM

# PIN CONNECTORS 1.27 mm

SINGLE ROW / DOUBLE ROW / SURFACE MOUNT

Ultraminiature PCB pin connectors, SMD mount.

## TECHNICAL SPECIFICATIONS (FOR GENERAL SPECS, SEE PAGE 43)

<b>INSULATOR</b>	Black glass filled polyester PCT-GF30-FR
<b>FLAMMABILITY</b>	UL 94V-0
<b>CONTACT</b>	Brass CuZn36Pb3 (C36000)
<b>CONNECTING PIN Ø</b>	0.41 mm
<b>MECHANICAL LIFE</b>	Min. 500 cycles
<b>RATED CURRENT</b>	1 A
<b>DIELECTRIC STRENGTH</b>	Min. 1'000 V <sub>RMS</sub>
<b>COPLANARITY</b>	
<b>SMD TERMINATIONS</b>	Max. 0.1 mm (measured on 25 mm long connectors)

For corresponding socket connectors, see pages 46-50.

## ORDERING INFORMATION ROHS COMPLIANT PARTS

PP PLATING CODE	TERMINATION	CONNECTING PIN
10	0.25 µm gold	0.25 µm gold
80	Tin	Tin

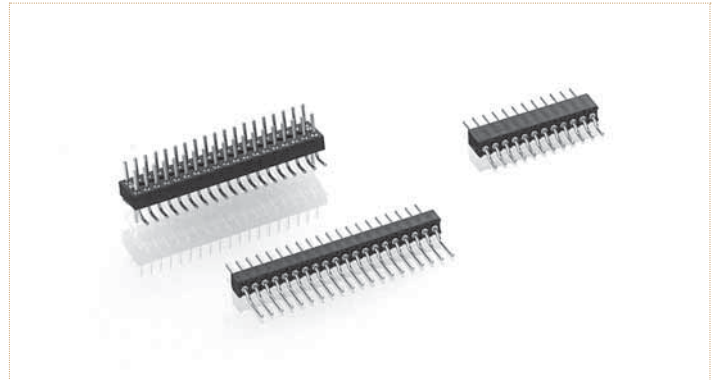

Other plating on request (see page 178 for plating specs).

**NNN number of poles.** Replace **NNN** with the requested number of poles, e.g. 850-10-**NNN**-40-001101 for a single row version with 16 pins becomes 850-10-**016**-40-001101.

### 852-PP-NNN-30-051101

SMD pin connector, double row with 2.54 mm row to row distance, perpendicular mount with 2 positioning pins

**AVAILABILITY FROM** 4 to 100 contacts  
(standard number of contacts: 100)  
For connectors having more than 19 contacts per row, the coplanarity issue is to be addressed specifically

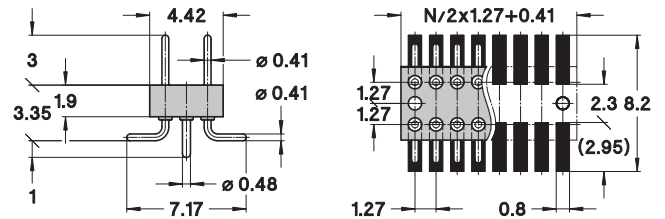

### 850-PP-NNN-40-001101

SMD pin connector, single row, parallel mount with long solder termination

**AVAILABILITY FROM** 2 to 50 contacts  
(standard number of contacts: 25 and 50)  
For connectors having more than 19 contacts, the coplanarity issue is to be addressed specifically

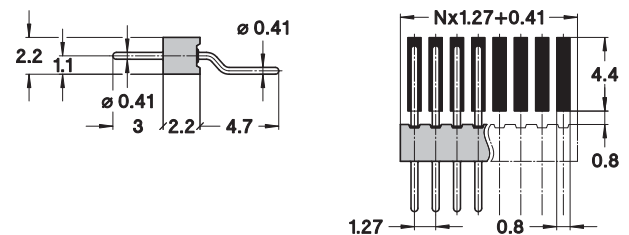

### Bulk: T & R Packaging\*:

#### 850-PP-NNN-40-251101 850-PP-NNN-40-251191

SMD pin connector, single row, parallel mount short solder termination and wider insulator for easier pick and place

**AVAILABILITY FROM** 2 to 50 contacts  
(standard number of contacts: 50)  
For connectors having more than 19 contacts, the coplanarity issue is to be addressed specifically

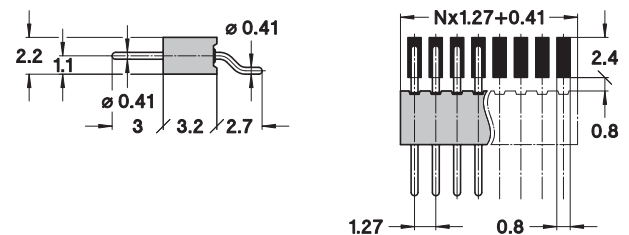

\*Please consult [www.precidip.com](http://www.precidip.com) for availability size of tape, size of reel, number of components per reel and packing units.



preci-dip

WWW.PRECIDIP.COM TEL +41 32 421 04 00 SALES@PRECIDIP.COM

# SOCKET CONNECTORS 1.778 and 1.8 mm

SINGLE ROW / SOLDER TAIL

Socket connectors, with reduced grid spacing 1.778 and 1.8 mm, solder tail.

## TECHNICAL SPECIFICATIONS (FOR GENERAL SPECS, SEE PAGE 43)

INSULATOR	Black glass filled polyester PCT-GF30-FR
FLAMMABILITY	UL 94V-0
SLEEVE	Brass CuZn36Pb3 (C36000)
CONTACT CLIP (4 FINGER)	Beryllium copper (C17200)
MATING PIN Ø	0.40 to 0.56 mm
FORCES	2 N typ. insertion      1 N typ. withdrawal (polished steel gauge Ø 0.43 mm)
MECHANICAL LIFE	Min. 500 cycles
RATED CURRENT	1 A
CONTACT RESISTANCE	Max. 10 mΩ
DIELECTRIC STRENGTH	Min. 1'000 VRMS

For corresponding pin connectors, see page 56.



## ORDERING INFORMATION ROHS COMPLIANT PARTS

PP PLATING CODE	SLEEVE	CLIP
87	Tin	Flash gold
83	Tin	0.75 µm gold

Other plating on request (see page 178 for plating specs).

**NN number of poles.** Replace NN with the requested number of poles, e.g. 317-87-1NN-41-005101 for a single row version with 8 pins becomes 317-87-108-41-005101.

### 317-PP-1NN-41-005101

Straight socket connector, single row, grid spacing 1.778 mm

AVAILABILITY FROM 2 to 38 contacts  
(standard number of contacts: 38)

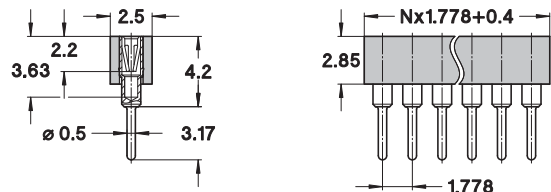

### 317-PP-1NN-41-022101

Straight socket connector elevated, single row, grid spacing 1.778 mm

AVAILABILITY FROM 2 to 38 contacts  
(standard number of contacts: 38)

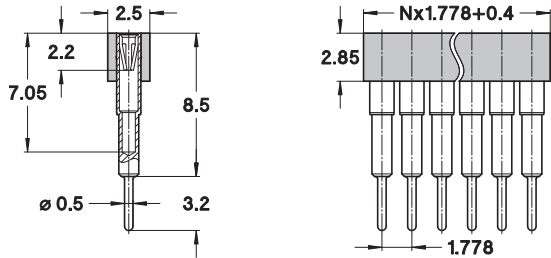

### 317-PP-1NN-41-026101

Straight socket connector elevated, single row, grid spacing 1.778 mm

AVAILABILITY FROM 2 to 38 contacts  
(standard number of contacts: 38)

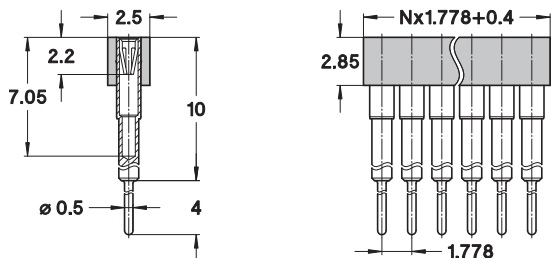

### 317-PP-1NN-01-687101

Straight socket connector, single row, grid spacing 1.8 mm for LCD-displays

AVAILABILITY FROM 2 to 42 contacts  
(standard number of contacts: 42)

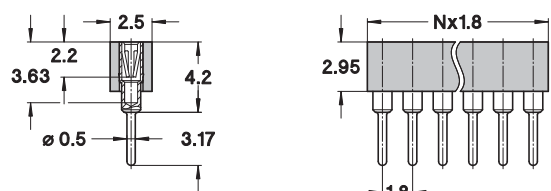



preci-dip

WWW.PRECIDIP.COM TEL +41 32 421 04 00 SALES@PRECIDIP.COM

# PIN CONNECTORS 1.778 mm

SINGLE ROW / SOLDER TAIL

PCB pin connectors, solder tail with reduced pin spacing 1,778 mm.

## TECHNICAL SPECIFICATIONS (FOR GENERAL SPECS, SEE PAGE 43)

INSULATOR	Black glass filled polyester PCT-GF30-FR
FLAMMABILITY	UL 94V-0
CONTACT	Brass CuZn36Pb3 (C36000)
CONNECTING PIN Ø	0.47 mm
MECHANICAL LIFE	Min. 500 cycles
RATED CURRENT	1 A
DIELECTRIC STRENGTH	Min. 1'000 V <sub>RMS</sub>

For corresponding socket connectors, see page 55.

## ORDERING INFORMATION ROHS COMPLIANT PARTS

PP PLATING CODE	TERMINATION	CONNECTING PIN
10	0.25 µm gold	0.25 µm gold
80	Tin	Tin



Other plating on request (see page 178 for plating specs).

**NN number of poles.** Replace **NN** with the requested number of poles, e.g. 350-10-1**NN**-00-012101 for a single row version with 8 pins becomes 350-10-1**08**-00-012101.

### 350-PP-1NN-00-012101

Straight pin connector, single row, grid spacing 1.778 mm

AVAILABILITY FROM 2 to 38 contacts  
(standard number of contacts: 38)

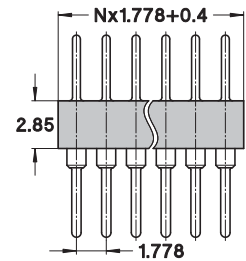
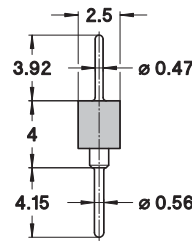





preci-dip

WWW.PRECIDIP.COM TEL +41 32 421 04 00 SALES@PRECIDIP.COM

# SOCKET CONNECTORS 2 mm

SINGLE ROW / DOUBLE ROW / SOLDER TAIL

"Hard metric" PCB socket connectors, solder tail.

## TECHNICAL SPECIFICATIONS (FOR GENERAL SPECS, SEE PAGE 43)

<b>INSULATOR</b>	Black glass filled polymer LCP-GF30-FR
<b>FLAMMABILITY</b>	UL 94V-0
<b>SLEEVE</b>	Brass CuZn36Pb3 (C36000)
<b>CONTACT CLIP (6 FINGER)</b>	Beryllium copper (C17200)
<b>MATING PINS</b>	Ø 0.40 to 0.66 mm, $\nabla$ 0.50 mm
<b>FORCES</b>	0.7 N typ. insertion      0.4 N typ. withdrawal (polished steel gauge Ø 0.46 mm)
<b>MECHANICAL LIFE</b>	Min. 500 cycles
<b>RATED CURRENT</b>	3 A
<b>CONTACT RESISTANCE</b>	Max. 10 mΩ
<b>DIELECTRIC STRENGTH</b>	Min. 1'000 V <sub>RMS</sub>

For corresponding pin connectors, see pages 64-68.

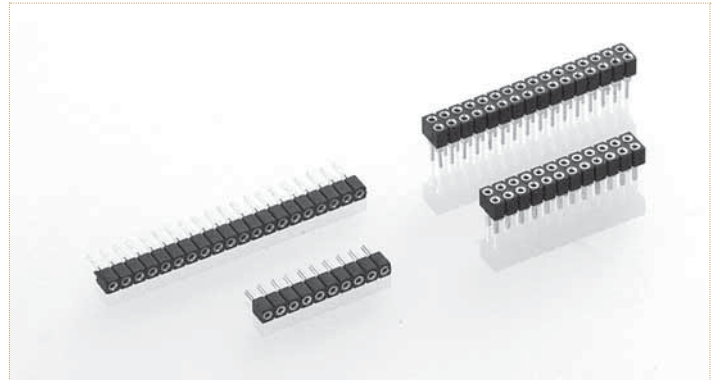

Other plating on request (see page 178 for plating specs).

**NNN number of poles.** Replace **NNN** with the requested number of poles, e.g. 833-87-**NNN**-10-001101 for a double row version with 16 pins becomes 833-87-**016**-10-001101.

## ORDERING INFORMATION ROHS COMPLIANT PARTS

PP PLATING CODE	SLEEVE	CLIP
87	Tin	Flash gold
83	Tin	0.75 µm gold

### 831-PP-NNN-10-273101

Straight socket connector, low profile height 2.8 mm, solder tail, single row

**AVAILABILITY FROM** 2 to 50 contacts  
(standard number of contacts: 50)

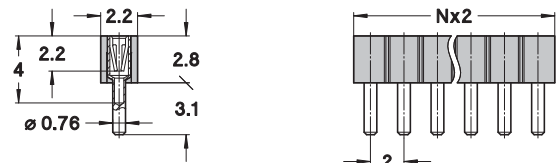

### 833-PP-NNN-10-273101

Straight socket connector, low profile height 2.8 mm, solder tail, double row

**AVAILABILITY FROM** 4 to 100 contacts  
(standard number of contacts: 100)

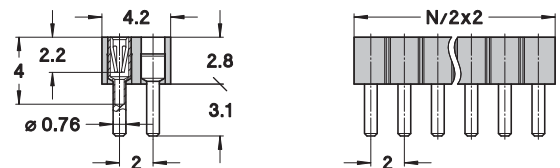

### 831-PP-NNN-10-001101

Straight socket connector, height 4.2 mm, solder tail, single row

**AVAILABILITY FROM** 2 to 50 contacts  
(standard number of contacts: 50)

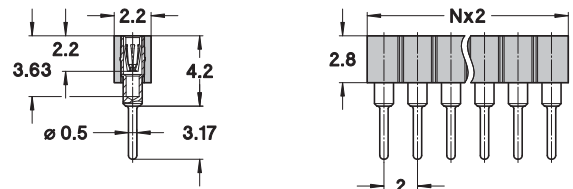

### 833-PP-NNN-10-001101

Straight socket connector, height 4.2 mm, solder tail, double row

**AVAILABILITY FROM** 4 to 100 contacts  
(standard number of contacts: 100)

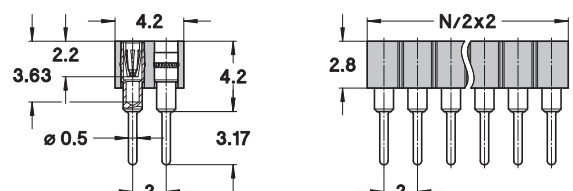



preci-dip

WWW.PRECIDIP.COM TEL +41 32 421 04 00 SALES@PRECIDIP.COM

# SOCKET CONNECTORS 2 mm

SINGLE ROW / DOUBLE ROW / SOLDER TAIL

"Hard metric" PCB socket connectors, solder tail.

## TECHNICAL SPECIFICATIONS (FOR GENERAL SPECS, SEE PAGE 43)

<b>INSULATOR</b>	Black glass filled polymer LCP-GF30-FR (PCT-GF30-FR for 833...10-457101)
<b>FLAMMABILITY</b>	UL 94V-0
<b>SLEEVE</b>	Brass CuZn36Pb3 (C36000)
<b>CONTACT CLIP (6 FINGER)</b>	Beryllium copper (C17200)
<b>MATING PINS</b>	Ø 0.40 to 0.56 mm, $\nabla$ 0.50 mm
<b>FORCES</b>	0.7 N typ. insertion      0.4 N typ. withdrawal (polished steel gauge Ø 0.46 mm)
<b>MECHANICAL LIFE</b>	Min. 500 cycles
<b>RATED CURRENT</b>	3 A
<b>CONTACT RESISTANCE</b>	Max. 10 mΩ
<b>DIELECTRIC STRENGTH</b>	Min. 1'000 V <sub>RMS</sub>

For corresponding pin connectors, see pages 64-68.

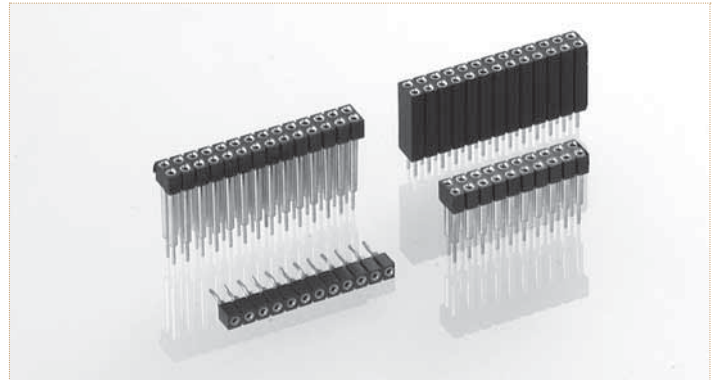

Other plating on request (see page 178 for plating specs).

**NNN number of poles.** Replace **NNN** with the requested number of poles, e.g. 833-87-**NNN**-10-453101 for a double row version with 16 pins becomes 833-87-**016**-10-453101.

## ORDERING INFORMATION ROHS COMPLIANT PARTS

PP PLATING CODE	SLEEVE	CLIP
87	Tin	Flash gold
83	Tin	0.75 µm gold

### 831-PP-NNN-10-230101

Straight socket connector, height 4.2 mm, with clinched (right/left) solder tails, single row

**AVAILABILITY FROM** 3 to 50 contacts  
(standard number of contacts: 50)

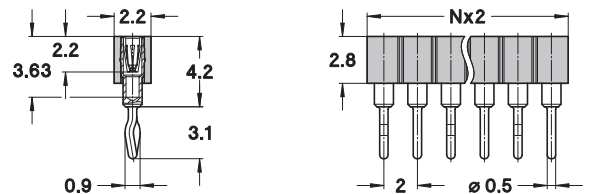

### 833-PP-NNN-10-453101

Straight socket connector, height 8 mm, solder tail, double row

**AVAILABILITY FROM** 4 to 100 contacts  
(standard number of contacts: 100)

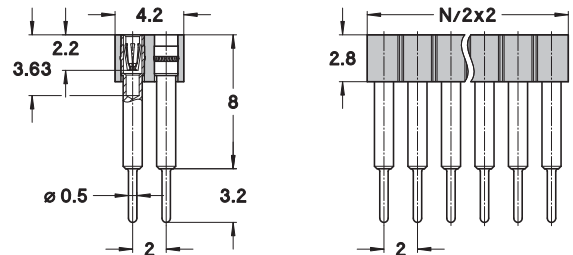

### 833-PP-NNN-10-457101

Straight socket connector, height 10.4 mm, solder tail, double row

**AVAILABILITY FROM** 4 to 50 contacts  
(standard number of contacts: 50)

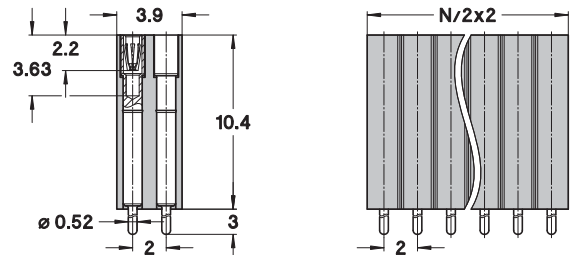

### 833-PP-NNN-10-287101

Straight socket connector, height 11.5 mm, solder tail, double row

**AVAILABILITY FROM** 4 to 100 contacts  
(standard number of contacts: 100)

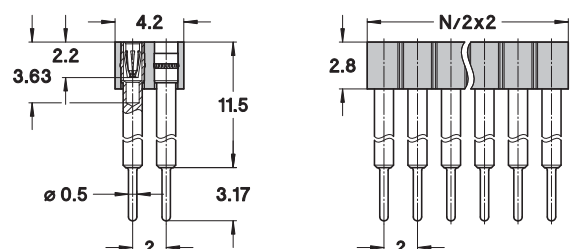



preci-dip

WWW.PRECIDIP.COM TEL +41 32 421 04 00 SALES@PRECIDIP.COM

# SOCKET CONNECTORS 2 mm

SINGLE ROW / DOUBLE ROW / SOLDER TAIL

"Hard metric" PCB socket connectors, solder tail, polarised.

## TECHNICAL SPECIFICATIONS (FOR GENERAL SPECS, SEE PAGE 43)

INSULATOR	Black glass filled polymer LCP-GF30-FR
FLAMMABILITY	UL 94V-0
SLEEVE	Brass CuZn36Pb3 (C36000)
CONTACT CLIP (6 FINGER)	Beryllium copper (C17200)
MATING PINS	Ø 0.40 to 0.66 mm, $\nabla$ 0.50 mm
FORCES	0.7 N typ. insertion      0.4 N typ. withdrawal (polished steel gauge Ø 0.46 mm)
MECHANICAL LIFE	Min. 500 cycles
RATED CURRENT	3 A
CONTACT RESISTANCE	Max. 10 mΩ
DIELECTRIC STRENGTH	Min. 1'000 V <sub>RMS</sub>

For corresponding pin connectors, see pages 64-68.

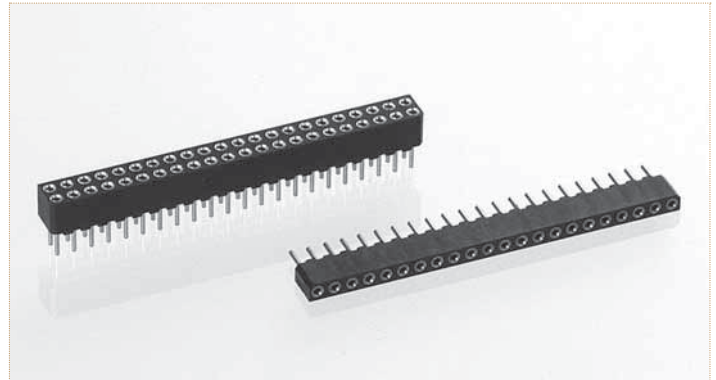

Other plating on request (see page 178 for plating specs).

**NNN number of poles.** Replace **NNN** with the requested number of poles, e.g. 833-87-**NNN**-10-245101 for a double row version with 26 pins becomes 833-87-**026**-10-245101.

## ORDERING INFORMATION ROHS COMPLIANT PARTS

PP PLATING CODE	SLEEVE	CLIP
87	Tin	Flash gold
83	Tin	0.75 µm gold

### 831-PP-NNN-10-242101

Straight socket connector height 4.55 mm, solder tail, single row, polarised

AVAILABILITY FROM	22 contacts
	Other pin number on request

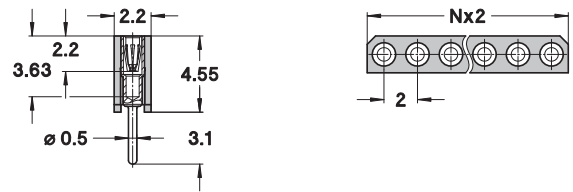

### 833-PP-NNN-10-245101

Straight socket connector height 4.55 mm, solder tail, double row, polarised

AVAILABILITY FROM	26 and 44 contacts
	Other pin number on request

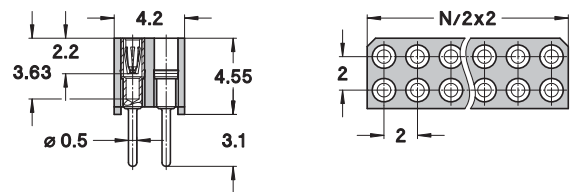



preci-dip

WWW.PRECIDIP.COM TEL +41 32 421 04 00 SALES@PRECIDIP.COM

# SOCKET CONNECTORS 2 mm

SINGLE ROW / DOUBLE ROW / SOLDER TAIL / RIGHT ANGLE

"Hard metric" PCB socket connectors right angle, solder tail.

## TECHNICAL SPECIFICATIONS (FOR GENERAL SPECS, SEE PAGE 43)

INSULATOR	Black glass filled polymer LCP-GF30-FR
FLAMMABILITY	UL 94V-0
SLEEVE	Brass CuZn36Pb3 (C36000)
CONTACT CLIP (6 FINGER)	Beryllium copper (C17200)
MATING PINS	Ø 0.40 to 0.66 mm, $\nabla$ 0.50 mm
FORCES	0.7 N typ. insertion      0.4 N typ. withdrawal (polished steel gauge Ø 0.46 mm)
MECHANICAL LIFE	Min. 500 cycles
RATED CURRENT	3 A
CONTACT RESISTANCE	Max. 10 mΩ
DIELECTRIC STRENGTH	Min. 1'000 V <sub>RMS</sub>

For corresponding pin connectors, see pages 64-68.

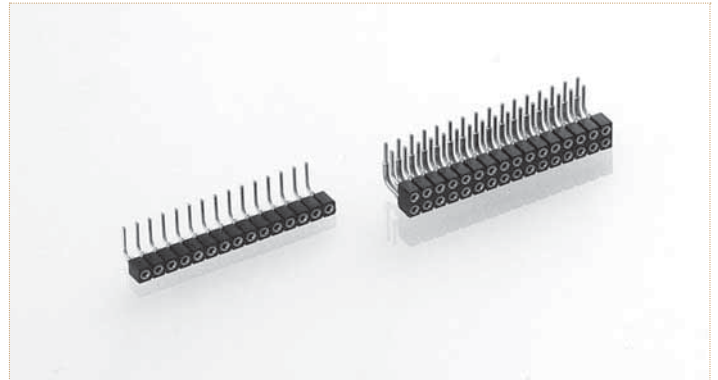

## ORDERING INFORMATION ROHS COMPLIANT PARTS

PP PLATING CODE	SLEEVE	CLIP
87	Tin	Flash gold
83	Tin	0.75 µm gold

Other plating on request (see page 178 for plating specs).

**NNN number of poles.** Replace **NNN** with the requested number of poles, e.g. 833-87-**NNN**-20-001101 for a double row version with 16 pins becomes 833-87-**016**-20-001101.

### 831-PP-NNN-20-001101

Right angle socket connector, solder tail, single row

AVAILABILITY FROM 2 to 50 contacts  
(standard number of contacts: 50)

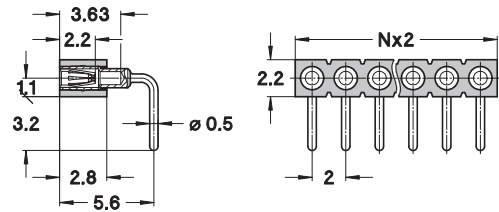

### 833-PP-NNN-20-001101

Right angle socket connector, solder tail, double row

AVAILABILITY FROM 4 to 100 contacts  
(standard number of contacts: 100)

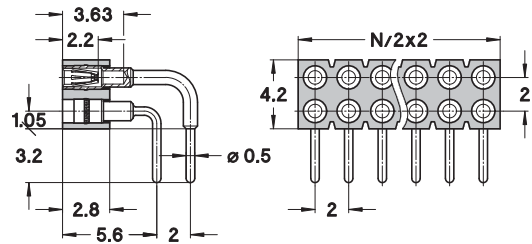





preci-dip

WWW.PRECIDIP.COM TEL +41 32 421 04 00 SALES@PRECIDIP.COM

# SOCKET CONNECTORS 2 mm

SINGLE ROW / DOUBLE ROW / SURFACE MOUNT

"Hard metric" PCB socket connectors, SMD perpendicular mount.

## TECHNICAL SPECIFICATIONS (FOR GENERAL SPECS, SEE PAGE 43)

<b>INSULATOR</b>	Black glass filled polymer LCP-GF30-FR
<b>FLAMMABILITY</b>	UL 94V-0
<b>SLEEVE</b>	Brass CuZn36Pb3 (C36000)
<b>CONTACT CLIP (6 FINGER)</b>	Beryllium copper (C17200)
<b>MATING PINS</b>	Ø 0.40 to 0.56 mm, $\nabla$ 0.50 mm
<b>FORCES</b>	0.7 N typ. insertion      0.4 N typ. withdrawal (polished steel gauge Ø 0.46 mm)
<b>MECHANICAL LIFE</b>	Min. 500 cycles
<b>RATED CURRENT</b>	3 A
<b>CONTACT RESISTANCE</b>	Max. 10 mΩ
<b>DIELECTRIC STRENGTH</b>	Min. 1'000 V <sub>RMS</sub>
<b>COPLANARITY SMD TERMINATIONS</b>	Max. 0.1 mm (measured on 25 mm long connectors)

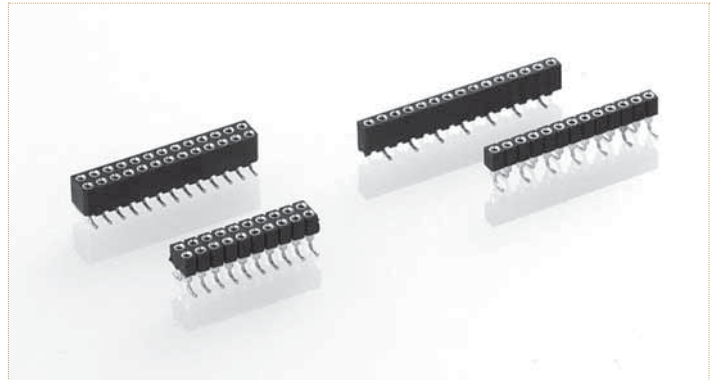

For corresponding pin connectors, see pages 64-68.

Other plating on request (see page 178 for plating specs).

**NNN number of poles.** Replace **NNN** with the requested number of poles, e.g. 833-87-**NNN**-30-001101 for a double row version with 16 pins becomes 833-87-**016**-30-001101.

## ORDERING INFORMATION ROHS COMPLIANT PARTS

PP PLATING CODE	SLEEVE	CLIP
87	Tin	Flash gold
83	Tin	0.75 µm gold

### Bulk: T & R Packaging with pick & place cap\* :

831-PP-**NNN**-30-001101    831-PP-**NNN**-30-001191

SMD socket connector, single row, perpendicular mount

**AVAILABILITY FROM**    3 to 50 contacts  
(standard number of contacts: 50)  
For connectors having more than 12 contacts, the coplanarity issue is to be addressed specifically

\*Please consult [www.precidip.com](http://www.precidip.com) for availability size of tape, size of reel, number of components per reel and packing units.

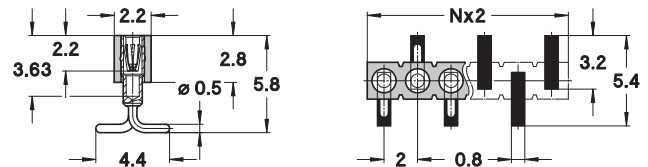

### Bulk: T & R Packaging with pick & place cap\* :

833-PP-**NNN**-30-001101    833-PP-**NNN**-30-001191

SMD socket connector, double row, perpendicular mount

**AVAILABILITY FROM**    4 to 100 contacts  
(standard number of contacts: 100)  
For connectors having more than 12 contacts per row, the coplanarity issue is to be addressed specifically

\*Please consult [www.precidip.com](http://www.precidip.com) for availability size of tape, size of reel, number of components per reel and packing units.

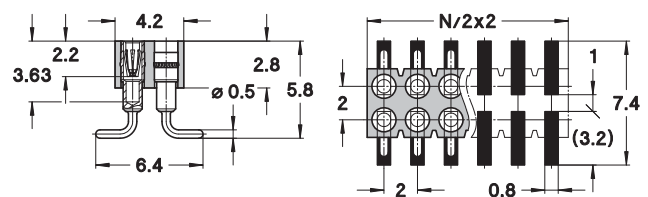

### Bulk: T & R Packaging with pick & place cap\* :

831-PP-**NNN**-30-242101    831-PP-**NNN**-30-242191

SMD socket connector, single row, perpendicular mount, polarised

**AVAILABILITY**            22 contacts  
Other pin number on request  
For connectors having more than 12 contacts, the coplanarity issue is to be addressed specifically

\*Please consult [www.precidip.com](http://www.precidip.com) for availability size of tape, size of reel, number of components per reel and packing units.

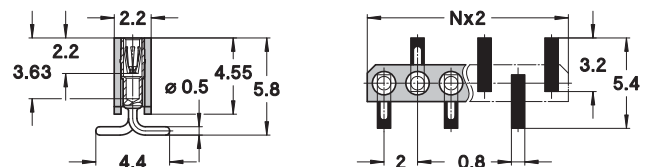

### Bulk: T & R Packaging with pick & place cap\* :

833-PP-**NNN**-30-245101    833-PP-**NNN**-30-245191

SMD socket connector, double row, perpendicular mount, polarised

**AVAILABILITY FROM**    26 and 44 contacts  
Other pin number on request  
For connectors having more than 12 contacts per row, the coplanarity issue is to be addressed specifically

\*Please consult [www.precidip.com](http://www.precidip.com) for availability size of tape, size of reel, number of components per reel and packing units.

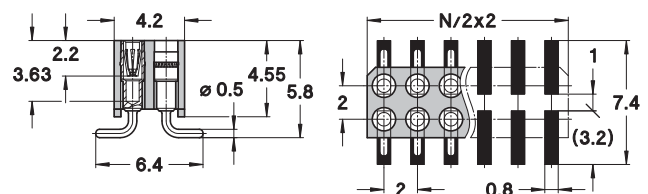

Due to technical progress, all information provided is subject to change without prior notice.





preci-dip

WWW.PRECIDIP.COM TEL +41 32 421 04 00 SALES@PRECIDIP.COM

# SOCKET CONNECTORS 2 mm

SINGLE ROW / DOUBLE ROW / PRESS-FIT

"Hard metric" PCB socket connectors, solderless press-fit mount.

## TECHNICAL SPECIFICATIONS (FOR GENERAL SPECS, SEE PAGE 43)

<b>INSULATOR</b>	Black glass filled polymer LCP-GF30-FR
<b>FLAMMABILITY</b>	UL 94V-0
<b>SLEEVE</b>	Bronze CuSn4Pb4Zn4 (C54400)
<b>CONTACT CLIP (6 FINGER)</b>	Beryllium copper (C17200)
<b>MATING PINS</b>	Ø 0.40 to 0.66 mm, $\nabla$ 0.50 mm
<b>FORCES</b>	0.7 N typ. insertion      0.4 N typ. withdrawal (polished steel gauge Ø 0.46 mm)
<b>MECHANICAL LIFE</b>	Min. 500 cycles
<b>RATED CURRENT</b>	3 A
<b>CONTACT RESISTANCE</b>	Max. 10 mΩ
<b>DIELECTRIC STRENGTH</b>	Min. 1'000 V <sub>RMS</sub>
<b>PCB HOLE Ø</b>	0.7 +0.07/-0.05 mm finished (0.8 ±0.025 mm drill)

For corresponding pin connectors, see pages 64-68.

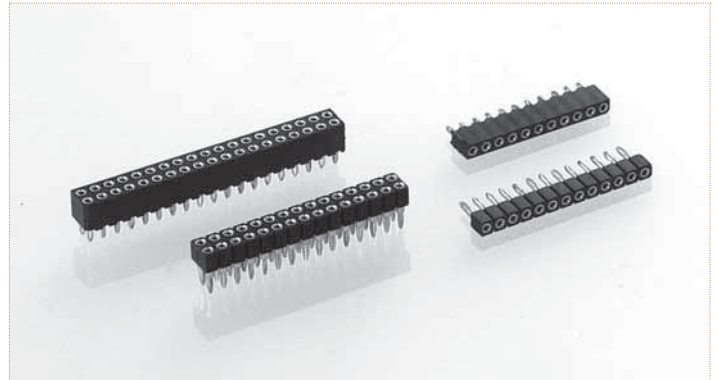

Other plating on request (see page 178 for plating specs).

**NNN number of poles.** Replace **NNN** with the requested number of poles, e.g. 833-87-**NNN**-64-001101 for a double row version with 16 pins becomes 833-87-**016**-64-001101.

## ORDERING INFORMATION ROHS COMPLIANT PARTS

PP PLATING CODE	SLEEVE	CLIP
87	Tin	Flash gold
83	Tin	0.75 µm gold

### 831-PP-NNN-64-001101

Press-fit socket connector, single row, compliant pin for PCB thickness 1.5 to 2 mm

**AVAILABILITY FROM** 2 to 50 contacts  
(standard number of contacts: 50)

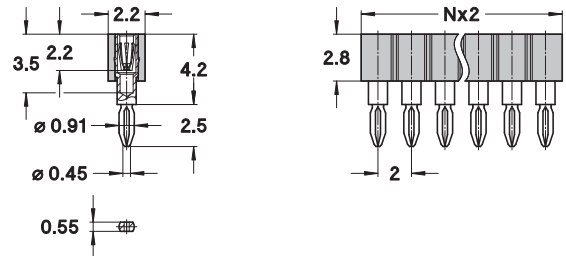

### 833-PP-NNN-64-001101

Press-fit socket connector, double row, compliant pin for PCB thickness 1.5 to 2 mm

**AVAILABILITY FROM** 4 to 100 contacts  
(standard number of contacts: 100)

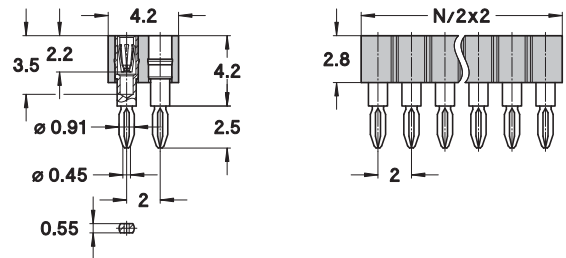

### 831-PP-NNN-64-242101

Press-fit socket connector polarised, single row, compliant pin for PCB thickness 1.5 to 2 mm

**AVAILABILITY** 22 contacts  
Other pin number on request

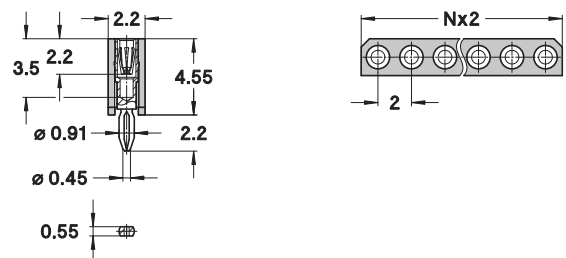

### 833-PP-NNN-64-245101

Press-fit socket connector polarised, double row, compliant pin for PCB thickness 1.5 to 2 mm

**AVAILABILITY** 26 and 44 contacts  
Other pin number on request

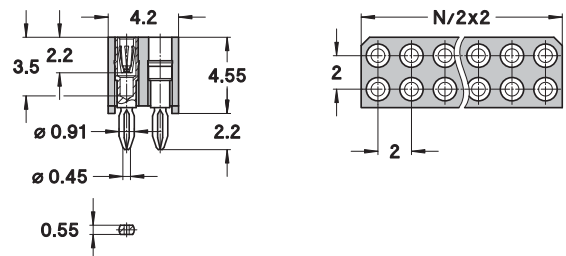



preci-dip

WWW.PRECIDIP.COM TEL +41 32 421 04 00 SALES@PRECIDIP.COM

# PIN CONNECTORS 2 mm

SINGLE ROW / DOUBLE ROW / SOLDER TAIL

"Hard metric" PCB pin connectors, solder tail.

## TECHNICAL SPECIFICATIONS (FOR GENERAL SPECS, SEE PAGE 43)

INSULATOR	Black glass filled polymer LCP-GF30-FR
FLAMMABILITY	UL 94V-0
CONTACT	Brass CuZn36Pb3 (C36000)
CONNECTING PIN Ø	0.47 mm
MECHANICAL LIFE	Min. 500 cycles
RATED CURRENT	3 A
DIELECTRIC STRENGTH	Min. 1'000 V <sub>RMS</sub>

For corresponding socket connectors, see pages 57-63.

## ORDERING INFORMATION ROHS COMPLIANT PARTS

PP PLATING CODE	TERMINATION	CONNECTING PIN
10	0.25 µm gold	0.25 µm gold
80	Tin	Tin
V3*	Tin	0.75 µm gold

\*only for 830/832...12-002101 series

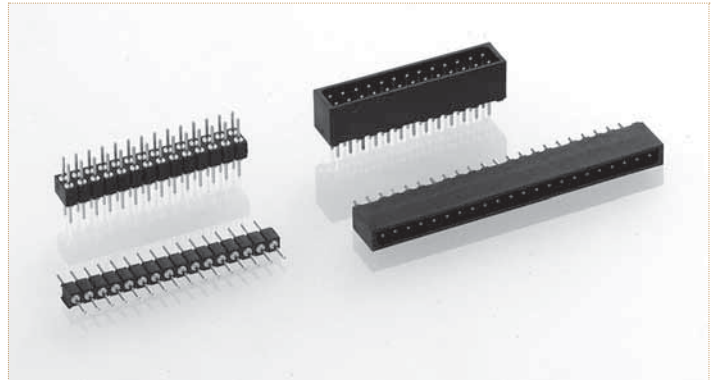

Other plating on request (see page 178 for plating specs).

**NNN number of poles.** Replace **NNN** with the requested number of poles, e.g. 830-10-**NNN**-10-001101 for a single row version with 8 pins becomes 830-10-**008**-10-001101.

### 830-PP-NNN-10-001101

Straight pin connector, solder tail, single row

AVAILABILITY FROM 2 to 50 contacts  
(standard number of contacts: 50)

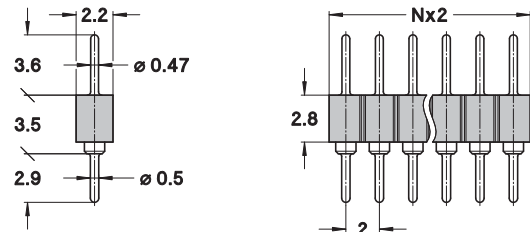

### 832-PP-NNN-10-001101

Straight pin connector, solder tail, double row

AVAILABILITY FROM 4 to 100 contacts  
(standard number of contacts: 100)

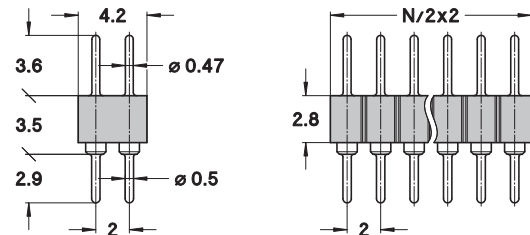

### 830-V3-NNN-12-002101

Straight pin connector, solder tail, single row, shrouded and polarised

AVAILABILITY 22 contacts  
Other pin number on request

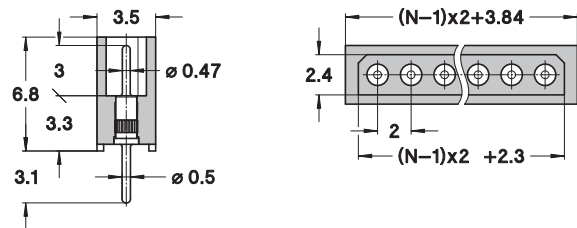

### 832-V3-NNN-12-002101

Straight pin connector, solder tail, double row, shrouded and polarised

AVAILABILITY 26 and 44 contacts  
Other pin number on request

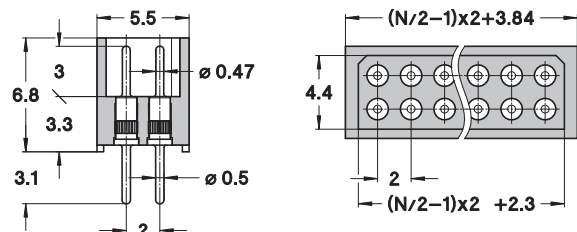





preci-dip

WWW.PRECIDIP.COM TEL +41 32 421 04 00 SALES@PRECIDIP.COM

# PIN CONNECTORS 2 mm

SINGLE ROW / DOUBLE ROW / SOLDER TAIL / RIGHT ANGLE

"Hard metric" PCB pin connectors, solder tail.

## TECHNICAL SPECIFICATIONS (FOR GENERAL SPECS, SEE PAGE 43)

INSULATOR	Black glass filled polymer LCP-GF30-FR
FLAMMABILITY	UL 94V-0
CONTACT	Brass CuZn36Pb3 (C36000)
CONNECTING PIN Ø	0.47 mm
MECHANICAL LIFE	Min. 500 cycles
RATED CURRENT	3 A
DIELECTRIC STRENGTH	Min. 1'000 V <sub>RMS</sub>

For corresponding socket connectors, see pages 57-63.

## ORDERING INFORMATION ROHS COMPLIANT PARTS

PP PLATING CODE	TERMINATION	CONNECTING PIN
10	0.25 µm gold	0.25 µm gold
80	Tin	Tin
V3*	Tin	0.75 µm gold

\*only for 830/832...22-002101 series

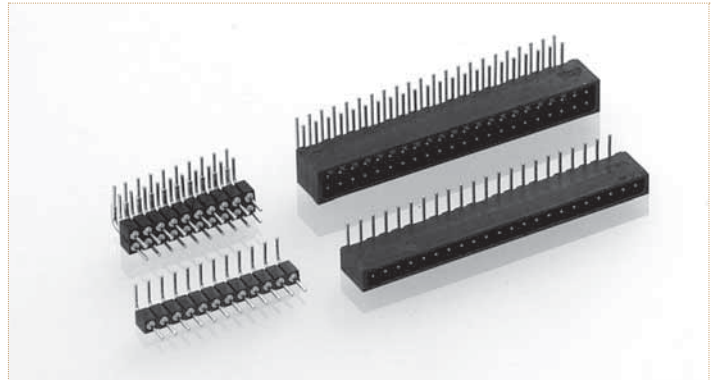

Other plating on request (see page 178 for plating specs).

**NNN number of poles.** Replace **NNN** with the requested number of poles, e.g. 830-10-**NNN**-20-001101 for a single row version with 8 pins becomes 830-10-**008**-20-001101.

### 830-PP-NNN-20-001101

Right angle pin connector, solder tail, single row

AVAILABILITY FROM 2 to 50 contacts  
(standard number of contacts: 50)

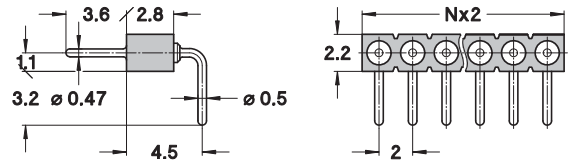

### 832-PP-NNN-20-001101

Right angle pin connector, solder tail, double row

AVAILABILITY FROM 4 to 100 contacts  
(standard number of contacts: 100)

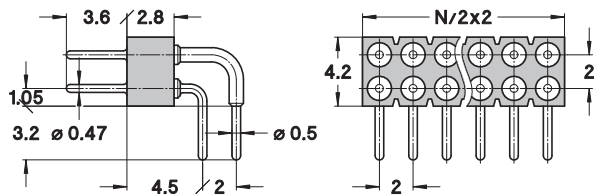

### 830-V3-NNN-22-002101

Right angle pin connector, solder tail, single row, shrouded and polarised

AVAILABILITY 22 contacts  
Other pin number on request

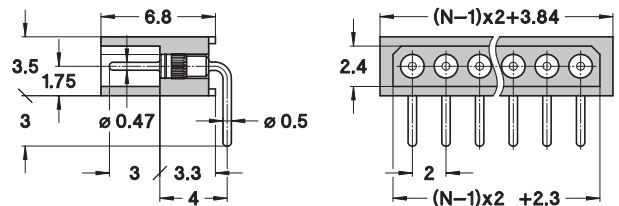

### 832-V3-NNN-22-002101

Right angle pin connector, solder tail, double row, shrouded and polarised

AVAILABILITY 26 and 44 contacts  
Other pin number on request

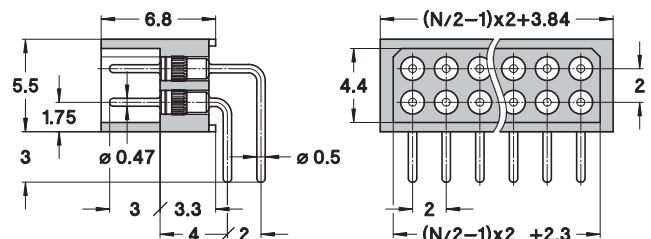



preci-dip

WWW.PRECIDIP.COM TEL +41 32 421 04 00 SALES@PRECIDIP.COM

# PIN CONNECTORS 2 mm

SINGLE ROW / DOUBLE ROW / SURFACE MOUNT

"Hard metric" PCB pin connectors, SMD mount.

## TECHNICAL SPECIFICATIONS (FOR GENERAL SPECS, SEE PAGE 43)

INSULATOR	Black glass filled polymer LCP-GF30-FR
FLAMMABILITY	UL 94V-0
CONTACT	Brass CuZn36Pb3 (C36000)
CONNECTING PIN Ø	0.47 mm
MECHANICAL LIFE	Min. 500 cycles
RATED CURRENT	3 A
DIELECTRIC STRENGTH	Min. 1'000 V <sub>RMS</sub>
COPLANARITY SMD TERMINATIONS	Max. 0.1 mm (measured on 25 mm long connectors)

For corresponding socket connectors, see pages 57-63.

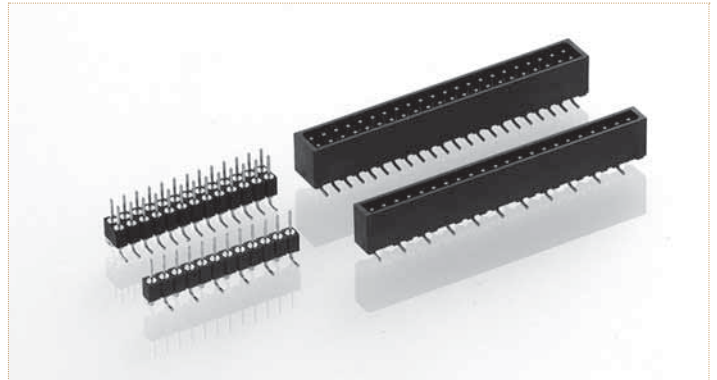

## ORDERING INFORMATION ROHS COMPLIANT PARTS

PP PLATING CODE	TERMINATION	CONNECTING PIN
10	0.25 µm gold	0.25 µm gold
80	Tin	Tin
V3*	Tin	0.75 µm gold

\*only for 830/832...32-002101 series

Other plating on request (see page 178 for plating specs).

**NNN number of poles.** Replace **NNN** with the requested number of poles, e.g. 830-10-**NNN**-30-001101 for a single row version with 8 pins becomes 830-10-**008**-30-001101.

### Bulk: T & R Packaging with pick & place cap\* :

830-PP-**NNN**-30-001101 830-PP-**NNN**-30-001191

SMD pin connector, single row, perpendicular mount

AVAILABILITY FROM 3 to 50 contacts  
(standard number of contacts: 50)  
For connectors having more than 12 contacts, the coplanarity issue is to be addressed specifically

\*Please consult [www.precidip.com](http://www.precidip.com) for availability size of tape, size of reel, number of components per reel and packing units.

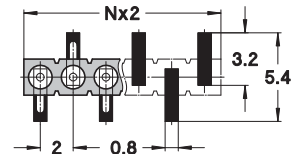
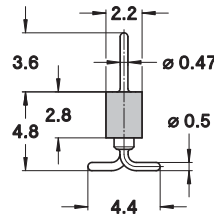

### Bulk: T & R Packaging with pick & place cap\* :

832-PP-**NNN**-30-001101 832-PP-**NNN**-30-001191

SMD pin connector, double row, perpendicular mount

AVAILABILITY FROM 4 to 100 contacts  
(Standard number of contacts: 100)  
For connectors having more than 12 contacts per row, the coplanarity issue is to be addressed specifically

\*Please consult [www.precidip.com](http://www.precidip.com) for availability size of tape, size of reel, number of components per reel and packing units.

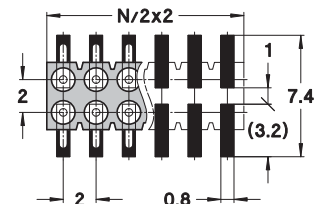
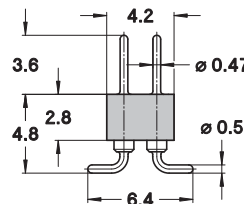

### Bulk: T & R Packaging with pick & place cap\* :

830-V3-**NNN**-32-002101 830-V3-**NNN**-32-002191

SMD pin connector, single row, perpendicular mount, shrouded and polarised

AVAILABILITY 22 contacts  
Other pin number on request  
For connectors having more than 12 contacts per row, the coplanarity issue is to be addressed specifically

\*Please consult [www.precidip.com](http://www.precidip.com) for availability size of tape, size of reel, number of components per reel and packing units.

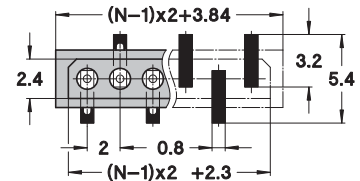
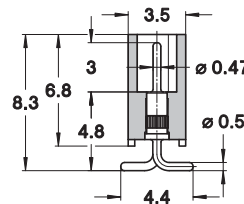

### Bulk: T & R Packaging with pick & place cap\* :

832-V3-**NNN**-32-002101 832-V3-**NNN**-32-002191

SMD pin connector, double row, perpendicular mount, shrouded and polarised

AVAILABILITY 26 and 44 contacts  
Other pin number on request  
For connectors having more than 12 contacts per row, the coplanarity issue is to be addressed specifically

\*Please consult [www.precidip.com](http://www.precidip.com) for availability size of tape, size of reel, number of components per reel and packing units.

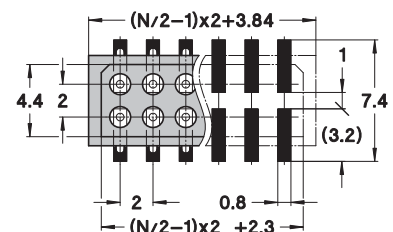
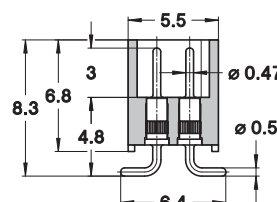



preci-dip

WWW.PRECIDIP.COM TEL +41 32 421 04 00 SALES@PRECIDIP.COM

# PIN CONNECTORS 2 mm

SINGLE ROW / SURFACE MOUNT

"Hard metric" PCB pin connectors, SMD mount.

## TECHNICAL SPECIFICATIONS (FOR GENERAL SPECS, SEE PAGE 43)

INSULATOR	Black glass filled polymer LCP-GF30-FR
FLAMMABILITY	UL 94V-0
CONTACT	Brass CuZn36Pb3 (C36000)
CONNECTING PIN Ø	0.47 mm
MECHANICAL LIFE	Min. 500 cycles
RATED CURRENT	3 A
DIELECTRIC STRENGTH	Min. 1'000 V <sub>RMS</sub>
COPLANARITY	
SMD TERMINATIONS	Max. 0.1 mm (measured on 25 mm long connectors)

For corresponding socket connectors, see pages 57-63.

## ORDERING INFORMATION ROHS COMPLIANT PARTS

PP PLATING CODE	TERMINATION	CONNECTING PIN
10	0.25 µm gold	0.25 µm gold
80	Tin	Tin

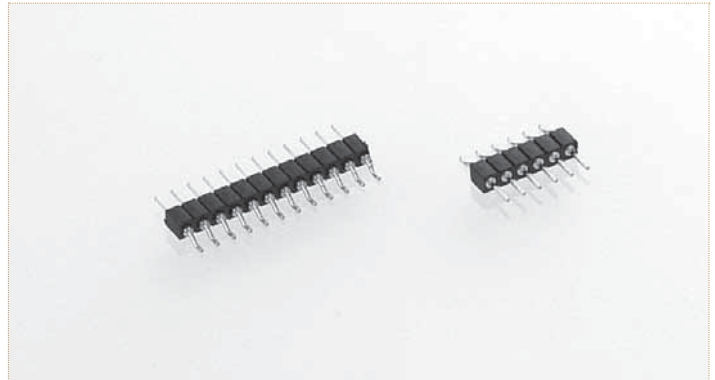

Other plating on request (see page 178 for plating specs).

**NNN number of poles.** Replace **NNN** with the requested number of poles, e.g. 830-10-**NNN**-40-001101 for a single row version with 8 pins becomes 830-10-**008**-40-001101.

**Bulk:** 830-PP-**NNN**-40-001101 **T & R Packaging\*:** 830-PP-**NNN**-40-001191

SMD pin connector, single row, parallel mount

**AVAILABILITY FROM** 2 to 50 contacts  
(standard number of contacts: 50)  
For connectors having more than 12 contacts, the coplanarity issue is to be addressed specifically

\*Please consult [www.precidip.com](http://www.precidip.com) for availability size of tape, size of reel, number of components per reel and packing units.

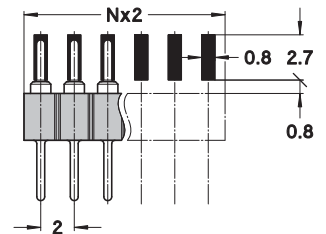
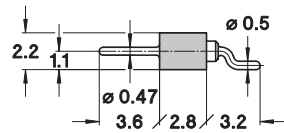



preci-dip

WWW.PRECIDIP.COM TEL +41 32 421 04 00 SALES@PRECIDIP.COM

# PIN CONNECTORS 2 mm

SQUARE PIN  $\square$  0.5 mm / SINGLE ROW / DOUBLE ROW / SOLDER TAIL

Square pin headers, solder tail.

## TECHNICAL SPECIFICATIONS (FOR GENERAL SPECS, SEE PAGE 43)

INSULATOR	Black glass filled polyamide PA-GF30-FR
FLAMMABILITY	UL 94V-0
CONTACT	Brass
CONNECTING PIN	$\square$ 0.5 mm
MECHANICAL LIFE	Min. 100 cycles
RATED CURRENT	1 A
DIELECTRIC STRENGTH	Min. 500 V <sub>RMS</sub>

For corresponding socket connectors, see pages 57-63.

## ORDERING INFORMATION ROHS COMPLIANT PARTS

PP PLATING CODE	TERMINATION	CONNECTING PIN
70	Flash gold	Flash gold

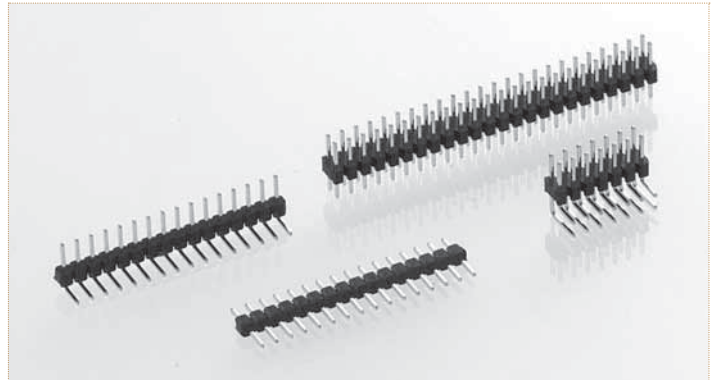

See page 178 for plating specs.

**NNN number of poles.** Replace **NNN** with the requested number of poles, e.g. 880-70-**NNN**-10-001101 for a single row version with 8 pins becomes 880-70-**008**-10-001101.

### 880-70-**NNN**-10-001101

Straight square pin header, solder tail, single row

AVAILABILITY FROM 2 to 40 contacts  
(standard number of contacts: 40)

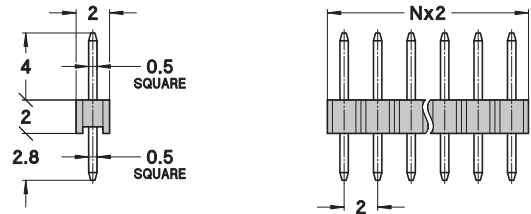

### 882-70-**NNN**-10-001101

Straight square pin header, solder tail, double row

AVAILABILITY FROM 4 to 80 contacts  
(standard number of contacts: 80)

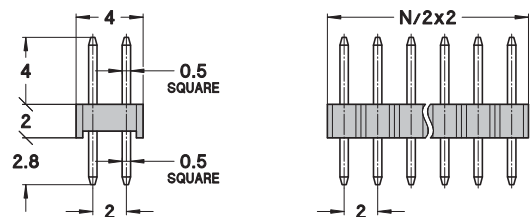

### 880-70-**NNN**-20-001101

Right angle square pin header, solder tail, single row

AVAILABILITY FROM 2 to 40 contacts  
(standard number of contacts: 40)

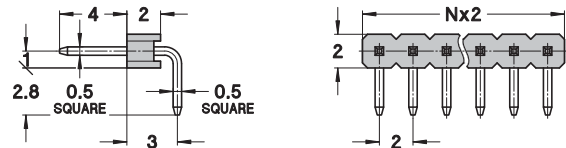

### 882-70-**NNN**-20-001101

Right angle square pin header, solder tail, double row

AVAILABILITY FROM 4 to 80 contacts  
(standard number of contacts: 80)

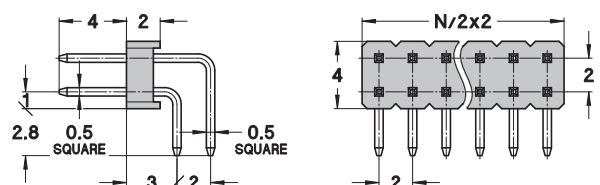





preci-dip

WWW.PRECIDIP.COM TEL +41 32 421 04 00 SALES@PRECIDIP.COM

# SOCKET CONNECTORS 2.54 mm

MATING PIN Ø 0.47 mm / SINGLE ROW / DOUBLE ROW / SOLDER TAIL

Ultralow and very low profile socket connectors, solder tail.

## TECHNICAL SPECIFICATIONS (FOR GENERAL SPECS, SEE PAGE 43)

<b>INSULATOR</b>	Black glass filled polyester PCT-GF30-FR
<b>FLAMMABILITY</b>	UL 94V-0
<b>SLEEVE</b>	Brass CuZn36Pb3 (C36000)
<b>CONTACT CLIP (4 FINGER)</b>	Beryllium copper (C17200)
<b>MATING PIN Ø</b>	0.40 to 0.52 mm
<b>FORCES</b>	3 N typ. insertion      1.5 N typ. withdrawal (polished steel gauge Ø 0.43 mm)
<b>MECHANICAL LIFE</b>	Min. 500 cycles
<b>RATED CURRENT</b>	1 A
<b>CONTACT RESISTANCE</b>	Max. 10 mΩ
<b>DIELECTRIC STRENGTH</b>	Min. 1'000 V <sub>RMS</sub>

For corresponding pin connectors, see pages 101-108.

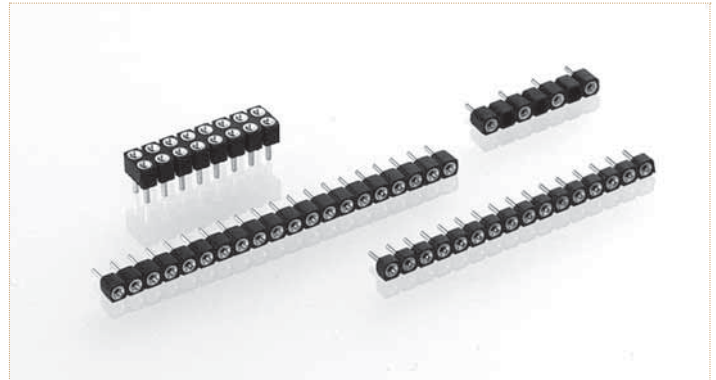

## ORDERING INFORMATION ROHS COMPLIANT PARTS

PP PLATING CODE	SLEEVE	CLIP
87	Tin	Flash gold
83	Tin	0.75 µm gold

Other plating on request (see page 178 for plating specs).

**NN number of poles.** Replace NN with the requested number of poles, e.g. 415-83-2NN-41-001101 for a double row version with 16 pins becomes 415-83-216-41-001101.

### 315-PP-1NN-41-003101

Straight socket connector ultralow profile, height 2.4 mm, solder tail, single row

**AVAILABILITY FROM** 2 to 64 contacts  
(standard number of contacts: 64)  
Please note: ultralow version not available as double row

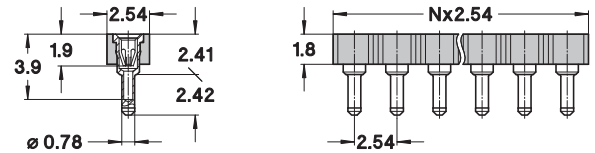

### 315-PP-1NN-41-001101

Straight socket connector very low profile, height 3.14 mm, solder tail, single row

**AVAILABILITY FROM** 2 to 64 contacts  
(standard number of contacts: 64)

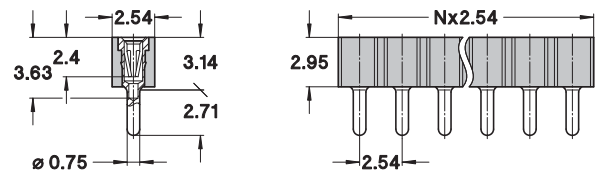

### 415-PP-2NN-41-001101

Straight socket connector very low profile, height 3.14 mm, solder tail, double row

**AVAILABILITY FROM** 4 to 72 contacts  
(standard number of contacts: 72)  
Please note: ultralow version not available as double row

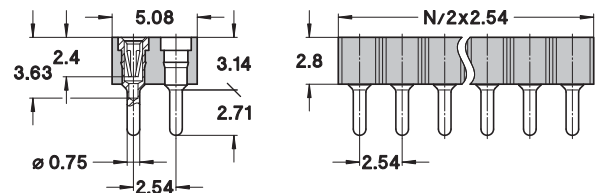

### 315-PP-1YY-01-881101

Straight socket connector very low profile, height 3.14 mm, partially equipped 5.08 mm, solder tail, single row

**AVAILABILITY FROM** 2 to 32 contacts  
**YY number of poles:**  
please consult for ordering code

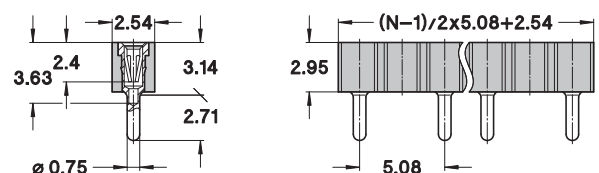



preci-dip

WWW.PRECIDIP.COM TEL +41 32 421 04 00 SALES@PRECIDIP.COM

# SOCKET CONNECTORS 2.54 mm

MATING PIN Ø 0.47 mm / SINGLE ROW / DOUBLE ROW / SOLDER TAIL

Socket connector strips, solder tail.

## TECHNICAL SPECIFICATIONS (FOR GENERAL SPECS, SEE PAGE 43)

INSULATOR	Black glass filled polyester PCT-GF30-FR
FLAMMABILITY	UL 94V-0
SLEEVE	Brass CuZn36Pb3 (C36000)
CONTACT CLIP (4 FINGER)	Beryllium copper (C17200)
MATING PIN Ø	0.40 to 0.56 mm
FORCES	2 N typ. insertion      1 N typ. withdrawal (polished steel gauge Ø 0.43 mm)
MECHANICAL LIFE	Min. 500 cycles
RATED CURRENT	3 A
CONTACT RESISTANCE	Max. 10 mΩ
DIELECTRIC STRENGTH	Min. 1'000 V <sub>RMS</sub>

For corresponding pin connectors, see pages 101-108.

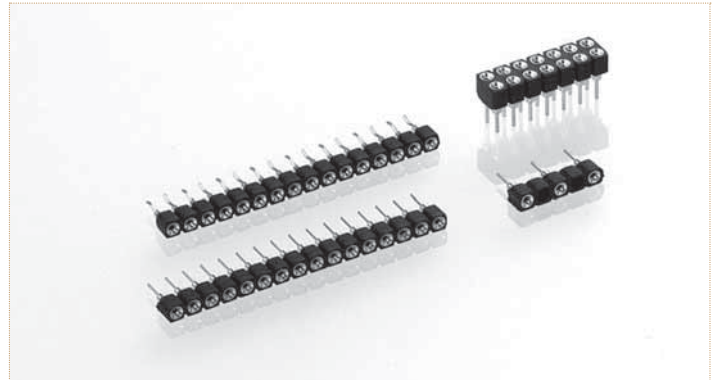

## ORDERING INFORMATION ROHS COMPLIANT PARTS

PP PLATING CODE	SLEEVE	CLIP
87	Tin	Flash gold
83	Tin	0.75 µm gold

Other plating on request (see page 178 for plating specs).

**NN number of poles.** Replace NN with the requested number of poles, e.g. 410-83-2NN-41-001101 for a double row version with 16 pins becomes 410-83-216-41-001101.

### 310-PP-1NN-41-001101

Straight socket connector height 4.2 mm, solder tail, single row

AVAILABILITY FROM 2 to 64 contacts  
(standard number of contacts: 64)

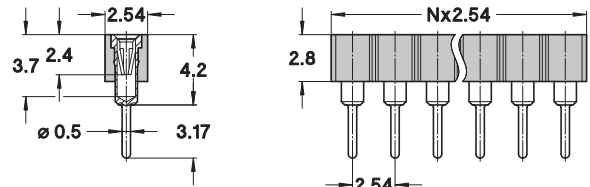

### 410-PP-2NN-41-001101

Straight socket connector height 4.2 mm, solder tail, double row

AVAILABILITY FROM 4 to 72 contacts  
(standard number of contacts: 72)

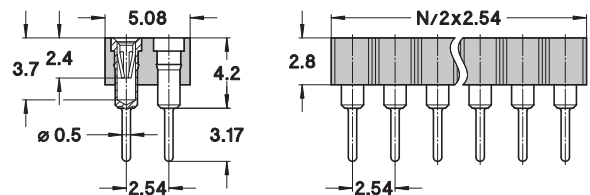

### 310-PP-1YY-01-609101

Straight socket connector height 4.2 mm, solder tail, single row, partially equipped 5.08 mm

AVAILABILITY FROM 2 to 32 contacts  
**YY number of poles:**  
please consult for ordering code

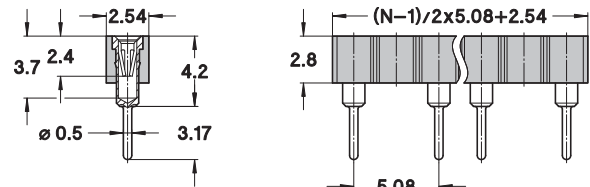

### 310-PP-1NN-01-666101

Straight socket connector height 4.2 mm, with clinched (right/left) solder tails, single row

AVAILABILITY FROM 3 to 64 contacts  
(standard number of contacts: 64)

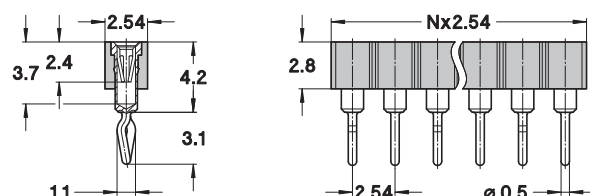



preci-dip

WWW.PRECIDIP.COM TEL +41 32 421 04 00 SALES@PRECIDIP.COM

# SOCKET CONNECTORS 2.54 mm

MATING PIN Ø 0.47 mm / SINGLE ROW / DOUBLE ROW / SOLDER TAIL

Socket connectors, long solder tail.

## TECHNICAL SPECIFICATIONS (FOR GENERAL SPECS, SEE PAGE 43)

INSULATOR	Black glass filled polyester PCT-GF30-FR
FLAMMABILITY	UL 94V-0
SLEEVE	Brass CuZn36Pb3 (C36000)
CONTACT CLIP (4 FINGER)	Beryllium copper (C17200)
MATING PIN Ø	0.40 to 0.56 mm
FORCES	2 N typ. insertion      1 N typ. withdrawal (polished steel gauge Ø 0.43 mm)
MECHANICAL LIFE	Min. 500 cycles
RATED CURRENT	3 A
CONTACT RESISTANCE	Max. 10 mΩ
DIELECTRIC STRENGTH	Min. 1'000 V <sub>RMS</sub>

For corresponding pin connectors, see pages 101-108.

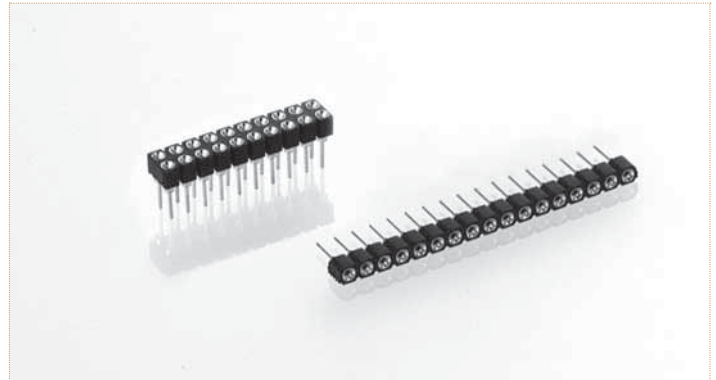

## ORDERING INFORMATION ROHS COMPLIANT PARTS

PP PLATING CODE	SLEEVE	CLIP
87	Tin	Flash gold
83	Tin	0.75 µm gold

Other plating on request (see page 178 for plating specs).

**NN number of poles.** Replace NN with the requested number of poles, e.g. 411-83-2NN-41-001101 for a double row version with 16 pins becomes 411-83-216-41-001101.

### 311-PP-1NN-41-001101

Straight socket connector height 4.1 mm, long solder tail, single row

AVAILABILITY FROM 2 to 64 contacts  
(standard number of contacts: 64)

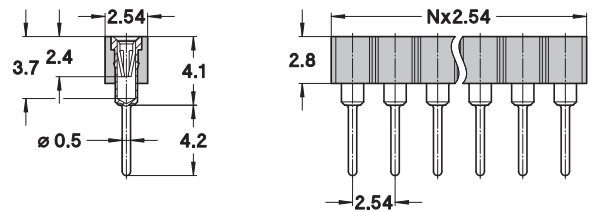

### 411-PP-2NN-41-001101

Straight socket connector height 4.1 mm, long solder tail, double row

AVAILABILITY FROM 4 to 72 contacts  
(standard number of contacts: 72)

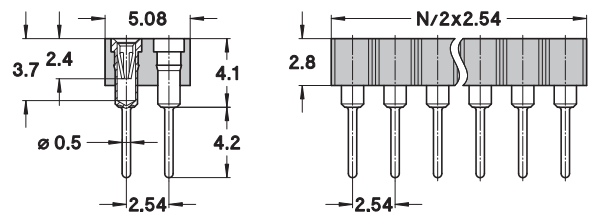



preci-dip

WWW.PRECIDIP.COM TEL +41 32 421 04 00 SALES@PRECIDIP.COM

# SOCKET CONNECTORS 2.54 mm

MATING PIN Ø 0.47 mm / SINGLE ROW / DOUBLE ROW / TRIPLE ROW  
SOLDER TAIL

Socket connectors, solder tail with standoff.

## TECHNICAL SPECIFICATIONS (FOR GENERAL SPECS, SEE PAGE 43)

INSULATOR	Black glass filled polyester PCT-GF30-FR
FLAMMABILITY	UL 94V-0
SLEEVE	Brass CuZn36Pb3 (C36000)
CONTACT CLIP (4 FINGER)	Beryllium copper (C17200)
MATING PIN Ø	0.40 to 0.56 mm
FORCES	2 N typ. insertion      1 N typ. withdrawal (polished steel gauge Ø 0.43 mm)
MECHANICAL LIFE	Min. 500 cycles
RATED CURRENT	3 A
CONTACT RESISTANCE	Max. 10 mΩ
DIELECTRIC STRENGTH	Min. 1'000 V <sub>RMS</sub>

For corresponding pin connectors, see pages 101-108.

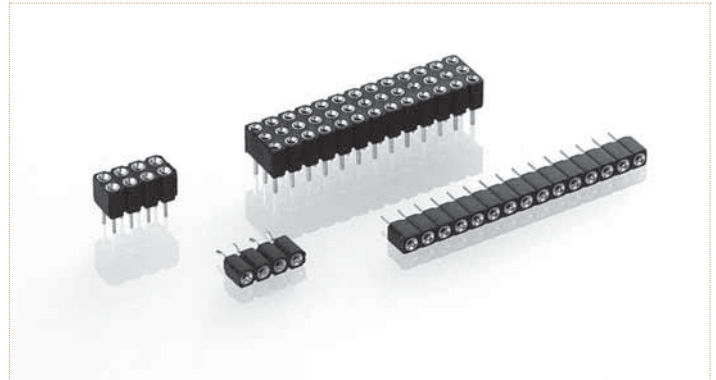

## ORDERING INFORMATION ROHS COMPLIANT PARTS

PP PLATING CODE	SLEEVE	CLIP
87	Tin	Flash gold
83	Tin	0.75 µm gold

Other plating on request (see page 178 for plating specs).

**NN number of poles.** Replace NN with the requested number of poles, e.g. 410-83-2**NN**-01-640101 for a double row version with 16 pins becomes 410-83-2**16**-01-640101.

### 310-PP-1NN-01-640101

Straight socket connector height 4.2 mm, solder tail, single row, with standoff

AVAILABILITY FROM 2 to 32 contacts  
(standard number of contacts: 32)

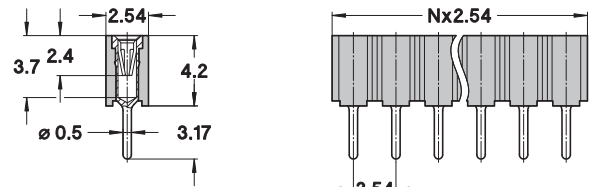

### 410-PP-2NN-01-640101

Straight socket connector height 4.2 mm, solder tail, double row, with standoff

AVAILABILITY FROM 4 to 64 contacts  
(standard number of contacts: 64)

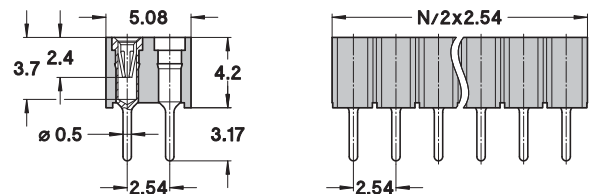

### 410-PP-3NN-01-640101

Straight socket connector height 4.2 mm: solder tail, triple row, with standoff

AVAILABILITY FROM 9 to 96 contacts  
(standard number of contacts: 96)

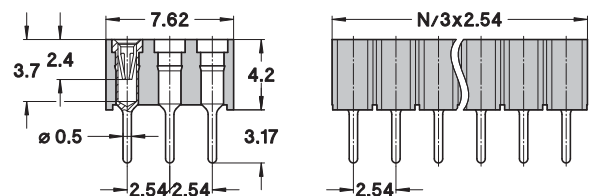

### 310-PP-1NN-01-754101

Straight socket connector height 4.2 mm, with clinched (right/left) solder tails, single row, with standoff

AVAILABILITY FROM 3 to 32 contacts  
(standard number of contacts 32):

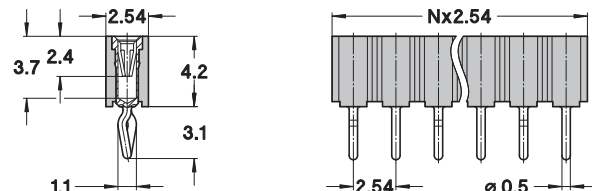





preci-dip

WWW.PRECIDIP.COM TEL +41 32 421 04 00 SALES@PRECIDIP.COM

# SOCKET CONNECTORS 2.54 mm

MATING PIN Ø 0.47 mm / DOUBLE ROW / SOLDER TAIL

Socket connectors, solder tail.

## TECHNICAL SPECIFICATIONS (FOR GENERAL SPECS, SEE PAGE 43)

INSULATOR	Black glass filled polyester PCT-GF30-FR
FLAMMABILITY	UL 94V-0
SLEEVE	Brass CuZn36Pb3 (C36000)
CONTACT CLIP (4 FINGER)	Beryllium copper (C17200)
MATING PIN Ø	0.36 to 0.46 mm
FORCES	2 N typ. insertion      1 N typ. withdrawal (polished steel gauge Ø 0.43 mm)
MECHANICAL LIFE	Min. 500 cycles
RATED CURRENT	3 A
CONTACT RESISTANCE	Max. 10 mΩ
DIELECTRIC STRENGTH	Min. 1'000 V <sub>RMS</sub>

For corresponding pin connectors, see pages 101-108.



Other plating on request (see page 178 for plating specs).

## ORDERING INFORMATION ROHS COMPLIANT PARTS

PP PLATING CODE	SLEEVE	CLIP
87	Tin	Flash gold
83	Tin	0.75 µm gold

### 805-PP-YYY-10-229101

Straight socket connector height 4.2 mm. solder tail, double row, partially equipped 5.08 mm

AVAILABILITY FROM 4 to 32 contacts

**YYY number of poles:**

please consult for ordering code

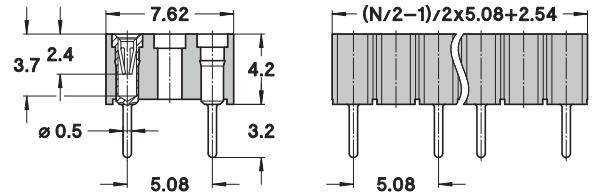



preci-dip

WWW.PRECIDIP.COM TEL +41 32 421 04 00 SALES@PRECIDIP.COM

# SOCKET CONNECTORS 2.54 mm

MATING PIN Ø 0.47 mm / SINGLE ROW / DOUBLE ROW / SOLDER TAIL

Interconnect socket strips, solder tail.

## TECHNICAL SPECIFICATIONS (FOR GENERAL SPECS, SEE PAGE 43)

<b>INSULATOR</b>	Black glass filled polyester PCT-GF30-FR
<b>FLAMMABILITY</b>	UL 94V-0
<b>SLEEVE</b>	Brass CuZn36Pb3 (C36000)
<b>CONTACT CLIP (4 FINGER)</b>	Beryllium copper (C17200)
<b>MATING PIN Ø</b>	0.40 to 0.56 mm
<b>FORCES</b>	2 N typ. insertion      1 N typ. withdrawal (polished steel gauge Ø 0.43 mm)
<b>MECHANICAL LIFE</b>	Min. 500 cycles
<b>RATED CURRENT</b>	3 A
<b>CONTACT RESISTANCE</b>	Max. 10 mΩ
<b>DIELECTRIC STRENGTH</b>	Min. 1'000 V <sub>RMS</sub>

For corresponding pin connectors, see pages 101-108.

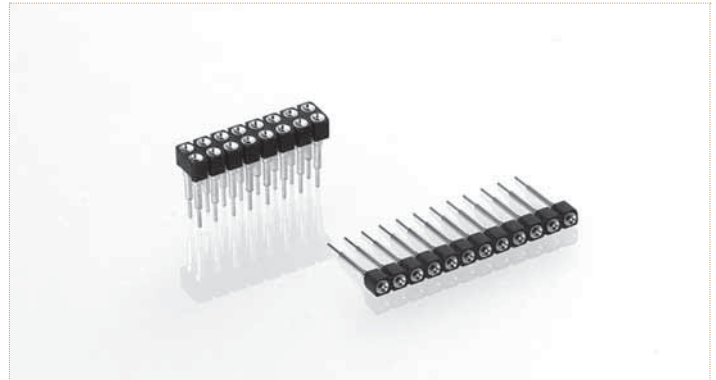

## ORDERING INFORMATION ROHS COMPLIANT PARTS

PP PLATING CODE	SLEEVE	CLIP
87	Tin	Flash gold
83	Tin	0.75 µm gold

Other plating on request (see page 178 for plating specs).

**NN number of poles.** Replace **NN** with the requested number of poles, e.g. 416-83-2**NN**-41-007101 for a double row version with 16 pins becomes 416-83-2**16**-41-007101.

### 316-PP-1NN-41-XXX101

Interconnect socket strip, solder tail, single row

**AVAILABILITY FROM** 2 to 64 contacts  
(standard number of contacts: 64)

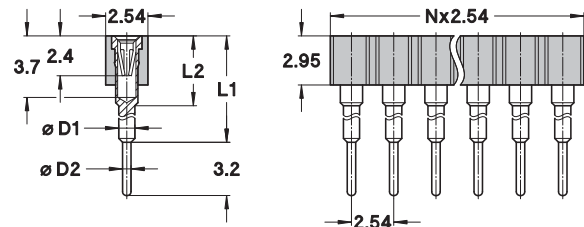

### 416-PP-2NN-41-XXX101

Interconnect socket strip, solder tail, double row

**AVAILABILITY FROM** 4 to 72 contacts  
(standard number of contacts: 72)

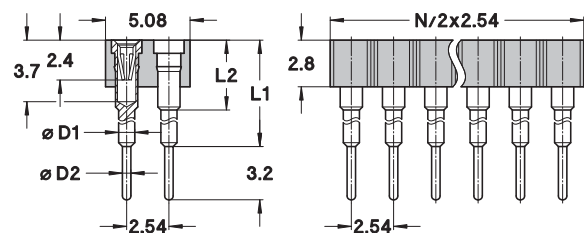

## AVAILABLE CONTACT LENGTHS

CONTACT LENGTH		CONTACT DIAMETER		XXX CODE
L1 (mm)	L2 (mm)	D1 (mm)	D2 (mm)	
6	4.2	1	0.51	006
7	4.2	1	0.51	018
8	4.2	1	0.51	003
9	4.85	1	0.46	012
10	4.2	1	0.51	007
11	4.2	0.85	0.51	002
12	4.2	1	0.51	008
13	4.2	1	0.51	009
15	4.2	1	0.51	001
18	4.2	1	0.51	011
22	4.2	1	0.51	004
33	4.2	1.18	0.51	013



preci-dip

WWW.PRECIDIP.COM TEL +41 32 421 04 00 SALES@PRECIDIP.COM

# SOCKET CONNECTORS 2.54 mm

MATING PIN Ø 0.47 mm / SINGLE ROW / DOUBLE ROW / TRIPLE ROW  
SOLDER TAIL

Socket connectors, solder tail.

## TECHNICAL SPECIFICATIONS (FOR GENERAL SPECS, SEE PAGE 43)

INSULATOR	Black glass filled polyester PCT-GF30-FR
FLAMMABILITY	UL 94V-0
SLEEVE	Brass CuZn36Pb3 (C36000)
CONTACT CLIP (4 FINGER)	Beryllium copper (C17200)
MATING PIN Ø	0.40 to 0.56 mm
FORCES	2 N typ. insertion      1 N typ. withdrawal (polished steel gauge Ø 0.43 mm)
MECHANICAL LIFE	Min. 500 cycles
RATED CURRENT	3 A
CONTACT RESISTANCE	Max. 10 mΩ
DIELECTRIC STRENGTH	Min. 1'000 V <sub>RMS</sub>

For corresponding pin connectors, see pages 101-108.

## ORDERING INFORMATION ROHS COMPLIANT PARTS

PP PLATING CODE	SLEEVE	CLIP
87	Tin	Flash gold
83	Tin	0.75 µm gold

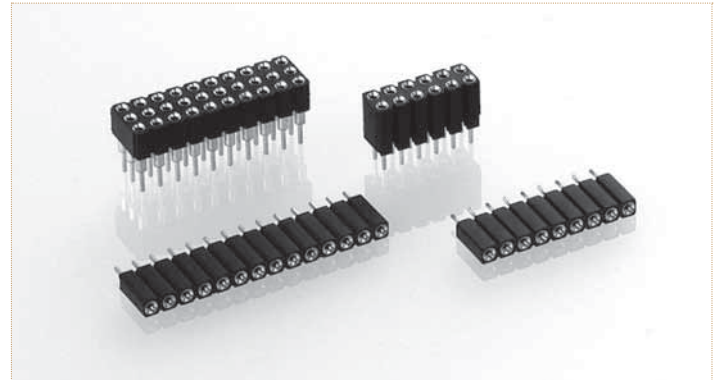

Other plating on request (see page 178 for plating specs).

**NNN number of poles.** Replace **NNN** with the requested number of poles, e.g. 803-83-**NNN**-10-132101 for a double row version with 16 pins becomes 803-83-**016**-10-132101.

### 801-PP-NNN-10-132101

Straight socket connector height 7 mm, solder tail, single row

AVAILABILITY FROM 2 to 50 contacts  
(standard number of contacts: 50)

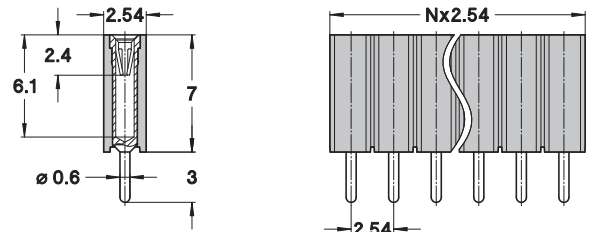

### 803-PP-NNN-10-132101

Straight socket connector height 7 mm, solder tail, double row

AVAILABILITY FROM 4 to 100 contacts  
(standard number of contacts: 100)

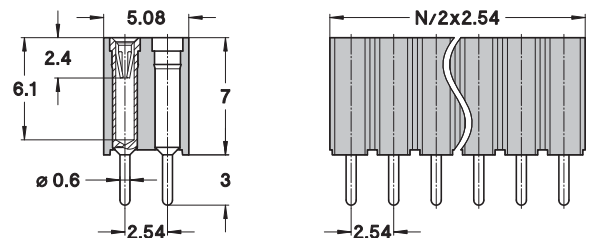

### 805-PP-NNN-10-132101

Straight socket connector height 7 mm, solder tail, triple row

AVAILABILITY FROM 9 to 96 contacts  
(standard number of contacts: 96)

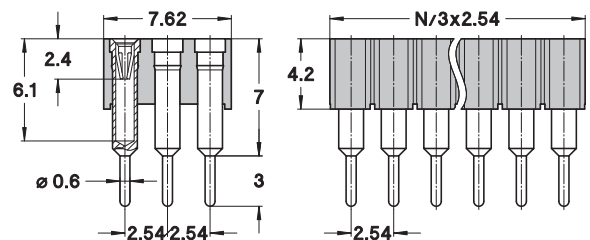

### 801-PP-NNN-10-173101

Straight socket connector height 7 mm, with clinched (right/left) solder tails, single row

AVAILABILITY FROM 3 to 50 contacts  
(standard number of contacts: 50)

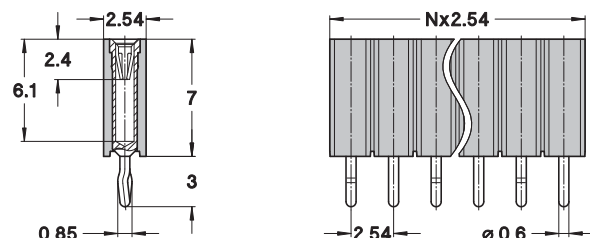



preci-dip

WWW.PRECIDIP.COM TEL +41 32 421 04 00 SALES@PRECIDIP.COM

# SOCKET CONNECTORS 2.54 mm

MATING PIN Ø 0.47 mm / SINGLE ROW / DOUBLE ROW / SOLDER TAIL / RIGHT ANGLE

Right angle socket connectors, solder tail.

## TECHNICAL SPECIFICATIONS (FOR GENERAL SPECS, SEE PAGE 43)

INSULATOR	Black glass filled polyester PCT-GF30-FR
FLAMMABILITY	UL 94V-0
SLEEVE	Brass CuZn36Pb3 (C36000)
CONTACT CLIP (4 FINGER)	Beryllium copper (C17200)
MATING PIN Ø	0.40 to 0.56 mm
FORCES	2 N typ. insertion      1 N typ. withdrawal (polished steel gauge Ø 0.43 mm)
MECHANICAL LIFE	Min. 500 cycles
RATED CURRENT	3 A
CONTACT RESISTANCE	Max. 10 mΩ
DIELECTRIC STRENGTH	Min. 1'000 V <sub>RMS</sub>

## ORDERING INFORMATION ROHS COMPLIANT PARTS

PP PLATING CODE	SLEEVE	CLIP
87	Tin	Flash gold
83	Tin	0.75 µm gold

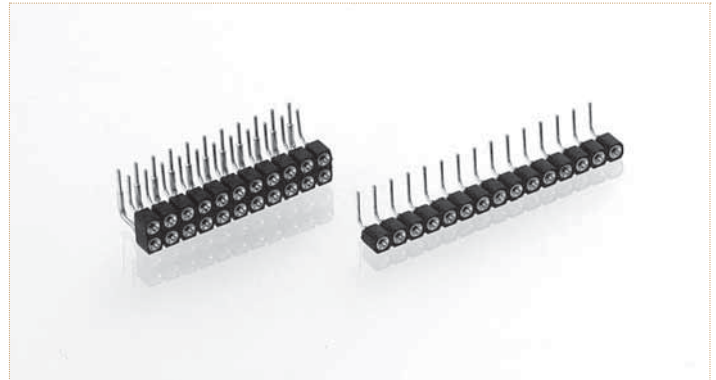

Other plating on request (see page 178 for plating specs).

**NN number of poles.** Replace **NN** with the requested number of poles, e.g. 499-83-2**NN**-10-003101 for a double row version with 16 pins becomes 499-83-**216**-10-003101.

### 399-PP-1NN-10-003101

Right angle socket connector, single row

AVAILABILITY FROM 2 to 64 contacts  
(standard number of contacts: 64)

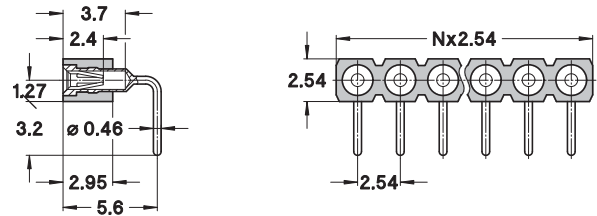

### 499-PP-2NN-10-003101

Right angle socket connector, double row

AVAILABILITY FROM 4 to 72 contacts  
(standard number of contacts 72):

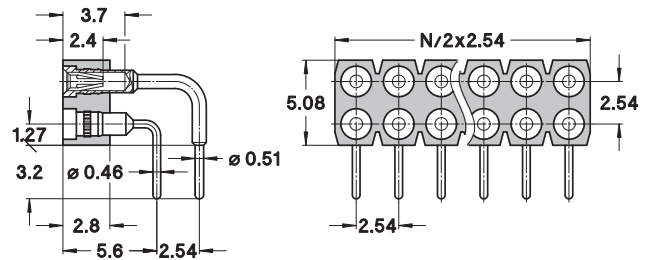





preci-dip

WWW.PRECIDIP.COM TEL +41 32 421 04 00 SALES@PRECIDIP.COM

# SOCKET CONNECTORS 2.54 mm

MATING PIN Ø 0.47 mm / SINGLE ROW / DOUBLE ROW / SURFACE MOUNT

Socket connectors, SMD perpendicular mount.

## TECHNICAL SPECIFICATIONS (FOR GENERAL SPECS, SEE PAGE 43)

<b>INSULATOR</b>	Black glass filled polyester PCT-GF30-FR
<b>FLAMMABILITY</b>	UL 94V-0
<b>SLEEVE</b>	Brass CuZn36Pb3 (C36000)
<b>CONTACT CLIP (4 FINGER)</b>	Beryllium copper (C17200)
<b>MATING PIN Ø</b>	0.40 to 0.56 mm
<b>FORCES</b>	2 N typ. insertion 1 N typ. withdrawal (polished steel gauge Ø 0.43 mm)
<b>MECHANICAL LIFE</b>	Min. 500 cycles
<b>RATED CURRENT</b>	3 A
<b>CONTACT RESISTANCE</b>	Max. 10 mΩ
<b>DIELECTRIC STRENGTH</b>	Min. 1'000 V <sub>RMS</sub>
<b>COPLANARITY</b>	
<b>SMD TERMINATIONS</b>	Max. 0.1 mm (measured on 25 mm long connectors)

For corresponding pin connectors, see pages 101-108.

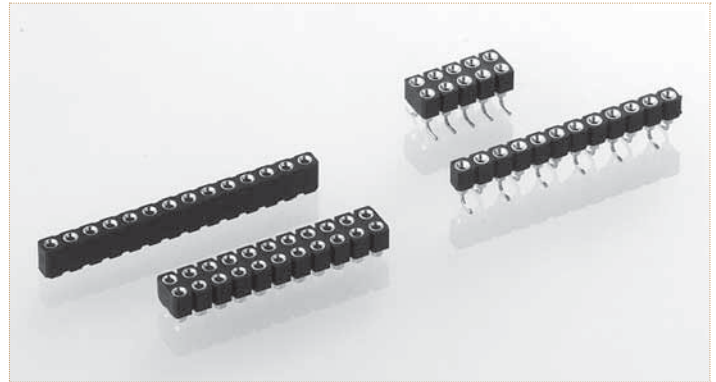

Other plating on request (see page 178 for plating specs).

**NN number of poles.** Replace NN with the requested number of poles, e.g. 410-87-2NN-41-105101 for a double row version with 16 pins becomes 410-87-216-41-105101.

## ORDERING INFORMATION ROHS COMPLIANT PARTS

PP PLATING CODE	SLEEVE	CLIP
87	Tin	Flash gold
83	Tin	0.75 µm gold

**Bulk:** 314-PP-1NN-01-899101 **T & R Packaging\*:** 314-PP-1NN-01-899191

SMD socket connector, low profile, single row, perpendicular mount with self-levelling floating contacts

**AVAILABILITY FROM** 2 to 12 contacts  
(standard number of contacts: 12)  
For connectors having more than 9 contacts, the coplanarity issue is to be addressed specifically

\*Please consult [www.precidip.com](http://www.precidip.com) for availability size of tape, size of reel, number of components per reel and packing units.

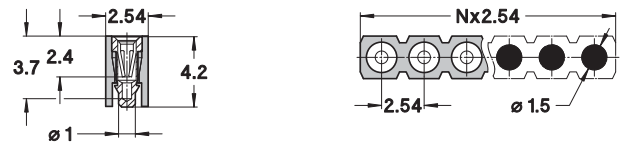

**Bulk:** 414-PP-2NN-41-134101 **T & R Packaging\*:** 414-PP-2NN-41-134191

SMD socket connector, low profile, double row, perpendicular mount with self-levelling floating contacts

**AVAILABILITY FROM** 4 to 64 contacts  
(standard number of contacts: 64)  
For connectors having more than 9 contacts per row, the coplanarity issue is to be addressed specifically

\*Please consult [www.precidip.com](http://www.precidip.com) for availability size of tape, size of reel, number of components per reel and packing units.

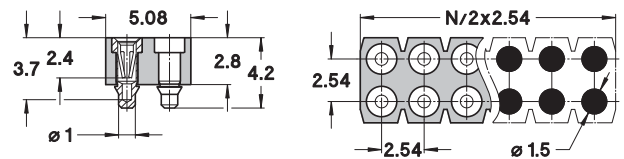

**Bulk:** 310-PP-1NN-41-105101 **T & R Packaging with pick & place cap\*:** 310-PP-1NN-41-105191

SMD socket connector, single row, perpendicular mount with gull-wing terminations

**AVAILABILITY FROM** 3 to 64 contacts  
(standard number of contacts: 64)  
For connectors having more than 9 contacts, the coplanarity issue is to be addressed specifically

\*Please consult [www.precidip.com](http://www.precidip.com) for availability size of tape, size of reel, number of components per reel and packing units.

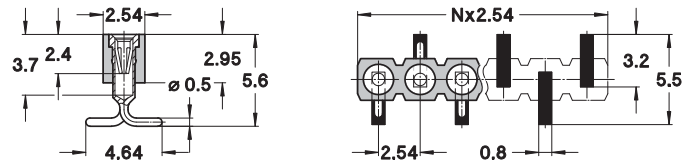

**Bulk:** 410-PP-2NN-41-105101 **T & R Packaging with pick & place cap\*:** 410-PP-2NN-41-105191

SMD socket connector, double row, perpendicular mount with gull-wing terminations

**AVAILABILITY FROM** 4 to 72 contacts  
(standard number of contacts: 72)  
For connectors having more than 9 contacts per row, the coplanarity issue is to be addressed specifically

\*Please consult [www.precidip.com](http://www.precidip.com) for availability size of tape, size of reel, number of components per reel and packing units.

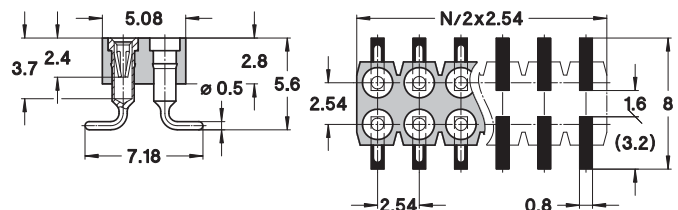



preci-dip

WWW.PRECIDIP.COM TEL +41 32 421 04 00 SALES@PRECIDIP.COM

# SOCKET CONNECTORS 2.54 mm

MATING PIN Ø 0.47 mm / SINGLE ROW / SURFACE MOUNT

Socket connectors, SMD parallel mount.

## TECHNICAL SPECIFICATIONS (FOR GENERAL SPECS, SEE PAGE 43)

INSULATOR	Black glass filled polyester PCT-GF30-FR
FLAMMABILITY	UL 94V-0
SLEEVE	Brass CuZn36Pb3 (C36000)
CONTACT CLIP (4 FINGER)	Beryllium copper (C17200)
MATING PIN Ø	0.40 to 0.56 mm
FORCES	2 N typ. insertion      1 N typ. withdrawal (polished steel gauge Ø 0.43 mm)
MECHANICAL LIFE	Min. 500 cycles
RATED CURRENT	3 A
CONTACT RESISTANCE	Max. 10 mΩ
DIELECTRIC STRENGTH	Min. 1'000 V <sub>RMS</sub>
COPLANARITY SMD TERMINATIONS	Max. 0.1 mm (measured on 25 mm long connectors)

For corresponding pin connectors, see pages 101-108.

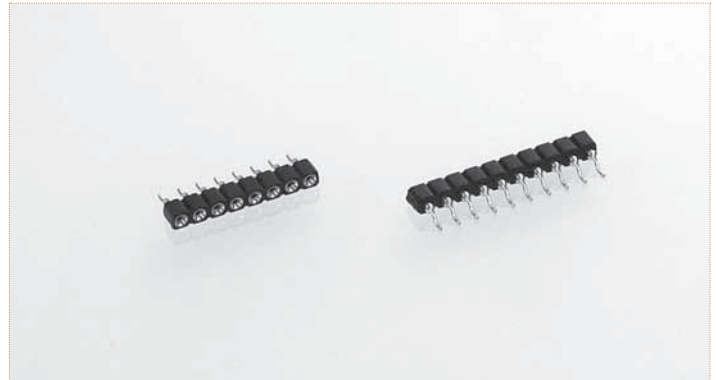

Other plating on request (see page 178 for plating specs).

**NN number of poles.** Replace **NN** with the requested number of poles, e.g. 310-87-**1NN**-41-205101 for a single row version with 8 pins becomes 310-87-**108**-41-205101.

## ORDERING INFORMATION ROHS COMPLIANT PARTS

PP PLATING CODE	SLEEVE	CLIP
87	Tin	Flash gold
83	Tin	0.75 µm gold

**Bulk:** 310-PP-1NN-41-205101      **T & R Packaging\*:** 310-PP-1NN-41-205191

SMD socket connector, single row, parallel mount

**AVAILABILITY FROM** 2 to 64 contacts  
(standard number of contacts: 64)  
For connectors having more than 9 contacts, the coplanarity issue is to be addressed specifically

\*Please consult [www.precidip.com](http://www.precidip.com) for availability size of tape, size of reel, number of components per reel and packing units.

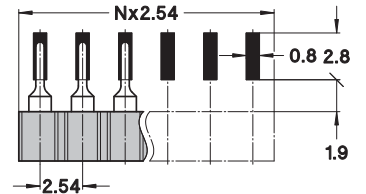
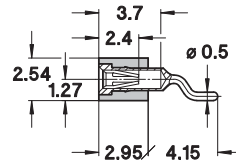



preci-dip

WWW.PRECIDIP.COM TEL +41 32 421 04 00 SALES@PRECIDIP.COM

# SOCKET CONNECTORS 2.54 mm

MATING PIN Ø 0.47 mm / SINGLE ROW / DOUBLE ROW / PRESS-FIT

Socket connectors, press-fit with compliant pin for solderless mount in PCB plated through holes.

## TECHNICAL SPECIFICATIONS (FOR GENERAL SPECS, SEE PAGE 43)

<b>INSULATOR</b>	Black glass filled polyester PCT-GF30-FR
<b>FLAMMABILITY</b>	UL 94V-0
<b>SLEEVE</b>	Bronze CuSn4Pb4Zn4 (C54400)
<b>CONTACT CLIP (4 FINGER)</b>	Beryllium copper (C17200)
<b>MATING PIN Ø</b>	0.40 to 0.56 mm
<b>FORCES</b>	2 N typ. insertion      1 N typ. withdrawal (polished steel gauge Ø 0.43 mm)
<b>MECHANICAL LIFE</b>	Min. 500 cycles
<b>RATED CURRENT</b>	3 A
<b>CONTACT RESISTANCE</b>	Max. 10 mΩ
<b>DIELECTRIC STRENGTH</b>	Min. 1'000 V <sub>RMS</sub>
<b>PCB HOLE Ø</b>	1 mm +0.09/-0.06 mm finished (1.15 ±0.025 mm drill)

For corresponding pin connectors, see pages 101-108.

## ORDERING INFORMATION ROHS COMPLIANT PARTS

PP PLATING CODE	SLEEVE	CLIP
87	Tin	Flash gold
83	Tin	0.75 µm gold

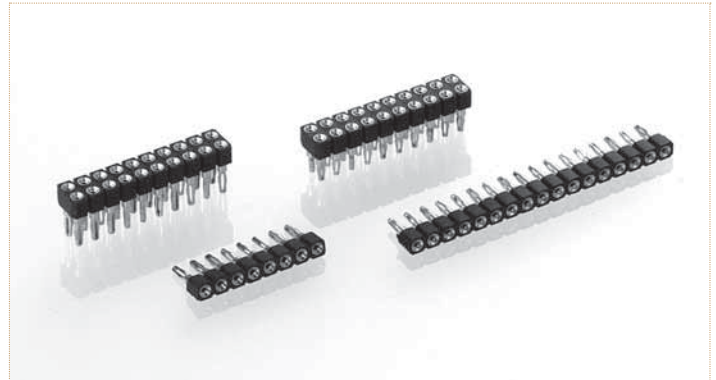

Other plating on request (see page 178 for plating specs).

**NN number of poles.** Replace NN with the requested number of poles, e.g. 346-83-1NN-41-036101 for a single row version with 8 pins becomes 346-83-108-41-036101.

### 346-PP-1NN-41-036101

Press-fit socket connector, single row, compliant pin for PCB thickness 1.5 to 2.5 mm

**AVAILABILITY FROM** 2 to 64 contacts  
(standard number of contacts: 64)

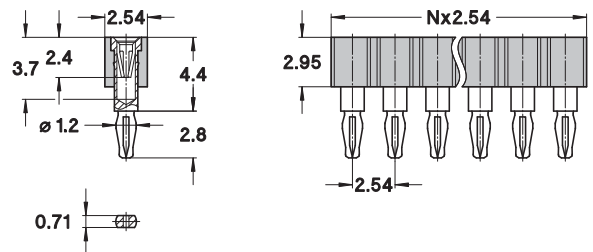

### 446-PP-2NN-41-036101

Press-fit socket connector, double row, compliant pin for PCB thickness 1.5 to 2.5 mm

**AVAILABILITY FROM** 4 to 72 contacts  
(standard number of contacts: 72)

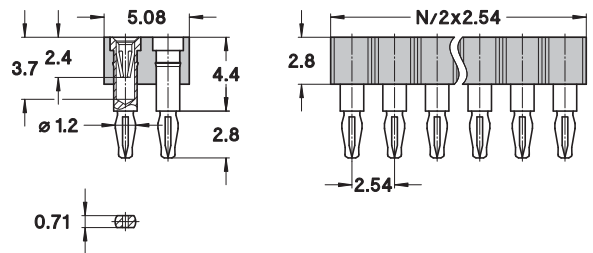

### 346-PP-1NN-41-035101

Press-fit socket connector, single row, compliant pin for PCB thickness 2.1 to 3.2 mm

**AVAILABILITY FROM** 2 to 64 contacts  
(standard number of contacts: 64)

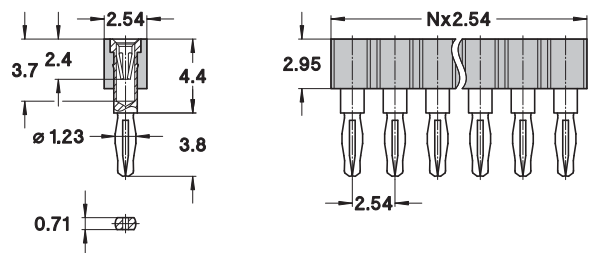

### 446-PP-2NN-41-035101

Press-fit socket connector, double row, compliant pin for PCB thickness 2.1 to 3.2 mm

**AVAILABILITY FROM** 4 to 72 contacts  
(standard number of contacts: 72)

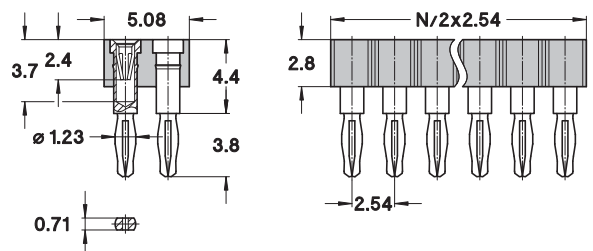



preci-dip

WWW.PRECIDIP.COM TEL +41 32 421 04 00 SALES@PRECIDIP.COM

# SOCKET CONNECTORS 2.54 mm

MATING PIN Ø 0.47 mm / SINGLE ROW / DOUBLE ROW / PRESS-FIT

Socket connectors, press-fit with compliant pin for solderless mount in PCB plated through holes.

## TECHNICAL SPECIFICATIONS (FOR GENERAL SPECS, SEE PAGE 43)

<b>INSULATOR</b>	Black glass filled polyester PCT-GF30-FR
<b>FLAMMABILITY</b>	UL 94V-0
<b>SLEEVE</b>	Bronze CuSn4Pb4Zn4 (C54400)
<b>CONTACT CLIP (4 FINGER)</b>	Beryllium copper (C17200)
<b>MATING PIN Ø</b>	0.40 to 0.56 mm
<b>FORCES</b>	2 N typ. insertion      1 N typ. withdrawal (polished steel gauge Ø 0.43 mm)
<b>MECHANICAL LIFE</b>	Min. 500 cycles
<b>RATED CURRENT</b>	3 A
<b>CONTACT RESISTANCE</b>	Max. 10 mΩ
<b>DIELECTRIC STRENGTH</b>	Min. 1'000 V <sub>RMS</sub>
<b>PCB HOLE Ø</b>	1 mm +0.09/-0.06 mm finished (1.15 ±0.025 mm drill)

For corresponding pin connectors, see pages 101-108.

## ORDERING INFORMATION ROHS COMPLIANT PARTS

PP PLATING CODE	SLEEVE	CLIP
87	Tin	Flash gold
83	Tin	0.75 µm gold

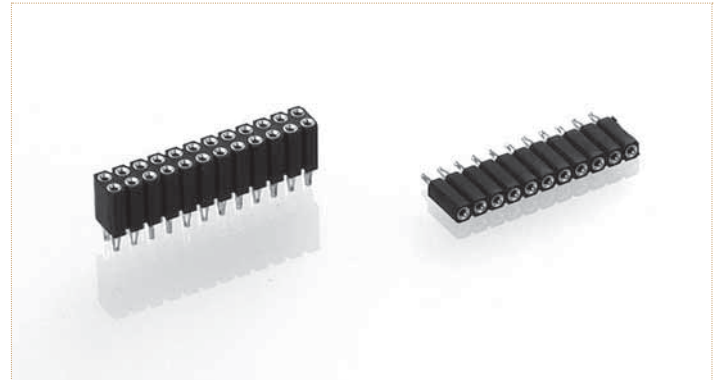

Other plating on request (see page 178 for plating specs).

**NNN number of poles.** Replace **NNN** with the requested number of poles, e.g. 801-87-**NNN**-65-410101 for a single row version with 8 pins becomes 801-87-**008**-65-410101.

### 801-PP-NNN-65-410101

Press-fit socket connector height 7 mm, single row, compliant pin for PCB thickness 1.5 to 2.5 mm

**AVAILABILITY FROM** 2 to 50 contacts  
(standard number of contacts: 50)

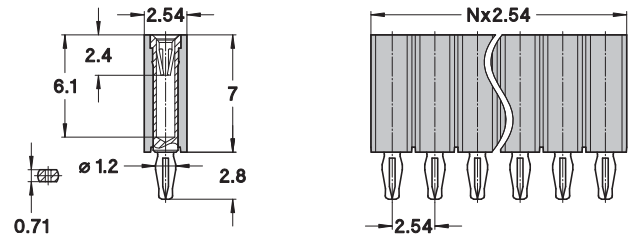

### 803-PP-NNN-65-410101

Press-fit receptacle socket height 7 mm, double row, compliant pin for PCB thickness 1.5 to 2.5 mm

**AVAILABILITY FROM** 4 to 100 contacts  
(standard number of contacts: 100)

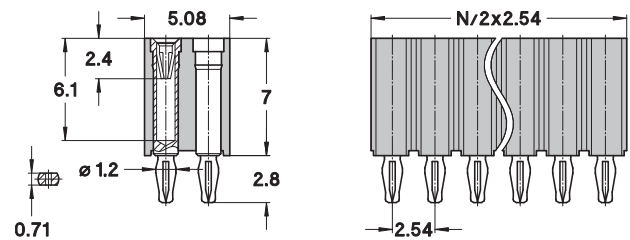



preci-dip

WWW.PRECIDIP.COM TEL +41 32 421 04 00 SALES@PRECIDIP.COM

# SOCKET CONNECTORS 2.54 mm

MATING PIN Ø 0.47 mm / SINGLE ROW / DOUBLE ROW / WIRE-WRAP

Socket connectors with wire-wrap terminations.

## TECHNICAL SPECIFICATIONS (FOR GENERAL SPECS, SEE PAGE 43)

INSULATOR	Black glass filled polyester PCT-GF30-FR
FLAMMABILITY	UL 94V-0
SLEEVE	Brass CuZn36Pb3 (C36000)
CONTACT CLIP (4 FINGER)	Beryllium copper (C17200)
MATING PIN Ø	0.40 to 0.56 mm
FORCES	2 N typ. insertion      1 N typ. withdrawal (polished steel gauge Ø 0.43 mm)
MECHANICAL LIFE	Min. 500 cycles
RATED CURRENT	3 A
CONTACT RESISTANCE	Max. 10 mΩ
DIELECTRIC STRENGTH	Min. 1'000 V <sub>RMS</sub>

For corresponding pin connectors, see pages 101-108.

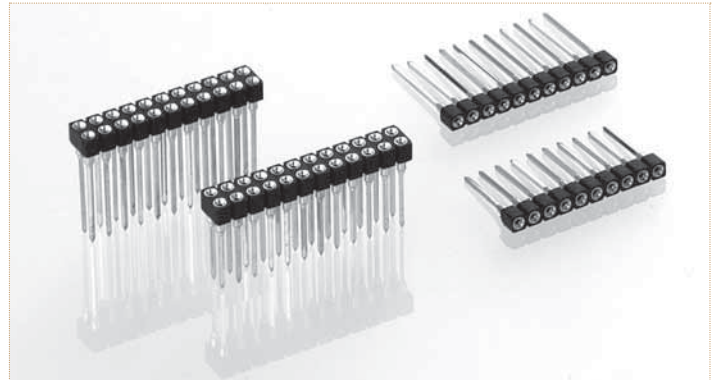

## ORDERING INFORMATION ROHS COMPLIANT PARTS

PP PLATING CODE	SLEEVE	CLIP
87	Tin	Flash gold
83	Tin	0.75 µm gold

Other plating on request (see page 178 for plating specs).

**NN number of poles.** Replace **NN** with the requested number of poles, e.g. 422-83-2**NN**-41-001101 for a double row version with 16 pins becomes 422-83-2**16**-41-001101.

### 322-PP-1NN-41-001101

Wire-wrap socket connector height 4.9 mm, 2-level, single row

AVAILABILITY FROM 2 to 64 contacts  
(standard number of contacts: 64)

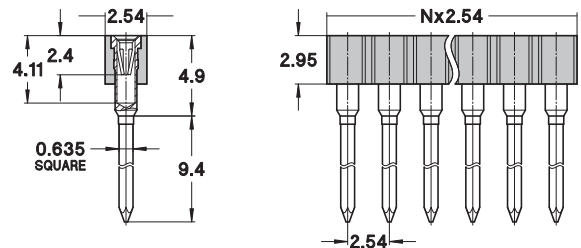

### 422-PP-2NN-41-001101

Wire-wrap socket connector height 4.9 mm, 2-level, double row

AVAILABILITY FROM 4 to 72 contacts  
(standard number of contacts: 72)

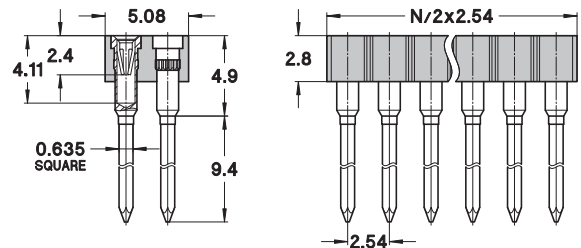

### 323-PP-1NN-41-001101

Wire-wrap socket connector height 4.9 mm, 3-level, single row

AVAILABILITY FROM 2 to 64 contacts  
(standard number of contacts: 64)

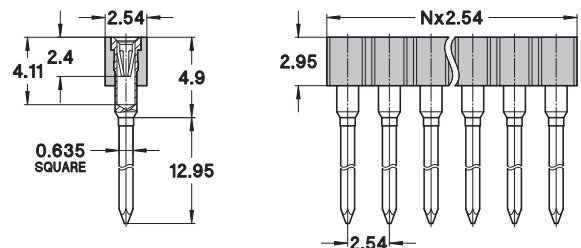

### 423-PP-2NN-41-001101

Wire-wrap socket connector height 4.9 mm, 3-level, double row

AVAILABILITY FROM 4 to 72 contacts  
(standard number of contacts: 72)

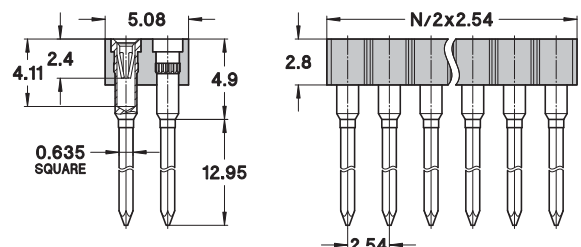





preci-dip

WWW.PRECIDIP.COM TEL +41 32 421 04 00 SALES@PRECIDIP.COM

# SOCKET CONNECTORS 2.54 mm

MATING PIN Ø 0.47 mm / SINGLE ROW / DOUBLE ROW / WIRE-WRAP

Socket connectors with wire-wrap terminations and connecting pin for board stacking.

## TECHNICAL SPECIFICATIONS (FOR GENERAL SPECS, SEE PAGE 43)

INSULATOR	Black glass filled polyester PCT-GF30-FR
FLAMMABILITY	UL 94V-0
SLEEVE	Brass CuZn36Pb3 (C36000)
CONTACT CLIP (4 FINGER)	Beryllium copper (C17200)
MATING PIN Ø	0.40 to 0.56 mm
FORCES	2 N typ. insertion      1 N typ. withdrawal (polished steel gauge Ø 0.43 mm)
MECHANICAL LIFE	Min. 500 cycles
RATED CURRENT	3 A
CONTACT RESISTANCE	Max. 10 mΩ
DIELECTRIC STRENGTH	Min. 1'000 V <sub>RMS</sub>

For corresponding pin connectors, see pages 101-108.

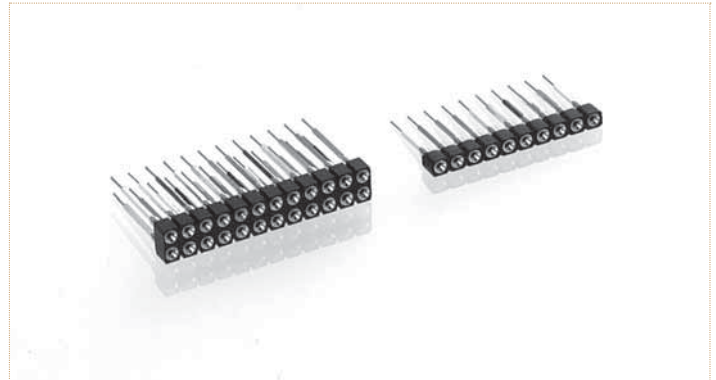

## ORDERING INFORMATION ROHS COMPLIANT PARTS

PP PLATING CODE	SLEEVE	CLIP
83	Tin	0.75 µm gold

Other plating on request (see page 178 for plating specs).

**NN number of poles.** Replace **NN** with the requested number of poles, e.g. 426-83-2**NN**-41-001101 for a double row version with 16 pins becomes 426-83-2**16**-41-001101.

### 326-83-1**NN**-41-**XXX**101

Wire-wrap socket connector with connecting pin, height 4.9 mm, single row

AVAILABILITY FROM 2 to 64 contacts  
(standard number of contacts: 64)

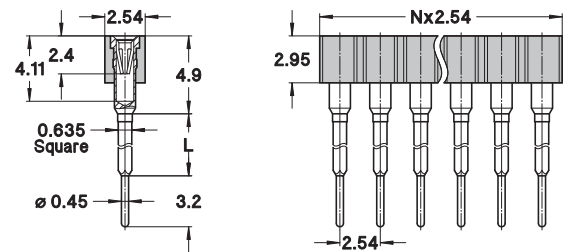

### 426-83-2**NN**-41-**XXX**101

Wire-wrap socket connector with connecting pin, height 4.9 mm, double row

AVAILABILITY FROM 4 to 72 contacts  
(standard number of contacts: 72)

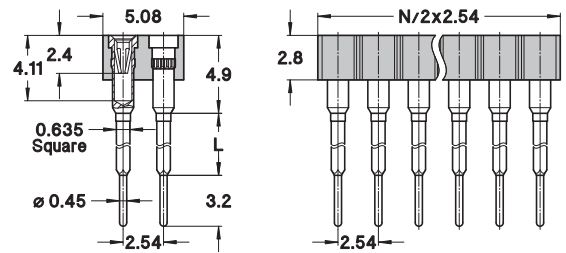

## AVAILABLE CONTACT LENGTHS

CONTACT LENGTH L (mm)	WW-LEVEL	XXX CODE
5.9	1	001
8.9	2	002
11.9	3	003



preci-dip

WWW.PRECIDIP.COM TEL +41 32 421 04 00 SALES@PRECIDIP.COM

# SOCKET CONNECTORS 2.54 mm

MATING PIN Ø 0.47 mm / SINGLE ROW / CARRIER ASSEMBLIES

"Zero profile" socket connectors. Single socket contacts for solder mount into PCB, supplied on disposable carriers.

## TECHNICAL SPECIFICATIONS (FOR GENERAL SPECS, SEE PAGE 43)

<b>INSULATOR</b>	Black glass filled polyester PCT-GF30-FR
<b>FLAMMABILITY</b>	UL 94V-0
<b>SLEEVE</b>	Brass CuZn36Pb3 (C36000)
<b>CONTACT CLIP (4 FINGER)</b>	Beryllium copper (C17200)
<b>MATING PIN Ø</b>	0.40 to 0.56 mm
<b>FORCES</b>	2 N typ. insertion      1 N typ. withdrawal (polished steel gauge Ø 0.43 mm)
<b>MECHANICAL LIFE</b>	Min. 500 cycles
<b>RATED CURRENT</b>	3 A
<b>CONTACT RESISTANCE</b>	Max. 10 mΩ
<b>DIELECTRIC STRENGTH</b>	Min. 1'000 V <sub>RMS</sub>

For corresponding pin connectors, see pages 101-108.



## ORDERING INFORMATION ROHS COMPLIANT PARTS

PP PLATING CODE	SLEEVE	CLIP
87	Tin	Flash gold
83	Tin	0.75 µm gold

Other plating on request (see page 178 for plating specs).

**NN number of poles.** Replace NN with the requested number of poles, e.g. 714-83-1NN-41-001101 for a single row version with 8 pins becomes 714-83-108-41-001101.

### 712-PP-1NN-41-001101

Single row carrier with standard socket contact with solder tail

**AVAILABILITY FROM** 2 to 64 contacts  
(standard number of contacts: 64)

Double row, disposable carrier strips on request

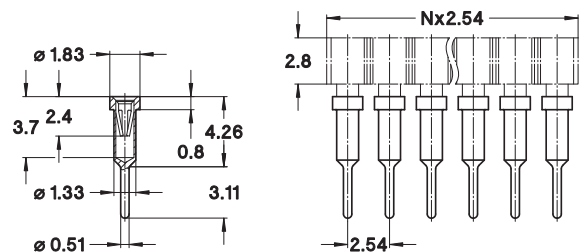

### 714-PP-1NN-41-001101

Single row carrier with low profile contact

for solder mount into PCB hole Ø 1.4-1.8 mm, PCB thickness 1 to 2.6 mm

**AVAILABILITY FROM** 2 to 64 contacts  
(standard number of contacts: 64)

Double row, disposable carrier strips on request

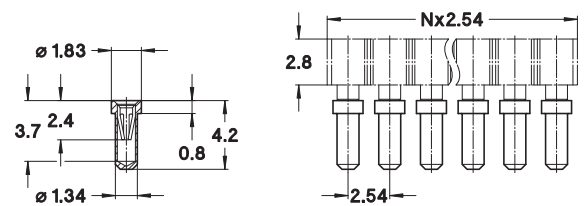

### 714-PP-1NN-41-014101

Single row carrier with low profile contact

for solder mount into PCB hole Ø 1.4-1.8 mm, PCB thickness 1 to 5 mm

**AVAILABILITY FROM** 2 to 64 contacts  
(standard number of contacts: 64)

Double row, disposable carrier strips on request

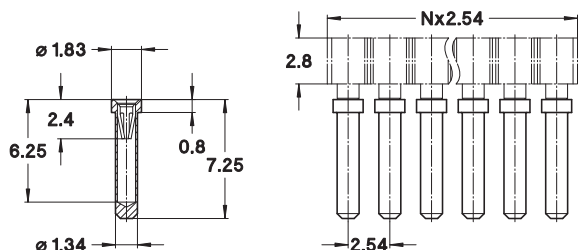



preci-dip

WWW.PRECIDIP.COM TEL +41 32 421 04 00 SALES@PRECIDIP.COM

# SOCKET CONNECTORS 2.54 mm

MATING PIN Ø 0.47 mm / SINGLE ROW / CARRIER ASSEMBLIES

"Zero profile" socket connectors. Single socket contacts for solder and press-fit solderless mount into PCB, supplied on disposable carriers.

## TECHNICAL SPECIFICATIONS (FOR GENERAL SPECS, SEE PAGE 43)

INSULATOR	Black glass filled polyester PCT-GF30-FR
FLAMMABILITY	UL 94V-0
SLEEVE	Brass CuZn36Pb3 (C36000)
CONTACT CLIP (3 FINGER)	Beryllium copper (C17200)
MATING PIN Ø	0.40 to 0.52 mm
FORCES	1 N typ. insertion      0.4 N typ. withdrawal (polished steel gauge Ø 0.43 mm)
MECHANICAL LIFE	Min. 500 cycles
RATED CURRENT	3 A
CONTACT RESISTANCE	Max. 10 mΩ
DIELECTRIC STRENGTH	Min. 1'000 V <sub>RMS</sub>

For corresponding pin connectors, see pages 101-108.

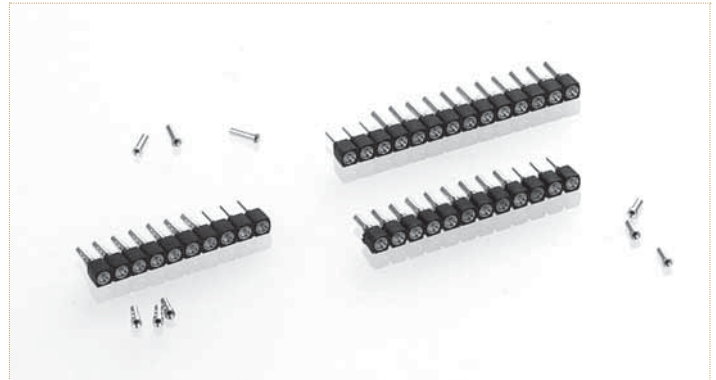

## ORDERING INFORMATION ROHS COMPLIANT PARTS

PP PLATING CODE	SLEEVE	CLIP
87	Tin	Flash gold
83	Tin	0.75 µm gold

Other plating on request (see page 178 for plating specs).

**NN number of poles.** Replace NN with the requested number of poles, e.g. 714-83-1NN-31-018101 for a single row version with 8 pins becomes 714-83-108-31-018101.

### 714-PP-1NN-31-012101

Single row carrier with ultra thin, low profile contact or solder mount into PCB hole Ø 1-1.3 mm, PCB thickness 1 to 2.4 mm

AVAILABILITY FROM 2 to 64 contacts  
(standard number of contacts: 64)

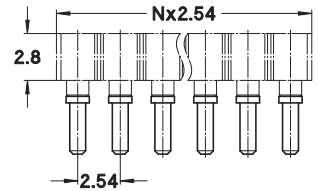
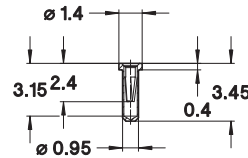

Double row, disposable carrier strips on request

### 714-PP-1NN-31-018101

Single row carrier with ultra thin, low profile contact for solder mount into PCB hole Ø 1-1.3 mm, PCB thickness 1 to 3.4 mm

AVAILABILITY FROM 1 to 64 contacts  
(standard number of contacts: 64)

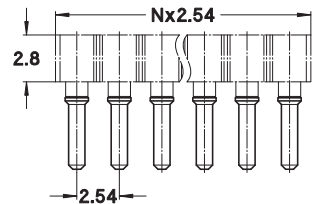
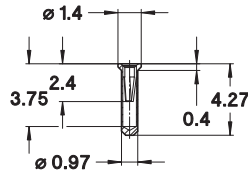

Double row, disposable carrier strips on request

### 714-PP-1NN-31-008101

Single row carrier with contacts for solderless press-fit mount into plated trough PCB hole Ø 1.05 ±0.05 mm finished, PCB thickness 1.5 to 2.5 mm

AVAILABILITY FROM 2 to 64 contacts  
(standard number of contacts: 64)

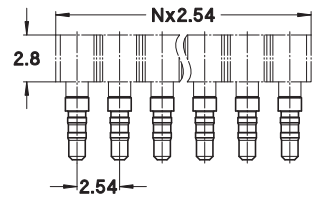
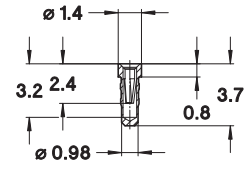

Double row, disposable carrier strips on request



preci-dip

WWW.PRECIDIP.COM TEL +41 32 421 04 00 SALES@PRECIDIP.COM

# SOCKET CONNECTORS 2.54 mm

MATING PIN Ø 0.76 mm / SINGLE ROW / DOUBLE ROW / SOLDER TAIL

Very low profile socket connectors, solder tail.

## TECHNICAL SPECIFICATIONS (FOR GENERAL SPECS, SEE PAGE 43)

<b>INSULATOR</b>	Black glass filled polyester PCT-GF30-FR
<b>FLAMMABILITY</b>	UL 94V-0
<b>SLEEVE</b>	Brass CuZn36Pb3 (C36000)
<b>CONTACT CLIP (6 FINGER)</b>	Beryllium copper (C17200)
<b>MATING PINS</b>	Ø 0.70 to 0.90 mm, $\nabla$ 0.635 mm
<b>FORCES</b>	1.2 N typ. insertion      0.6 N typ. withdrawal (polished steel gauge Ø 0.76 mm)
<b>MECHANICAL LIFE</b>	Min. 500 cycles
<b>RATED CURRENT</b>	3 A
<b>CONTACT RESISTANCE</b>	Max. 10 mΩ
<b>DIELECTRIC STRENGTH</b>	Min. 1'000 V <sub>RMS</sub>

For corresponding pin connectors, see pages 109-119.

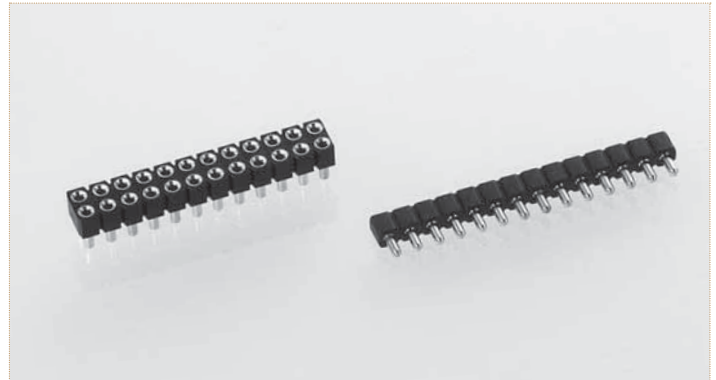

## ORDERING INFORMATION ROHS COMPLIANT PARTS

PP PLATING CODE	SLEEVE	CLIP
87	Tin	Flash gold
83	Tin	0.75 µm gold

Other plating on request (see page 178 for plating specs).

**NNN number of poles.** Replace **NNN** with the requested number of poles, e.g. 803-87-**NNN**-10-268101 for a double row version with 16 pins becomes 803-87-**016**-10-268101.

### 801-PP-NNN-10-268101

Straight socket connector, very low profile, height 2.95 mm, solder tail, single row

**AVAILABILITY FROM** 2 to 64 contacts  
(standard number of contacts: 64)

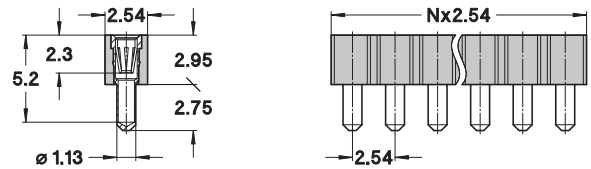

### 803-PP-NNN-10-268101

Straight socket connector, very low profile, height 2.95 mm, solder tail, double row

**AVAILABILITY FROM** 4 to 72 contacts  
(standard number of contacts: 72)

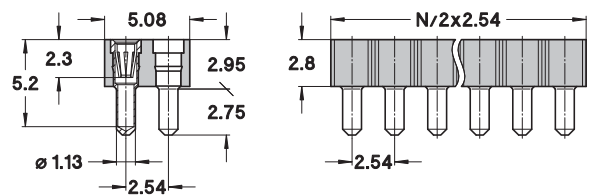



preci-dip

WWW.PRECIDIP.COM TEL +41 32 421 04 00 SALES@PRECIDIP.COM

# SOCKET CONNECTORS 2.54 mm

MATING PIN Ø 0.76 mm / SINGLE ROW / DOUBLE ROW / TRIPLE ROW  
SOLDER TAIL

Very low profile socket connectors, solder tail.

## TECHNICAL SPECIFICATIONS (FOR GENERAL SPECS, SEE PAGE 43)

INSULATOR	Black glass filled polyester PCT-GF30-FR
FLAMMABILITY	UL 94V-0
SLEEVE	Brass CuZn36Pb3 (C36000)
CONTACT CLIP (6 FINGER)	Beryllium copper (C17200)
MATING PINS	Ø 0.70 to 0.90 mm, $\nabla$ 0.635 mm
FORCES	1.2 N typ. insertion      0.6 N typ. withdrawal (polished steel gauge Ø 0.76 mm)
MECHANICAL LIFE	Min. 500 cycles
RATED CURRENT	3 A
CONTACT RESISTANCE	Max. 10 mΩ
DIELECTRIC STRENGTH	Min. 1'000 V <sub>RMS</sub>

For corresponding pin connectors, see pages 109-119.

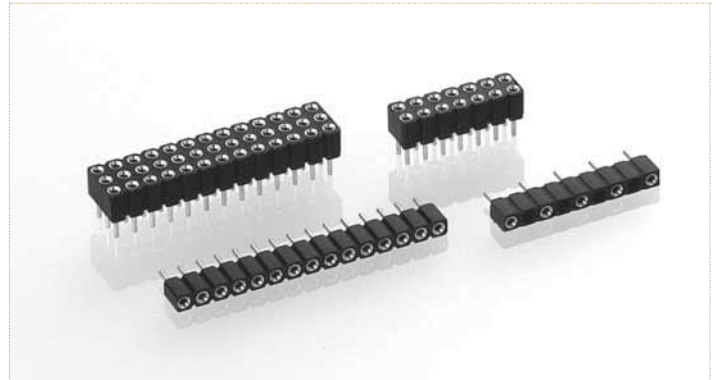

## ORDERING INFORMATION ROHS COMPLIANT PARTS

PP PLATING CODE	SLEEVE	CLIP
87	Tin	Flash gold
83	Tin	0.75 µm gold

Other plating on request (see page 178 for plating specs).

**NNN number of poles.** Replace **NNN** with the requested number of poles, e.g. 803-87-**NNN**-10-012101 for a double row version with 16 pins becomes 803-87-**016**-10-012101.

### 801-PP-NNN-10-012101

Straight socket connector, low profile, height 4.2 mm, solder tail, single row

AVAILABILITY FROM 2 to 32 contacts  
(standard number of contacts: 32)

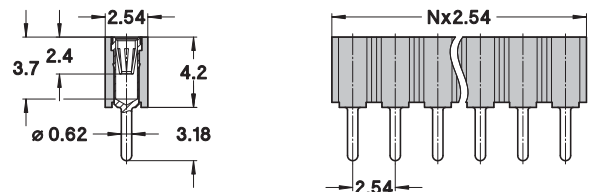

### 803-PP-NNN-10-012101

Straight socket connector, low profile, height 4.2 mm, solder tail, double row

AVAILABILITY FROM 4 to 64 contacts  
(standard number of contacts: 64)

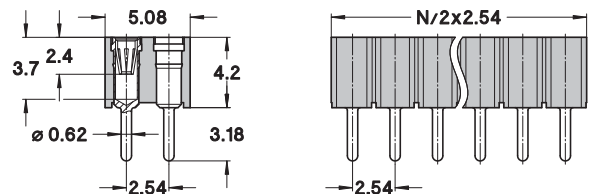

### 805-PP-NNN-10-012101

Straight socket connector, low profile, height 4.2 mm, solder tail, triple row

AVAILABILITY FROM 9 to 96 contacts  
(standard number of contacts: 96)

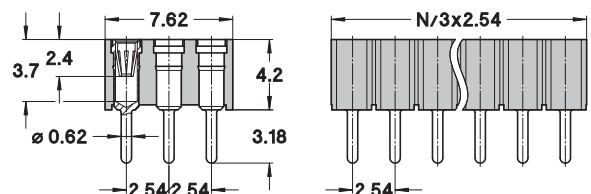

### 801-PP-YYY-10-458101

Straight socket connector, low profile, height 4.2 mm, solder tail, single row, partially equipped 5.08 mm

AVAILABILITY FROM 2 to 16 contacts  
**YYY number of poles:**  
please consult for ordering code

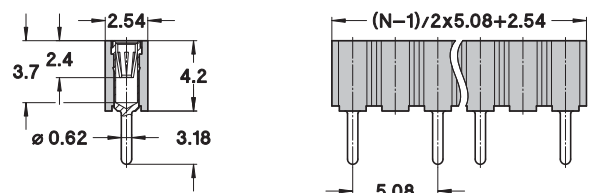





preci-dip

WWW.PRECIDIP.COM TEL +41 32 421 04 00 SALES@PRECIDIP.COM

# SOCKET CONNECTORS 2.54 mm

MATING PIN Ø 0.76 mm / SINGLE ROW / DOUBLE ROW / TRIPLE ROW  
SOLDER TAIL

Socket connectors, solder tail.

## TECHNICAL SPECIFICATIONS (FOR GENERAL SPECS, SEE PAGE 43)

INSULATOR	Black glass filled polyester PCT-GF30-FR
FLAMMABILITY	UL 94V-0
SLEEVE	Brass CuZn36Pb3 (C36000)
CONTACT CLIP (6 FINGER)	Beryllium copper (C17200)
MATING PINS	Ø 0.70 to 0.90 mm, $\nabla$ 0.635 mm
FORCES	1.2 N typ. insertion      0.6 N typ. withdrawal (polished steel gauge Ø 0.76 mm)
MECHANICAL LIFE	Min. 500 cycles
RATED CURRENT	3 A
CONTACT RESISTANCE	Max. 10 mΩ
DIELECTRIC STRENGTH	Min. 1'000 V <sub>RMS</sub>

For corresponding pin connectors, see pages 109-119.

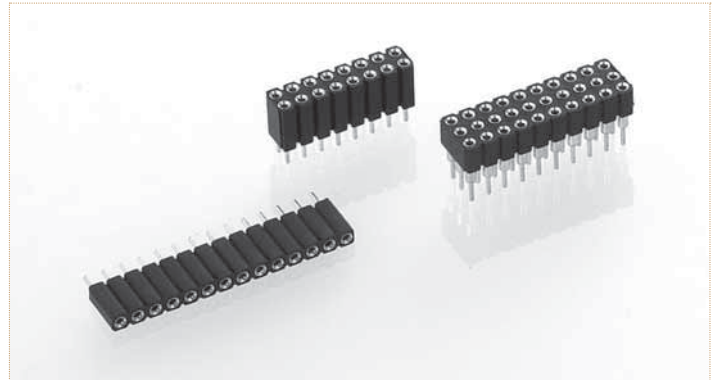

## ORDERING INFORMATION ROHS COMPLIANT PARTS

PP PLATING CODE	SLEEVE	CLIP
87	Tin	Flash gold
83	Tin	0.75 µm gold

Other plating on request (see page 178 for plating specs).

**NNN number of poles.** Replace **NNN** with the requested number of poles, e.g. 803-87-**NNN**-10-001101 for a double row version with 16 pins becomes 803-87-**016**-10-001101.

### 801-PP-NNN-10-001101

Straight socket connector, height 7 mm, solder tail, single row

AVAILABILITY FROM 2 to 50 contacts  
(standard number of contacts: 50)

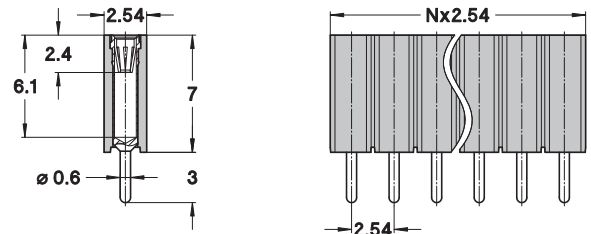

**Bulk:** T & R Packaging\*:

803-PP-NNN-10-001101 803-PP-NNN-10-001191

Straight socket connector, height 7 mm, solder tail, double row

AVAILABILITY FROM 4 to 100 contacts  
(standard number of contacts: 100)

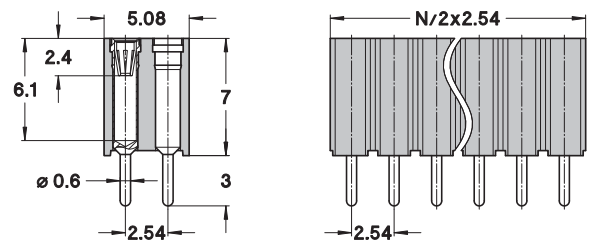

\*Please consult [www.precidip.com](http://www.precidip.com) for availability size of tape, size of reel, number of components per reel and packing units.

### 805-PP-NNN-10-001101

Straight socket connector, height 6.9 mm, solder tail, triple row

AVAILABILITY FROM 9 to 96 contacts  
(standard number of contacts: 96)

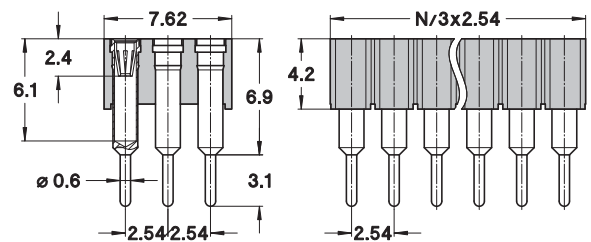



preci-dip

WWW.PRECIDIP.COM TEL +41 32 421 04 00 SALES@PRECIDIP.COM

# SOCKET CONNECTORS 2.54 mm

MATING PIN Ø 0.76 mm / SINGLE ROW / SOLDER TAIL

Socket connectors, solder tail.

## TECHNICAL SPECIFICATIONS (FOR GENERAL SPECS, SEE PAGE 43)

<b>INSULATOR</b>	Black glass filled polyester PCT-GF30-FR
<b>FLAMMABILITY</b>	UL 94V-0
<b>SLEEVE</b>	Brass CuZn36Pb3 (C36000)
<b>CONTACT CLIP (6 FINGER)</b>	Beryllium copper (C17200)
<b>MATING PINS</b>	Ø 0.70 to 0.90 mm, $\nabla$ 0.635 mm
<b>FORCES</b>	1.2 N typ. insertion      0.6 N typ. withdrawal (polished steel gauge Ø 0.76 mm)
<b>MECHANICAL LIFE</b>	Min. 500 cycles
<b>RATED CURRENT</b>	3 A
<b>CONTACT RESISTANCE</b>	Max. 10 mΩ
<b>DIELECTRIC STRENGTH</b>	Min. 1'000 V <sub>RMS</sub>

For corresponding pin connectors, see pages 109-119.

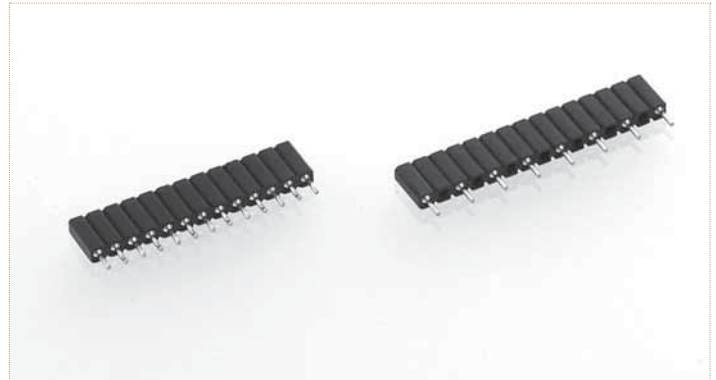

## ORDERING INFORMATION ROHS COMPLIANT PARTS

PP PLATING CODE	SLEEVE	CLIP
87	Tin	Flash gold
83	Tin	0.75 µm gold

Other plating on request (see page 178 for plating specs).

**NNN number of poles.** Replace **NNN** with the requested number of poles, e.g. 801-87-**NNN**-10-143101 for a single row version with 16 pins becomes 801-87-**016**-10-143101.

### 801-PP-YYY-10-101101

Straight socket connector, height 7 mm, solder tail, single row, partially equipped 5.08 mm

**AVAILABILITY FROM** 2 to 25 contacts

**YYY number of poles:**

please consult for ordering code

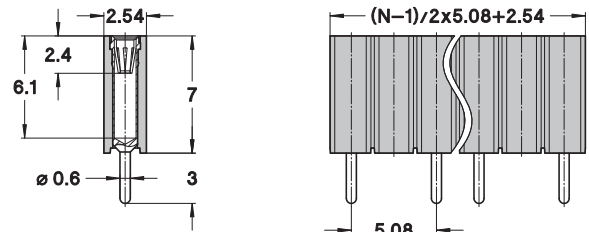

### 801-PP-NNN-10-143101

Straight socket connector, height 7 mm with clinched (right/left) solder tail, single row

**AVAILABILITY FROM** 3 to 50 contacts

(standard number of contacts: 50)

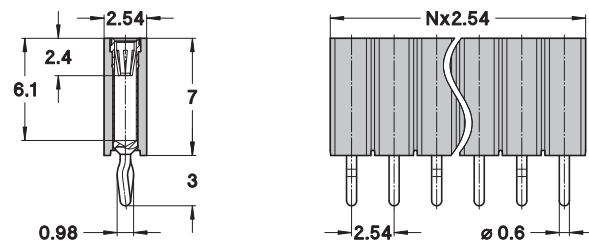



preci-dip

WWW.PRECIDIP.COM TEL +41 32 421 04 00 SALES@PRECIDIP.COM

# SOCKET CONNECTORS 2.54 mm

MATING PIN Ø 0.76 mm / SINGLE ROW / DOUBLE ROW / TRIPLE ROW  
SOLDER TAIL

Socket connectors, solder tail.

## TECHNICAL SPECIFICATIONS (FOR GENERAL SPECS, SEE PAGE 43)

INSULATOR	Black glass filled polyester PCT-GF30-FR
FLAMMABILITY	UL 94V-0
SLEEVE	Brass CuZn36Pb3 (C36000)
CONTACT CLIP (6 FINGER)	Beryllium copper (C17200)
MATING PINS	Ø 0.70 to 0.90 mm, $\nabla$ 0.635 mm
FORCES	1.2 N typ. insertion      0.6 N typ. withdrawal (polished steel gauge Ø 0.76 mm)
MECHANICAL LIFE	Min. 500 cycles
RATED CURRENT	3 A
CONTACT RESISTANCE	Max. 10 mΩ
DIELECTRIC STRENGTH	Min. 1'000 V <sub>RMS</sub>

For corresponding pin connectors, see pages 109-119.

## ORDERING INFORMATION ROHS COMPLIANT PARTS

PP PLATING CODE	SLEEVE	CLIP
87	Tin	Flash gold
83	Tin	0.75 µm gold

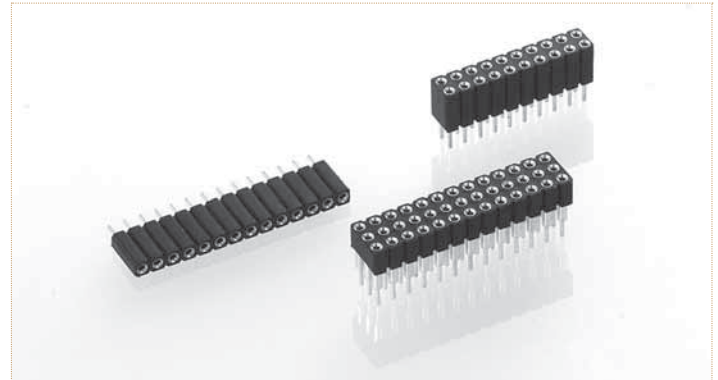

Other plating on request (see page 178 for plating specs).

**NNN number of poles.** Replace **NNN** with the requested number of poles, e.g. 803-87-**NNN**-10-003101 for a double row version with 16 pins becomes 803-87-**016**-10-003101.

### 801-PP-NNN-10-003101

Straight socket connector, height 8 mm, solder tail, single row

AVAILABILITY FROM 2 to 36 contacts  
(standard number of contacts: 36)

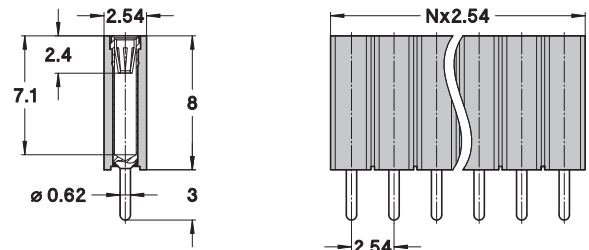

### 803-PP-NNN-10-003101

Straight socket connector, height 7.9 mm, solder tail, double row

AVAILABILITY FROM 4 to 100 contacts  
(standard number of contacts: 100)

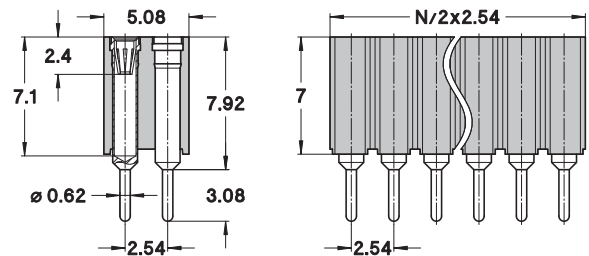

### 805-PP-NNN-10-003101

Straight socket connector, height 7.9 mm, solder tail, triple row

AVAILABILITY FROM 9 to 96 contacts  
(standard number of contacts: 96)

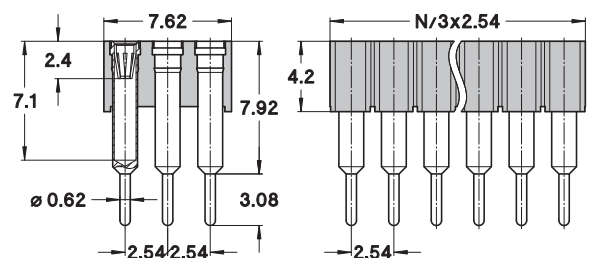



precidip

WWW.PRECIDIP.COM TEL +41 32 421 04 00 SALES@PRECIDIP.COM

# SOCKET CONNECTORS 2.54 mm

MATING PIN Ø 0.76 mm / SINGLE ROW / DOUBLE ROW / TRIPLE ROW  
SOLDER TAIL

Socket connectors, solder tail.

## TECHNICAL SPECIFICATIONS (FOR GENERAL SPECS, SEE PAGE 43)

INSULATOR	Black glass filled polyester PCT-GF30-FR
FLAMMABILITY	UL 94V-0
SLEEVE	Brass CuZn36Pb3 (C36000)
CONTACT CLIP (6 FINGER)	Beryllium copper (C17200)
MATING PINS	Ø 0.70 to 0.90 mm, $\nabla$ 0.635 mm
FORCES	1.2 N typ. insertion      0.6 N typ. withdrawal (polished steel gauge Ø 0.76 mm)
MECHANICAL LIFE	Min. 500 cycles
RATED CURRENT	3 A
CONTACT RESISTANCE	Max. 10 mΩ
DIELECTRIC STRENGTH	Min. 1'000 V <sub>RMS</sub>

For corresponding pin connectors, see pages 109-119.

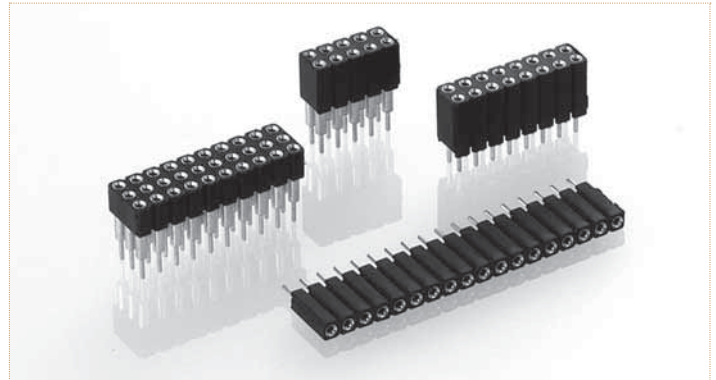

## ORDERING INFORMATION ROHS COMPLIANT PARTS

PP PLATING CODE	SLEEVE	CLIP
87	Tin	Flash gold
83	Tin	0.75 µm gold

Other plating on request (see page 178 for plating specs).

**NNN number of poles.** Replace **NNN** with the requested number of poles, e.g. 803-87-**NNN**-10-005101 for a double row version with 16 pins becomes 803-87-**016**-10-005101.

### 801-PP-NNN-10-005101

Straight socket connector, height 8.5 mm, solder tail, single row

AVAILABILITY FROM 2 to 36 contacts  
(standard number of contacts: 36)

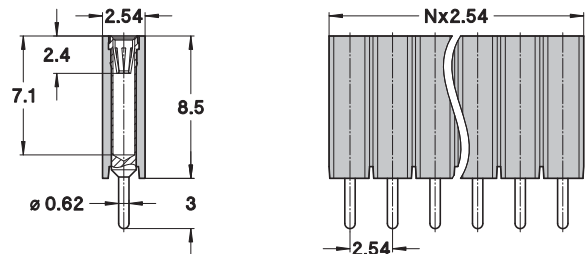

### 803-PP-NNN-10-005101

Straight socket connector, height 8.5 mm, solder tail, double row

AVAILABILITY FROM 4 to 100 contacts  
(standard number of contacts: 100)

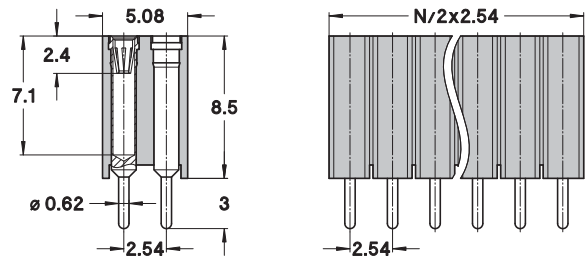

### 805-PP-NNN-10-005101

Straight socket connector, height 8.4 mm, solder tail, triple row

AVAILABILITY FROM 9 to 96 contacts  
(standard number of contacts: 96)

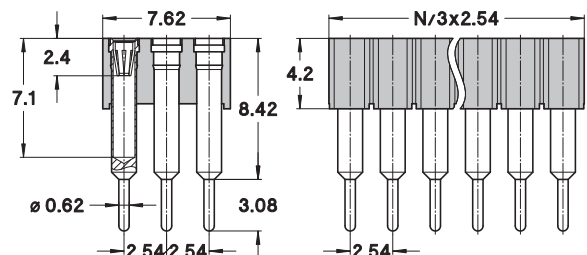

### 803-PP-NNN-10-269101

Straight socket connector, height 11 mm, solder tail, double row

AVAILABILITY FROM 4 to 100 contacts  
(standard number of contacts: 100)

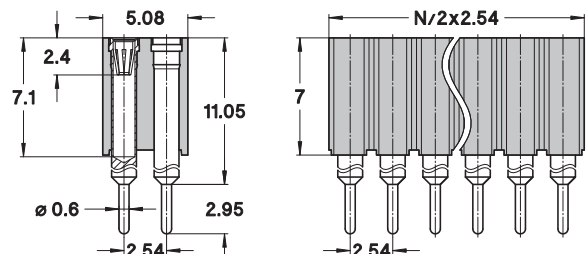



preci-dip

WWW.PRECIDIP.COM TEL +41 32 421 04 00 SALES@PRECIDIP.COM

# SOCKET CONNECTORS 2.54 mm

MATING PIN Ø 0.76 mm / SINGLE ROW / DOUBLE ROW / SOLDER TAIL

Socket connectors, solder tail.

## TECHNICAL SPECIFICATIONS (FOR GENERAL SPECS, SEE PAGE 43)

INSULATOR	Black glass filled polyester PCT-GF30-FR
FLAMMABILITY	UL 94V-0
SLEEVE	Brass CuZn36Pb3 (C36000)
CONTACT CLIP (6 FINGER)	Beryllium copper (C17200)
MATING PINS	Ø 0.70 to 0.90 mm, $\nabla$ 0.635 mm
FORCES	1.2 N typ. insertion      0.6 N typ. withdrawal (polished steel gauge Ø 0.76 mm)
MECHANICAL LIFE	Min. 500 cycles
RATED CURRENT	3 A
CONTACT RESISTANCE	Max. 10 mΩ
DIELECTRIC STRENGTH	Min. 1'000 V <sub>RMS</sub>

For corresponding pin connectors, see pages 109-119.

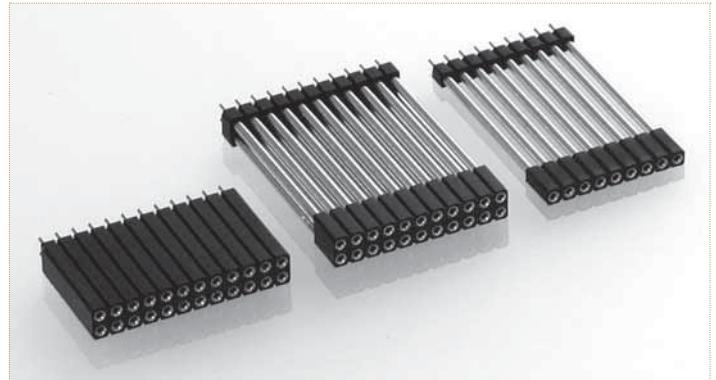

## ORDERING INFORMATION ROHS COMPLIANT PARTS

PP PLATING CODE	SLEEVE	CLIP
87	Tin	Flash gold
83	Tin	0.75 µm gold

Other plating on request (see page 178 for plating specs).

**NNN number of poles.** Replace **NNN** with the requested number of poles, e.g. 803-87-**NNN**-10-216101 for a double row version with 16 pins becomes 803-87-**016**-10-216101.

### 803-PP-NNN-10-249101

Straight socket connector, height 19.7 mm, solder tail, double row

AVAILABILITY FROM 4 to 40 contacts  
(standard number of contacts: 40)

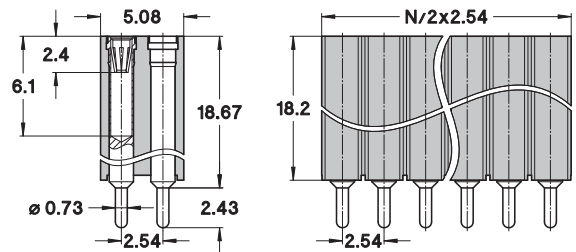

### 801-PP-NNN-10-216101

Straight socket connector, height 37.5 mm, solder tail, single row

AVAILABILITY FROM 2 to 32 contacts  
(standard number of contacts: 32)

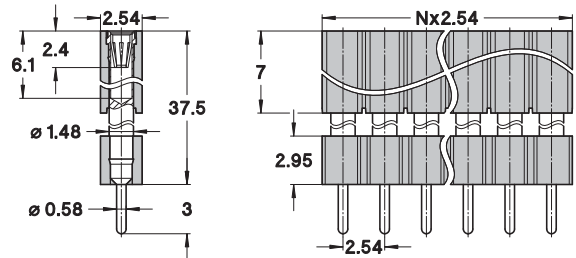

### 803-PP-NNN-10-216101

Straight socket connector, height 37.5 mm, solder tail, double row

AVAILABILITY FROM 4 to 72 contacts  
(standard number of contacts: 72)

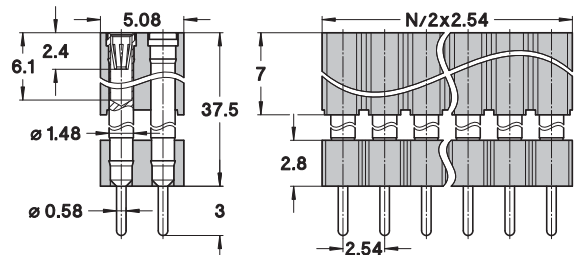





preci-dip

WWW.PRECIDIP.COM TEL +41 32 421 04 00 SALES@PRECIDIP.COM

# SOCKET CONNECTORS 2.54 mm

MATING PIN Ø 0.76 mm / SINGLE ROW / DOUBLE ROW / SOLDER TAIL / RIGHT ANGLE

Right angle socket connectors, solder tail.

## TECHNICAL SPECIFICATIONS (FOR GENERAL SPECS, SEE PAGE 43)

INSULATOR	Black glass filled polyester PCT-GF30-FR
FLAMMABILITY	UL 94V-0
SLEEVE	Brass CuZn36Pb3 (C36000)
CONTACT CLIP (6 FINGER)	Beryllium copper (C17200)
MATING PINS	Ø 0.70 to 0.90 mm, $\nabla$ 0.635 mm
FORCES	1.2 N typ. insertion      0.6 N typ. withdrawal (polished steel gauge Ø 0.76 mm)
MECHANICAL LIFE	Min. 500 cycles
RATED CURRENT	3 A
CONTACT RESISTANCE	Max. 10 mΩ
DIELECTRIC STRENGTH	Min. 1'000 V <sub>RMS</sub>

For corresponding pin connectors, see pages 109-119.

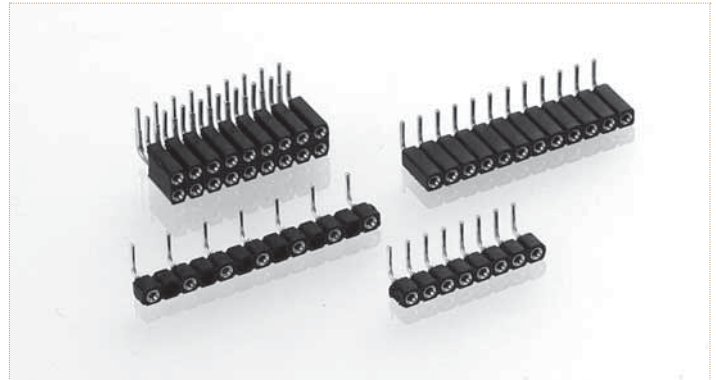

## ORDERING INFORMATION ROHS COMPLIANT PARTS

PP PLATING CODE	SLEEVE	CLIP
87	Tin	Flash gold
83	Tin	0.75 µm gold

Other plating on request (see page 178 for plating specs).

**NNN number of poles.** Replace **NNN** with the requested number of poles, e.g. 803-87-**NNN**-20-001101 for a double row version with 16 pins becomes 803-87-**016**-20-001101.

### 801-PP-NNN-20-002101

Right angle short socket connector, solder tail, single row

**AVAILABILITY FROM** 2 to 64 contacts  
(standard number of contacts: 64)  
Option: right angle short receptacle, solder tail, double row available on request

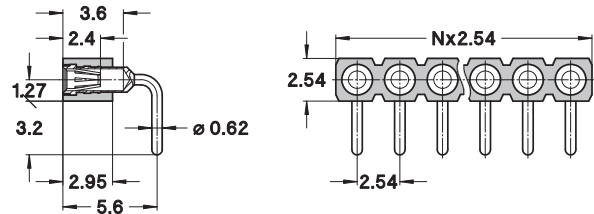

### 801-PP-YYY-20-442101

Right angle short socket connector, solder tail, single row, partially equipped 5.08 mm

**AVAILABILITY FROM** 2 to 32 contacts  
**YYY number of poles:**  
please consult for ordering code

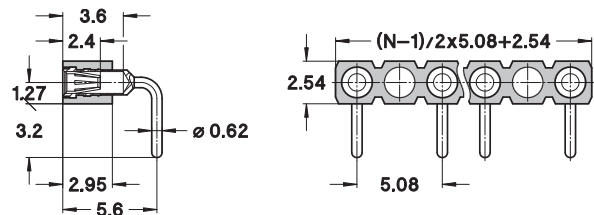

**Bulk:** 801-PP-NNN-20-001101      **T & R Packaging\*:** 801-PP-NNN-20-001191

Right angle socket connector, solder tail, single row

**AVAILABILITY FROM** 2 to 50 contacts  
(standard number of contacts: 50)

\*Please consult [www.precidip.com](http://www.precidip.com) for availability size of tape, size of reel, number of components per reel and packing units.

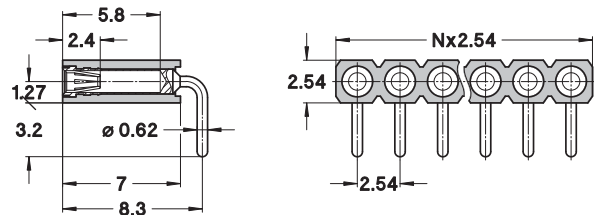

### 803-PP-NNN-20-001101

Right angle socket connector, solder tail, double row

**AVAILABILITY FROM** 4 to 100 contacts  
(standard number of contacts: 100)

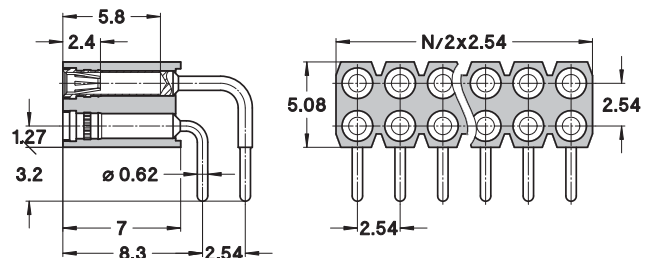



preci-dip

WWW.PRECIDIP.COM TEL +41 32 421 04 00 SALES@PRECIDIP.COM

# SOCKET CONNECTORS 2.54 mm

MATING PIN Ø 0.76 mm / SINGLE ROW / SOLDER TAIL / RIGHT ANGLE

Right angle socket connectors, solder tail.

## TECHNICAL SPECIFICATIONS (FOR GENERAL SPECS, SEE PAGE 43)

INSULATOR	Black glass filled polyester PCT-GF30-FR
FLAMMABILITY	UL 94V-0
SLEEVE	Brass CuZn36Pb3 (C36000)
CONTACT CLIP (6 FINGER)	Beryllium copper (C17200)
MATING PINS	Ø 0.70 to 0.90 mm, $\nabla$ 0.635 mm
FORCES	1.2 N typ. insertion      0.6 N typ. withdrawal (polished steel gauge Ø 0.76 mm)
MECHANICAL LIFE	Min. 500 cycles
RATED CURRENT	3 A
CONTACT RESISTANCE	Max. 10 mΩ
DIELECTRIC STRENGTH	Min. 1'000 V <sub>RMS</sub>

For corresponding pin connectors, see pages 109-119.



Other plating on request (see page 178 for plating specs).

## ORDERING INFORMATION ROHS COMPLIANT PARTS

PP PLATING CODE	SLEEVE	CLIP
87	Tin	Flash gold
83	Tin	0.75 µm gold

### 801-PP-YYY-20-101101

Right angle socket connector, solder tail, single row, partially equipped 5.08 mm

AVAILABILITY FROM 2 to 25 contacts  
**YYY number of poles:**  
 please consult for ordering code

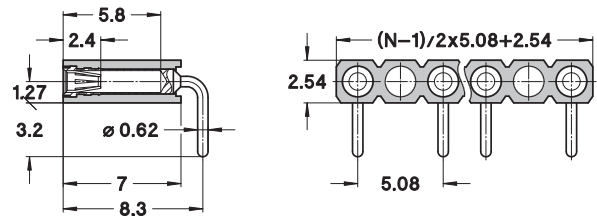



preci-dip

WWW.PRECIDIP.COM TEL +41 32 421 04 00 SALES@PRECIDIP.COM

# SOCKET CONNECTORS 2.54 mm

MATING PIN Ø 0.76 mm / SINGLE ROW / DOUBLE ROW / SURFACE MOUNT

Socket connectors, SMD perpendicular mount.

## TECHNICAL SPECIFICATIONS (FOR GENERAL SPECS, SEE PAGE 43)

INSULATOR	Black glass filled polyester PCT-GF30-FR
FLAMMABILITY	UL 94V-0
SLEEVE	Brass CuZn36Pb3 (C36000)
CONTACT CLIP (6 FINGER)	Beryllium copper (C17200)
MATING PINS	Ø 0.70 to 0.90 mm, $\nabla$ 0.635 mm
FORCES	1.2 N typ. insertion      0.6 N typ. withdrawal (polished steel gauge Ø 0.76 mm)
MECHANICAL LIFE	Min. 500 cycles
RATED CURRENT	3 A
CONTACT RESISTANCE	Max. 10 mΩ
DIELECTRIC STRENGTH	Min. 1'000 V <sub>RMS</sub>
COPLANARITY SMD TERMINATIONS	Max. 0.1 mm (measured on 25 mm long connectors)

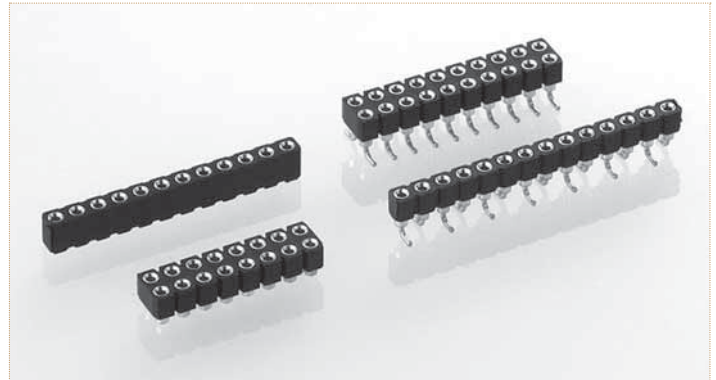

For corresponding pin connectors, see pages 109-119.

Other plating on request (see page 178 for plating specs).

**NNN number of poles.** Replace **NNN** with the requested number of poles, e.g. 803-87-**NNN**-30-002101 for a double row version with 16 pins becomes 803-87-**016**-30-002101.

## ORDERING INFORMATION ROHS COMPLIANT PARTS

PP PLATING CODE	SLEEVE	CLIP
87	Tin	Flash gold
83	Tin	0.75 µm gold

**Bulk:** **T & R Packaging with pick & place cap\*:**  
801-PP-**NNN**-30-480101    801-PP-**NNN**-30-480191

SMD socket connector, single row, perpendicular mount with self-levelling floating contacts

**AVAILABILITY FROM** 2 to 12 contacts  
(standard number of contacts: 12)  
For connectors having more than 9 contacts, the coplanarity issue is to be addressed specifically

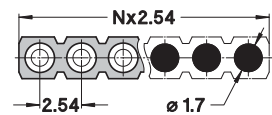
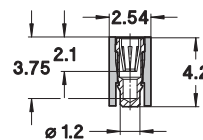

\*Please consult [www.precidip.com](http://www.precidip.com) for availability size of tape, size of reel, number of components per reel and packing units.

**Bulk:** **T & R Packaging with pick & place cap\*:**  
803-PP-**NNN**-30-480101    803-PP-**NNN**-30-480191

SMD socket connector, double row, perpendicular mount with self-levelling floating contacts

**AVAILABILITY FROM** 4 to 64 contacts  
(standard number of contacts: 64)  
For connectors having more than 9 contacts per row, the coplanarity issue is to be addressed specifically

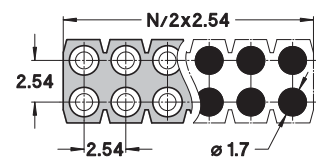
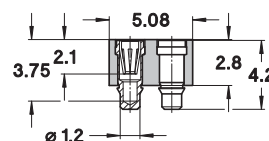

\*Please consult [www.precidip.com](http://www.precidip.com) for availability size of tape, size of reel, number of components per reel and packing units.

**Bulk:** **T & R Packaging with pick & place cap\*:**  
801-PP-**NNN**-30-002101    801-PP-**NNN**-30-002191

SMD socket connector, single row, perpendicular mount with gull-wing terminations

**AVAILABILITY FROM** 3 to 64 contacts  
(standard number of contacts: 64)  
For connectors having more than 9 contacts, the coplanarity issue is to be addressed specifically

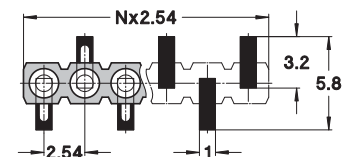
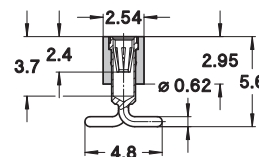

\*Please consult [www.precidip.com](http://www.precidip.com) for availability size of tape, size of reel, number of components per reel and packing units.

**Bulk:** **T & R Packaging with pick & place cap\*:**  
803-PP-**NNN**-30-002101    803-PP-**NNN**-30-002191

SMD socket connector, double row, perpendicular mount with gull-wing terminations

**AVAILABILITY FROM** 4 to 72 contacts  
(standard number of contacts: 40 and 72)  
For connectors having more than 9 contacts per row, the coplanarity issue is to be addressed specifically

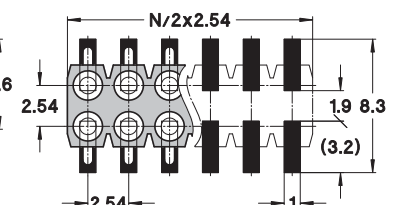
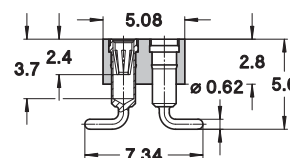

\*Please consult [www.precidip.com](http://www.precidip.com) for availability size of tape, size of reel, number of components per reel and packing units.



preci-dip

WWW.PRECIDIP.COM TEL +41 32 421 04 00 SALES@PRECIDIP.COM

# SOCKET CONNECTORS 2.54 mm

MATING PIN Ø 0.76 mm / SINGLE ROW / DOUBLE ROW / SURFACE MOUNT

Socket connectors, SMD perpendicular mount.

## TECHNICAL SPECIFICATIONS (FOR GENERAL SPECS, SEE PAGE 43)

<b>INSULATOR</b>	Black glass filled polyester PCT-GF30-FR
<b>FLAMMABILITY</b>	UL 94V-0
<b>SLEEVE</b>	Brass CuZn36Pb3 (C36000)
<b>CONTACT CLIP (6 FINGER)</b>	Beryllium copper (C17200)
<b>MATING PINS</b>	Ø 0.70 to 0.90 mm, $\nabla$ 0.635 mm
<b>FORCES</b>	1.2 N typ. insertion      0.6 N typ. withdrawal (polished steel gauge Ø 0.76 mm)
<b>MECHANICAL LIFE</b>	Min. 500 cycles
<b>RATED CURRENT</b>	3 A
<b>CONTACT RESISTANCE</b>	Max. 10 mΩ
<b>DIELECTRIC STRENGTH</b>	Min. 1'000 V <sub>RMS</sub>
<b>COPLANARITY</b>	
<b>SMD TERMINATIONS</b>	Max. 0.1 mm (measured on 25 mm long connectors)

For corresponding pin connectors, see pages 109-119.

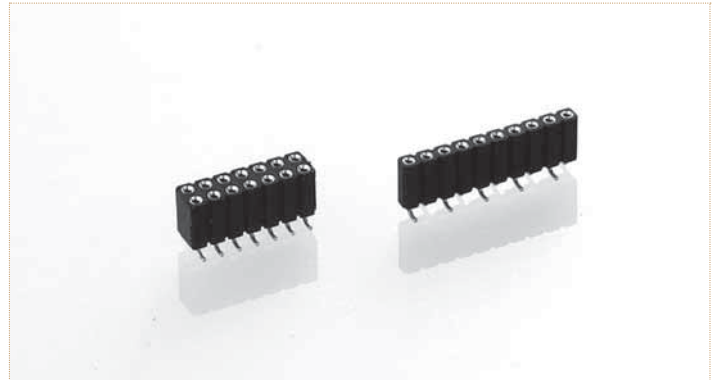

Other plating on request (see page 178 for plating specs).

**NNN number of poles.** Replace **NNN** with the requested number of poles, e.g. 803-87-**NNN**-30-001101 for a double row version with 16 pins becomes 803-87-**016**-30-001101.

## ORDERING INFORMATION ROHS COMPLIANT PARTS

PP PLATING CODE	SLEEVE	CLIP
87	Tin	Flash gold
83	Tin	0.75 µm gold

**Bulk:** **T & R Packaging with pick & place cap\*:**  
801-PP-**NNN**-30-001101    801-PP-**NNN**-30-001191

SMD socket connector, single row, perpendicular mount with gull-wing terminations

**AVAILABILITY FROM** 3 to 50 contacts  
(standard number of contacts: 50)  
For connectors having more than 9 contacts, the coplanarity issue is to be addressed specifically

\*Please consult [www.precidip.com](http://www.precidip.com) for availability size of tape, size of reel, number of components per reel and packing units.

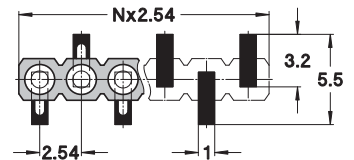
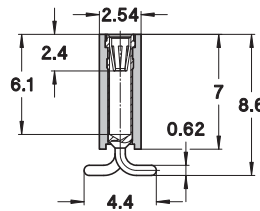

**Bulk:** **T & R Packaging with pick & place cap\*:**  
803-PP-**NNN**-30-001101    803-PP-**NNN**-30-001191

SMD socket connector, double row, perpendicular mount with gull-wing terminations

**AVAILABILITY FROM** 4 to 100 contacts  
(standard number of contacts: 100)  
For connectors having more than 9 contacts per row, the coplanarity issue is to be addressed specifically

\*Please consult [www.precidip.com](http://www.precidip.com) for availability size of tape, size of reel, number of components per reel and packing units.

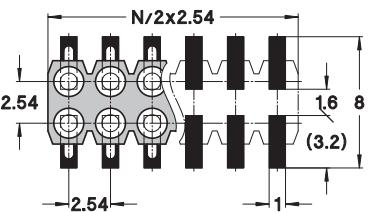
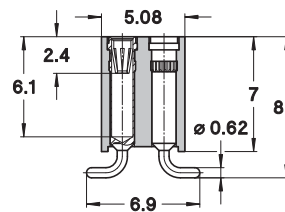



preci-dip

WWW.PRECIDIP.COM TEL +41 32 421 04 00 SALES@PRECIDIP.COM

# SOCKET CONNECTORS 2.54 mm

MATING PIN Ø 0.76 mm / SINGLE ROW / SURFACE MOUNT

Socket connectors, SMD parallel mount.

## TECHNICAL SPECIFICATIONS (FOR GENERAL SPECS, SEE PAGE 43)

<b>INSULATOR</b>	Black glass filled polyester PCT-GF30-FR
<b>FLAMMABILITY</b>	UL 94V-0
<b>SLEEVE</b>	Brass CuZn36Pb3 (C36000)
<b>CONTACT CLIP (6 FINGER)</b>	Beryllium copper (C17200)
<b>MATING PINS</b>	Ø 0.70 to 0.90 mm, $\nabla$ 0.635 mm
<b>FORCES</b>	1.2 N typ. insertion      0.6 N typ. withdrawal (polished steel gauge Ø 0.76 mm)
<b>MECHANICAL LIFE</b>	Min. 500 cycles
<b>RATED CURRENT</b>	3 A
<b>CONTACT RESISTANCE</b>	Max. 10 mΩ
<b>DIELECTRIC STRENGTH</b>	Min. 1'000 V <sub>RMS</sub>
<b>COPLANARITY</b>	
<b>SMD TERMINATIONS</b>	Max. 0.1 mm (measured on 25 mm long connectors)

For corresponding pin connectors, see pages 109-119.

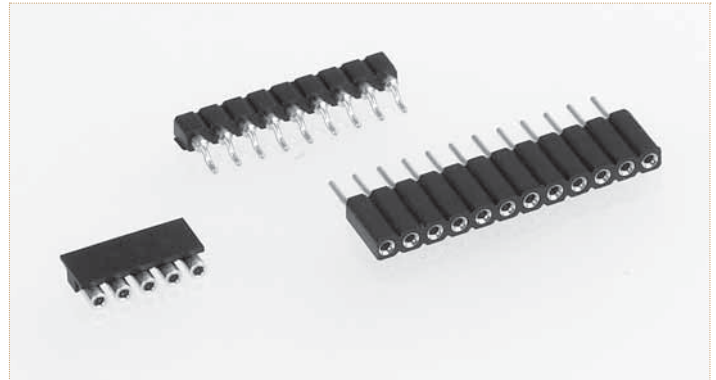

## ORDERING INFORMATION ROHS COMPLIANT PARTS

PP PLATING CODE	SLEEVE	CLIP
78, 87	Tin	Gold flash
38, 83	Tin	Gold 0.75 µm

Code 78, 38 for 8FM...02-146 series / 87, 83 for 801...40-00X101 series

Other plating on request (see page 178 for plating specs).

**NNN number of poles.** Replace **NNN** with the requested number of poles, e.g. 801-87-**NNN**-40-002101 for a single row version with 8 pins becomes 801-87-**008**-40-002101.

**Bulk:** **T & R Packaging with pick & place cap\*:**  
8FM-PP-0NNN-02-278      8FM-PP-0NNN-02-278191

SMD socket connector, parallel mount, low profile minimum PCB space requirement, single row

**AVAILABILITY FROM** 2 to 10 contacts  
(standard number of contacts: 10)  
For connectors having more than 9 contacts, the coplanarity issue is to be addressed specifically

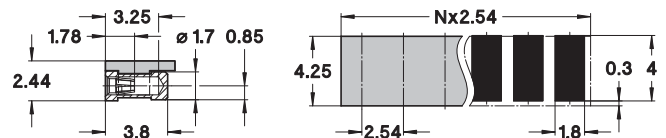

\*Please consult [www.precidip.com](http://www.precidip.com) for availability size of tape, size of reel, number of components per reel and packing units.

**Bulk:** **T & R Packaging with pick & place cap\*:**  
8FM-PP-0NNN-02-146      8FM-PP-0NNN-02-146191

SMD socket connector, parallel mount, low profile minimum PCB space requirement, single row

**AVAILABILITY FROM** 2 to 10 contacts  
(standard number of contacts: 10)  
For connectors having more than 9 contacts, the coplanarity issue is to be addressed specifically

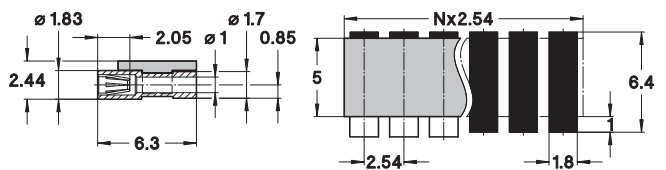

\*Please consult [www.precidip.com](http://www.precidip.com) for availability size of tape, size of reel, number of components per reel and packing units.

**Bulk:** **T & R Packaging\*:**  
801-PP-NNN-40-002101      8FM-PP-0NNN-02-146191

SMD socket connector, parallel mount, short contact, single row

**AVAILABILITY FROM** 2 to 64 contacts  
(standard number of contacts: 64)  
For connectors having more than 9 contacts, the coplanarity issue is to be addressed specifically

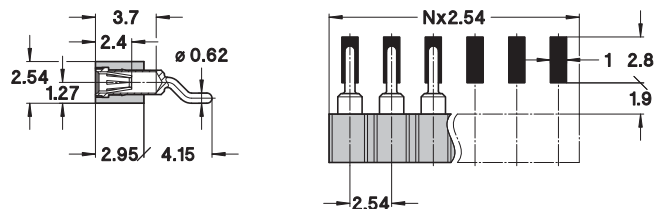

\*Please consult [www.precidip.com](http://www.precidip.com) for availability size of tape, size of reel, number of components per reel and packing units.

**Bulk:** **T & R Packaging\*:**  
801-PP-NNN-40-001101      8FM-PP-0NNN-02-146191

SMD socket connector, parallel mount, long contact, single row

**AVAILABILITY FROM** 2 to 50 contacts  
(standard number of contacts: 50)  
For connectors having more than 9 contacts, the coplanarity issue is to be addressed specifically

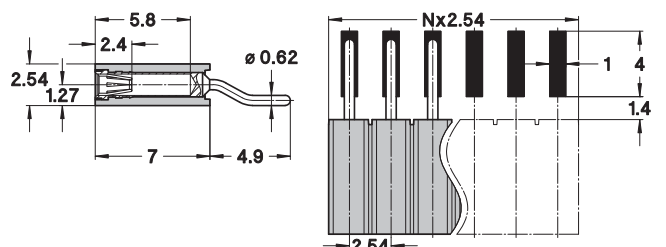

\*Please consult [www.precidip.com](http://www.precidip.com) for availability size of tape, size of reel, number of components per reel and packing units.





preci-dip

WWW.PRECIDIP.COM TEL +41 32 421 04 00 SALES@PRECIDIP.COM

# SOCKET CONNECTORS 2.54 mm

MATING PIN Ø 0.76 mm / SINGLE ROW / DOUBLE ROW / PRESS-FIT

Socket connectors, press-fit with compliant pin for solderless mount in PCB plated through holes.

## TECHNICAL SPECIFICATIONS (FOR GENERAL SPECS, SEE PAGE 43)

<b>INSULATOR</b>	Black glass filled polyester PCT-GF30-FR
<b>FLAMMABILITY</b>	UL 94V-0
<b>SLEEVE</b>	Bronze CuSn4Pb4Zn4 (C54400)
<b>CONTACT CLIP (6 FINGER)</b>	Beryllium copper (C17200)
<b>MATING PINS</b>	Ø 0.70 to 0.90 mm, $\nabla$ 0.635 mm
<b>FORCES</b>	1.2 N typ. insertion      0.6 N typ. withdrawal (polished steel gauge Ø 0.76 mm)
<b>MECHANICAL LIFE</b>	Min. 500 cycles
<b>RATED CURRENT</b>	3 A
<b>CONTACT RESISTANCE</b>	Max. 10 mΩ
<b>DIELECTRIC STRENGTH</b>	Min. 1'000 V <sub>RMS</sub>
<b>PCB HOLE Ø</b>	1 mm +0.09/-0.06 mm finished (1.15 ±0.025 mm drill)

For corresponding pin connectors, see pages 109-119.

## ORDERING INFORMATION ROHS COMPLIANT PARTS

PP PLATING CODE	SLEEVE	CLIP
87	Tin	Flash gold
83	Tin	0.75 µm gold

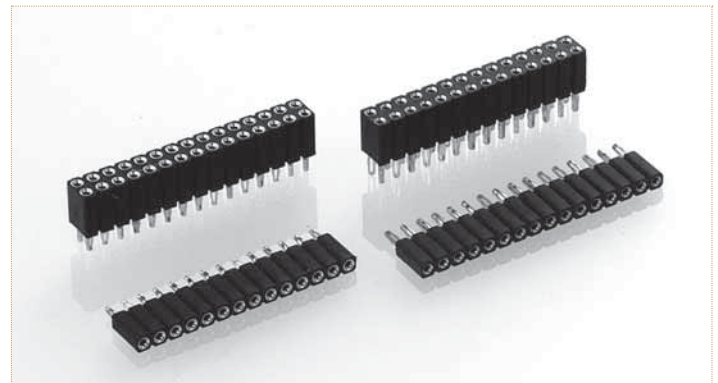

Other plating on request (see page 178 for plating specs).

**NNN number of poles.** Replace **NNN** with the requested number of poles, e.g. 801-87-**NNN**-65-001101 for a single row version with 8 pins becomes 801-87-**008**-65-001101.

### 801-PP-NNN-65-001101

Press-fit socket connector, single row, compliant pin for PCB thickness 1.5 to 2.5 mm

**AVAILABILITY FROM** 2 to 50 contacts  
(standard number of contacts: 50)

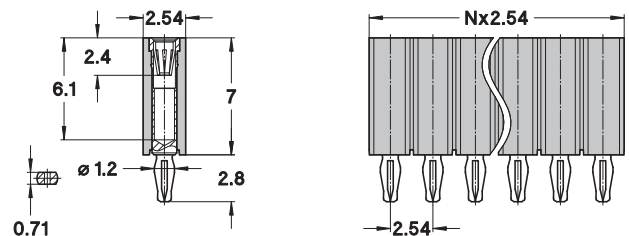

### 803-PP-NNN-65-001101

Press-fit socket connector, double row, compliant pin for PCB thickness 1.5 to 2.5 mm

**AVAILABILITY FROM** 4 to 100 contacts  
(standard number of contacts: 100)

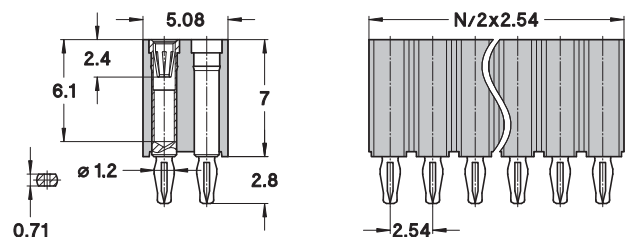

### 801-PP-NNN-66-001101

Press-fit socket connector, single row, compliant pin for PCB thickness 2.1 to 3.2 mm

**AVAILABILITY FROM** 2 to 50 contacts  
(standard number of contacts: 50)

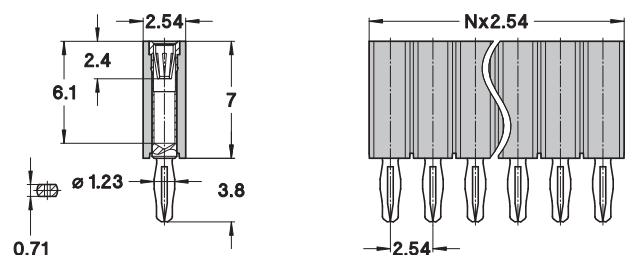

### 803-PP-NNN-66-001101

Press-fit socket connector, double row, compliant pin for PCB thickness 2.1 to 3.2 mm

**AVAILABILITY FROM** 4 to 100 contacts  
(standard number of contacts: 100)

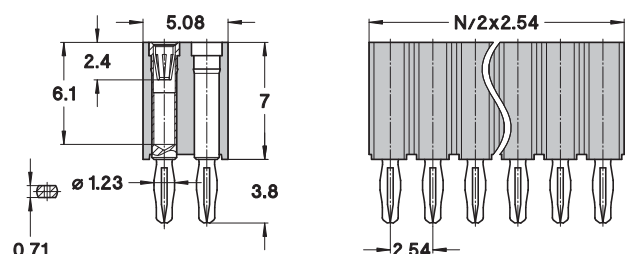



preci-dip

WWW.PRECIDIP.COM TEL +41 32 421 04 00 SALES@PRECIDIP.COM

# SOCKET CONNECTORS 2.54 mm

MATING PIN Ø 0.76 mm / SINGLE ROW / DOUBLE ROW / WIRE-WRAP

Socket connectors.

## TECHNICAL SPECIFICATIONS (FOR GENERAL SPECS, SEE PAGE 43)

<b>INSULATOR</b>	Black glass filled polyester PCT-GF30-FR
<b>FLAMMABILITY</b>	UL 94V-0
<b>SLEEVE</b>	Brass CuZn36Pb3 (C36000)
<b>CONTACT CLIP (6 FINGER)</b>	Beryllium copper (C17200)
<b>MATING PINS</b>	Ø 0.70 to 0.90 mm, $\square$ 0.635 mm
<b>FORCES</b>	1.2 N typ. insertion      0.6 N typ. withdrawal (polished steel gauge Ø 0.76 mm)
<b>MECHANICAL LIFE</b>	Min. 500 cycles
<b>RATED CURRENT</b>	3 A
<b>CONTACT RESISTANCE</b>	Max. 10 mΩ
<b>DIELECTRIC STRENGTH</b>	Min. 1'000 V <sub>RMS</sub>

For corresponding pin connectors, see pages 109-119.

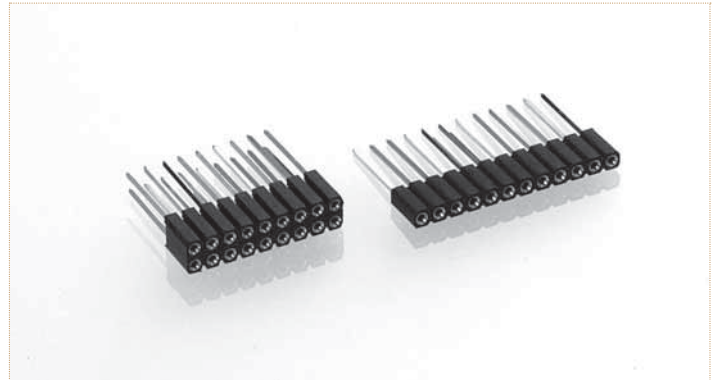

## ORDERING INFORMATION ROHS COMPLIANT PARTS

PP PLATING CODE	SLEEVE	CLIP
87	Tin	Flash gold
83	Tin	0.75 µm gold

Other plating on request (see page 178 for plating specs).

**NNN number of poles.** Replace **NNN** with the requested number of poles, e.g. 803-87-**NNN**-53-001101 for a double row version with 16 pins becomes 803-87-**016**-53-001101.

### 801-PP-NNN-53-001101

Wire-wrap socket connector, height 7 mm, 3-level, single row

**AVAILABILITY FROM** 2 to 50 contacts  
(standard number of contacts: 50)

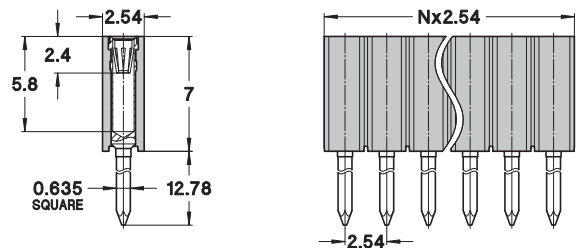

### 803-PP-NNN-53-001101

Wire-wrap socket connector, height 7 mm, 3-level, double row

**AVAILABILITY FROM** 4 to 100 contacts  
(standard number of contacts: 100)

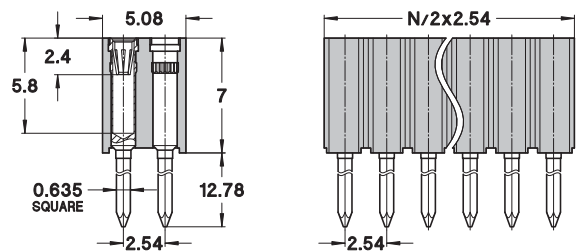



preci-dip

WWW.PRECIDIP.COM TEL +41 32 421 04 00 SALES@PRECIDIP.COM

# SOCKET CONNECTORS 2.54 mm

MATING PIN Ø 1 mm / SINGLE ROW / DOUBLE ROW / SOLDER TAIL

Socket connectors, solder tail.

## TECHNICAL SPECIFICATIONS (FOR GENERAL SPECS, SEE PAGE 43)

<b>INSULATOR</b>	Black glass filled polyester PCT-GF30-FR
<b>FLAMMABILITY</b>	UL 94V-0
<b>SLEEVE</b>	Brass CuZn36Pb3 (C36000)
<b>CONTACT CLIP (6 FINGER)</b>	Beryllium copper (C17200)
<b>MATING PIN Ø</b>	0.95 to 1.08 mm
<b>FORCES</b>	1.2 N typ. insertion      0.6 N typ. withdrawal (polished steel gauge Ø 1 mm)
<b>MECHANICAL LIFE</b>	Min. 100 cycles
<b>RATED CURRENT</b>	3 A
<b>CONTACT RESISTANCE</b>	Max. 10 mΩ
<b>DIELECTRIC STRENGTH</b>	Min. 1'000 V <sub>RMS</sub>

For corresponding pin connectors, see page 113.

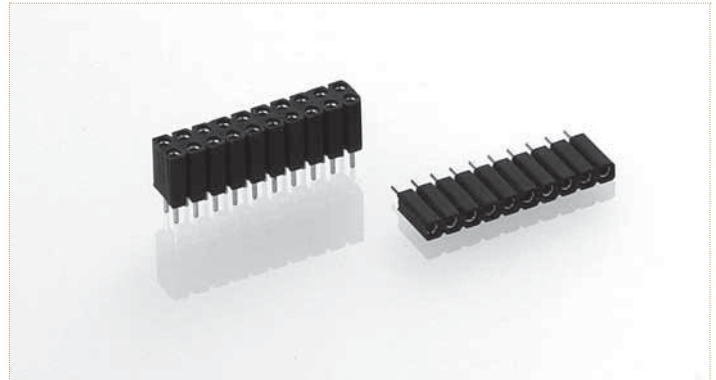

## ORDERING INFORMATION ROHS COMPLIANT PARTS

PP PLATING CODE	SLEEVE	CLIP
87	Tin	Flash gold
83	Tin	0.75 µm gold

Other plating on request (see page 178 for plating specs).

**NNN number of poles.** Replace **NNN** with the requested number of poles, e.g. 803-87-**NNN**-10-004101 for a double row version with 16 pins becomes 803-87-**016**-10-004101.

### 801-PP-NNN-10-004101

Straight socket connector, height 7 mm, solder tail, single row

**AVAILABILITY FROM** 2 to 50 contacts  
(standard number of contacts: 50)

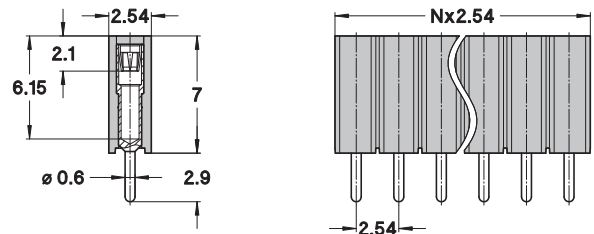

### 803-PP-NNN-10-004101

Straight socket connector, height 7 mm, solder tail, double row

**AVAILABILITY FROM** 4 to 100 contacts  
(standard number of contacts: 100)

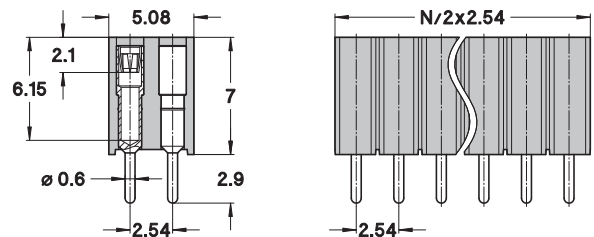



preci-dip

WWW.PRECIDIP.COM TEL +41 32 421 04 00 SALES@PRECIDIP.COM

# PIN CONNECTORS 2.54 mm

CONNECTING PIN Ø 0.47 mm / SINGLE ROW / DOUBLE ROW  
SOLDER TAIL

Pin connectors, solder tail.

## TECHNICAL SPECIFICATIONS (FOR GENERAL SPECS, SEE PAGE 43)

INSULATOR	Black glass filled polyester PCT-GF30-FR
FLAMMABILITY	UL 94V-0
CONTACT	Brass CuZn36Pb3 (C36000)
CONNECTING PIN Ø	0.47 mm and 0.49 mm
MECHANICAL LIFE	Min. 500 cycles
RATED CURRENT	3 A
DIELECTRIC STRENGTH	Min. 1'000 V <sub>RMS</sub>

For corresponding socket connectors, see pages 69-84.

## ORDERING INFORMATION ROHS COMPLIANT PARTS

PP PLATING CODE	TERMINATION	CONNECTING PIN
10	0.25 µm gold	0.25 µm gold
80	Tin	Tin
V3*	Tin	0.75 µm gold

\*only for 350/450...00-006101 series

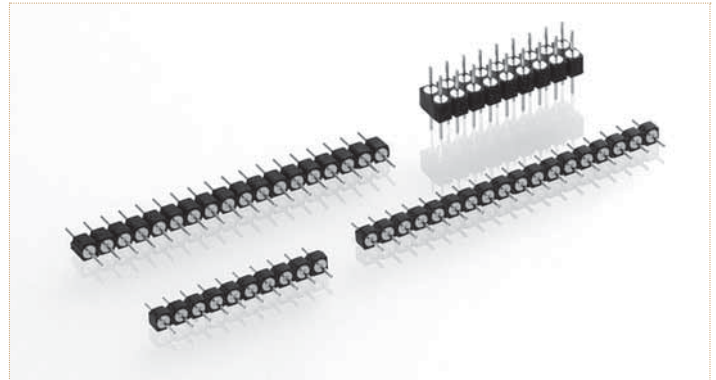

Other plating on request (see page 178 for plating specs).

**NN number of poles.** Replace NN with the requested number of poles, e.g. 450-10-2NN-00-006101 for a double row version with 16 pins becomes 450-10-216-00-006101.

### 350-PP-1NN-00-019101

Straight pin connector ultralow profile, height 1.9 mm, solder tail, single row

AVAILABILITY FROM 2 to 64 contacts  
(standard number of contacts: 64)

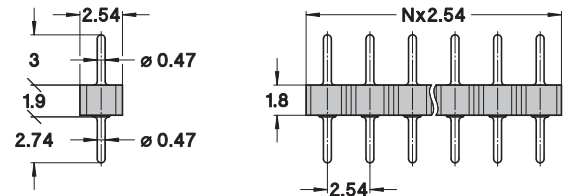

### 350-PP-1NN-00-024101

Straight pin connector ultralow profile, height 2.2 mm, solder tail, single row

AVAILABILITY FROM 2 to 64 contacts  
(standard number of contacts: 64)

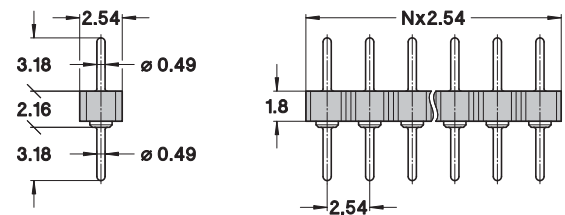

### 350-PP-1NN-00-006101

Straight pin connector low profile, height 3.5 mm, solder tail, single row

AVAILABILITY FROM 2 to 64 contacts  
(standard number of contacts: 64)

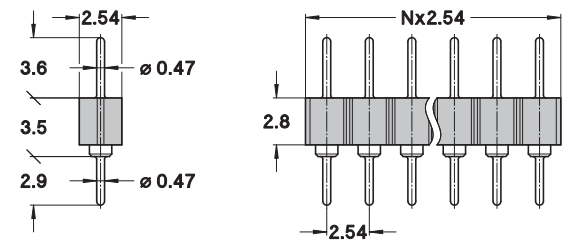

### 450-PP-2NN-00-006101

Straight pin connector low profile, height 3.5 mm, solder tail, double row

AVAILABILITY FROM 4 to 72 contacts  
(standard number of contacts: 72)

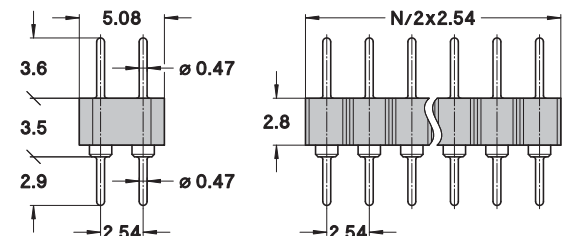



preci-dip

WWW.PRECIDIP.COM TEL +41 32 421 04 00 SALES@PRECIDIP.COM

# PIN CONNECTORS 2.54 mm

CONNECTING PIN Ø 0.47 mm / SINGLE ROW / DOUBLE ROW  
SOLDER TAIL

Pin connectors, solder tail.

## TECHNICAL SPECIFICATIONS (FOR GENERAL SPECS, SEE PAGE 43)

INSULATOR	Black glass filled polyester PCT-GF30-FR
FLAMMABILITY	UL 94V-0
CONTACT	Brass CuZn36Pb3 (C36000)
CONNECTING PIN Ø	0.47 mm
MECHANICAL LIFE	Min. 500 cycles
RATED CURRENT	3 A
DIELECTRIC STRENGTH	Min. 1'000 V <sub>RMS</sub>

For corresponding socket connectors, see pages 69-84.

## ORDERING INFORMATION ROHS COMPLIANT PARTS

PP PLATING CODE	TERMINATION	CONNECTING PIN
10	0.25 µm gold	0.25 µm gold
80	Tin	Tin

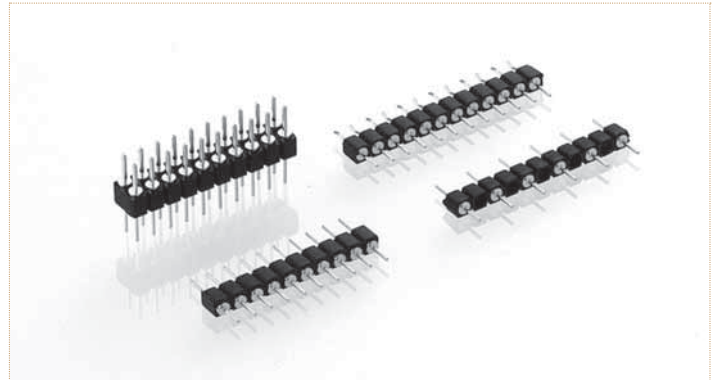

Other plating on request (see page 178 for plating specs).

**NN number of poles.** Replace NN with the requested number of poles, e.g. 350-10-1NN-00-001101 for a single row version with 8 pins becomes 350-10-108-00-001101.

### 350-PP-1NN-01-666101

Straight pin connector, height 3.5 mm, with clinched (right/left) solder tails, single row

AVAILABILITY FROM 3 to 64 contacts  
(standard number of contacts: 64)

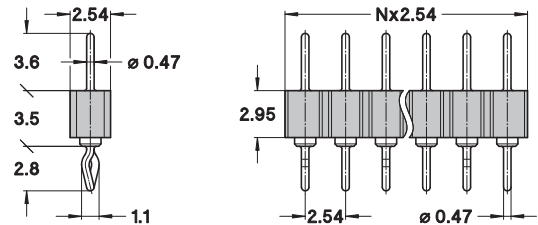

### 350-PP-1YY-01-714101

Straight pin connector, height 3.5 mm, solder tail, single row, partially equipped 5.08 mm

AVAILABILITY FROM 2 to 32 contacts  
**YY number of poles:**  
please consult for ordering code

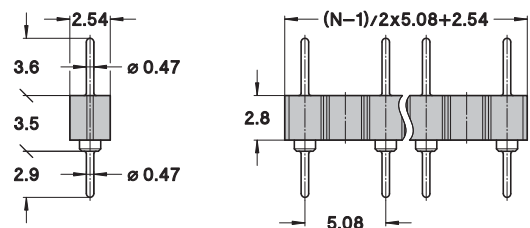

### 350-PP-1NN-00-001101

Straight pin connector, height 4 mm, solder tail, single row

AVAILABILITY FROM 2 to 64 contacts  
(standard number of contacts: 64)

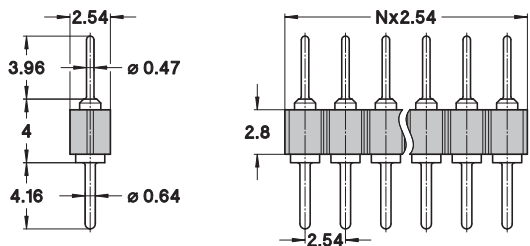

### 450-PP-2NN-00-001101

Straight pin connector, height 4 mm, solder tail, double row

AVAILABILITY FROM 4 to 72 contacts  
(standard number of contacts: 72)

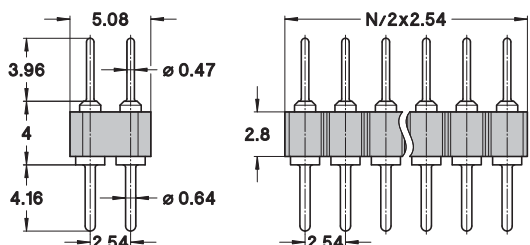





preci-dip

WWW.PRECIDIP.COM TEL +41 32 421 04 00 SALES@PRECIDIP.COM

# PIN CONNECTORS 2.54 mm

CONNECTING PIN Ø 0.47 mm / SINGLE ROW / DOUBLE ROW  
SOLDER TAIL

Pin connectors, solder tail.

## TECHNICAL SPECIFICATIONS (FOR GENERAL SPECS, SEE PAGE 43)

INSULATOR	Black glass filled polyester PCT-GF30-FR
FLAMMABILITY	UL 94V-0
CONTACT	Brass CuZn36Pb3 (C36000)
CONNECTING PIN Ø	0.47 mm
MECHANICAL LIFE	Min. 500 cycles
RATED CURRENT	3 A
DIELECTRIC STRENGTH	Min. 1'000 V <sub>RMS</sub>

For corresponding socket connectors, see pages 69-84.

## ORDERING INFORMATION ROHS COMPLIANT PARTS

PP PLATING CODE	TERMINATION	CONNECTING PIN
10	0.25 µm gold	0.25 µm gold
80	Tin	Tin

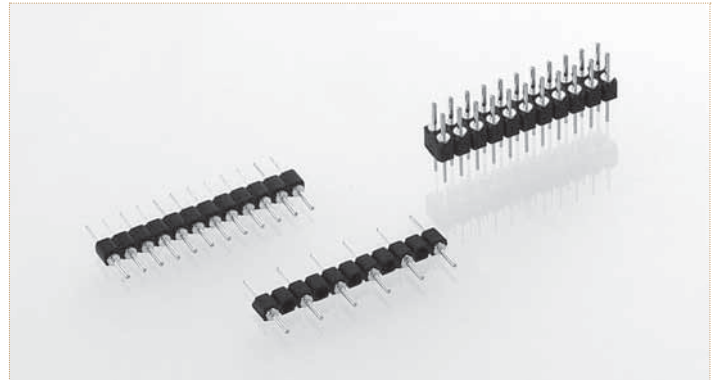

Other plating on request (see page 178 for plating specs).

**NN number of poles.** Replace **NN** with the requested number of poles, e.g. 450-10-2**NN**-00-013101 for a double row version with 16 pins becomes 450-10-2**16**-00-013101.

### 350-PP-1YY-01-609101

Straight pin connector, low profile, height 4 mm, solder tail, single row, partially equipped 5.08 mm

AVAILABILITY FROM 2 to 32 contacts  
**YY number of poles:**  
please consult for ordering code

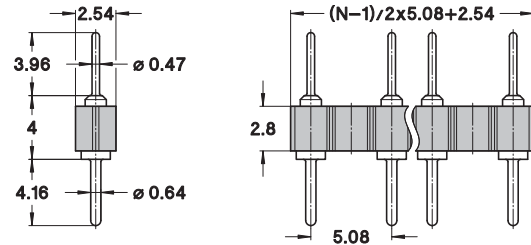

### 350-PP-1NN-00-013101

Straight pin connector, height 4.1 mm, solder tail, single row

AVAILABILITY FROM 2 to 64 contacts  
(standard number of contacts: 64)

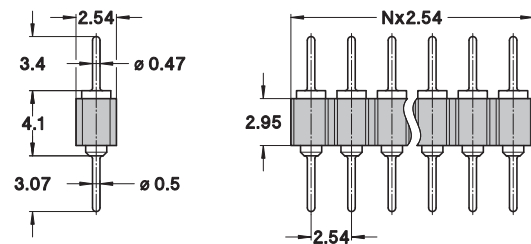

### 450-PP-2NN-00-013101

Straight pin connector, height 4.1 mm, solder tail, double row

AVAILABILITY FROM 4 to 72 contacts  
(standard number of contacts: 72)

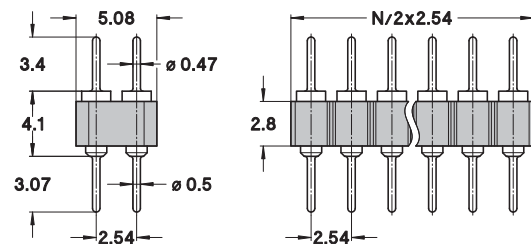



preci-dip

WWW.PRECIDIP.COM TEL +41 32 421 04 00 SALES@PRECIDIP.COM

# PIN CONNECTORS 2.54 mm

CONNECTING PIN Ø 0.47 mm / SINGLE ROW / DOUBLE ROW  
SOLDER TAIL

Pin interconnect connectors, solder tail.

## TECHNICAL SPECIFICATIONS (FOR GENERAL SPECS, SEE PAGE 43)

INSULATOR	Black glass filled polyester PCT-GF30-FR
FLAMMABILITY	UL 94V-0
CONTACT	Brass CuZn36Pb3 (C36000)
CONNECTING PIN Ø	0.47 mm
MECHANICAL LIFE	Min. 500 cycles
RATED CURRENT	3 A
DIELECTRIC STRENGTH	Min. 1'000 V <sub>RMS</sub>

For corresponding socket connectors, see pages 69-80.

## ORDERING INFORMATION ROHS COMPLIANT PARTS

PP PLATING CODE	TERMINATION	CONNECTING PIN
10	0.25 µm gold	0.25 µm gold
80	Tin	Tin

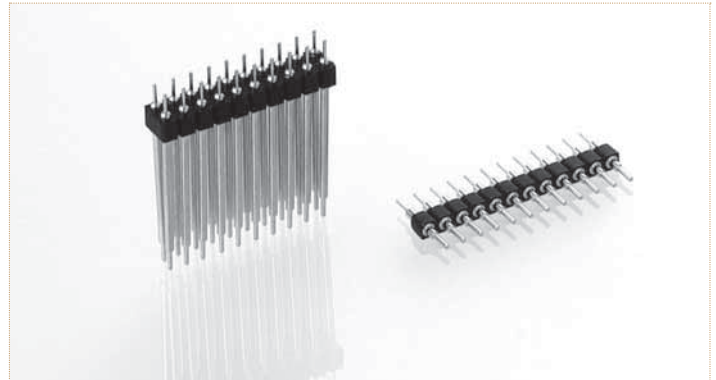

Other plating on request (see page 178 for plating specs).

**NN number of poles.** Replace **NN** with the requested number of poles, e.g. 451-10-2**NN**-00-003101 for a double row version with 8 pins becomes 451-10-2**08**-00-003101.

### 351-PP-1NN-00-XXX101

Straight interconnect pin connector, solder tail, single row

AVAILABILITY FROM 2 to 64 contacts  
(standard number of contacts: 64)

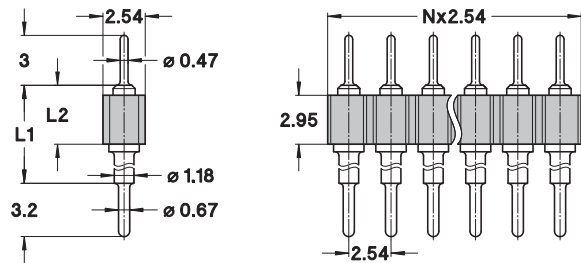

### 451-PP-2NN-00-XXX101

Straight interconnect pin connector, solder tail, double row

AVAILABILITY FROM 4 to 72 contacts  
(standard number of contacts: 72)

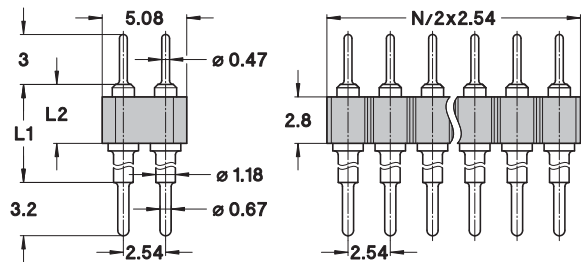

## AVAILABLE CONTACT LENGTHS

CONTACT LENGTH		XXX CODE
L1 (mm)	L2 (mm)	
6.2	4.7	003
8.4	3.55	004
15.3	3.55	005
21.2	3.55	016
27.4	3.55	017

Other lengths on request



preci-dip

WWW.PRECIDIP.COM TEL +41 32 421 04 00 SALES@PRECIDIP.COM

# PIN CONNECTORS 2.54 mm

CONNECTING PIN Ø 0.47 mm / SINGLE ROW / DOUBLE ROW  
SOLDER TAIL / RIGHT ANGLE

Right angle pin connectors, solder tail.

## TECHNICAL SPECIFICATIONS (FOR GENERAL SPECS, SEE PAGE 43)

INSULATOR	Black glass filled polyester PCT-GF30-FR
FLAMMABILITY	UL 94V-0
CONTACT	Brass CuZn36Pb3 (C36000)
CONNECTING PIN Ø	0.47 mm
MECHANICAL LIFE	Min. 500 cycles
RATED CURRENT	3 A
DIELECTRIC STRENGTH	Min. 1'000 V <sub>RMS</sub>

For corresponding socket connectors, see pages 69-84.

## ORDERING INFORMATION ROHS COMPLIANT PARTS

PP PLATING CODE	TERMINATION	CONNECTING PIN
10	0.25 µm gold	0.25 µm gold
80	Tin	Tin
V3	Tin	0.75 µm gold

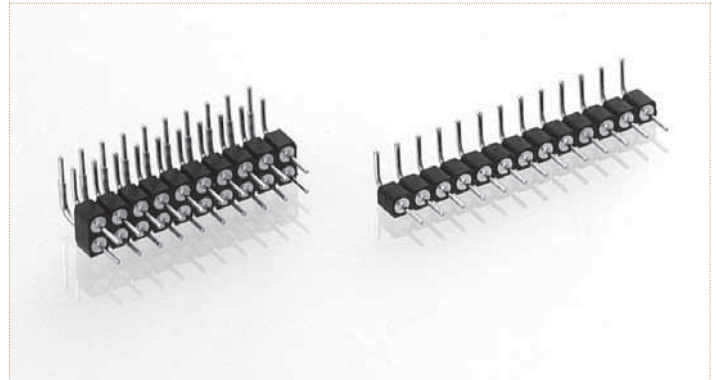

Other plating on request (see page 178 for plating specs).

**NN number of poles.** Replace **NN** with the requested number of poles, e.g. 499-10-2**NN**-10-009101 for a double row version with 8 pins becomes 499-10-2**08**-10-009101.

### 399-PP-1NN-10-009101

Right angle pin connector, solder tail, single row

AVAILABILITY FROM 2 to 64 contacts  
(standard number of contacts: 64)

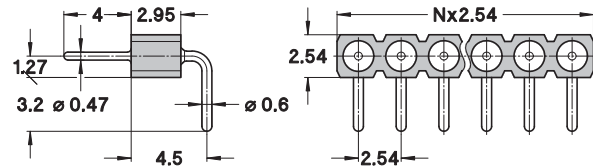

### 499-PP-2NN-10-009101

Right angle pin connector, solder tail, double row

AVAILABILITY FROM 4 to 72 contacts  
(standard number of contacts: 72)

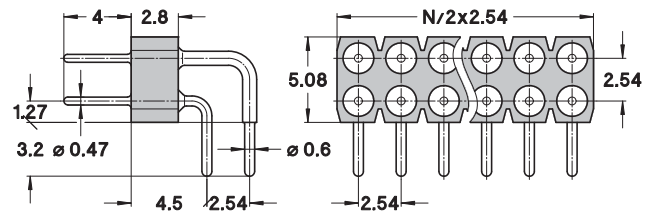



preci-dip

WWW.PRECIDIP.COM TEL +41 32 421 04 00 SALES@PRECIDIP.COM

# PIN CONNECTORS 2.54 mm

CONNECTING PIN Ø 0.47 mm / SINGLE ROW / DOUBLE ROW  
SURFACE MOUNT

Pin connectors, SMD.

## TECHNICAL SPECIFICATIONS (FOR GENERAL SPECS, SEE PAGE 43)

<b>INSULATOR</b>	Black glass filled polyester PCT-GF30-FR
<b>FLAMMABILITY</b>	UL 94V-0
<b>CONTACT</b>	Brass CuZn36Pb3 (C36000)
<b>CONNECTING PIN Ø</b>	0.47 mm
<b>MECHANICAL LIFE</b>	Min. 500 cycles
<b>RATED CURRENT</b>	3 A
<b>DIELECTRIC STRENGTH</b>	Min. 1'000 V <sub>RMS</sub>
<b>COPLANARITY SMD TERMINATIONS</b>	Max. 0.1 mm (measured on 25 mm long connectors)

For corresponding socket connectors, see pages 69-84.

## ORDERING INFORMATION ROHS COMPLIANT PARTS

PP PLATING CODE	TERMINATION	CONNECTING PIN
10	0.25 µm gold	0.25 µm gold
80	Tin	Tin
V3*	Tin	0.75 µm gold

\*only for 350/450...00-106101 series

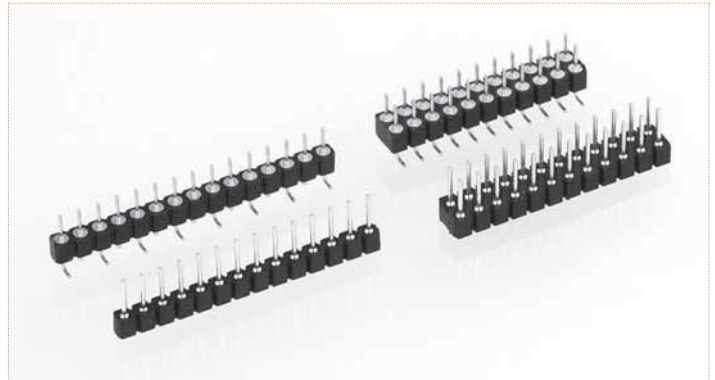

Other plating on request (see page 178 for plating specs).

**NN number of poles.** Replace NN with the requested number of poles, e.g. 350-10-1NN-00-106101 for a single row version with 8 pins becomes 350-10-108-00-106101.

**Bulk:** **T & R Packaging with pick & place cap\*:**  
350-PP-1NN-01-899101 350-PP-1NN-01-899191

SMD pin connector, low profile, single row, perpendicular mount with self-levelling floating contacts

**AVAILABILITY FROM** 2 to 64 contacts  
(standard number of contacts: 64)  
For connectors having more than 9 contacts, the coplanarity issue is to be addressed specifically

\*Please consult [www.precidip.com](http://www.precidip.com) for availability size of tape, size of reel, number of components per reel and packing units.

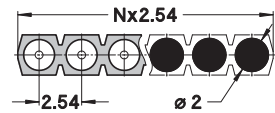
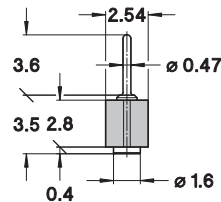

**Bulk:** **T & R Packaging with pick & place cap\*:**  
450-PP-2NN-01-899101 450-PP-2NN-01-899191

SMD pin connector, low profile, double row, perpendicular mount with self-levelling floating contacts

**AVAILABILITY FROM** 4 to 72 contacts  
(standard number of contacts: 72)  
For connectors having more than 9 contacts per row, the coplanarity issue is to be addressed specifically

\*Please consult [www.precidip.com](http://www.precidip.com) for availability size of tape, size of reel, number of components per reel and packing units.

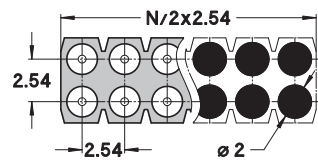
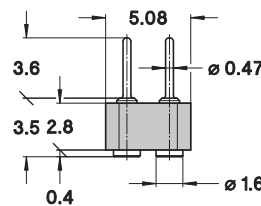

**Bulk:** **T & R Packaging with pick & place cap\*:**  
350-PP-1NN-00-106101 350-PP-1NN-00-106191

SMD pin connector, single row, perpendicular mount with gull-wing terminations

**AVAILABILITY FROM** 3 to 64 contacts  
(standard number of contacts: 64)  
For connectors having more than 9 contacts, the coplanarity issue is to be addressed specifically

\*Please consult [www.precidip.com](http://www.precidip.com) for availability size of tape, size of reel, number of components per reel and packing units.

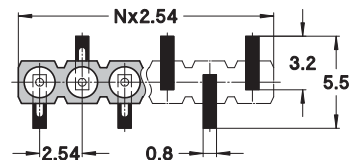
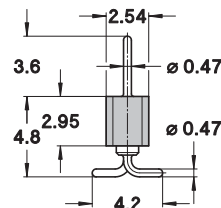

**Bulk:** **T & R Packaging with pick & place cap\*:**  
450-PP-2NN-00-106101 450-PP-2NN-00-106191

SMD pin connector, double row, perpendicular mount with gull-wing terminations

**AVAILABILITY FROM** 4 to 72 contacts  
(standard number of contacts: 72)  
For connectors having more than 9 contacts per row, the coplanarity issue is to be addressed specifically

\*Please consult [www.precidip.com](http://www.precidip.com) for availability size of tape, size of reel, number of components per reel and packing units.

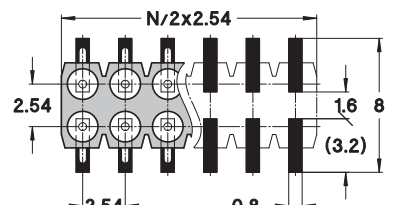
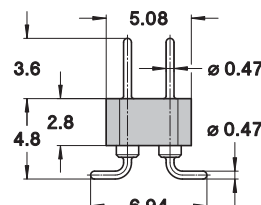



preci-dip

WWW.PRECIDIP.COM TEL +41 32 421 04 00 SALES@PRECIDIP.COM

# PIN CONNECTORS 2.54 mm

CONNECTING PIN Ø 0.47 mm / SINGLE ROW / SURFACE MOUNT

Pin connectors, SMD.

## TECHNICAL SPECIFICATIONS (FOR GENERAL SPECS, SEE PAGE 43)

INSULATOR	Black glass filled polyester PCT-GF30-FR
FLAMMABILITY	UL 94V-0
CONTACT	Brass CuZn36Pb3 (C36000)
CONNECTING PIN Ø	0.47 mm
MECHANICAL LIFE	Min. 500 cycles
RATED CURRENT	3 A
DIELECTRIC STRENGTH	Min. 1'000 V <sub>RMS</sub>
COPLANARITY	
SMD TERMINATIONS	Max. 0.1 mm (measured on 25 mm long connectors)

For corresponding socket connectors, see pages 69-84.

## ORDERING INFORMATION ROHS COMPLIANT PARTS

PP PLATING CODE	TERMINATION	CONNECTING PIN
10	0.25 µm gold	0.25 µm gold
80	Tin	Tin



Other plating on request (see page 178 for plating specs).

**NN number of poles.** Replace **NN** with the requested number of poles, e.g. 350-10-1**NN**-00-206101 for a single row version with 8 pins becomes 350-10-1**08**-00-206101.

**Bulk:** 350-PP-1**NN**-00-206101      **T & R Packaging\*:** 350-PP-1**NN**-00-206191

SMD pin connector, single row, parallel mount

**AVAILABILITY FROM** 2 to 64 contacts  
(standard number of contacts: 64)  
For connectors having more than 9 contacts, the coplanarity issue is to be addressed specifically

\*Please consult [www.precidip.com](http://www.precidip.com) for availability size of tape, size of reel, number of components per reel and packing units.

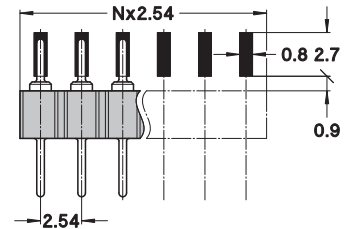
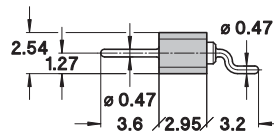





preci-dip

WWW.PRECIDIP.COM TEL +41 32 421 04 00 SALES@PRECIDIP.COM

# PIN CONNECTORS 2.54 mm

CONNECTING PIN Ø 0.47 mm / SINGLE ROW / DOUBLE ROW / PRESS-FIT

Pin connectors, press-fit with compliant pin for solderless mount in PCB plated through holes.

## TECHNICAL SPECIFICATIONS (FOR GENERAL SPECS, SEE PAGE 43)

INSULATOR	Black glass filled polyester PCT-GF30-FR
FLAMMABILITY	UL 94V-0
CONTACT	Bronze CuSn4Pb4Zn4 (C54400)
CONNECTING PIN Ø	0.47 mm
MECHANICAL LIFE	Min. 500 cycles
RATED CURRENT	3 A
DIELECTRIC STRENGTH	Min. 1'000 V <sub>RMS</sub>
PCB HOLE Ø	1 mm +0.09/-0.06 mm finished (1.15 ±0.025 mm drill)

For corresponding socket connectors, see pages 69-84.

## ORDERING INFORMATION ROHS COMPLIANT PARTS

PP PLATING CODE	TERMINATION	CONNECTING PIN
V3	Tin	0.75 µm gold

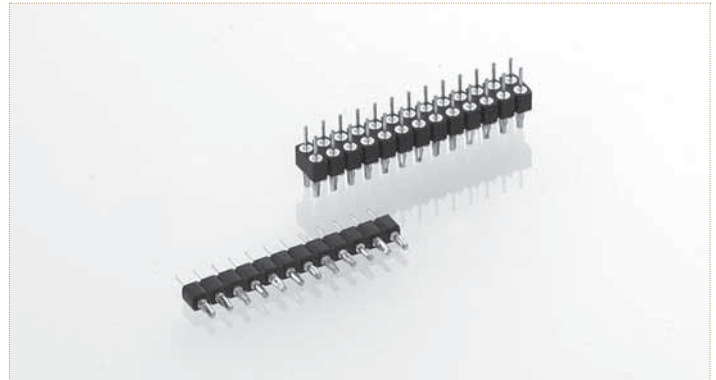

Other plating on request (see page 178 for plating specs).

**NN number of poles.** Replace **NN** with the requested number of poles, e.g. 356-V3-1**NN**-00-014101 for a single row version with 8 pins becomes 356-V3-**108**-00-014101.

### 356-V3-1**NN**-00-014101

Press-fit pin connector, single row, compliant pin for PCB thickness 1.5 to 2.5 mm

AVAILABILITY FROM 2 to 64 contacts  
(standard number of contacts: 64)

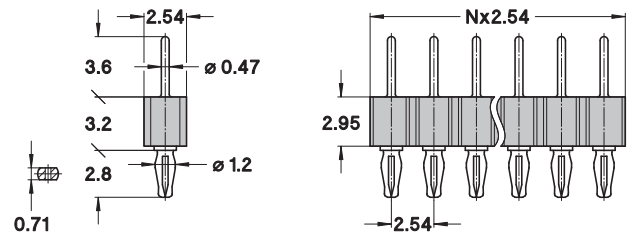

### 456-V3-2**NN**-00-014101

Press-fit pin connector, double row, compliant pin for PCB thickness 1.5 to 2.5 mm

AVAILABILITY FROM 4 to 72 contacts  
(standard number of contacts: 72)

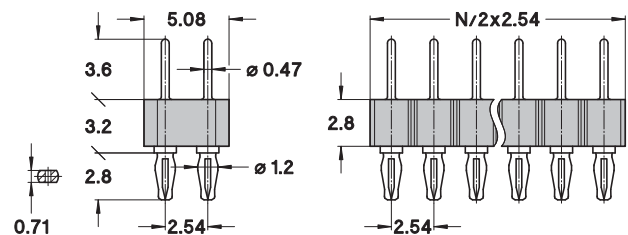



preci-dip

WWW.PRECIDIP.COM TEL +41 32 421 04 00 SALES@PRECIDIP.COM

# PIN CONNECTORS 2.54 mm

CONNECTING PIN Ø 0.76 mm / SINGLE ROW / DOUBLE ROW  
SOLDER TAIL

Pin connectors, solder tail.

## TECHNICAL SPECIFICATIONS (FOR GENERAL SPECS, SEE PAGE 43)

INSULATOR	Black glass filled polyester PCT-GF30-FR
FLAMMABILITY	UL 94V-0
CONTACT	Brass CuZn36Pb3 (C36000)
CONNECTING PIN Ø	0.76 mm
MECHANICAL LIFE	Min. 500 cycles
RATED CURRENT	3 A
DIELECTRIC STRENGTH	Min. 1'000 V <sub>RMS</sub>

For corresponding socket connectors, see pages 85-99.

## ORDERING INFORMATION ROHS COMPLIANT PARTS

PP PLATING CODE	TERMINATION	CONNECTING PIN
10	0.25 µm gold	0.25 µm gold
80	Tin	Tin

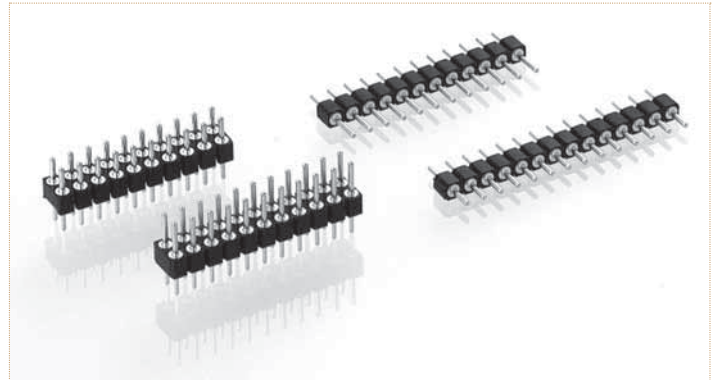

Other plating on request (see page 178 for plating specs).

**NNN number of poles.** Replace **NNN** with the requested number of poles, e.g. 800-10-**NNN**-10-001101 for a single row version with 8 pins becomes 800-10-**008**-10-001101.

### 800-PP-NNN-10-002101

Straight pin connector, height 3.2 mm, short pin, solder tail, single row

AVAILABILITY FROM 2 to 64 contacts  
(standard number of contacts: 64)

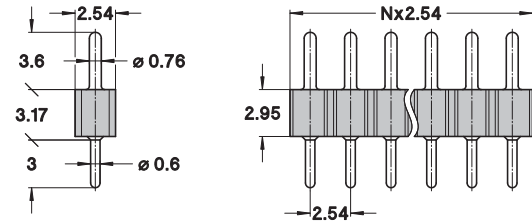

### 802-PP-NNN-10-002101

Straight pin connector, height 3.2 mm, short pin, solder tail, double row

AVAILABILITY FROM 4 to 72 contacts  
(standard number of contacts: 72)

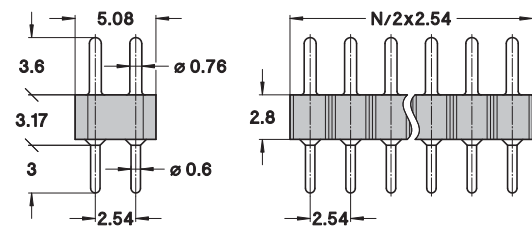

### 800-PP-NNN-10-001101

Straight pin connector, height 3.2 mm, long pin, solder tail, single row

AVAILABILITY FROM 2 to 64 contacts  
(standard number of contacts: 64)  
Option: partially equipped 5.08 mm connector  
PN 800-PP-YYY-10-101101 available on request

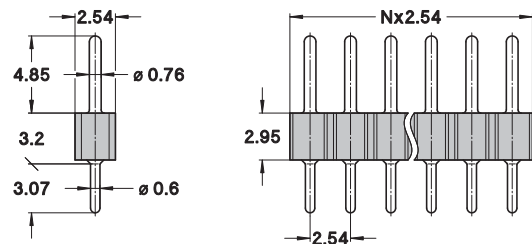

### 802-PP-NNN-10-001101

Straight pin connector, height 3.2 mm, long pin, solder tail, double row

AVAILABILITY FROM 4 to 72 contacts  
(standard number of contacts: 72)

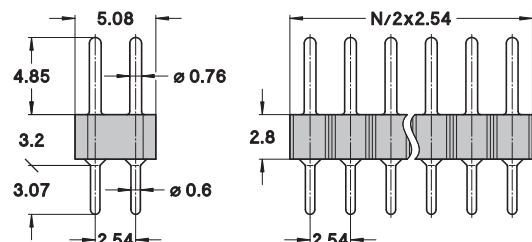



preci-dip

WWW.PRECIDIP.COM TEL +41 32 421 04 00 SALES@PRECIDIP.COM

# PIN CONNECTORS 2.54 mm

CONNECTING PIN Ø 0.76 mm / SINGLE ROW / DOUBLE ROW / TRIPLE ROW  
SOLDER TAIL

Pin connectors, solder tail.

## TECHNICAL SPECIFICATIONS (FOR GENERAL SPECS, SEE PAGE 43)

INSULATOR	Black glass filled polyester PCT-GF30-FR
FLAMMABILITY	UL 94V-0
CONTACT	Brass CuZn36Pb3 (C36000)
CONNECTING PIN Ø	0.76 mm
MECHANICAL LIFE	Min. 500 cycles
RATED CURRENT	3 A
DIELECTRIC STRENGTH	Min. 1'000 V <sub>RMS</sub>

For corresponding socket connectors, see pages 85-99.

## ORDERING INFORMATION ROHS COMPLIANT PARTS

PP PLATING CODE	TERMINATION	CONNECTING PIN
10	0.25 µm gold	0.25 µm gold
80	Tin	Tin
V3*	Tin	0.75 µm gold

\*only for 802/804...10-193101 series

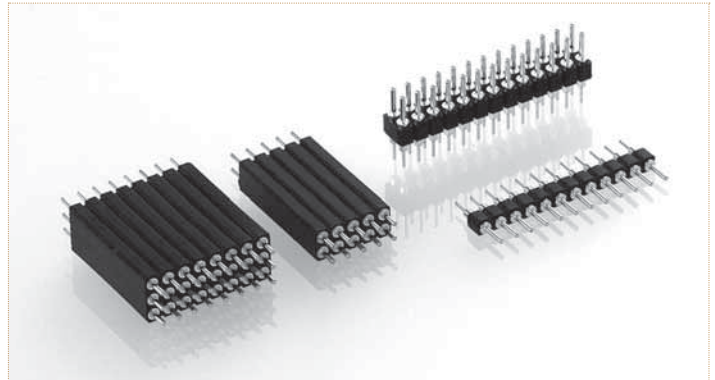

Other plating on request (see page 178 for plating specs).

**NNN number of poles.** Replace **NNN** with the requested number of poles, e.g. 802-10-**NNN**-10-193101 for a double row version with 16 pins becomes 802-10-**016**-10-193101.

### 350-PP-1NN-00-018101

Straight pin connector, height 4.75 mm, solder tail, single row

AVAILABILITY FROM 2 to 64 contacts  
(standard number of contacts: 64)

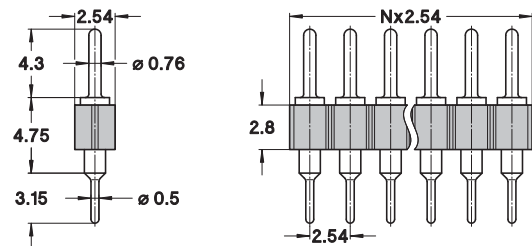

### 450-PP-2NN-00-018101

Straight pin connector, height 4.75 mm, solder tail, double row

AVAILABILITY FROM 4 to 72 contacts  
(standard number of contacts: 72)

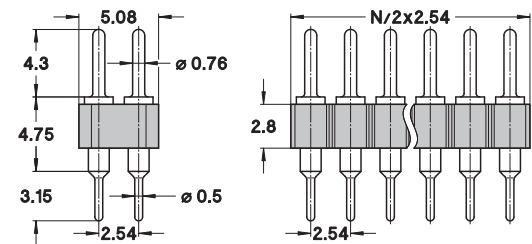

### 802-V3-NNN-10-193101

Straight pin connector, height 21.2 mm, solder tail, double row

AVAILABILITY FROM 4 to 64 contacts  
(standard number of contacts: 64)

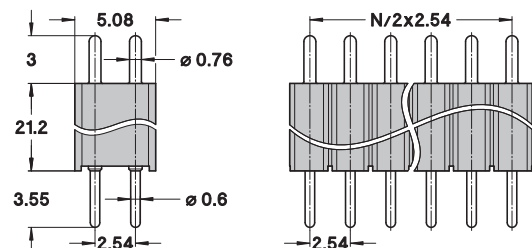

### 804-V3-NNN-10-193101

Straight pin connector, height 21.2 mm, solder tail, triple row

AVAILABILITY FROM 9 to 96 contacts  
(standard number of contacts: 96)

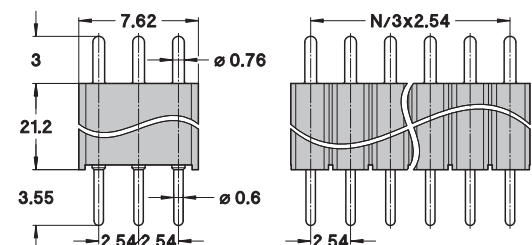



precidip

WWW.PRECIDIP.COM TEL +41 32 421 04 00 SALES@PRECIDIP.COM

# PIN CONNECTORS 2.54 mm

CONNECTING PIN Ø 0.76 mm / SINGLE ROW / DOUBLE ROW / TRIPLE ROW  
SOLDER TAIL

Shrouded pin connectors, solder tail.

## TECHNICAL SPECIFICATIONS (FOR GENERAL SPECS, SEE PAGE 43)

INSULATOR	Black glass filled polyester PCT-GF30-FR
FLAMMABILITY	UL 94V-0
CONTACT	Brass CuZn36Pb3 (C36000)
CONNECTING PIN Ø	0.76 mm
MECHANICAL LIFE	Min. 500 cycles
RATED CURRENT	3 A
DIELECTRIC STRENGTH	Min. 1'000 V <sub>RMS</sub>

For corresponding socket connectors, see pages 85-99.

## ORDERING INFORMATION ROHS COMPLIANT PARTS

PP PLATING CODE	TERMINATION	CONNECTING PIN
V3	Tin	0.75 µm gold

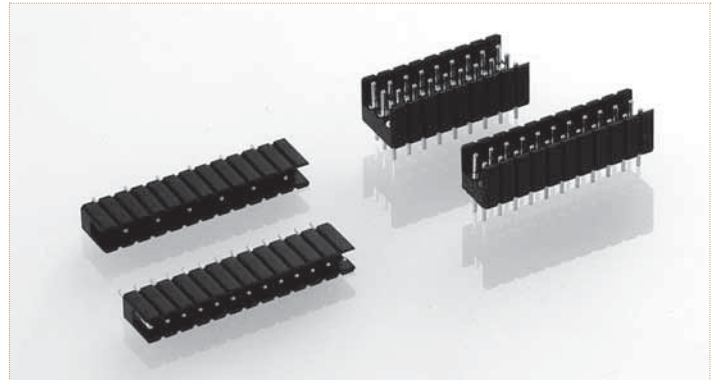

Other plating on request (see page 178 for plating specs).

**NNN number of poles.** Replace **NNN** with the requested number of poles, e.g. 800-V3-**NNN**-12-002101 for a single row version with 8 pins becomes 800-V3-**008**-12-002101.

### 800-V3-**NNN**-12-002101

Straight shrouded pin connector, solder tail, single row

AVAILABILITY FROM 2 to 32 contacts  
(standard number of contacts: 32)

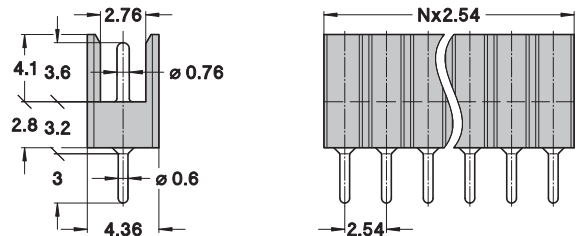

### 802-V3-**NNN**-12-002101

Straight shrouded pin connector, solder tail, double row

AVAILABILITY FROM 4 to 64 contacts  
(standard number of contacts: 64)

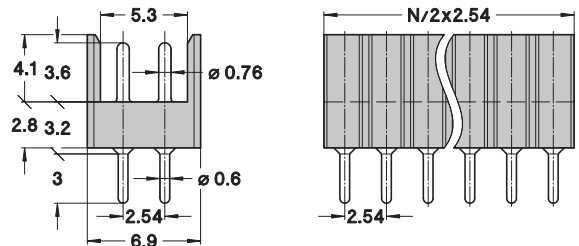

### 804-V3-**NNN**-12-002101

Straight shrouded pin connector, solder tail, triple row

AVAILABILITY FROM 9 to 96 contacts  
(standard number of contacts: 96)

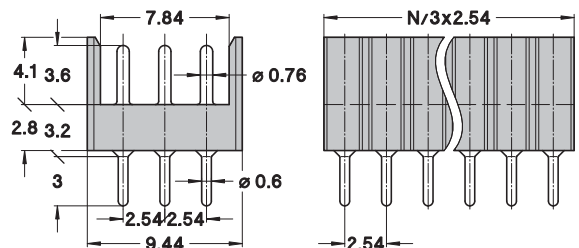

### 800-V3-**YYY**-12-422101

Straight shrouded pin connector, solder tail, single row, partially equipped 5.08 mm

AVAILABILITY FROM 2 to 16 contacts  
**YYY number of poles:**  
please consult for ordering code

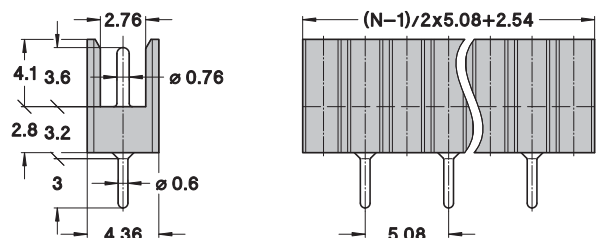



preci-dip

WWW.PRECIDIP.COM TEL +41 32 421 04 00 SALES@PRECIDIP.COM

# PIN CONNECTORS 2.54 mm

CONNECTING PIN Ø 0.76 mm / SINGLE ROW / DOUBLE ROW  
SOLDER TAIL / RIGHT ANGLE

Right angle pin connectors, solder tail.

## TECHNICAL SPECIFICATIONS (FOR GENERAL SPECS, SEE PAGE 43)

INSULATOR	Black glass filled polyester PCT-GF30-FR
FLAMMABILITY	UL 94V-0
CONTACT	Brass CuZn36Pb3 (C36000)
CONNECTING PIN Ø	0.76 mm
MECHANICAL LIFE	Min. 500 cycles
RATED CURRENT	3 A
DIELECTRIC STRENGTH	Min. 1'000 V <sub>RMS</sub>

For corresponding socket connectors, see pages 85-99.

## ORDERING INFORMATION ROHS COMPLIANT PARTS

PP PLATING CODE	TERMINATION	CONNECTING PIN
10	0.25 µm gold	0.25 µm gold
80	Tin	Tin
V3	Tin	0.75 µm gold

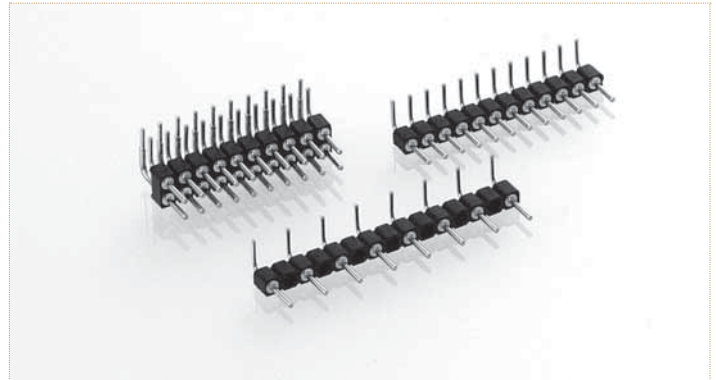

Other plating on request (see page 178 for plating specs).

**NNN number of poles.** Replace **NNN** with the requested number of poles, e.g. 800-10-**NNN**-20-001101 for a single row version with 8 pins becomes 800-10-**008**-20-001101.

### 800-PP-NNN-20-001101

Right angle pin connector, solder tail, single row

AVAILABILITY FROM 2 to 64 contacts  
(standard number of contacts: 64)

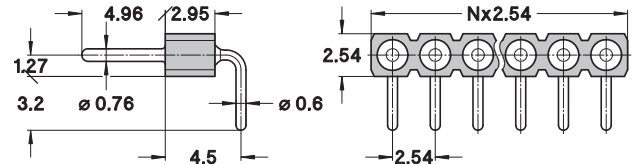

### 802-PP-NNN-20-001101

Right angle pin connector, solder tail, double row

AVAILABILITY FROM 4 to 72 contacts  
(standard number of contacts: 72)

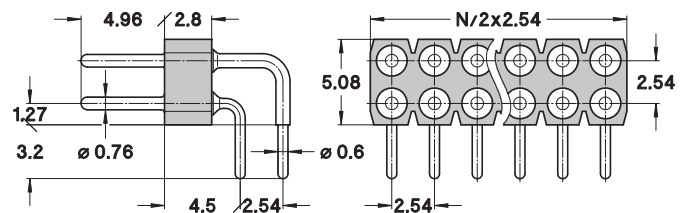

### 800-PP-YYY-20-101101

Right angle pin connector, solder tail, single row, partially equipped 5.08 mm

AVAILABILITY FROM 2 to 32 contacts  
**YYY number of poles:**  
please consult for ordering code

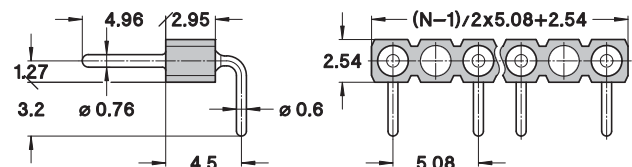





preci-dip

WWW.PRECIDIP.COM TEL +41 32 421 04 00 SALES@PRECIDIP.COM

# PIN CONNECTORS 2.54 mm

CONNECTING PIN Ø 0.76 / 1 mm / SINGLE ROW / DOUBLE ROW  
TRIPLE ROW / SOLDER TAIL / RIGHT ANGLE

Right angle pin connectors, solder tail.

## TECHNICAL SPECIFICATIONS (FOR GENERAL SPECS, SEE PAGE 43)

INSULATOR	Black glass filled polyester PCT-GF30-FR
FLAMMABILITY	UL 94V-0
CONTACT	Brass CuZn36Pb3 (C36000)
CONNECTING PIN Ø	0.76 mm / 1 mm
MECHANICAL LIFE	Min. 500 cycles
RATED CURRENT	3 A
DIELECTRIC STRENGTH	Min. 1'000 V <sub>RMS</sub>

For corresponding socket connectors, see pages 85-100.

## ORDERING INFORMATION ROHS COMPLIANT PARTS

PP PLATING CODE	TERMINATION	CONNECTING PIN
10*	0.25 µm gold	0.25 µm gold
80*	Tin	Tin
V3	Tin	0.75 µm gold

\*only for 800...-20-004101 series

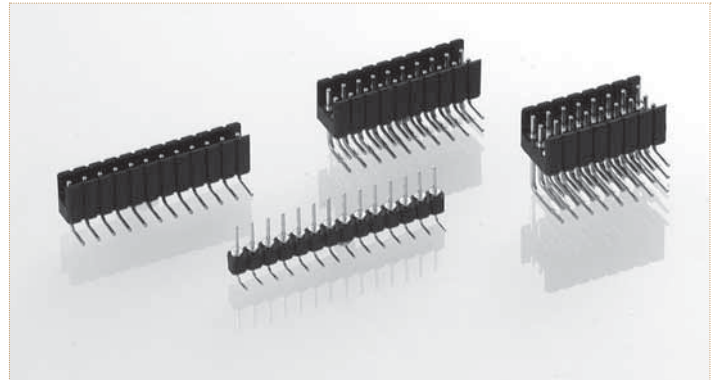

Other plating on request (see page 178 for plating specs).

**NNN number of poles.** Replace **NNN** with the requested number of poles, e.g. 800-V3-**NNN**-22-002101 for a single row version with 8 pins becomes 800-V3-**008**-22-002101.

### 800-V3-**NNN**-22-002101

Right angle shrouded pin connector, solder tail, single row

AVAILABILITY FROM 2 to 32 contacts  
(standard number of contacts: 32)

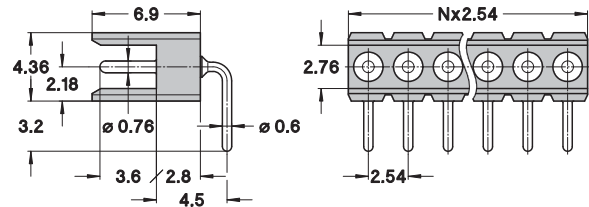

### 802-V3-**NNN**-22-002101

Right angle shrouded pin connector, solder tail, double row

AVAILABILITY FROM 4 to 64 contacts  
(standard number of contacts: 64)

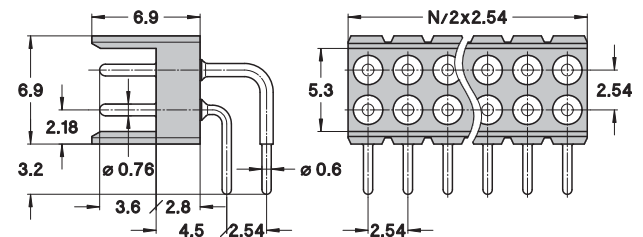

### 804-V3-**NNN**-22-002101

Right angle shrouded pin connector, solder tail, triple row

AVAILABILITY FROM 9 to 96 contacts  
(standard number of contacts: 96)

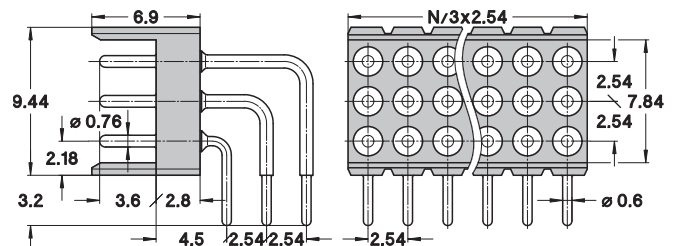

### 800-PP-**NNN**-20-004101

Right angle pin connector Ø 1 mm, solder tail, single row

AVAILABILITY FROM 2 to 64 contacts  
(standard number of contacts: 64)

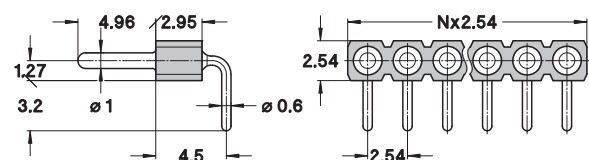



preci-dip

WWW.PRECIDIP.COM TEL +41 32 421 04 00 SALES@PRECIDIP.COM

# PIN CONNECTORS 2.54 mm

CONNECTING PIN Ø 0.76 mm / SINGLE ROW / DOUBLE ROW  
SURFACE MOUNT

Pin connectors, SMD.

## TECHNICAL SPECIFICATIONS (FOR GENERAL SPECS, SEE PAGE 43)

<b>INSULATOR</b>	Black glass filled polyester PCT-GF30-FR
<b>FLAMMABILITY</b>	UL 94V-0
<b>CONTACT</b>	Brass CuZn36Pb3 (C36000)
<b>CONNECTING PIN Ø</b>	0.76 mm
<b>MECHANICAL LIFE</b>	Min. 500 cycles
<b>RATED CURRENT</b>	3 A
<b>DIELECTRIC STRENGTH</b>	Min. 1'000 V <sub>RMS</sub>
<b>COPLANARITY SMD TERMINATIONS</b>	Max. 0.1 mm (measured on 25 mm long connectors)

For corresponding socket connectors, see pages 85-99.

## ORDERING INFORMATION ROHS COMPLIANT PARTS

PP PLATING CODE	TERMINATION	CONNECTING PIN
10	0.25 µm gold	0.25 µm gold
80	Tin	Tin
V3*	Tin	0.75 µm gold

\*only for 800/802...30-001101 series

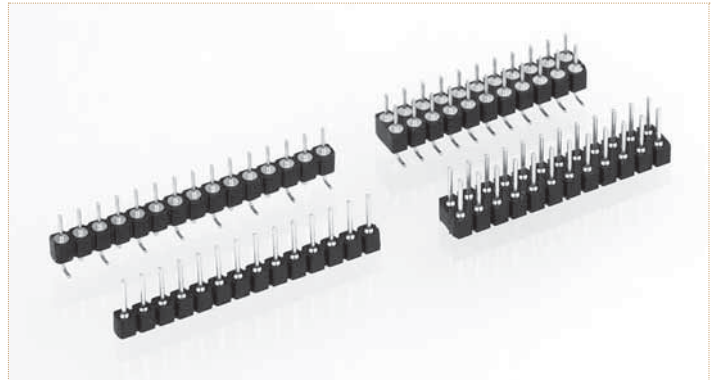

Other plating on request (see page 178 for plating specs).

**NNN number of poles.** Replace **NNN** with the requested number of poles, e.g. 800-10-**NNN**-30-001101 for a single row version with 8 pins becomes 800-10-**008**-30-001101.

**Bulk:** **T & R Packaging with pick & place cap\*:**  
800-PP-**NNN**-30-480101 800-PP-**NNN**-30-480191

SMD pin connector, low profile, single row, perpendicular mount with self-levelling floating contacts

**AVAILABILITY FROM** 2 to 64 contacts  
(standard number of contacts: 64)  
For connectors having more than 9 contacts, the coplanarity issue is to be addressed specifically

\*Please consult [www.precidip.com](http://www.precidip.com) for availability size of tape, size of reel, number of components per reel and packing units.

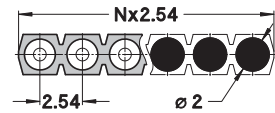
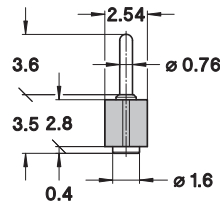

**Bulk:** **T & R Packaging with pick & place cap\*:**  
802-PP-**NNN**-30-480101 802-PP-**NNN**-30-480191

SMD pin connector, low profile, double row, perpendicular mount with self-levelling floating contacts

**AVAILABILITY FROM** 4 to 64 contacts  
(standard number of contacts: 64)  
For connectors having more than 9 contacts per row, the coplanarity issue is to be addressed specifically

\*Please consult [www.precidip.com](http://www.precidip.com) for availability size of tape, size of reel, number of components per reel and packing units.

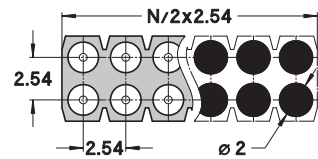
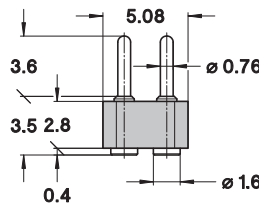

**Bulk:** **T & R Packaging with pick & place cap\*:**  
800-PP-**NNN**-30-001101 800-PP-**NNN**-30-001191

SMD pin connector, single row, perpendicular mount with gull-wing terminations

**AVAILABILITY FROM** 3 to 64 contacts  
(standard number of contacts: 64)  
For connectors having more than 9 contacts, the coplanarity issue is to be addressed specifically

\*Please consult [www.precidip.com](http://www.precidip.com) for availability size of tape, size of reel, number of components per reel and packing units.

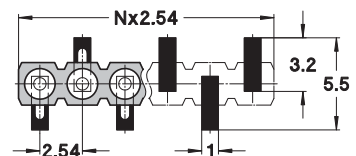
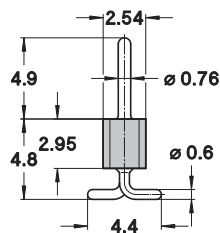

**Bulk:** **T & R Packaging with pick & place cap\*:**  
802-PP-**NNN**-30-001101 802-PP-**NNN**-30-001191

SMD pin connector, double row, perpendicular mount with gull-wing terminations

**AVAILABILITY FROM** 4 to 72 contacts  
(standard number of contacts: 72)  
For connectors having more than 9 contacts per row, the coplanarity issue is to be addressed specifically

\*Please consult [www.precidip.com](http://www.precidip.com) for availability size of tape, size of reel, number of components per reel and packing units.

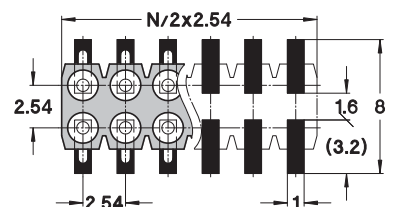
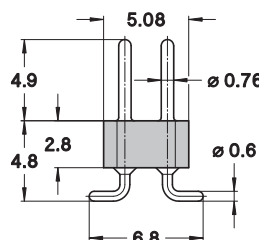

Due to technical progress, all information provided is subject to change without prior notice.



preci-dip

WWW.PRECIDIP.COM TEL +41 32 421 04 00 SALES@PRECIDIP.COM

# PIN CONNECTORS 2.54 mm

CONNECTING PIN Ø 0.76 mm / SINGLE ROW / DOUBLE ROW  
SURFACE MOUNT

Pin connectors, SMD.

## TECHNICAL SPECIFICATIONS (FOR GENERAL SPECS, SEE PAGE 43)

INSULATOR	Black glass filled polyester PCT-GF30-FR
FLAMMABILITY	UL 94V-0
CONTACT	Brass CuZn36Pb3 (C36000)
CONNECTING PIN Ø	0.76 mm
MECHANICAL LIFE	Min. 500 cycles
RATED CURRENT	3 A
DIELECTRIC STRENGTH	Min. 1'000 V <sub>RMS</sub>
COPLANARITY	
SMD TERMINATIONS	Max. 0.1 mm (measured on 25 mm long connectors)

For corresponding socket connectors, see pages 85-99.

## ORDERING INFORMATION ROHS COMPLIANT PARTS

PP PLATING CODE	TERMINATION	CONNECTING PIN
V3	Tin	0.75 µm gold

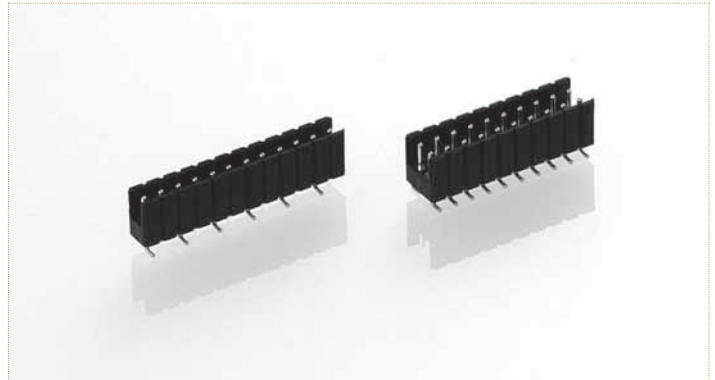

Other plating on request (see page 178 for plating specs).

**NNN number of poles.** Replace **NNN** with the requested number of poles, e.g. 800-V3-**NNN**-32-002101 for a single row version with 8 pins becomes 800-V3-**008**-32-002101.

**Bulk:** **T & R Packaging with pick & place cap\* :**  
800-V3-**NNN**-32-002101 800-V3-**NNN**-32-002191

SMD shrouded pin connector, single row, perpendicular mount with gull-wing terminations

**AVAILABILITY FROM** 3 to 32 contacts  
(standard number of contacts: 32)  
For connectors having more than 9 contacts, the coplanarity issue is to be addressed specifically

\*Please consult [www.precidip.com](http://www.precidip.com) for availability size of tape, size of reel, number of components per reel and packing units.

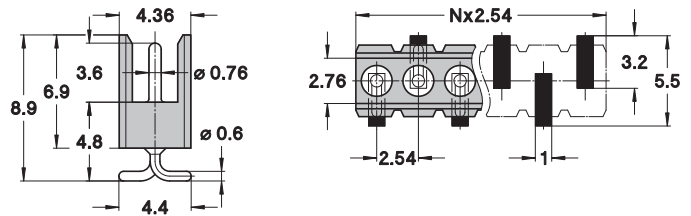

**Bulk:** **T & R Packaging with pick & place cap\* :**  
802-V3-**NNN**-32-002101 802-V3-**NNN**-32-002191

SMD shrouded pin connector, double row, perpendicular mount with gull-wing terminations

**AVAILABILITY FROM** 4 to 64 contacts  
(standard number of contacts: 64)  
For connectors having more than 9 contacts per row, the coplanarity issue is to be addressed specifically

\*Please consult [www.precidip.com](http://www.precidip.com) for availability size of tape, size of reel, number of components per reel and packing units.

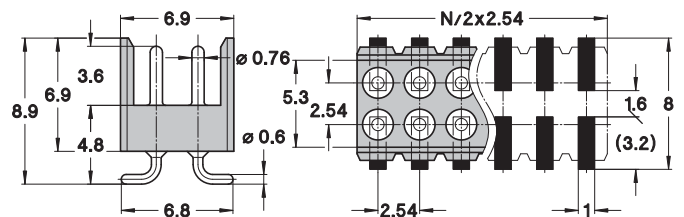



preci-dip

WWW.PRECIDIP.COM TEL +41 32 421 04 00 SALES@PRECIDIP.COM

# PIN CONNECTORS 2.54 mm

CONNECTING PIN Ø 0.76 mm / SINGLE ROW / SURFACE MOUNT

Pin connectors, SMD.

## TECHNICAL SPECIFICATIONS (FOR GENERAL SPECS, SEE PAGE 43)

INSULATOR	Black glass filled polyester PCT-GF30-FR
FLAMMABILITY	UL 94V-0
CONTACT	Brass CuZn36Pb3 (C36000)
CONNECTING PIN Ø	0.76 mm
MECHANICAL LIFE	Min. 500 cycles
RATED CURRENT	3 A
DIELECTRIC STRENGTH	Min. 1'000 V <sub>RMS</sub>
COPLANARITY SMD TERMINATIONS	Max. 0.1 mm (measured on 25 mm long connectors)

For corresponding socket connectors, see pages 85-99.

## ORDERING INFORMATION ROHS COMPLIANT PARTS

PP PLATING CODE	TERMINATION	CONNECTING PIN
11	0.25 µm gold	0.25 µm gold
10*	0.25 µm gold	0.25 µm gold
80*	Tin	Tin

\*only for 800...40-001101 series

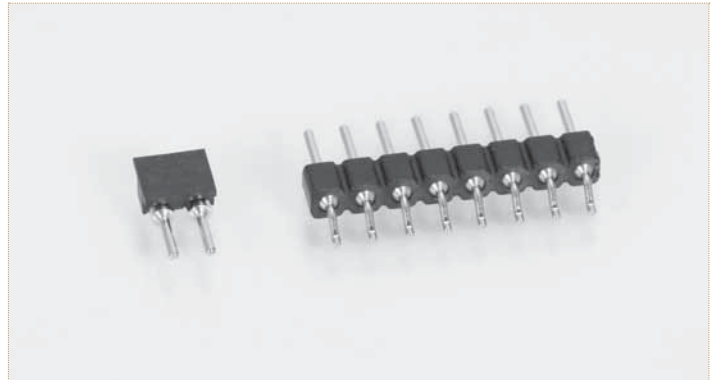

Other plating on request (see page 178 for plating specs).

**NNN number of poles.** Replace **NNN** with the requested number of poles, e.g. 800-10-**NNN**-40-001101 for a single row version with 8 pins becomes 800-10-**008**-40-001101.

**Bulk:** **T & R Packaging with pick & place cap\*:**  
8MM-11-**ONNN**-02-279 8MM-11-**ONNN**-02-279191

SMD pin connector, single row, parallel mount low profile minimum PCB space requirement

**AVAILABILITY FROM** 2 to 10 contacts  
(standard number of contacts: 10)  
For connectors having more than 9 contacts, the coplanarity issue is to be addressed specifically

\*Please consult [www.precidip.com](http://www.precidip.com) for availability size of tape, size of reel, number of components per reel and packing units.

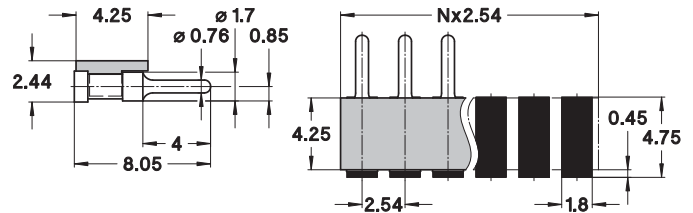

**Bulk:** **T & R Packaging\*:**  
800-**PP**-**NNN**-40-001101 800-**PP**-**NNN**-40-001191

SMD pin connector, single row, parallel mount

**AVAILABILITY FROM** 2 to 64 contacts  
(standard number of contacts: 64)  
For connectors having more than 9 contacts, the coplanarity issue is to be addressed specifically

\*Please consult [www.precidip.com](http://www.precidip.com) for availability size of tape, size of reel, number of components per reel and packing units.

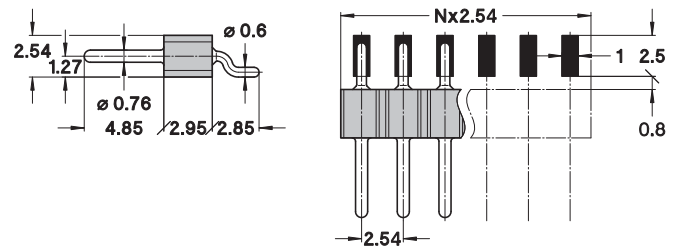



preci-dip

WWW.PRECIDIP.COM TEL +41 32 421 04 00 SALES@PRECIDIP.COM

# PIN CONNECTORS 2.54 mm

CONNECTING PIN Ø 0.76 mm / SINGLE ROW / DOUBLE ROW / PRESS-FIT

Pin connectors, press-fit with compliant pin for solderless mount in PCB plated through holes.

## TECHNICAL SPECIFICATIONS (FOR GENERAL SPECS, SEE PAGE 43)

INSULATOR	Black glass filled polyester PCT-GF30-FR
FLAMMABILITY	UL 94V-0
CONTACT	Bronze CuSn4Pb4Zn4 (C54400)
CONNECTING PIN Ø	0.76 mm
MECHANICAL LIFE	Min. 500 cycles
RATED CURRENT	3 A
DIELECTRIC STRENGTH	Min. 1'000 V <sub>RMS</sub>
PCB HOLE Ø	1 mm +0.09/-0.06 mm finished (1.15 ±0.025 mm drill)

For corresponding socket connectors, see pages 85-99.

## ORDERING INFORMATION ROHS COMPLIANT PARTS

PP PLATING CODE	TERMINATION	CONNECTING PIN
10	0.25 µm gold	0.25 µm gold
80	Tin	Tin

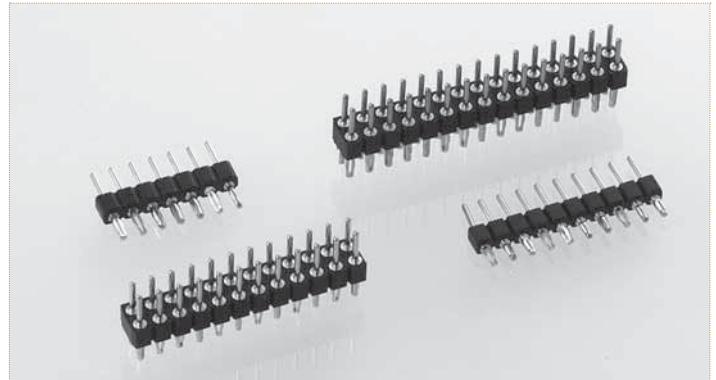

Other plating on request (see page 178 for plating specs).

**NNN number of poles.** Replace **NNN** with the requested number of poles, e.g. 800-10-**NNN**-65-001101 for a single row version with 8 pins becomes 800-10-**008**-65-001101.

### 800-PP-NNN-65-001101

Press-fit pin connector, single row, compliant pin for PCB thickness 1.5 to 2.5 mm

AVAILABILITY FROM 2 to 64 contacts  
(standard number of contacts: 64)

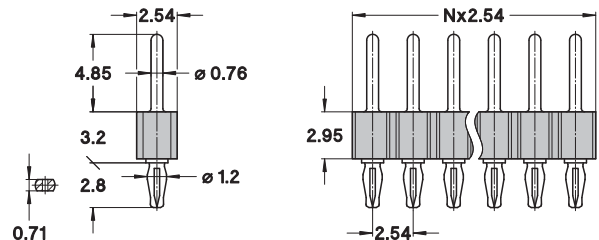

### 802-PP-NNN-65-001101

Press-fit pin connector, double row, compliant pin for PCB thickness 1.5 to 2.5 mm

AVAILABILITY FROM 4 to 72 contacts  
(standard number of contacts: 72)

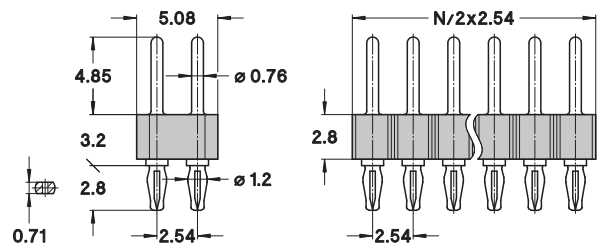

### 800-PP-NNN-66-001101

Press-fit pin connector, single row, compliant pin for PCB thickness 2.1 to 3.2 mm

AVAILABILITY FROM 2 to 64 contacts  
(standard number of contacts: 64)

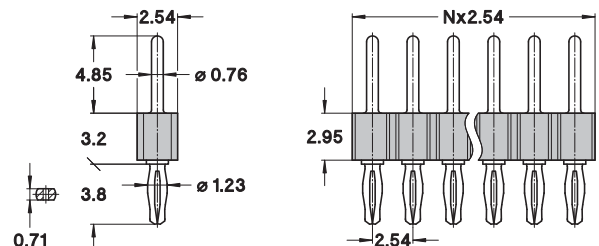

### 802-PP-NNN-66-001101

Press-fit pin connector, double row, compliant pin for PCB thickness 2.1 to 3.2 mm

AVAILABILITY FROM 4 to 72 contacts  
(standard number of contacts: 72)

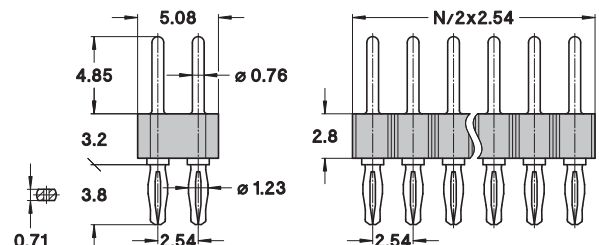





preci-dip

WWW.PRECIDIP.COM TEL +41 32 421 04 00 SALES@PRECIDIP.COM

# PIN CONNECTORS 2.54 mm

CONNECTING PIN Ø 0.76 mm / SINGLE ROW / DOUBLE ROW / TRIPLE ROW PRESS-FIT

Pin connectors, press-fit with compliant pin for solderless mount in PCB plated through holes.

## TECHNICAL SPECIFICATIONS (FOR GENERAL SPECS, SEE PAGE 43)

INSULATOR	Black glass filled polyester PCT-GF30-FR
FLAMMABILITY	UL 94V-0
CONTACT	Bronze CuSn4Pb4Zn4 (C54400)
CONNECTING PIN Ø	0.76 mm
MECHANICAL LIFE	Min. 500 cycles
RATED CURRENT	3 A
DIELECTRIC STRENGTH	Min. 1'000 V <sub>RMS</sub>
PCB HOLE Ø	1 mm +0.09/-0.06 mm finished (1.15 ±0.025 mm drill)

For corresponding socket connectors, see pages 85-99.

## ORDERING INFORMATION ROHS COMPLIANT PARTS

PP PLATING CODE	TERMINATION	CONNECTING PIN
V3	Tin	0.75 µm gold

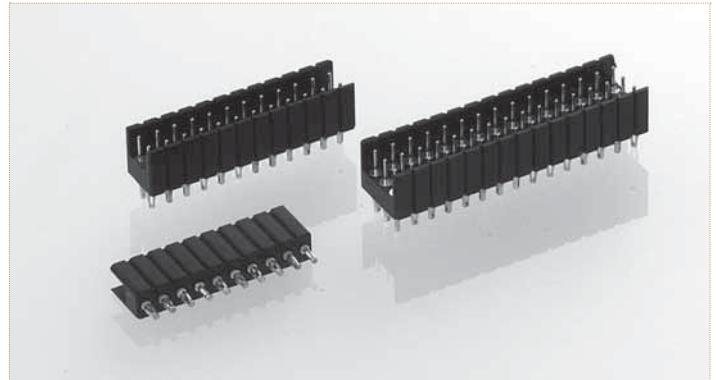

Other plating on request (see page 178 for plating specs).

**NNN number of poles.** Replace **NNN** with the requested number of poles, e.g. 800-V3-**NNN**-6B-002101 for a single row version with 8 pins becomes 800-V3-**008**-6B-002101.

### 800-V3-**NNN**-6B-002101

Press-fit shrouded pin connector, single row, compliant pin for PCB thickness 1.5 to 2.5 mm

AVAILABILITY FROM 2 to 32 contacts  
(standard number of contacts: 32)

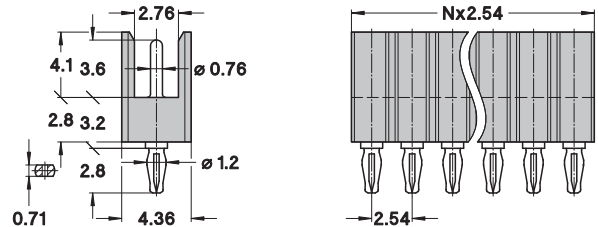

### 802-V3-**NNN**-6B-002101

Press-fit shrouded pin connector, double row, compliant pin for PCB thickness 1.5 to 2.5 mm

AVAILABILITY FROM 4 to 64 contacts  
(standard number of contacts: 64)

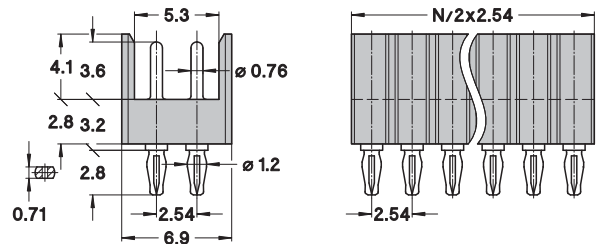

### 804-V3-**NNN**-6B-002101

Press-fit shrouded pin connector, triple row, compliant pin for PCB thickness 1.5 to 2.5 mm

AVAILABILITY FROM 9 to 96 contacts  
(standard number of contacts: 96)

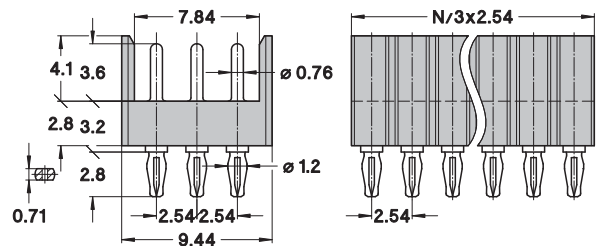



preci-dip

WWW.PRECIDIP.COM TEL +41 32 421 04 00 SALES@PRECIDIP.COM

# PIN CONNECTORS 2.54 mm

SQUARE PIN  $\square$  0.635 mm / SINGLE ROW / DOUBLE ROW / TRIPLE ROW  
SOLDER TAIL

Square pin headers, solder tail.

## TECHNICAL SPECIFICATIONS (FOR GENERAL SPECS, SEE PAGE 43)

INSULATOR	Black glass filled polyamide PA-GF30-FR
FLAMMABILITY	UL 94V-0
CONTACT	Brass
CONNECTING PIN	$\square$ 0.635 mm
MECHANICAL LIFE	Min. 100 cycles
RATED CURRENT	3 A
DIELECTRIC STRENGTH	Min. 1'000 V <sub>RMS</sub>

For corresponding socket connectors, see pages 85-99.

## ORDERING INFORMATION ROHS COMPLIANT PARTS

PP PLATING CODE	TERMINATION	CONNECTING PIN
70	Flash gold	Flash gold
80	Tin	Tin
18	Tin	0.25 $\mu$ m gold



See page 178 for plating specs.

**NNN number of poles.** Replace **NNN** with the requested number of poles, e.g. 890-70-**NNN**-10-001101 for a single row version with 8 pins becomes 890-70-**008**-10-001101.

### 890-PP-NNN-10-XXX101

Straight square pin header, solder tail, single row

AVAILABILITY FROM 2 to 40 contacts  
(standard number of contacts: 40)

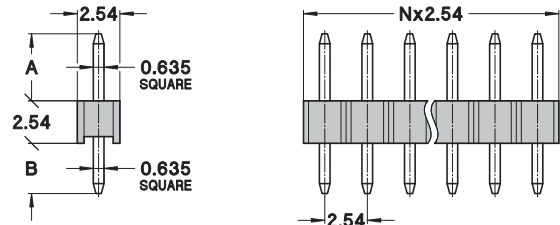

### 892-PP-NNN-10-XXX101

Straight square pin header, solder tail, double row

AVAILABILITY FROM 4 to 80 contacts  
(standard number of contacts: 80)

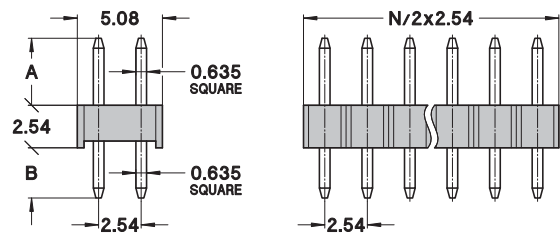

### 894-PP-NNN-10-001101

Straight square pin header, solder tail, triple row

Only contact length code 001 available

AVAILABILITY FROM 9 to 120 contacts  
(standard number of contacts: 120)

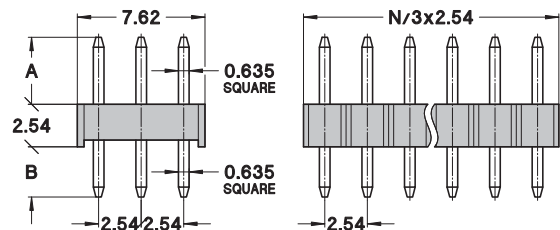

## AVAILABLE CONTACT LENGTHS

CONNECTING PIN A (mm)	SOLDER PIN B (mm)	XXX CODE
6	3.1	001
7	3	002
8.5	3	003
14.9	3	004



preci-dip

WWW.PRECIDIP.COM TEL +41 32 421 04 00 SALES@PRECIDIP.COM

# PIN CONNECTORS 2.54 mm

SQUARE PIN  $\square$  0.635 mm / SINGLE ROW / DOUBLE ROW / TRIPLE ROW  
SOLDER TAIL / RIGHT ANGLE

Right angle square pin headers, solder tail.

## TECHNICAL SPECIFICATIONS (FOR GENERAL SPECS, SEE PAGE 43)

INSULATOR	Black glass filled polyamide PA-GF30-FR
FLAMMABILITY	UL 94V-0
CONTACT	Brass
CONNECTING PIN	$\square$ 0.635 mm
MECHANICAL LIFE	Min. 100 cycles
RATED CURRENT	3 A
DIELECTRIC STRENGTH	Min. 1'000 V <sub>RMS</sub>

For corresponding socket connectors, see pages 85-99.

## ORDERING INFORMATION ROHS COMPLIANT PARTS

PP PLATING CODE	TERMINATION	CONNECTING PIN
70	Flash gold	Flash gold
80	Tin	Tin
18	Tin	0.25 $\mu$ m gold



See page 178 for plating specs.

**NNN number of poles.** Replace **NNN** with the requested number of poles, e.g. 890-70-**NNN**-20-006101 for a single row version with 8 pins becomes 890-70-**008**-20-006101.

### 890-PP-NNN-20-XXX101

Right angle square pin header, solder tail, single row

AVAILABILITY FROM 2 to 40 contacts  
(standard number of contacts: 40)

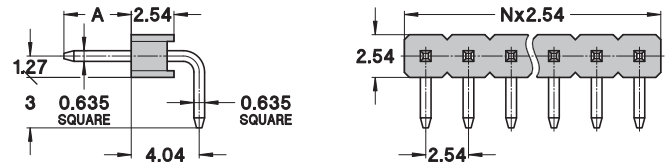

### 892-PP-NNN-20-XXX101

Right angle square pin header, solder tail, double row

AVAILABILITY FROM 4 to 80 contacts  
(standard number of contacts: 80)

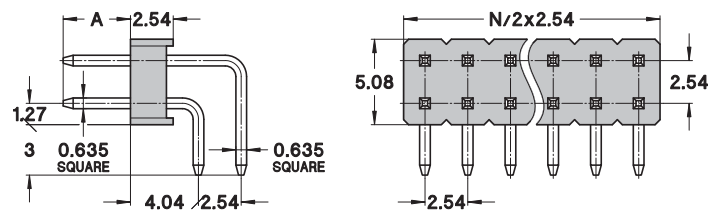

### 894-PP-NNN-20-001101

Right angle square pin header, solder tail, triple row

Only contact length code 001 available

AVAILABILITY FROM 9 to 120 contacts  
(standard number of contacts: 120)

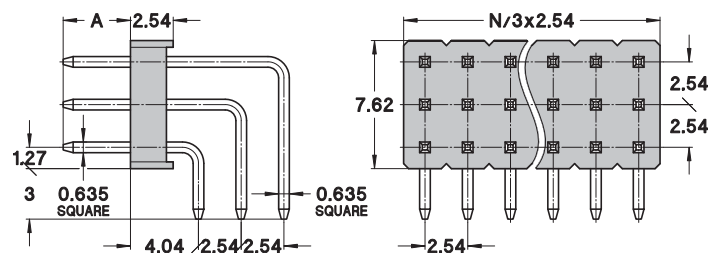

## AVAILABLE CONTACT LENGTHS

CONNECTING PIN A (mm)	XXX CODE
6	001
7	002



preci-dip

WWW.PRECIDIP.COM TEL +41 32 421 04 00 SALES@PRECIDIP.COM

# PCB HEADER STRIPS 2.54 mm

SINGLE ROW / DOUBLE ROW / SOLDER TAIL

PCB header strips for wiring application with solder tail / connecting pin.

## TECHNICAL SPECIFICATIONS (FOR GENERAL SPECS, SEE PAGE 43)

INSULATOR	Black glass filled polyester PCT-GF30-FR
FLAMMABILITY	UL 94V-0
CONTACT	Brass CuZn36Pb3 (C36000)
CONNECTING PIN Ø	0.5 mm
MECHANICAL LIFE	Min. 100 cycles
RATED CURRENT	3 A
CONTACT RESISTANCE	Max. 10 mΩ
DIELECTRIC STRENGTH	Min. 1'000 VRMS

For corresponding socket connectors, see pages 69-84.

## ORDERING INFORMATION ROHS COMPLIANT PARTS

PP PLATING CODE	TERMINATION	CONNECTING PIN
10	0.25 µm gold	0.25 µm gold
80	Tin	Tin

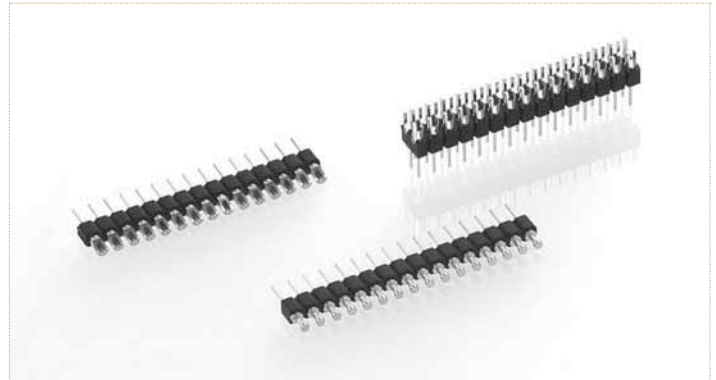

Other plating on request (see page 178 for plating specs).

**NN number of poles.** Replace **NN** with the requested number of poles, e.g. 460-10-2**NN**-00-001101 for a double row version with 16 pins becomes 460-10-2**16**-00-001101.

### 360-PP-1NN-00-001101

Slotted head strip with solder tail / connecting pin, single row

AVAILABILITY FROM 2 to 64 contacts  
(standard number of contacts: 64)

### 460-PP-2NN-00-001101

Slotted head strip with solder tail / connecting pin, double row

AVAILABILITY FROM 4 to 72 contacts  
(standard number of contacts: 72)

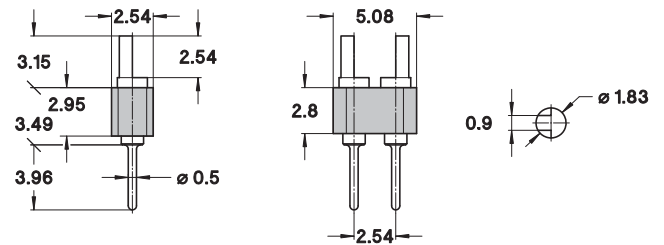

### 370-PP-1NN-00-001101

Turret head strip with solder tail / connecting pin, single row

AVAILABILITY FROM 2 to 64 contacts  
(standard number of contacts: 64)

### 470-PP-2NN-00-001101

Turret head strip with solder tail / connecting pin, double row

AVAILABILITY FROM 4 to 72 contacts  
(standard number of contacts: 72)

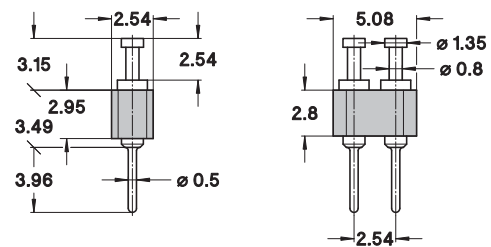

### 380-PP-1NN-00-001101

Solder cup strip with solder tail / connecting pin, single row

AVAILABILITY FROM 2 to 64 contacts  
(standard number of contacts: 64)

### 480-PP-2NN-00-001101

Solder cup strip with solder tail / connecting pin, double row

AVAILABILITY FROM 4 to 72 contacts  
(standard number of contacts: 72)

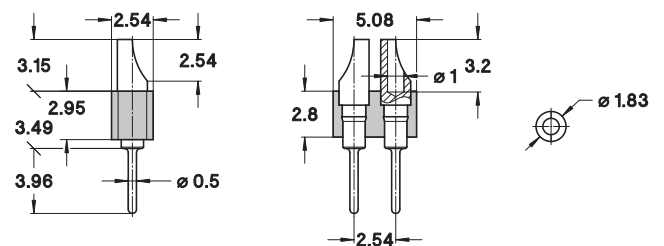



preci-dip

WWW.PRECIDIP.COM TEL +41 32 421 04 00 SALES@PRECIDIP.COM

# PCB HEADER STRIPS 2.54 mm

SINGLE ROW / DOUBLE ROW / WIRE-WRAP

PCB header strips for wiring application, wire-wrap.

## TECHNICAL SPECIFICATIONS (FOR GENERAL SPECS, SEE PAGE 43)

INSULATOR	Black glass filled polyester PCT-GF30-FR
FLAMMABILITY	UL 94V-0
CONTACT	Brass CuZn36Pb3 (C36000)
WIRE-WRAP TERMINAL	□ 0.635 mm, 3-level
MECHANICAL LIFE	Min. 100 cycles
RATED CURRENT	3 A
CONTACT RESISTANCE	Max. 10 mΩ
DIELECTRIC STRENGTH	Min. 1'000 V <sub>RMS</sub>

For corresponding socket connectors, see pages 69-84.

## ORDERING INFORMATION ROHS COMPLIANT PARTS

PP PLATING CODE	TERMINATION	CONNECTING PIN
10	0.25 μm gold	0.25 μm gold

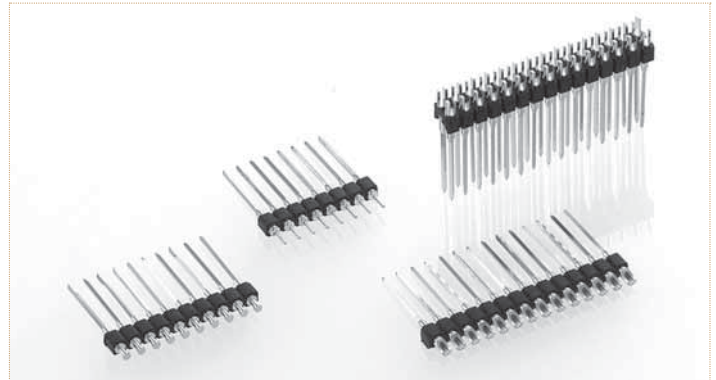

Other plating on request (see page 178 for plating specs).

**NN number of poles.** Replace NN with the requested number of poles, e.g. 453-10-2NN-00-001101 for a double row version with 16 pins becomes 453-10-216-00-001101.

PCB CONNECTORS

### 353-10-1NN-00-001101

Pin header strip with wire-wrap termination, single row  
AVAILABILITY FROM 2 to 64 contacts  
(standard number of contacts: 64)

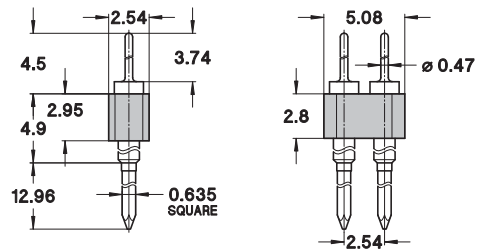

### 453-10-2NN-00-001101

Pin header strip with wire-wrap termination, double row  
AVAILABILITY FROM 4 to 72 contacts  
(standard number of contacts: 72)

### 363-10-1NN-00-001101

Slotted head strip with wire-wrap termination, single row  
AVAILABILITY FROM 2 to 64 contacts  
(standard number of contacts: 64)

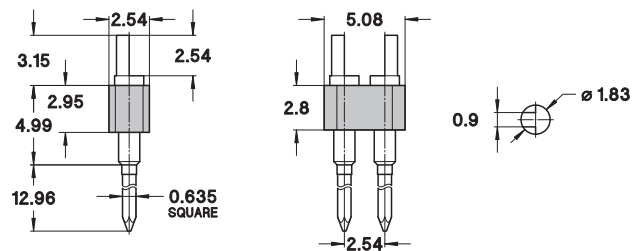

### 463-10-2NN-00-001101

Slotted head strip with wire-wrap termination, double row  
AVAILABILITY FROM 4 to 72 contacts  
(standard number of contacts: 72)

### 373-10-1NN-00-001101

Turret head strip with wire-wrap termination, single row  
AVAILABILITY FROM 2 to 64 contacts  
(standard number of contacts: 64)

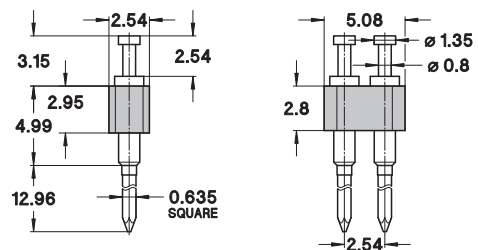

### 473-10-2NN-00-001101

Turret head strip with wire-wrap termination, double row  
AVAILABILITY FROM 4 to 72 contacts  
(standard number of contacts: 72)

### 383-10-1NN-00-001101

Solder cup strip with wire-wrap termination, single row  
AVAILABILITY FROM 2 to 64 contacts  
(standard number of contacts: 64)

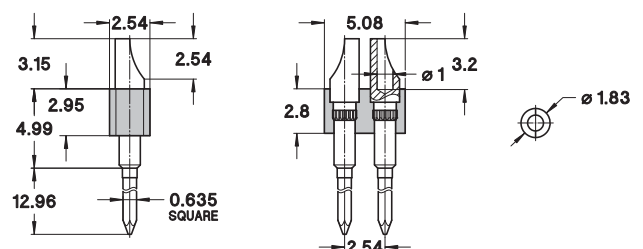

### 483-10-2NN-00-001101

Solder cup strip with wire-wrap termination, double row  
AVAILABILITY FROM 4 to 72 contacts  
(standard number of contacts: 72)





preci-dip

WWW.PRECIDIP.COM TEL +41 32 421 04 00 SALES@PRECIDIP.COM

# MALE JUMPERS

2.54 mm GRID

Available with or without insulator and with 2.54, 5.08 or 7.62 mm pitch. For use with standard socket connectors.

## TECHNICAL SPECIFICATIONS (FOR GENERAL SPECS, SEE PAGE 43)

<b>INSULATOR</b>	Black glass filled polyester PBT-GF30-FR
<b>FLAMMABILITY</b>	UL 94V-0
<b>CONTACT</b>	Brass CuZn36Pb3 (C36000)
<b>CONNECTING PIN Ø</b>	0.56 mm
<b>MECHANICAL LIFE</b>	Min. 100 cycles
<b>RATED CURRENT</b>	3 A
<b>CONTACT RESISTANCE</b>	Max. 10 mΩ
<b>DIELECTRIC STRENGTH</b>	Min. 1'000 V <sub>RMS</sub>

## ORDERING INFORMATION ROHS COMPLIANT PARTS

<b>P PLATING CODE</b>	<b>TERMINATION</b>
1	0.15 µm gold

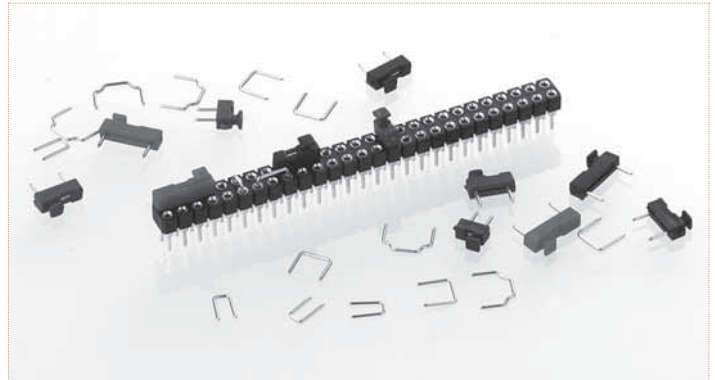

Jumpers for socket connectors, B = 2.54 mm, not insulated (Fig. 1)

999-11-110-10

Jumpers for socket connectors, B = 2.54 mm (Fig. 2):

999-11-210-10

Black insulator

999-11-210-11

Red insulator

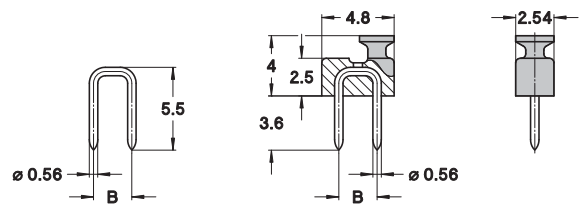

Fig. 1

Fig. 2

Jumpers for socket connectors, B = 5.08 mm, not insulated (Fig. 3)

999-11-112-10

Jumpers for socket connectors, B = 5.08 mm (Fig. 4):

999-11-220-10

Black insulator

999-11-220-11

Red insulator

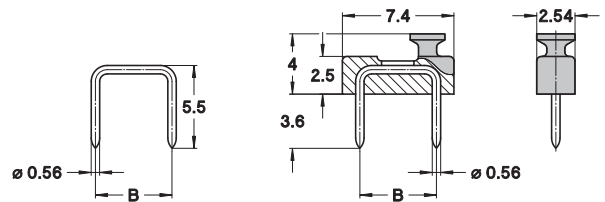

Fig. 3

Fig. 4

Jumpers for socket connectors, B = 7.62 mm, not insulated (Fig. 5)

999-11-113-10

Jumpers for socket connectors, B = 7.62 mm (Fig. 6):

999-11-230-10

Black insulator

999-11-230-11

Red insulator

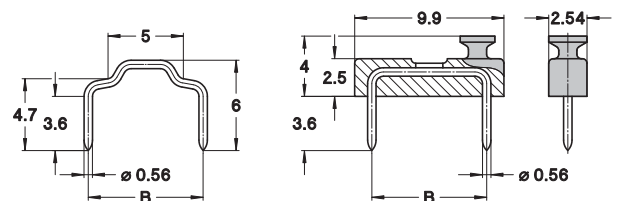

Fig. 5

Fig. 6

## OPTION

Jumpers without insulator with wire Ø 0.50 mm instead of 0.56 mm.

WIDTH B (MM)	PART NUMBER
2.54	999-51-110-10
5.08	999-51-112-10
7.62	999-51-113-10



preci-dip

WWW.PRECIDIP.COM TEL +41 32 421 04 00 SALES@PRECIDIP.COM

# FEMALE JUMPERS

2 mm / 2.54 mm GRID

Female jumpers, colour coded, closed or open top of insulator body.

## TECHNICAL SPECIFICATIONS (FOR GENERAL SPECS, SEE PAGE 43)

<b>INSULATOR</b>	Black glass filled polyester PBT-GF30-FR
<b>FLAMMABILITY</b>	UL 94V-0
<b>CONTACT</b>	Phosphor bronze
<b>MATING PIN</b>	∅ 0.635 mm
<b>MECHANICAL LIFE</b>	Min. 100 cycles
<b>RATED CURRENT</b>	1 A (2 mm) / 3 A (2.54 mm)
<b>CONTACT RESISTANCE</b>	Max. 20 mΩ
<b>DIELECTRIC STRENGTH</b>	Min. 500 V <sub>RMS</sub>

## ORDERING INFORMATION ROHS COMPLIANT PARTS

<b>PP PLATING CODE</b>	<b>TERMINATION</b>
19	Flash gold

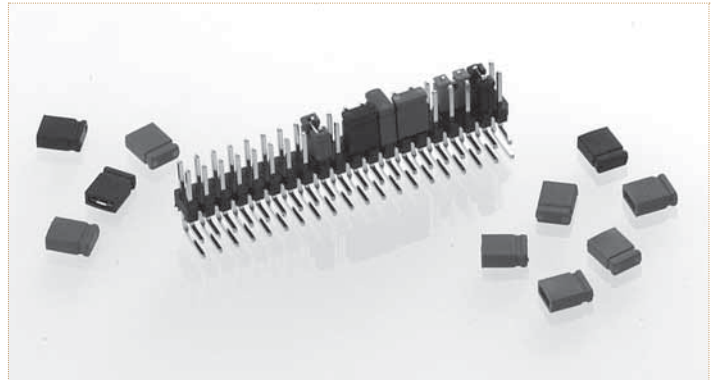

PCB CONNECTORS

2 mm jumpers for ∅ 0.5 mm pin headers, closed body:

999-19-220-00

Black insulator

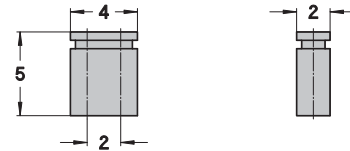

2 mm jumpers for ∅ 0.5 mm pin headers, stackable open body:

999-19-320-00

Black insulator

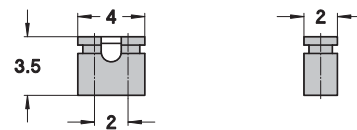

2.54 mm jumpers for ∅ 0.635 mm pin headers, closed body:

999-19-210-00

Black insulator

999-19-210-02

Red insulator

999-19-210-06

Blue insulator

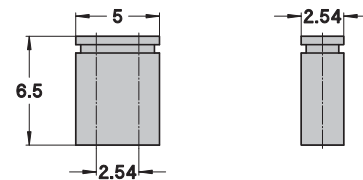

2.54 mm jumpers for ∅ 0.635 mm pin headers, stackable open body:

999-19-310-00

Black insulator

999-19-310-02

Red insulator

999-19-310-06

Blue insulator

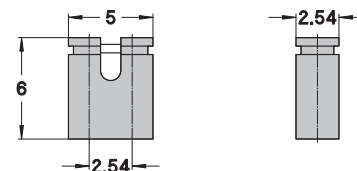

# DIL SOCKETS



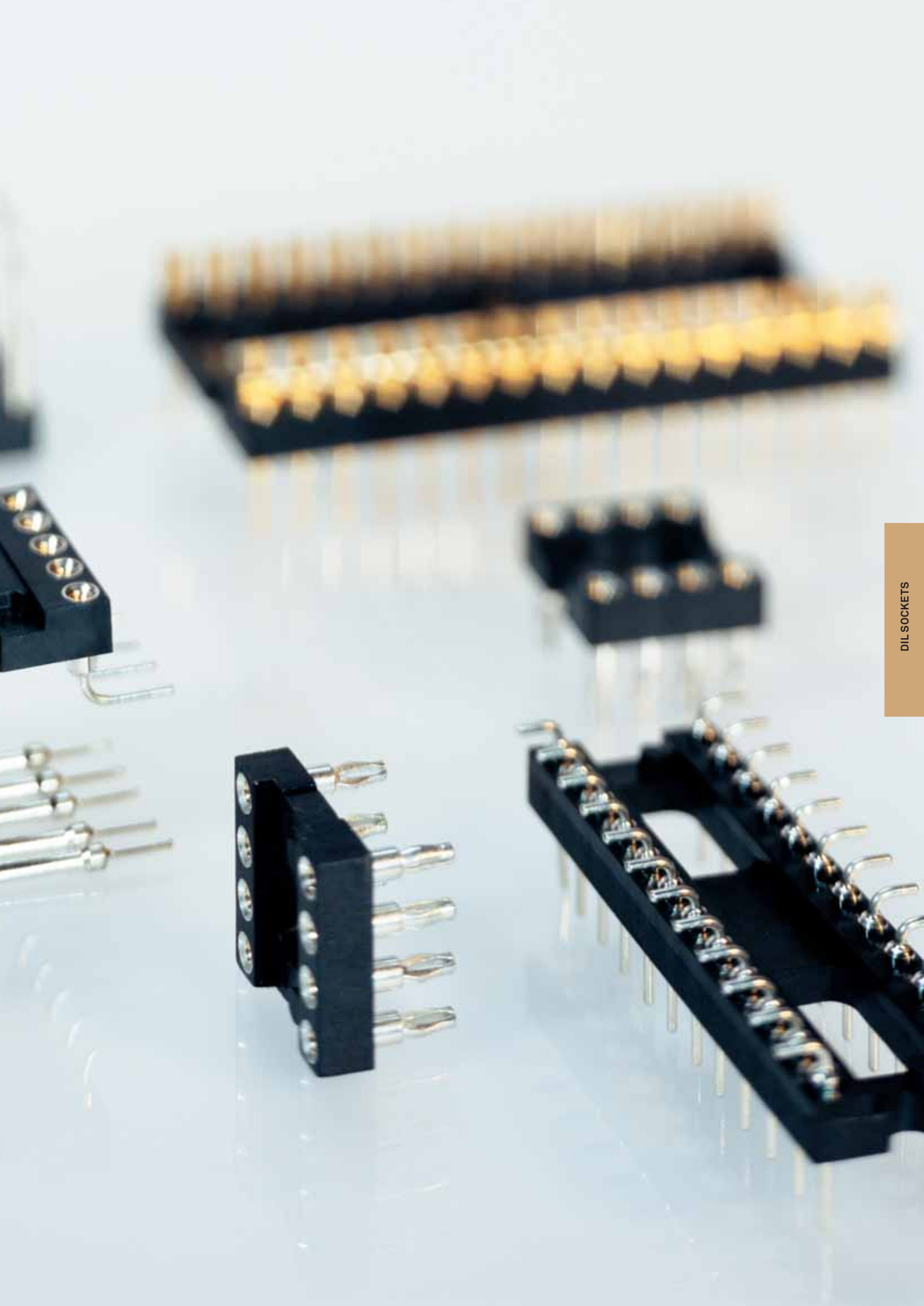



preci-dip

WWW.PRECIDIP.COM TEL +41 32 421 04 00 SALES@PRECIDIP.COM

# QUICK SELECTOR CHART

DIL / SIL / TO SOCKETS

GRID		DIL		STAGGERED	STAGGERED	TO
		2.54 mm	1.778 mm	2.54 mm	2.54 mm	
<b>SOCKETS</b>		<b>SEE PAGE</b>				
Solder tail		129	141	150	150	149
Solder tail automatic insertion		130				
Solder tail with decoupling capacitor		131				
Surface mount		132, 134	141			
Surface mount pick and place		133, 135				149
Solder tail ultralow profile		137				
Solder tail interconnect		138				
Wire-wrap		139				
Solderless press-fit mount		142				
Carrier		143				
Display right angle solder tail		144				
Crystal, relay and display, partially equipped solder tail		151				
<b>HEADERS</b>						
Solder tail		145	141			
Solder tail interconnect		145				
Surface mount		146				
Surface mount pick and place		147				
Solder tail wiring slotted head		148				
Solder tail wiring turret head		148				
Solder tail wiring solder cup		148				





preci-dip

WWW.PRECIDIP.COM TEL +41 32 421 04 00 SALES@PRECIDIP.COM

# DIL SOCKETS

## GENERAL SPECIFICATIONS

The values listed below are general specs applying for PRECI-DIP DIL sockets. Please see individual catalog page for additional and product specific technical data.

<b>OPERATING TEMPERATURE RANGE</b>	-55 ... +125 °C
<b>CLIMATIC CATEGORY (IEC)</b>	55/125/21
<b>OPERATING HUMIDITY RANGE</b>	Annual mean 75%
<b>MAX. WORKING VOLTAGE</b>	100 VRMS/150 VDC



PRECI-DIP connectors designated «Series Preci-Dip Connector» are recognized by UL LLC and listed under «Connectors for Use in Data, Signal, Control and Power Applications», File Nr. E174442.

### MECHANICAL CHARACTERISTICS

<b>CLIP RETENTION</b>	Min. 40 N (no displacement under axial force applied)
<b>CONTACT (SLEEVE / CLIP) RETENTION</b>	Min. 3.3 N acc. to MIL-DTL-83734, pt 4.6.4.2

### ELECTRICAL CHARACTERISTICS

<b>INSULATION RESISTANCE AT 500 V AC BETWEEN ANY TWO ADJACENT CONTACTS</b>	Min. 10'000 MΩ
<b>CAPACITANCE BETWEEN ANY TWO ADJACENT CONTACTS</b>	Max. 1 pF
<b>AIR AND CREEPAGE DISTANCES BETWEEN ANY TWO ADJACENT CONTACTS (Min. 0.2 mm FOR SHRINK-DIP SOCKETS)</b>	Min. 0.6 mm

### ENVIRONMENTAL CHARACTERISTICS

The sockets withstand the following environmental tests without mechanical and electrical defects:

- Dry heat steady state IEC 60512-11-9.11i / 60068-2-2.Bb: 125 °C, 16 h
  - Damp heat cyclic IEC 60512-11-12.11m / 60068-2-30.Db: 25/55 °C, 90 – 100 %rH, 1 cycle of 24 h
  - Cold steady state IEC 60512-11-10.11j / 60068-2-1.A: -55 °C, 2 h
  - Thermal shock IEC 60512-11-4.11d / 60068-2-14.Na: -55/125 °C, 5 cycles 30 min.
  - Sinusoidal vibrations IEC 60512-6-4.6d / 60068-2-6.Fc: 10 to 500 Hz, 10 g, 1 octave/min, 10 cycles for each axis
  - Shock IEC 60512-6-3.6c / 60068-2-27.Ea: 50 g, 11 ms, 3 shocks in three axis
- During the above two tests, no contact interruption >50 ns does appear.

- Solderability J-STD-002A, Test A, 245 °C, 5 s, solder alloy SnAg3.8Cu0.7
- Resistance to soldering heat J-STD-020C, 260 °C, 20 s
- Moisture sensitivity J-STD-020C level 1

### SOLDERLESS COMPLIANT PRESS-FIT CHARACTERISTICS

#### PRESS-FIT CHARACTERISTICS MEASURED ACC. TO IEC 60352-5

- Press-in force: 90 N max. (at min. hole dia.) / 65 N typ.
- Push-out force: 30 N min. (at max. hole dia.) / 50 N typ.
- Push-out 3<sup>rd</sup> cycle: 20 N min. (at max. hole dia.)

#### PCB HOLE DIMENSIONS

- 2.54 mm grid
- Finished hole Ø: 1 + 0.09/-0.06 mm  
Drilled hole Ø: 1.15 ± 0.025 mm

#### PCB HOLE PLATING

- PCB surface finish
- Hole plating
- Tin: 5-15 µm tin over min. 25 µm copper
  - Copper: min. 25 µm copper
  - Gold over nickel: 0.05-0.2 µm gold over 2.5-5 µm nickel over min. 25 µm copper



preci-dip

WWW.PRECIDIP.COM TEL +41 32 421 04 00 SALES@PRECIDIP.COM

# DUAL-IN-LINE SOCKETS

INSULATOR BODIES / STANDARD, OPEN FRAME

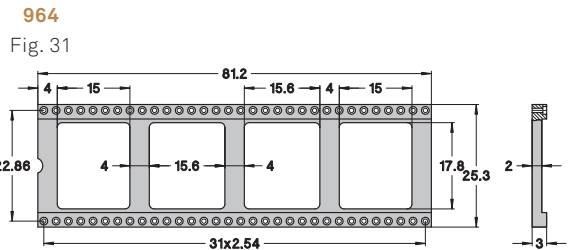
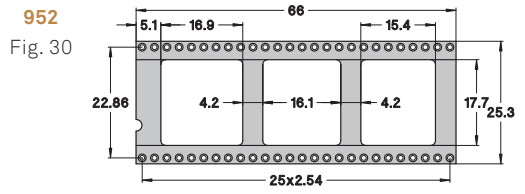
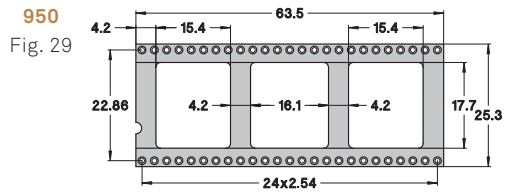
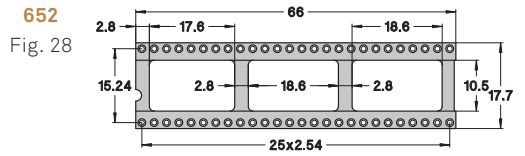
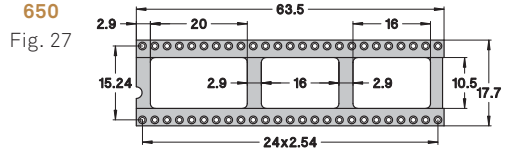
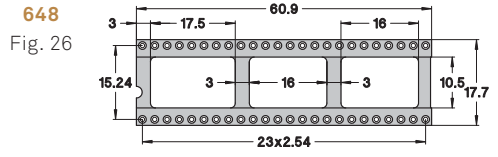
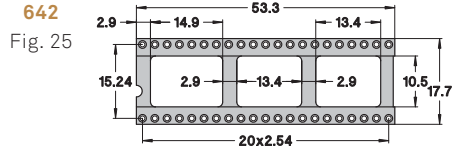
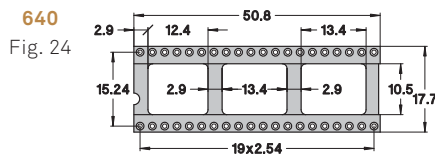
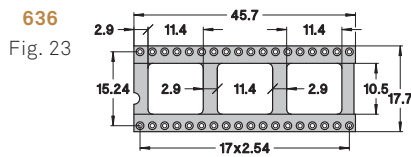
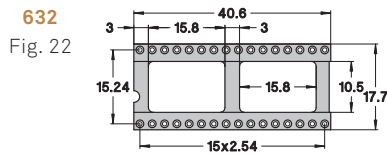
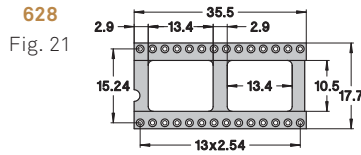
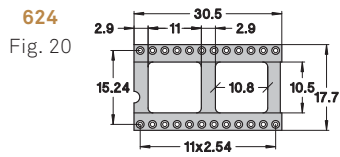
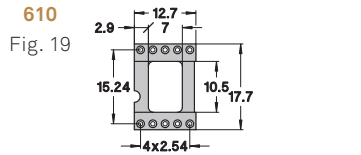
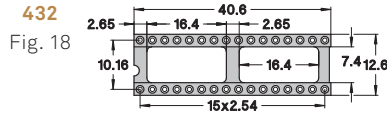
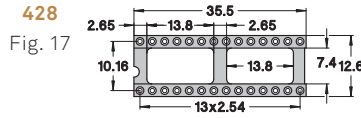
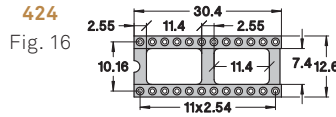
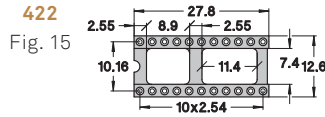
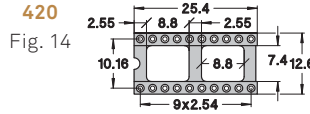
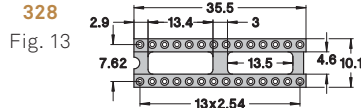
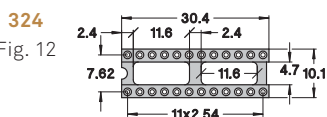
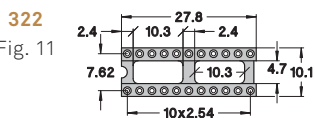
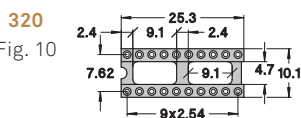
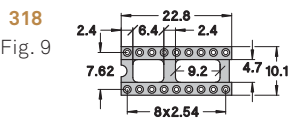
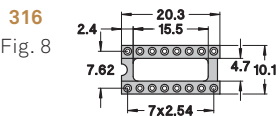
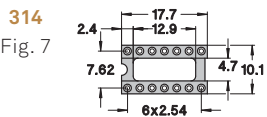
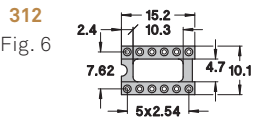
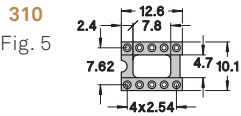
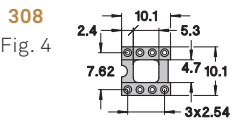
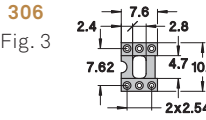
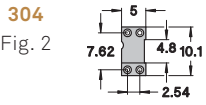
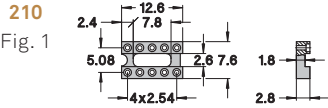

## ORDERING INFORMATION

Example:

110-PP-**314**-41-001101 (Order Code)

Row spacing  
Number of pins

**314**  
Fig. 7

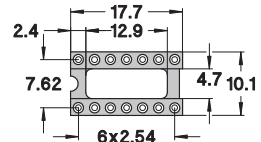



preci-dip

WWW.PRECIDIP.COM TEL +41 32 421 04 00 SALES@PRECIDIP.COM

# DUAL-IN-LINE SOCKETS

OPEN FRAME / SOLDER TAIL

Open frame standard low profile DIL Sockets.

## TECHNICAL SPECIFICATIONS (FOR GENERAL SPECS, SEE PAGE 127)

<b>INSULATOR</b>	Black glass filled polyester PCT-GF30-FR
<b>FLAMMABILITY</b>	UL 94V-0
<b>SLEEVE</b>	Brass CuZn36Pb3 (C36000)
<b>CONTACT CLIP (4 FINGER)</b>	Beryllium copper (C17200)
<b>ACCEPTED PIN Ø</b>	0.40 to 0.56 mm
<b>FORCES</b>	2 N typ. insertion      1 N typ. withdrawal (polished steel gauge Ø 0.43 mm)
<b>MECHANICAL LIFE</b>	Min. 100 cycles
<b>RATED CURRENT</b>	1 A
<b>CONTACT RESISTANCE</b>	Max. 10 mΩ
<b>DIELECTRIC STRENGTH</b>	Min. 1'000 VRMS

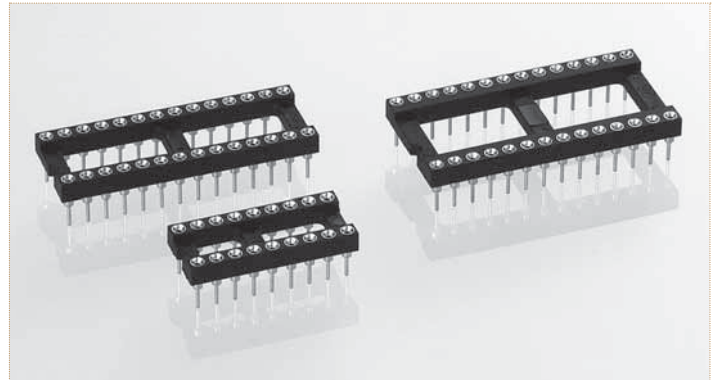

## ORDERING INFORMATION ROHS COMPLIANT PARTS

<b>PP PLATING CODE</b>	<b>SLEEVE</b>	<b>CLIP</b>
87	Tin	Flash gold
83	Tin	0.75 µm gold

Other plating on request (see page 178 for plating specs).

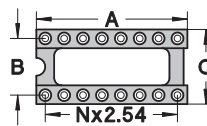
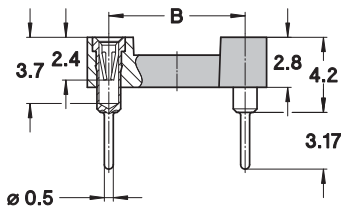

NO. OF POLES	A	B	C	SEE PAGE 128	ORDER CODES
10	12.6	5.08	7.6	Fig. 1	110-PP-210-41-001101
4	5.0	7.62	10.1	Fig. 2	110-PP-304-41-001101
6	7.6	7.62	10.1	Fig. 3	110-PP-306-41-001101
8	10.1	7.62	10.1	Fig. 4	110-PP-308-41-001101
10	12.6	7.62	10.1	Fig. 5	110-PP-310-41-001101
12	15.2	7.62	10.1	Fig. 6	110-PP-312-41-001101
14	17.7	7.62	10.1	Fig. 7	110-PP-314-41-001101
16	20.3	7.62	10.1	Fig. 8	110-PP-316-41-001101
18*	22.8	7.62	10.1	Fig. 9	110-PP-318-41-001101
20*	25.3	7.62	10.1	Fig. 10	110-PP-320-41-001101
22*	27.8	7.62	10.1	Fig. 11	110-PP-322-41-001101
24*	30.4	7.62	10.1	Fig. 12	110-PP-324-41-001101
28	35.5	7.62	10.1	Fig. 13	110-PP-328-41-001101
20	25.4	10.16	12.6	Fig. 14	110-PP-420-41-001101
22	27.8	10.16	12.6	Fig. 15	110-PP-422-41-001101
24	30.4	10.16	12.6	Fig. 16	110-PP-424-41-001101
28	35.5	10.16	12.6	Fig. 17	110-PP-428-41-001101
32	40.6	10.16	12.6	Fig. 18	110-PP-432-41-001101
10	12.7	15.24	17.7	Fig. 19	110-PP-610-41-001101
24*	30.5	15.24	17.7	Fig. 20	110-PP-624-41-001101
28*	35.5	15.24	17.7	Fig. 21	110-PP-628-41-001101
32*	40.6	15.24	17.7	Fig. 22	110-PP-632-41-001101
36	45.7	15.24	17.7	Fig. 23	110-PP-636-41-001101
40*	50.8	15.24	17.7	Fig. 24	110-PP-640-41-001101
42	53.3	15.24	17.7	Fig. 25	110-PP-642-41-001101
48*	60.9	15.24	17.7	Fig. 26	110-PP-648-41-001101
50	63.5	15.24	17.7	Fig. 27	110-PP-650-41-001101
52	66.0	15.24	17.7	Fig. 28	110-PP-652-41-001101
50	63.5	22.86	25.3	Fig. 29	110-PP-950-41-001101
52	66.0	22.86	25.3	Fig. 30	110-PP-952-41-001101
64	81.2	22.86	25.3	Fig. 31	110-PP-964-41-001101

## OPTIONS

- 1 **Insulators without center bar \***  
Open frame insulators 318, 320, 322, 324, 624, 628, 632, 640 and 648 available on special request without center bars; add suffix 151 to the part number. Example 110-83-628-41-001101 becomes 110-83-628-41-001151
- 2 **Sockets with increased solder tail length of 4.2 mm**  
allowing application on multilayer PCBs up to 3.4 mm thickness replace 110-...-...-... by 111-...-...-...
- 3 **Sockets with soft brass pin series 110-...-...-005101**, please consult
- 4 **For DIL Sockets with closed frame insulators** replace 110-... by 210-... Please consult for available pin numbers

DIL SOCKETS



preci-dip

WWW.PRECIDIP.COM TEL +41 32 421 04 00 SALES@PRECIDIP.COM

# DUAL-IN-LINE SOCKETS

AUTOMATIC INSERTION / OPEN FRAME / SOLDER TAIL

DIL sockets with ribbed insulator body and soft copper alloy contacts compatible with automatic insertion equipment.

## TECHNICAL SPECIFICATIONS (FOR GENERAL SPECS, SEE PAGE 127)

<b>INSULATOR</b>	Black glass filled polyester PCT-GF30-FR
<b>FLAMMABILITY</b>	UL 94V-0
<b>SLEEVE</b>	Brass CuZn36Pb3 (C36000)
<b>CONTACT CLIP (4 FINGER)</b>	Beryllium copper (C17200)
<b>ACCEPTED PIN Ø</b>	0.40 to 0.56 mm
<b>FORCES</b>	2 N typ. insertion      1 N typ. withdrawal (polished steel gauge Ø 0.43 mm)
<b>MECHANICAL LIFE</b>	Min. 100 cycles
<b>RATED CURRENT</b>	1 A
<b>CONTACT RESISTANCE</b>	Max. 10 mΩ
<b>DIELECTRIC STRENGTH</b>	Min. 1'000 V <sub>RMS</sub>

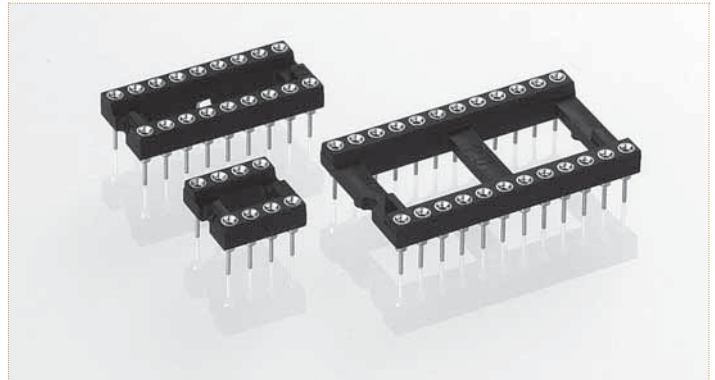

## ORDERING INFORMATION ROHS COMPLIANT PARTS

<b>PP PLATING CODE</b>	<b>SLEEVE</b>	<b>CLIP</b>
87	Tin	Flash gold
83	Tin	0.75 µm gold

Other plating on request (see page 178 for plating specs).  
Other pin count please consult.

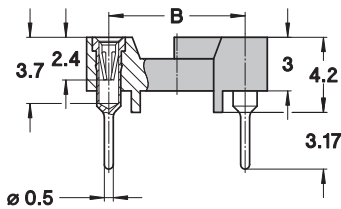

NO. OF POLES	B	SEE BELOW	ORDER CODES
6	7.62	Fig. 1	110-PP-306-41-605101
8	7.62	Fig. 2	110-PP-308-41-605101
14	7.62	Fig. 3	110-PP-314-41-605101
16	7.62	Fig. 4	110-PP-316-41-605101
18	7.62	Fig. 5	110-PP-318-41-605101
20	7.62	Fig. 6	110-PP-320-41-605101
24	7.62	Fig. 7	110-PP-324-41-605101
28	7.62	Fig. 7a	110-PP-328-41-605101
22	10.16	Fig. 8	110-PP-422-41-605101
24	15.24	Fig. 9	110-PP-624-41-605101
28	15.24	Fig. 10	110-PP-628-41-605101
32	15.24	Fig. 11	110-PP-632-41-605101
40	15.24	Fig. 12	110-PP-640-41-605101

## INSULATOR BODIES

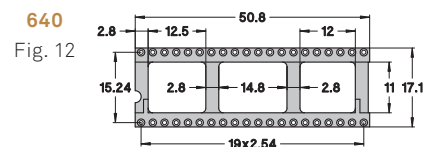
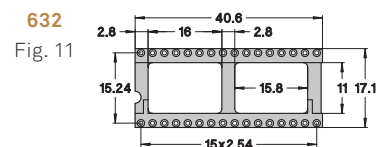
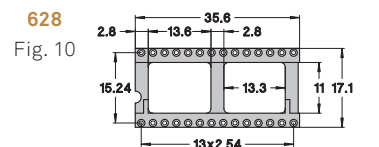
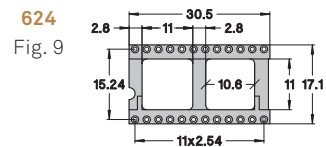
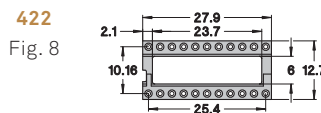
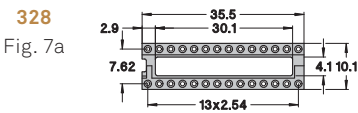
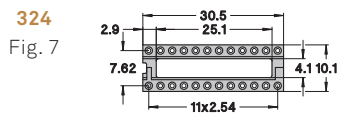
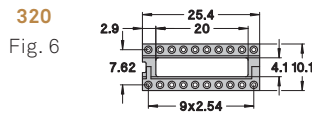
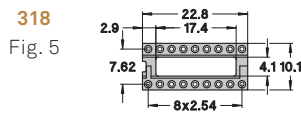
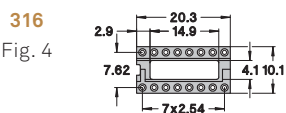
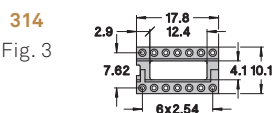
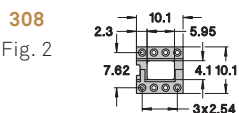
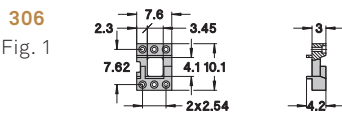



preci-dip

WWW.PRECIDIP.COM TEL +41 32 421 04 00 SALES@PRECIDIP.COM

# DUAL-IN-LINE CAPACITOR SOCKETS

OPEN FRAME / SOLDER TAIL

With ceramic multilayer decoupling capacitor 100 nF +80% -20% / 50 V, epoxy encapsulated.

## TECHNICAL SPECIFICATIONS (FOR GENERAL SPECS, SEE PAGE 127)

INSULATOR	Black glass filled polyester PCT-GF30-FR
FLAMMABILITY	UL 94V-0
SLEEVE	Brass CuZn36Pb3 (C36000)
CONTACT CLIP (4 FINGER)	Beryllium copper (C17200)
ACCEPTED PIN Ø	0.40 to 0.56 mm
FORCES	2 N typ. insertion      1 N typ. withdrawal (polished steel gauge Ø 0.43 mm)
MECHANICAL LIFE	Min. 100 cycles
RATED CURRENT	1 A
CONTACT RESISTANCE	Max. 10 mΩ
DIELECTRIC STRENGTH	Min. 1'000 V <sub>RMS</sub>
TEMPERATURE RANGE	-25°C to +85°C

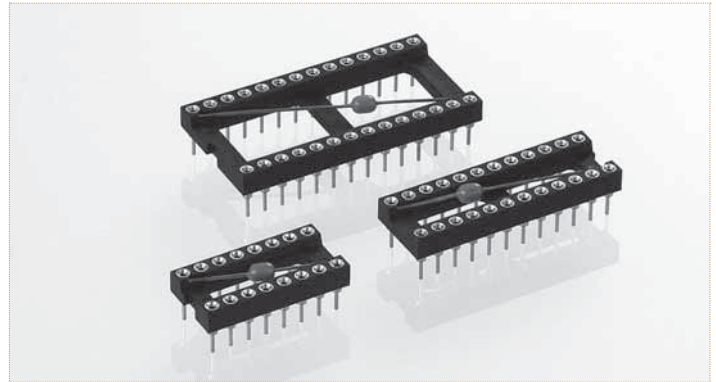

## ORDERING INFORMATION ROHS COMPLIANT PARTS

PP PLATING CODE	SLEEVE	CLIP
83	Tin	0.75 µm gold

Other plating on request (see page 178 for plating specs).

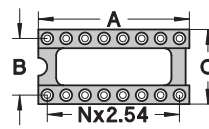
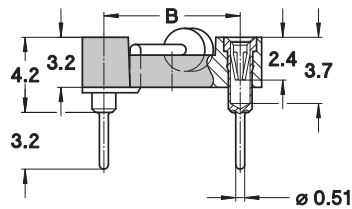

NO. OF POLES	A	B	C	SEE PAGE 128	ORDER CODES
14	17.7	7.62	10.1	Fig. 7	110-PP-314-41-801101
16	20.3	7.62	10.1	Fig. 8	110-PP-316-41-801101
18	22.8	7.62	10.1	Fig. 9	110-PP-318-41-801101
20	25.3	7.62	10.1	Fig. 10	110-PP-320-41-801101
24	30.4	15.24	17.7	Fig. 20	110-PP-624-41-801101
28	35.5	15.24	17.7	Fig. 21	110-PP-628-41-801101
32	40.6	15.24	17.7	Fig. 22	110-PP-632-41-801101
40	50.8	15.24	17.7	Fig. 24	110-PP-640-41-801101

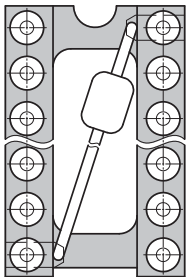

DIL SOCKETS





preci-dip

WWW.PRECIDIP.COM TEL +41 32 421 04 00 SALES@PRECIDIP.COM

# DUAL-IN-LINE SOCKETS

OPEN FRAME / SURFACE MOUNT

Specially designed for reflow soldering including vapor phase with gull wing terminations for maximum strength and easy in-circuit test.

## TECHNICAL SPECIFICATIONS (FOR GENERAL SPECS, SEE PAGE 127)

INSULATOR	Black glass filled polyester PCT-GF30-FR
FLAMMABILITY	UL 94V-0
SLEEVE	Brass CuZn36Pb3 (C36000)
CONTACT CLIP (4 FINGER)	Beryllium copper (C17200)
ACCEPTED PIN Ø	0.40 to 0.56 mm
FORCES	2 N typ. insertion 1 N typ. withdrawal (polished steel gauge Ø 0.43 mm)
MECHANICAL LIFE	Min. 100 cycles
RATED CURRENT	1 A
CONTACT RESISTANCE	Max. 10 mΩ
DIELECTRIC STRENGTH	Min. 1'000 V <sub>RMS</sub>
COPLANARITY	
SMD TERMINATIONS	Max. 0.10 mm

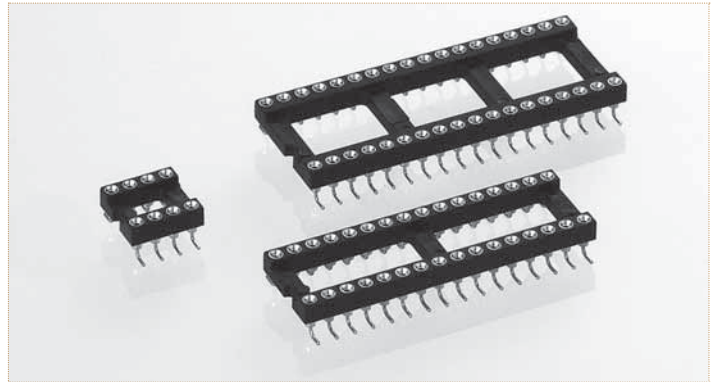

## ORDERING INFORMATION ROHS COMPLIANT PARTS

PP PLATING CODE	SLEEVE	CLIP
87	Tin	Flash gold
83	Tin	0.75 µm gold

Other plating on request (see page 178 for plating specs).

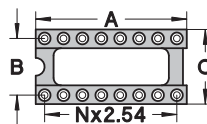
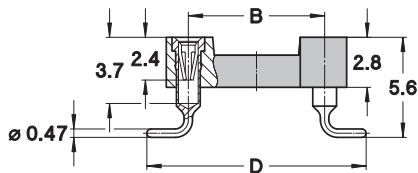

NO. OF POLES	A	B	C	D	SEE PAGE 128	ORDER CODES
10	12.6	5.08	7.6	9.72	Fig. 1	110-PP-210-41-105101
4	5.0	7.62	10.1	12.26	Fig. 2	110-PP-304-41-105101
6	7.6	7.62	10.1	12.26	Fig. 3	110-PP-306-41-105101
8	10.1	7.62	10.1	12.26	Fig. 4	110-PP-308-41-105101
10	12.6	7.62	10.1	12.26	Fig. 5	110-PP-310-41-105101
12	15.2	7.62	10.1	12.26	Fig. 6	110-PP-312-41-105101
14	17.7	7.62	10.1	12.26	Fig. 7	110-PP-314-41-105101
16	20.3	7.62	10.1	12.26	Fig. 8	110-PP-316-41-105101
18	22.8	7.62	10.1	12.26	Fig. 9	110-PP-318-41-105101
20	25.3	7.62	10.1	12.26	Fig. 10	110-PP-320-41-105101
22	27.8	7.62	10.1	12.26	Fig. 11	110-PP-322-41-105101
24	30.4	7.62	10.1	12.26	Fig. 12	110-PP-324-41-105101
28	35.5	7.62	10.1	12.26	Fig. 13	110-PP-328-41-105101
20	25.4	10.16	12.6	14.80	Fig. 14	110-PP-420-41-105101
22	27.8	10.16	12.6	14.80	Fig. 15	110-PP-422-41-105101
24	30.4	10.16	12.6	14.80	Fig. 16	110-PP-424-41-105101
28	35.5	10.16	12.6	14.80	Fig. 17	110-PP-428-41-105101
32	40.6	10.16	12.6	14.80	Fig. 18	110-PP-432-41-105101
24	30.5	15.24	17.7	19.88	Fig. 20	110-PP-624-41-105101
28	35.5	15.24	17.7	19.88	Fig. 21	110-PP-628-41-105101
32	40.6	15.24	17.7	19.88	Fig. 22	110-PP-632-41-105101
36	45.7	15.24	17.7	19.88	Fig. 23	110-PP-636-41-105101
40	50.8	15.24	17.7	19.88	Fig. 24	110-PP-640-41-105101
42	53.3	15.24	17.7	19.88	Fig. 25	110-PP-642-41-105101
48	60.9	15.24	17.7	19.88	Fig. 26	110-PP-648-41-105101

## PCB LAYOUT

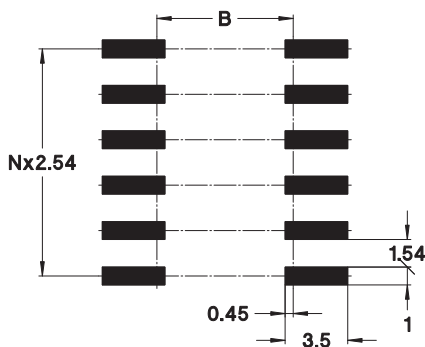



preci-dip

WWW.PRECIDIP.COM TEL +41 32 421 04 00 SALES@PRECIDIP.COM

# DUAL-IN-LINE SOCKETS

OPEN FRAME / SURFACE MOUNT, PICK AND PLACE

Specially designed for reflow soldering including vapor phase with gull wing terminations for maximum strength and easy in-circuit test.

## TECHNICAL SPECIFICATIONS (FOR GENERAL SPECS, SEE PAGE 127)

<b>INSULATOR</b>	Black glass filled polyester PCT-GF30-FR	
<b>FLAMMABILITY</b>	UL 94V-0	
<b>SLEEVE</b>	Brass CuZn36Pb3 (C36000)	
<b>CONTACT CLIP (4 FINGER)</b>	Beryllium copper (C17200)	
<b>ACCEPTED PIN Ø</b>	0.40 to 0.56 mm	
<b>FORCES</b>	2 N typ. insertion	1 N typ. withdrawal (polished steel gauge Ø 0.43 mm)
<b>MECHANICAL LIFE</b>	Min. 100 cycles	
<b>RATED CURRENT</b>	1 A	
<b>CONTACT RESISTANCE</b>	Max. 10 mΩ	
<b>DIELECTRIC STRENGTH</b>	Min. 1'000 V <sub>RMS</sub>	
<b>COPLANARITY</b>	Max. 0.10 mm	
<b>SMD TERMINATIONS</b>		

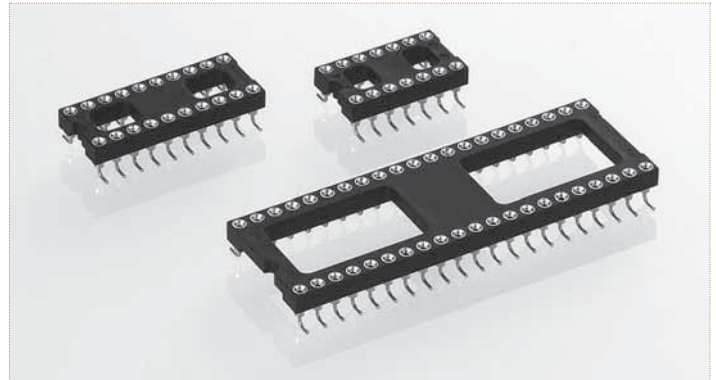

## ORDERING INFORMATION ROHS COMPLIANT PARTS

<b>PP PLATING CODE</b>	<b>SLEEVE</b>	<b>CLIP</b>
87	Tin	Flash gold
83	Tin	0.75 µm gold

Other plating on request (see page 178 for plating specs).

### Tape & Reel packaging:

replace 161 by suffix 191 to part number. Other pin counts please consult. Please consult [www.precidip.com](http://www.precidip.com) for availability size of tape, size of reel, number of components per reel, packing units and part numbers.

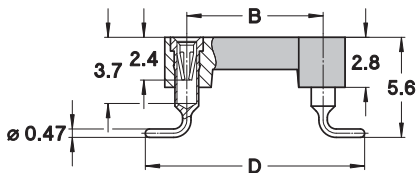

NO. OF POLES	A	B	C	D	E	ORDER CODES
6	7.6	7.62	10.1	12.26	7.6	110-PP-306-41-105161
8	10.1	7.62	10.1	12.26	10.1	110-PP-308-41-105161
10	12.6	7.62	10.1	12.26	12.6	110-PP-310-41-105161
14	17.8	7.62	10.1	12.26	5.3	110-PP-314-41-105161
16	20.3	7.62	10.1	12.26	5.3	110-PP-316-41-105161
18	22.9	7.62	10.1	12.26	5.3	110-PP-318-41-105161
20	25.4	7.62	10.1	12.26	8.3	110-PP-320-41-105161
24	30.4	7.62	10.1	12.26	8.3	110-PP-324-41-105161
28	35.6	7.62	10.1	12.26	8.3	110-PP-328-41-105161
28	35.5	15.24	17.7	19.88	10.0	110-PP-628-41-105161
32	40.6	15.24	17.7	19.88	10.0	110-PP-632-41-105161
40	50.8	15.24	17.7	19.88	10.0	110-PP-640-41-105161
42	53.4	15.24	17.7	19.88	10.0	110-PP-642-41-105161

DIL SOCKETS

## INSULATOR

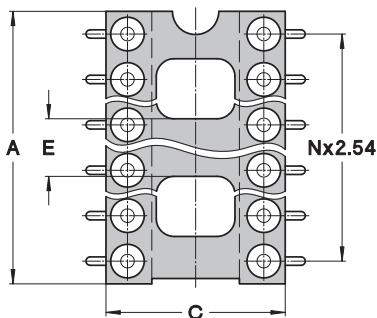

## PCB LAYOUT

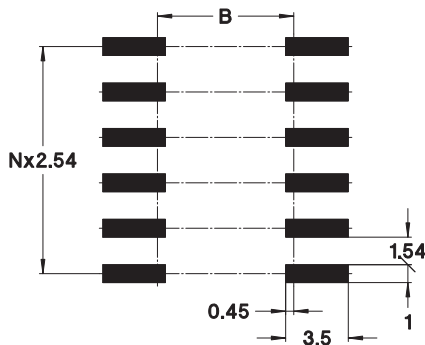



preci-dip

WWW.PRECIDIP.COM TEL +41 32 421 04 00 SALES@PRECIDIP.COM

# DUAL-IN-LINE SOCKETS

OPEN FRAME / SURFACE MOUNT

Specially designed for reflow soldering including vapor phase with unique self-aligning floating contacts.

## TECHNICAL SPECIFICATIONS (FOR GENERAL SPECS, SEE PAGE 127)

INSULATOR	Black glass filled polyester PCT-GF30-FR
FLAMMABILITY	UL 94V-0
SLEEVE	Brass CuZn36Pb3 (C36000)
CONTACT CLIP (4 FINGER)	Beryllium copper (C17200)
ACCEPTED PIN Ø	0.40 to 0.56 mm
FORCES	2 N typ. insertion      1 N typ. withdrawal (polished steel gauge Ø 0.43 mm)
MECHANICAL LIFE	Min. 100 cycles
RATED CURRENT	1 A
CONTACT RESISTANCE	Max. 10 mΩ
DIELECTRIC STRENGTH	Min. 1'000 V <sub>RMS</sub>
COPLANARITY	
SMD TERMINATIONS	Max. 0.10 mm

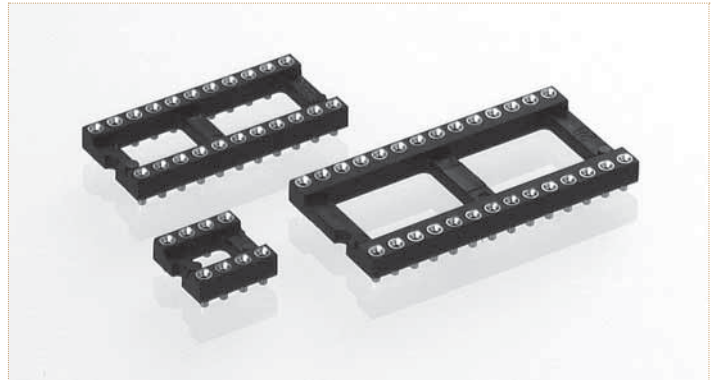

## ORDERING INFORMATION ROHS COMPLIANT PARTS

PP PLATING CODE	SLEEVE	CLIP
87	Tin	Flash gold
83	Tin	0.75 µm gold

Other plating on request (see page 178 for plating specs).

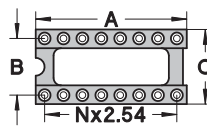
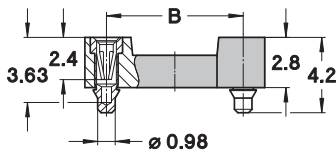

NO. OF POLES	A	B	C	SEE PAGE 128	ORDER CODES
10	12.6	5.08	7.6	Fig. 1	114-PP-210-41-117101
4	5.0	7.62	10.1	Fig. 2	114-PP-304-41-117101
6	7.6	7.62	10.1	Fig. 3	114-PP-306-41-117101
8	10.1	7.62	10.1	Fig. 4	114-PP-308-41-117101
10	12.6	7.62	10.1	Fig. 5	114-PP-310-41-117101
12	15.2	7.62	10.1	Fig. 6	114-PP-312-41-117101
14	17.7	7.62	10.1	Fig. 7	114-PP-314-41-117101
16	20.3	7.62	10.1	Fig. 8	114-PP-316-41-117101
18	22.8	7.62	10.1	Fig. 9	114-PP-318-41-117101
20	25.3	7.62	10.1	Fig. 10	114-PP-320-41-117101
22	27.8	7.62	10.1	Fig. 11	114-PP-322-41-117101
24	30.4	7.62	10.1	Fig. 12	114-PP-324-41-117101
28	35.5	7.62	10.1	Fig. 13	114-PP-328-41-117101
20	25.4	10.16	12.6	Fig. 14	114-PP-420-41-117101
22	27.8	10.16	12.6	Fig. 15	114-PP-422-41-117101
24	30.4	10.16	12.6	Fig. 16	114-PP-424-41-117101
28	35.5	10.16	12.6	Fig. 17	114-PP-428-41-117101
32	40.6	10.16	12.6	Fig. 18	114-PP-432-41-117101
24	30.5	15.24	17.7	Fig. 20	114-PP-624-41-117101
28	35.5	15.24	17.7	Fig. 21	114-PP-628-41-117101
32	40.6	15.24	17.7	Fig. 22	114-PP-632-41-117101
36	45.7	15.24	17.7	Fig. 23	114-PP-636-41-117101
40	50.8	15.24	17.7	Fig. 24	114-PP-640-41-117101
42	53.3	15.24	17.7	Fig. 25	114-PP-642-41-117101
48	60.9	15.24	17.7	Fig. 26	114-PP-648-41-117101

## PCB LAYOUT

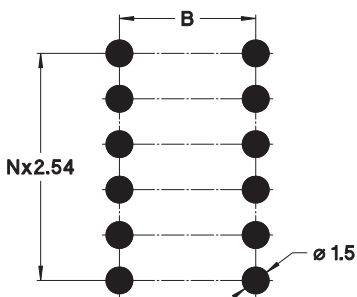



preci-dip

WWW.PRECIDIP.COM TEL +41 32 421 04 00 SALES@PRECIDIP.COM

# DUAL-IN-LINE SOCKETS

OPEN FRAME / SURFACE MOUNT PICK AND PLACE

Specially designed for reflow soldering including vapor phase with unique self-aligning floating contacts.

## TECHNICAL SPECIFICATIONS (FOR GENERAL SPECS, SEE PAGE 127)

<b>INSULATOR</b>	Black glass filled polyester PCT-GF30-FR
<b>FLAMMABILITY</b>	UL 94V-0
<b>SLEEVE</b>	Brass CuZn36Pb3 (C36000)
<b>CONTACT CLIP (4 FINGER)</b>	Beryllium copper (C17200)
<b>ACCEPTED PIN Ø</b>	0.40 to 0.56 mm
<b>FORCES</b>	2 N typ. insertion      1 N typ. withdrawal (polished steel gauge Ø 0.43 mm)
<b>MECHANICAL LIFE</b>	Min. 100 cycles
<b>RATED CURRENT</b>	1 A
<b>CONTACT RESISTANCE</b>	Max. 10 mΩ
<b>DIELECTRIC STRENGTH</b>	Min. 1'000 V <sub>RMS</sub>
<b>COPLANARITY</b>	
<b>SMD TERMINATIONS</b>	Max. 0.10 mm

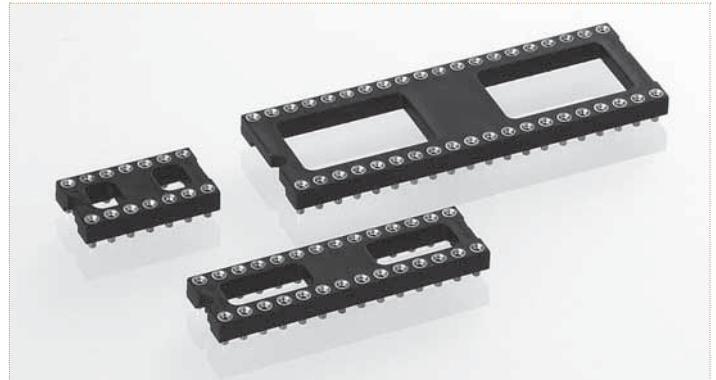

## ORDERING INFORMATION ROHS COMPLIANT PARTS

PP PLATING CODE	SLEEVE	CLIP
87	Tin	Flash gold
83	Tin	0.75 µm gold

Other plating on request (see page 178 for plating specs).

### Tape & Reel packaging:

replace 161 by suffix 191 to part number. Other pin counts please consult. Please consult [www.precidip.com](http://www.precidip.com) for availability size of tape, size of reel, number of components per reel, packing units and part numbers.

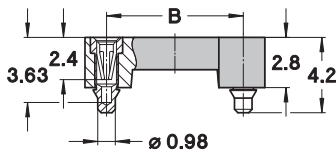

NO. OF POLES	A	B	C	E	ORDER CODES
6	7.6	7.62	10.1	7.6	114-PP-306-41-134161
8	10.1	7.62	10.1	10.1	114-PP-308-41-134161
10	12.6	7.62	10.1	12.6	114-PP-310-41-134161
12	15.2	7.62	10.1	5.3	114-PP-312-41-134161
14	17.8	7.62	10.1	5.3	114-PP-314-41-134161
16	20.3	7.62	10.1	5.3	114-PP-316-41-134161
18	22.9	7.62	10.1	5.3	114-PP-318-41-134161
20	25.4	7.62	10.1	8.3	114-PP-320-41-134161
24	30.4	7.62	10.1	8.3	114-PP-324-41-134161
28	35.6	7.62	10.1	8.3	114-PP-328-41-134161
28	35.5	15.24	17.7	10.0	114-PP-628-41-134161
32	40.6	15.24	17.7	10.0	114-PP-632-41-134161
40	50.8	15.24	17.7	10.0	114-PP-640-41-134161
42	53.4	15.24	17.7	10.0	114-PP-642-41-134161

DIL SOCKETS

## INSULATOR

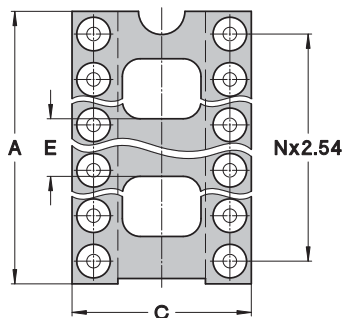

## PCB LAYOUT

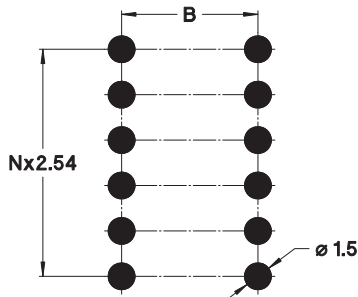



preci-dip

WWW.PRECIDIP.COM TEL +41 32 421 04 00 SALES@PRECIDIP.COM

# DUAL-IN-LINE SOCKETS

INSULATOR BODIES / ULTRALOW, OPEN FRAME

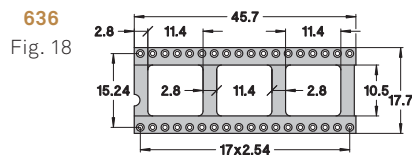
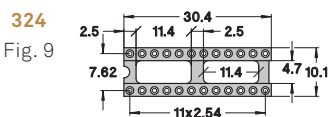
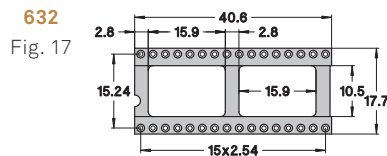
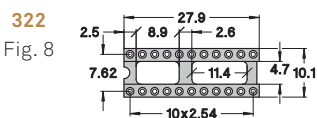
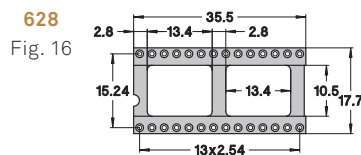
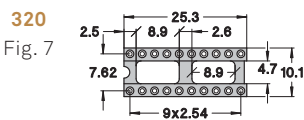
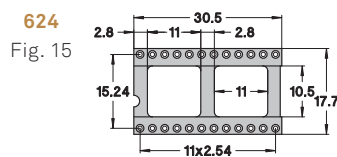
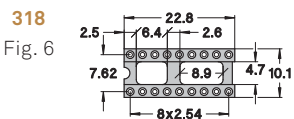
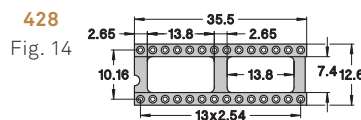
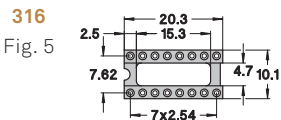
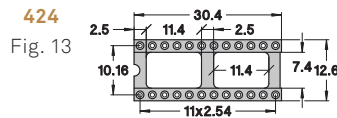
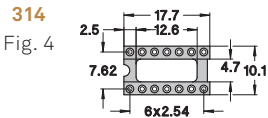
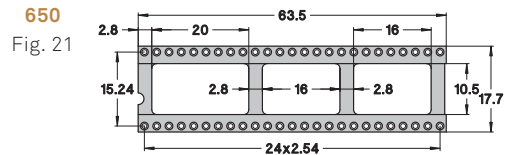
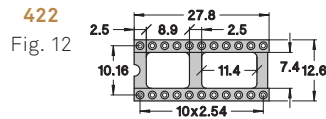
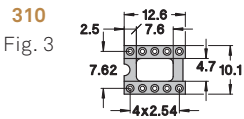
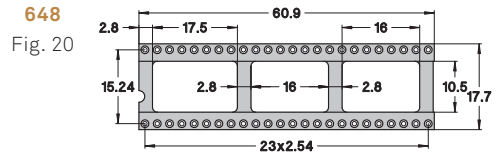
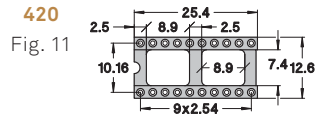
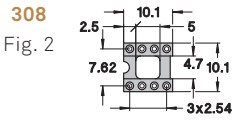
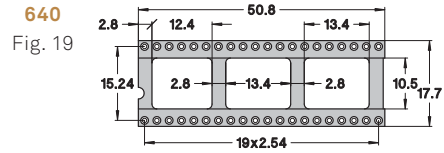
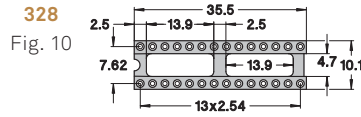
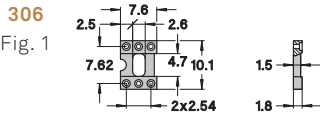

## ORDERING INFORMATION

Example:

115-PP-**314**-41-003101 (Order Code)

Row spacing  
Number of pins

**314**  
Fig. 4

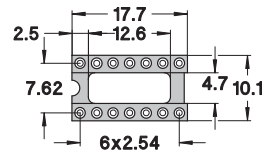





preci-dip

WWW.PRECIDIP.COM TEL +41 32 421 04 00 SALES@PRECIDIP.COM

# DUAL-IN-LINE SOCKETS

ULTRALOW AND VERY LOW PROFILE / OPEN FRAME / SOLDER TAIL

"Ultralow" sockets have specially designed contacts for reduced socket height above PCB.

## TECHNICAL SPECIFICATIONS (FOR GENERAL SPECS, SEE PAGE 127)

<b>INSULATOR</b>	Black glass filled polyester PCT-GF30-FR	
<b>FLAMMABILITY</b>	UL 94V-0	
<b>SLEEVE</b>	Brass CuZn36Pb3 (C36000)	
<b>CONTACT CLIP (4 FINGER)</b>	Beryllium copper (C17200)	
<b>ACCEPTED PIN Ø</b>	0.40 to 0.52 mm	
<b>FORCES</b>	3 N typ. insertion	1.5 N typ. withdrawal (polished steel gauge Ø 0.43 mm)
<b>MECHANICAL LIFE</b>	Min. 100 cycles	
<b>RATED CURRENT</b>	1 A	
<b>CONTACT RESISTANCE</b>	Max. 10 mΩ	
<b>DIELECTRIC STRENGTH</b>	Min. 1'000 VRMS	

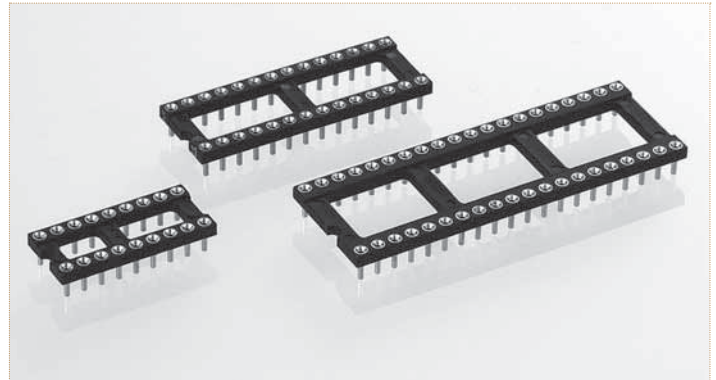

## ORDERING INFORMATION ROHS COMPLIANT PARTS

<b>PP PLATING CODE</b>	<b>SLEEVE</b>	<b>CLIP</b>
87	Tin	Flash gold
83	Tin	0.75 µm gold

Other plating on request (see page 178 for plating specs).

## ULTRALOW SOCKET

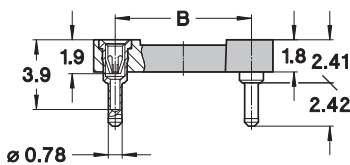
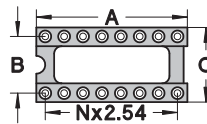

Fig. 1



NO. OF POLES	A	B	C	SEE PAGE 136	ORDER CODES
6	7.6	7.62	10.1	Fig. 1	115-PP-306-41-003101
8	10.1	7.62	10.1	Fig. 2	115-PP-308-41-003101
10	12.6	7.62	10.1	Fig. 3	115-PP-310-41-003101
14	17.7	7.62	10.1	Fig. 4	115-PP-314-41-003101
16	20.3	7.62	10.1	Fig. 5	115-PP-316-41-003101
18	22.8	7.62	10.1	Fig. 6	115-PP-318-41-003101
20	25.3	7.62	10.1	Fig. 7	115-PP-320-41-003101
22	27.9	7.62	10.1	Fig. 8	115-PP-322-41-003101
24	30.4	7.62	10.1	Fig. 9	115-PP-324-41-003101
28	35.5	7.62	10.1	Fig. 10	115-PP-328-41-003101
20	25.4	10.16	12.6	Fig. 11	115-PP-420-41-003101
22	27.8	10.16	12.6	Fig. 12	115-PP-422-41-003101
24	30.4	10.16	12.6	Fig. 13	115-PP-424-41-003101
28	35.5	10.16	12.6	Fig. 14	115-PP-428-41-003101
24	30.5	15.24	17.7	Fig. 15	115-PP-624-41-003101
28	35.5	15.24	17.7	Fig. 16	115-PP-628-41-003101
32	40.6	15.24	17.7	Fig. 17	115-PP-632-41-003101
36	45.7	15.24	17.7	Fig. 18	115-PP-636-41-003101
40	50.8	15.24	17.7	Fig. 19	115-PP-640-41-003101
48	60.9	15.24	17.7	Fig. 20	115-PP-648-41-003101
50	63.5	15.24	17.7	Fig. 21	115-PP-650-41-003101

## OPTIONS: VERY LOW VERSION

Very low version (Fig. 2) is optional; change suffix 003101 to 001101. Insulator body dimensions see page 128 Fig. 1 to 31. Same number of poles as standard series 110.

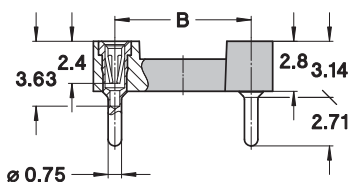

Fig. 2

DIL SOCKETS



preci-dip

WWW.PRECIDIP.COM TEL +41 32 421 04 00 SALES@PRECIDIP.COM

# DUAL-IN-LINE SOCKETS

INTERCONNECT / OPEN FRAME / SOLDER TAIL

For mechanical and electrical interconnection, PCB stacking or elevated positioning of display modules.

## TECHNICAL SPECIFICATIONS (FOR GENERAL SPECS, SEE PAGE 127)

<b>INSULATOR</b>	Black glass filled polyester PA-GF30-FR
<b>FLAMMABILITY</b>	UL 94V-0
<b>SLEEVE</b>	Brass CuZn36Pb3 (C36000)
<b>CONTACT CLIP (4 FINGER)</b>	Beryllium copper (C17200)
<b>ACCEPTED PIN Ø</b>	0.40 to 0.56 mm
<b>FORCES</b>	2 N typ. insertion      1 N typ. withdrawal (polished steel gauge Ø 0.43 mm)
<b>MECHANICAL LIFE</b>	Min. 100 cycles
<b>RATED CURRENT</b>	1 A
<b>CONTACT RESISTANCE</b>	Max. 10 mΩ
<b>DIELECTRIC STRENGTH</b>	Min. 1'000 V <sub>RMS</sub>

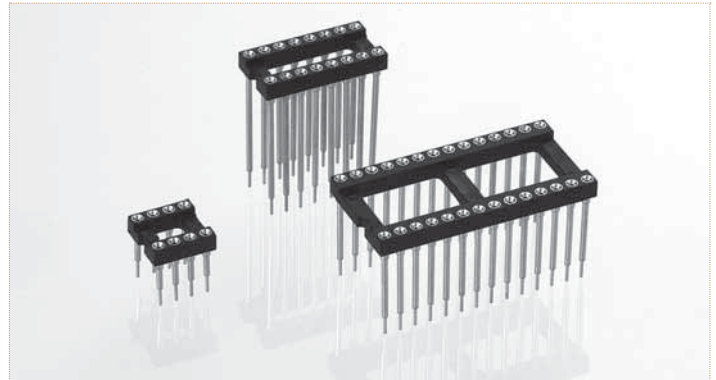

## ORDERING INFORMATION ROHS COMPLIANT PARTS

<b>PP PLATING CODE</b>	<b>SLEEVE</b>	<b>CLIP</b>
87	Tin	Flash gold
83	Tin	0.75 µm gold

Other plating on request (see page 178 for plating specs).

For complete part number replace **XXX** with the code given below left for the required contact length **L**.

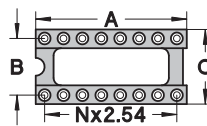
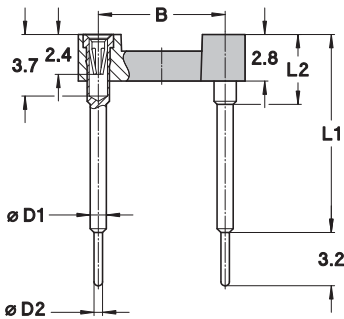

NO. OF POLES	A	B	C	SEE PAGE 128	ORDER CODES
10	12.6	5.08	7.6	Fig. 1	116-PP-210-41-XXX101
4	5.0	7.62	10.1	Fig. 2	116-PP-304-41-XXX101
6	7.6	7.62	10.1	Fig. 3	116-PP-306-41-XXX101
8	10.1	7.62	10.1	Fig. 4	116-PP-308-41-XXX101
10	12.6	7.62	10.1	Fig. 5	116-PP-310-41-XXX101
12	15.2	7.62	10.1	Fig. 6	116-PP-312-41-XXX101
14	17.7	7.62	10.1	Fig. 7	116-PP-314-41-XXX101
16	20.3	7.62	10.1	Fig. 8	116-PP-316-41-XXX101
18	22.8	7.62	10.1	Fig. 9	116-PP-318-41-XXX101
20	25.3	7.62	10.1	Fig. 10	116-PP-320-41-XXX101
22	27.8	7.62	10.1	Fig. 11	116-PP-322-41-XXX101
24	30.4	7.62	10.1	Fig. 12	116-PP-324-41-XXX101
28	35.5	7.62	10.1	Fig. 13	116-PP-328-41-XXX101
20	25.4	10.16	12.6	Fig. 14	116-PP-420-41-XXX101
22	27.8	10.16	12.6	Fig. 15	116-PP-422-41-XXX101
24	30.4	10.16	12.6	Fig. 16	116-PP-424-41-XXX101
28	35.5	10.16	12.6	Fig. 17	116-PP-428-41-XXX101
32	40.6	10.16	12.6	Fig. 18	116-PP-432-41-XXX101
10	12.7	15.24	17.7	Fig. 19	116-PP-610-41-XXX101
24	30.5	15.24	17.7	Fig. 20	116-PP-624-41-XXX101
28	35.5	15.24	17.7	Fig. 21	116-PP-628-41-XXX101
32	40.6	15.24	17.7	Fig. 22	116-PP-632-41-XXX101
36	45.7	15.24	17.7	Fig. 23	116-PP-636-41-XXX101
40	50.8	15.24	17.7	Fig. 24	116-PP-640-41-XXX101
42	53.3	15.24	17.7	Fig. 25	116-PP-642-41-XXX101
48	60.9	15.24	17.7	Fig. 26	116-PP-648-41-XXX101
50	63.5	15.24	17.7	Fig. 27	116-PP-650-41-XXX101
52	66.0	15.24	17.7	Fig. 28	116-PP-652-41-XXX101
50	63.5	22.86	25.3	Fig. 29	116-PP-950-41-XXX101
52	66.0	22.86	25.3	Fig. 30	116-PP-952-41-XXX101
64	81.2	22.86	25.3	Fig. 31	116-PP-964-41-XXX101

## AVAILABLE CONTACT LENGTHS

CONTACT LENGTH L1 (mm)	L2 (mm)	CONTACT DIAMETER		XXX CODE
		D1 (mm)	D2 (mm)	
6	4.2	1	0.51	006
7	4.2	1	0.51	018
8	4.2	1	0.51	003
9	4.85	1	0.46	012
10	4.2	1	0.51	007
11	4.2	0.85	0.51	002
12	4.2	1	0.51	008
13	4.2	1	0.51	009
15	4.2	1	0.51	001
18	4.2	1	0.51	011
22	4.2	1	0.51	004
33	4.2	1.18	0.51	013



preci-dip

WWW.PRECIDIP.COM TEL +41 32 421 04 00 SALES@PRECIDIP.COM

# DUAL-IN-LINE SOCKETS

OPEN FRAME / WIRE-WRAP

Solderless wire-wrap terminals are firmly fitted in the insulator body to withstand torque of wrapping tool.

## TECHNICAL SPECIFICATIONS (FOR GENERAL SPECS, SEE PAGE 127)

<b>INSULATOR</b>	Black glass filled polyester PA-GF30-FR
<b>FLAMMABILITY</b>	UL 94V-0
<b>SLEEVE</b>	Brass CuZn36Pb3 (C36000)
<b>CONTACT CLIP (4 FINGER)</b>	Beryllium copper (C17200)
<b>ACCEPTED PIN Ø</b>	0.40 to 0.56 mm
<b>FORCES</b>	2 N typ. insertion      1 N typ. withdrawal (polished steel gauge Ø 0.43 mm)
<b>MECHANICAL LIFE</b>	Min. 100 cycles
<b>RATED CURRENT</b>	1 A
<b>CONTACT RESISTANCE</b>	Max. 10 mΩ
<b>DIELECTRIC STRENGTH</b>	Min. 1'000 V <sub>RMS</sub>

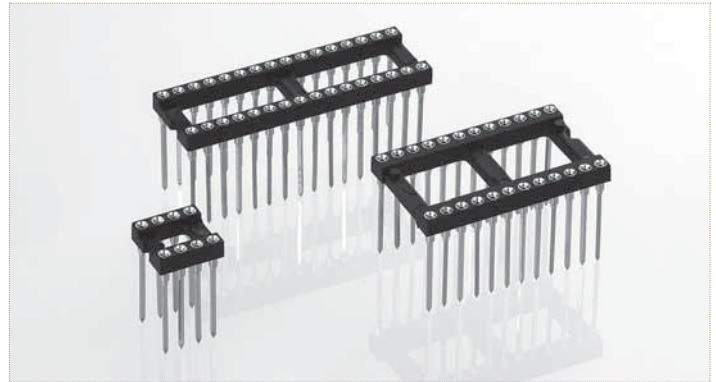

## ORDERING INFORMATION ROHS COMPLIANT PARTS

<b>PP PLATING CODE</b>	<b>SLEEVE</b>	<b>CLIP</b>
87	Tin	Flash gold
83	Tin	0.75 µm gold

Other plating on request (see page 178 for plating specs).

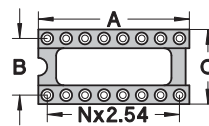
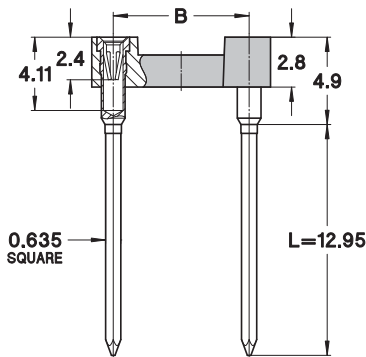

NO. OF POLES	A	B	C	SEE PAGE 128	ORDER CODES
10	12.6	5.08	7.6	Fig. 1	123-PP-210-41-001101
4	5.0	7.62	10.1	Fig. 2	123-PP-304-41-001101
6	7.6	7.62	10.1	Fig. 3	123-PP-306-41-001101
8	10.1	7.62	10.1	Fig. 4	123-PP-308-41-001101
10	12.6	7.62	10.1	Fig. 5	123-PP-310-41-001101
12	15.2	7.62	10.1	Fig. 6	123-PP-312-41-001101
14	17.7	7.62	10.1	Fig. 7	123-PP-314-41-001101
16	20.3	7.62	10.1	Fig. 8	123-PP-316-41-001101
18	22.8	7.62	10.1	Fig. 9	123-PP-318-41-001101
20	25.3	7.62	10.1	Fig. 10	123-PP-320-41-001101
22	27.8	7.62	10.1	Fig. 11	123-PP-322-41-001101
24	30.4	7.62	10.1	Fig. 12	123-PP-324-41-001101
28	35.5	7.62	10.1	Fig. 13	123-PP-328-41-001101
20	25.4	10.16	12.6	Fig. 14	123-PP-420-41-001101
22	27.8	10.16	12.6	Fig. 15	123-PP-422-41-001101
24	30.4	10.16	12.6	Fig. 16	123-PP-424-41-001101
28	35.5	10.16	12.6	Fig. 17	123-PP-428-41-001101
32	40.6	10.16	12.6	Fig. 18	123-PP-432-41-001101
10	12.7	15.24	17.7	Fig. 19	123-PP-610-41-001101
24	30.5	15.24	17.7	Fig. 20	123-PP-624-41-001101
28	35.5	15.24	17.7	Fig. 21	123-PP-628-41-001101
32	40.6	15.24	17.7	Fig. 22	123-PP-632-41-001101
36	45.7	15.24	17.7	Fig. 23	123-PP-636-41-001101
40	50.8	15.24	17.7	Fig. 24	123-PP-640-41-001101
42	53.3	15.24	17.7	Fig. 25	123-PP-642-41-001101
48	60.9	15.24	17.7	Fig. 26	123-PP-648-41-001101
50	63.5	15.24	17.7	Fig. 27	123-PP-650-41-001101
52	66.0	15.24	17.7	Fig. 28	123-PP-652-41-001101
50	63.5	22.86	25.3	Fig. 29	123-PP-950-41-001101
52	66.0	22.86	25.3	Fig. 30	123-PP-952-41-001101
64	81.2	22.86	25.3	Fig. 31	123-PP-964-41-001101

## OPTION

Other lengths for 1-level, 2-level or 4-level wrapping available on request

Replace 123-... in order code by

- 121-83-...	for 1-level	L = 6.6 mm
- 122-...	for 2-level	L = 9.4 mm
- 124-83-...-002101	for 4-level	L = 16 mm



preci-dip

WWW.PRECIDIP.COM TEL +41 32 421 04 00 SALES@PRECIDIP.COM

# DUAL-IN-LINE SOCKETS

INSULATOR BODIES / SHRINKDIP, OPEN FRAME

316

Fig. 1

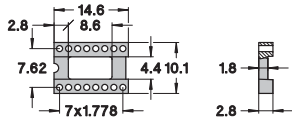

642

Fig. 10

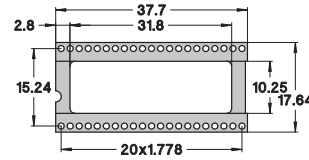

764

Fig. 16

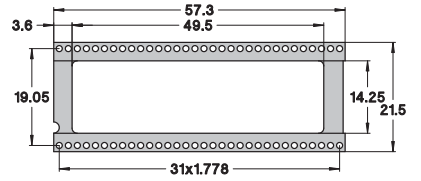

428

Fig. 2

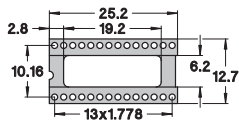

648

Fig. 11

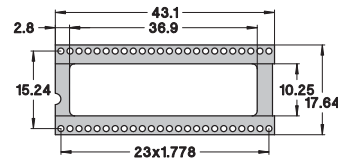

430

Fig. 3

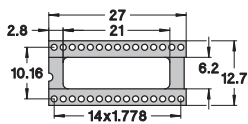

652

Fig. 12

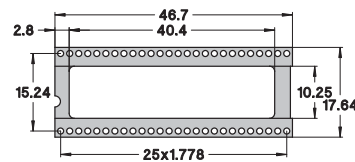

432

Fig. 4

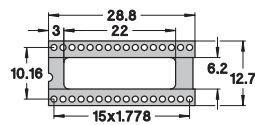

656

Fig. 13

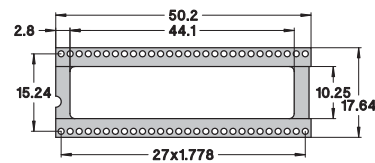

448

Fig. 5

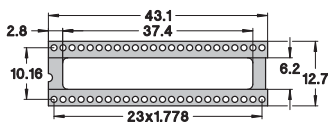

664

Fig. 14

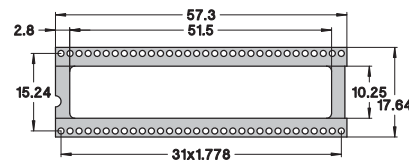

620

Fig. 6

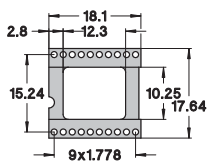

668

Fig. 15

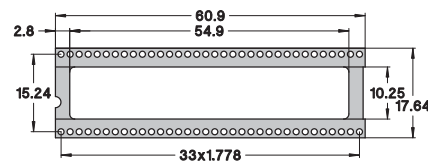

624

Fig. 7

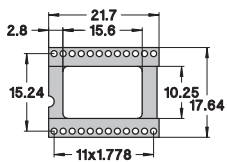

628

Fig. 8

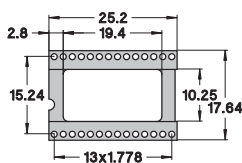

640

Fig. 9

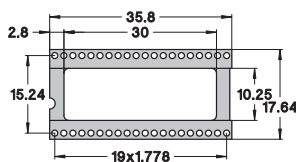

## ORDERING INFORMATION

Example:

117-PP-624-41-005101 (Order Code)

624  
Fig. 7

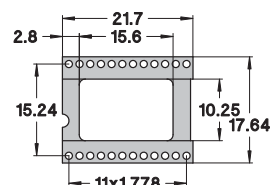



preci-dip

WWW.PRECIDIP.COM TEL +41 32 421 04 00 SALES@PRECIDIP.COM

# SHRINKDIP SOCKETS

OPEN FRAME / SOLDER TAIL

High density DIL sockets for devices featuring 0.07" (1.778 mm) lead spacing.

## TECHNICAL SPECIFICATIONS (FOR GENERAL SPECS, SEE PAGE 127)

<b>INSULATOR</b>	Black glass filled polyester PCT-GF30-FR
<b>FLAMMABILITY</b>	UL 94V-0
<b>SLEEVE</b>	Brass CuZn36Pb3 (C36000)
<b>CONTACT CLIP (4 FINGER)</b>	Beryllium copper (C17200)
<b>ACCEPTED PIN Ø</b>	0.40 to 0.56 mm
<b>FORCES</b>	2 N typ. insertion      1 N typ. withdrawal (polished steel gauge Ø 0.43 mm)
<b>MECHANICAL LIFE</b>	Min. 100 cycles
<b>RATED CURRENT</b>	1 A
<b>CONTACT RESISTANCE</b>	Max. 10 mΩ
<b>DIELECTRIC STRENGTH</b>	Min. 1'000 VRMS

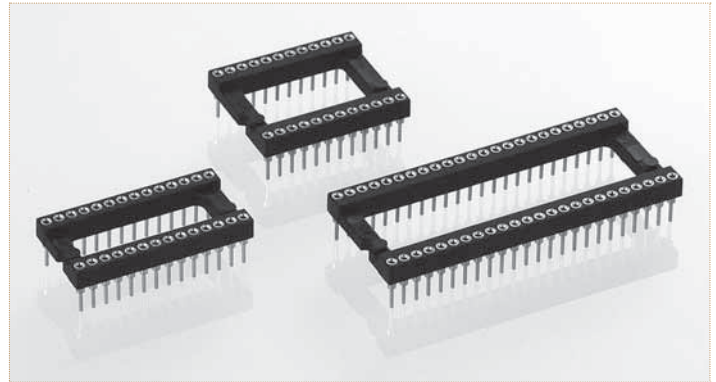

## ORDERING INFORMATION ROHS COMPLIANT PARTS

<b>PP PLATING CODE</b>	<b>SLEEVE</b>	<b>CLIP</b>
87	Tin	Flash gold
83	Tin	0.75 µm gold

Other plating on request (see page 178 for plating specs).

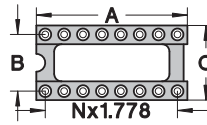
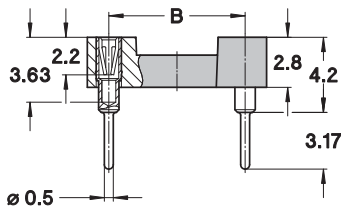

NO. OF POLES	A	B	C	SEE PAGE 140	ORDER CODES
16	14.6	7.62	10.10	Fig. 1	117-PP-316-41-005101
28	25.2	10.16	12.70	Fig. 2	117-PP-428-41-005101
30	27.0	10.16	12.70	Fig. 3	117-PP-430-41-005101
32	28.8	10.16	12.70	Fig. 4	117-PP-432-41-005101
48	43.1	10.16	12.70	Fig. 5	117-PP-448-41-005101
20	18.1	15.24	17.64	Fig. 6	117-PP-620-41-005101
24	21.7	15.24	17.64	Fig. 7	117-PP-624-41-005101
28	25.2	15.24	17.64	Fig. 8	117-PP-628-41-005101
40	35.8	15.24	17.64	Fig. 9	117-PP-640-41-005101
42	37.7	15.24	17.64	Fig. 10	117-PP-642-41-005101
48	43.1	15.24	17.64	Fig. 11	117-PP-648-41-005101
52	46.7	15.24	17.64	Fig. 12	117-PP-652-41-005101
56	50.2	15.24	17.64	Fig. 13	117-PP-656-41-005101
64	57.3	15.24	17.64	Fig. 14	117-PP-664-41-005101
68	60.9	15.24	17.64	Fig. 15	117-PP-668-41-005101
64*	57.3	19.05	21.50	Fig. 16	117-PP-764-41-005101

## OPTIONS AVAILABLE ON REQUEST

- \* Socket 117-PP-764-41-005101 available with closed frame insulator PN 217-PP-764-41-005101
- Surface mount Shrinkdip socket with gull wing terminations Series 117-...-41-105101
- Shrinkdip pin header, solder tail Series 150-10...-00-012101 or 150-80...-00-012101

Please consult





preci-dip

WWW.PRECIDIP.COM TEL +41 32 421 04 00 SALES@PRECIDIP.COM

# DUAL-IN-LINE SOCKETS

OPEN FRAME / PRESS-FIT

DIL Sockets with compliant press-fit pin for solderless mount in PCB plated through holes.

## TECHNICAL SPECIFICATIONS (FOR GENERAL SPECS, SEE PAGE 127)

<b>INSULATOR</b>	Black glass filled polyester PCT-GF30-FR
<b>FLAMMABILITY</b>	UL 94V-0
<b>SLEEVE</b>	Bronze CuSn4Pb4Zn4 (C54400)
<b>CONTACT CLIP (4 FINGER)</b>	Beryllium copper (C17200)
<b>ACCEPTED PIN Ø</b>	0.40 to 0.56 mm
<b>FORCES</b>	2 N typ. insertion      1 N typ. withdrawal (polished steel gauge Ø 0.43 mm)
<b>MECHANICAL LIFE</b>	Min. 500 cycles
<b>RATED CURRENT</b>	1 A
<b>CONTACT RESISTANCE</b>	Max. 10 mΩ
<b>DIELECTRIC STRENGTH</b>	Min. 1'000 V <sub>RMS</sub>
<b>PCB HOLE Ø</b>	1 +0.09/-0.06 mm finished (1.15 ±0.025 mm drill)

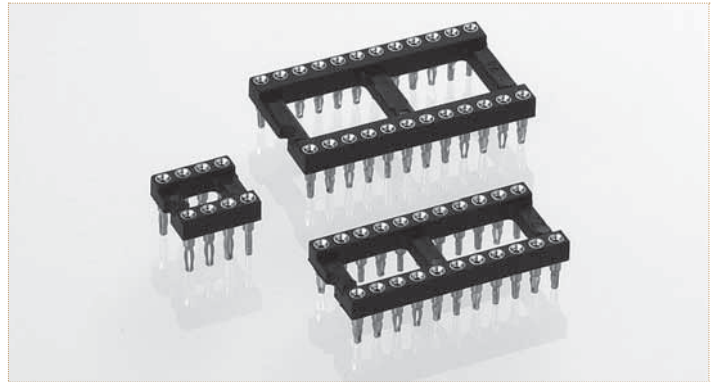

## ORDERING INFORMATION ROHS COMPLIANT PARTS

PP PLATING CODE	SLEEVE	CLIP
87	Tin	Flash gold
83	Tin	0.75 µm gold

Other plating on request (see page 178 for plating specs).

For complete part number replace **XXX** with the code given below left for the required contact length **L**.

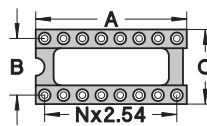
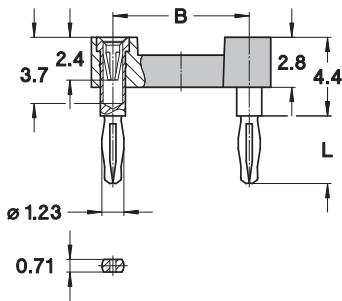

NO. OF POLES	A	B	C	SEE PAGE 128	ORDER CODES
10	12.6	5.08	7.6	Fig. 1	146-PP-210-41-XXX101
4	5.0	7.62	10.1	Fig. 2	146-PP-304-41-XXX101
6	7.6	7.62	10.1	Fig. 3	146-PP-306-41-XXX101
8	10.1	7.62	10.1	Fig. 4	146-PP-308-41-XXX101
10	12.6	7.62	10.1	Fig. 5	146-PP-310-41-XXX101
12	15.2	7.62	10.1	Fig. 6	146-PP-312-41-XXX101
14	17.7	7.62	10.1	Fig. 7	146-PP-314-41-XXX101
16	20.3	7.62	10.1	Fig. 8	146-PP-316-41-XXX101
18	22.8	7.62	10.1	Fig. 9	146-PP-318-41-XXX101
20	25.3	7.62	10.1	Fig. 10	146-PP-320-41-XXX101
22	27.8	7.62	10.1	Fig. 11	146-PP-322-41-XXX101
24	30.4	7.62	10.1	Fig. 12	146-PP-324-41-XXX101
28	35.5	7.62	10.1	Fig. 13	146-PP-328-41-XXX101
20	25.4	10.16	12.6	Fig. 14	146-PP-420-41-XXX101
22	27.8	10.16	12.6	Fig. 15	146-PP-422-41-XXX101
24	30.4	10.16	12.6	Fig. 16	146-PP-424-41-XXX101
28	35.5	10.16	12.6	Fig. 17	146-PP-428-41-XXX101
32	40.6	10.16	12.6	Fig. 18	146-PP-432-41-XXX101
24	30.5	15.24	17.7	Fig. 20	146-PP-624-41-XXX101
28	35.5	15.24	17.7	Fig. 21	146-PP-628-41-XXX101
32	40.6	15.24	17.7	Fig. 22	146-PP-632-41-XXX101
36	45.7	15.24	17.7	Fig. 23	146-PP-636-41-XXX101
40	50.8	15.24	17.7	Fig. 24	146-PP-640-41-XXX101

## AVAILABLE CONTACT LENGTH

CONTACT LENGTH L (mm)	PCB THICKNESS (mm)	XXX CODE
2.8	1.5-2.0	036
3.8	2.1-3.2	035



precidip

WWW.PRECIDIP.COM TEL +41 32 421 04 00 SALES@PRECIDIP.COM

# DUAL-IN-LINE PIN CARRIER ASSEMBLIES

LOW PROFILE / LOW PROFILE ULTRA THIN / SOLDER TAIL

Easy mounting due to the disposable plastic carrier, no solder or flux wicking problems.

## TECHNICAL SPECIFICATIONS (FOR GENERAL SPECS, SEE PAGE 127)

<b>INSULATOR</b>	Black glass filled polyester PCT-GF30-FR
<b>FLAMMABILITY</b>	UL 94V-0
<b>SLEEVE</b>	Brass CuZn36Pb3 (C36000)
<b>CONTACT CLIP (4 FINGER) (3 FINGER)</b>	Beryllium copper (C17200) (Series 614...012101)
<b>ACCEPTED PIN Ø</b>	0.40 to 0.56 mm
<b>FORCES</b>	2 N typ. (1.0 N typ. 614...012001) insertion 1 N typ. (0.4 N typ. 614...012001) withdrawal (polished steel gauge Ø 0.43 mm)
<b>MECHANICAL LIFE</b>	Min. 100 cycles
<b>RATED CURRENT</b>	1 A
<b>CONTACT RESISTANCE</b>	Max. 10 mΩ
<b>DIELECTRIC STRENGTH</b>	Min. 1'000 V <sub>RMS</sub>

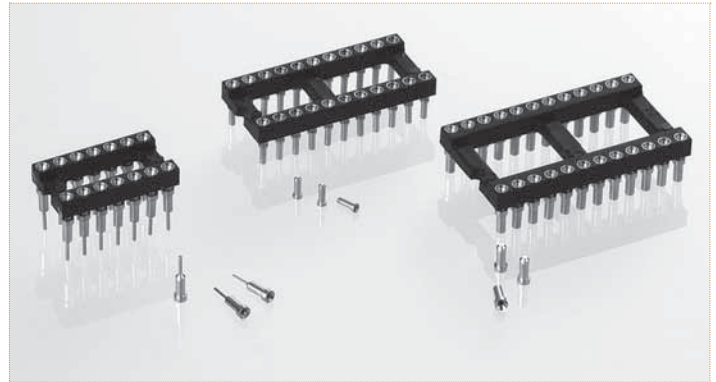

## ORDERING INFORMATION ROHS COMPLIANT PARTS

PP PLATING CODE	SLEEVE	CLIP
87	Tin	Flash gold
83	Tin	0.75 µm gold

Other plating on request (see page 178 for plating specs).

For complete part number replace X-...-XX-XXX with the code given below left.

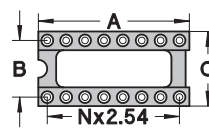
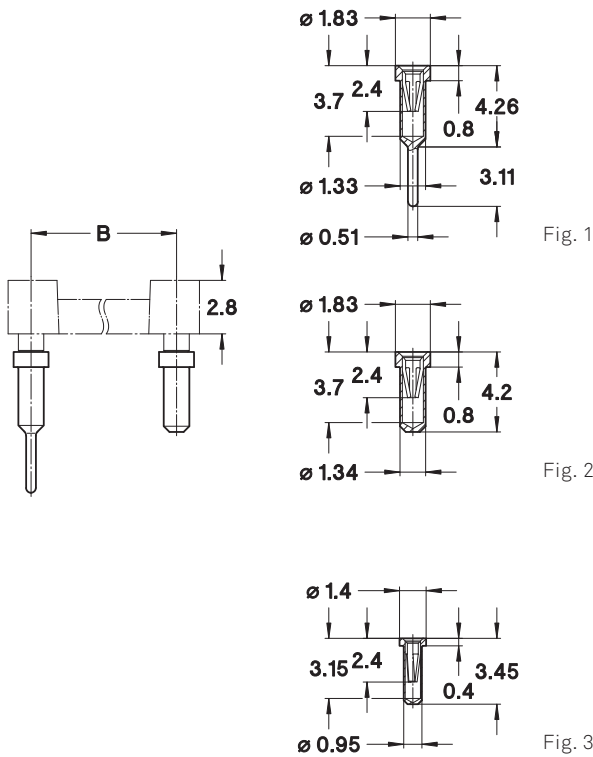

NO. OF POLES	A	B	C	SEE PAGE 128	ORDER CODES
10	12.6	5.08	7.6	Fig. 1	61X-PP-210-XX-XXX101
4	5.0	7.62	10.1	Fig. 2	61X-PP-304-XX-XXX101
6	7.6	7.62	10.1	Fig. 3	61X-PP-306-XX-XXX101
8	10.1	7.62	10.1	Fig. 4	61X-PP-308-XX-XXX101
10	12.6	7.62	10.1	Fig. 5	61X-PP-310-XX-XXX101
12	15.2	7.62	10.1	Fig. 6	61X-PP-312-XX-XXX101
14	17.7	7.62	10.1	Fig. 7	61X-PP-314-XX-XXX101
16	20.3	7.62	10.1	Fig. 8	61X-PP-316-XX-XXX101
18	22.8	7.62	10.1	Fig. 9	61X-PP-318-XX-XXX101
20	25.3	7.62	10.1	Fig. 10	61X-PP-320-XX-XXX101
22	27.8	7.62	10.1	Fig. 11	61X-PP-322-XX-XXX101
24	30.4	7.62	10.1	Fig. 12	61X-PP-324-XX-XXX101
28	35.5	7.62	10.1	Fig. 13	61X-PP-328-XX-XXX101
20	25.4	10.16	12.6	Fig. 14	61X-PP-420-XX-XXX101
22	27.8	10.16	12.6	Fig. 15	61X-PP-422-XX-XXX101
24	30.4	10.16	12.6	Fig. 16	61X-PP-424-XX-XXX101
28	35.5	10.16	12.6	Fig. 17	61X-PP-428-XX-XXX101
32	40.6	10.16	12.6	Fig. 18	61X-PP-432-XX-XXX101
10	12.7	15.24	17.7	Fig. 19	61X-PP-610-XX-XXX101
24	30.5	15.24	17.7	Fig. 20	61X-PP-624-XX-XXX101
28	35.5	15.24	17.7	Fig. 21	61X-PP-628-XX-XXX101
32	40.6	15.24	17.7	Fig. 22	61X-PP-632-XX-XXX101
36	45.7	15.24	17.7	Fig. 23	61X-PP-636-XX-XXX101
40	50.8	15.24	17.7	Fig. 24	61X-PP-640-XX-XXX101
42	53.3	15.24	17.7	Fig. 25	61X-PP-642-XX-XXX101
48	60.9	15.24	17.7	Fig. 26	61X-PP-648-XX-XXX101
50	63.5	15.24	17.7	Fig. 27	61X-PP-650-XX-XXX101
52	66.0	15.24	17.7	Fig. 28	61X-PP-652-XX-XXX101
50	63.5	22.86	25.3	Fig. 29	61X-PP-950-XX-XXX101
52	66.0	22.86	25.3	Fig. 30	61X-PP-952-XX-XXX101
64	81.2	22.86	25.3	Fig. 31	61X-PP-964-XX-XXX101

## AVAILABLE VERSIONS

- Standard carrier 612...-41-001101  
see Fig. 1
- Low profile 614...-41-001101  
see Fig. 2 for PCB hole Ø 1.4-1.8 mm
- Low profile, ultra thin 614...-31-012101  
see Fig. 3 for PCB hole Ø 1.0-1.3 mm



preci-dip

WWW.PRECIDIP.COM TEL +41 32 421 04 00 SALES@PRECIDIP.COM

# DUAL-IN-LINE SOCKETS

RIGHT ANGLE VERSION / CLOSED FRAME / SOLDER TAIL

Right angle DIL Sockets for components to be mounted perpendicularly to the PCB such as displays.

## TECHNICAL SPECIFICATIONS (FOR GENERAL SPECS, SEE PAGE 127)

<b>INSULATOR</b>	Black glass filled polyester PCT-GF30-FR
<b>FLAMMABILITY</b>	UL 94V-0
<b>SLEEVE</b>	Brass CuZn36Pb3 (C36000)
<b>CONTACT CLIP (4 FINGER)</b>	Beryllium copper (C17200)
<b>ACCEPTED PIN Ø</b>	0.40 to 0.56 mm
<b>FORCES</b>	2 N typ. insertion      1 N typ. withdrawal (polished steel gauge Ø 0.43 mm)
<b>MECHANICAL LIFE</b>	Min. 100 cycles
<b>RATED CURRENT</b>	1 A
<b>CONTACT RESISTANCE</b>	Max. 10 mΩ
<b>DIELECTRIC STRENGTH</b>	Min. 1'000 V <sub>RMS</sub>

## ORDERING INFORMATION ROHS COMPLIANT PARTS

<b>PP PLATING CODE</b>	<b>SLEEVE</b>	<b>CLIP</b>
87	Tin	Flash gold
83	Tin	0.75 µm gold

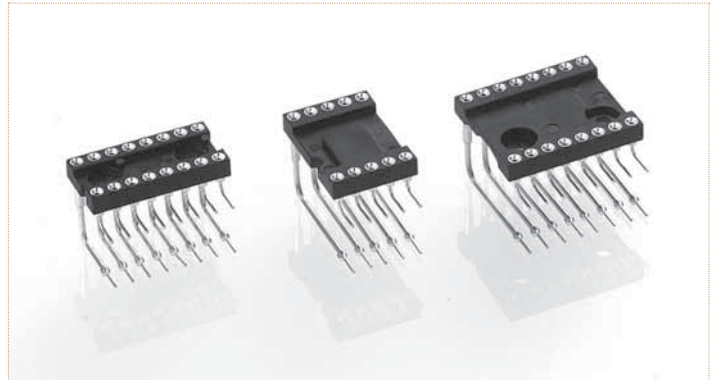

Other plating on request (see page 178 for plating specs).

For complete part number replace **XX** with the code given below left.

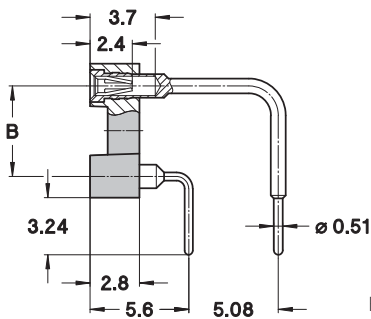

Fig. 1

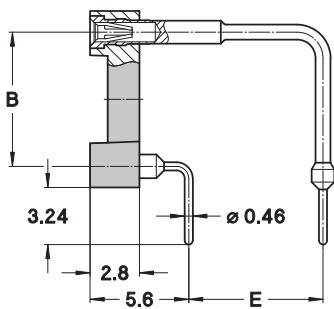

Fig. 2

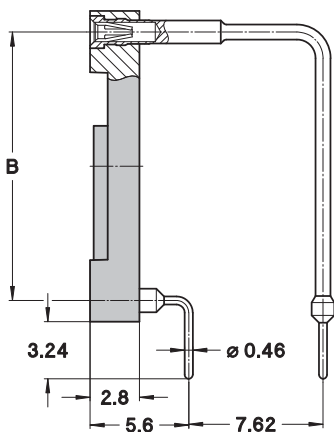
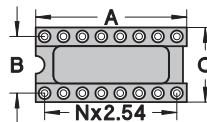

Fig. 3

### ROW SPACING E

<b>E (mm)</b>	<b>ORDER CODE XX</b>
7.62	299... <b>10</b> -001101
2.54	299... <b>11</b> -001101



NO. OF POLES	A	B	C	SEE	ORDER CODES
10	12.6	5.08	7.6	Fig. 1	299-PP-210-10-001101
6	7.6	7.62	10.1	Fig. 2	299-PP-306-XX-001101
8	10.1	7.62	10.1	Fig. 2	299-PP-308-XX-001101
10	12.6	7.62	10.1	Fig. 2	299-PP-310-XX-001101
12	15.2	7.62	10.1	Fig. 2	299-PP-312-XX-001101
14	17.7	7.62	10.1	Fig. 2	299-PP-314-XX-001101
16	20.3	7.62	10.1	Fig. 2	299-PP-316-XX-001101
18	22.8	7.62	10.1	Fig. 2	299-PP-318-XX-001101
20	25.3	7.62	10.1	Fig. 2	299-PP-320-XX-001101
22	27.8	7.62	10.1	Fig. 2	299-PP-322-XX-001101
24	30.4	7.62	10.1	Fig. 2	299-PP-324-XX-001101
8	10.1	15.24	17.7	Fig. 3	299-PP-608-10-002101
10	12.6	15.24	17.7	Fig. 3	299-PP-610-10-002101
12	15.2	15.24	10.1	Fig. 3	299-PP-612-10-002101
14	17.7	15.24	10.1	Fig. 3	299-PP-614-10-002101
16	20.1	15.24	17.7	Fig. 3	299-PP-616-10-002101
18	22.8	15.24	17.7	Fig. 3	299-PP-618-10-002101
20	25.3	15.24	17.7	Fig. 3	299-PP-620-10-002101
22	27.8	15.24	17.7	Fig. 3	299-PP-622-10-002101
24	30.4	15.24	17.7	Fig. 3	299-PP-624-10-002101
26	33.0	15.24	17.7	Fig. 3	299-PP-626-10-002101
28	35.5	15.24	17.7	Fig. 3	299-PP-628-10-002101
30	38.0	15.24	17.7	Fig. 3	299-PP-630-10-002101
32	40.6	15.24	17.7	Fig. 3	299-PP-632-10-002101
36	45.7	15.24	17.7	Fig. 3	299-PP-636-10-002101
40	50.6	15.24	17.7	Fig. 3	299-PP-640-10-002101
48	61.0	15.24	17.7	Fig. 3	299-PP-648-10-002101



preci-dip

WWW.PRECIDIP.COM TEL +41 32 421 04 00 SALES@PRECIDIP.COM

# DUAL-IN-LINE PIN HEADERS

OPEN FRAME / SOLDER TAIL

DIL pin headers with male contacts pluggable into standard female socket contacts.

## TECHNICAL SPECIFICATIONS (FOR GENERAL SPECS, SEE PAGE 127)

<b>INSULATOR</b>	Black glass filled polyester PCT-GF30-FR
<b>FLAMMABILITY</b>	UL 94V-0
<b>CONTACT</b>	Brass CuZn36Pb3 (C36000)
<b>CONNECTING PIN Ø</b>	0.47 mm / 0.76 mm
<b>MECHANICAL LIFE</b>	Min. 100 cycles
<b>RATED CURRENT</b>	1 A
<b>DIELECTRIC STRENGTH</b>	Min. 1'000 V <sub>RMS</sub>

## ORDERING INFORMATION ROHS COMPLIANT PARTS

<b>PP PLATING CODE</b>	<b>TERMINATION</b>	<b>CONNECTING PIN</b>
10	0.25 µm gold	0.25 µm gold
80	Tin	Tin

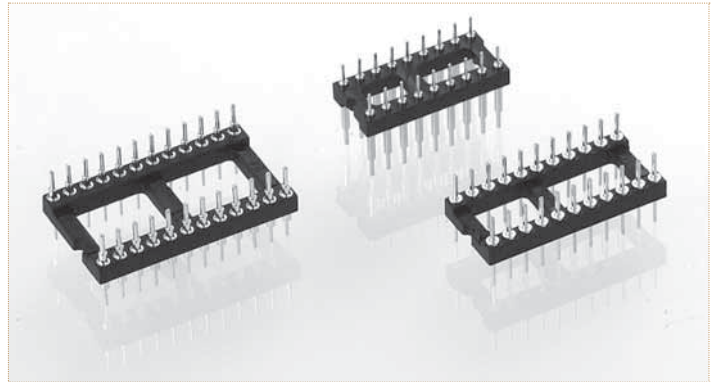

Other plating on request (see page 178 for plating specs).

For complete part number replace X-...-XXX with the code given below left.

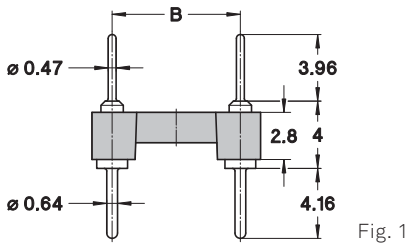

Fig. 1

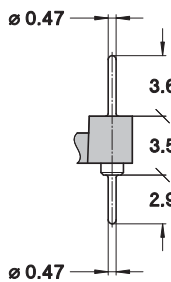

Fig. 2

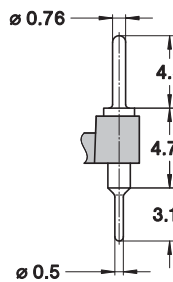

Fig. 3

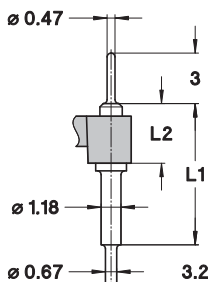
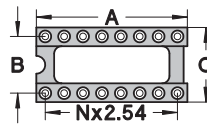

Fig. 4



NO. OF POLES	A	B	C	SEE PAGE 128	ORDER CODES
10	12.6	5.08	7.6	Fig. 1	15X-PP-210-00-XXX101
4	5.0	7.62	10.1	Fig. 2	15X-PP-304-00-XXX101
6	7.6	7.62	10.1	Fig. 3	15X-PP-306-00-XXX101
8	10.1	7.62	10.1	Fig. 4	15X-PP-308-00-XXX101
10	12.6	7.62	10.1	Fig. 5	15X-PP-310-00-XXX101
12	15.2	7.62	10.1	Fig. 6	15X-PP-312-00-XXX101
14	17.7	7.62	10.1	Fig. 7	15X-PP-314-00-XXX101
16	20.3	7.62	10.1	Fig. 8	15X-PP-316-00-XXX101
18	22.8	7.62	10.1	Fig. 9	15X-PP-318-00-XXX101
20	25.3	7.62	10.1	Fig. 10	15X-PP-320-00-XXX101
22	27.8	7.62	10.1	Fig. 11	15X-PP-322-00-XXX101
24	30.4	7.62	10.1	Fig. 12	15X-PP-324-00-XXX101
28	35.5	7.62	10.1	Fig. 13	15X-PP-328-00-XXX101
20	25.4	10.16	12.6	Fig. 14	15X-PP-420-00-XXX101
22	27.8	10.16	12.6	Fig. 15	15X-PP-422-00-XXX101
24	30.4	10.16	12.6	Fig. 16	15X-PP-424-00-XXX101
28	35.5	10.16	12.6	Fig. 17	15X-PP-428-00-XXX101
32	40.6	10.16	12.6	Fig. 18	15X-PP-432-00-XXX101
10	12.7	15.24	17.7	Fig. 19	15X-PP-610-00-XXX101
24	30.5	15.24	17.7	Fig. 20	15X-PP-624-00-XXX101
28	35.5	15.24	17.7	Fig. 21	15X-PP-628-00-XXX101
32	40.6	15.24	17.7	Fig. 22	15X-PP-632-00-XXX101
36	45.7	15.24	17.7	Fig. 23	15X-PP-636-00-XXX101
40	50.8	15.24	17.7	Fig. 24	15X-PP-640-00-XXX101
42	53.3	15.24	17.7	Fig. 25	15X-PP-642-00-XXX101
48	60.9	15.24	17.7	Fig. 26	15X-PP-648-00-XXX101
50	63.5	15.24	17.7	Fig. 27	15X-PP-650-00-XXX101
52	66.0	15.24	17.7	Fig. 28	15X-PP-652-00-XXX101
50	63.5	22.86	25.3	Fig. 29	15X-PP-950-00-XXX101
52	66.0	22.86	25.3	Fig. 30	15X-PP-952-00-XXX101
64	81.2	22.86	25.3	Fig. 31	15X-PP-964-00-XXX101

## AVAILABLE VERSIONS

### STANDARD HEADER

150-...-001101	See Fig. 1
150-...-006101	See Fig. 2
150-...-018101	See Fig. 3

### INTERCONNECT HEADER

151-...-XXX101	See Fig. 4
----------------	------------

### CONTACT LENGTH

L1 (mm)	L2 (mm)	XXX CODE
6.2	4.7	003
8.4	3.55	004
15.3	3.55	005
21.2	3.55	016
27.4	3.55	017

Other lengths on request



preci-dip

WWW.PRECIDIP.COM TEL +41 32 421 04 00 SALES@PRECIDIP.COM

# DUAL-IN-LINE PIN HEADERS

OPEN FRAME / SURFACE MOUNT

Specially designed for reflow soldering including vapor phase with male contacts pluggable into standard socket contacts and gull wing terminations.

## TECHNICAL SPECIFICATIONS (FOR GENERAL SPECS, SEE PAGE 127)

INSULATOR	Black glass filled polyester PCT-GF30-FR
FLAMMABILITY	UL 94V-0
CONTACT	Brass CuZn36Pb3 (C36000)
CONNECTING PIN Ø	0.47 mm
MECHANICAL LIFE	Min. 100 cycles
RATED CURRENT	1 A
DIELECTRIC STRENGTH	Min. 1'000 V <sub>RMS</sub>
COPLANARITY	
SMD TERMINATIONS	Max. 0.10 mm

## ORDERING INFORMATION ROHS COMPLIANT PARTS

PP PLATING CODE	TERMINATION	CONNECTING PIN
10	0.25 µm gold	0.25 µm gold
80	Tin	Tin
V3	Tin	0.75 µm gold

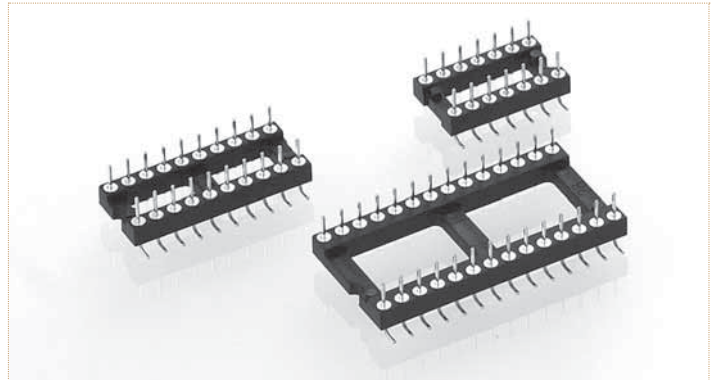

Other plating on request (see page 178 for plating specs).

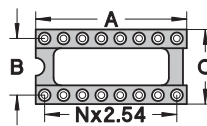
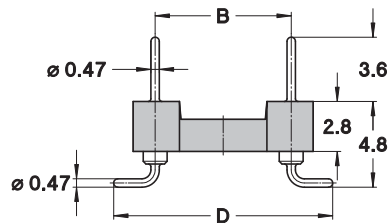

NO. OF POLES	A	B	C	D	SEE PAGE 128	ORDER CODES
10	12.6	5.08	7.6	9.76	Fig. 1	150-PP-210-00-106101
4	5.0	7.62	10.1	12.30	Fig. 2	150-PP-304-00-106101
6	7.6	7.62	10.1	12.30	Fig. 3	150-PP-306-00-106101
8	10.1	7.62	10.1	12.30	Fig. 4	150-PP-308-00-106101
10	12.6	7.62	10.1	12.30	Fig. 5	150-PP-310-00-106101
12	15.2	7.62	10.1	12.30	Fig. 6	150-PP-312-00-106101
14	17.7	7.62	10.1	12.30	Fig. 7	150-PP-314-00-106101
16	20.3	7.62	10.1	12.30	Fig. 8	150-PP-316-00-106101
18	22.8	7.62	10.1	12.30	Fig. 9	150-PP-318-00-106101
20	25.3	7.62	10.1	12.30	Fig. 10	150-PP-320-00-106101
22	27.8	7.62	10.1	12.30	Fig. 11	150-PP-322-00-106101
24	30.4	7.62	10.1	12.30	Fig. 12	150-PP-324-00-106101
28	35.5	7.62	10.1	12.30	Fig. 13	150-PP-328-00-106101
20	25.4	10.16	12.6	14.84	Fig. 14	150-PP-420-00-106101
22	27.8	10.16	12.6	14.84	Fig. 15	150-PP-422-00-106101
24	30.4	10.16	12.6	14.84	Fig. 16	150-PP-424-00-106101
28	35.5	10.16	12.6	14.84	Fig. 17	150-PP-428-00-106101
32	40.6	10.16	12.6	14.84	Fig. 18	150-PP-432-00-106101
24	30.5	15.24	17.7	19.92	Fig. 20	150-PP-624-00-106101
28	35.5	15.24	17.7	19.92	Fig. 21	150-PP-628-00-106101
32	40.6	15.24	17.7	19.92	Fig. 22	150-PP-632-00-106101
36	45.7	15.24	17.7	19.92	Fig. 23	150-PP-636-00-106101
40	50.8	15.24	17.7	19.92	Fig. 24	150-PP-640-00-106101
42	53.3	15.24	17.7	19.92	Fig. 25	150-PP-642-00-106101
48	60.9	15.24	17.7	19.92	Fig. 26	150-PP-648-00-106101

## PCB LAYOUT

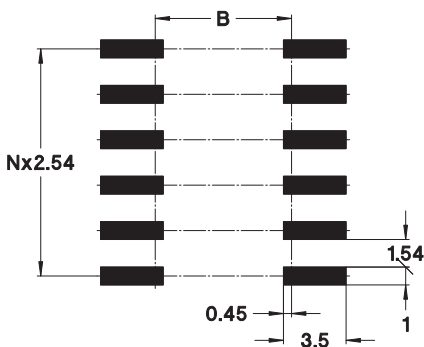





preci-dip

WWW.PRECIDIP.COM TEL +41 32 421 04 00 SALES@PRECIDIP.COM

# DUAL-IN-LINE PIN HEADERS

OPEN FRAME / SURFACE MOUNT PICK AND PLACE

Specially designed for reflow soldering including vapor phase with male contact pluggable into standard socket contacts.

## TECHNICAL SPECIFICATIONS (FOR GENERAL SPECS, SEE PAGE 127)

INSULATOR	Black glass filled polyester PCT-GF30-FR
FLAMMABILITY	UL 94V-0
CONTACT	Brass CuZn36Pb3 (C36000)
CONNECTING PIN Ø	0.47 mm
MECHANICAL LIFE	Min. 100 cycles
RATED CURRENT	1 A
DIELECTRIC STRENGTH	Min. 1'000 V <sub>RMS</sub>
COPLANARITY	
SMD TERMINATIONS	Max. 0.10 mm

## ORDERING INFORMATION ROHS COMPLIANT PARTS

PP PLATING CODE	TERMINATION	CONNECTING PIN
10	0.25 µm gold	0.25 µm gold
80	Tin	Tin
V3*	Tin	0.75 µm gold

\*only for 150-PP-XXX-00-106161

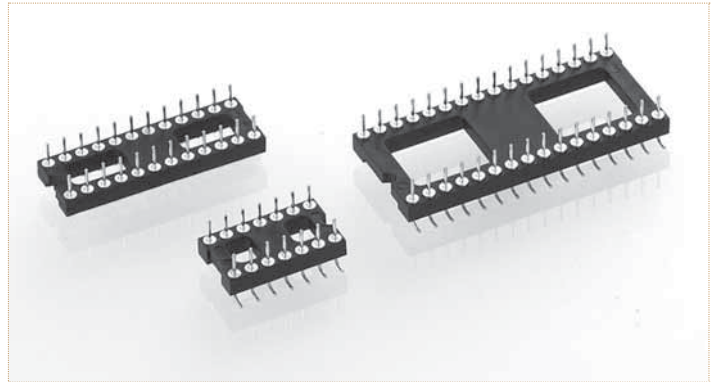

Other plating on request (see page 178 for plating specs).

### Tape & Reel packaging:

replace 161 by suffix 191 to part number. Other pin counts please consult. Please consult [www.precidip.com](http://www.precidip.com) for availability size of tape, size of reel, number of components per reel and packing units.

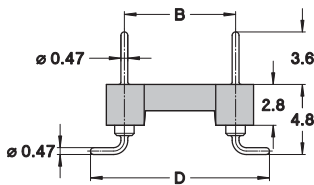

INSULATOR

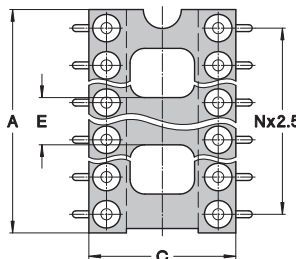

PCB LAYOUT

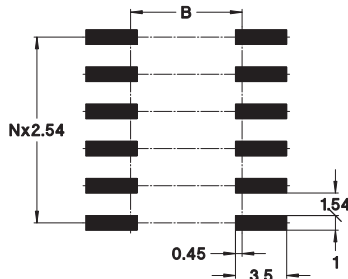

## HEADER WITH GULL-WING TERMINATION

NO. OF POLES	A	B	C	D	E	ORDER CODES
6	7.6	7.62	10.1	12.30	7.6	150-PP-306-00-106161
8	10.1	7.62	10.1	12.30	10.1	150-PP-308-00-106161
10	12.6	7.62	10.1	12.30	12.6	150-PP-310-00-106161
14	17.8	7.62	10.1	12.30	5.3	150-PP-314-00-106161
16	20.3	7.62	10.1	12.30	5.3	150-PP-316-00-106161
18	22.9	7.62	10.1	12.30	5.3	150-PP-318-00-106161
20	25.4	7.62	10.1	12.30	8.3	150-PP-320-00-106161
24	30.4	7.62	10.1	12.30	8.3	150-PP-324-00-106161
28	35.6	7.62	10.1	12.30	8.3	150-PP-328-00-106161
28	35.5	15.24	17.7	19.22	10.0	150-PP-628-00-106161
32	40.6	15.24	17.7	19.22	10.0	150-PP-632-00-106161
40	50.8	15.24	17.7	19.22	10.0	150-PP-640-00-106161
42	53.4	15.24	17.7	19.22	10.0	150-PP-642-00-106161

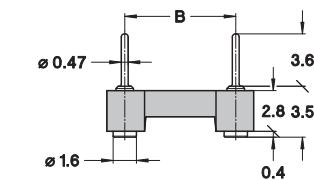

INSULATOR

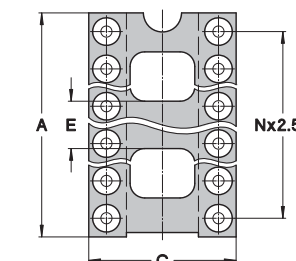

PCB LAYOUT

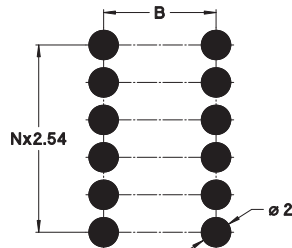

## HEADER WITH FLOATING PIN TERMINATION

NO. OF POLES	A	B	C	D	E	ORDER CODES
6	7.6	7.62	10.1	12.30	7.6	150-PP-306-01-899161
8	10.1	7.62	10.1	12.30	10.1	150-PP-308-01-899161
10	12.6	7.62	10.1	12.30	12.6	150-PP-310-01-899161
14	17.8	7.62	10.1	12.30	5.3	150-PP-314-01-899161
16	20.3	7.62	10.1	12.30	5.3	150-PP-316-01-899161
18	22.9	7.62	10.1	12.30	5.3	150-PP-318-01-899161
20	25.4	7.62	10.1	12.30	8.3	150-PP-320-01-899161
24	30.4	7.62	10.1	12.30	8.3	150-PP-324-01-899161
28	35.6	7.62	10.1	12.30	8.3	150-PP-328-01-899161
28	35.5	15.24	17.7	19.22	10.0	150-PP-628-01-899161
32	40.6	15.24	17.7	19.22	10.0	150-PP-632-01-899161
40	50.8	15.24	17.7	19.22	10.0	150-PP-640-01-899161
42	53.4	15.24	17.7	19.22	10.0	150-PP-642-01-899161



preci-dip

WWW.PRECIDIP.COM TEL +41 32 421 04 00 SALES@PRECIDIP.COM

# DUAL-IN-LINE PIN HEADERS

SLOTTED HEAD / TURRET / SOLDER CUP / OPEN FRAME / SOLDER TAIL

DIL headers for wiring applications.

## TECHNICAL SPECIFICATIONS (FOR GENERAL SPECS, SEE PAGE 127)

<b>INSULATOR</b>	Black glass filled polyester PCT-GF30-FR (Black glass filled polyamide PA66T-GF25-FR for 160-PP-XXX-00-001101/R1 and 180-PP-XXX-00-001101/R1)
<b>FLAMMABILITY</b>	UL 94V-0
<b>CONTACT</b>	Brass CuZn36Pb3 (C36000)
<b>CONNECTING PIN Ø</b>	0.5 mm
<b>MECHANICAL LIFE</b>	Min. 100 cycles
<b>RATED CURRENT</b>	1 A
<b>DIELECTRIC STRENGTH</b>	Min. 1'000 V <sub>RMS</sub>

## ORDERING INFORMATION ROHS COMPLIANT PARTS

PP PLATING CODE	TERMINATION	CONNECTING PIN
10	0.25 µm gold	0.25 µm gold
80	Tin	Tin

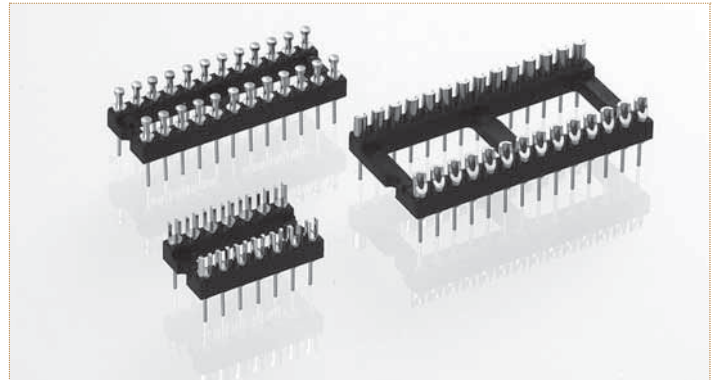

Other plating on request (see page 178 for plating specs).  
For complete part number replace **XX** with the code given below left.

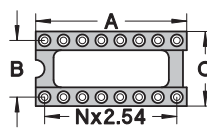
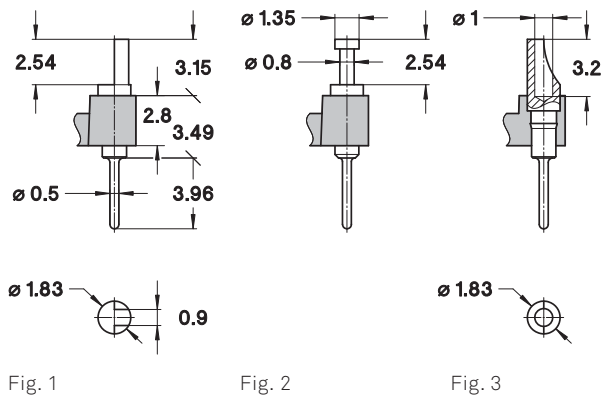

NO. OF POLES	A	B	C	SEE PAGE 128	ORDER CODES
10	12.6	5.08	7.6	Fig. 1	1XX-PP-210-00-001101
4	5.0	7.62	10.1	Fig. 2	1XX-PP-304-00-001101
6	7.6	7.62	10.1	Fig. 3	1XX-PP-306-00-001101
8	10.1	7.62	10.1	Fig. 4	1XX-PP-308-00-001101
10	12.6	7.62	10.1	Fig. 5	1XX-PP-310-00-001101
12	15.2	7.62	10.1	Fig. 6	1XX-PP-312-00-001101
14	17.7	7.62	10.1	Fig. 7	1XX-PP-314-00-001101
16	20.3	7.62	10.1	Fig. 8	1XX-PP-316-00-001101
18	22.8	7.62	10.1	Fig. 9	1XX-PP-318-00-001101
20	25.3	7.62	10.1	Fig. 10	1XX-PP-320-00-001101
22	27.8	7.62	10.1	Fig. 11	1XX-PP-322-00-001101
24	30.4	7.62	10.1	Fig. 12	1XX-PP-324-00-001101
28	35.5	7.62	10.1	Fig. 13	1XX-PP-328-00-001101
20	25.4	10.16	12.6	Fig. 14	1XX-PP-420-00-001101
22	27.8	10.16	12.6	Fig. 15	1XX-PP-422-00-001101
24	30.4	10.16	12.6	Fig. 16	1XX-PP-424-00-001101
28	35.5	10.16	12.6	Fig. 17	1XX-PP-428-00-001101
32	40.6	10.16	12.6	Fig. 18	1XX-PP-432-00-001101
10	12.7	15.24	17.7	Fig. 19	1XX-PP-610-00-001101
24	30.5	15.24	17.7	Fig. 20	1XX-PP-624-00-001101
28	35.5	15.24	17.7	Fig. 21	1XX-PP-628-00-001101
32	40.6	15.24	17.7	Fig. 22	1XX-PP-632-00-001101
36	45.7	15.24	17.7	Fig. 23	1XX-PP-636-00-001101
40	50.8	15.24	17.7	Fig. 24	1XX-PP-640-00-001101
42	53.3	15.24	17.7	Fig. 25	1XX-PP-642-00-001101
48	60.9	15.24	17.7	Fig. 26	1XX-PP-648-00-001101
50	63.5	15.24	17.7	Fig. 27	1XX-PP-650-00-001101
52	66.0	15.24	17.7	Fig. 28	1XX-PP-652-00-001101
50	63.5	22.86	25.3	Fig. 29	1XX-PP-950-00-001101
52	66.0	22.86	25.3	Fig. 30	1XX-PP-952-00-001101
64	81.2	22.86	25.3	Fig. 31	1XX-PP-964-00-001101

## AVAILABLE VERSIONS

Replace **1XX-...** in order code by

ORDER CODE	DESCRIPTION	DIMENSIONS
<b>160</b>	Header with slotted head to accept wires or component leads	See Fig. 1
<b>170</b>	Header with turret head	See Fig. 2
<b>180</b>	Header with solder cup	See Fig. 3



preci-dip

WWW.PRECIDIP.COM TEL +41 32 421 04 00 SALES@PRECIDIP.COM

# TO SOCKETS

SOLDER TAIL / SURFACE MOUNT

Sockets for packages with contacts arranged on .200" (5.08 mm) and .230" (5.84 mm) diameter acc. to JEDEC TO-Series outlines.

## TECHNICAL SPECIFICATIONS (FOR GENERAL SPECS, SEE PAGE 127)

<b>INSULATOR</b>	Black glass filled polyester PCT-GF30-FR
<b>FLAMMABILITY</b>	UL 94V-0
<b>SLEEVE</b>	Brass CuZn36Pb3 (C36000)
<b>CONTACT CLIP (4 FINGER)</b>	Beryllium copper (C17200)
<b>ACCEPTED PIN Ø</b>	0.40 to 0.56 mm
<b>FORCES</b>	2 N typ. insertion      1 N typ. withdrawal (polished steel gauge Ø 0.43 mm)
<b>MECHANICAL LIFE</b>	Min. 100 cycles
<b>RATED CURRENT</b>	1 A
<b>CONTACT RESISTANCE</b>	Max. 10 mΩ
<b>DIELECTRIC STRENGTH</b>	Min. 1'000 V <sub>RMS</sub>



Other plating on request (see page 178 for plating specs).

## ORDERING INFORMATION ROHS COMPLIANT PARTS

<b>PP PLATING CODE</b>	<b>SLEEVE</b>	<b>CLIP</b>
87	Tin	Flash gold
83	Tin	0.75 µm gold

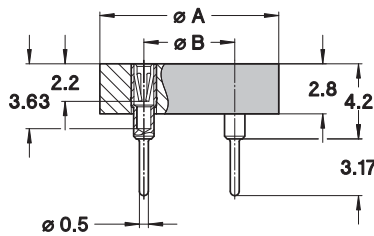

Fig. 1

## SOCKETS, SOLDER TAIL, FIG. 1

NO. OF POLES	A	B	SEE	ORDER CODES
3	10.0	5.08	Fig. 3	917-PP-103-41-005101
4	10.0	5.08	Fig. 4	917-PP-104-41-005101
8	10.0	5.08	Fig. 5	917-PP-108-41-005101
8	10.0	5.84	Fig. 6	917-PP-208-41-005101
10	10.0	5.84	Fig. 7	917-PP-210-41-005101

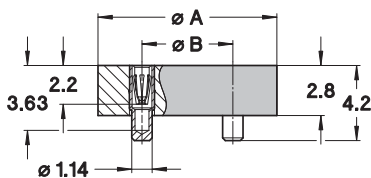

Fig. 2

## SOCKETS, SMD MOUNT, FIG. 2

NO. OF POLES	A	B	SEE	ORDER CODES
3	10.0	5.08	Fig. 3	917-PP-103-41-053101*
4	10.0	5.08	Fig. 4	917-PP-104-41-053101*
8	10.0	5.08	Fig. 5	917-PP-108-41-053101*
8	10.0	5.84	Fig. 6	917-PP-208-41-053101*
10	10.0	5.84	Fig. 7	917-PP-210-41-053101*

### \*Tape & Reel packaging:

replace 101 by suffix 191 to part number. Other pin counts please consult. Please consult [www.precidip.com](http://www.precidip.com) for availability size of tape, size of reel, number of components per reel and packing units.

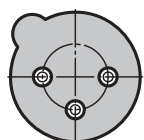

Fig. 3

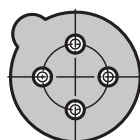

Fig. 4

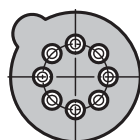

Fig. 5

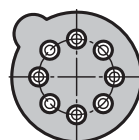

Fig. 6

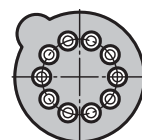

Fig. 7



precidip

WWW.PRECIDIP.COM TEL +41 32 421 04 00 SALES@PRECIDIP.COM

# SPECIFIC APPLICATIONS SOCKETS

SOLDER TAIL / STAGGERED DIL AND SIL SOCKETS

Quad-in-line sockets and staggered (zig-zag) strips are suitable for IC's with staggered double row Dual-in-line type pin patterns.

## TECHNICAL SPECIFICATIONS (FOR GENERAL SPECS, SEE PAGE 127)

<b>INSULATOR</b>	Black glass filled polyester PCT-GF30-FR
<b>FLAMMABILITY</b>	UL 94V-0
<b>SLEEVE</b>	Brass CuZn36Pb3 (C36000)
<b>CONTACT CLIP (4 FINGER)</b>	Beryllium copper (C17200)
<b>ACCEPTED PIN Ø</b>	0.40 to 0.56 mm
<b>FORCES</b>	2 N typ. insertion      1 N typ. withdrawal (polished steel gauge Ø 0.43 mm)
<b>MECHANICAL LIFE</b>	Min. 100 cycles
<b>RATED CURRENT</b>	1 A
<b>CONTACT RESISTANCE</b>	Max. 10 mΩ
<b>DIELECTRIC STRENGTH</b>	Min. 1'000 V <sub>RMS</sub>

## ORDERING INFORMATION ROHS COMPLIANT PARTS

PP PLATING CODE	SLEEVE	CLIP
87	Tin	Flash gold
83	Tin	0.75 µm gold

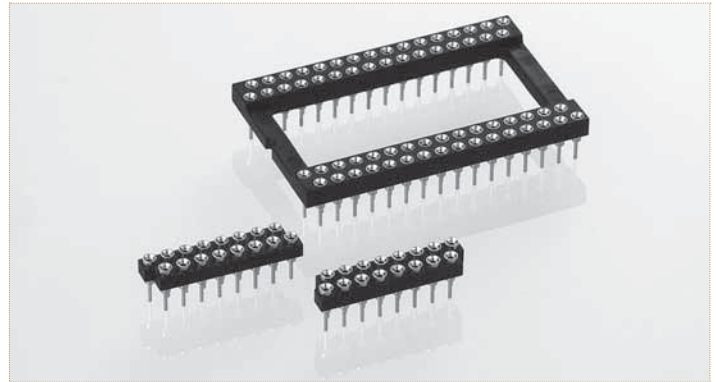

Other plating on request (see page 178 for plating specs).

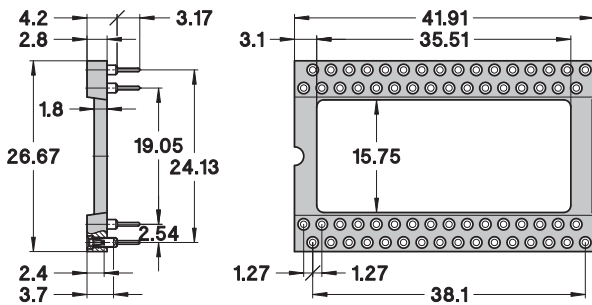

Fig. 1

## QUAD-IN-LINE SOCKET

NO. OF POLES	SEE	ORDER CODES
64	Fig. 1	110-PP-064-01-505101

### Note:

Suitable for quad-in-line packages with 19.05 / 23.50 mm row spacing acc. to JEDEC MO-030.  
Quad-in-line socket layout requires 19.05 / 24.13 mm row spacing.

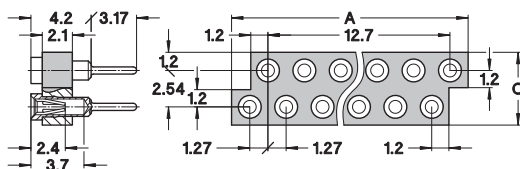

Fig. 2

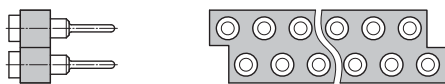

Fig. 3

## STAGGERED ZIG-ZAG STRIPS

NO. OF POLES	A	C	VERSION	SEE	ORDER CODES
14*	19.00	5.0	left	Fig. 2	410-PP-214-10-001101
			right	Fig. 3	410-PP-214-10-002101
16	21.50	5.0	left	Fig. 2	410-PP-216-10-001101
			right	Fig. 3	410-PP-216-10-002101
20	26.57	5.0	left	Fig. 2	410-PP-220-10-001101
			right	Fig. 3	410-PP-220-10-002101
24	31.65	5.0	left	Fig. 2	410-PP-224-10-001101
			right	Fig. 3	410-PP-224-10-002101
28	36.73	5.0	left	Fig. 2	410-PP-228-10-001101
			right	Fig. 3	410-PP-228-10-002101
30	39.27	5.0	left	Fig. 2	410-PP-230-10-001101
			right	Fig. 3	410-PP-230-10-002101
40	52.00	5.0	left	Fig. 2	410-PP-240-10-001101
			right	Fig. 3	410-PP-240-10-002101

\* 14-pin strips are not stackable end to end



precidip

WWW.PRECIDIP.COM TEL +41 32 421 04 00 SALES@PRECIDIP.COM

# SPECIFIC APPLICATIONS SOCKETS

CRYSTAL, RELAY AND DISPLAY SOCKETS / SOLDER TAIL

Partially equipped DIL sockets and display sockets.

## TECHNICAL SPECIFICATIONS (FOR GENERAL SPECS, SEE PAGE 127)

<b>INSULATOR</b>	Black glass filled polyester PCT-GF30-FR
<b>FLAMMABILITY</b>	UL 94V-0
<b>SLEEVE</b>	Brass CuZn36Pb3 (C36000)
<b>CONTACT CLIP (4 FINGER) (6 FINGER)</b>	Beryllium copper (C17200) (Series 510...504101)
<b>ACCEPTED PIN Ø</b>	0.40 to 0.56 mm
<b>FORCES</b>	2 N typ. (0.7 N typ. 510...504101) insertion 1 N typ. (0.4 N typ. 510...504101) withdrawal (polished steel gauge Ø 0.43 mm) (6 finger: Ø 0.46 mm)
<b>MECHANICAL LIFE</b>	Min. 100 cycles
<b>RATED CURRENT</b>	1 A
<b>CONTACT RESISTANCE</b>	Max. 10 mΩ
<b>DIELECTRIC STRENGTH</b>	Min. 1'000 V <sub>RMS</sub>

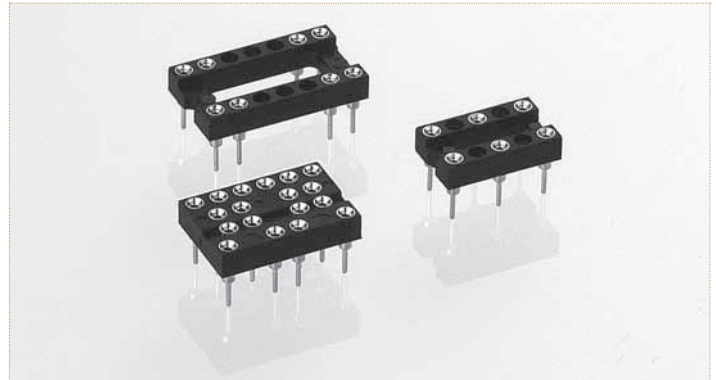

Other plating on request (see page 178 for plating specs).

## ORDERING INFORMATION ROHS COMPLIANT PARTS

PP PLATING CODE	SLEEVE	CLIP
87	Tin	Flash gold
83	Tin	0.75 µm gold

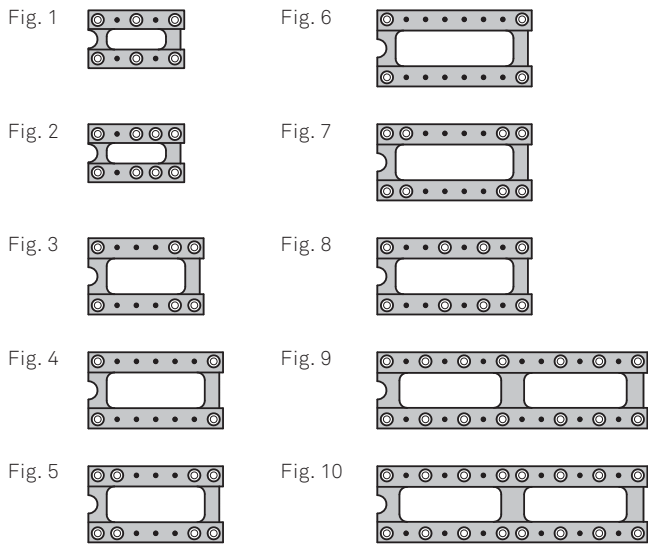

## PARTIALLY EQUIPPED DIL SOCKETS

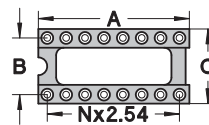

NO. OF POLES TOTAL EQUIPPED	A	B	C	SEE	ORDER CODES
10 / 6	12.6	5.08	7.6	Fig. 1	110-PP-210-01-742101
10 / 8	12.6	5.08	7.6	Fig. 2	110-PP-210-01-839101
12 / 6	15.2	7.62	10.1	Fig. 3	110-PP-312-01-680101
14 / 4	17.7	7.62	10.1	Fig. 4	110-PP-314-10-001101
14 / 8	17.7	7.62	10.1	Fig. 5	110-PP-314-10-002101
16 / 4	20.3	7.62	10.1	Fig. 6	110-PP-316-01-822101
16 / 8	20.3	7.62	10.1	Fig. 7	110-PP-316-01-931101
16 / 8	20.3	7.62	10.1	Fig. 8	110-PP-316-10-003101
28 / 14	35.5	7.62	10.1	Fig. 9	110-PP-328-01-777101
28 / 16	35.5	7.62	10.1	Fig. 10	110-PP-328-01-762101

Other pin count and arrangement please consult

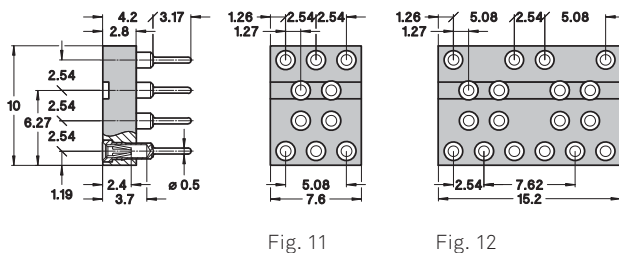

## DISPLAY SOCKETS FOR 7 SEGMENT DISPLAYS (1 OR 2 DIGITS)

NO. OF POLES	SEE	ORDER CODES
10	Fig. 11	510-PP-010-01-504101
18	Fig. 12	510-PP-018-01-504101

Please consult for other display sockets, single or multidigits



# PGA/BGA/PLCC SOCKETS

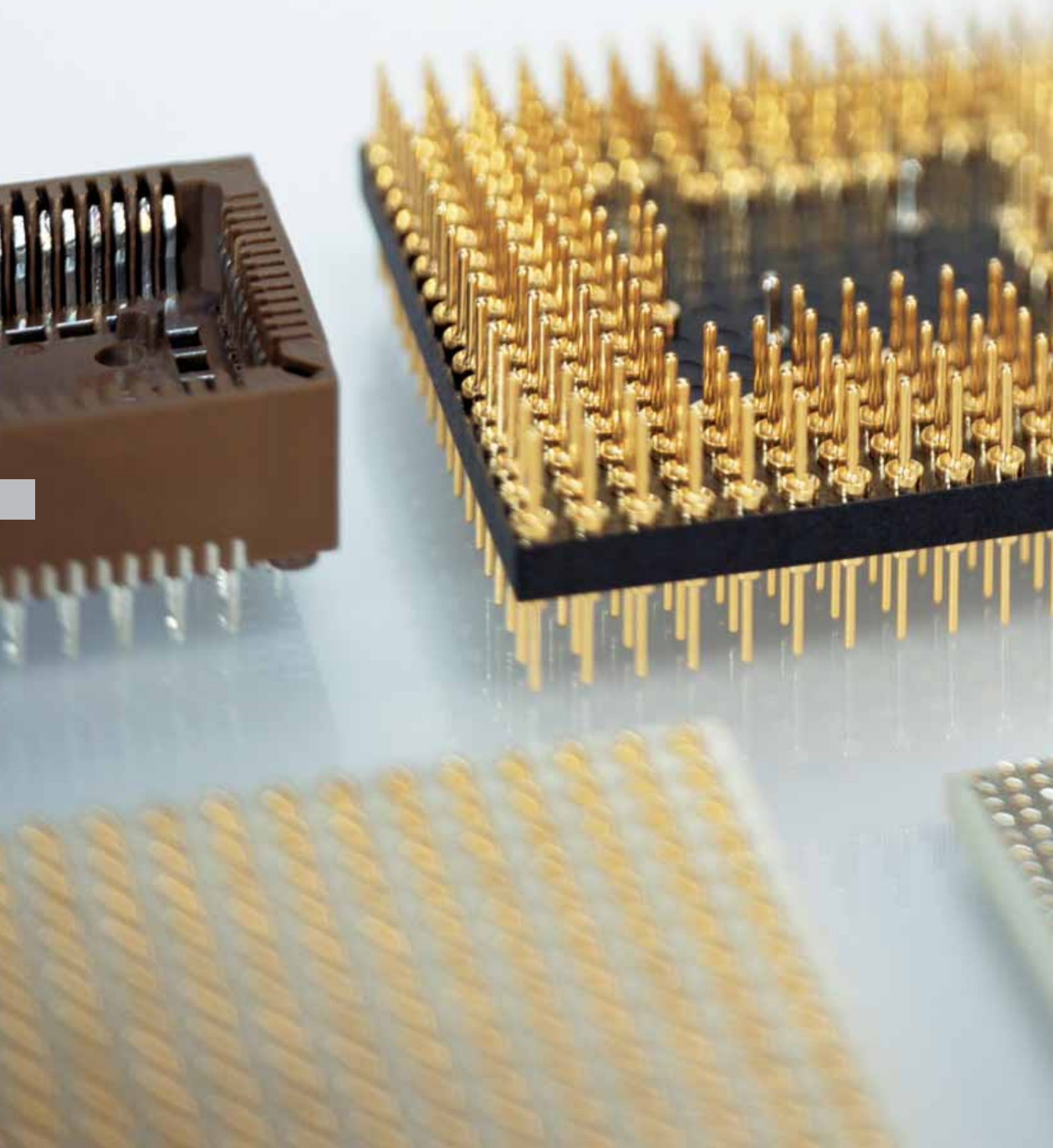

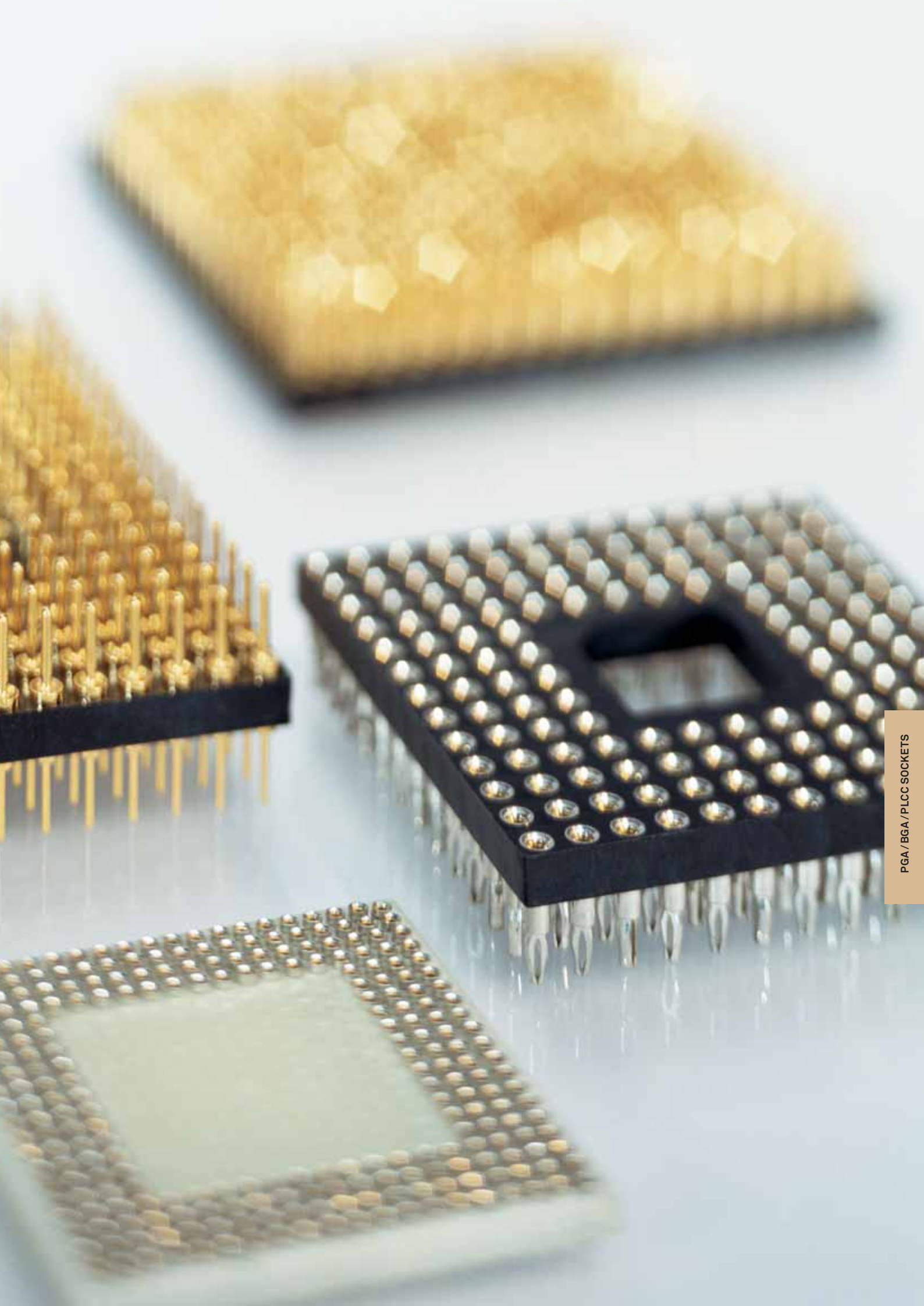

PGA / BGA / PLCC SOCKETS











precip-dip

WWW.PRECIDIP.COM TEL +41 32 421 04 00 SALES@PRECIDIP.COM

# QUICK SELECTOR CHART

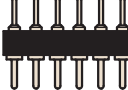
PGA / BGA / PLCC

GRID	PGA			BGA		PLCC
	2.54 mm	INTERSTITIAL	1.27 mm	1.27 mm	1 mm	
<b>SOCKETS</b>	<b>SEE PAGE</b>					
Solder tail		156	161	165		
						173
Surface mount		156	161	165	166	169
						172
Solderless compliant press-fit		157	161			
Carrier		158	162			
Interconnect pin		158	162	165	167	
Interconnect pin surface mount					167	169
BGA pin-adapter					166	169



preci-dip

WWW.PRECIDIP.COM TEL +41 32 421 04 00 SALES@PRECIDIP.COM

# PGA / BGA / PLCC

## GENERAL SPECIFICATIONS

The values listed below are general specs applying for PRECI-DIP PGA, BGA and PLCC sockets. Please see individual catalog page for additional and product specific technical data.

<b>OPERATING TEMPERATURE RANGE</b>	-55 ... +125 °C
<b>CLIMATIC CATEGORY (IEC)</b>	55/125/21
<b>OPERATING HUMIDITY RANGE</b>	Annual mean 75%
<b>MAX. WORKING VOLTAGE</b>	100 V <sub>RMS</sub> /150 V <sub>DC</sub> (2.54 mm grid)



PRECI-DIP connectors designated « Series Preci-Dip Connector » are recognized by UL LLC and listed under « Connectors for Use in Data, Signal, Control and Power Applications », File Nr. E174442.

## MECHANICAL CHARACTERISTICS

<b>CLIP RETENTION</b>	Min. 40 N (no displacement under axial force applied)
<b>CONTACT RETENTION</b>	Min. 3.3 N acc. to MIL-DTL-83734, pt 4.6.4.2

## ELECTRICAL CHARACTERISTICS

<b>INSULATION RESISTANCE BETWEEN ANY TWO ADJACENT CONTACTS</b>	Min. 10'000 MΩ at 500 V <sub>AC</sub>
<b>CAPACITANCE BETWEEN ANY TWO ADJACENT CONTACTS</b>	Max. 1 pF (PLCC max. 2 pF)
<b>SELF INDUCTANCE PER CONTACT</b>	Max. 2 nH

## ENVIRONMENTAL CHARACTERISTICS

The sockets withstand the following environmental tests without mechanical and electrical defects:

- Dry heat steady state IEC 60512-11-9.11i / 60068-2-2.Bb: 125 °C, 16 h
- Damp heat cyclic IEC 60512-11-12.11m / 60068-2-30.Db: 25/55 °C, 90 – 100 %rH, 1 cycle of 24 h
- Cold steady state IEC 60512-11-10.11j / 60068-2-1.A: -55 °C, 2 h
- Thermal shock IEC 60512-11-4.11d / 60068-2-14.Na: -55/125 °C, 5 cycles 30 min.
- Sinusoidal vibrations IEC 60512-6-4.6d / 60068-2-6.Fc: 10 to 500 Hz, 10 g, 1 octave/min., 10 cycles for each axis
- Shock IEC 60512-6-3.6c / 60068-2-27.Ea: 50 g, 11 ms, 3 shocks in three axis

During the above two tests, no contact interruption >50 ns does appear.

- Solderability J-STD-002A, Test A, 245 °C, 5 s, solder alloy SnAg3.8Cu0.7
- Resistance to soldering heat J-STD-020C, 260 °C, 20 s
- Moisture sensitivity J-STD-020C level 1

## SOLDERLESS COMPLIANT PRESS-FIT CHARACTERISTICS

### PRESS-FIT CHARACTERISTICS MEASURED ACC. TO IEC 60352-5

- Press-in force: 90 N max. (at min. hole dia.) / 65 N typ.
- Push-out force: 30 N min. (at max. hole dia.) / 50 N typ.
- Push-out 3<sup>rd</sup> cycle: 20 N min. (at max. hole dia.)

### PCB HOLE DIMENSIONS

- 2.54 mm grid
 

Finished hole Ø:	1 + 0.09/-0.06 mm
Drilled hole Ø:	1.15 ± 0.025 mm
- Interstitial grid
 

Finished hole Ø:	0.7 + 0.09/-0.06 mm
Drilled hole Ø:	0.8 ± 0.02 mm

### PCB HOLE PLATING

- PCB surface finish
 

Hole plating	
• Tin	5-15 µm tin over min. 25 µm copper
• Copper	min. 25 µm copper
• Gold over nickel	0.05-0.2 µm gold over 2.5-5 µm nickel over min. 25 µm copper





preci-dip

WWW.PRECIDIP.COM TEL +41 32 421 04 00 SALES@PRECIDIP.COM

# PIN GRID ARRAY SOCKETS

SOLDER TAIL / SURFACE MOUNT

Pin grid array sockets, standard solder version and surface mount with floating contacts.

## TECHNICAL SPECIFICATIONS (FOR GENERAL SPECS, SEE PAGE 155)

INSULATOR	Black glass filled polyester PCT-GF30-FR
FLAMMABILITY	UL 94V-0
SLEEVE	Brass CuZn36Pb3 (C36000)
CONTACT CLIP (6 FINGER)	Beryllium copper (C17200)
ACCEPTED PIN Ø	0.40 to 0.56 mm
FORCES	0.7 N typ. insertion      0.4 N typ. withdrawal (polished steel gauge Ø 0.46 mm)
MECHANICAL LIFE	Min. 100 cycles
RATED CURRENT	1 A
CONTACT RESISTANCE	Max. 10 mΩ
DIELECTRIC STRENGTH	Min. 1'000 V <sub>RMS</sub>

## ORDERING INFORMATION ROHS COMPLIANT PARTS

PP PLATING CODE	SLEEVE	CLIP
87	Tin	Flash gold
83	Tin	0.75 µm gold

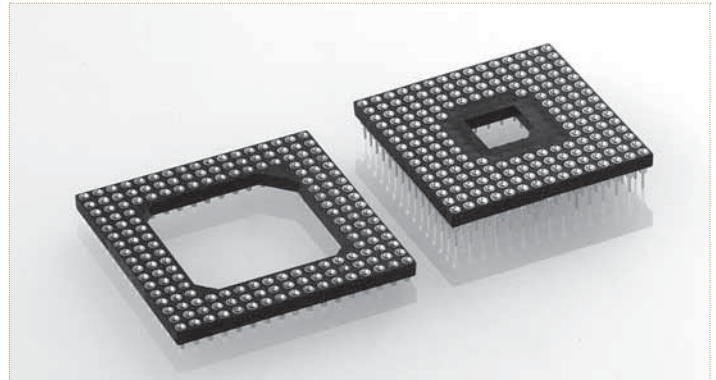

Other plating on request (see page 178 for plating specs).

Replace **NNN** with the number of poles and **XX-XXX** with body size and layout numbers as indicated on pages 159 to 160.

For example a 17x17 pin configuration with window and 168 contacts as shown on page 160 becomes 510-83-**168-17-101101**.

## DIMENSIONS

Calculate with n1 = number of contacts in one line and n2 = characteristic size of the window

$$A = n1 \times 2.54$$

$$B = (n1 - 1) \times 2.54$$

$$C = (n2 \times 2.54) - 0.40$$

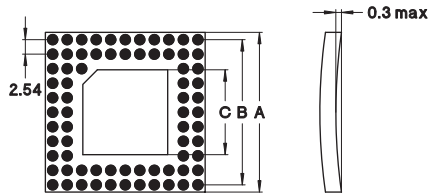

**Options:** please consult for availability

- PGA sockets with optional standoffs
- PGA sockets with solder tails, length 4.2 mm
- PGA sockets with low profile contacts and solder tails of 2.8 mm length
- PGA interconnect sockets with other contact lengths.

### 510-PP-NNN-XX-XXX101

PGA sockets with standard solder tails, length 3.17 mm.

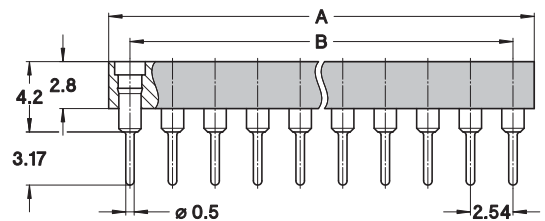

### 514-PP-NNN-XX-XXX117

PGA sockets with self-aligning SMD floating contacts.

Contact diameter of soldering end 0.98 mm, allowing PCB pads as small as 1.1 mm.

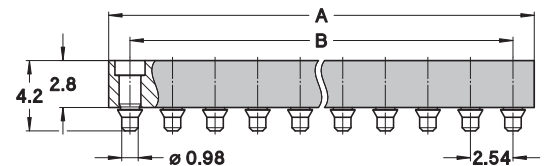





preci-dip

WWW.PRECIDIP.COM TEL +41 32 421 04 00 SALES@PRECIDIP.COM

# PIN GRID ARRAY SOCKETS

PRESS-FIT TERMINATIONS

Pin grid array sockets with compliant press-fit terminations.

## TECHNICAL SPECIFICATIONS (FOR GENERAL SPECS, SEE PAGE 155)

<b>INSULATOR</b>	Black glass filled polyester PCT-GF30-FR	
<b>FLAMMABILITY</b>	UL 94V-0	
<b>SLEEVE</b>	Bronze CuSn4Pb4Zn4 (C54400)	
<b>CONTACT CLIP (6 FINGER)</b>	Beryllium copper (C17200)	
<b>ACCEPTED PIN Ø</b>	0.40 to 0.56 mm	
<b>FORCES</b>	0.7 N typ. insertion	0.4 N typ. withdrawal (polished steel gauge Ø 0.46 mm)
<b>MECHANICAL LIFE</b>	Min. 100 cycles	
<b>RATED CURRENT</b>	1 A	
<b>CONTACT RESISTANCE</b>	Max. 10 mΩ	
<b>DIELECTRIC STRENGTH</b>	Min. 1'000 V <sub>RMS</sub>	

## ORDERING INFORMATION ROHS COMPLIANT PARTS

PP PLATING CODE	SLEEVE	CLIP
87	Tin	Flash gold
83	Tin	0.75 µm gold

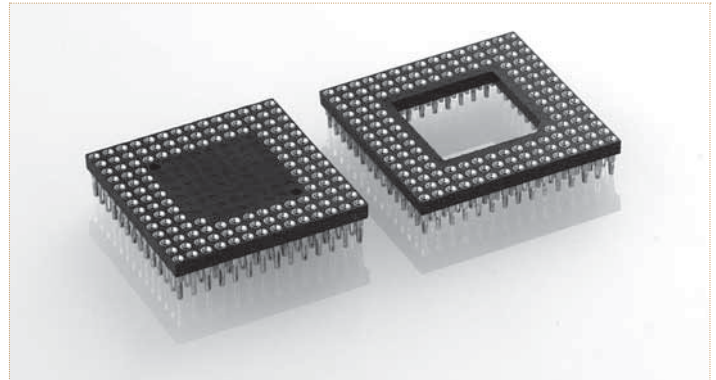

Other plating on request (see page 178 for plating specs).

Replace **NNN** with the number of poles and **XX-XXX** with body size and layout numbers as indicated on pages 159 to 160.

For example a 17x17 pin configuration with window and 168 contacts as shown on page 160 becomes 546-83-**168-17-101**136.

## DIMENSIONS

Calculate with n1 = number of contacts in one line and n2 = characteristic size of the window

$$A = n1 \times 2.54$$

$$B = (n1 - 1) \times 2.54$$

$$C = (n2 \times 2.54) - 0.40$$

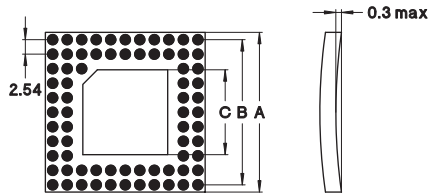

### 546-PP-NNN-XX-XXX136

PGA sockets with solderless compliant press-fit terminations for 1.5 to 2.0 mm PCB thickness.

Hole diameter 1 (+0.09/-0.06) mm after metallization (Drill diameter 1.15±0.025 mm).

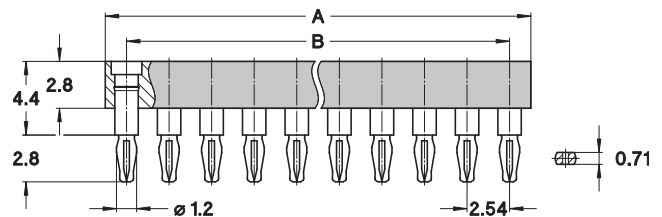

### 546-PP-NNN-XX-XXX135

PGA sockets with solderless compliant press-fit terminations for 2.1 to 3.2 mm PCB thickness.

Hole diameter 1 (+0.09/-0.06) mm after metallization (Drill diameter 1.15±0.025 mm).

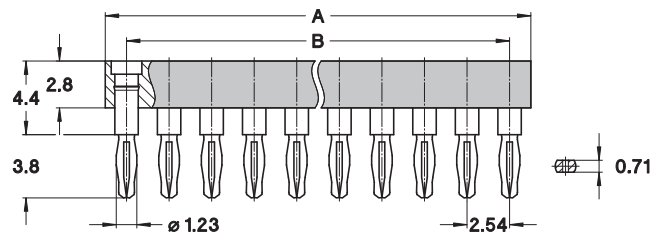



preci-dip

WWW.PRECIDIP.COM TEL +41 32 421 04 00 SALES@PRECIDIP.COM

# PIN GRID ARRAY SOCKETS

INTERCONNECT PIN AND CARRIERS

Pin grid array sockets, interconnect pin and carriers with disposable plastic body.

## TECHNICAL SPECIFICATIONS (FOR GENERAL SPECS, SEE PAGE 155)

<b>INSULATOR</b>	Black glass filled polyester PCT-GF30-FR	
<b>FLAMMABILITY</b>	UL 94V-0	
<b>SLEEVE</b>	Brass CuZn36Pb3 (C36000)	
<b>CONTACT CLIP (3 FINGER)</b>	Beryllium copper (C17200)	
<b>ACCEPTED PIN Ø</b>	0.40 to 0.56 mm	
<b>FORCES</b>	0.8 N typ. insertion	0.4 N typ. withdrawal (polished steel gauge Ø 0.46 mm)
<b>MECHANICAL LIFE</b>	Min. 100 cycles	
<b>RATED CURRENT</b>	1 A	
<b>CONTACT RESISTANCE</b>	Max. 10 mΩ	
<b>DIELECTRIC STRENGTH</b>	Min. 1'000 V <sub>RMS</sub>	

## ORDERING INFORMATION ROHS COMPLIANT PARTS

PP PLATING CODE	TERMINATION	CONNECTING PIN
10 (Serie 550)	0.25 µm gold	0.25 µm gold
80 (Serie 550)	Tin	Tin
PP PLATING CODE	SLEEVE	CLIP
87 (Serie 614)	Tin	Flash gold
83 (Serie 614)	Tin	0.75 µm gold

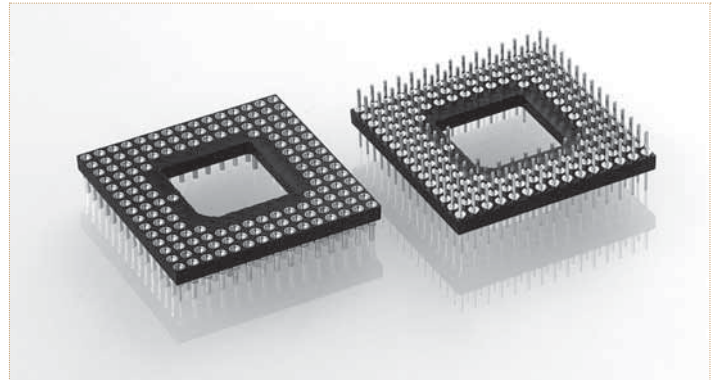

Other plating on request (see page 178 for plating specs).  
 Replace **NNN** with the number of poles and **XX-XXX** with body size and layout numbers as indicated on pages 159 to 160.  
 For example a 17x17 pin configuration with window and 168 contacts as shown on page 160 becomes 550-10-**168-17-101101**.

## DIMENSIONS

Calculate with n1 = number of contacts in one line and n2 = characteristic size of the window

$$A = n1 \times 2.54$$

$$B = (n1 - 1) \times 2.54$$

$$C = (n2 \times 2.54) - 0.40$$

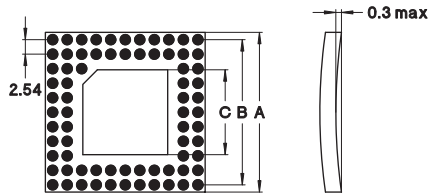

### 550-PP-NNN-XX-XXX101

PGA interconnect sockets with through hole solder tails and connecting pin Ø 0.47 mm.

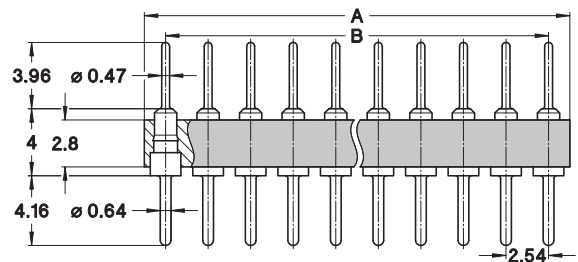

### 614-PP-NNN-XX-XXX112

PGA carrier sockets with disposable plastic body. Low profile ultra thin contacts with solder termination Ø 0.95 mm that requires Ø 1 mm holes in PCB.

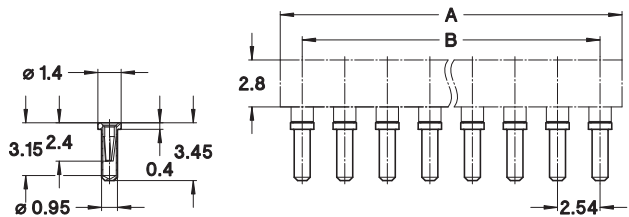



precidip

WWW.PRECIDIP.COM TEL +41 32 421 04 00 SALES@PRECIDIP.COM

# PIN GRID ARRAY SOCKETS

2.54 mm GRID / FOOTPRINTS / TOP VIEW



5x5

...-012-05-001...

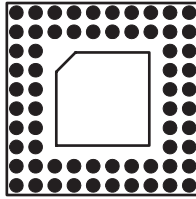

10x10

...-064-10-051...

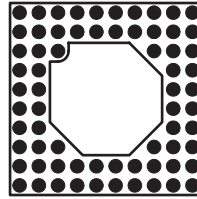

10x10

...-068-10-061...

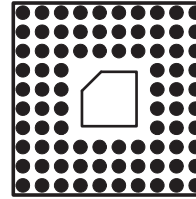

10x10

...-084-10-031...

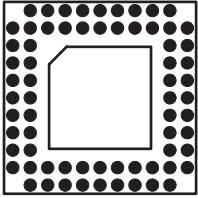

11x11

...-068-11-061...

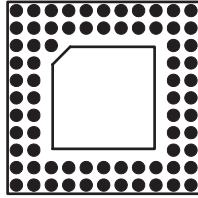

11x11

...-073-11-061...

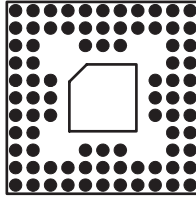

11x11

...-084-11-042...

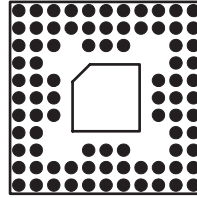

11x11

...-085-11-041...

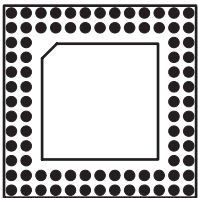

13x13

...-088-13-081...

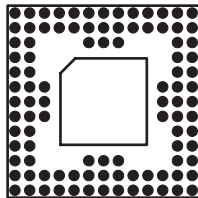

13x13

...-100-13-062...

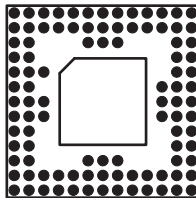

13x13

...-100-13-063...

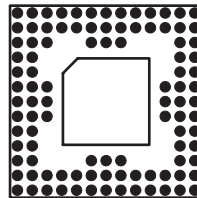

13x13

...-101-13-061...

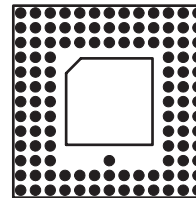

13x13

...-114-13-061...

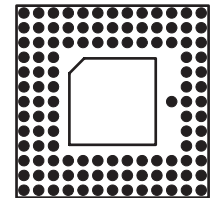

13x13

...-114-13-062...

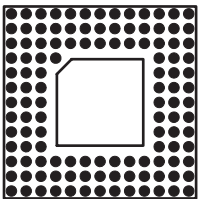

13x13

...-121-13-061...

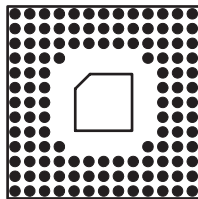

13x13

...-124-13-041...

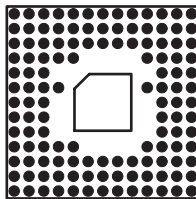

13x13

...-128-13-041...

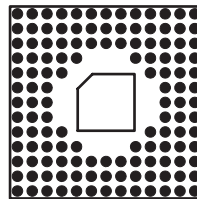

13x13

...-132-13-041...

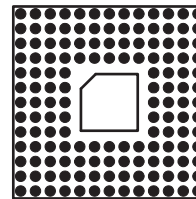

13x13

...-144-13-041...

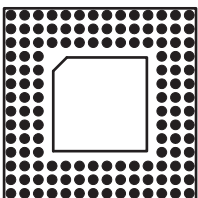

14x14

...-132-14-071...

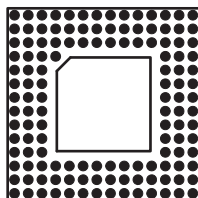

14x14

...-133-14-071...

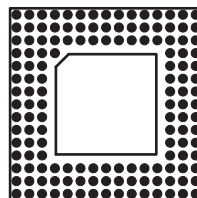

15x15

...-145-15-081...

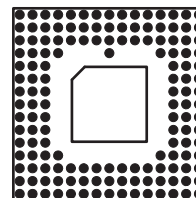

15x15

...-149-15-063...

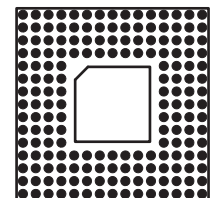

15x15

...-176-15-061...

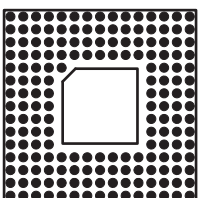

15x15

...-177-15-061...

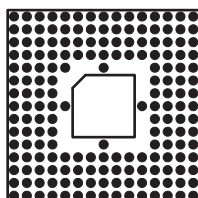

15x15

...-181-15-051...

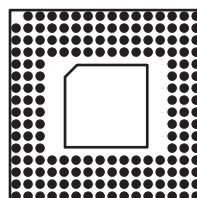

16x16

...-175-16-072...

PGA / BGA / PLCC SOCKETS



precidip

WWW.PRECIDIP.COM TEL +41 32 421 04 00 SALES@PRECIDIP.COM

# PIN GRID ARRAY SOCKETS

2.54 mm GRID / FOOTPRINTS / TOP VIEW

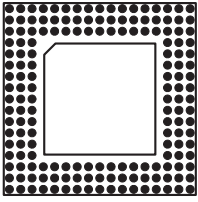

17x17

...-168-17-101...

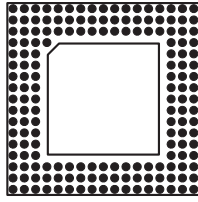

17x17

...-169-17-101...

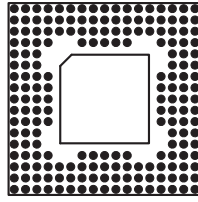

17x17

...-192-17-081...

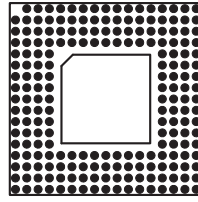

17x17

...-207-17-081...

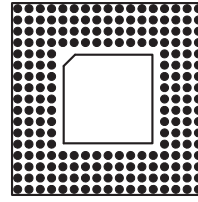

17x17

...-208-17-081...

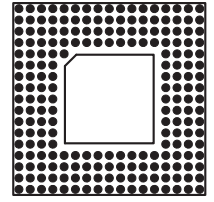

17x17

...-209-17-081...

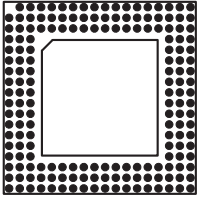

18x18

...-179-18-111...

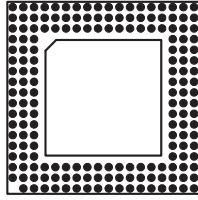

18x18

...-179-18-112...

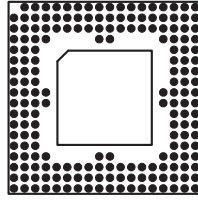

18x18

...-191-18-091...

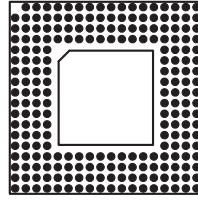

18x18

...-223-18-091...

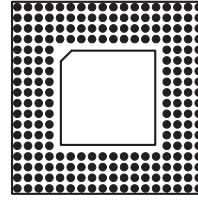

18x18

...-224-18-091...

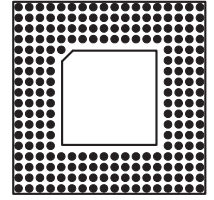

18x18

...-225-18-091...

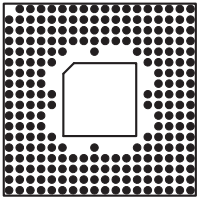

18x18

...-241-18-071...

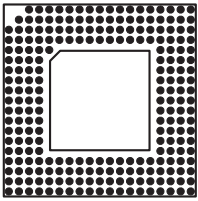

19x19

...-238-19-101...

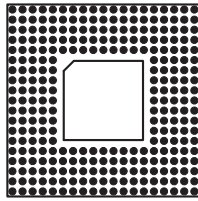

19x19

...-280-19-081...

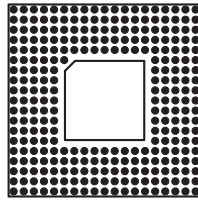

19x19

...-281-19-081...

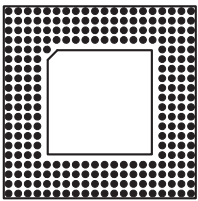

20x20

...-257-20-111...

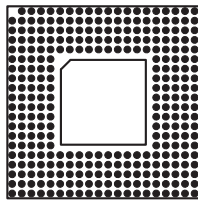

20x20

...-299-20-091...

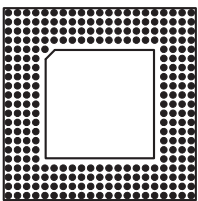

21x21

...-273-21-121...



preci-dip

WWW.PRECIDIP.COM TEL +41 32 421 04 00 SALES@PRECIDIP.COM

# PIN GRID ARRAY SOCKETS

INTERSTITIAL / SOLDER TAIL / SURFACE MOUNT  
PRESS-FIT TERMINATIONS

Pin grid array sockets with interstitial contact rows, solder tails, surface mount floating contacts and solderless compliant.

## TECHNICAL SPECIFICATIONS (FOR GENERAL SPECS, SEE PAGE 155)

<b>INSULATOR</b>	Black glass filled polyester PCT-GF30-FR	
<b>FLAMMABILITY</b>	UL 94V-0	
<b>SLEEVE</b>	Brass CuZn36Pb3 (C36000) (Bronze CuSn4Pb4Zn4 (C54400) for press-fit contacts)	
<b>CONTACT CLIP (6 FINGER)</b>	Beryllium copper (C17200)	
<b>ACCEPTED PIN Ø</b>	0.40 to 0.56 mm	
<b>FORCES</b>	0.4 N typ. insertion	0.2 N typ. withdrawal
	(polished steel gauge Ø 0.46 mm)	
<b>MECHANICAL LIFE</b>	Min. 100 cycles	
<b>RATED CURRENT</b>	1 A	
<b>CONTACT RESISTANCE</b>	Max. 10 mΩ	
<b>DIELECTRIC STRENGTH</b>	Min. 700 V <sub>RMS</sub>	

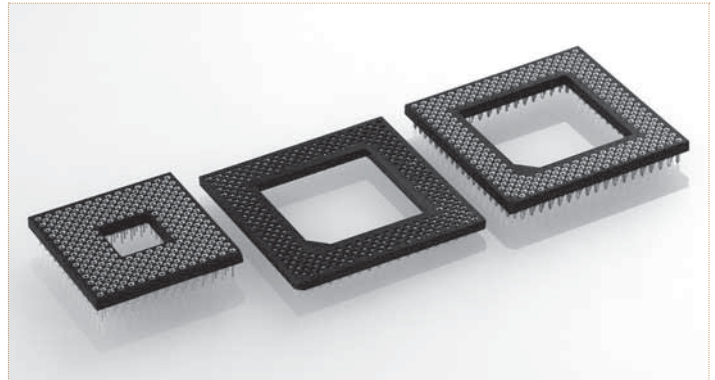

## ORDERING INFORMATION ROHS COMPLIANT PARTS

PP PLATING CODE	SLEEVE	CLIP
87	Tin	Flash gold
83	Tin	0.75 µm gold

Other plating on request (see page 178 for plating specs).

Replace **NNN** with the number of poles and **XX-XXX** with body size and layout numbers as indicated on pages 163 to 164.

For example a 19x19 pin configuration with window and 296 contacts as shown on page 163 becomes 517-83-296-19-131111.

## DIMENSIONS

Calculate with n1 = number of contacts on the external row and n2 = characteristic size of the window

$$A = (n1 \times 2.54) + 1.30$$

$$B = (n1 - 1) \times 2.54$$

$$C = (n2 \times 2.54) - 0.40$$

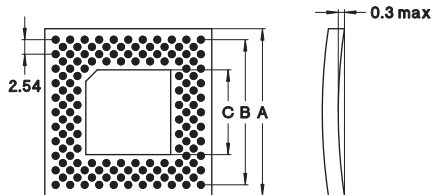

### 517-PP-NNN-XX-XXX111

Interstitial PGA sockets with through hole solder tails, length 3.17 mm.

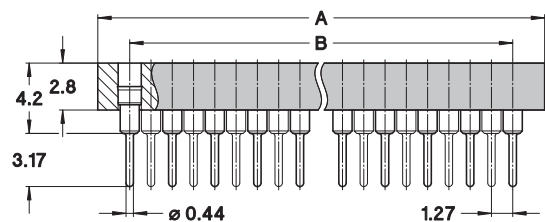

### 514-PP-NNN-XX-XXX154

Interstitial PGA sockets with self-aligning SMD floating contacts. Contact diameter of soldering end 0.8 mm allowing PCB pads with 0.9 mm diameter.

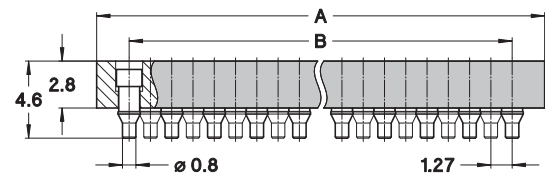

### 546-PP-NNN-XX-XXX147

Interstitial PGA sockets with solderless compliant press-fit terminations for 1.2 to 2.5 mm PCB thickness.

Hole diameter 0.7 (+0.07/-0.05) mm after metallization (Drill diameter 0.85±0.025 mm).

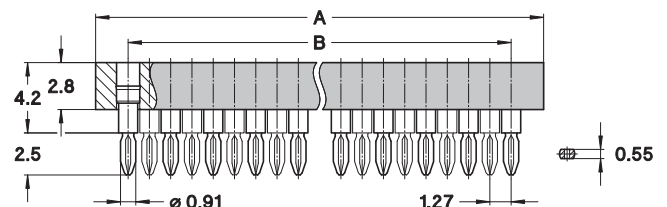





preci-dip

WWW.PRECIDIP.COM TEL +41 32 421 04 00 SALES@PRECIDIP.COM

# PIN GRID ARRAY SOCKETS

INTERSTITIAL / INTERCONNECT PIN AND CARRIER

Pin grid array sockets with interstitial contact rows, interconnect pin and carriers with disposable plastic body.

## TECHNICAL SPECIFICATIONS (FOR GENERAL SPECS, SEE PAGE 155)

<b>INSULATOR</b>	Black glass filled polyester PCT-GF30-FR	
<b>FLAMMABILITY</b>	UL 94V-0	
<b>SLEEVE / PIN</b>	Brass CuZn36Pb3 (C36000)	
<b>CONTACT CLIP (3 FINGER)</b>	Beryllium copper (C17200)	
<b>ACCEPTED PIN Ø</b>	0.40 to 0.56 mm	
<b>FORCES</b>	0.3 N typ. insertion	0.15 N typ. withdrawal (polished steel gauge Ø 0.46 mm)
<b>MECHANICAL LIFE</b>	Min. 100 cycles	
<b>RATED CURRENT</b>	1 A	
<b>CONTACT RESISTANCE</b>	Max. 10 mΩ	
<b>DIELECTRIC STRENGTH</b>	Min. 700 V <sub>RMS</sub>	

## ORDERING INFORMATION ROHS COMPLIANT PARTS

PP PLATING CODE	TERMINATION	CONNECTING PIN
10 (Serie 550)	0.25 µm gold	0.25 µm gold
80 (Serie 550)	Tin	Tin
PP PLATING CODE	SLEEVE	CLIP
87 (Serie 614)	Tin	Flash gold
83 (Serie 614)	Tin	0.75 µm gold

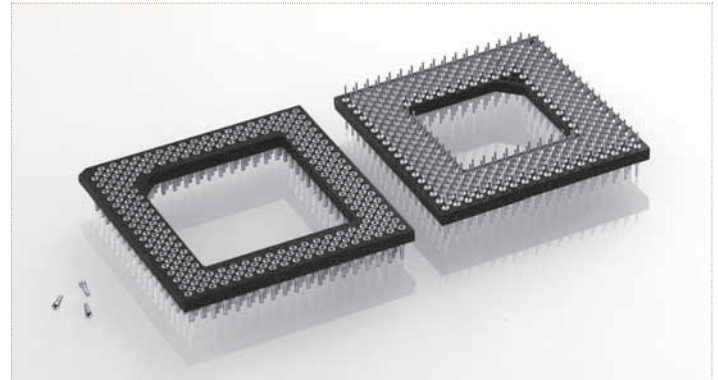

Other plating on request (see page 178 for plating specs).

Replace **NNN** with the number of poles and **XX-XXX** with body size and layout numbers as indicated on pages 163 to 164.

For example a 19x19 pin configuration with window and 296 contacts as shown on page 163 becomes 550-10-**296-19-131135**.

## DIMENSIONS

Calculate with n1 = number of contacts on the external row and n2 = characteristic size of the window

$$A = (n1 \times 2.54) + 1.30$$

$$B = (n1 - 1) \times 2.54$$

$$C = (n2 \times 2.54) - 0.40$$

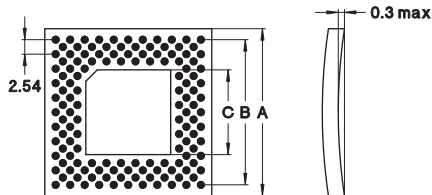

### 550-PP-NNN-XX-XXX135

Interstitial PGA interconnect sockets with through hole solder tails and connecting pin Ø 0.44 mm.

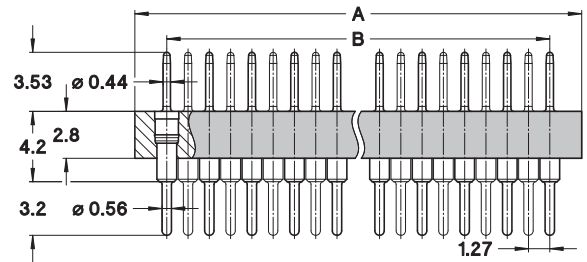

### 614-PP-NNN-XX-XXX144

Interstitial PGA carrier sockets with disposable plastic body and low profile, ultra-thin contacts with Ø 0.84 mm that requires Ø min 0.9 mm PCB holes.

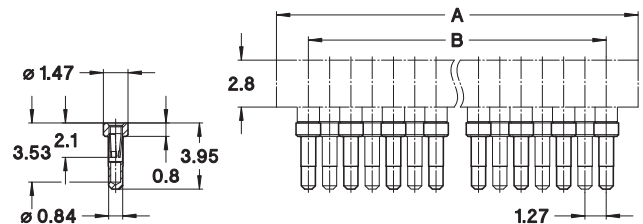



preci-dip

WWW.PRECIDIP.COM TEL +41 32 421 04 00 SALES@PRECIDIP.COM

# PIN GRID ARRAY SOCKETS

INTERSTITIAL / FOOTPRINTS / TOP VIEW

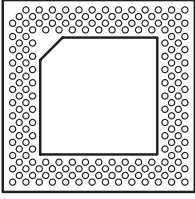

14x14

...-183-14-091...

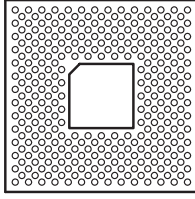

14x14

...-304-14-051...

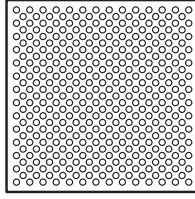

14x14

...-365-14-000...

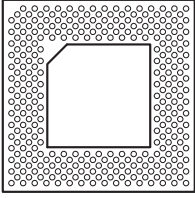

16x16

...-299-16-091...

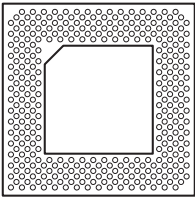

17x17

...-321-17-101...

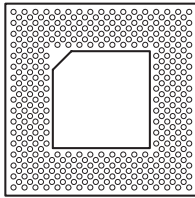

17x17

...-364-17-091...

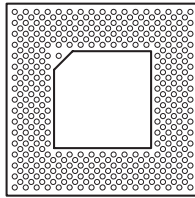

17x17

...-365-17-091...

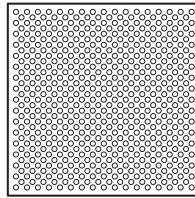

17x17

...-545-17-000...

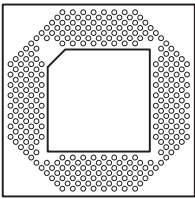

18x18

...-280-18-101...

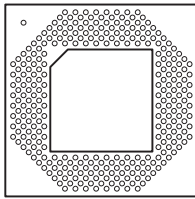

18x18

...-293-18-101...

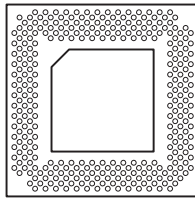

18x18

...-305-18-101...

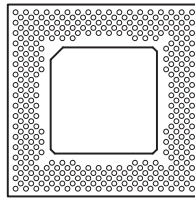

18x18

...-325-18-111...

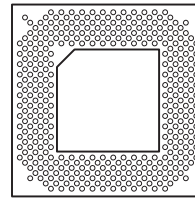

18x18

...-361-18-101...

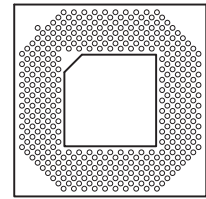

18x18

...-369-18-091...

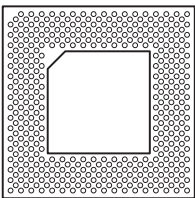

18x18

...-391-18-101...

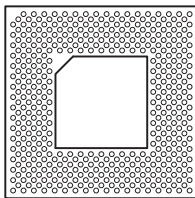

18x18

...-431-18-091...

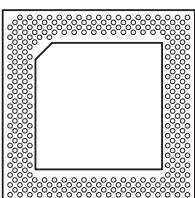

19x19

...-296-19-131...

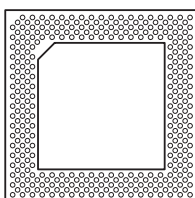

19x19

...-320-19-131...

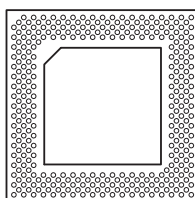

19x19

...-321-19-121...

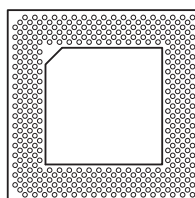

19x19

...-370-19-121...

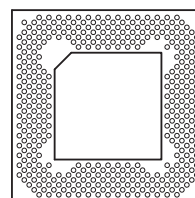

19x19

...-372-19-111...

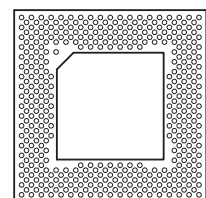

19x19

...-401-19-111...

PGA / BGA / PLCC SOCKETS



preci-dip

WWW.PRECIDIP.COM TEL +41 32 421 04 00 SALES@PRECIDIP.COM

# PIN GRID ARRAY SOCKETS

INTERSTITIAL / FOOTPRINTS / TOP VIEW

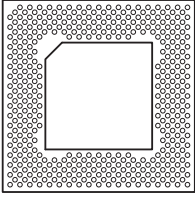

**19x19**

...-403-19-111...

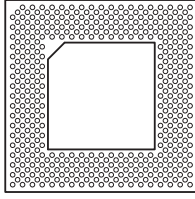

**19x19**

...-419-19-111...

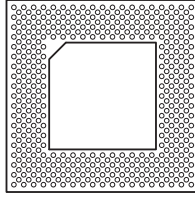

**19x19**

...-420-19-111...

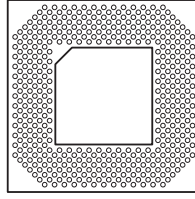

**19x19**

...-428-19-101...

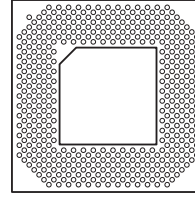

**19x19**

...-429-19-101...

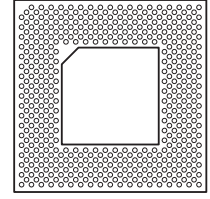

**19x19**

...-463-19-101...

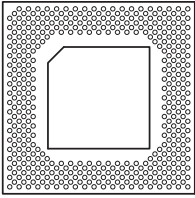

**20x20**

...-411-20-111...

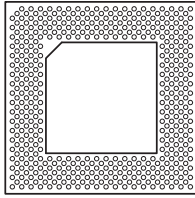

**20x20**

...-447-20-121...

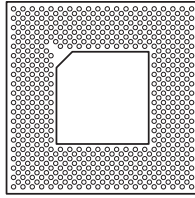

**20x20**

...-539-20-101...

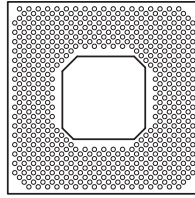

**20x20**

...-557-20-091...

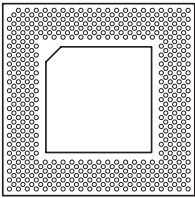

**21x21**

...-475-21-121...

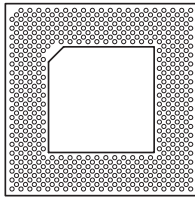

**21x21**

...-528-21-121...

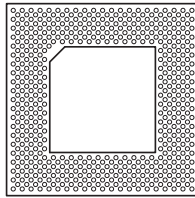

**21x21**

...-529-21-121...

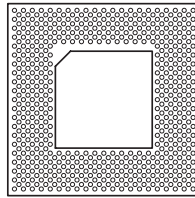

**21x21**

...-565-21-111...

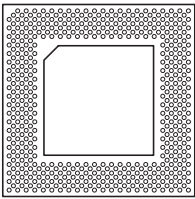

**22x22**

...-503-22-131...

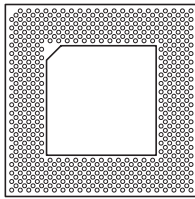

**22x22**

...-559-22-131...

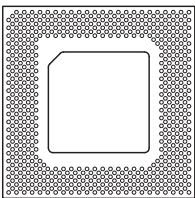

**24x24**

...-599-54-131...



preci-dip

WWW.PRECIDIP.COM TEL +41 32 421 04 00 SALES@PRECIDIP.COM

# MICRO PIN GRID ARRAY SOCKETS

1.27 mm GRID / SOLDER TAIL / SURFACE MOUNT / INTERCONNECT PIN

Micro pin grid array sockets (µPGA) with contacts placed on 1.27 mm grid, solder tail, surface mount and interconnect pin.

## TECHNICAL SPECIFICATIONS (FOR GENERAL SPECS, SEE PAGE 155)

INSULATOR	Glass-epoxy laminate FR4
FLAMMABILITY	UL 94V-0
SLEEVE / PIN	Brass CuZn36Pb3 (C36000)
CONTACT CLIP (6 FINGER)	Beryllium copper (C17200)
ACCEPTED PIN Ø	0.30 to 0.35 mm
FORCES	0.2 N typ. insertion      0.15 N typ. withdrawal (polished steel gauge Ø 0.3 mm)
MECHANICAL LIFE	Min. 100 cycles
RATED CURRENT	1 A
CONTACT RESISTANCE	Max. 10 mΩ
DIELECTRIC STRENGTH	Min. 500 V <sub>RMS</sub>

## ORDERING INFORMATION ROHS COMPLIANT PARTS

PP PLATING CODE	SLEEVE	CLIP
77 (Serie 518)	Flash gold	Flash gold
PP PLATING CODE	TERMINATION	CONNECTING PIN
10 (Serie 558)	0.25 µm gold	0.25 µm gold

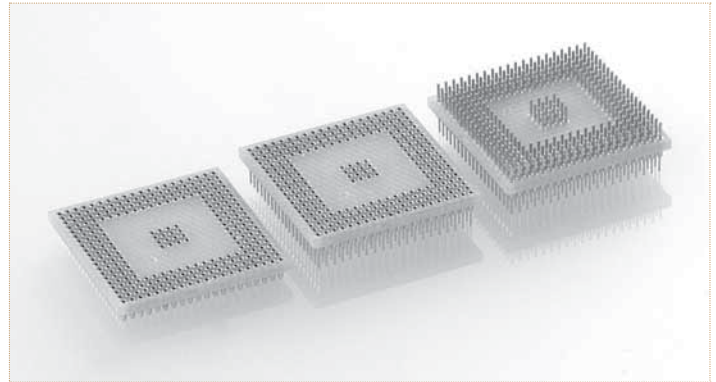

Other plating on request (see page 178 for plating specs).

Replace **NNN** with the number of poles and **XX-XXX** with body size and layout numbers as indicated on page 168.

For example a 26x26 pin configuration with window and 478 contacts as shown on page 168 becomes 518-77-478M26-131105.

## DIMENSIONS

Calculate with n1 = number of contacts in one line and n2 = characteristic size of the window

$$A = (n1 \times 1.27) + 1.27$$

$$B = (n1 - 1) \times 1.27$$

$$C = (n2 \times 1.27) - 0.40$$

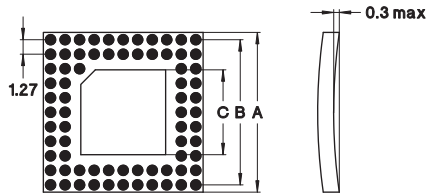

### 518-77-NNNMXX-XXX105

PGA sockets 1.27 mm grid with through hole solder tails length 2.79 mm.

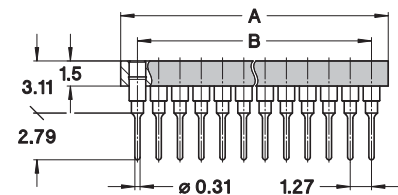

### 518-77-NNNMXX-XXX106

PGA sockets 1.27 mm grid, surface mount.

Contact diameter of soldering end 0.31 mm allowing PCB pads with 0.4 mm diameter.

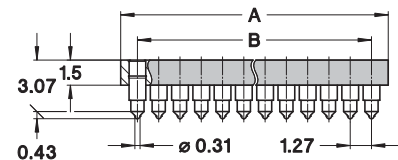

### 558-10-NNNMXX-XXX101

PGA 1.27 mm grid, interconnect sockets with through hole solder tail and connecting pin Ø 0.31 mm.

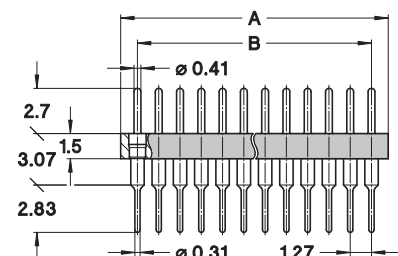



preci-dip

WWW.PRECIDIP.COM TEL +41 32 421 04 00 SALES@PRECIDIP.COM

# BALL GRID ARRAY SOCKETS

1.27 mm GRID / SURFACE MOUNT / SOCKET AND ADAPTER

Ball grid array sockets and adapters, surface mount.

## TECHNICAL SPECIFICATIONS (FOR GENERAL SPECS, SEE PAGE 155)

<b>INSULATOR</b>	Glass-epoxy laminate FR4	
<b>FLAMMABILITY</b>	UL 94V-0	
<b>SLEEVE / PIN</b>	Brass CuZn36Pb3 (C36000)	
<b>CONTACT CLIP (4 FINGER)</b>	Beryllium copper (C17200)	
<b>ACCEPTED PIN Ø</b>	0.36 to 0.46 mm	
<b>FORCES</b>	0.3 N typ. insertion	0.15 N typ. withdrawal (polished steel gauge Ø 0.43 mm)
<b>MECHANICAL LIFE</b>	Min. 100 cycles	
<b>RATED CURRENT</b>	1 A	
<b>CONTACT RESISTANCE</b>	Max. 10 mΩ	
<b>DIELECTRIC STRENGTH</b>	Min. 500 V <sub>RMS</sub>	

## ORDERING INFORMATION ROHS COMPLIANT PARTS

PP PLATING CODE	SLEEVE	CLIP
87 (Serie 514)	Tin	Flash gold
83 (Serie 514)	Tin	0.75 µm gold
PP PLATING CODE	TERMINATION	CONNECTING PIN
10 (Serie 550)	0.25 µm gold	0.25 µm gold
80 (Serie 550)	Tin	Tin

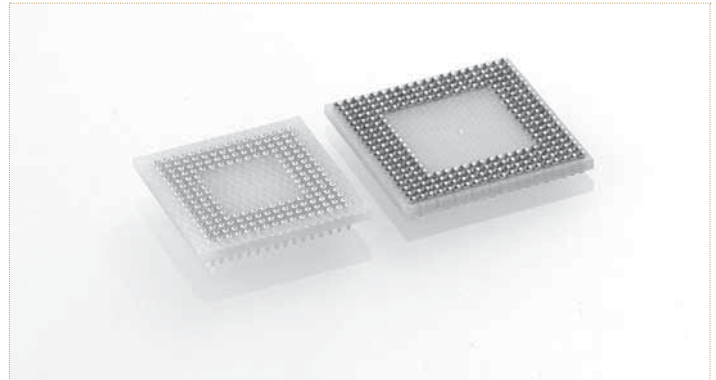

Other plating on request (see page 178 for plating specs).  
 Replace **NNN** with the number of poles and **XX-XXX** with body size and layout numbers as indicated on page 168.  
 For example a 20x20 pin configuration with 256 contacts as shown on page 168 becomes 514-83-**256M20-001148**.

## DIMENSIONS

Calculate with n1 = number of contacts in one line

for sockets

$$A = (n1 \times 1.27) + 1.27$$

$$B = (n1 - 1) \times 1.27$$

for adapters

$$A = (n1 \times 1.27) + 3.27$$

$$B = (n1 - 1) \times 1.27$$

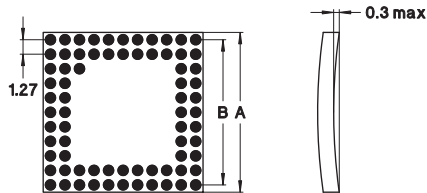

### 514-PP-NNNMXX-XXX148

BGA sockets 1.27 mm grid with self-aligning surface mount floating contacts.  
 Same foot print as the BGA device, to mate with the corresponding adapter.

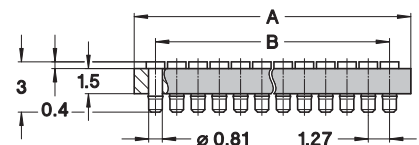

### 550-10-NNNMXX-XXX166

BGA adapter 1.27 mm grid pluggable into the corresponding socket.  
 Connecting pin Ø 0.42 mm.  
 BGA device is SMD soldered on the solder pads.

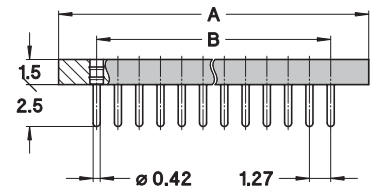

BGA socket and adapter systems are the reliable solution to make BGAs pluggable:

- the BGA socket Series 514 ① is soldered to the PCB in place of the BGA device and using the same footprint
- the BGA device ③ is soldered to the adapter Series 550 ②
- the BGA + adapter sub-assembly is plugged into the socket

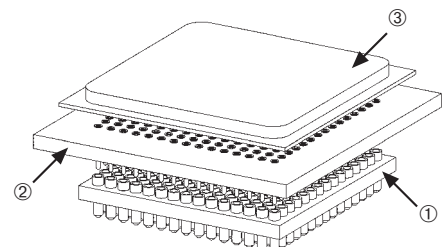





preci-dip

WWW.PRECIDIP.COM TEL +41 32 421 04 00 SALES@PRECIDIP.COM

# BALL GRID ARRAY SOCKETS

1.27 mm GRID / INTERCONNECT PIN / SOLDER TAIL / SURFACE MOUNT

Ball grid array interconnect pin, through hole solder tail and surface mount.

## TECHNICAL SPECIFICATIONS (FOR GENERAL SPECS, SEE PAGE 155)

<b>INSULATOR</b>	Glass-epoxy laminate FR4
<b>FLAMMABILITY</b>	UL 94V-0
<b>CONTACT</b>	Brass CuZn36Pb3 (C36000)
<b>MECHANICAL LIFE</b>	Min. 100 cycles
<b>RATED CURRENT</b>	1 A
<b>CONTACT RESISTANCE</b>	Max. 10 mΩ
<b>DIELECTRIC STRENGTH</b>	Min. 500 V <sub>RMS</sub>

## ORDERING INFORMATION ROHS COMPLIANT PARTS

PP PLATING CODE	TERMINATION	CONNECTING PIN
10	0.25 μm gold	0.25 μm gold

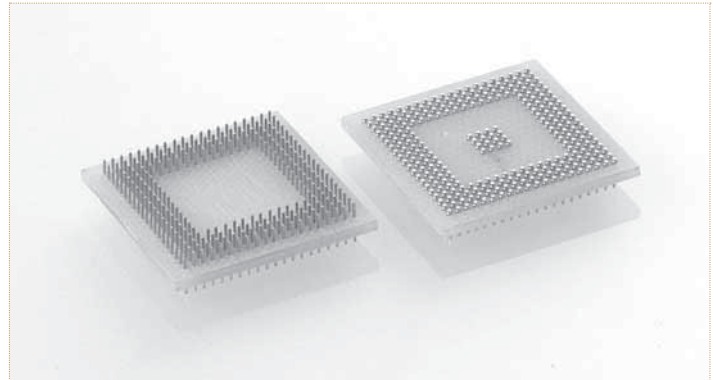

Other plating on request (see page 178 for plating specs).

Replace **NNN** with the number of poles and **XX-XXX** with body size and layout numbers as indicated on page 168.

For example a 20x20 pin configuration with 256 contacts as shown on page 168 becomes 550-10-2**56M20-001**152.

## DIMENSIONS

Calculate with n1 = number of contacts in one line

$$A = (n1 \times 1.27) + 3.27$$

$$B = (n1 - 1) \times 1.27$$

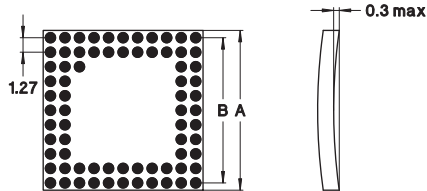

### 550-10-**NNN**XX-XXX152

BGA interconnect sockets 1.27 mm grid, through hole solder tails and connecting pin Ø 0.40 mm.

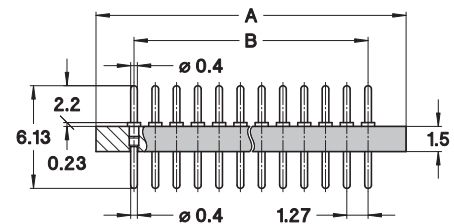

### 558-10-**NNN**XX-XXX104

BGA interconnect sockets 1.27 mm grid, with surface mount terminations and connecting pin Ø 0.41 mm.

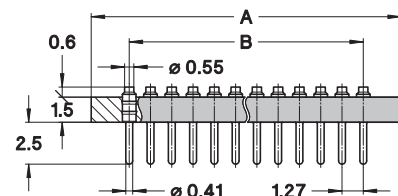



preci-dip

WWW.PRECIDIP.COM TEL +41 32 421 04 00 SALES@PRECIDIP.COM

# BALL/PIN GRID ARRAY SOCKETS

1.27 mm GRID / FOOTPRINTS / TOP VIEW

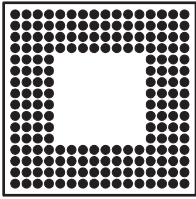

16x16

...-192M16-001...

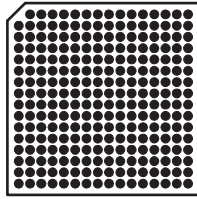

16x16

...-255M16-001...

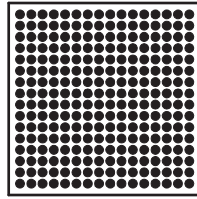

16x16

...-256M16-000...

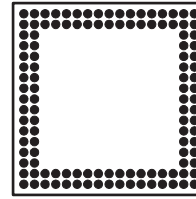

17x17

...-120M17-001...

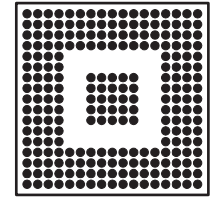

17x17

...-233M17-001...

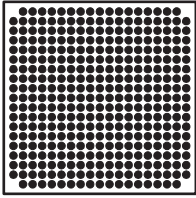

19x19

...-357M19-001...

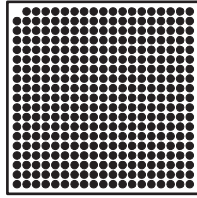

19x19

...-360M19-001...

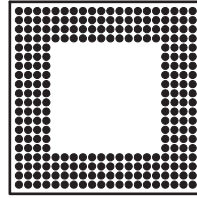

20x20

...-256M20-001...

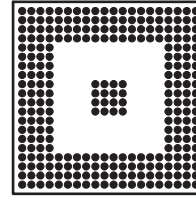

20x20

...-272M20-001...

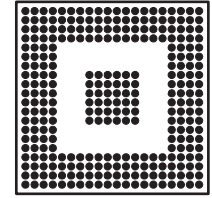

20x20

...-292M20-001...

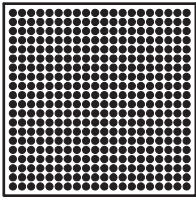

20x20

...-400M20-000...

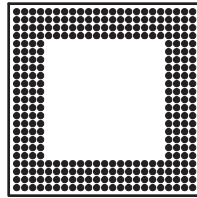

23x23

...-304M23-001...

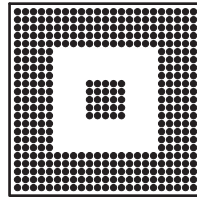

23x23

...-385M23-001...

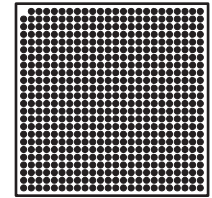

24x24

...-575M24-001...

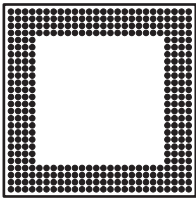

26x26

...-352M26-001...

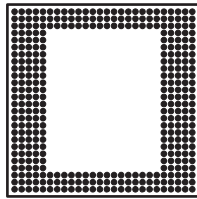

26x26

...-356M26-001...

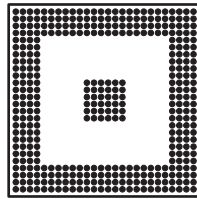

26x26

...-388M26-001...

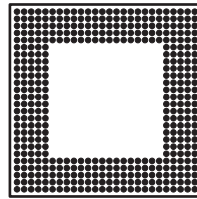

26x26

...-420M26-001...

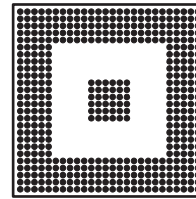

26x26

...-456M26-001...

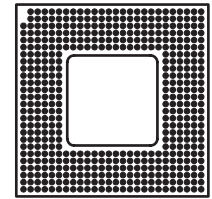

26x26

...-478M26-131...

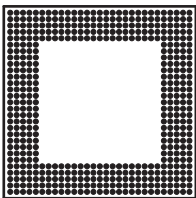

29x29

...-480M29-001...

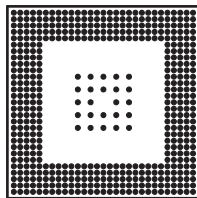

29x29

...-504M29-001...

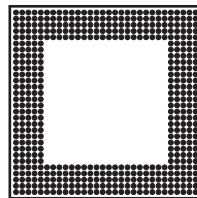

30x30

...-500M30-001...

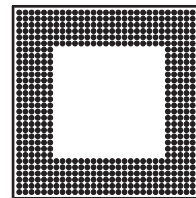

30x30

...-576M30-001...

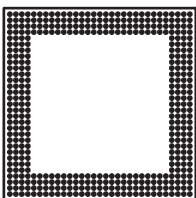

31x31

...-432M31-001...

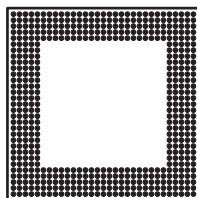

31x31

...-520M31-001...

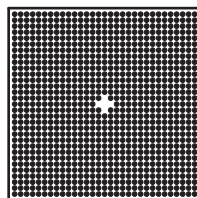

31x31

...-956M31-001...

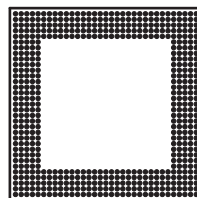

33x33

...-560M33-001...

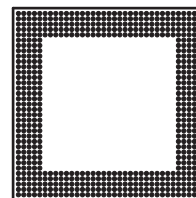

35x35

...-600M35-001...

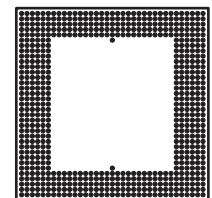

35x35

...-652M35-001...



preci-dip

WWW.PRECIDIP.COM TEL +41 32 421 04 00 SALES@PRECIDIP.COM

# BALL GRID ARRAY SOCKETS

1 mm GRID / SURFACE MOUNT SOCKET, ADAPTER / INTERCONNECT PIN

Ball grid array sockets and adapter surface mount.

## TECHNICAL SPECIFICATIONS (FOR GENERAL SPECS, SEE PAGE 155)

<b>INSULATOR</b>	Glass-epoxy laminate FR4	
<b>FLAMMABILITY</b>	UL 94V-0	
<b>SLEEVE / PIN</b>	Brass CuZn36Pb3 (C36000)	
<b>CONTACT CLIP (3 FINGER)</b>	Beryllium copper (C17200)	
<b>ACCEPTED PIN Ø</b>	0.20 to 0.30 mm	
<b>FORCES</b>	0.4 N typ. insertion	0.2 N typ. withdrawal (polished steel gauge Ø 0.25 mm)
<b>MECHANICAL LIFE</b>	Min. 100 cycles	
<b>RATED CURRENT</b>	1 A	
<b>CONTACT RESISTANCE</b>	Max. 10 mΩ	
<b>DIELECTRIC STRENGTH</b>	Min. 500 V <sub>RMS</sub>	

## ORDERING INFORMATION ROHS COMPLIANT PARTS

<b>PP PLATING CODE</b>	<b>SLEEVE</b>	<b>CLIP</b>
11 (Serie 514)	0.25 µm gold	0.25 µm gold
<b>PP PLATING CODE</b>	<b>TERMINATION</b>	<b>CONNECTING PIN</b>
10 (Serie 558)	0.25 µm gold	0.25 µm gold

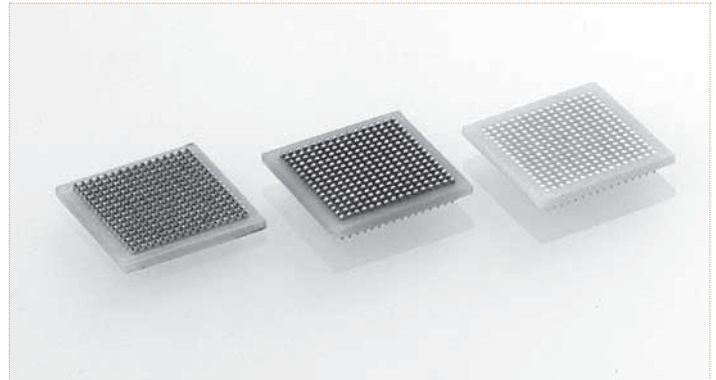

Other plating on request (see page 178 for plating specs).  
Please consult for complete part number and available footprints.

**Options:** please consult for availability  
- Through hole adapter.

## DIMENSIONS

Calculate with n1 = number of contacts in one line

$$A = n1 + 2.81$$

$$B = n1 - 1$$

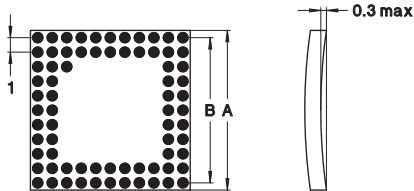

### 514-11-NNNPXX-XXX159

BGA sockets 1 mm grid, surface mount.  
Same foot print as the BGA device to mate with the corresponding adapter.

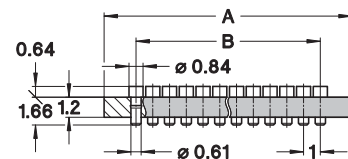

### 558-10-NNNPXX-XXX102

BGA adapter 1 mm grid, pluggable into the corresponding socket.  
Connecting pin Ø 0.25 mm.  
BGA device is SMD soldered on the solder pads.

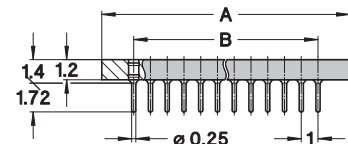

### 558-10-NNNPXX-XXX103

BGA interconnect sockets 1 mm grid with surface mount terminations and connecting pin Ø 0.25 mm.

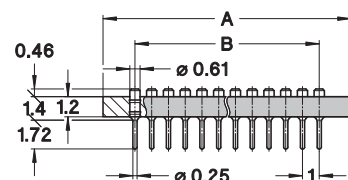



preci-dip

WWW.PRECIDIP.COM TEL +41 32 421 04 00 SALES@PRECIDIP.COM

# BALL/PIN GRID ARRAY SOCKETS

## PART NUMBER IDENTIFICATION

### TYPE OF SOCKET

#### Standard PGA, Interstitial PGA and µPGA PAGE

<b>510-...01</b>	Solder pin 2.54 mm grid	156
<b>514-...34</b>	SMD 2.54 mm grid	156
<b>514-...54</b>	SMD interstitial	161
<b>517-...11</b>	Solder pin interstitial	161
<b>518-...05</b>	Solder pin 1.27 mm grid	165
<b>518-...06</b>	SMD 1.27 mm grid	165
<b>546-...35</b>	Press-fit 2.54 mm, PCB 2.1-3.2 mm	157
<b>546-...36</b>	Press-fit 2.54 mm, PCB 1.5-2.0 mm	157
<b>546-...47</b>	Press-fit interstitial	161
<b>550-...01</b>	Interconnect, solder pin, 2.54 mm grid	158
<b>550-...35</b>	Interconnect, solder pin, interstitial	162
<b>558-...01</b>	Interconnect, solder pin, 1.27 mm grid	165
<b>614-...12</b>	Carrier 2.54 mm grid	158
<b>614-...44</b>	Carrier interstitial	162

#### BGA

<b>514-...48</b>	Socket SMD, 1.27 mm grid	166
<b>514-...59</b>	Socket SMD, 1 mm grid	169
<b>550-...66</b>	Adapter, 1.27 mm grid	166
<b>550-...52</b>	Interconnect, solder pin, 1.27 mm grid	167
<b>558-...02</b>	Adapter, 1 mm grid	169
<b>558-...03</b>	Interconnect SMD, 1 mm grid	169
<b>558-...04</b>	Interconnect SMD, 1.27 mm grid	167

**XXX – PP – NNN X XX – XXX 1 XX**

#### PLATING CODE ROHS COMPLIANT PARTS

CODE	SLEEVE	CLIP
77	Flash gold	Flash gold
83	Tin	0.75 µm gold
87	Tin	Flash gold

	TERMINATION	CONNECTING PIN
10	0.25 µm gold	0.25 µm gold
80	Tin	Tin

TOTAL NUMBER OF PINS

SIZE OF BODY

SIZE OF WINDOW AND FOOTPRINT

**Grid:** – 2.54 mm or interstitial  
**M** 1.27 mm grid  
**P** 1 mm grid

See pages 159, 160, 163, 164 and 168 for most popular footprints.



precip-dip

WWW.PRECIDIP.COM TEL +41 32 421 04 00 SALES@PRECIDIP.COM

# BALL/PIN GRID ARRAY SOCKETS

CUSTOM GRID DESIGN

If the desired footprint does not exist in this catalogue, please photocopy this page, complete it and send it to your local PRECI-DIP distributor.

Your address

## ORDERING INFORMATION

Type of socket (see opposite page)



Plating code PP (see opposite page)



Grid



Standard 2.54 mm



Interstitial



1.27 mm



1 mm

Size of body



Semiconductor device used

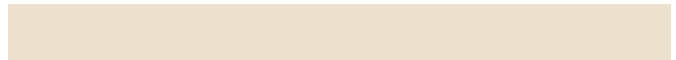

Quantity

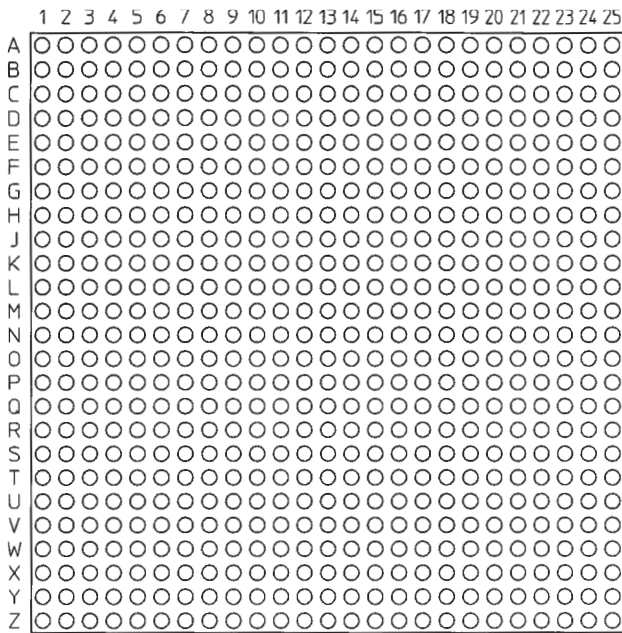

## TOP VIEW

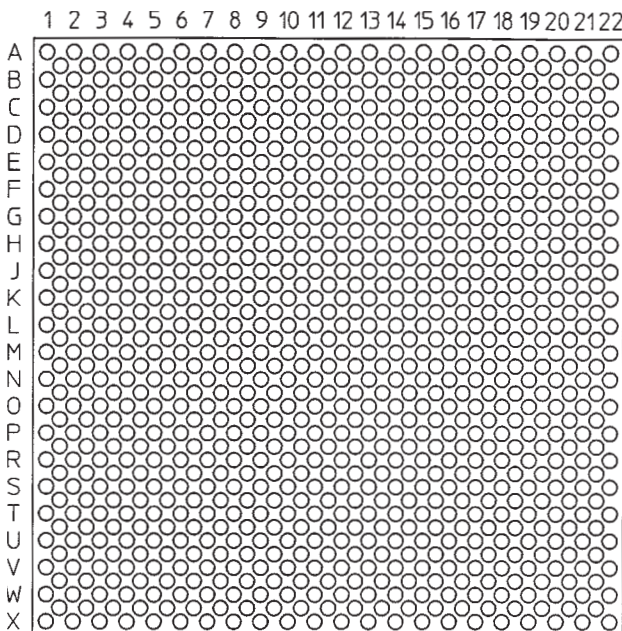

## EXAMPLE

Fill in the position of pins

Mark of the window

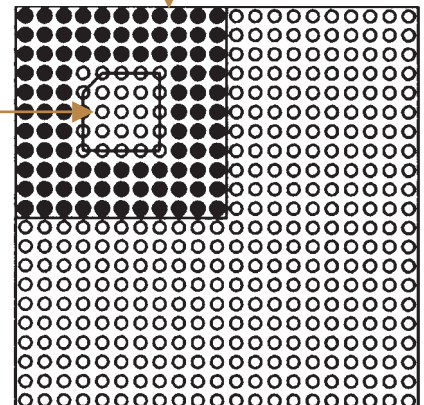





preci-dip

WWW.PRECIDIP.COM TEL +41 32 421 04 00 SALES@PRECIDIP.COM

# SOCKETS FOR PLASTIC LEADED CHIP CARRIERS (PLCC)

SMT TERMINATIONS

Series 540 PLCC sockets with SMT terminations come with square sizes for IC-packages according to JEDEC MO-047 and rectangular size (32) according to JEDEC MO-052, low profile.

## TECHNICAL SPECIFICATIONS (FOR GENERAL SPECS, SEE PAGE 155)

INSULATOR	Glass filled thermoplastic PPS-GF30-FR
FLAMMABILITY	UL 94V-0
CONTACT	Phosphor bronze
CONTACT PRESSURE	Min. 1.5 N per contact
MECHANICAL LIFE	Min. 50 cycles
RATED CURRENT	1 A
CONTACT RESISTANCE	Max. 20 mΩ
DIELECTRIC STRENGTH	Min. 600 V <sub>RMS</sub>
INSULATION RESISTANCE	Min. 5'000 MΩ
CAPACITANCE	Max. 2 pF
COPLANARITY	
SMD TERMINATIONS	Max. 0.1 mm

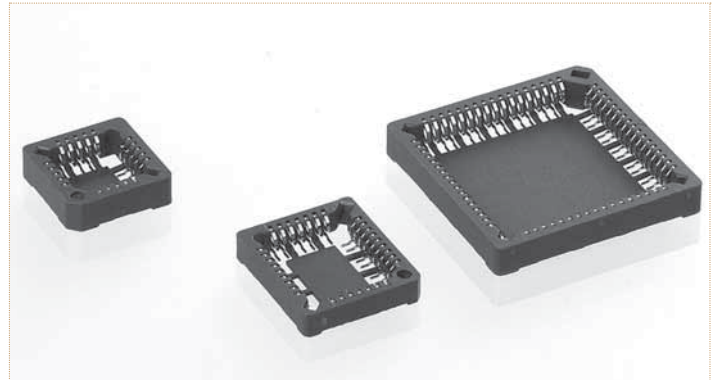

## ORDERING INFORMATION ROHS COMPLIANT PARTS

PP PLATING CODE	TERMINATION	CONTACT
88	Tin	Tin

**Option:** parts with positioning pegs add suffix **-2** to part number (only available for No. of poles 32 and 68).

### Tape & Reel packaging:

add suffix **-TR** to part number.

Please consult [www.precidip.com](http://www.precidip.com) for availability size of tape, size of reel, number of components per reel and packing units.

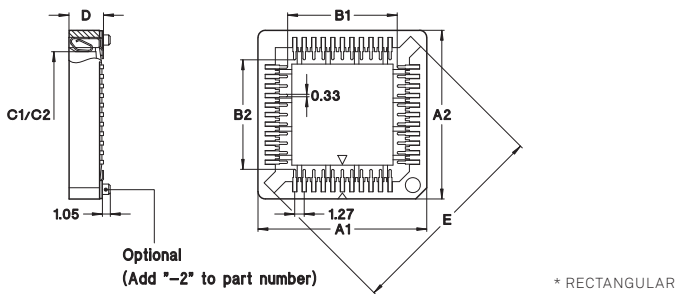

NO. OF POLES	A1/A2	B1/B2	C1/C2	D	E	ORDER CODES
20	14.86	7.02	9.20	4.60	16.20	540-88-020-17-400
28	17.34	9.50	11.76	4.60	19.70	540-88-028-17-400
32*	16.95 / 9.40 / 11.60 / 19.50	11.90	14.20	3.80	22.00	540-88-032-17-400
44	22.42	14.50	16.70	4.60	27.00	540-88-044-17-400
52	25.40	17.24	19.46	4.60	30.80	540-88-052-17-400
68	30.54	22.26	24.40	4.60	37.65	540-88-068-17-400
84	35.56	27.34	29.58	4.60	45.10	540-88-084-17-400

## PCB LAYOUT SERIES 540, SMD TYPES

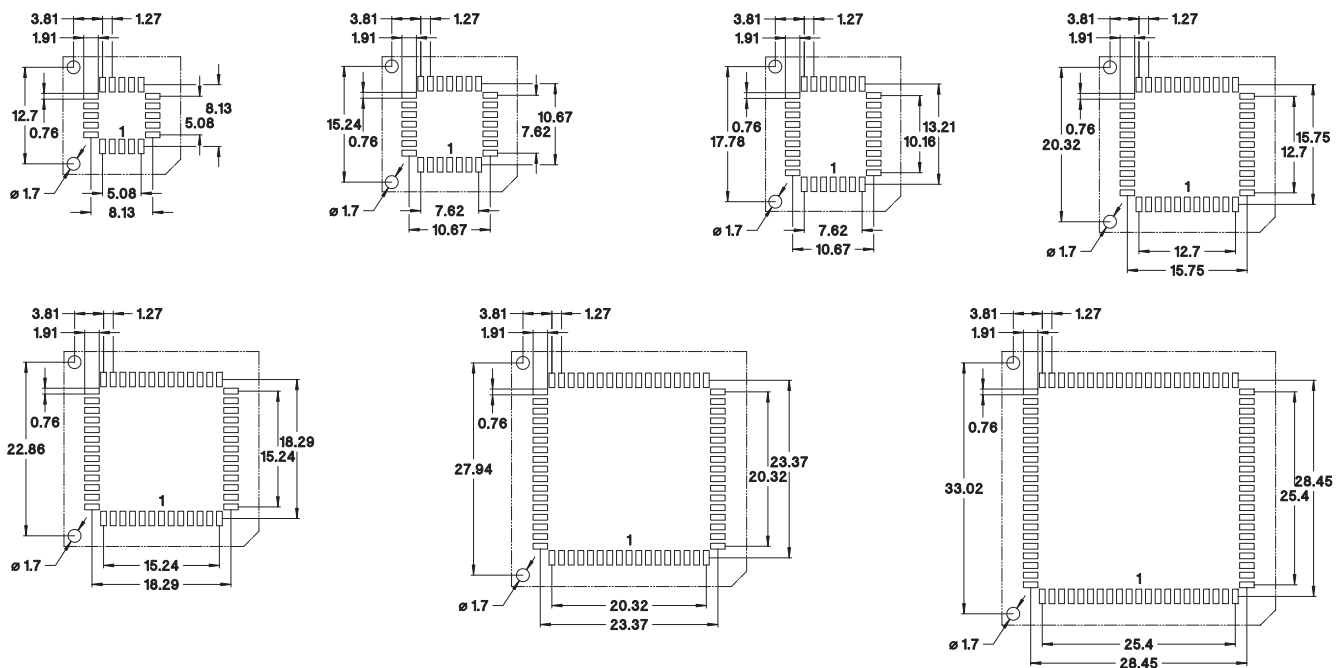



preci-dip

WWW.PRECIDIP.COM TEL +41 32 421 04 00 SALES@PRECIDIP.COM

# SOCKETS FOR PLASTIC LEADED CHIP CARRIERS (PLCC)

SOLDER TAIL

Series 540 PLCC sockets, solder tail, with precision stamped contacts providing component retention thanks to positive spring action.

## TECHNICAL SPECIFICATIONS (FOR GENERAL SPECS, SEE PAGE 155)

INSULATOR	Glass filled thermoplastic PPS-GF40-FR
FLAMMABILITY	UL 94V-0
CONTACT	Phosphor bronze
MECHANICAL LIFE	Min. 25 cycles
RATED CURRENT	1 A
CONTACT RESISTANCE	Max. 30 mΩ
DIELECTRIC STRENGTH	Min. 500 V <sub>RMS</sub>
INSULATION RESISTANCE	Min. 1'000 MΩ
CAPACITANCE	Max. 1 pF

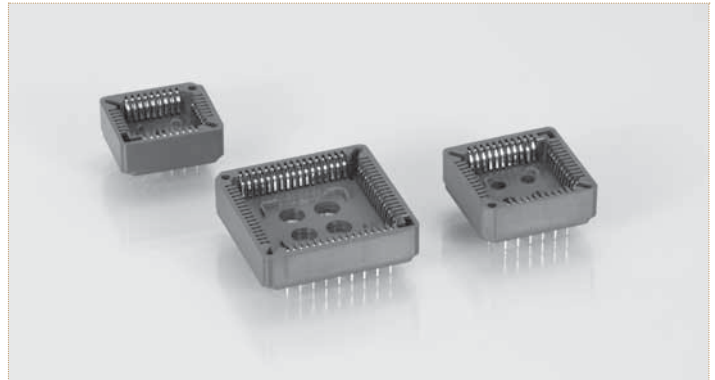

## ORDERING INFORMATION ROHS COMPLIANT PARTS

PP PLATING CODE	TERMINATION	CONTACT
88	Tin	Tin

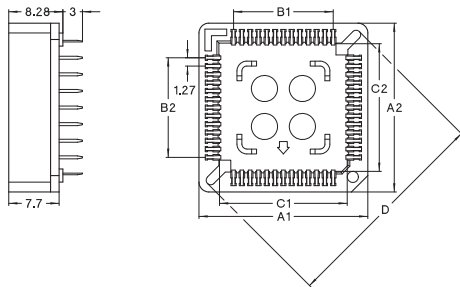

\* RECTANGULAR

NO. OF POLES	A1	A2	B1	B2	C1	C2	D	ORDER CODES
28	18.20	18.20	7.62	7.62	11.91	11.91	22.11	540-88-028-24-008
32*	18.20	20.74	7.62	10.16	11.91	14.45	23.90	540-88-032-24-008
44	23.28	23.28	12.70	12.70	16.99	16.99	29.23	540-88-044-24-008
52	25.82	25.82	15.24	15.24	19.53	19.53	32.85	540-88-052-24-008
68	30.90	30.90	20.32	20.32	24.61	24.61	40.03	540-88-068-24-008
84	35.98	35.98	25.40	25.40	29.69	29.69	47.21	540-88-084-24-008

## PCB HOLE PATTERNS SERIES 540, THRU-HOLE TYPES

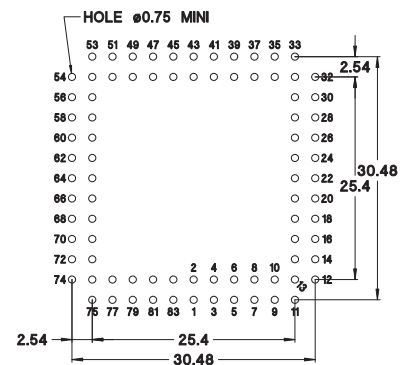
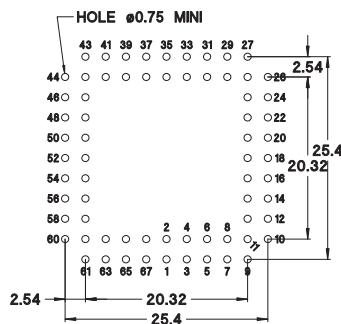
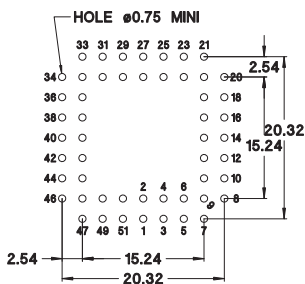
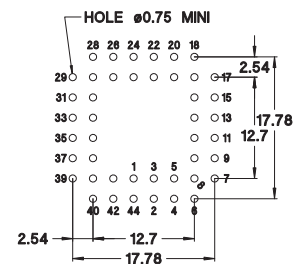
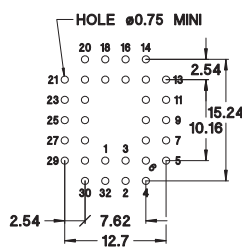
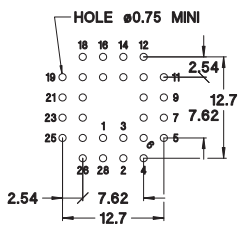

PGA/BGA/PLCC SOCKETS

# CONTACTS







**preci-dip**

[WWW.PRECIDIP.COM](http://WWW.PRECIDIP.COM) TEL +41 32 421 04 00 SALES@PRECIDIP.COM

# CONTACT TECHNOLOGY

## INTRODUCTION

PRECI-DIP, a world wide leading manufacturer of precision machined contacts and related interconnect components is continuously improving its ability to design innovative contacts. This catalog provides general technical information on PRECI-DIP contacts. It should help potential users make the best technical choice for a given application.

**TO FIND INDIVIDUAL SPECIFICATIONS OF STANDARD CONTACTS, PLEASE CONSULT OUR SEARCH ENGINE AT [WWW.PRECIDIP.COM](http://WWW.PRECIDIP.COM)**

If no adequate solution can be found there, please contact us, only a selected choice of all existing contacts is displayed. Further, PRECI-DIP will be pleased to offer full support to design and manufacture customer specific contacts.

## THREE MAIN GROUPS OF CONTACT PRODUCTS ARE DESCRIBED AND OFFERED

- Spring-loaded contacts
- Socket contacts also called female contacts or pin receptacles
- Pin or male contacts and PCB terminals

All of these can be manufactured with different type of terminations:

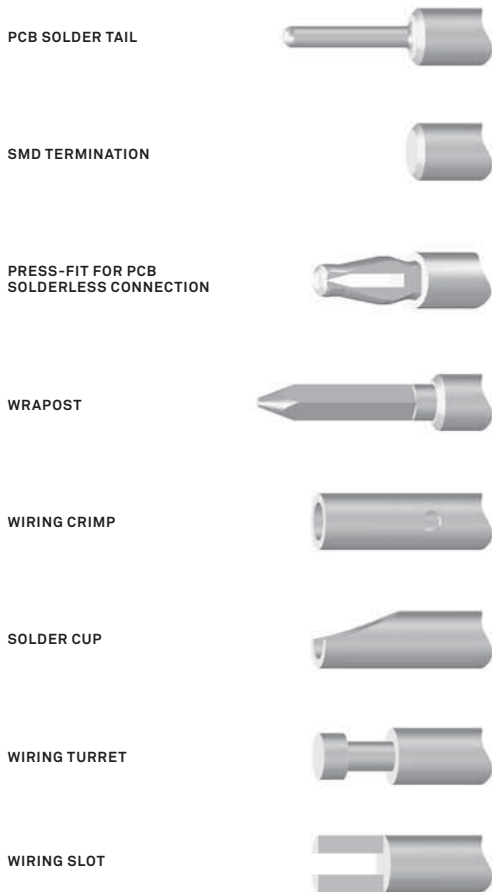

## THIS CATALOG SECTION CONTAINS GENERAL TECHNICAL INFORMATION ON PRECI-DIP CONTACTS

	PAGE		PAGE
Socket contact selector	177	Spring-loaded contacts	180
General technical specifications	178	MIL contacts	182
Socket + pin contacts	179	Data sheet clip contacts	185





precip-dip

WWW.PRECIDIP.COM TEL +41 32 421 04 00 SALES@PRECIDIP.COM

# CONTACT TECHNOLOGY

## SOCKET CONTACT SELECTOR

### CONTACT SELECTOR BY MATING PIN DIAMETER

The mating pin diameter range and insertion characteristics of socket contacts are identified with the clip code, given by the last 4 digits of the part number.

#### 1 TO SEARCH A SUITABLE SOCKET CONTACT TO MATE WITH A KNOWN PIN:

With the graph on the right, find the group code corresponding to the mating pin diameter. In the table below right, search the clip codes corresponding to the group and the page number of the corresponding data sheet.

All clip codes from the same group are interchangeable within a given contact body. This allows for contacts with a larger range of insertion characteristics to fulfill the requirements of special applications

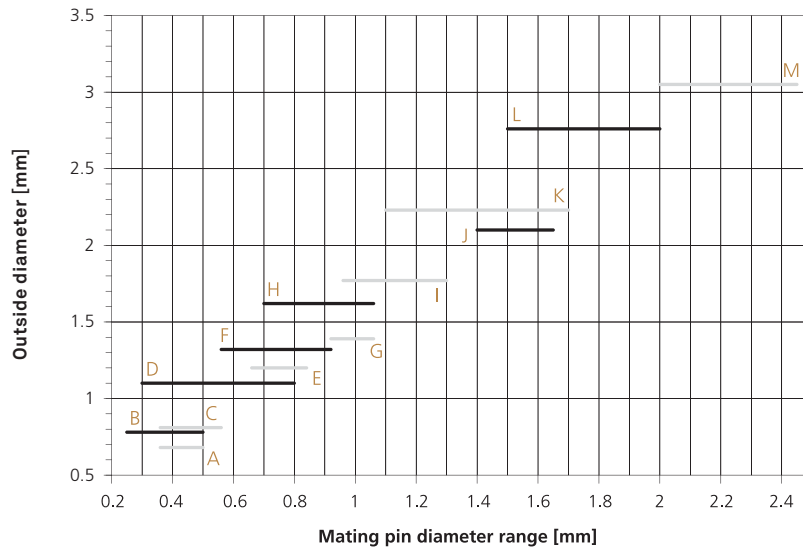

#### 2 TO SEARCH THE CHARACTERISTICS OF A KNOWN CLIP CODE:

Find the corresponding page number for each clip code data sheet in the table on the right side

GROUP	CLIP CODE	TYP. INSERTION FORCE [N]	TEST PIN DIAM. [mm]	SEE PAGE
A	0110	0.25	0.38	185
B	5410	0.20	0.30	185
C	1110	1.0	0.43	185
	2110	0.8	0.46	186
	0510	0.5	0.52	186
D	3020	0.45	0.30	186
	1210	3.0	0.43	187
	3010	2.0	0.43	187
	2210	0.6	0.46	187
	3110	0.7	0.46	188
	3130	0.4	0.46	188
	3160	0.2	0.46	188
	5210	0.56	0.76	189
E	1410	1.5	0.78	189
F	1610	3.5	0.76	189
	0610	1.5	0.76	190
	4710	0.4	0.76	190
G	1810	2.0	1.04	190
H	3410	4.0	1.04	191
I	0210	5.0	1.15	191
	2710	2.2	1.15	191
J	4910	3.0	1.61	192
K	1310	1.3	1.27	192
	2310	3.0	1.30	192
	3920	2.5	1.61	193
L	0710	4.0	1.88	193
M	4010	10.0	2.41	193



preci-dip

WWW.PRECIDIP.COM TEL +41 32 421 04 00 SALES@PRECIDIP.COM

# CONTACT TECHNOLOGY

GENERAL SPECIFICATIONS

## GENERAL TECHNICAL SPECIFICATIONS

The contacts are manufactured by high speed turning process with, if necessary, additional secondary machining operation for example for flats, slots or solder cups. The preferred diameter range lies between 1 and 6 mm and contact length up to 40 mm are standard.

## MATERIALS

### CONTACT BODIES

- Brass CuZn36Pb3, C36000
- Brass CuZn35Pb2, C34500 for contacts with crimp terminations
- Bronze CuSn4Pb4Zn4, C54400 for contacts with compliant press-fit terminations

### CLIPS

- Beryllium copper alloy C17200

### SPRINGS

- Stainless steel X12CrNi177 mat. Nr 1.4310, DIN 17224
- Music wire mat. Nr 1.1211, DIN 17223

### HOODS

- Stainless steel AISI 305

All these materials are compliant with RoHS requirements. Lead content of copper alloys is less than 4% in accordance with Exception 6 of the RoHS directive 2002/95/CE.

## PLATING

Contact plating is made up of basis underplating acting as diffusion barrier and of finishing layer.

### UNDERPLATING

- Nickel (Ni) electro-deposited, acc. to SAE-AMS-QQ-N-290
- Electroless nickel phosphorus alloy for max. corrosion and wear resistance and for lowest magnetic permeability (plating suffix N)

### FINISH

- Gold (Au) acc. to ASTM B488, type II C, plating codes 1 (0.25  $\mu\text{m}$ ), 3 (0.75  $\mu\text{m}$ ), 4 (1.27  $\mu\text{m}$ ) and 7 (gold flash)
- Tin (pure tin Sn), plating code 8, standard tin plating with excellent solderability, RoHS compliant
- Tin-Lead (SnPb90/10) acc. to ASTM B545, plating code 9. This plating is **not RoHS compliant**.
- Silver (Ag) acc. to ASTM B700, plating code 6

## ELECTRICAL AND MECHANICAL CHARACTERISTICS

See individual data pages

## ENVIRONMENTAL CHARACTERISTICS

The contacts withstands following environmental tests without mechanical and electrical defects:

- Dry heat steady state IEC 60512-11-9.11i / 60068-2-2.Bb: 125 °C, 16 h
- Damp heat cyclic IEC 60512-11-12.11m / 60068-2-30.Db: 25/55 °C, 90 – 100 %rH, 1 cycle of 24 h
- Cold steady state IEC 60512-11-10.11j / 60068-2-1.A: -55 °C, 2 h
- Thermal shock IEC 60512-11-4.11d / 60068-2-14.Na: -55/125 °C, 5 cycles 30 min
- Sinusoidal vibrations IEC 60512-6-4.6d / 60068-2-6.Fc: 10 to 500 Hz, 10 g, 1 octave/min, 10 cycles for each axis
- Shock IEC 60512-6-3.6c / 60068-2-27.Ea: 50 g, 11 ms, 3 shocks in three axis

During the above two tests no contact interruption >50 ns does appear.

- Solderability J-STD-002C, Test A1, 245 °C, 5 s, solder alloy SnAg3.8Cu0.7
- Resistance to soldering heat J-STD-020C, 260 °C, 20 s
- Resistance to corrosion:
  - 1) Salt spray test IEC 60068-2-11.Ka: 48 h
  - 2) Sulfur dioxide (SO<sub>2</sub>) test IEC 60068-2-42.Kc: 96 h at 25 ppm SO<sub>2</sub>, 25 °C, 75 %rH
  - 3) Hydrogen sulfide (H<sub>2</sub>S) test IEC 60068-2-43.Kd: 96 h at 12 ppm H<sub>2</sub>S, 25 °C, 75 %rH



preci-dip

WWW.PRECIDIP.COM TEL +41 32 421 04 00 SALES@PRECIDIP.COM

# CONTACT TECHNOLOGY

## SOCKET AND PIN CONTACTS

### SOCKET CONTACTS

The PRECI-DIP technology for socket contacts is based on a two-parts design:

- Contact body
- Multi-finger contact spring called clip

These socket contacts with clip are compatible with all existing machined and stamped mating pin contacts of same size

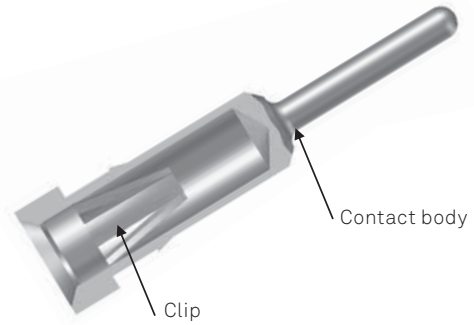

### CONTACT BODIES AND CLIPS ARE MANUFACTURED AND PLATED SEPARATELY

The contact bodies are manufactured by high speed turning process with additional secondary machining operation if required.

The clip are stamped and formed from sheet material. Depending on size and characteristics, the clips are designed with 3 to 8 contact finger. The choice of heat treated beryllium copper alloy gives the best possible combination of mechanical and electrical properties for use in electrical contacts. More than 40 clips are pre-tooled, covering a mating pin diameter range from 0.25 to 2.5 mm. They can accept square or rectangular pin.

The clip is assembled into the contact body by press-fit on automatic equipment including on-line inspections.

### MAIN ADVANTAGES OF THE TECHNOLOGY

- The combination of existing standard clip with specific contact body gives a flexibility unknown with traditional contact design
- Production of machined specific contact bodies is cost effective starting at medium sized quantities
- PRECI-DIP automatic high speed contact assembly lines are optimized for large production runs but also for smaller series

### PIN CONTACTS

Precision screw-machined pin contacts are the best choice for many applications:

- High quality, low dimensional tolerances
- Best surface of the mating end for applications requiring high mating cycle count
- Wide range of dimensions and geometry
  - Length from 3 to 50 mm
  - Diameter from 0.25 to 6 mm
- Low initial (tooling) costs and attractive prices for medium and high volume production due to manufacturing on high speed automatic lathes

With its own plating unit, PRECI-DIP offers single source services for finished contacts

### MECHANICAL CHARACTERISTICS

- Insertion characteristics  
Insertion and withdrawal force for standard clips are displayed on the corresponding data sheets. The values are measured with polished steel gauges with spherical tip and are typical average measurements. These data are for general information and selection of best suited clip for a given application.
- Compliancy  
Each clip is able to accept a broad range of mating pins. This ability is called «compliancy». The compliancy factor  $\Delta$  specifies the resulting operating range after insertion of the largest permissible mating pin.
- Clip retention  
This is the force needed to pull-out the press-fitted clip from its contact body. Clip retention is greater than 40 N.
- Mechanical life  
The mechanical life expectancy is dependent on the surface smoothness and diameter of the mating pin and on the plating. For some applications, more than 1000 mating cycles are possible.

### ELECTRICAL CHARACTERISTICS

- Current rating  
The given currents are for one mated combination of socket and pin contact, in free air and for 10°C temperature rise.

### BI-BLOC PIN CONTACTS

PRECIDI-DIP offers «selective plated» bi-bloc pin contact with the high quality of machined contact and the advantages of selective plating. These contacts are made from 2 parts: the contact body with termination and the connecting or mating pin manufactured separately and assembled after plating.

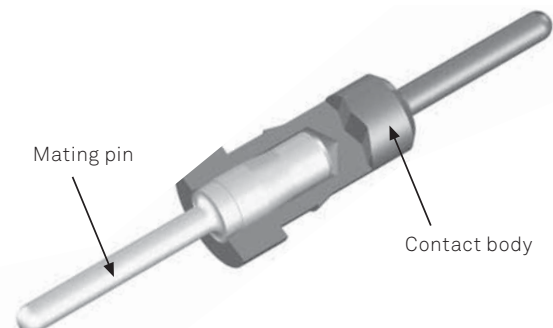



preci-dip

WWW.PRECIDIP.COM TEL +41 32 421 04 00 SALES@PRECIDIP.COM

# CONTACT TECHNOLOGY

## SPRING-LOADED CONTACTS

### SPRING-LOADED CONTACTS

Spring-loaded contacts were initially designed since 1995 for mobile phones. The application requires miniature, reliable, contacts with very high mating cycles count at low cost. The basic design of spring-loaded contact with hollow piston consists of a contact body or barrel, a contact member or piston and an helical compression spring. The piston is retained in the barrel by a crimp. The electrical contact is established by pressure between the piston and a fixed, flat, conducting area of the opposite part.

Based on this initial model, new contacts with improved characteristics were designed:

- Low resistance spring-loaded contacts with shaped piston
- High-reliable contacts with clip. This contact design is protected by international patents

### Main advantages

- Very long life time
- Many types of terminations available (see page Introduction)
- Small dimensions for use in applications with limited space (min. contact height 3 mm, min. contact diameter 1 mm)
- Very good resistance to shocks and vibrations
- Best adapted where conventional connection solutions cannot satisfy the application requirements:

In case of important positioning tolerances of the connectors parts

For compensation of errors of parallelism and flatness

To make connection with pivoting, rotating or non parallel mating movement

For connections with sliding mating action (push and lock)

### CHARACTERISTICS

STANDARD CONTACTS  
HOLLOW PISTON  
DESIGN



IMPROVED-DESIGN CONTACTS  
SLANT PISTON  
DESIGN      POLYGONAL PISTON  
DESIGN



«HIGH RELIABILITY» CONTACTS  
CLIP COAXIAL  
DESIGN



«HIGH RELIABILITY» CONTACTS  
CLIP IN-LINE  
DESIGN



patented

patented

### ENVIRONMENTAL

Operating temp. range

- 55°C to + 85°C (music wire) / + 125°C (stainless steel)

### MATERIALS (RoHS-compliant)

Piston		Gold plated machined brass		
Barrel		Gold plated machined brass		
Spring		Gold plated music wire / Stainless steel		Gold plated BeCu C17200
Clip	-	-		

### MECHANICAL

Min. diameter	1.1 mm	1.5 mm	1.8 mm	0.8 mm
Min. initial height	2.5 mm	5 mm	4.5 mm	9 mm
Travel / height ratio	Max. 0.3	Max. 0.2	Max. 0.2	Max. 0.15
Max. travel (stroke)	2 mm	2 mm		1.5 mm
Min. initial spring force	0.2 N	0.2 N		0.2 N
Mechanical life*	100'000 cycles	50'000 cycles		40'000 cycles

### ELECTRICAL

Contact resistance**	Max. 15 mΩ	Max. 10 mΩ		Max. 20 mΩ
Max. operating current***	1 A cont. / 2 A peak	3.5 A cont. / 7 A peak		2 A cont. / 4 A peak

\* Tested at nominal stroke with perpendicular pad connector area    \*\* Static measurement in halfway position of piston travel

\*\*\* Above max. current values are for single contacts in free air and for 10°C temperature rise. Values are indicative and may be affected by contact force, static or dynamic applications, shocks or vibrations



preci-dip

WWW.PRECIDIP.COM TEL +41 32 421 04 00 SALES@PRECIDIP.COM

# CONTACT TECHNOLOGY

SPRING-LOADED CONTACTS

## DOUBLE-SIDED SPRING-LOADED CONNECTORS

A solderless connecting system with double-sided pressure connection (Fig.1).

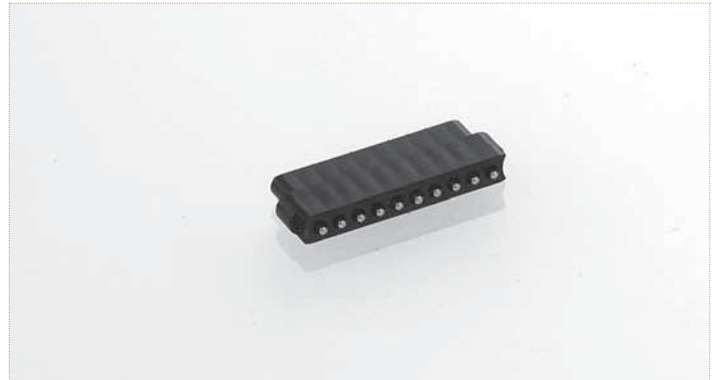

### WORKING MODE

The conventional spring-loaded contact (SLC) ① is mounted in a frame (housing) ②.

The barrel has a groove behind a retention barb ③.

The first contact surface is positioned on one side of the SLC (Fig. 2).

The second contact surface will actuate the spring-loaded contact. An equal contact pressure applies on both surfaces (Fig. 3).

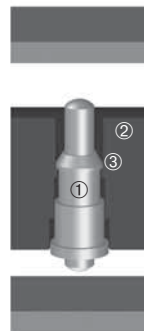

Fig. 1



Fig. 2

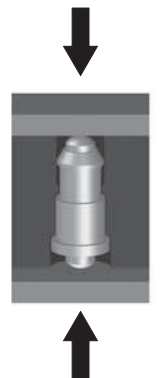

Fig. 3

### AVAILABILITY

Double-sided contacts have been designed to be assembled on custom design connectors or to be integrated by customer into their own assemblies:

- contacts with outside diameter 1.8 mm with min. 4.5 mm distance (D) between connecting surfaces (see Fig. 3).
- contacts with min. 0.8 mm outside diameter and min. 8 mm distance (D) for fine pitch applications.
- long stroke and high contact pressure high reliability clip contacts.

Please consult for more information.





preci-dip

WWW.PRECIDIP.COM TEL +41 32 421 04 00 SALES@PRECIDIP.COM

# CONTACT TECHNOLOGY

MIL CONTACTS

## INTRODUCTION

PRECI-DIP has tapped its unique expertise and tested know-how to develop new MIL socket contacts based on the clip technology.

Two socket contact technologies are available: hooded contacts using the reversed clip and hoodless contacts using the Eagle Grip clip.

These contacts have successfully passed all the qualification tests according to AS39029 and are listed on the QPL.

We are also manufacturing the corresponding precision-machined pin contacts.



## HOODED CONTACTS USING THE REVERSED CLIP PATENTED TECHNOLOGY

### CONTACT DESIGN

The contact consists of three parts, separately manufactured and made of different base materials. This design allows to optimise the performance and to select the most appropriate production process individually:

- Contact body made of machined brass
- Reversed clip made of stamped and formed beryllium-copper
- Protection hood made of deep-drawn stainless steel

Separate electroplating processes of body and clip allow the best cost-performance ratio. The assembly of the three parts is then carried out on dedicated, fully automatic assembly lines.

Reversed clip contacts are presently available in size 12, 16, 20 and 22. This proprietary technology, entirely developed by PRECI-DIP, is protected by international patents.

### ADVANTAGES AND CHARACTERISTICS

In comparison with the traditional slotted contact body, the reversed clip design has several advantages:

- Smaller difference between insertion and extraction force
- Reduced dispersion of the force values
- Better redundancy at the level of the contact point, thanks to 6 or 8 contact fingers

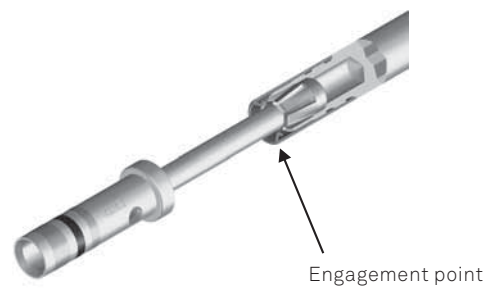
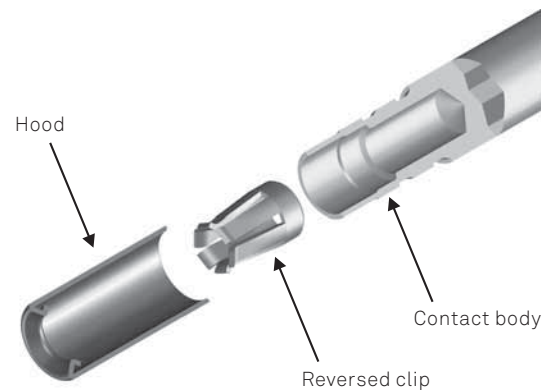

Reversed clip available in sizes 12, 16, 20, 22



preci-dip

WWW.PRECIDIP.COM TEL +41 32 421 04 00 SALES@PRECIDIP.COM

# CONTACT TECHNOLOGY

MIL CONTACTS

## HOODLESS CONTACTS USING THE EAGLE GRIP CLIP PATENTED TECHNOLOGY

### CONTACT DESIGN

- The hoodless contact consists of two parts: the contact body and the clip (separate pressure member) are made from different base materials.
- The high-speed screw machined contact body is made of brass.
- The use of quality crimping brass renders the annealing operation unnecessary.
- The precision stamped and formed Eagle Grip clip is made of beryllium-copper.
- Separate electroplating processes of the body and clip offer the best cost-performance ratio.
- Automatic assembly lines are designed by our engineers to conduct the body and clip assembly.
- The clip is precisely positioned in the outer shell and firmly held in place between a shoulder and the crimp lip.
- In-line mechanical check is carried out on the assembly machine.
- Eagle Grip clip hoodless contacts are presently available in sizes 16, 20 and 22.
- This PRECI-DIP proprietary technology is protected by international patents.

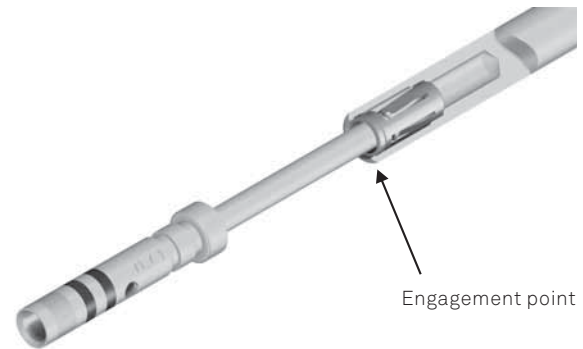
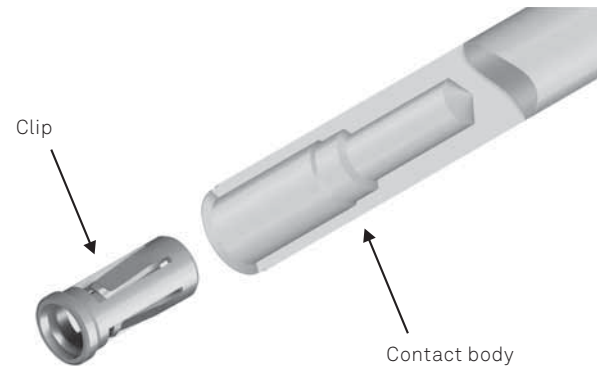

### ADVANTAGES AND CHARACTERISTICS

- 2-piece contact without hood
- Fully automatic assembly process with in-line mechanical check
- Localized finish: body and clip are plated separately
- High surface quality with a stamped and formed clip
- Precision rolling surface finish in the contact area
- Better contact redundancy thanks to 3 or 4 contact fingers
- Repeatability in the manufacturing process of the clip (tooling and stamping)
- Limited difference between insertion and extraction mating forces
- Narrow range of the force values
- Fully integrated manufacturing process on one single production site
- Swiss precision technology

### TECHNICAL SPECIFICATIONS

#### CONTACT BODY

**MATERIAL** Machined brass C34500  
**OVERALL FINISH** Gold plate acc. to ASTM B488, Type II, C, over 2.5 µm Ni

#### CLIP

**MATERIAL** BeCu C17200  
**OVERALL FINISH** Gold plate acc. to ASTM B488, Type II, C, min. 1.27 µm Au over 2.5 µm Ni



preci-dip

WWW.PRECIDIP.COM TEL +41 32 421 04 00 SALES@PRECIDIP.COM

# CONTACT TECHNOLOGY

MIL CONTACTS

## LIST OF PART NUMBERS QUALIFIED PRODUCT LISTED

### SOCKET CONTACTS

CONNECTOR TYPE ACC. TO	MIL P/N	REVERSED / EAGLE GRIP CLIP	PRECI-DIP P/N	SIZE
MIL-DTL-38999 Series I, III, IV	AS/M39029/56-348	Reversed Eagle Grip	83011-1P4-7010-B1 83051-7Q4-6010-01	#22D
	AS/M39029/56-351	Reversed Eagle Grip	83021-1P4-7110-B1 83061-7Q4-6110-01	#20
	AS/M39029/56-352	Reversed Eagle Grip	83031-1P4-7210-B1 83071-7Q4-6210-01	#16
	AS/M39029/56-353	Reversed	83041-1P4-7310-B1	#12
MIL-DTL-38999 Series II	AS/M39029/57-354	Reversed	83101-7Q4-7010-B1	#22D
MIL-DTL-24308		Eagle Grip	83091-7Q4-6010-01	
MIL-DTL-55302				
MIL-DTL-83733				
MIL-DTL-24308	AS/M39029/63-368	Eagle Grip	83121-7Q4-6110-01	#20
MIL-DTL-26482 Series 2	AS/M39029/5-115	Reversed	83181-7Q4-7110-B1	#20
AS 81703 Series 3		Eagle Grip	83131-7Q4-6110-01	
MIL-DTL-83723 Series 3	AS/M39029/5-116	Reversed	83191-7Q4-7210-B1	#16
MIL-DTL-83733		Eagle Grip	83141-7Q4-6210-01	
	AS/M39029/5-118	Reversed	83151-7Q4-7310-B1	#12
MIL-DTL-26482 Series 1	AS/M39029/32-259	Reversed	83161-7Q4-7110-B1	#20
		Eagle Grip	83111-7Q4-6110-01	
MIL-DTL-26482 Series 1	AS/M39029/32-248	Reversed	83171-7Q4-7210-B1	#16
MIL-DTL-26500		Eagle Grip	83081-7Q4-6210-01	

### PIN CONTACTS

CONNECTOR TYPE ACC. TO	MIL P/N	OVERALL / LOCALIZED FINISH	PRECI-DIP P/N	SIZE
MIL-DTL-38999 Series I, II, III, IV	AS/M39029/58-360	Overall	82011-40-01	#22D
		Localized	82011-7Q4-01	
MIL-DTL-24308	AS/M39029/58-363	Overall	82021-40-01	#20
MIL-DTL-55302		Localized	82021-7Q4-01	
MIL-DTL-83733	AS/M39029/58-364	Overall	82031-40-01	#16
		Localized	82031-7Q4-01	
	AS/M39029/58-365	Overall	82041-40-01	#12
		Localized	82041-7Q4-01	
MIL-DTL-24308	AS/M39029/64-369	Overall	82061-40-01	#20
		Localized	82061-7Q4-01	
MIL-DTL-26482 Series 2	AS/M39029/4-110	Overall	82071-40-01	#20
AS 81703 Series 3		Localized	82071-7Q4-01	
MIL-DTL-83723 Series 3	AS/M39029/4-111	Overall	82081-40-01	#16
MIL-DTL-83733		Localized	82081-7Q4-01	
	AS/M39029/4-113	Overall	82091-40-01	#12
		Localized	82091-7Q4-01	
MIL-DTL-26482 Series 1	AS/M39029/31-240	Overall	82051-40-01	#20
		Localized	82051-7Q4-01	
MIL-DTL-26482 Series 1	AS/M39029/31-229	Overall	82101-40-01	#16
MIL-DTL-26500		Localized	82101-7Q4-01	



preci-dip

WWW.PRECIDIP.COM TEL +41 32 421 04 00 SALES@PRECIDIP.COM

# CONTACT DATA

STANDARD CLIP

## CLIP CODE 0110

4-FINGER

MATING PIN DIAMETER RANGE	0.36-0.46 mm
COMPLIANCY $\Delta$	0.08 mm
MIN. MATING PIN LENGTH	1.8 mm
CURRENT RATING	1 A

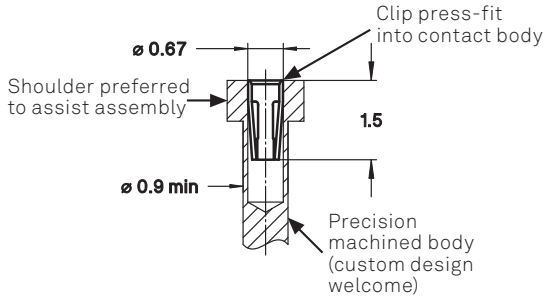

Force [N]

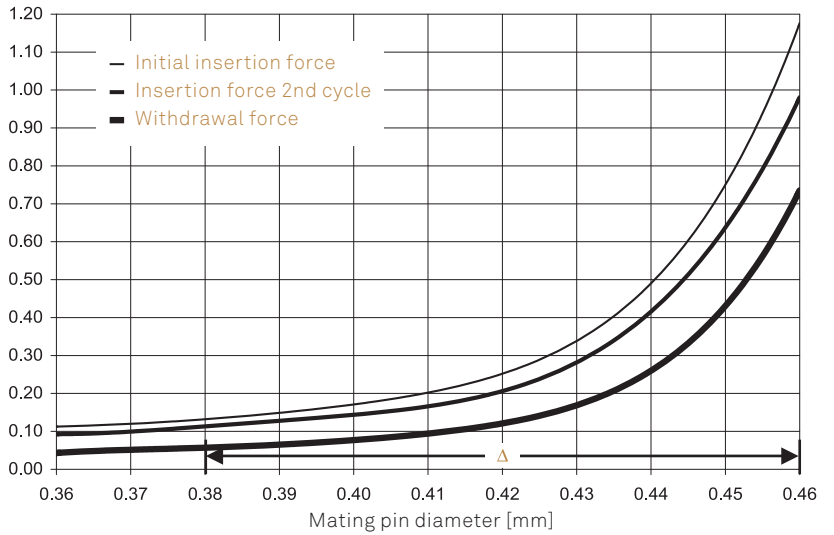

## CLIP CODE 5410

6-FINGER

MATING PIN DIAMETER RANGE	0.3-0.5 mm
COMPLIANCY $\Delta$	0.12 mm
MIN. MATING PIN LENGTH	1.8 mm
CURRENT RATING	1 A

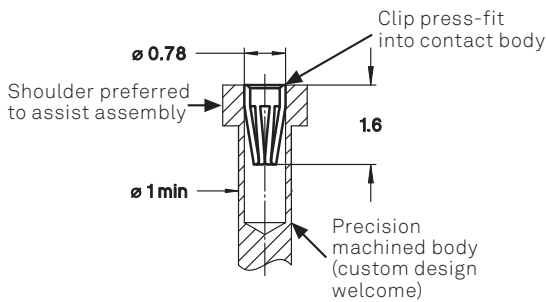

Force [N]

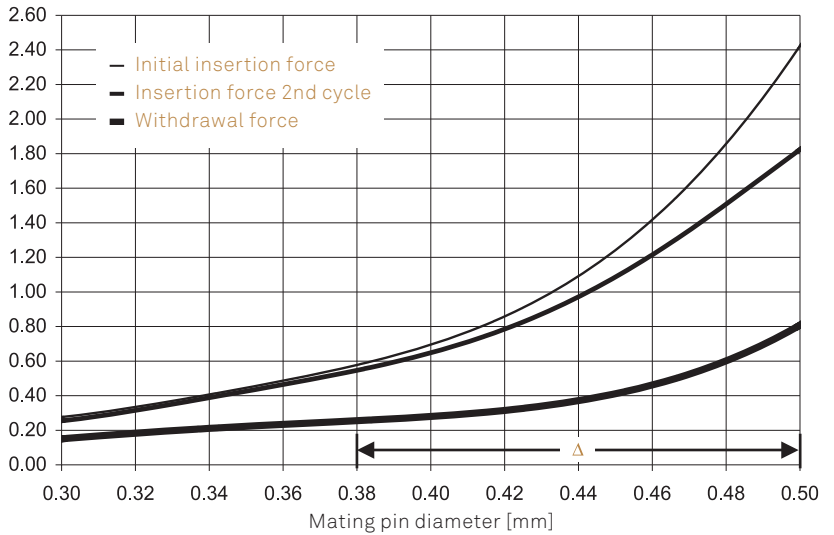

## CLIP CODE 1110

3-FINGER

MATING PIN DIAMETER RANGE	0.36-0.52 mm
COMPLIANCY $\Delta$	0.12 mm
MIN. MATING PIN LENGTH	2.3 mm
CURRENT RATING	3 A

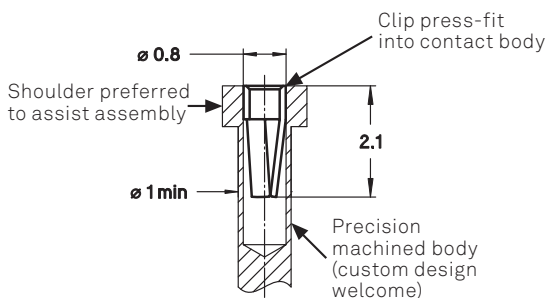

Force [N]

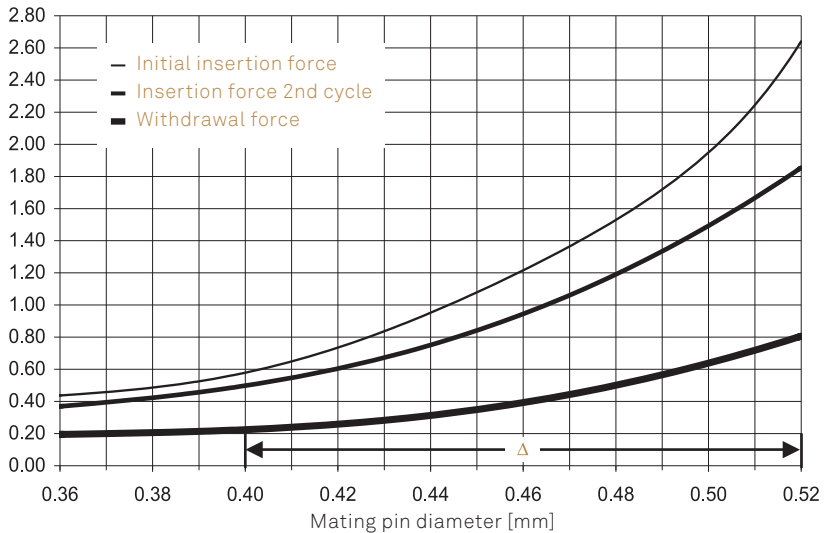

CONTACTS



preci-dip

WWW.PRECIDIP.COM TEL +41 32 421 04 00 SALES@PRECIDIP.COM

# CONTACT DATA

STANDARD CLIP

## CLIP CODE 2110

3-FINGER

MATING PIN DIAMETER RANGE	0.38-0.54 mm
COMPLIANCY $\Delta$	0.16 mm
MIN. MATING PIN LENGTH	2.2 mm
CURRENT RATING	2 A

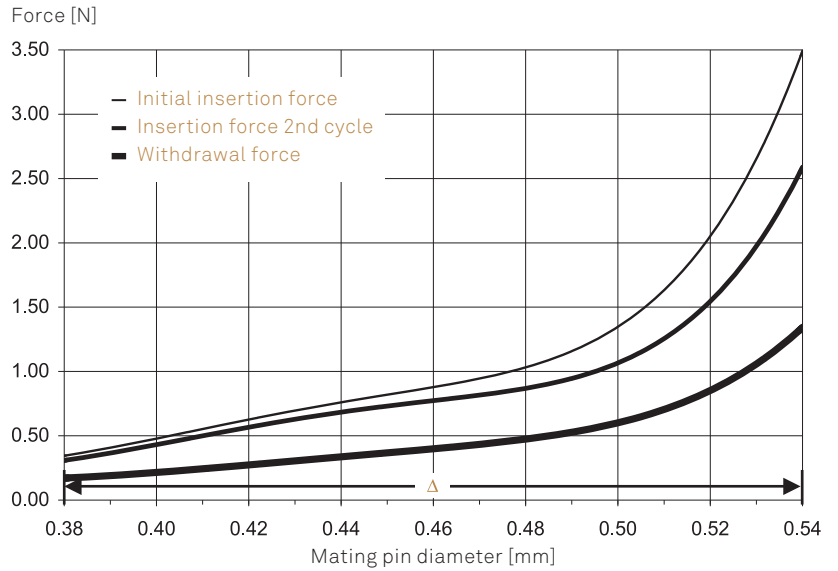
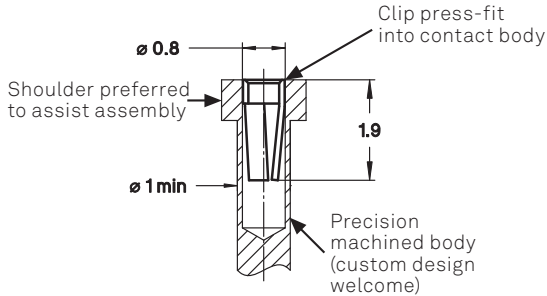

## CLIP CODE 0510

3-FINGER

MATING PIN DIAMETER RANGE	0.4-0.56 mm
COMPLIANCY $\Delta$	0.1 mm
MIN. MATING PIN LENGTH	2.2 mm
CURRENT RATING	2 A

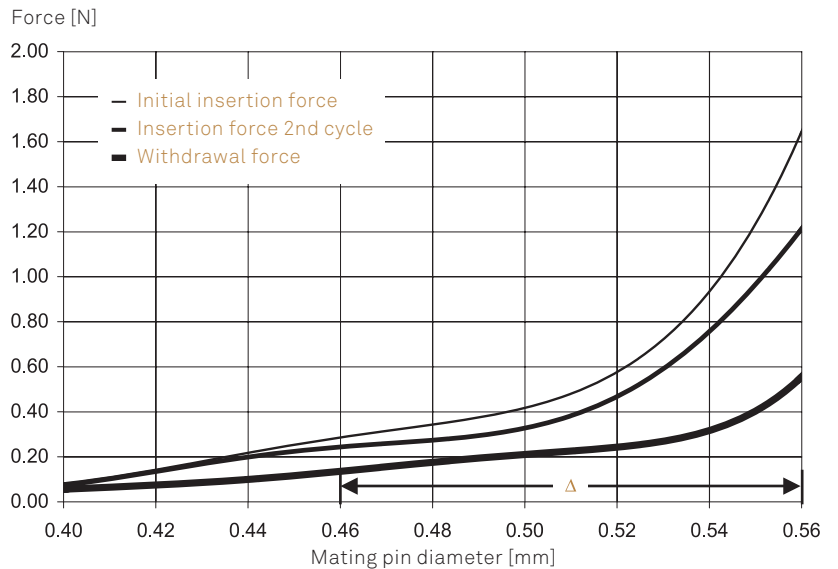
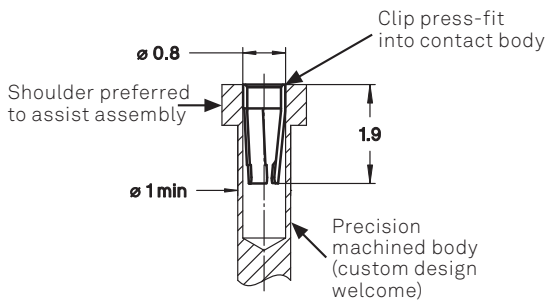

## CLIP CODE 3020

4-FINGER

MATING PIN DIAMETER RANGE	0.3-0.5 mm
COMPLIANCY $\Delta$	0.2 mm
MIN. MATING PIN LENGTH	2.4 mm
CURRENT RATING	3 A

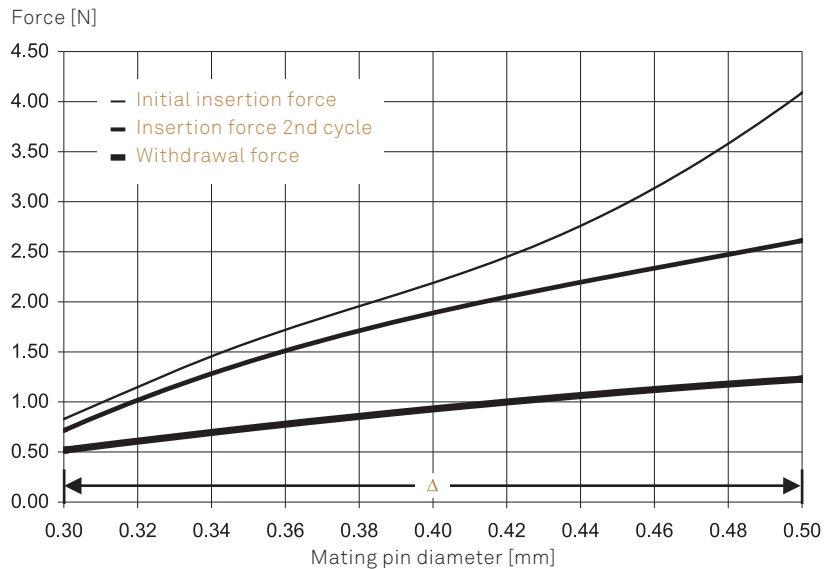
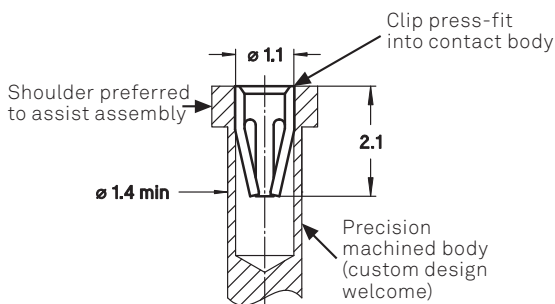





precidip

WWW.PRECIDIP.COM TEL +41 32 421 04 00 SALES@PRECIDIP.COM

# CONTACT DATA

STANDARD CLIP

## CLIP CODE 1210

4-FINGER

MATING PIN DIAMETER RANGE	0.32-0.52 mm
COMPLIANCY $\Delta$	0.14 mm
MIN. MATING PIN LENGTH	2 mm
CURRENT RATING	3 A

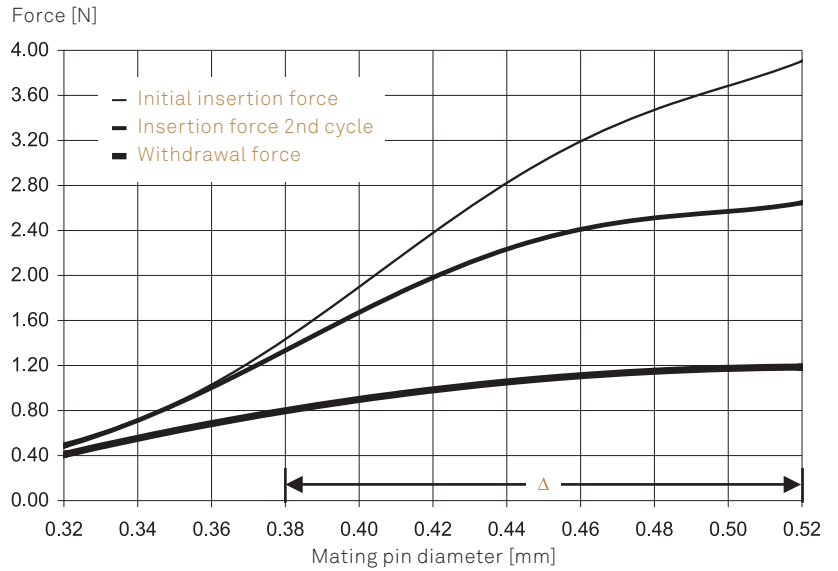
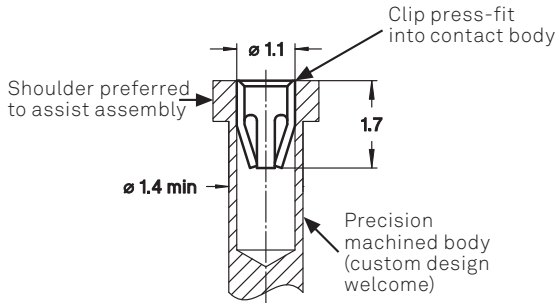

## CLIP CODE 3010

4-FINGER

MATING PIN DIAMETER RANGE	0.36-0.56 mm
COMPLIANCY $\Delta$	0.2 mm
MIN. MATING PIN LENGTH	2.4 mm
CURRENT RATING	3 A

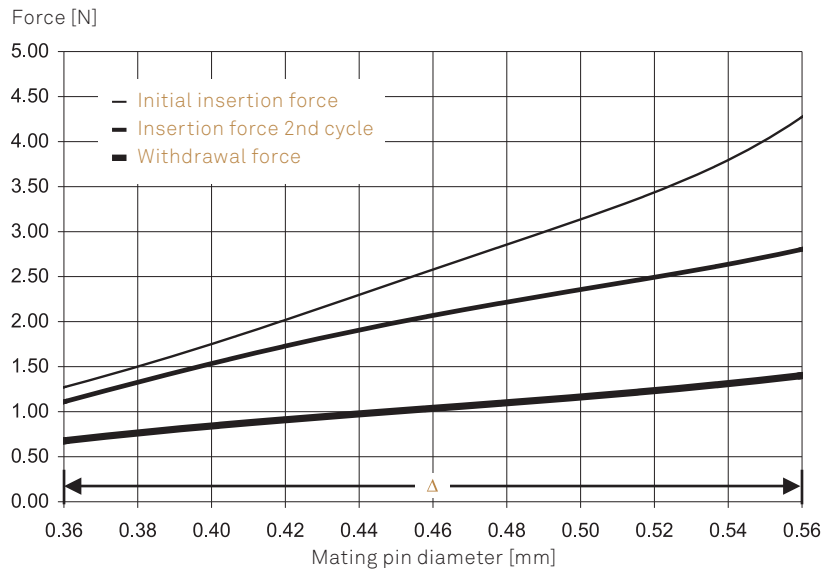
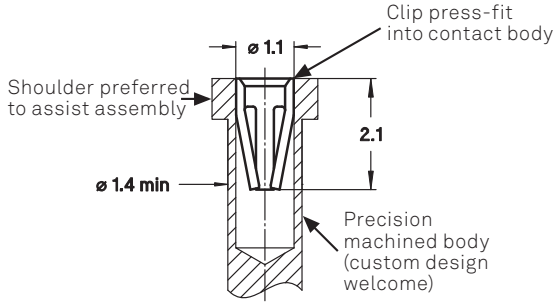

## CLIP CODE 2210

6-FINGER

MATING PIN DIAMETER RANGE	0.4-0.64 mm
COMPLIANCY $\Delta$	0.14 mm
MIN. MATING PIN LENGTH	2 mm
CURRENT RATING	3 A

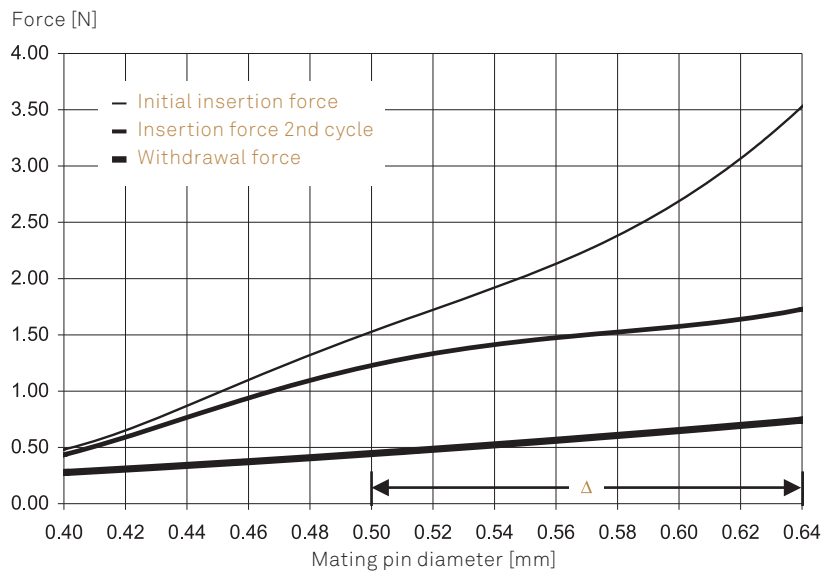
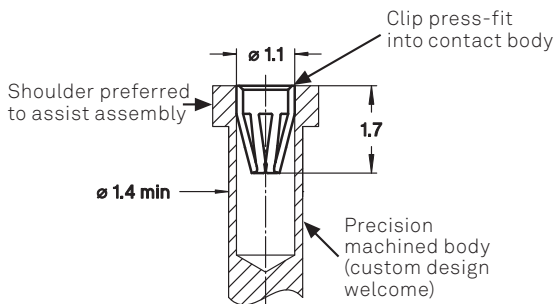



preci-dip

WWW.PRECIDIP.COM TEL +41 32 421 04 00 SALES@PRECIDIP.COM

# CONTACT DATA

STANDARD CLIP

## CLIP CODE 3110

6-FINGER

MATING PIN DIAMETER RANGE	0.38-0.7 mm
COMPLIANCY $\Delta$	0.3 mm
MIN. MATING PIN LENGTH	2.5 mm
CURRENT RATING	3 A

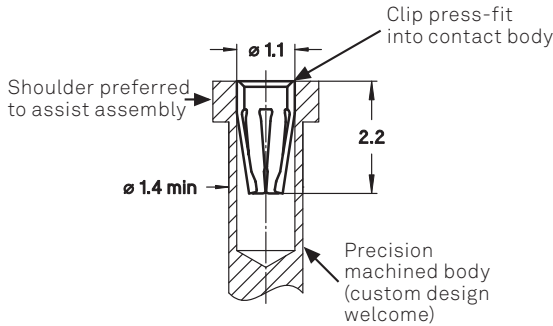

Force [N]

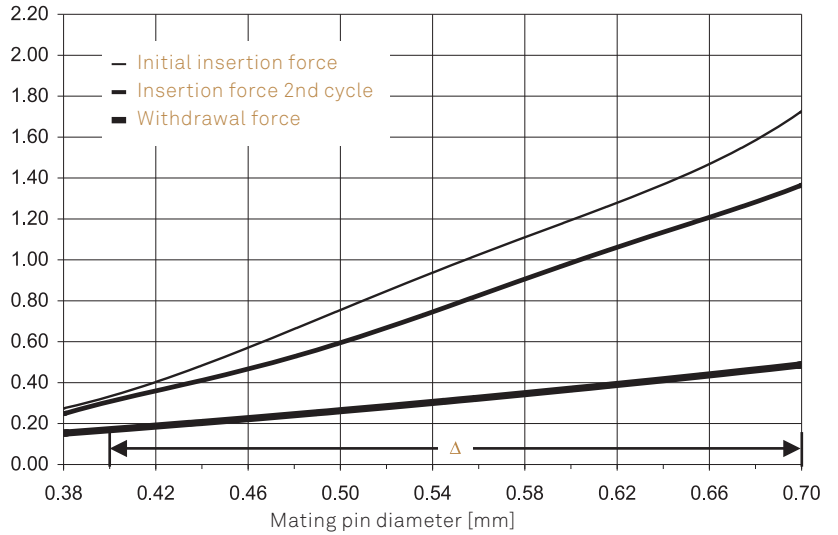

## CLIP CODE 3130

6-FINGER

MATING PIN DIAMETER RANGE	0.38-0.7 mm
COMPLIANCY $\Delta$	0.26 mm
MIN. MATING PIN LENGTH	2.5 mm
CURRENT RATING	3 A

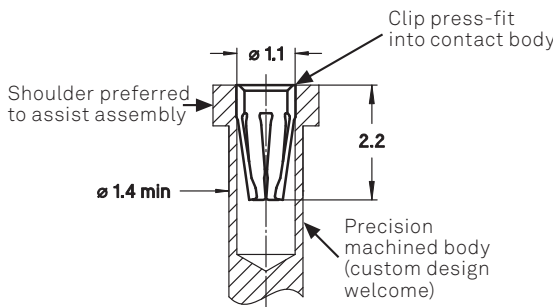

Force [N]

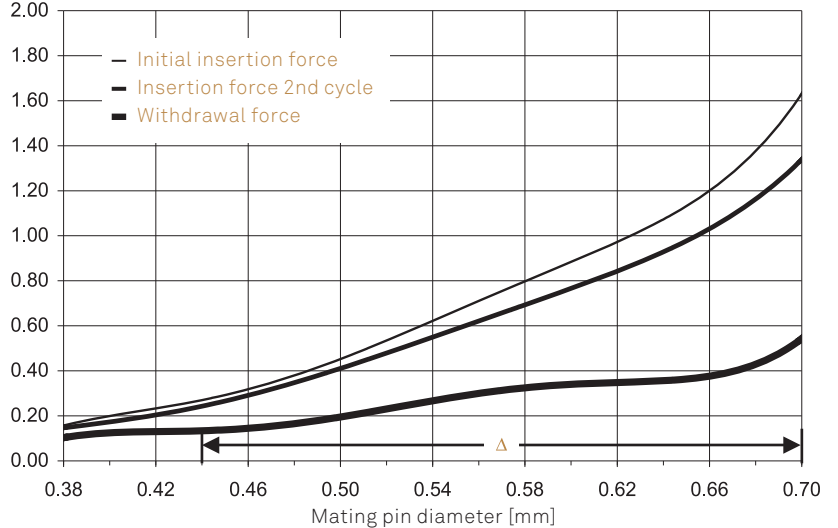

## CLIP CODE 3160

6-FINGER

MATING PIN DIAMETER RANGE	0.42-0.72 mm
COMPLIANCY $\Delta$	0.28 mm
MIN. MATING PIN LENGTH	2.5 mm
CURRENT RATING	3 A

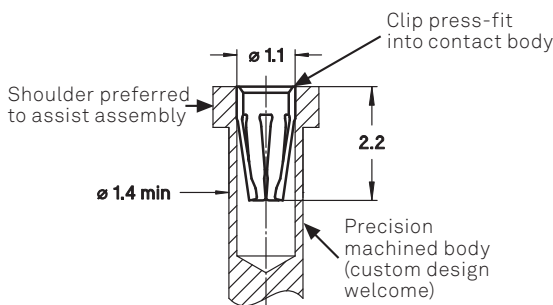

Force [N]

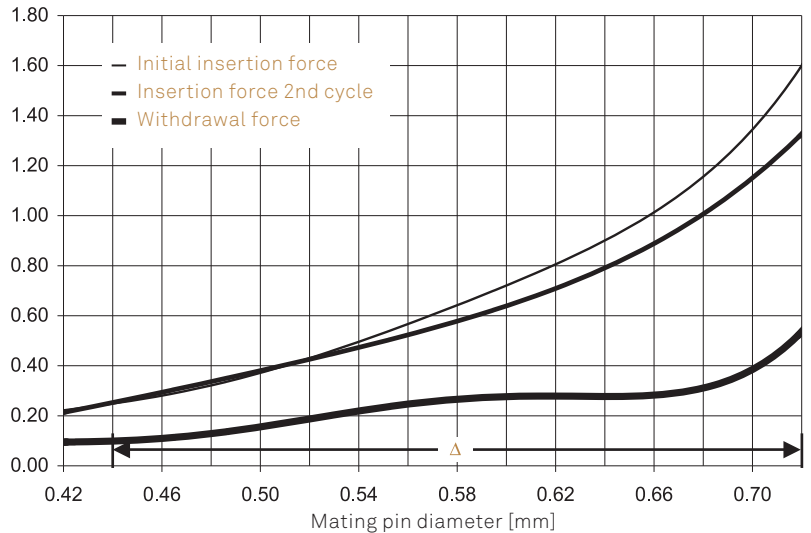



preci-dip

WWW.PRECIDIP.COM TEL +41 32 421 04 00 SALES@PRECIDIP.COM

# CONTACT DATA

STANDARD CLIP

## CLIP CODE 5210

6-FINGER

MATING PIN DIAMETER RANGE	0.7-0.8 mm
COMPLIANCY $\Delta$	0.1 mm
MIN. MATING PIN LENGTH	2.2 mm
CURRENT RATING	4.5 A

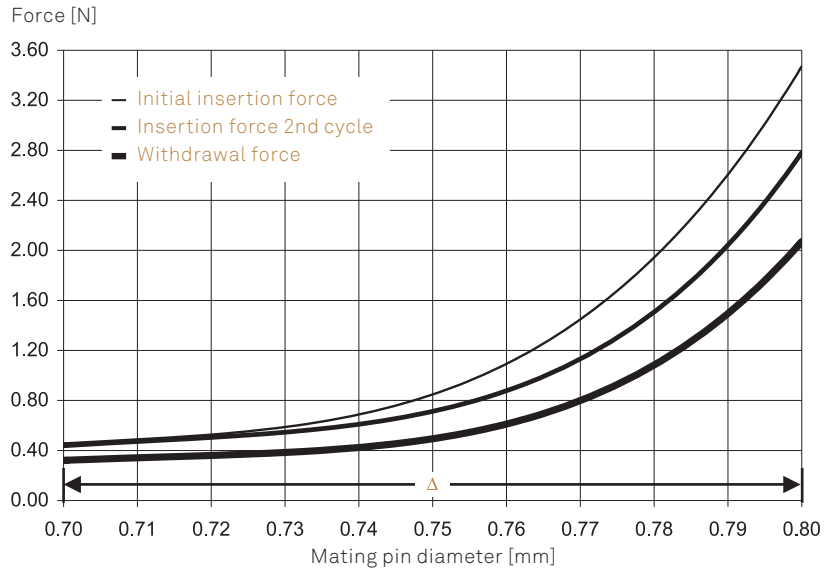
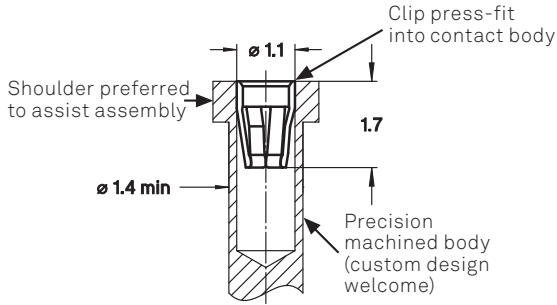

## CLIP CODE 1410

6-FINGER

MATING PIN DIAMETER RANGE	0.66-0.84 mm
COMPLIANCY $\Delta$	0.16 mm
MIN. MATING PIN LENGTH	2.2 mm
CURRENT RATING	4.5 A

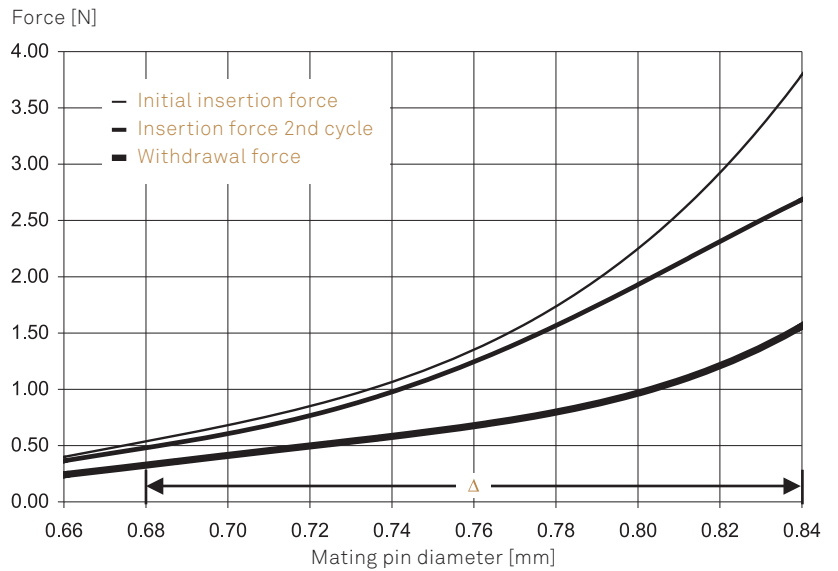
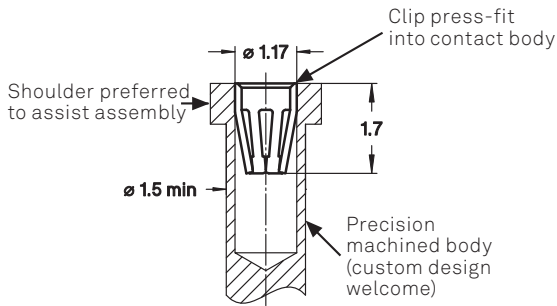

## CLIP CODE 1610

6-FINGER

MATING PIN DIAMETER RANGE	0.56-0.84 mm
COMPLIANCY $\Delta$	0.2 mm
MIN. MATING PIN LENGTH	2.7 mm
CURRENT RATING	5 A

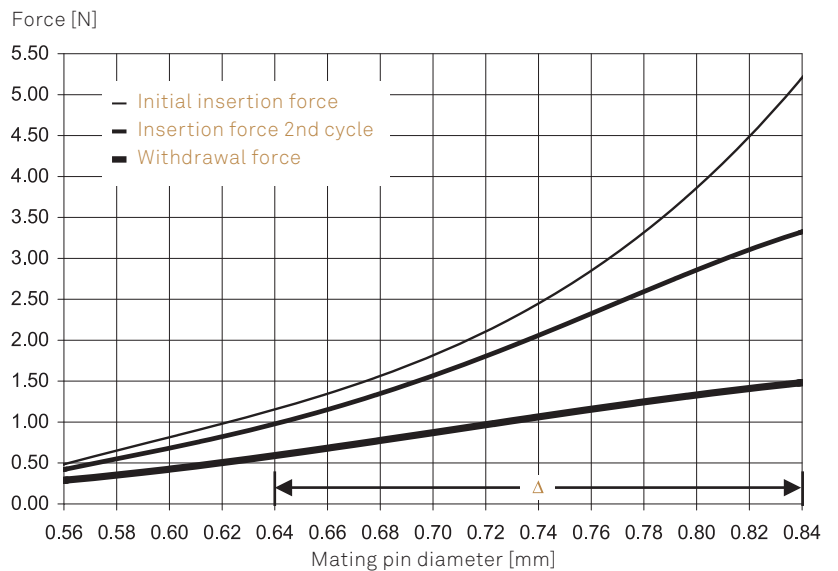
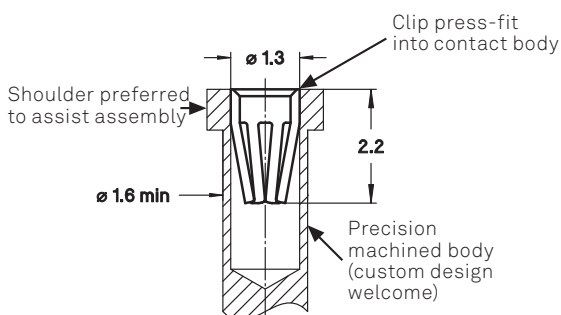



preci-dip

WWW.PRECIDIP.COM TEL +41 32 421 04 00 SALES@PRECIDIP.COM

# CONTACT DATA

STANDARD CLIP

## CLIP CODE 0610

4-FINGER

MATING PIN DIAMETER RANGE	0.56-0.84 mm
COMPLIANCY $\Delta$	0.28 mm
MIN. MATING PIN LENGTH	3.5 mm
CURRENT RATING	5 A

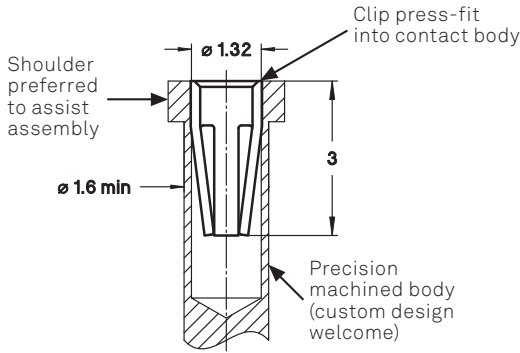

Force [N]

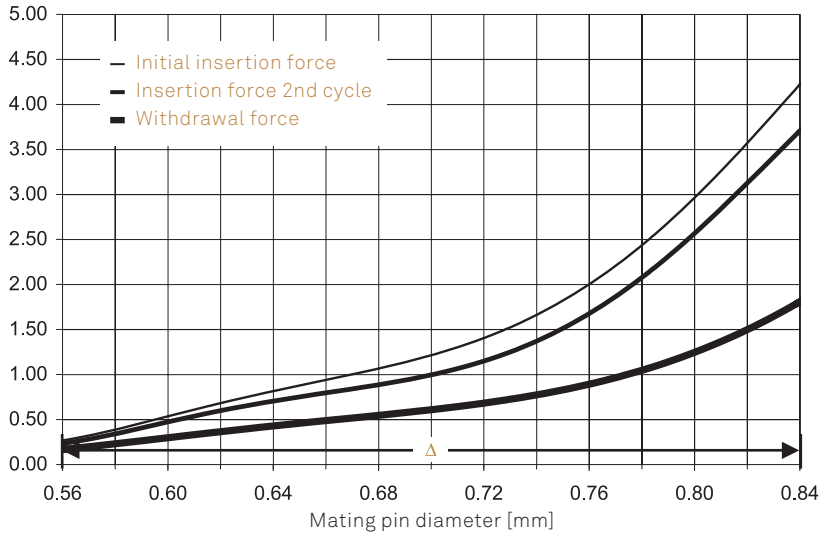

## CLIP CODE 4710

6-FINGER

MATING PIN DIAMETER RANGE	0.64-0.92 mm
COMPLIANCY $\Delta$	0.24 mm
MIN. MATING PIN LENGTH	2.6 mm
CURRENT RATING	5 A

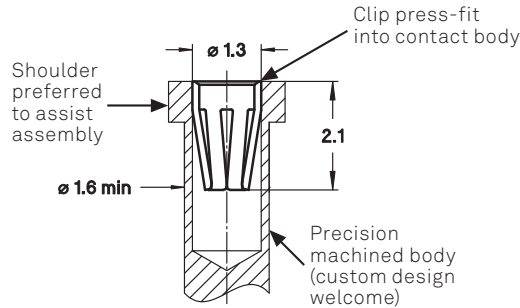

Force [N]

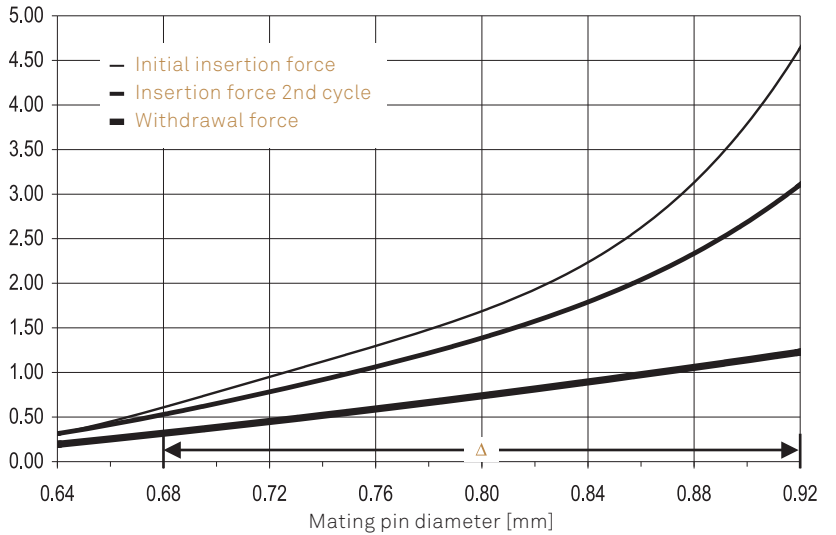

## CLIP CODE 1810

6-FINGER

MATING PIN DIAMETER RANGE	0.92-1.06 mm
COMPLIANCY $\Delta$	0.14 mm
MIN. MATING PIN LENGTH	2.2 mm
CURRENT RATING	8 A

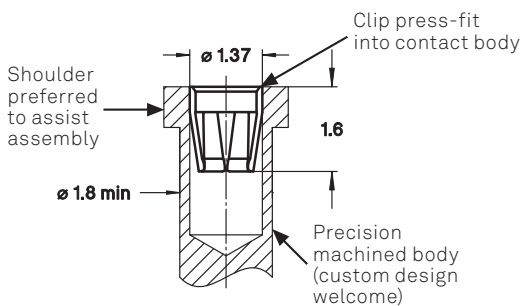

Force [N]

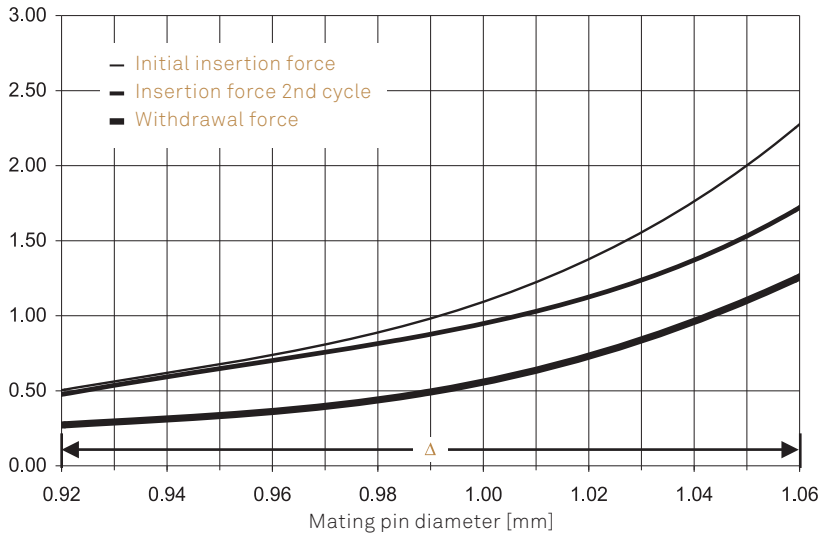



preci-dip

WWW.PRECIDIP.COM TEL +41 32 421 04 00 SALES@PRECIDIP.COM

# CONTACT DATA

STANDARD CLIP

## CLIP CODE 3410

4-FINGER

MATING PIN DIAMETER RANGE	0.7-1.06 mm
COMPLIANCY $\Delta$	0.34 mm
MIN. MATING PIN LENGTH	3.7 mm
CURRENT RATING	8 A

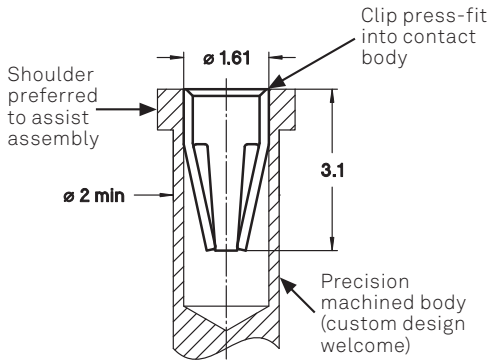

Force [N]

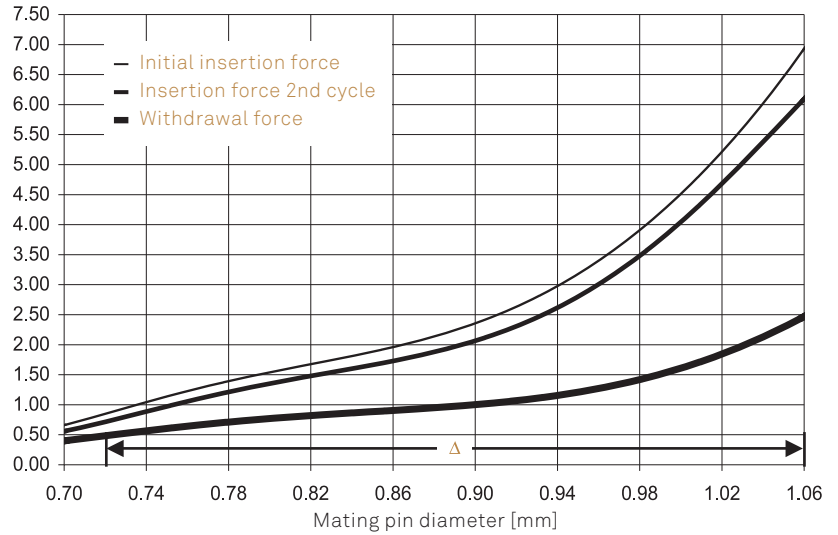

## CLIP CODE 0210

6-FINGER

MATING PIN DIAMETER RANGE	0.98-1.2 mm
COMPLIANCY $\Delta$	0.22 mm
MIN. MATING PIN LENGTH	3 mm
CURRENT RATING	8 A

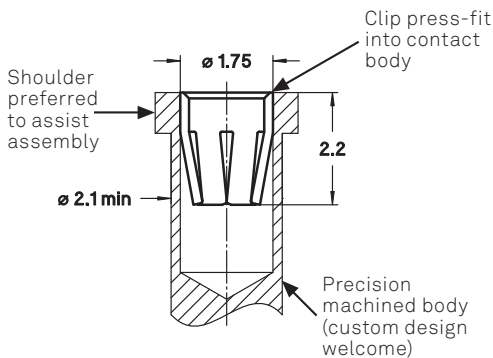

Force [N]

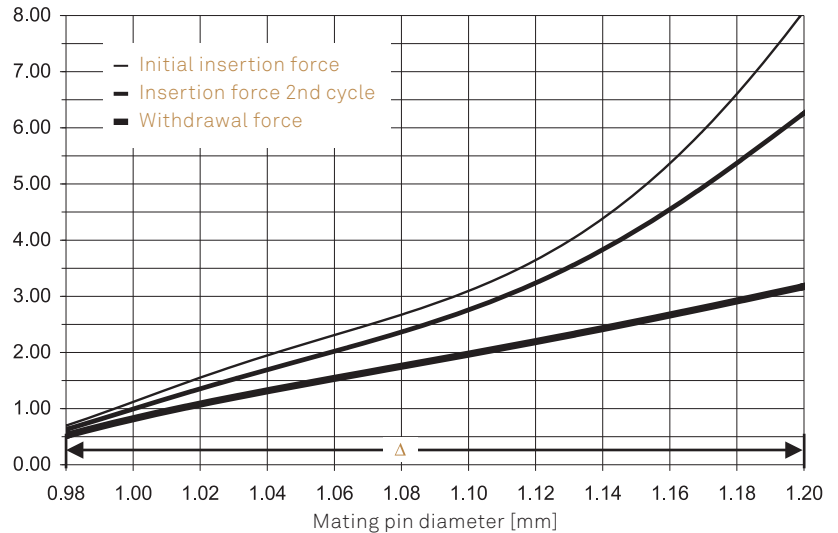

## CLIP CODE 2710

6-FINGER

MATING PIN DIAMETER RANGE	0.96-1.3 mm
COMPLIANCY $\Delta$	0.24 mm
MIN. MATING PIN LENGTH	3 mm
CURRENT RATING	8 A

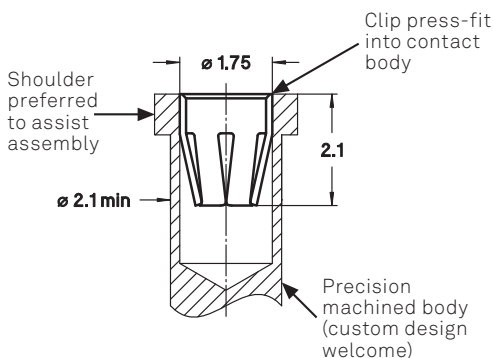

Force [N]

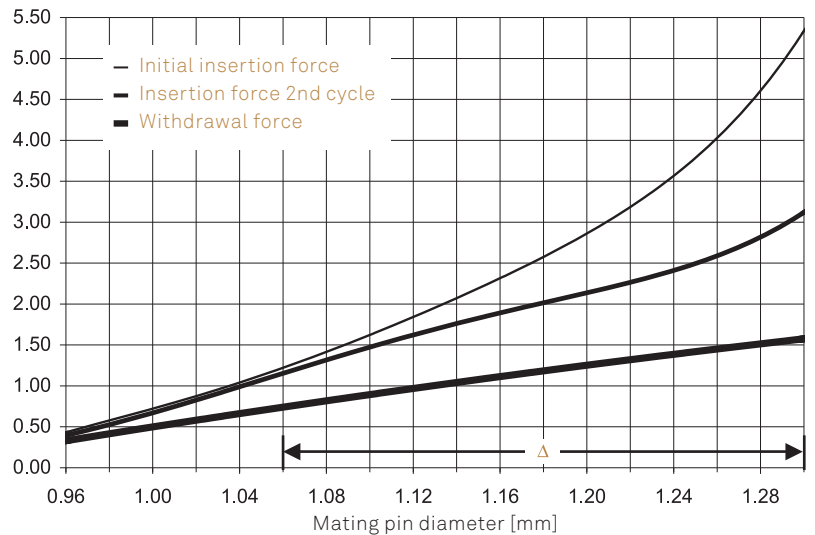

CONTACTS





preci-dip

WWW.PRECIDIP.COM TEL +41 32 421 04 00 SALES@PRECIDIP.COM

# CONTACT DATA

STANDARD CLIP

## CLIP CODE 4910

6-FINGER

MATING PIN DIAMETER RANGE	1.4-1.65 mm
COMPLIANCY $\Delta$	0.25 mm
MIN. MATING PIN LENGTH	3.4 mm
CURRENT RATING	11 A

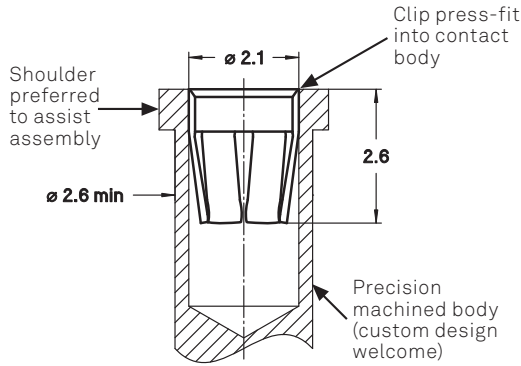

Force [N]

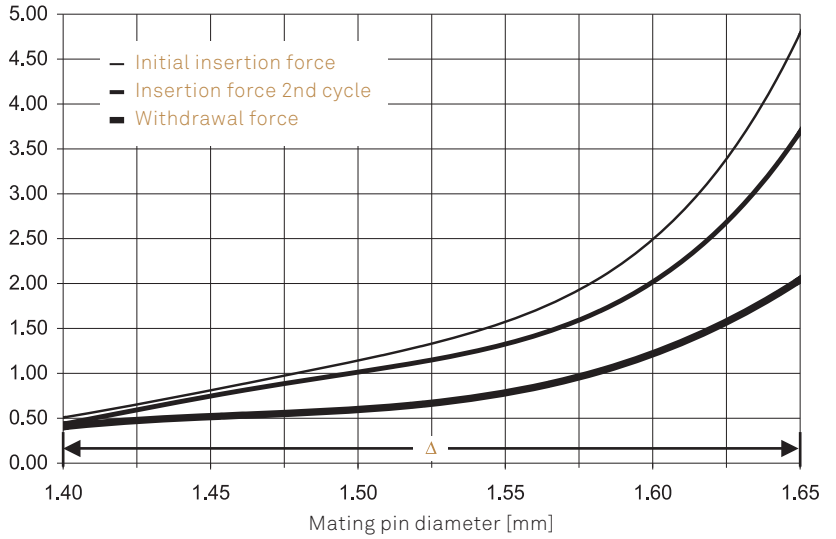

## CLIP CODE 1310

4-FINGER

MATING PIN DIAMETER RANGE	1.1-1.5 mm
COMPLIANCY $\Delta$	0.35 mm
MIN. MATING PIN LENGTH	4.2 mm
CURRENT RATING	11 A

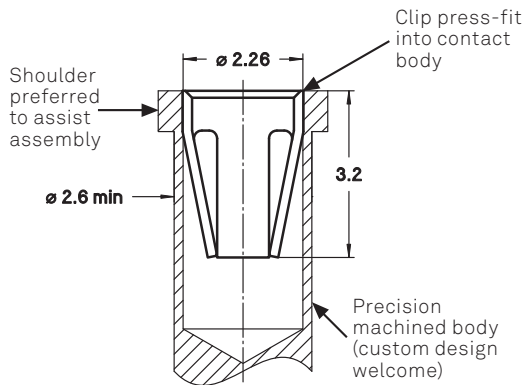

Force [N]

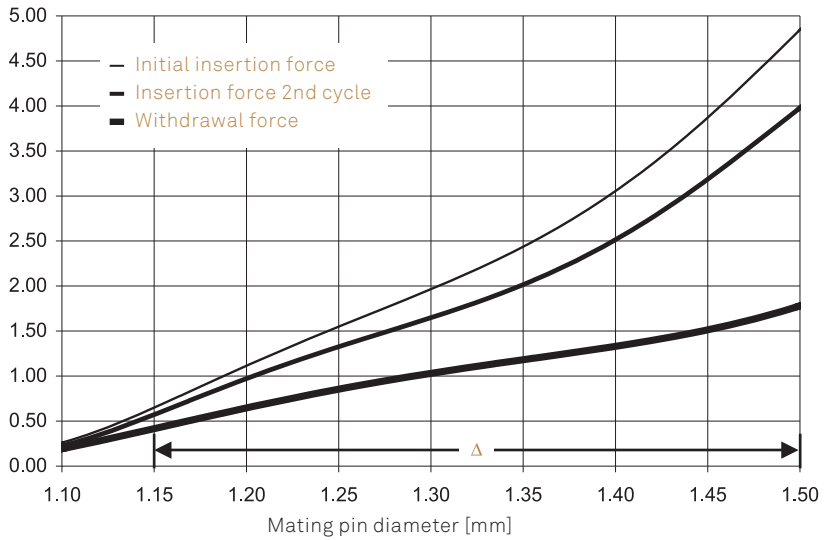

## CLIP CODE 2310

6-FINGER

MATING PIN DIAMETER RANGE	1.15-1.55 mm
COMPLIANCY $\Delta$	0.3 mm
MIN. MATING PIN LENGTH	3.5 mm
CURRENT RATING	11 A

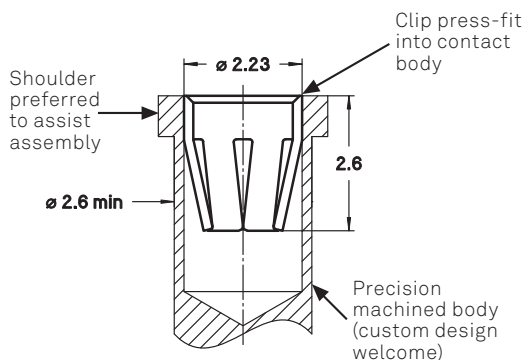

Force [N]

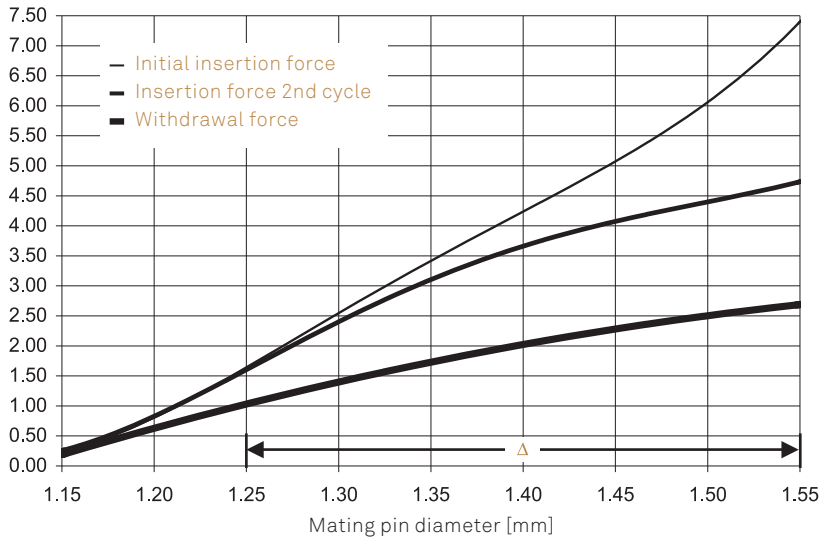



preci-dip

WWW.PRECIDIP.COM TEL +41 32 421 04 00 SALES@PRECIDIP.COM

# CONTACT DATA

STANDARD CLIP

## CLIP CODE 3920

6-FINGER

MATING PIN DIAMETER RANGE	1.4-1.7 mm
COMPLIANCY $\Delta$	0.25 mm
MIN. MATING PIN LENGTH	3.5 mm
CURRENT RATING	11 A

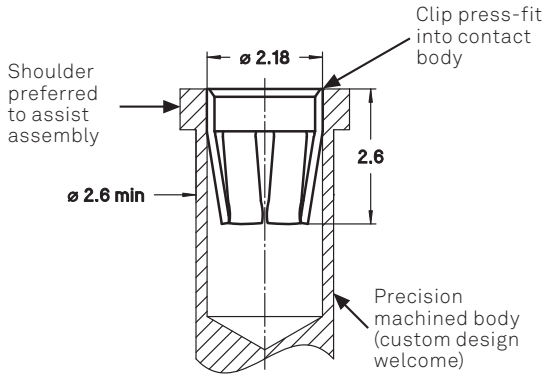

Force [N]

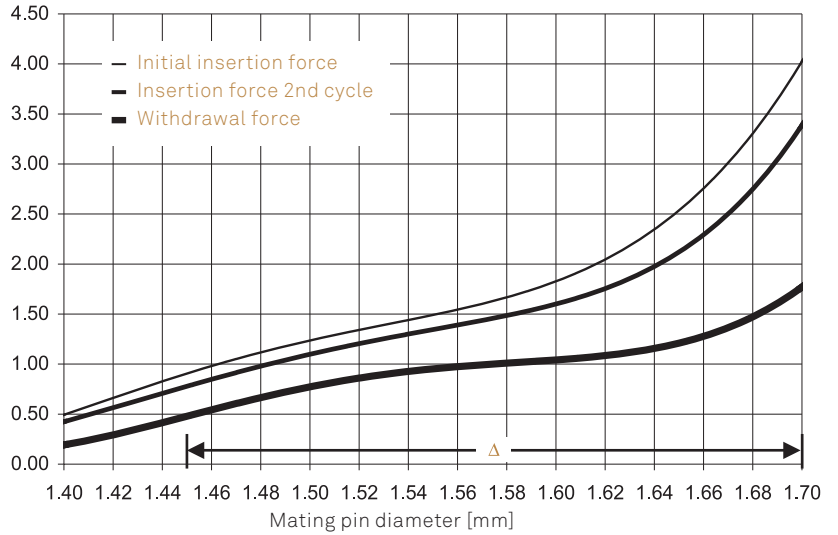

## CLIP CODE 0710

4-FINGER

MATING PIN DIAMETER RANGE	1.5-2 mm
COMPLIANCY $\Delta$	0.45 mm
MIN. MATING PIN LENGTH	5 mm
CURRENT RATING	15 A

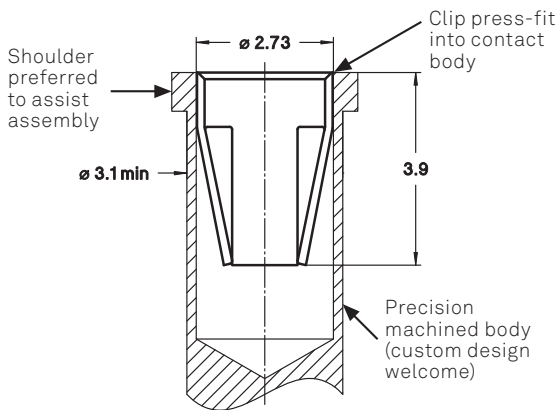

Force [N]

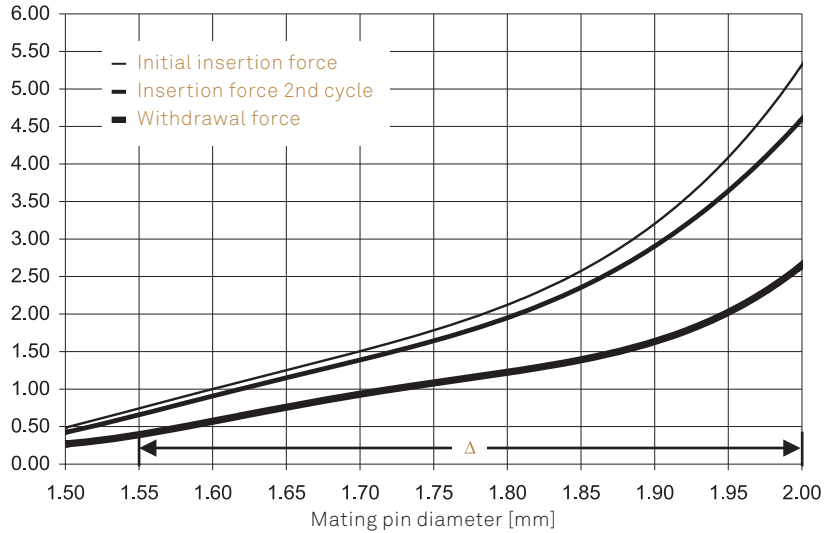

## CLIP CODE 4010

8-FINGER

MATING PIN DIAMETER RANGE	2-2.45 mm
COMPLIANCY $\Delta$	0.4 mm
MIN. MATING PIN LENGTH	4.7 mm
CURRENT RATING	18 A

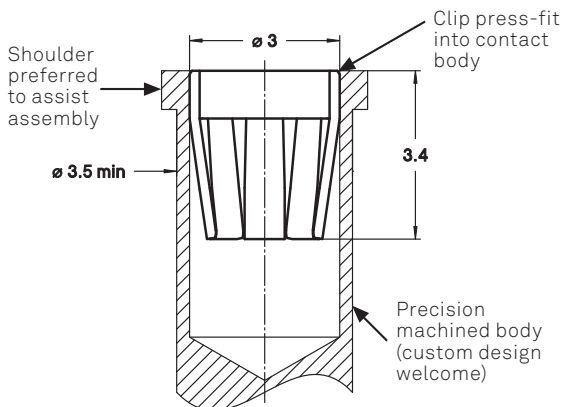

Force [N]

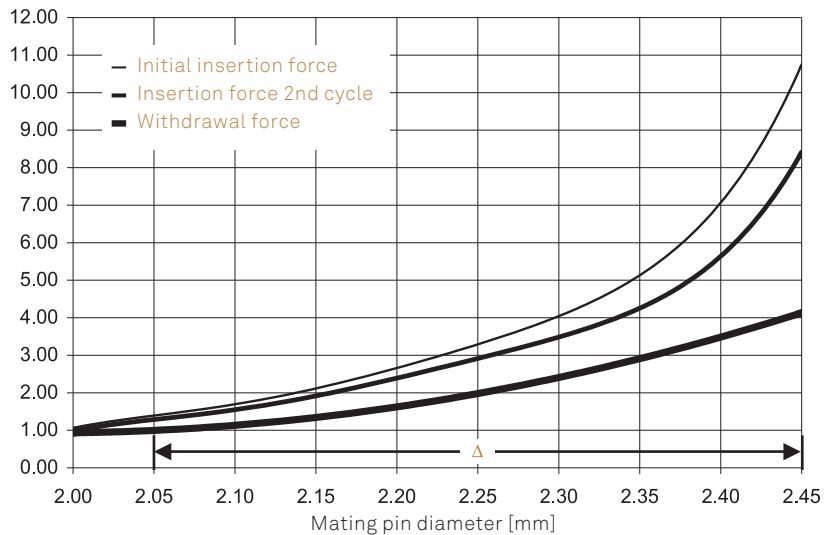

CONTACTS

# CUSTOM DESIGN

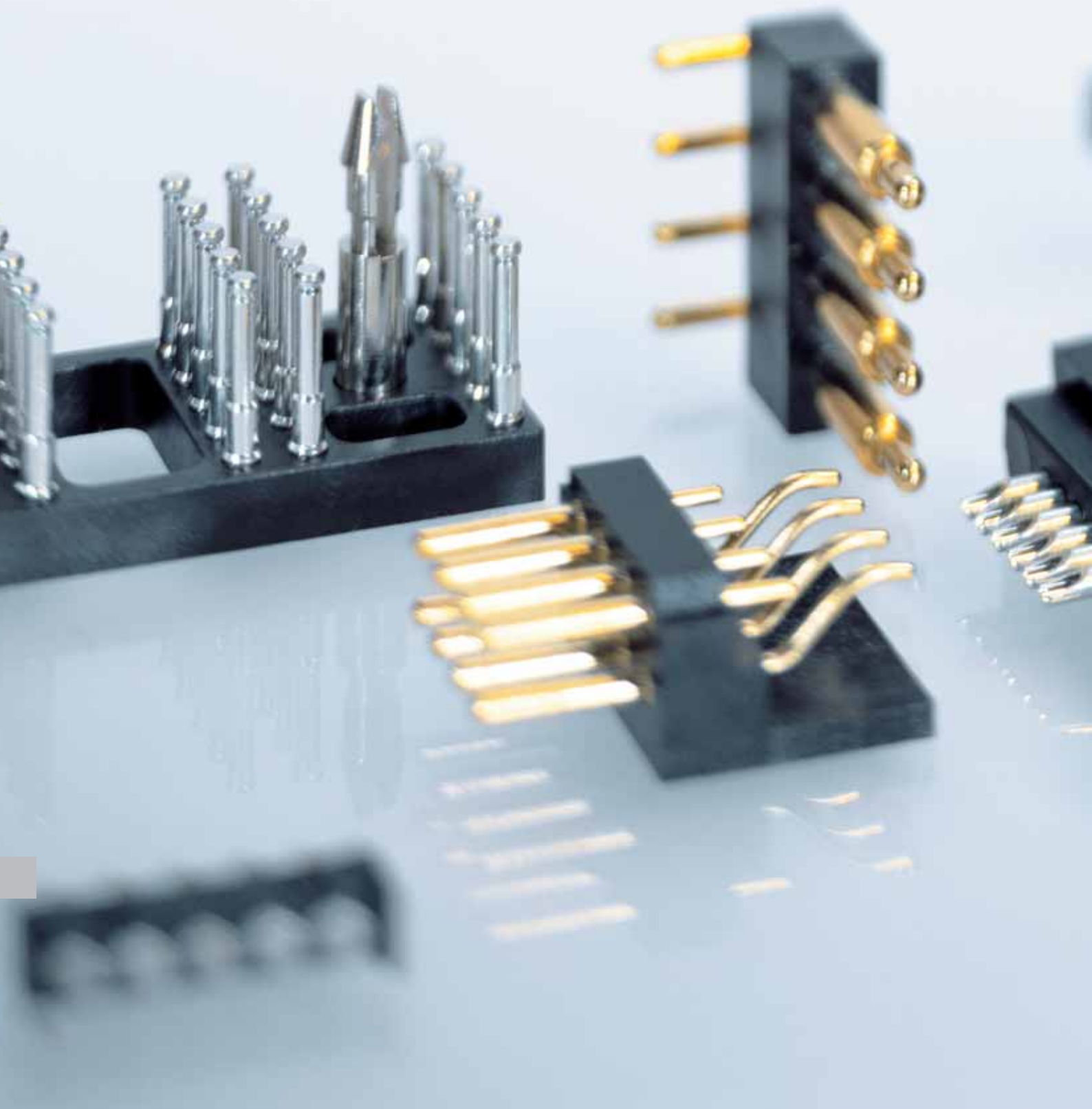

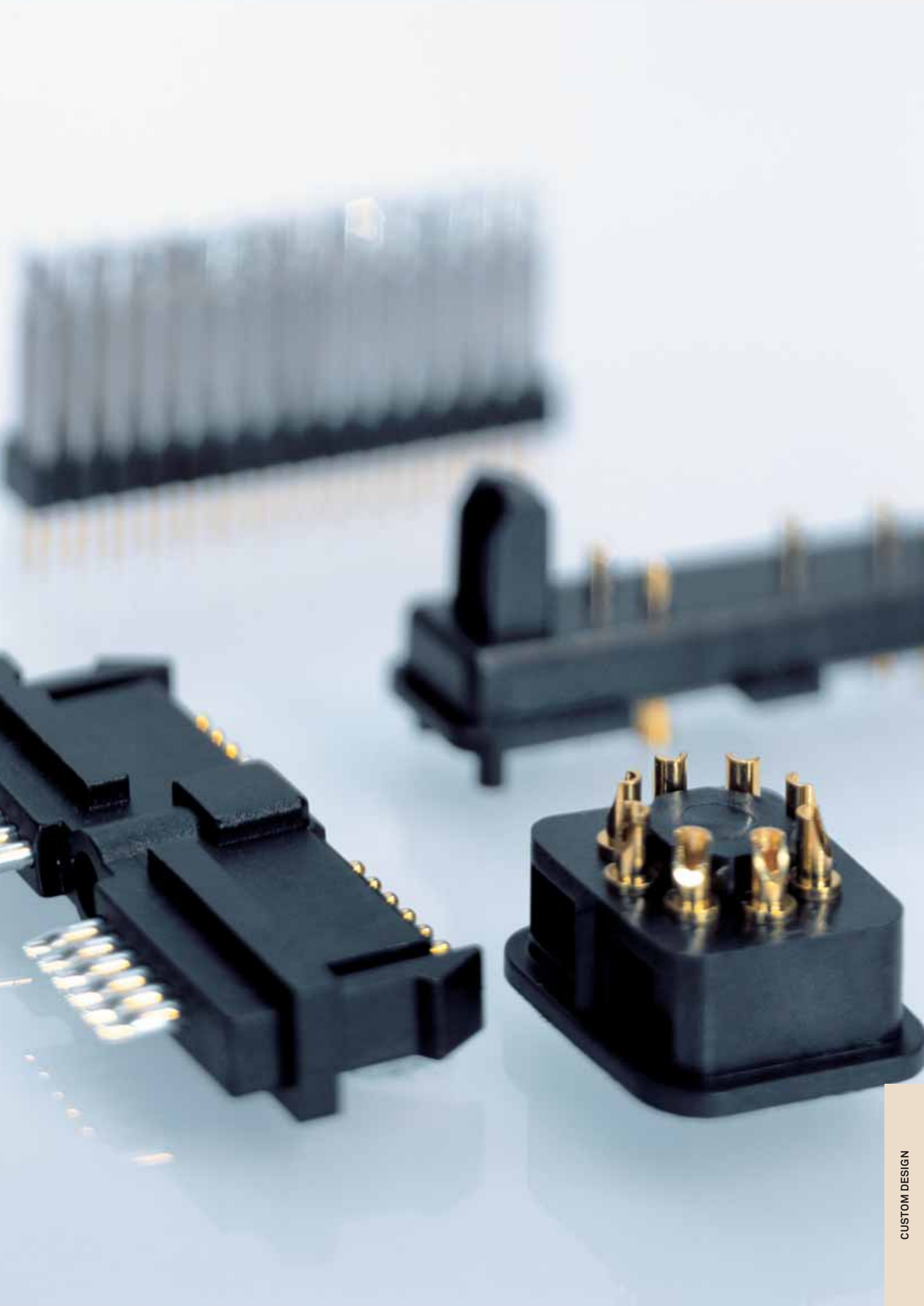



precidip

WWW.PRECIDIP.COM TEL +41 32 421 04 00 SALES@PRECIDIP.COM

# APPLICATION FIELD

TELECOMMUNICATION



## EXAMPLES

1. Dead connector system interface, professional mobile radio
2. SMD connector for automatic assembly for mobile phone loudspeaker
3. Flex-print connector with orientation pins and protective cover, GSM base station
4. Double action connector, cover position detector on mobile phone
5. Connector with integrated guiding system for docking station for professional mobile radio
6. System interface connector with locking device for professional mobile radio
7. SMD spring-loaded board-to-board connector for blind assembly on professional mobile radio
8. SIM card connector in mobile phones and professional mobile radios
9. Connector with holding bracket for remote microphone and control unit for mobile radio
10. Connector for sealed assembly for mobile phone battery
11. Miniature spring-loaded connector, very low profile with less than 2.5 mm working height

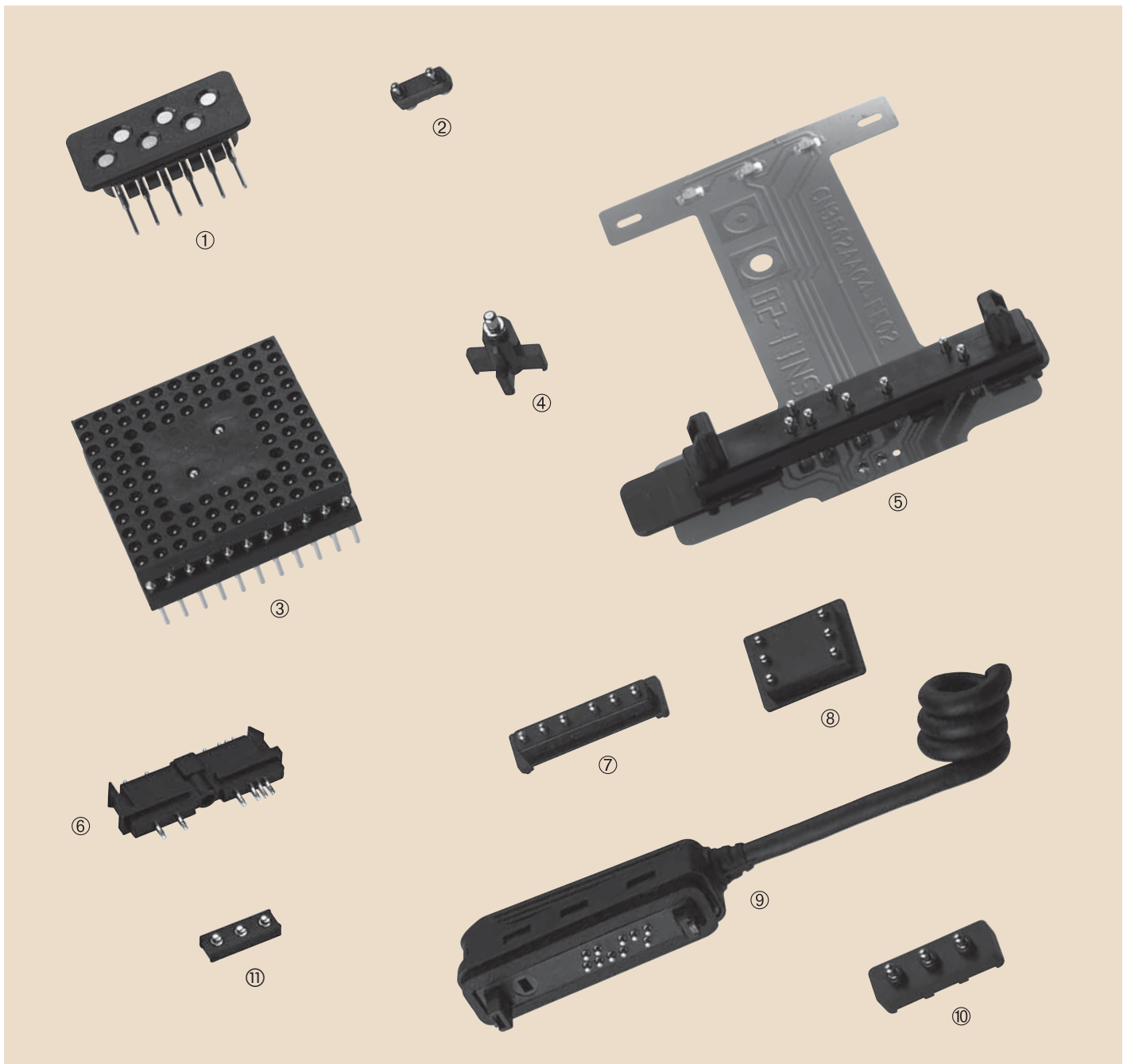





precidip

WWW.PRECIDIP.COM TEL +41 32 421 04 00 SALES@PRECIDIP.COM

# APPLICATION FIELDS

DATA PROCESSING AND ACQUISITION



## EXAMPLES

1. Spring-loaded and pad connectors for portable voice directed data acquisition terminal
2. Miniature high density connector for single board industrial processor
3. LED display socket control panel
4. 545 way interstitial PGA socket with compliant press-fit terminations, multi-processor, parallel computing, mainframe computer
5. PCB interconnect component for electronic banking terminal
6. Power connector hard-disk drive
7. SMD connector for docking station for tablett-PC, PDA and bar code readers
8. Connector for security control loop on automatic cash dispenser, banking and vending machines

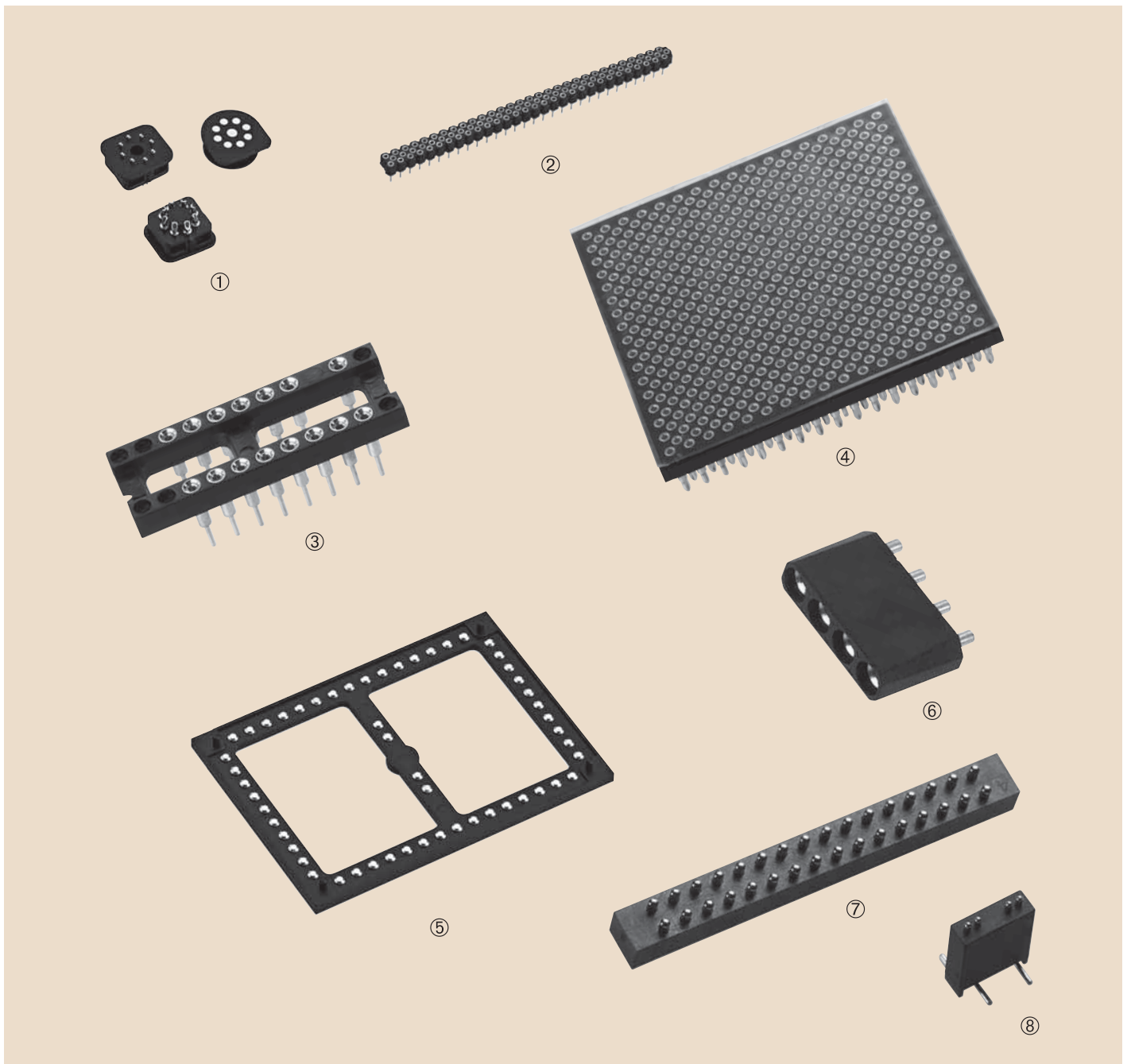



precidip

WWW.PRECIDIP.COM TEL +41 32 421 04 00 SALES@PRECIDIP.COM

# APPLICATION FIELD

TRANSPORTATION



## EXAMPLES

1. Connector for car dash-board instrument
2. Car dash-board connector for blind mating
3. LED lamp socket for back-lighting, car radio
4. Spring-loaded connector for vehicles for secured cash transport
5. SMD connector for internal dash board connection
6. SMD spring-loaded and pad connector for dash board add-on for telecommunication equipment
7. Spring-loaded connector for food conveyor trolley
8. Card connectors air conditioning control equipment, railway
9. Connector for press-fit assembly and connection to removable operation panel for car radio

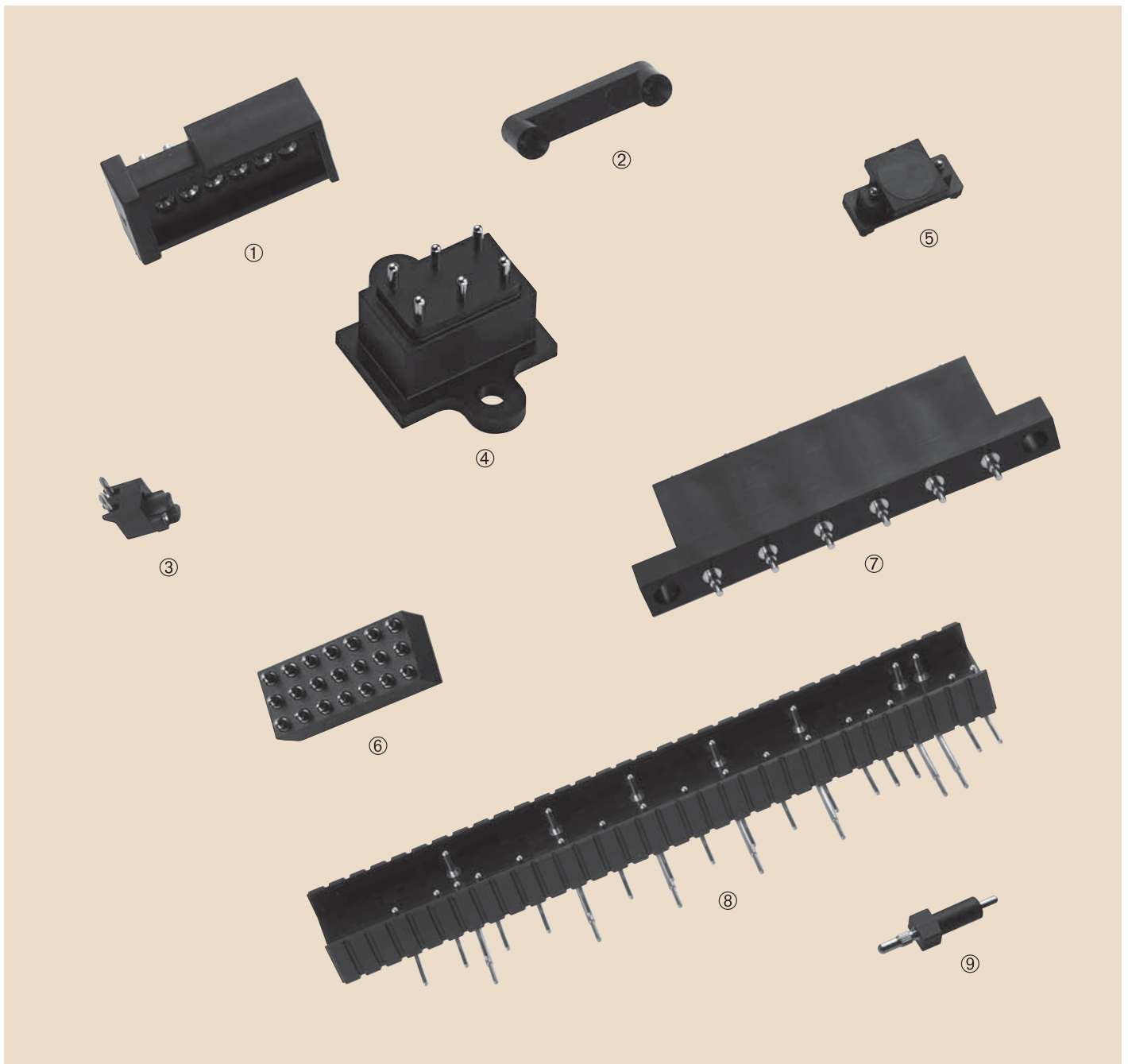



precidip

WWW.PRECIDIP.COM TEL +41 32 421 04 00 SALES@PRECIDIP.COM

# APPLICATION FIELDS

AIRCRAFT, AEROSPACE AND MILITARY



## EXAMPLES

1. Miniature board to board connectors avionics equipment
2. Interface socket PCB to ARINC connector
3. Board-to-board connection in tactical manpack radio
4. Radar equipment of military helicopter
5. Miniature board to board connectors avionics equipment
6. Interface socket PCB to ARINC connector
7. Interface socket PCB to MIL connector
8. Miniature pad connector used in test systems for satellite navigation system
9. High-stiffness 2 mm-pitch connector for avionics equipment
10. Sealed connector with very high contact pressure for avionics equipment, electronic defence systems
11. Floating spring-loaded contact with insulator body for electronic defense systems

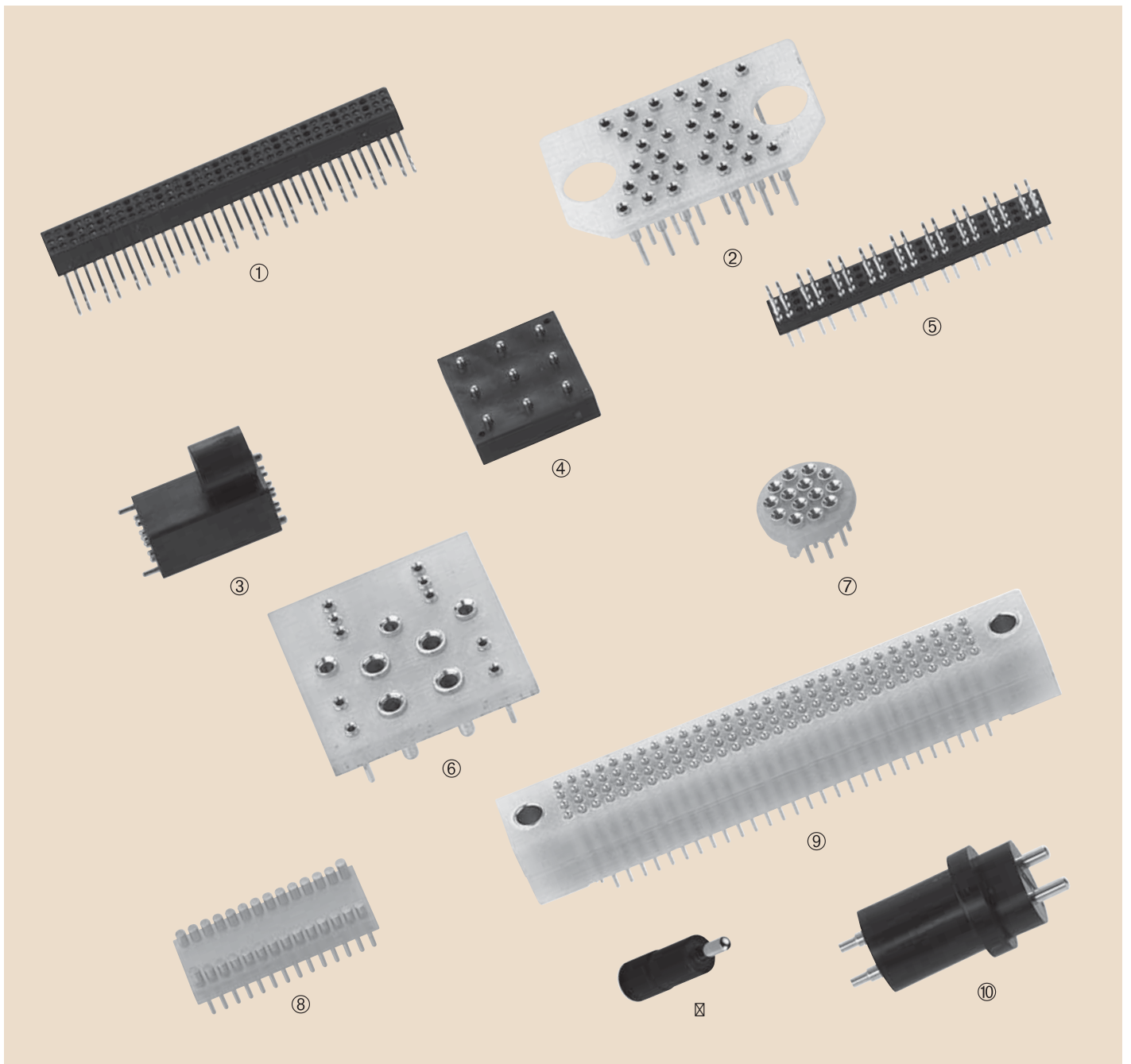



precidip

WWW.PRECIDIP.COM TEL +41 32 421 04 00 SALES@PRECIDIP.COM

# APPLICATION FIELDS

AUTOMATION AND INDUSTRIAL EQUIPMENT



## EXAMPLES

1. Test jack for calibration of industrial transmitter
2. SMD connector for industrial sensor
3. Socket for gas pressure sensor
4. Spring-loaded connector for programming module for industrial sensor
5. Pin connectors for industrial position sensor
6. Polarized PCB socket connector, controller for building automation system
7. Spring-loaded and dead connector for gate control on automatic conveyor system
8. Press-fit socket for coding module in industrial control unit
9. Socket for photomultiplier tube for industrial measurement system

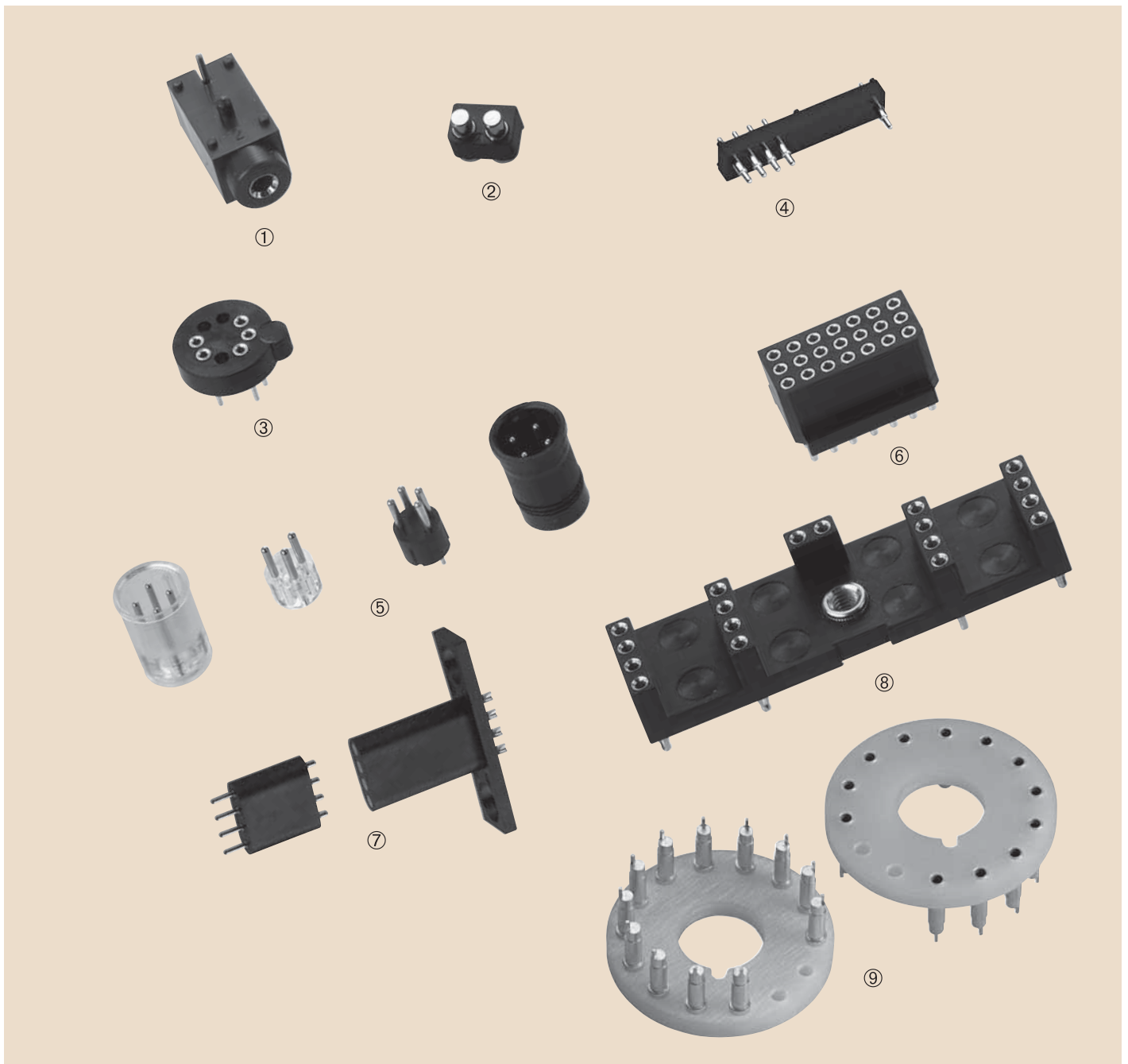



precidip

WWW.PRECIDIP.COM TEL +41 32 421 04 00 SALES@PRECIDIP.COM

# APPLICATION FIELDS

TESTING AND MEASURING



## EXAMPLES

1. Data interface connector for weighing and counting systems
2. Test probe connector
3. Sensor connector for liquid analysis
4. Connector with mixed SMD and through-hole terminations for bare-board test systems
5. Connector for test systems for hard-disk drives
6. Shielded contacts connector pair for industrial flow rate measuring systems
7. Base plate / connector system between sensor system and transmitter
8. Spring-loaded connector with recessed pistons for functional test systems for disk drives
9. Spring-loaded and pad connector for IR thermography camera

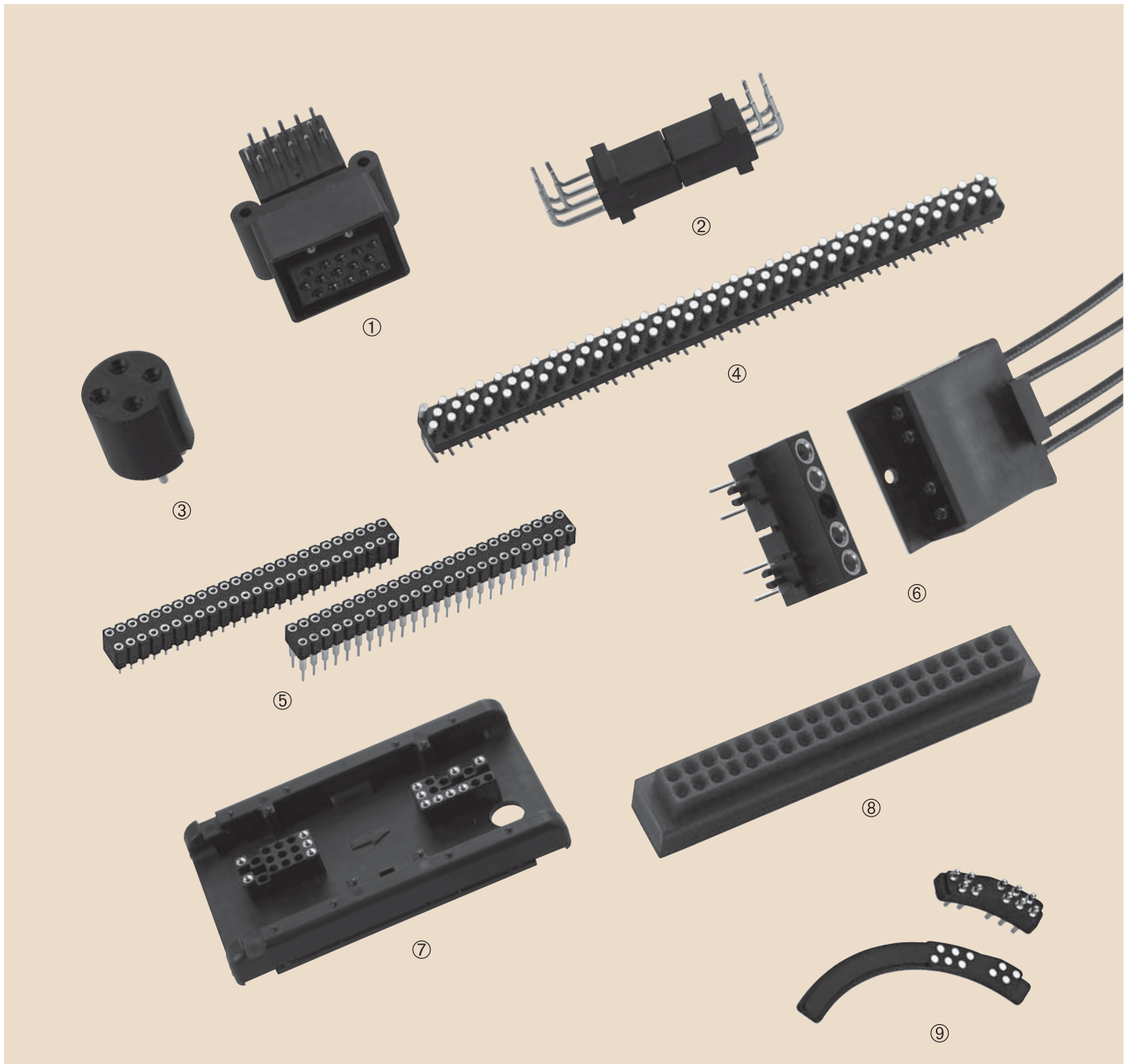





precidip

WWW.PRECIDIP.COM TEL +41 32 421 04 00 SALES@PRECIDIP.COM

# APPLICATION FIELD

MEDICAL



## EXAMPLES

1. Spring-loaded + pad connector for breathing assistance equipment
2. Battery connector for portable blood pressure measuring equipment
3. Spring-loaded connector for removable display module
4. Electrode connector for muscular electro-stimulation systems
5. Spring-loaded and pad connector data exchange from portable patient monitoring unit into computer system
6. Socket for gas sensor
7. Socket for CCD image sensor for digital radiography
8. Overmoulded miniature connectors with high degree of protection IP 67 for patient monitoring systems
9. Floating-pin spring-loaded connector with integrated snap-in bracket for motherboard to mezzanine board connection

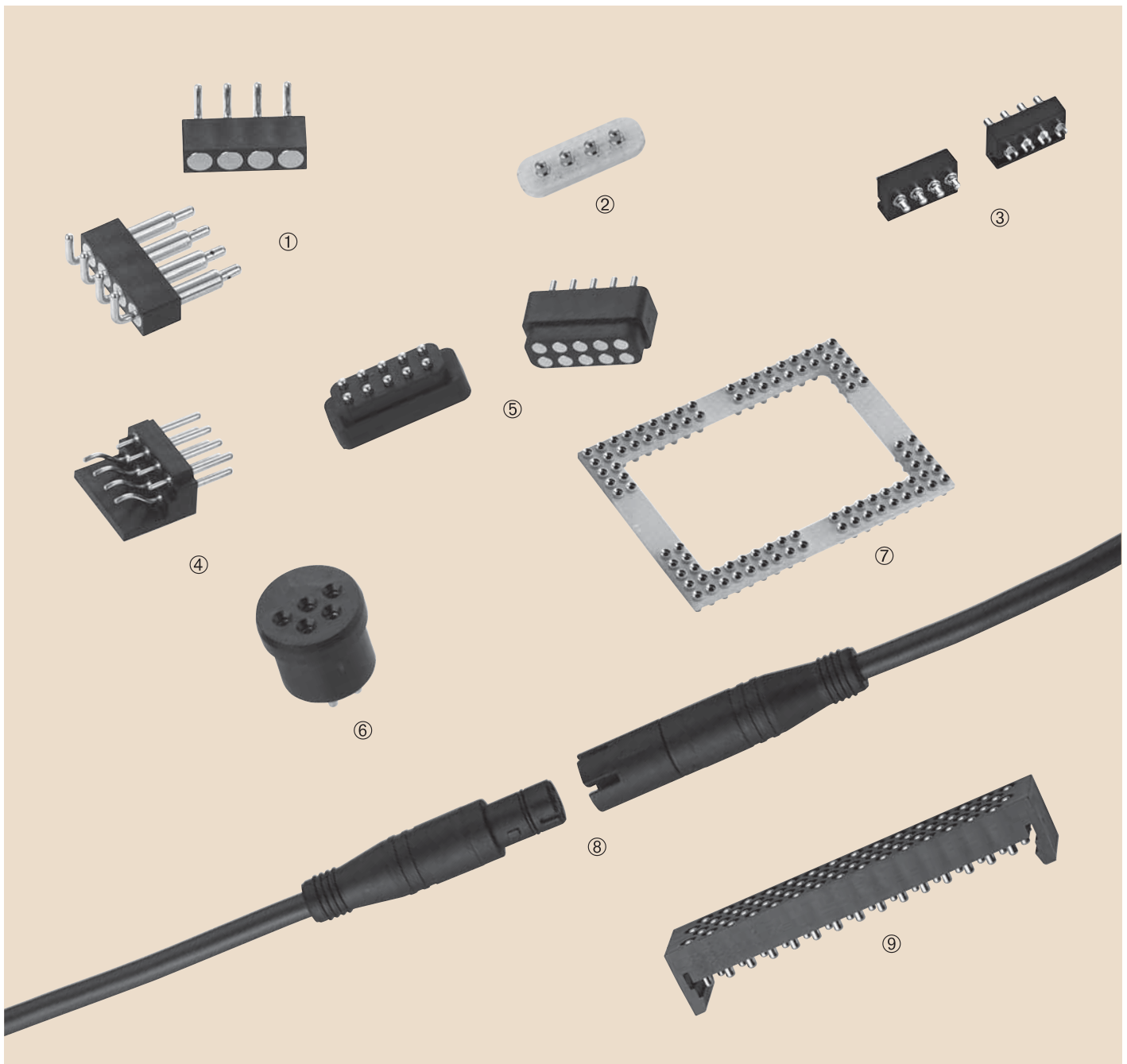



precidip

WWW.PRECIDIP.COM TEL +41 32 421 04 00 SALES@PRECIDIP.COM

# APPLICATION FIELDS

PROFESSIONAL AND CONSUMER ELECTRONIC



## EXAMPLES

1. Miniature connector for ink-jet printing unit
2. Clamp-on connector to load data from wristwatch type diving computer into PC
3. Double-action connector for modular system of professional camera
4. Connection in bayonet mating for camera with interchangeable lenses
5. PCB connector for add-on modules
6. LED display sockets for household washing machine
7. Cable-to-cable connector for audio professional headset
8. Battery connector for portable media player
9. Board-to-board connection for model train
10. Spring-loaded connector for boiler control panel

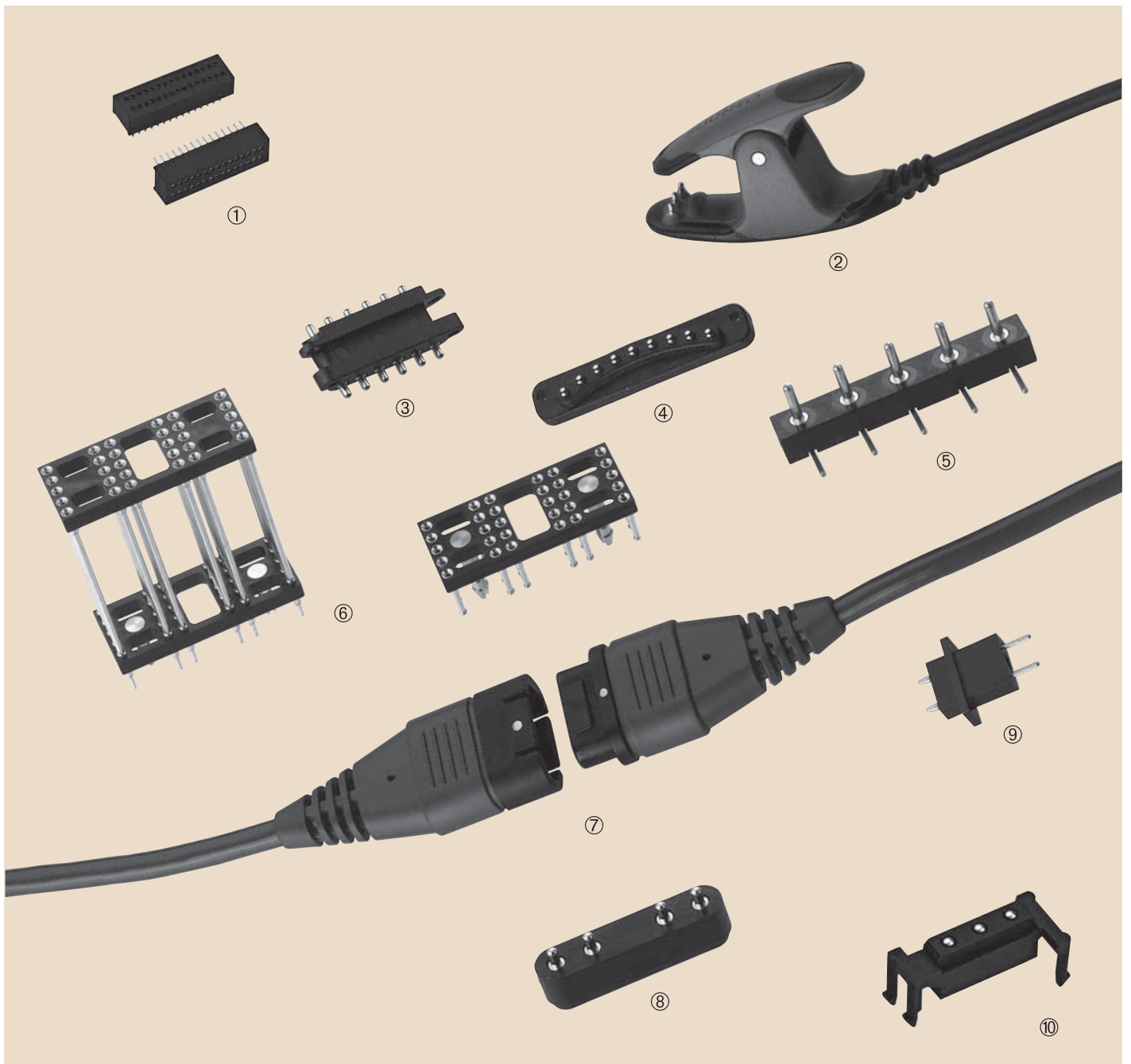



preci-dip

WWW.PRECIDIP.COM TEL +41 32 421 04 00 SALES@PRECIDIP.COM

# SALES OFFICES AND DISTRIBUTORS

## PRECI-DIP SALES OFFICES

**HEADQUARTER - PRECI-DIP SA**  
Rue Saint-Henri 11, P.O. Box 834  
CH-2800 Delémont / Switzerland  
Phone +41 32 421 04 00  
sales@precidip.com

**SHANGHAI REPRESENTATIVE OFFICE**  
24T, No 379, Jin Sui Mansion,  
Pudong Nan Road,  
200120 Shanghai / China  
Phone +86 (186) 1630 0833  
sales@precidip.com

### E-DISTRIBUTORS

Digi-Key  
www.digikey.com  
RS Components  
www.rs-components.com

## DISTRIBUTORS

### EUROPE

#### AUSTRIA

Arrow Electronics  
www.arrowce.com  
Avnet Abacus  
www.avnet-abacus.eu  
Ineltro Electronics  
www.ineltro.at  
Rutronik  
www.rutronik.com

#### BELGIUM

Alcom Electronics  
www.alcom.be  
Arrow Electronics  
www.arrowce.com  
Avnet Abacus  
www.avnet-abacus.eu  
Rutronik  
www.rutronik.com

#### BULGARIA

Arrow Electronics  
www.arrowce.com  
Rutronik  
www.rutronik.com

#### BELARUS

Arrow Electronics  
www.arrowce.com  
Avnet Abacus  
www.avnet-abacus.eu

#### CROATIA

Avnet Abacus  
www.avnet-abacus.eu

#### CZECH REPUBLIC

Arrow Electronics  
www.arrowce.com  
Avnet Abacus  
www.avnet-abacus.eu  
Official Electronic  
www.official.cz  
Rutronik  
www.rutronik.com

#### DENMARK

Arrow Electronics  
www.arrowne.com  
Avnet Abacus  
www.avnet-abacus.eu  
Fr-Tech  
www.fr-tech.dk  
Rutronik  
www.rutronik.com

#### ESTONIA

Arrow Electronics  
www.arrowne.com  
Avnet Abacus  
www.avnet-abacus.eu  
Perel  
www.perel.ee  
Rutronik  
www.rutronik.com

#### FINLAND

Arrow Electronics  
www.arrowne.com  
Avnet Abacus  
www.avnet-abacus.eu  
Perel  
www.perel.fi  
Rutronik  
www.rutronik.com

#### FRANCE

Arrow Electronique  
www.arrowelectronique.com  
Avnet Abacus  
www.avnet-abacus.eu  
Direct  
www.direct.fr  
Mateleco  
www.mateleco.fr  
Rutronik  
www.rutronik.com  
Yelloz  
www.yellozgroup.com

#### GERMANY

Arrow Electronics  
www.arrowne.com  
Avnet Abacus  
www.avnet-abacus.eu  
CAB  
www.cabgbmh.com  
Ekontor  
www.ekontor.de  
Rutronik  
www.rutronik.com

#### GREECE

Arrow Electronics  
www.arroweurope.com  
Avnet Abacus  
www.avnet-abacus.eu

#### HUNGARY

Arrow Electronics  
www.arrowce.com  
Avnet Abacus  
www.avnet-abacus.eu  
Lomex  
www.lomex.hu  
Rutronik  
www.rutronik.com

#### IRELAND

Arrow Electronics  
www.arrowne.com

#### ISRAEL

Am Components  
www.amcomp.co.il  
Arrow Israel  
www.arrow-israel.co.il

#### ITALY

Arrow Electronics  
www.arrowitaly.it  
Avnet Abacus  
www.avnet-abacus.eu  
Comprel  
www.comprel.it  
Rutronik  
www.rutronik.com

#### LATVIA

Arrow  
www.arrowne.com

#### LITHUANIA

Arrow Electronics  
www.arrowne.com  
Avnet Abacus  
www.avnet-abacus.eu  
Rutronik  
www.rutronik.com

#### NETHERLANDS

Alcom Electronics  
www.alcom.nl  
Arrow Electronics  
www.arrowce.com  
Avnet Abacus  
www.avnet-abacus.eu  
Rutronik  
www.rutronik.com

#### NORWAY

Acte  
www.acte.no  
Arrow Electronics  
www.arrowne.com  
Avnet Abacus  
www.avnet-abacus.eu  
Rutronik  
www.rutronik.com

#### POLAND

Arrow Electronics  
www.arrowce.com  
Avnet Abacus  
www.avnet-abacus.eu  
Rutronik  
www.rutronik.com  
Semicon  
www.semicon.com.pl

#### PORTUGAL

Arrow Electronics  
www.arrow.com  
Avnet Abacus  
www.avnet-abacus.eu  
Rutronik  
www.rutronik.com

#### ROMANIA

Arrow Electronics  
www.arrow.com  
Rutronik  
www.rutronik.com

#### RUSSIA

Arrow Electronics  
www.arrow.com  
Avnet Abacus  
www.avnet-abacus.eu  
Perel  
www.perel-russia.ru  
Rutronik  
www.rutronik.com

#### SERBIA

Avnet Abacus  
www.avnet-abacus.eu  
Rutronik  
www.rutronik.com

#### SLOVAKIA

Arrow Electronics  
www.arrow.com  
Avnet Abacus  
www.avnet-abacus.eu  
Rutronik  
www.rutronik.com  
Official Electronic  
www.official.cz

#### SPAIN

Arrow Electronics  
www.arrow.com  
Avnet Abacus  
www.avnet-abacus.eu  
Electronica21  
www.electronica21.com  
Rutronik  
www.rutronik.com

#### SWEDEN

Arrow Electronics  
www.arrow.com  
Avnet Abacus  
www.avnet-abacus.eu  
Rutronik  
www.rutronik.com

#### SWITZERLAND

Arrow Electronics  
www.arrow.com  
Avnet Abacus  
www.avnet-abacus.eu  
Precimation  
www.precimation.ch  
Rutronik  
www.rutronik.com

#### TURKEY

Arrow Electronics  
www.arrow.com  
Avnet Abacus  
www.avnet-abacus.eu

#### UNITED KINGDOM

Arrow Electronics  
www.arrow.com  
Avnet Abacus  
www.avnet-abacus.eu  
Flint  
www.flint.co.uk  
Inelco Hunter  
www.inelcohunter.co.uk  
Rutronik  
www.rutronik.com

#### UKRAINE

Arrow Electronics  
www.arrow.com  
Avnet Abacus  
www.avnet-abacus.eu

## USA AND CANADA

#### USA

Abstract Electronics  
www.abstractelec.com  
Area51  
www.area51esg.com  
Component Sources International  
www.compsources.com  
Dependable Component Supply  
www.dependonus.com  
Diverse Electronics  
www.diverseelectronics.com  
Eby Electro  
www.ebyelectro.com  
LCL Electronics Corporation  
www.lclelectronics.com  
Spacecraft  
www.spacecraft.com  
TTI Inc.  
www.ttiinc.com  
NRC Electronics  
www.nrcelectronics.com  
CAM RPC Electronics  
www.camrpc.com  
Pui Projections Unlimited Inc.  
www.gopui.com  
Hughes-Peters  
www.hughespeters.com

#### MIL DISTRIBUTORS

BTc Electronics  
www.btcelectronics.com  
CPN Denelex Group  
www.cpdenelex.com  
March Electronics  
www.marchelectronics.com  
Spacecraft  
www.spacecraft.com

## ASIA

#### CHINA

Arrow Asia  
www.arrowasia.com  
Le Champ  
www.le-champ.com  
Shenzhen Mingxiang Electronic  
www.sz-mingxiang.com  
Kansai Electronics  
www.kansai-sz.com  
Avnet Abacus  
www.avnet.com  
Hongda Success  
www.hdchtech.com  
Hongkong Memec  
www.memec-hlc.com

Quanma Electronics  
www.quanma-china.com  
Rutronik  
www.rutronik.com  
Sinolink International  
www.sinolink-china.com  
Westwick  
www.westwick.com  
Ribbon Electronics  
www.bj-ribbon.com.cn

#### INDIA

FCI-OEN Connectors  
www.fciconnect.com  
Le Champ  
www.le-champ.com

#### INDONESIA

Addcom Solution  
www.addcom.com.sg  
Le Champ  
www.le-champ.com

#### JAPAN

Global Electronics Corp.  
www.gec-tokyo.co.jp  
K. Tokiwa  
www.k-tokiwa.co.jp  
Katotek  
www.katohstek.co.jp  
Kaga Electronics  
www.taxan.co.jp

#### KOREA

Britestone  
www.britestone.com

#### MALAYSIA

Addcom Solution  
www.addcom.com.sg  
Le Champ  
www.le-champ.com

#### SINGAPORE

Addcom  
www.addcom.com.sg  
Le Champ  
www.le-champ.com

#### TAIWAN

Helm Technology  
www.helm.com.tw

#### THAILAND

Addcom  
www.addcom.com.sg  
Le Champ  
www.le-champ.com

#### VIETNAM

Le Champ  
www.le-champ.com

## OCEANIA

#### AUSTRALIA

Arrow Electronics  
www.arrowasia.com

#### NEW ZEALAND

Arrow Electronics  
www.arrowasia.com

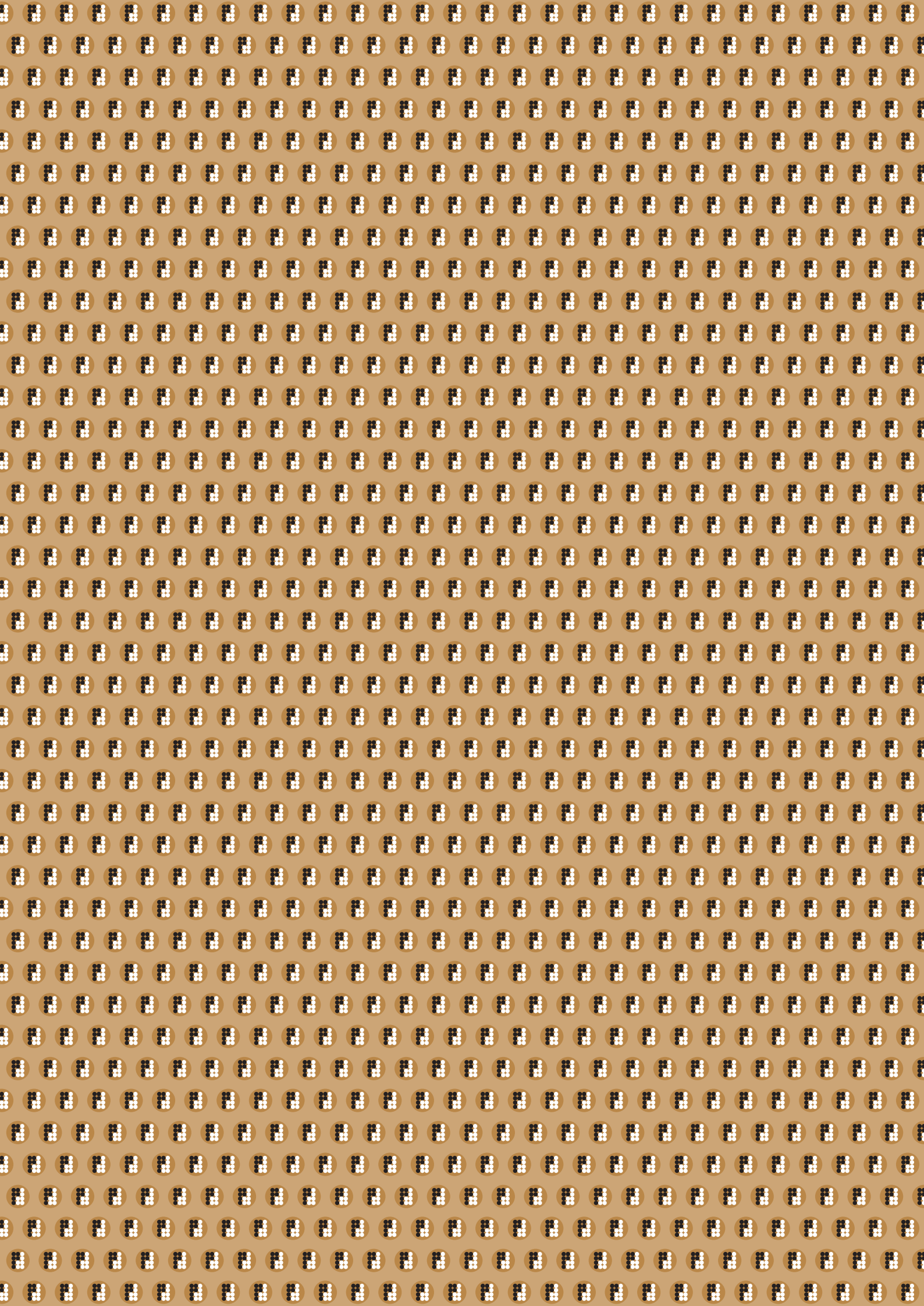

**[www.precidip.com](http://www.precidip.com)**

PRECI-DIP SA Rue Saint-Henri 11 P.O.Box 834 CH-2800 Delémont / Switzerland  
PHONE +41 (0)32 421 04 00 FAX +41 (0)32 421 04 01 E-MAIL [sales@precidip.com](mailto:sales@precidip.com) [www.precidip.com](http://www.precidip.com)



Компания «Океан Электроники» предлагает заключение долгосрочных отношений при поставках импортных электронных компонентов на взаимовыгодных условиях!

Наши преимущества:

- Поставка оригинальных импортных электронных компонентов напрямую с производств Америки, Европы и Азии, а так же с крупнейших складов мира;
- Широкая линейка поставок активных и пассивных импортных электронных компонентов (более 30 млн. наименований);
- Поставка сложных, дефицитных, либо снятых с производства позиций;
- Оперативные сроки поставки под заказ (от 5 рабочих дней);
- Экспресс доставка в любую точку России;
- Помощь Конструкторского Отдела и консультации квалифицированных инженеров;
- Техническая поддержка проекта, помощь в подборе аналогов, поставка прототипов;
- Поставка электронных компонентов под контролем ВП;
- Система менеджмента качества сертифицирована по Международному стандарту ISO 9001;
- При необходимости вся продукция военного и аэрокосмического назначения проходит испытания и сертификацию в лаборатории (по согласованию с заказчиком);
- Поставка специализированных компонентов военного и аэрокосмического уровня качества (Xilinx, Altera, Analog Devices, Intersil, Interpoint, Microsemi, Actel, Aeroflex, Peregrine, VPT, Syfer, Eurofarad, Texas Instruments, MS Kennedy, Miteq, Cobham, E2V, MA-COM, Hittite, Mini-Circuits, General Dynamics и др.);

Компания «Океан Электроники» является официальным дистрибьютором и эксклюзивным представителем в России одного из крупнейших производителей разъемов военного и аэрокосмического назначения «JONHON», а так же официальным дистрибьютором и эксклюзивным представителем в России производителя высокотехнологичных и надежных решений для передачи СВЧ сигналов «FORSTAR».



## JONHON

«JONHON» (основан в 1970 г.)

Разъемы специального, военного и аэрокосмического назначения:

(Применяются в военной, авиационной, аэрокосмической, морской, железнодорожной, горно- и нефтедобывающей отраслях промышленности)

«FORSTAR» (основан в 1998 г.)

ВЧ соединители, коаксиальные кабели, кабельные сборки и микроволновые компоненты:

(Применяются в телекоммуникациях гражданского и специального назначения, в средствах связи, РЛС, а так же военной, авиационной и аэрокосмической отраслях промышленности).



Телефон: 8 (812) 309-75-97 (многоканальный)

Факс: 8 (812) 320-03-32

Электронная почта: [ocean@oceanchips.ru](mailto:ocean@oceanchips.ru)

Web: <http://oceanchips.ru/>

Адрес: 198099, г. Санкт-Петербург, ул. Калинина, д. 2, корп. 4, лит. А