

DIFFERENTIAL CONNECTOR

FCN-260(D) Series microGiGaCN™

RoHS Compliant



■ FEATURES

- I/O Connector designed for high speed differential signal applications.
- Matched Impedance (100 ohms \pm 10%)
- Low insertion loss
- Low cross talk
- Adopted by InfiniBand as 10G Ethernet, SAS, & SATA for 4x/12x Interface



■ SPECIFICATIONS

Item	Specifications
Operating temperature range	-55° C to +105° C
Current rating	AC 0.5A (signal) AC 1A (ground)
Voltage rating	AC 30V
Contact resistance (with conductor resistance)	80 m ohms max. (signal) 35 m ohms max.(ground)
Insulation resistance	1000M ohms minimum
Dielectric withstanding voltage	AC 500V for 1 minute
Durability	250 cycles
Insertion force	30 N max. (8 pair) 60 N max. (24 pair)
Withdrawl force	7 N min. (8 pair) 10.5 N min. (24 pair)

■ MATERIALS

Item	Materials
Insulator	LCP Resin (UL94V-0)
Conductor	Copper Alloy
Plating	Contact: Gold Plating (PAGOS) Terminal: Gold coat over Pd-Ni plating Cover: Zinc

Product Specification are subject to change, please check our website (www.fc.ai.fujitsu.com) for the latest specifications.

microGiGaCN™ FCN- 260 (D) Series

The MicroGiGaCN offers a cost-effective I/O solution for high-speed applications in data and telecommunications convergence (voice, data, video and storage). It offers four or twelve link widths, offering a scalable performance range of 500Mbps to 6Gbps per link to meet the needs of entry-level and high-end enterprise systems. Forward crosstalk is less than 4% at 100 pico second pulse-rise time (four-pair switching).

Fujitsu Components designed the MicroGiGaCN to specifically address the requirements for a high speed differential signal I/O connector.

The MicroGiGaCN offers a unique solution to LVDS, InfiniBand, 10G Ethernet, 3G/6G SAS & SATA, and other high speed I/O applications. InfiniBand, IEEE802.3AR, SAS, & SATA have selected Fujitsu's connector for the 4x and 12x I/O connector interface.

The performance requirements of the connector system were tested with cable to simulate the actual requirements of an OEM System manufacturer. Our test data includes the parasitic effects of the PCB, along with measurements of a completed I/O cable assembly.

Electrical Performance in out testing:

- Matched Impedance: 93.6 to 109.9 ohms @ 100 ps Trise
- Low Cross Talk: NEXT 3.8% @ 100pc Trise (4 pairs switching, 2 connectors and 10 meters of cable)
- Low Insertion Loss: 2.3dB @ 2.5Gb/s (1.25GHz, 1 Meter Cable Assembly)
- Skew within Differential Pair: 14.4ps (2 connectors and 2 meter of cable)
- Skew pair to pair: 21.2ps (2 connectors and 2 meter of cable)

Product Specification are subject to change, please check our website (<http://us.fujitsu.com/connectors>) for the latest specifications.

microGiGaCN™ FCN- 260 (D) Series

Connector Internal Structure



Basic Concept for Differential Transfer

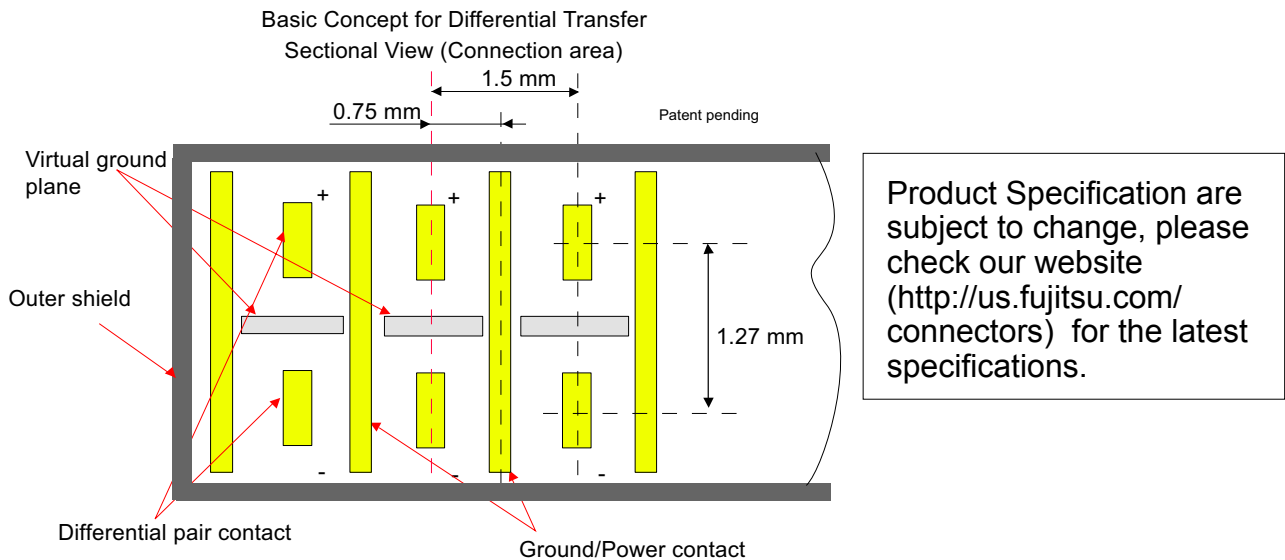

Fujitsu Components has designed the mechanical features of the connector to provide space saving footprint that will allow for 3 4x I/O connectors to mount onto a PCI form, or 2 12x. As RFI/EMI are critical elements in high performance cable assemblies, Fujitsu Components provides the surface mount sockets with an EMI Ground Spring on the face of the connector, to insure that the metal surface of the connector makes sufficient contact with the metal face of the card bracket.

The latching mechanism of the backshell offers a lanyard system for ease of un-mating the I/O plug connector/cable assembly from the SMT I/O socket. The die cast backshell offers excellent RFI/EMI characteristics. The backshell uses a ferrule and

unique ground spring system to provide 360 degree contact of the cable shield to the backshell, which, combined with the solid interconnect of the socket to faceplate, offers low AC coupling termination.

The current version of the I/O plug comes with an attached paddlecard for wire termination. Fujitsu offers the paddlecard in either an equalized or un-equalized version (see factory for details of the equalized version). Standard product offering will be un-equalized. As there are multiple applications for the paddlecard, with industry and customer specific wire termination, Fujitsu Components offers options to customers of providing the I/O plug connector with custom paddlecards (consult factory).

microGiGaCN™ FCN-260 (D) Series

CABLE I/O JACK SCREW LOCK TYPE

■ DIMENSIONS

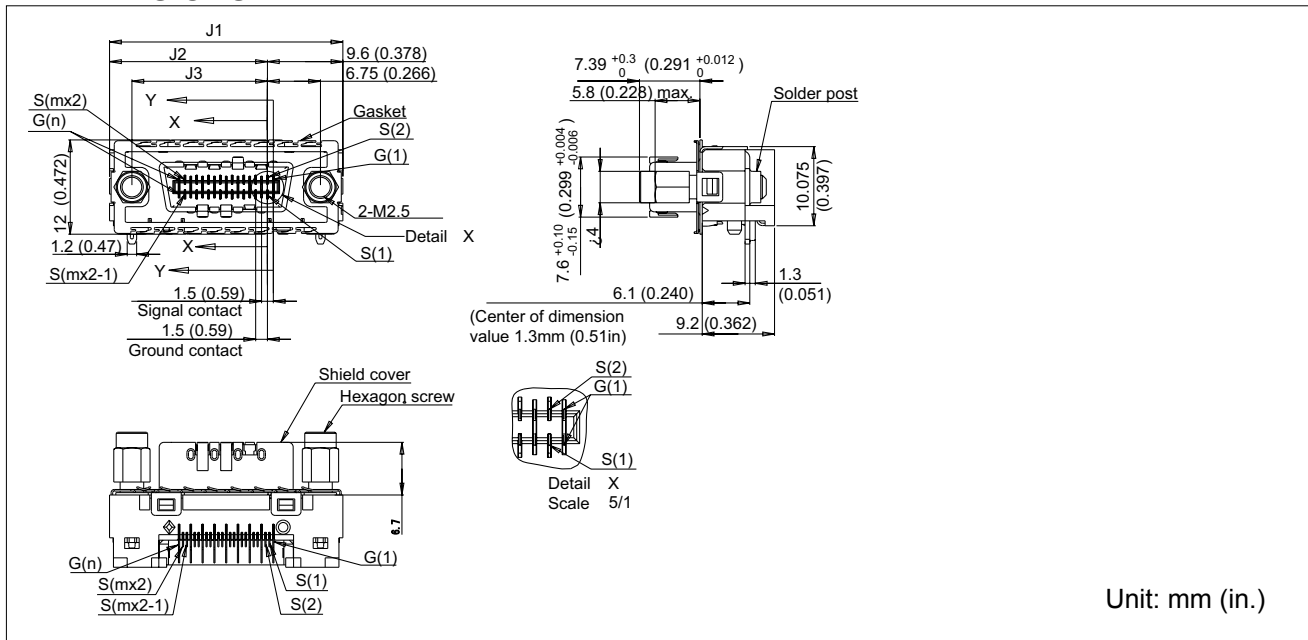

CABLE I/O JACK SCREW LOCK TYPE

FCN-268D0**-G/0*

NO MOLD PIN

■ DIMENSIONS

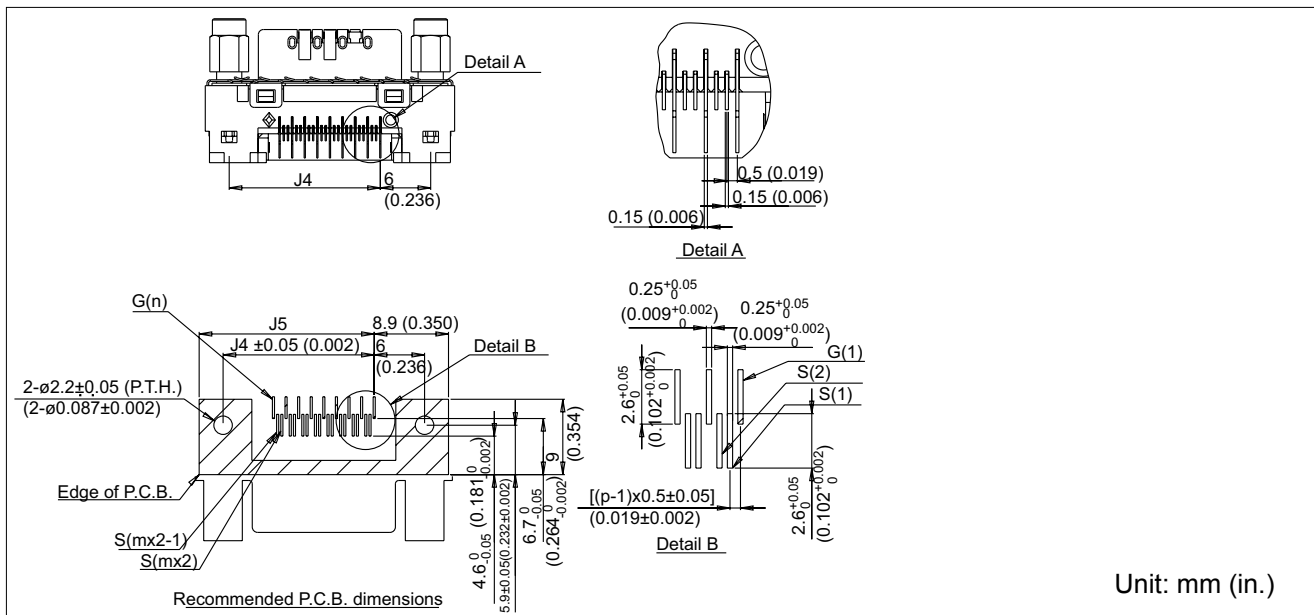

Part Number	m	n	p	J1	J2	J3	J4	J5
FCN-268D008-G/0*	1-8	1-9	1-25	29.8 (1.173)	20.15 (0.793)	17.25 (0.679)	18 (0.709)	20.9 (0.823)
FCN-268D024-G/0*	1-24	1-25	1-73	53.8 (2.118)	44.15 (1.738)	41.25 (1.624)	42 (1.654)	44.9 (1.768)

microGiGaCN™ FCN-260 (D) Series

CABLE I/O JACK SCREW LOCK TYPE FCN-268D0**-G/1* WITH ALIGNMENT PIN FCN-268D0**-G/2* WITH CRUSH PIN ■ DIMENSIONS



Part Number	m	n	p	J6	J7	J8
FCN-268D008-G/1*	1-8	1-9	1-25	14.5 (0.571)	19.25 (0.758)	22.15 (0.872)
FCN-268D008-G/2*	1-8	1-9	1-25	14.5 (0.571)	19.25 (0.758)	22.15 (0.872)
FCN-268D024-G/1*	1-24	1-25	1-73	38.1 (1.516)	43.25 (1.703)	46.15 (1.817)
FCN-268D024-G/2*	1-24	1-25	1-73	38.1 (1.516)	43.25 (1.703)	46.15 (1.817)

CABLE I/O JACK SCREW LOCK TYPE LOCK TYPE FCN-268D0**-G/ ** SOLDER POST LENGTH ■ DIMENSIONS



Part Number	P.C.B. thickness	J12
FCN-268D0**-G/*0	1.6 (0.063)	2.352 (0.092)
FCN-268D0**-G/*1	2.4 (0.0940)	3.125 (0.123)
fcn-268d0**-G/*3	4.0 (0.157)	4.725 (0.186)

CABLE I/O JACK SCREW LOCK TYPE FCN-268D0**-G/3* WITH DIAMOND PIN ■ DIMENSIONS



Part Number	m	n	p	J9	J10	J11
FCN-268D008-G/3*	1-8	1-9	1-25	14.5 (0.571)	19.25 (0.758)	22.15 (0.872)
FCN-268D024-G/3*	1-24	1-25	1-73	38.1 (1.516)	43.25 (1.703)	46.15 (1.817)

microGiGaCN™ FCN- 260 (D) Series

CABLE I/O JACK SCREW LOCK TYPE FCN-268D0**-G/ ** PANEL CUTOUT (REFERENCE)

■ DIMENSIONS



Part Number	m	n	J13	J14	J15
FCN-268D008-G/**	1-8	1-9	27 (1.063)	24 (0.945)	19.7 (0.776)
FCN-268D024-G/**	1-24	1-25	51 (2.008)	48 (1.890)	43.7 (1.720)

microGiGaCN™ FCN-260 (D) Series

FCN-264D - VERTICAL MOUNT SOCKETS, LATCH STYLE

■ DIMENSIONS



■ PART NUMBERS

Part Number	Pair	m	n	p	A	B	C	D	E
FCN-264D008-G/** FCN-264D008-G/***	8	1-8	1-9	1-25	17.675 (0.696)	14.5 (0.571)	17.7 (0.697)	22.7 (0.894)	19.7 (0.776)
FCN-264D024-G/** FCN-264D024-G/***	24	1-24	1-24	1-73	41.675 (1.641)	38.5 (1.516)	41.7 (1.642)	46.7 (1.839)	43.7 (1.720)

Lock Plate Thickness:

Part Number	F: Panel Thickness	G: Lock Plate Thickness
FCN-264D008-G/** FCN-264D024-G/**	1.0	0.5: FCN-260A622 FCN-260A626
FCN-264D008-G/**1 FCN-264D024-G/**1	1.2	0.3: FCN-260A632 FCN-260A636

Solder Post Length:

Part Number	P.W.B. Thickness	H
FCN-264D0**-G/*D FCN-264D0**-G/*D1	1.6	2.325
FCN-264D0**-G/*F FCN-264D0**-G/*F1	2.4	3.125
FCN-264D0**-G/*K FCN-264D0**-G/*K1	4.0	4.725

microGiGaCN™ FCN- 260 (D) Series

4X / 12X RIGHT ANGLE MOUNT SOCKETS WITH LATCHES WITH ALIGNMENT POST OR CRUSH PIN OPTION

■ PART NUMBERS

	Pair	P.W.B. thickness	X	m	n	A	B	C	D	E	F	Crush Pin
FCN-268D008-G/1D	8	1.6 (0.063)	2.4 (0.094)	1-8	1-9	24.85 (0.978)	17.675 (0.696)	17.7 (0.697)	14.5 (0.571)	22.7±0.1 (.894±.004)	19.7±0.1 (.776±.004)	no
FCN-268D008-G/2D	8	1.6 (0.063)	2.4 (0.094)	1-8	1-9	24.85 (0.978)	17.675 (0.696)	17.7 (0.697)	14.5 (0.571)	22.7±0.1 (.894±.004)	19.7±0.1 (.776±.004)	yes
FCN-268D008-G/1F	8	2.4 (0.094)	3.2 (0.126)	1-8	1-9	24.85 (0.978)	17.675 (0.696)	17.7 (0.697)	14.5 (0.571)	22.7±0.1 (.894±.004)	19.7±0.1 (.776±.004)	no
FCN-268D008-G/2F	8	2.4 (0.094)	3.2 (0.126)	1-8	1-9	24.85 (0.978)	17.675 (0.696)	17.7 (0.697)	14.5 (0.571)	22.7±0.1 (.894±.004)	19.7±0.1 (.776±.004)	yes
FCN-268D008-G/1K	8	4.0 (0.157)	4.8 (0.189)	1-8	1-9	24.85 (0.978)	17.675 (0.696)	17.7 (0.697)	14.5 (0.571)	22.7±0.1 (.894±.004)	19.7±0.1 (.776±.004)	no
FCN-268D008-G/2K	8	4.0 (0.157)	4.8 (0.189)	1-8	1-9	24.85 (0.978)	17.675 (0.696)	17.7 (0.697)	14.5 (0.571)	22.7±0.1 (.894±.004)	19.7±0.1 (.776±.004)	yes
FCN-268D024-G/1D	24	1.6 (0.063)	2.4 (0.094)	1-24	1-25	48.85 (1.923)	41.675 (1.641)	41.7 (1.642)	38.5 (1.516)	46.7±0.1 (1.839±.004)	43.7±0.1 (1.720±.004)	no
FCN-268D024-G/2D	24	1.6 (0.063)	2.4 (0.094)	1-24	1-25	48.85 (1.923)	41.675 (1.641)	41.7 (1.642)	38.5 (1.516)	46.7±0.1 (1.839±.004)	43.7±0.1 (1.720±.004)	yes
FCN-268D024-G/1F	24	2.4 (0.094)	3.2 (0.126)	1-24	1-25	48.85 (1.923)	41.675 (1.641)	41.7 (1.642)	38.5 (1.516)	46.7±0.1 (1.839±.004)	43.7±0.1 (1.720±.004)	no
FCN-268D024-G/2F	24	2.4 (0.094)	3.2 (0.126)	1-24	1-25	48.85 (1.923)	41.675 (1.641)	41.7 (1.642)	38.5 (1.516)	46.7±0.1 (1.839±.004)	43.7±0.1 (1.720±.004)	yes
FCN-268D024-G/1K	24	4.0 (0.157)	4.8 (0.189)	1-24	1-25	48.85 (1.923)	41.675 (1.641)	41.7 (1.642)	38.5 (1.516)	46.7±0.1 (1.839±.004)	43.7±0.1 (1.720±.004)	no
FCN-268D024-G/2K	24	4.0 (0.157)	4.8 (0.189)	1-24	1-25	48.85 (1.923)	41.675 (1.641)	41.7 (1.642)	38.5 (1.516)	46.7±0.1 (1.839±.004)	43.7±0.1 (1.720±.004)	yes

Fujitsu has developed 3 different versions of the board mount connector to meet various mounting processes:

FCN-268D0xx-G/1*

Added alignment post for robotic placement (recommended)

FCN-268D0xx-G/2*

Added crush pin feature - for manual placement (recommended)

FCN-268D0xx-G/0*

Original Design for optical robotic placement to the PCB

Retention Clip Hand Tool



FCN-268T-T514/H

For Assembly instructions, please see the Lock Plate Hand Tool Instruction Manual

Retention Clip



■ PART NUMBERS

Type	Part No.	Thickness of I/O panel	A	B	C	D	E
4X	FCN-260A622	1.0 (0.039)	23.44 (0.923)	22.45 (0.884)	20.50 (0.807)	20.45 (0.805)	0.5 (0.02)
	FCN-260A632	1.2 (0.047)					0.3 (0.12)
12X	FCN-260A626	1.0 (0.039)	47.45 (1.868)	46.45 (1.829)	44.50 (1.752)	44.45 (1.75)	0.5 (0.02)
	FCN-260A636	1.2 (0.047)					0.3 (0.12)

Each connector is shipped with 1 piece of FCN-260A622 retention clip. To order connector and retention clip separately, please contact factory for part number.

microGiGaCN™ FCN-260 (D) Series

4X / 12X RIGHT ANGLE MOUNT CONNECTOR SOCKET WITH LATCHES WITH MOUNTING EARS

■ DIMENSIONS



■ PART NUMBERS

Partnumber	Pair	P.W.B. thickness	X	m	n	A	B	C	D	E	F
FCN-268D008-G/3L-R	8	1.6 (0.063)	2.4 (0.094)	1-8	1-9	24.85 (0.978)	17.675 (0.696)	23.025 (0.906)	20.175 (0.794)	17.7 (0.673)	14.5 (0.571)
FCN-268D008-G/3M-R	8	2.4 (0.094)	3.2 (0.126)	1-8	1-9	24.85 (0.978)	17.675 (0.696)	23.025 (0.906)	20.175 (0.794)	17.7 (0.673)	14.5 (0.571)
FCN-268D008-G/3P-R	8	4.0 (0.157)	4.8 (0.189)	1-8	1-9	24.85 (0.978)	17.675 (0.696)	23.025 (0.906)	20.175 (0.794)	17.7 (0.673)	14.5 (0.571)
FCN-268D024-G/3L-R	24	1.6 (0.063)	2.4 (0.094)	1-24	1-25	48.85 (1.923)	41.675 (1.641)	47.025 (1.851)	44.175 (1.739)	41.7 (1.642)	38.5 (1.516)
FCN-268D024-G/3M-R	24	2.4 (0.094)	3.2 (0.126)	1-24	1-25	48.85 (1.923)	41.675 (1.641)	47.025 (1.851)	44.175 (1.739)	41.7 (1.642)	38.5 (1.516)
FCN-268D024-G/3P-R	24	4.0 (0.157)	4.8 (0.189)	1-24	1-25	48.85 (1.923)	41.675 (1.641)	47.025 (1.851)	44.175 (1.739)	41.7 (1.642)	38.5 (1.516)

microGiGaCN™ FCN-260 (D) Series

4X / 12X RIGHT ANGLE MOUNT CONNECTOR SOCKET WITH LATCHES, WITH MOUNTING EARS

RECOMMENDED FOOTPRINT DIMENSIONS



PART NUMBERS

Partnumber	Pair	P.W.B. thickness	G	H	I	J	K	L
FCN-268D008-G/3L-R	8	1.6 (0.063)	29.85 (1.175)	22.7 (0.894)	19.7 (0.776)	25.025 (0.895)	16.075 (0.633)	16.65 (0.656)
FCN-268D008-G/3M-R	8	2.4 (0.094)	29.85 (1.175)	22.7 (0.894)	19.7 (0.776)	25.025 (0.895)	16.075 (0.633)	16.65 (0.656)
FCN-268D008-G/3P-R	8	4.0 (0.157)	29.85 (1.175)	22.7 (0.894)	19.7 (0.776)	25.025 (0.895)	16.075 (0.633)	16.65 (0.656)
FCN-268D024-G/3L-R	24	1.6 (0.063)	53.85 (2.095)	46.7 (1.839)	43.7 (1.720)	49.025 (1.930)	38.075 (1.499)	40.65 (1.600)
FCN-268D024-G/3M-R	24	2.4 (0.094)	53.85 (2.095)	46.7 (1.839)	43.7 (1.720)	49.025 (1.930)	38.075 (1.499)	40.65 (1.600)
FCN-268D024-G/3P-R	24	4.0 (0.157)	53.85 (2.095)	46.7 (1.839)	43.7 (1.720)	49.025 (1.930)	38.075 (1.499)	40.65 (1.600)

microGiGaCN™ FCN- 260 (D) Series

4X / 12X SOCKETS WITH LATCHES

4X I/O CONNECTOR SOCKET

■ DIMENSIONS



12X I/O CONNECTOR SOCKET

■ DIMENSIONS



■ PART NUMBERS

Part Number	X	Recommended PCB Thickness
FCN-268D008-G/0D	2.4	1.6
FCN-268D008-G/0F	3.2	2.4
FCN-268D008-G/0K	4.8	4.0

■ PART NUMBER

Part Number	X	Recommended PCB Thickness
FCN-268D024-G/0D	2.4	1.6
FCN-268D024-G/0F	3.2	2.4
FCN-268D024-G/0K	4.8	4.0

Fujitsu has developed 3 different versions of the board mount connector to meet various mounting processes:

FCN-268D0xx-G/1*
 FCN-268D0xx-G/2*
 FCN-268D0xx-G/0*

Added alignment post for robotic placement (recommended)
 Added crush pin feature - for manual placement (recommended)
 Original Design for optical robotic placement to the PCB

Product Specification are subject to change, please check our website (www.fcai.fujitsu.com) for the latest specifications.

microGiGaCN™ FCN-260 (D) Series

4X / 12X PLUG CONNECTOR WITH INFINIBAND STYLE PCB

■ REFERENCE



microGiGaCN™ FCN- 260 (D) Series

4X / 12X PLUG CONNECTOR WITH INFINIBAND STYLE PCB (CABLE MOUNT)

■ PART NUMBERS

Non-Equalized Plug Kits

Uses Lead Solder	RoHS 6/6 (lead free solder)	Data Speeds
FCN-261R008-G/0	FCN-261R008-G/0L	4x up to 3.2Gbps
FCN-261R008-G/5	FCN-261R008-G/5L	4x up to 7Gbps
FCN-261R024-G/0	FCN-261R024-G/0L	12x up to 3.2Gbps
FCN-261R024-G/5	FCN-261R024-G/5L	12x up to 7Gbps

Equalized Plug Kits

4x Plug Kits - Equalized

Uses Lead Solder	RoHS 6/6 (lead free solder)	Data Speeds	Equalized Pair
FCN-261R008-G/3#08	FCN-261R008-G/3L#08	IB SDR 8 meter, 24AWG	1-4
FCN-261R008-G/3#10	FCN-261R008-G/3L#10	IB SDR 10 meter, 24AWG	1-4
FCN-261R008-G/3#12	FCN-261R008-G/3L#12	IB SDR 12 meter, 24AWG	1-4
FCN-261R008-G/3A#08	FCN-261R008-G/3AL#08	IB SDR 8 meter, 26AWG	1-4
FCN-261R008-G/3A#10	FCN-261R008-G/3AL#10	IB SDR 10 meter, 26AWG	1-4
FCN-261R008-G/3A#12	FCN-261R008-G/3AL#12	IB SDR 12 meter, 26AWG	1-4
FCN-261R008-G/6#08	FCN-261R008-G/6L#08	IB DDR 8 meter, 24AWG	1-4
FCN-261R008-G/6#10	FCN-261R008-G/6L#10	IB DDR 10 meter, 24AWG	1-4
FCN-261R008-G/6#12	FCN-261R008-G/6L#12	IB DDR 12 meter, 24AWG	1-4
FCN-261R008-G/6A#08	FCN-261R008-G/6AL#08	IB DDR 8 meter, 26AWG	1-4
FCN-261R008-G/6A#10	FCN-261R008-G/6AL#10	IB DDR 8 meter, 26AWG	1-4

12x Plug Kits - Equalized

Uses Lead Solder	RoHS 6/6 (lead free solder)	Data Speeds	Equalized Pair
FCN-261R024-G/3#08	FCN-261R024-G/3L#08	12x IB SDR 8 meter, 24AWG	1-12
FCN-261R024-G/3#10	FCN-261R024-G/3L#10	12x IB SDR 10 meter, 24AWG	1-12
FCN-261R024-G/3#12	FCN-261R024-G/3L#12	12x IB SDR 12 meter, 24AWG	1-12
FCN-261R024-G/3A#08	FCN-261R024-G/3AL#08	12x IB SDR 8 meter, 26AWG	1-12
FCN-261R024-G/3A#10	FCN-261R024-G/3AL#10	12x IB SDR 10 meter, 26AWG	1-12
FCN-261R024-G/3A#12	FCN-261R024-G/3AL#12	12x IB SDR 12 meter, 26AWG	1-12
FCN-261R024-G/6#08	FCN-261R024-G/6L#08	12x IB DDR 8 meter, 24AWG	1-12
FCN-261R024-G/6#10	FCN-261R024-G/6L#10	12x IB DDR 10 meter, 24AWG	1-12
FCN-261R024-G/6#12	FCN-261R024-G/6L#12	12x IB DDR 12 meter, 24AWG	1-12
FCN-261R024-G/6A#08	FCN-261R024-G/6AL#08	12x IB DDR 8 meter, 26AWG	1-12
FCN-261R024-G/6A#10	FCN-261R024-G/6AL#10	12x IB DDR 8 meter, 26AWG	1-12

IB SDR = InfiniBand Single Data rate - 2.5Gbps

IB DDR = InfiniBand Double Data rate - 5Gbps

Equalized circuits are optimized for cable length / wire AWG

microGiGaCN™ FCN- 260 (D) Series

4X / 12X PLUG CONNECTOR WITHOUT PCB RECOMMENDED PADDLE CARD OUTLINE

■ DIMENSIONS



■ PART NUMBERS

Part Number	Pair	m	n	B	C
FCN-261R008-G/A	8	1-8	1-9	10.5 (0.413)	12.0 (0.472)
FCN-261R024-G/A	12	1-24	1-25	34.5 (1.358)	36.0 (1.417)

microGiGaCN™ FCN-260 (D) Series

4X / 12X BACKSHELL KITS, WITH LATCHES CABLE I/O PLUG COVER

■ DIMENSIONS



■ PART NUMBERS

Standard Backshell Kit	Backshell Kit w/Pull Tab
FCN-260C008-A/L0	FCN-260C008-A/LA
FCN-260C008-C/L0	FCN-260C008-C/LA
FCN-260C024-A/L0	FCN-260C024-A/LA
FCN-260C024-C/L0	FCN-260C024-C/LA

4x pull tab = FCN-260A905
12x pull tab = FCN-260A902

Backshell key plug = FCN-260A802

microGiGaCN™ FCN- 260 (D) Series

REFERENCE 4X CABLE MOUNT PLUG WITH BACKSHELL

■ DIMENSIONS



REFERENCE 12X CABLE MOUNT PLUG WITH BACKSHELL

■ DIMENSIONS



■ PART NUMBER

Plug: FCN-261R008-G/0x

Backshell Kit: FCN-260C008-A/L0

■ PART NUMBER

Plug: FCN-261R024-G/x

Backshell Kit: FCN-260C024-A/L0

Drawing reflects plug and backshell together.

Backshell Kit is backshell and hardware only. Plug is not included and must be ordered separately.

Notes: * FCN-261R0xx-G/x is shipped with protective pastic cover over mating face of connector to protect contacts during shipping and cable assembly process.

* Equalization available - please consult factory.

Product Specification are subject to change, please check our website (www.fcai.fujitsu.com) for the latest specifications.

microGiGaCN™ FCN-260 (D) Series

4X LOOPBACK MODULE - 8 PAIRS

FCN-261Z008 (ROHS 5/6) - discontinued, replaced by:
FCN-261Z008L (ROHS 6/6)

■ DIMENSIONS



12X LOOPBACK MODULE - 8 PAIRS

FCN-261Z024 (ROHS 5/6)- discontinued, replaced by:
FCN-261Z024L (ROHS 6/6)

■ DIMENSIONS



microGiGaCN™ FCN-260 (D) Series

4X / 12X BACKSHELL KIT, THUMBSCREWS

■ DIMENSIONS



■ PART NUMBERS

Part Number	Pair No.	C1	C2	C3	C4	K1	K2	K3	K4
FCN-260C008-A/S3	8	29.8 (1.173)	20.15 (0.793)	17.25 (0.679)	14.4 (0.567)	9.75 (0.384)	6.75 (0.266)	5.25 (0.207)	8.25 (0.325)
FCN-260C024-A/S3	24	53.8 (2.118)	44.15 (1.738)	41.25 (1.624)	21.0 (0.827)	33.75 (1.329)	30.75 (1.211)	29.25 (1.152)	32.25 (1.270)

microGiGaCN™ FCN- 260 (D) Series

■ ASSEMBLY TOOLS



FCN-237T-T109/H
Hand Press



Ferrule Crimp Dies

Ferrule Crimp Dies

Part Number	Applicable Backshell	Applicable Cable OD	Notes
FCN-261T-T002/H	FCN-260C008-A/L0	9.53±0.4	Normally 8 pair, 24AWG
	FCN-260C008-A/S3	0.375±0.015	
FCN-261T-T103/H	FCN-260C008-C/L0	8.38±0.4	Normally 8 pair, 26AWG or 28AWG
	FCN-260C008-C/S3	0.330±0.015	
FCN-261T-T101/H	FCN260C024-C/L1	12.32±0.04	Normally 24 pair, 26AWG
	FCN260C024-C/L1S	0.485±0.015	
	FCN260C024-C/R1S		
	FCN260C024-C/4		
	FCN260C024-E/L1	10.287±0.4 0.405±0.015	Normally 22 pair, 28AWG
	FCN260C024-E/L0	11.05±0.4 0.435±0.015	Normally 24 pair, 28AWG
FCN-261T-T103/H	FCN-260C024-C/L2		
	FCN-260C024-C/L5		
FCN-261T-T105/H	FCN-260C024-A/L0	15.49±0.4	Normally 24 pair, 24AWG
	FCN-260C024-A/S3	0.610±0.015	
	FCN-260C024-A/LA		

Both the press and ferrule crimp tool are required for the ferrule crimp process.
Note that additional tooling will be added to cover smaller wire bundle O.D.s. Please check with factory.

microGiGaCN™ FCN-260 (D) Series

■ INSTRUCTIONS FOR CABLE ASSEMBLY

1. Set the crimping dies onto the hand press

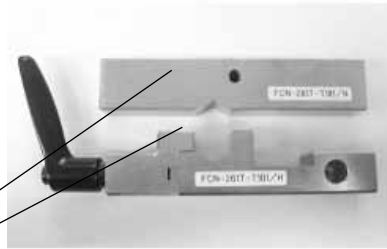

After a set is completed

2. A ferrule and a spring are put on the cable.

a. Strip the cable insulator and put the spring, which shall be moved at the position where it does not interfere with assembly process.

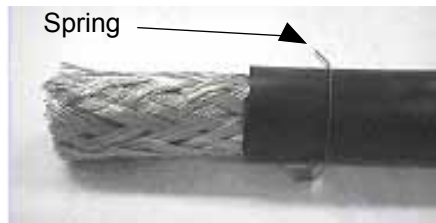

b. The shield braid is turned back and cut the length of 13mm (0.512 in.)

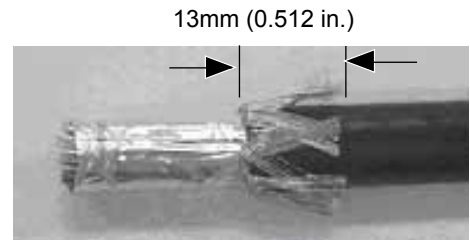

c. A ferrule is put on the position of 2mm from the end of the jacket

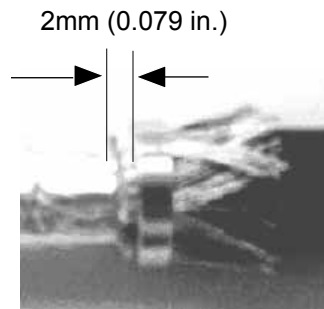

d. Strip the shield pair of wires (27mm [1.063in.] from the ring edge) and then wire insulation (27.5mm [1.082 in.]).



e. A shield of pair wires passed through the aligner, and solder the wires onto the paddle card.

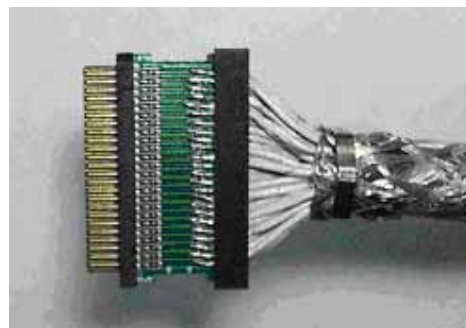

microGiGaCN™ FCN-260 (D) Series

3. Ferrule crimping:

To explain the process clearly, the following photos do not have a paddle card.

a. Set the cable onto right side of the jig, and end of the jig, ferrule edges are made to become parallel, and surface of provisional crimp and the connector made to parallel, pre-crimp the ferrule until part A, D hit parts B, E. (The ferrule becomes an eclipse).



Cable		X (mm) [in.]
Pair	AWG	
8	24	10.5 [0.413]
24	24	15.60 [0.614]



b. Confirm that lever is tightened hardly. If it isn't, a lever shall be pulled to the front and tightened.

c. Set the cable at the table cavity at the left side. (The ferrule edge/end face shall be parallel to the jig).

If a ring is not able to be inserted into the hollow, loosen with the lever, and insert the ferrule again. Then tighten with the lever.



d. Crimp ferrule until parts A, D hit parts B, E.



e. Hand press is returned to the original position, and loosened with the lever pulling forward.



f. Crimp completion.

microGiGaCN™ FCN- 260 (D) Series

Check Y dimension:



Cable		Y (mm) [in.]
Pair	AWG	
8	24	10.8 [0.425]
24	24	16.00 [0.630]

4. Turn back the jacket and cut in the ferrule edge.



5. Installation of cover:

g. Set the cable and soldered with the paddle card into the outer cover. (#1 pin position side of the connector shall be on top) and put another cover, and set the spring, which is initially put on the cable, at the edge of the ferrule and install it inside and then fix the covers with the screws.

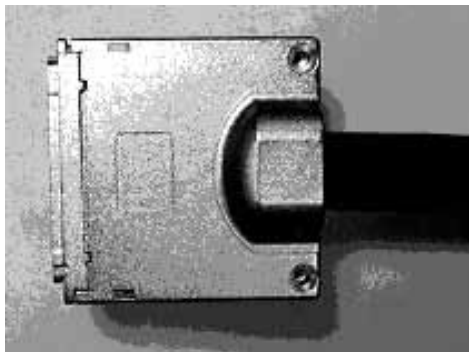

microGiGaCN™ FCN- 260 (D) Series

Fujitsu Components International Headquarter Offices

Japan

Fujitsu Component Limited
Gotanda-Chuo Building
3-5, Higashigotanda 2-chome, Shinagawa-ku
Tokyo 141, Japan
Tel: (81-3) 5449-7010
Fax: (81-3) 5449-2626
Email: promothq@ft.ed.fujitsu.com
Web: www.fcl.fujitsu.com

North and South America

Fujitsu Components America, Inc.
250 E. Caribbean Drive
Sunnyvale, CA 94089 U.S.A.
Tel: (1-408) 745-4900
Fax: (1-408) 745-4970
Email: components@us.fujitsu.com
Web: <http://us.fujitsu.com/printers/>

Europe

Fujitsu Components Europe B.V.
Diamantlaan 25
2132 WV Hoofddorp
Netherlands
Tel: (31-23) 5560910
Fax: (31-23) 5560950
Email: info@fceu.fujitsu.com
Web: emea.fujitsu.com/components/

Asia Pacific

Fujitsu Components Asia Ltd.
102E Pasir Panjang Road
#01-01 Citilink Warehouse Complex
Singapore 118529
Tel: (65) 6375-8560
Fax: (65) 6273-3021
Email: fcal@fcal.fujitsu.com
Web: <http://www.fujitsu.com/sg/services/micro/components/>

©2012 Fujitsu Components America, Inc. All rights reserved. All trademarks or registered trademarks are the property of their respective owners.

Fujitsu Components America or its affiliates do not warrant that the content of datasheet is error free. In a continuing effort to improve our products Fujitsu Components America, Inc. or its affiliates reserve the right to change specifications/datasheets without prior notice.
Rev. September 13, 2012.

Компания «Океан Электроники» предлагает заключение долгосрочных отношений при поставках импортных электронных компонентов на взаимовыгодных условиях!

Наши преимущества:

- Поставка оригинальных импортных электронных компонентов напрямую с производств Америки, Европы и Азии, а так же с крупнейших складов мира;
- Широкая линейка поставок активных и пассивных импортных электронных компонентов (более 30 млн. наименований);
- Поставка сложных, дефицитных, либо снятых с производства позиций;
- Оперативные сроки поставки под заказ (от 5 рабочих дней);
- Экспресс доставка в любую точку России;
- Помощь Конструкторского Отдела и консультации квалифицированных инженеров;
- Техническая поддержка проекта, помощь в подборе аналогов, поставка прототипов;
- Поставка электронных компонентов под контролем ВП;
- Система менеджмента качества сертифицирована по Международному стандарту ISO 9001;
- При необходимости вся продукция военного и аэрокосмического назначения проходит испытания и сертификацию в лаборатории (по согласованию с заказчиком);
- Поставка специализированных компонентов военного и аэрокосмического уровня качества (Xilinx, Altera, Analog Devices, Intersil, Interpoint, Microsemi, Actel, Aeroflex, Peregrine, VPT, Syfer, Eurofarad, Texas Instruments, MS Kennedy, Miteq, Cobham, E2V, MA-COM, Hittite, Mini-Circuits, General Dynamics и др.);

Компания «Океан Электроники» является официальным дистрибьютором и эксклюзивным представителем в России одного из крупнейших производителей разъемов военного и аэрокосмического назначения «JONHON», а так же официальным дистрибьютором и эксклюзивным представителем в России производителя высокотехнологичных и надежных решений для передачи СВЧ сигналов «FORSTAR».



JONHON

«JONHON» (основан в 1970 г.)

Разъемы специального, военного и аэрокосмического назначения:

(Применяются в военной, авиационной, аэрокосмической, морской, железнодорожной, горно- и нефтедобывающей отраслях промышленности)

«FORSTAR» (основан в 1998 г.)

ВЧ соединители, коаксиальные кабели, кабельные сборки и микроволновые компоненты:

(Применяются в телекоммуникациях гражданского и специального назначения, в средствах связи, РЛС, а так же военной, авиационной и аэрокосмической отраслях промышленности).



Телефон: 8 (812) 309-75-97 (многоканальный)

Факс: 8 (812) 320-03-32

Электронная почта: ocean@oceanchips.ru

Web: <http://oceanchips.ru/>

Адрес: 198099, г. Санкт-Петербург, ул. Калинина, д. 2, корп. 4, лит. А