



Features

- On-state RMS current, $I_{T(RMS)}$ 12 A
- Repetitive peak off-state voltage, V_{DRM} and V_{RRM} 600 V, 800 V and 1000 V
- Triggering gate current, I_{GT} 5 mA or 15 mA

Description

The standard 12 A SCR series is suitable to fit all modes of control, found in applications such as overvoltage crowbar protection, motor control circuits in power tools and kitchen aids, inrush current limiting circuits, capacitive discharge ignition and voltage regulation circuits.

Available in through-hole or surface-mount packages, they provide an optimized performance in a limited space.

Table 1. Device summary

Order code	Voltage V_{DRM} / V_{RRM} (V)			I_{GT} (mA)	Package
	600	800	1000		
TYN1012RG			x	15	TO-220AB
TYN1012TRG			x	5	TO-220AB
TYN612RG	x			15	TO-220AB
TYN612TRG	x			5	TO-220AB
TYN812RG		x		15	TO-220AB
TYN812TRG		x		5	TO-220AB
TN1215-600B	x			15	DPAK
TN1215-600B-TR	x			15	DPAK
TN1215-600G	x			15	D ² PAK
TN1215-600G-TR	x			15	D ² PAK
TN1215-600H	x			15	IPAK
TN1215-800B-TR		x		15	DPAK
TN1215-800G-TR		x		15	D ² PAK
TN1215-800H		x		15	IPAK

1 Characteristics

Table 2. Absolute ratings (limiting values)

Symbol	Parameter			Value		Unit
				TN1215-x00B TN1215-x00H (1) (2)	TN1215-x00G ⁽¹⁾⁽²⁾ TYNx12 ⁽²⁾⁽³⁾ TYNx12T ⁽²⁾⁽³⁾	
$I_{T(RMS)}$	On-state RMS current (180° conduction angle)	TO-220AB ins. D ² PAK	$T_C = 110\text{ °C}$	12		A
$I_{T(AV)}$	Average on-state current (180° conduction angle)	DPAK IPAK		8		
I_{TSM}	Non repetitive surge peak on-state current	$t_p = 8.3\text{ ms}$	$T_{jinitial} = 25\text{ °C}$	115	145	A
		$t_p = 10\text{ ms}$		110	140	
i^2t	i^2t value for fusing		$T_{jinitial} = 25\text{ °C}$	60	98	A ² S
di/dt	Critical rate of rise of on- state current $I_G = 2 \times I_{GT}, t_r \leq 100\text{ ns}$	F = 60 Hz	$T_j = 125\text{ °C}$	50		A/ μ s
I_{GM}	Peak gate current	$t_p = 20\text{ }\mu$ s	$T_j = 125\text{ °C}$	4		A
$P_{G(AV)}$	Average gate power dissipation		$T_j = 125\text{ °C}$	1		W
T_{stg} T_j	Storage junction temperature range Operating junction temperature range			- 40 to + 150 - 40 to + 125		°C
V_{RGM}	Maximum peak reverse gate voltage			5		V

1. x00= 600, 800
2. Check [Table 1](#) for devices availability
3. x= 6,8,10

Table 3. Standard electrical characteristics (T_j = 25 °C, unless otherwise specified)

Symbol	Test conditions		TN1215-x00 ⁽¹⁾⁽²⁾		TYN ⁽²⁾		Unit	
			-B/-H	-G	x12T ⁽³⁾	x12 ⁽³⁾		
I _{GT}	V _D = 12 V, R _L = 33 Ω		Min.	2		0.5	2	mA
			Max.	15		5	15	
V _{GT}			Max.	1.3			V	
V _{GD}	V _D = V _{DRM} , R _L = 3.3 kΩ	T _j = 125 °C	Min.	0.2			V	
I _H	I _T = 500 mA, gate open		Max.	40	30	15	30	mA
I _L	I _G = 1.2 I _{GT}		Max.	80	60	30	60	mA
dV/dt	V _D = 67% V _{DRM} , gate open	T _j = 125 °C	Min.	200		40	200	V/μs
V _{TM}	I _{TM} = 24 A t _p = 380 μs	T _j = 25 °C	Max.	1.6			V	
V _{to}	Threshold voltage		Max.	0.85			V	
R _d	Dynamic resistance		Max.	30			mΩ	
I _{DRM} I _{RRM}	V _D = V _R = V _{DRM} = V _{RRM}		T _j = 25 °C	Max.			5	μA
			T _j = 125 °C				2	mA

1. x00= 600, 800
2. Check [Table 1](#) for devices availability
3. x= 6,8,10

Table 4. Thermal resistance

Symbol	Parameter		Value	Unit	
R _{th(j-c)}	Junction to case (DC)		D ² PAK, DPAK, IPAK, TO-220AB	1.3 °C/W	
R _{th(j-a)}	Junction to ambient (DC)	S ⁽¹⁾ = 0.5 cm ²	DPAK	70	°C/W
		S ⁽¹⁾ = 1.0 cm ²	D ² PAK	45	
			IPAK	100	
			TO-220AB	60	

1. S = Copper surface under tab

Figure 1. Maximum average power dissipation versus average on-state current

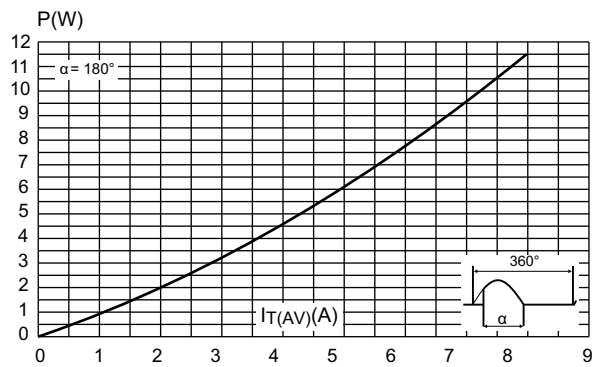

Figure 2. Average and DC on-state current versus case temperature

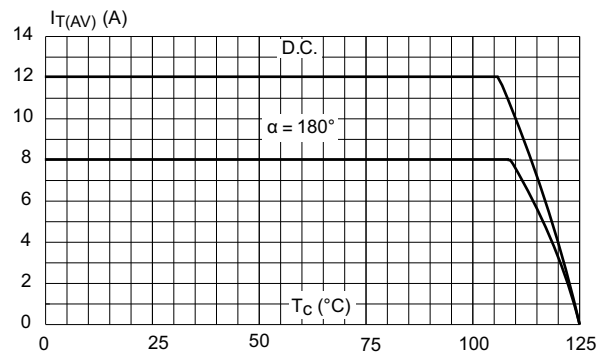

Figure 3. Average and DC on-state current versus ambient temperature (DPAK, D²PAK)



Figure 4. Relative variation of thermal impedance junction to case versus pulse duration

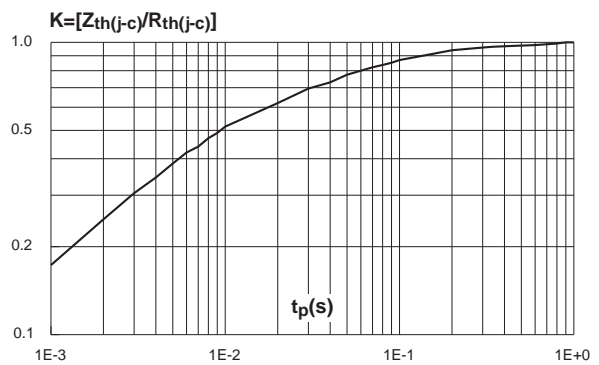

Figure 5. Relative variation of thermal impedance junction to ambient versus pulse duration

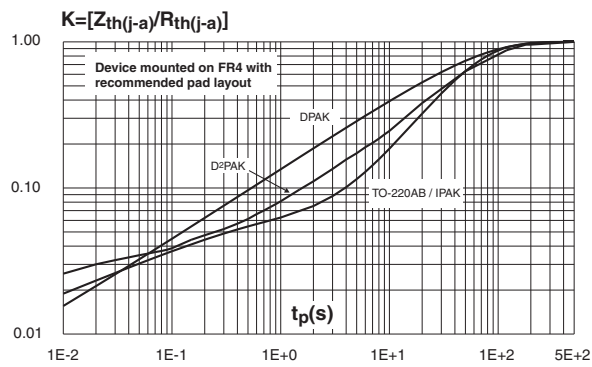

Figure 6. Relative variation of gate trigger, latching and holding current versus junction temperature

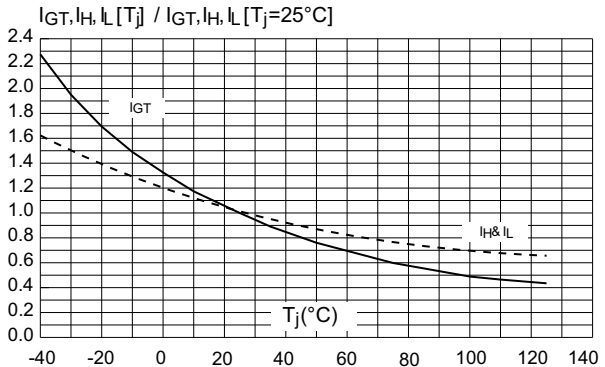

Figure 7. Surge peak on-state current versus number of cycles



Figure 8. Non repetitive surge peak on-state current for a sinusoidal pulse with width $t_p < 10\text{ ms}$



Figure 9. On-state characteristics (maximum values)



Figure 10. Thermal resistance junction to ambient versus copper surface under tab (DPAK and D²PAK)

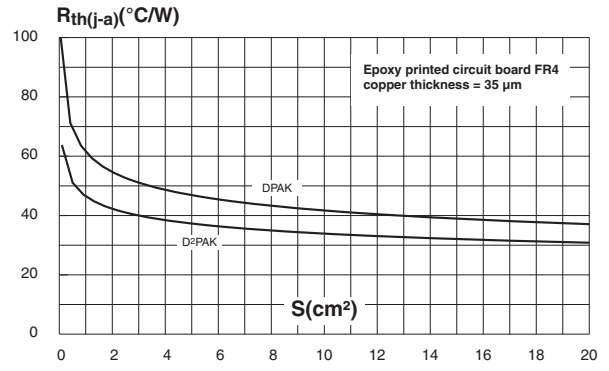

2 Package information

- Halogen free molding resin
- Epoxy meets UL94, V0
- Lead-free packages
- Recommended torque: 0.4 to 0.6 N·m (TO-220AB)

In order to meet environmental requirements, ST offers these devices in different grades of ECOPACK® packages, depending on their level of environmental compliance. ECOPACK® specifications, grade definitions and product status are available at: www.st.com. ECOPACK® is an ST trademark.

2.1 DPAK package information

Figure 11. DPAK package outline



Note: This package drawing may slightly differ from the physical package. However, all the specified dimensions are guaranteed.

Table 5. DPAK package mechanical data

Ref.	Dimensions					
	Millimeters			Inches ⁽¹⁾		
	Min.	Typ.	Max.	Min.	Typ.	Max.
A	2.18		2.40	0.0858		0.0945
A1	0.9		1.10	0.0354		0.0433
A2	0.03		0.23	0.0012		0.0091
b	0.64		0.90	0.0252		0.0354
b4	4.95		5.46	0.1949		0.2150
c	0.46		0.61	0.0181		0.0236
c2	0.46		0.60	0.0181		0.0236
D	5.97		6.22	0.2350		0.2449
D1	4.95		5.60	0.1949		0.2205
E	6.35		6.73	0.2500		0.2650
E1	4.32		5.50	0.1701		0.2165
e		2.286			0.0900	
e1	4.40		4.70	0.1732		0.1850
H	9.35		10.40	0.3681		0.4094
L	1.0		1.78	0.0394		0.0701
L2			1.27			0.0500
L4	0.6		1.02	0.0236		0.0402
V2	-8°		+8°	-8°		+8°

1. Inches only for reference.

Figure 12. Footprint (dimensions in mm)



2.2 IPAK package information

Figure 13. IPAK package outline

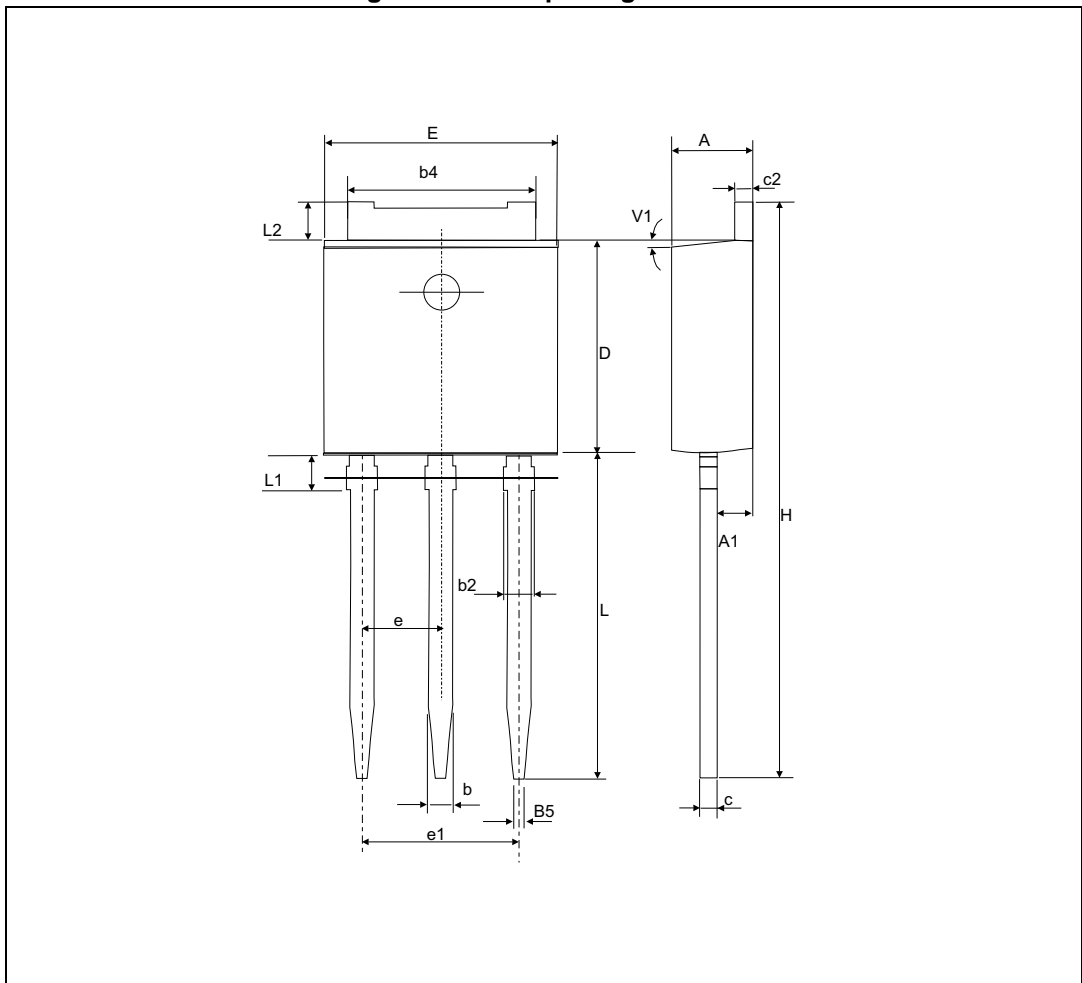

Note: This package drawing may slightly differ from the physical package. However, all the specified dimensions are guaranteed.

Table 6. IPAK package mechanical data

Ref.	Dimensions					
	Millimeters			Inches ⁽¹⁾		
	Min.	Typ.	Max.	Min.	Typ.	Max.
A	2.20		2.40	0.0866		0.0945
A1	0.90		1.10	0.0354		0.0433
b	0.64		0.90	0.0252		0.0354
b2			0.95			0.0374
b4	5.20		5.43	0.2047		0.2138
B5		0.30			0.0118	
c	0.45		0.60	0.0177		0.0236
c2	0.46		0.60	0.0181		0.0236
D	6.00		6.20	0.2362		0.2441
E	6.40		6.65	0.2520		0.2618
e		2.28			0.0898	
e1	4.40		4.60	0.1732		0.1811
H		16.10			0.6339	
L	9.00		9.60	0.3543		0.3780
L1	0.80		1.20	0.0315		0.0472
L2		0.80	1.25		0.0315	0.0492
V1		10°			10°	

1. Inches dimensions given only for reference.

2.3 TO-220AB package information

Figure 14. TO-220AB package outline



Table 7. TO-220AB package mechanical data

Ref.	Dimensions					
	Millimeters			Inches ⁽¹⁾		
	Min.	Typ.	Max.	Min.	Typ.	Max.
A	15.2		15.9	0.5984		0.6260
a1		3.75			0.1476	
a2	13		14	0.5118		0.5512
B	10		10.4	0.3937		0.4094
b1	0.61		0.88	0.0240		0.0346
b2	1.23		1.32	0.0484		0.0520
C	4.4		4.6	0.1732		0.1811
c1	0.49		0.7	0.0193		0.0276
c2	2.4		2.72	0.0945		0.1071
e	2.40		2.70	0.0945		0.1063
F	6.2		6.6	0.2441		0.2598
I	3.73		3.88	0.1469		0.1528
L	2.65		2.95	0.1043		0.1161
I2	1.14		1.7	0.0449		0.0669
I3	1.14		1.7	0.0449		0.0669
I4	15.8	16.4	16.8	0.6220	0.6457	0.6614
M		2.6			0.1024	

1. Inches dimensions given only for reference.

2.4 D²PAK package information

Figure 15. D²PAK package outline



Table 8. D²PAK package mechanical data

Ref.	Dimensions					
	Millimeters			Inches ⁽¹⁾		
	Min.	Typ.	Max.	Min.	Typ.	Max.
A	4.30		4.60	0.1693		0.1811
A1	2.49		2.69	0.0980		0.1059
A2	0.03		0.23	0.0012		0.0091
B	0.70		0.93	0.0276		0.0366
B2	1.25	1.40		0.0492	0.0551	
C	0.45		0.60	0.0177		0.0236
C2	1.21		1.36	0.0476		0.0535
D	8.95		9.35	0.3524		0.3681
D1	7.50		8.0	0.2953		0.3150
D2	1.3		1.7	0.0512		0.0669
E	10.00		10.28	0.3937		0.4047
E1	8.3		8.7	0.3268		0.3425
E2	6.85		7.25	0.2697		0.2854
G	4.88		5.28	0.1921		0.2079
L	15.00		15.85	0.5906		0.6240
L2	1.27		1.40	0.0500		0.0551
L3	1.40		1.75	0.0551		0.0689
R	0.40			0.0157		
V2	0°		8°	0°		8°

1. Inches dimensions given only for reference.

Figure 16. Footprint (dimensions in mm)



3 Ordering information

Figure 17. TN1215 series



Figure 18. TYNx12 series



Table 9. Ordering information

Order code	Voltage V_{DRM} / V_{RRM} (V)			I_{GT} (mA)	Package	Weight (g)	Base qty. (pc)	Delivery mode
	600	800	1000					
TYN1012RG			x	15	TO-220AB	2.3	50	Tube
TYN1012TRG			x	5	TO-220AB	2.3	50	Tube
TYN612RG	x			15	TO-220AB	2.3	50	Tube
TYN612TRG	x			5	TO-220AB	2.3	50	Tube
TYN812RG		x		15	TO-220AB	2.3	50	Tube
TYN812TRG		x		5	TO-220AB	2.3	50	Tube
TN1215-600B	x			15	DPAK	0.3	75	Tube
TN1215-600B-TR	x			15	DPAK	0.3	2500	Tape and reel
TN1215-600G	x			15	D ² PAK	1.5	50	Tube
TN1215-600G-TR	x			15	D ² PAK	1.5	1000	Tape and reel
TN1215-600H	x			15	IPAK	0.3	75	Tube
TN1215-800B-TR		x		15	DPAK	0.3	2500	Tape and reel
TN1215-800G-TR		x		15	D ² PAK	1.5	1000	Tape and reel
TN1215-800H		x		15	IPAK	0.3	75	Tube

4 Revision history

Table 10. Document revision history

Date	Revision	Changes
Sep-2000	3	Last update.
25-Mar-2005	4	TO-220AB delivery mode changed from bulk to tube.
14-Oct-2005	5	Changed sensitivity values in <i>Table 1</i> for TYNx12 (30 to 15 mA) and TYNx12T (15 to 5 mA). Added ECOPACK statement.
08-Mar-2007	6	Reformatted to current standard. <i>Figure 17: TN1215 series product name corrected.</i> <i>Figure 23: TS1220 series product name corrected.</i>
23-Oct-2009	7	Added TS1220-xxxT device.
03-Jun-2014	8	Updated DPAK and IPAK package information and reformatted to current standard.
25-Feb-2015	9	The part number TS1220 series has been moved to a separate document. Removed TO-220AB insulated package information.
29-Jul-2015	10	Updated <i>Figure 11</i> .
05-Oct-2016	11	Updated Section 2: Package information . Minor text changes.

IMPORTANT NOTICE – PLEASE READ CAREFULLY

STMicroelectronics NV and its subsidiaries (“ST”) reserve the right to make changes, corrections, enhancements, modifications, and improvements to ST products and/or to this document at any time without notice. Purchasers should obtain the latest relevant information on ST products before placing orders. ST products are sold pursuant to ST’s terms and conditions of sale in place at the time of order acknowledgement.

Purchasers are solely responsible for the choice, selection, and use of ST products and ST assumes no liability for application assistance or the design of Purchasers’ products.

No license, express or implied, to any intellectual property right is granted by ST herein.

Resale of ST products with provisions different from the information set forth herein shall void any warranty granted by ST for such product.

ST and the ST logo are trademarks of ST. All other product or service names are the property of their respective owners.

Information in this document supersedes and replaces information previously supplied in any prior versions of this document.

© 2016 STMicroelectronics – All rights reserved

Компания «Океан Электроники» предлагает заключение долгосрочных отношений при поставках импортных электронных компонентов на взаимовыгодных условиях!

Наши преимущества:

- Поставка оригинальных импортных электронных компонентов напрямую с производств Америки, Европы и Азии, а так же с крупнейших складов мира;
- Широкая линейка поставок активных и пассивных импортных электронных компонентов (более 30 млн. наименований);
- Поставка сложных, дефицитных, либо снятых с производства позиций;
- Оперативные сроки поставки под заказ (от 5 рабочих дней);
- Экспресс доставка в любую точку России;
- Помощь Конструкторского Отдела и консультации квалифицированных инженеров;
- Техническая поддержка проекта, помощь в подборе аналогов, поставка прототипов;
- Поставка электронных компонентов под контролем ВП;
- Система менеджмента качества сертифицирована по Международному стандарту ISO 9001;
- При необходимости вся продукция военного и аэрокосмического назначения проходит испытания и сертификацию в лаборатории (по согласованию с заказчиком);
- Поставка специализированных компонентов военного и аэрокосмического уровня качества (Xilinx, Altera, Analog Devices, Intersil, Interpoint, Microsemi, Actel, Aeroflex, Peregrine, VPT, Syfer, Eurofarad, Texas Instruments, MS Kennedy, Miteq, Cobham, E2V, MA-COM, Hittite, Mini-Circuits, General Dynamics и др.);

Компания «Океан Электроники» является официальным дистрибьютором и эксклюзивным представителем в России одного из крупнейших производителей разъемов военного и аэрокосмического назначения «JONHON», а так же официальным дистрибьютором и эксклюзивным представителем в России производителя высокотехнологичных и надежных решений для передачи СВЧ сигналов «FORSTAR».



JONHON

«JONHON» (основан в 1970 г.)

Разъемы специального, военного и аэрокосмического назначения:

(Применяются в военной, авиационной, аэрокосмической, морской, железнодорожной, горно- и нефтедобывающей отраслях промышленности)

«FORSTAR» (основан в 1998 г.)

ВЧ соединители, коаксиальные кабели, кабельные сборки и микроволновые компоненты:

(Применяются в телекоммуникациях гражданского и специального назначения, в средствах связи, РЛС, а так же военной, авиационной и аэрокосмической отраслях промышленности).



Телефон: 8 (812) 309-75-97 (многоканальный)

Факс: 8 (812) 320-03-32

Электронная почта: ocean@oceanchips.ru

Web: <http://oceanchips.ru/>

Адрес: 198099, г. Санкт-Петербург, ул. Калинина, д. 2, корп. 4, лит. А