

Middle Power Class-D Speaker Amplifiers

Class-D Speaker Amplifier for Digital Input



BD5446EFV

No.10075EBT14

●Description

BD5446EFV is a Class D Speaker Amplifier designed for Flat-panel TVs in particular for space-saving and low-power consumption, delivers an output power of 20W+20W. This IC employs state-of-the-art Bipolar, CMOS, and DMOS (BCD) process technology that eliminates turn-on resistance in the output power stage and internal loss due to line resistances up to an ultimate level. With this technology, the IC can achieve high efficiency of 87% (10W+10W output with 8Ω load). In addition, the IC is packaged in a compact reverse heat radiation type power package to achieve low power consumption and low heat generation and eliminates necessity of external heat-sink up to a total output power of 40W. This product satisfies both needs for drastic downsizing, low-profile structures and many function, high quality playback of sound system.

●Features

- 1) BD5446EFV has two system of digital audio interface.
(I²S/LJ format, SDATA: 16 / 20 / 24bit, LRCLK: 32kHz / 44.1kHz / 48kHz, BCLK: 64fs (fixed), SYS_CLK: 256fs (fixed))
- 2) Within the wide range of the power supply voltage, it is possible to operate in a single power supply. (10~26V)
- 3) It contributes to miniaturizing, making to the thin type, and the power saving of the system by high efficiency and low heat.
- 4) S/N of the system can be optimized by adjusting the gain setting among 8 steps. (20~34dB / 2dB step)
- 5) It has the output power limitation function that can be adjusted to an arbitrary output power.
- 6) The decrease in sound quality because of the change of the power supply voltage is prevented with the feedback circuitry of the output. In addition, a low noise and low distortion are achieved.
- 7) It provides with the best stereo DAC output for the headphone usage. As a result, the output of the selection of the digital input in two systems is possible.
- 8) Eliminates pop noise generated when the power supply goes on/off, or when the power supply is suddenly shut off. High quality muting performance is realized by using the soft-muting technology.
- 9) BD5446EFV is a highly reliable design to which it has various protection functions.
(High temperature protection, Under voltage protection, Output short protection, Output DC voltage protection and Clock stop protection)

●Applications

Flat Panel TVs (LCD, Plasma), Home Audio, Desktop PC, Amusement equipments, Electronic Music equipments, etc.,

● Absolute maximum ratings (Ta=25°C)

Parameter	Symbol	Ratings	Unit	Conditions
Supply voltage	V _{CC}	30	V	Pin 25, 28, 29, 53, 54 *1 *2
Power dissipation	P _d	2.0	W	*3
		4.5	W	*4
		6.2	W	*5
Input voltage	V _{IN}	-0.3 ~ 4.5	V	Pin 7 ~ 18, 21 *1
Open-drain terminal voltage	V _{ERR}	-0.3 ~ 30	V	Pin24 *1
Operating temperature range	T _{opr}	-25 ~ +85	°C	
Storage temperature range	T _{stg}	-55 ~ +150	°C	
Maximum junction temperature	T _{jmax}	+150	°C	

*1 The voltage that can be applied reference to GND (Pin 6, 36, 37, 45, 46).

*2 Do not, however exceed Pd and Tjmax=150°C.

*3 70mm×70mm×1.6mm, FR4, 1-layer glass epoxy board (Copper on bottom layer 0%)

Derating in done at 16mW/°C for operating above Ta=25°C.

*4 70mm×70mm×1.6mm, FR4, 2-layer glass epoxy board (Copper on bottom layer 100%)

Derating in done at 36mW/°C for operating above Ta=25°C. There are thermal via on the board.

*5 70mm×70mm×1.6mm, FR4, 4-layer glass epoxy board (Copper on bottom layer 100%)

Derating in done at 49.6mW/°C for operating above Ta=25°C. There are thermal via on the board.

● Operating conditions (Ta=25°C)

Parameter	Symbol	Ratings	Unit	Conditions
Supply voltage	V _{CC}	10 ~ 26	V	Pin 25, 28, 29, 53, 54 *1 *2
Minimum load impedance (Speaker Output)	R _{L_SP}	5.4	Ω	*6
Minimum load impedance (DAC Output)	R _{L_DA}	20	kΩ	Pin 22, 23

*6 Do not, however exceed Pd.

* No radiation-proof design.

●Electrical characteristics

(Unless otherwise specified Ta=25°C, Vcc=13V, f=1kHz, RL_SP=8Ω, RL_DA=20kΩ, RESETX=3.3V, MUTEX=3.3V, PDX=3.3V, Gain=20dB, fs=48kHz)

Item	Symbol	Limits			Unit	Conditions
		Min	Typ	Max		
Total circuit						
Circuit current	I _{CC1}	-	45	90	mA	Pin 25, 28, 29, 53, 54 No load
Circuit current (Power down mode)	I _{CC2}	-	1.5	3	mA	Pin 25, 28, 29, 53, 54, No load RESETX=0V, MUTEX=0V, PDX=0V
Open-drain terminal Low level voltage	V _{ERR}	-	-	0.8	V	Pin 24, I _O =0.5mA
Regulator output voltage 1	V _{REG_G}	5.0	5.5	6.0	V	Pin 1, 27
Regulator output voltage 2	V _{REG_3}	3.0	3.3	3.6	V	Pin 5
High level input voltage	V _{IH}	2.5	-	3.3	V	Pin 7 ~ 18, 21
Low level input voltage	V _{IL}	0	-	0.8	V	Pin 7 ~ 18, 21
Input current (Input pull-down terminal)	I _{IH}	33	66	132	μA	Pin 7 ~ 18, 21, V _{IN} = 3.3V
Speaker Output						
Maximum momentary output power 1	P _{O1}	-	10	-	W	THD+n=10% GAIN=26dB *7
Maximum momentary output power 2	P _{O2}	-	20	-	W	VCC=18V, THD+n=10% GAIN =26dB *7
Total harmonic distortion	THD _{SP}	-	0.07	-	%	P _O =1W, BW=20~20kHz *7
Crosstalk	CT _{SP}	65	80	-	dB	P _O =1W, BW=IHF-A *7
Output noise voltage (Sampling mode)	V _{NO_SP}	-	140	280	μVrms	-∞dBFS, BW=IHF-A *7
Residual noise voltage (Mute mode)	V _{NOR_SP}	-	5	10	μVrms	MUTEX=0V, -∞dBFS, BW=IHF-A *7
PWM sampling frequency	f _{PWM1}	-	512	-	KHz	fs=32kHz *7
	f _{PWM2}	-	705.6	-	KHz	fs=44.1kHz *7
	f _{PWM3}	-	768	-	KHz	fs=48kHz *7
DAC Output						
Maximum output voltage	V _{OMAX}	0.85	1.0	-	Vrms	0dBFS, THD+n=1%
Channel Balance	CB	-1	0	1	dB	0dBFS
Total harmonic distortion	THD _{DA}	-	0.05	0.5	%	-20dBFS, BW=20~20kHz
Crosstalk	CT _{DA}	65	80	-	dB	0dBFS, BW=IHF-A
Output noise voltage	V _{NO_DA}	-	10	20	μVrms	-∞dBFS, BW=IHF-A
Residual noise voltage	V _{NOR_DA}	-	3	10	μVrms	MUTEX=0V, PDX=0V, -∞dBFS, BW=IHF-A

*7 These items show the typical performance of device and depend on board layout, parts, and power supply.
The standard value is in mounting device and parts on surface of ROHM's board directly.

● **Electrical characteristic curves** ($V_{CC}=13V, T_a=25^\circ C, R_{L_SP}=8\Omega, R_{L_DA}=20k\Omega, Gain=20dB, f_{in}=1kHz, f_s=48kHz$)
 Measured by ROHM designed 4 layer board.

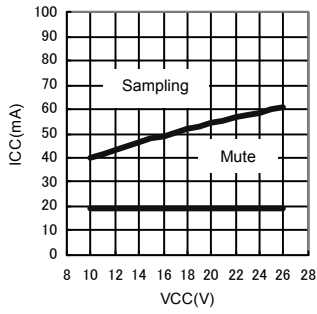

Fig.1

Current consumption
- Power supply voltage

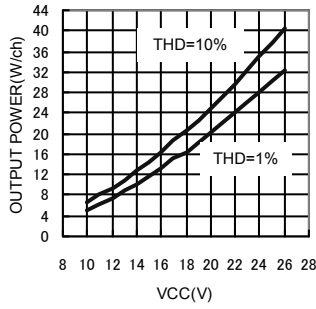

Fig.2

Output power
- Power supply voltage

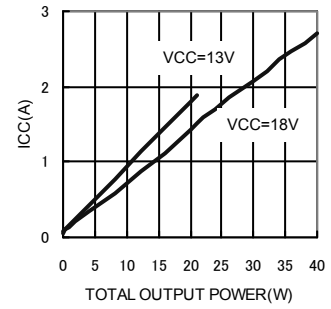

Fig.3

Current consumption
- Output power

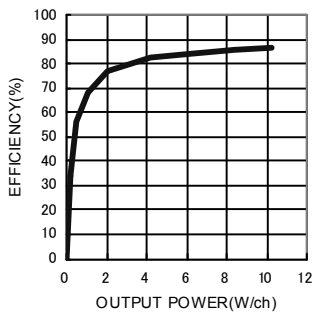

Fig.4

Efficiency - Output power

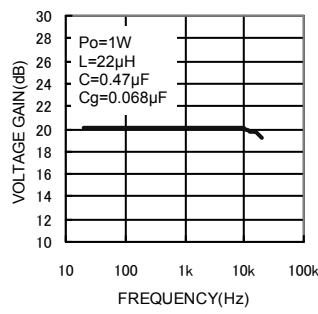

Fig.5

Voltage gain - Frequency

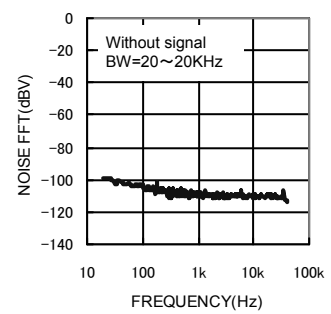

Fig.6

FFT of Output noise voltage

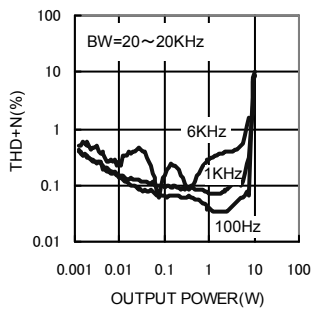

Fig.7

THD+N - Output power

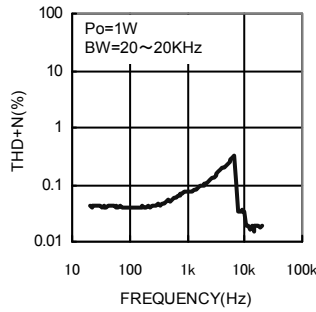

Fig.8

THD+N - Frequency

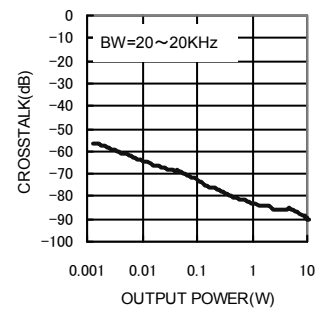

Fig.9

Crosstalk - Output power

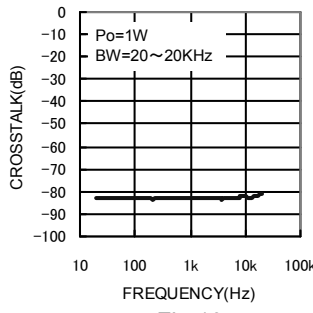

Fig.10

Crosstalk - Frequency

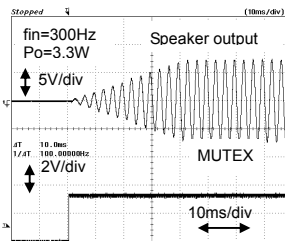

Fig.11

Wave form when
Releasing Soft-mute

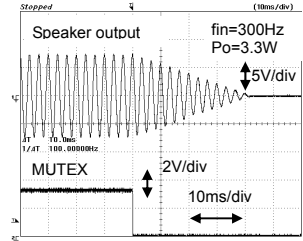

Fig.12

Wave form when
Activating Soft-mute

●Electrical characteristic curves($V_{CC}=18V, T_a=25^{\circ}C, R_{L_SP}=8\Omega, R_{L_DA}=20k\Omega, Gain=20dB, f_{in}=1kHz, f_s=48kHz$)
 Measured by ROHM designed 4layer board.

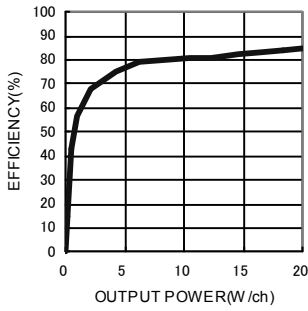

Fig. 13
 Efficiency – Output power

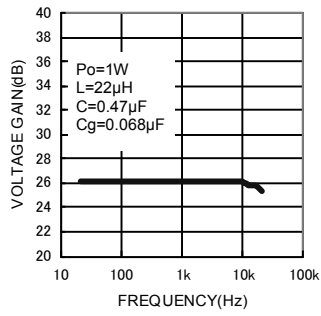

Fig. 14
 Voltage gain - Frequency

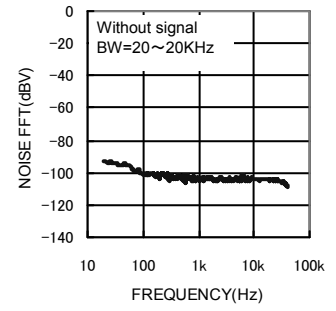

Fig. 15
 FFT of output noise voltage

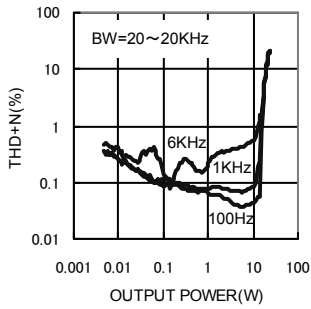

Fig. 16
 THD+N - Output power

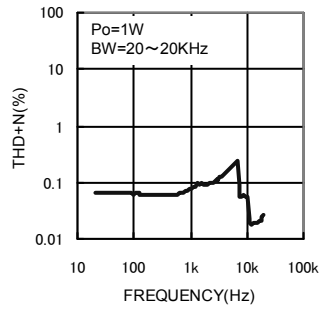

Fig. 17
 THD+N - Frequency

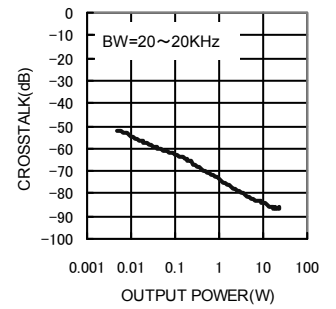

Fig. 18
 Crosstalk - Output power

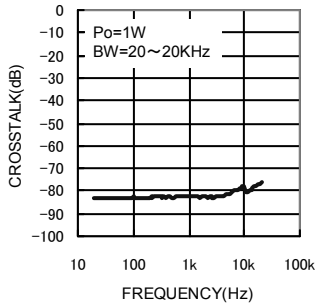
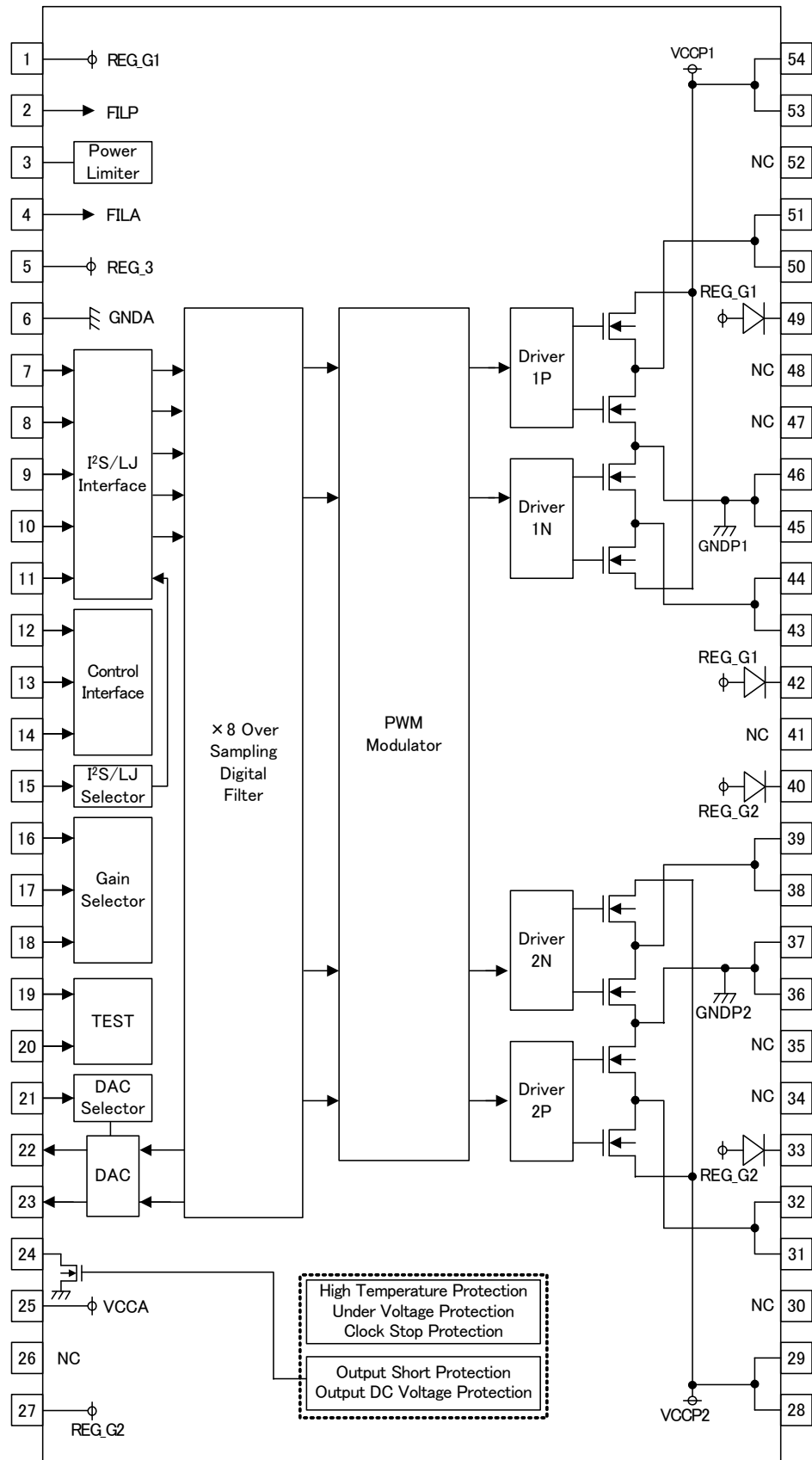

Fig. 19
 Crosstalk - Frequency

● Pin configuration and Block diagram



●Pin function explanation (Provided pin voltages are typ. Values)

No.	Pin name	Pin voltage	Pin explanation	Internal equivalence circuit
1 27	REG_G1 REG_G2	5.5V	Internal power supply pin for ch1 Gate driver Internal power supply pin for ch2 Gate driver Please connect the capacitor.	
2	FILP	1.75V~2.55V	Bias pin for PWM signal Please connect the capacitor.	
3	PLMT	0V	Power limiter setting terminal	
4	FILA	2.5V	Bias pin for Analog signal Please connect the capacitor.	
5	REG3	3.3V	Internal power supply pin for Digital circuit Please connect the capacitor.	
6	GNDA	0V	GND pin for Analog signal	—

No.	Pin name	Pin voltage	Pin explanation	Internal equivalence circuit
7 8 9 10 11	SYS_CLK BCLK LRCLK SDATA1 SDATA2	0V	Digital audio signal input pin	
12	RESETX	0V	Reset pin for Digital circuit H: Reset OFF L: Reset ON	
13	MUTEX		Speaker output mute control pin H: Mute OFF L: Mute ON	
14	PDX		Power down control pin H: Power down OFF L: Power down ON	
15	IIS_LJ	0V	Digital audio signal data format setting terminal H: Left Justified format L: I ² S format	
16 17 18	GAIN1 GAIN2 GAIN3	0V	Gain setting terminal Gain=20dB~34dB, 2dB step	
19 20	TEST1 TEST2	0V	Test pin Please connect to GND.	
21	SEL_DAC	0V	DAC output selection terminal H: SDATA2 is output from the DAC L: SDATA1 is output from the DAC	

No.	Pin name	Pin voltage	Pin explanation	Internal equivalence circuit
22 23	OUT_DAC2 OUT_DAC1	2.5V	ch2 DAC output pin ch1 DAC output pin Please connect it with the latter part circuit through the capacitor.	
24	ERROR	3.3V	Error flag pin Please connect pull-up resistor. H: While Normal L: While Error	
25	VCCA	VCC	Power supply pin for Analog signal	—
26,30 34,35 41,47 48,52	N.C.	—	Non connection pin	—

No.	Pin name	Pin voltage	Pin explanation	Internal equivalence circuit
28,29	VCCP2	Vcc	Power supply pin for ch2 PWM signal	
31,32	OUT2P	Vcc~0V	Output pin of ch2 positive PWM Please connect to Output LPF.	
33	BSP2P	—	Boot-strap pin of ch2 positive Please connect the capacitor.	
36,37	GNDP2	0V	GND pin for ch2 PWM signal	
38,39	OUT2N	Vcc~0V	Output pin of ch2 negative PWM Please connect to Output LPF.	
40	BSP2N	—	Boot-strap pin of ch2 negative Please connect the capacitor.	
42	BSP1N	—	Boot-strap pin of ch1 negative Please connect the capacitor.	
43,44	OUT1N	Vcc~0V	Output pin of ch1 negative PWM Please connect to Output LPF.	
45,46	GNDP1	0V	GND pin for ch1 PWM signal	
49	BSP1P	—	Boot-strap pin of ch1 positive Please connect the capacitor.	
50,51	OUT1P	Vcc~0V	Output pin of ch1 positive PWM Please connect to Output LPF.	
53,54	VCCP1	—	Power supply pin for ch1 PWM signal	

●GAIN1 pin, GAIN2 pin, GAIN3 pin function

GAIN3 (18pin)	GAIN2 (17pin)	GAIN1 (16pin)	Speaker output gain
L	L	L	20dB
L	L	H	22dB
L	H	L	24dB
L	H	H	26dB
H	L	L	28dB
H	L	H	30dB
H	H	L	32dB
H	H	H	34dB

●SEL_DAC pin function

SEL_DAC (21pin)	OUT_DAC1 (23pin)	OUT_DAC2 (24pin)
L	The Lch signal of SDATA1 is output	The Rch signal of SDATA1 is output
H	The Lch signal of SDATA2 is output	The Rch signal of SDATA2 is output

●RESETX pin function

RESETX (10pin)	State of Digital block
L	Reset ON
H	Reset OFF

●RESETX pin

RESETX (12pin)	State of Digital block
L	Reset ON
H	Reset OFF

●PDX pin,MUTEX pin function

PDX (12pin)	MUTEX (11pin)	Power Down	DAC output (24,25pin)	PWM output (33,34,38,39,43,44,48pin)
L	L or H	ON	HiZ_Low	HiZ_Low
H	L	OFF	Normal operation	
H	H			Normal operation

●IIS_LJ pin function

IIS_LJ (15pin)	Digital data format
L	I2S
H	Left Justified

●Input digital audio signal sampling frequency (fs) explanation

PWM sampling frequency, Soft-start, Soft-mute time, and the detection time of the DC voltage protection in the speaker depends on sampling frequency (fs) of the digital audio input.

Sampling frequency of the digital audio input (fs)	PWM sampling frequency (fpwm)	Soft-start / Soft-mute time	DC voltage protection in the speaker detection time
32kHz	512kHz	64msec.	64msec.
44.1kHz	705.6kHz	46msec.	46msec.
48kHz	768kHz	43msec.	43msec.

●For voltage gain (Gain setting)

BD5446EFV prescribe voltage gain at speaker output (BTL output) under the definition 0dBV (1Vrms) as full scale input of the digital audio input signal. For example, digital audio input signal = Full scale input, Gain setting = 20dB, Load resistance $R_{L_SP} = 8\Omega$ will give speaker output (BTL output) amplitude as $V_o=10V_{rms}$. (Output power $P_o = V_o^2/R_{L_SP} = 12.5W$)

●Speaker output and DAC output

Digital audio input signal SDATA1 will be output to the speaker. (SDATA2 will not be output to the speaker. DAC output can be selected either from digital audio input signal SDATA1 or SDATA2.)

●Format of digital audio input

- SYS_CLK: It is System Clock input signal.
It will input LRCLK, BCLK, SDATA1 (SDATA2) that synchronizes with this clock that are 256 times of sampling frequency (256fs).
- LRCLK: It is L/R clock input signal.
It corresponds to 32kHz/44.1kHz/48kHz with those clock (fs) that are same to the sampling frequency (fs) .
The data of a left channel and a right channel for one sample is input to this section.
- BCLK: It is Bit Clock input signal.
It is used for the latch of data in every one bit by sampling frequency's 64 times sampling frequency (64fs).
- SDATA1 & SDATA2: It is Data input signal.
It is amplitude data. The data length is different according to the resolution of the input digital audio data.
It corresponds to 16/ 20/ 24 bit.

● I²S data format

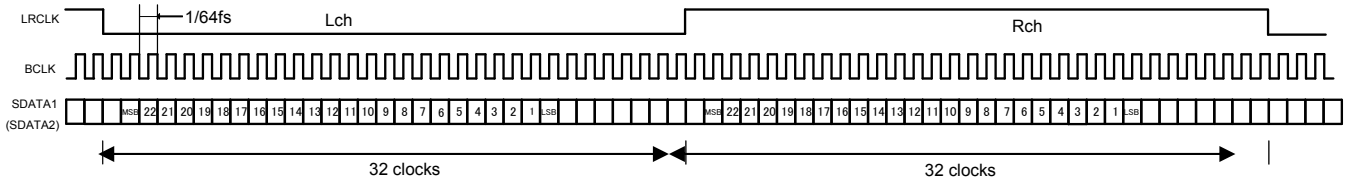

Fig.20 I²S Data Format 64fs, 24 bit Data

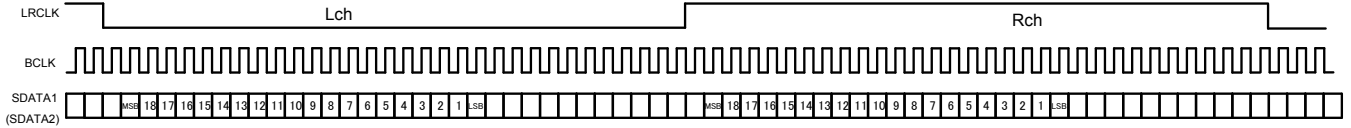

Fig.21 I²S Data Format 64fs, 20 bit Data

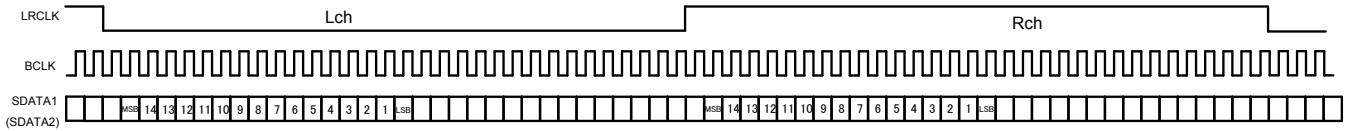

Fig.22 I²S Data Format 64fs, 16 bit Data

The Low section of LRCLK becomes Lch, the High section of LRCLK becomes Rch.
After changing LRCLK, second bit becomes MSB.

● Left-justified format

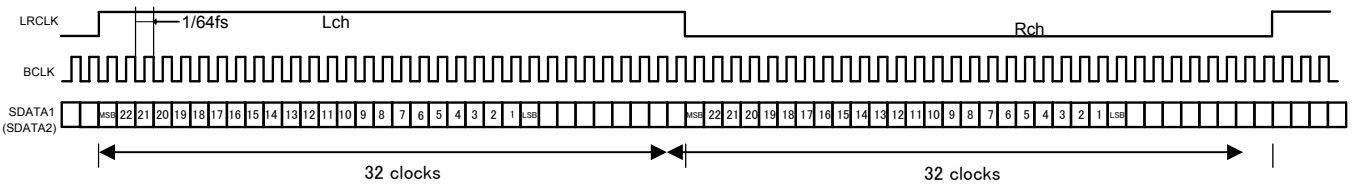

Fig.23 Left-Justified Data Format 64fs, 24 bit Data

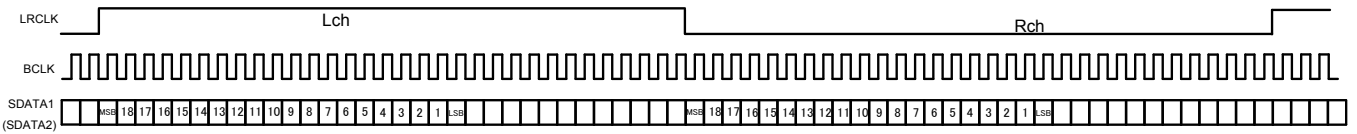

Fig.24 Left-Justified Data Format 64fs, 20 bit Data

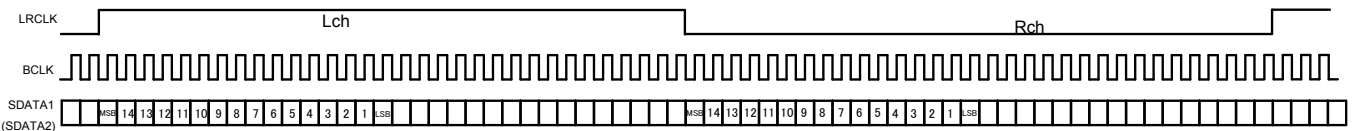
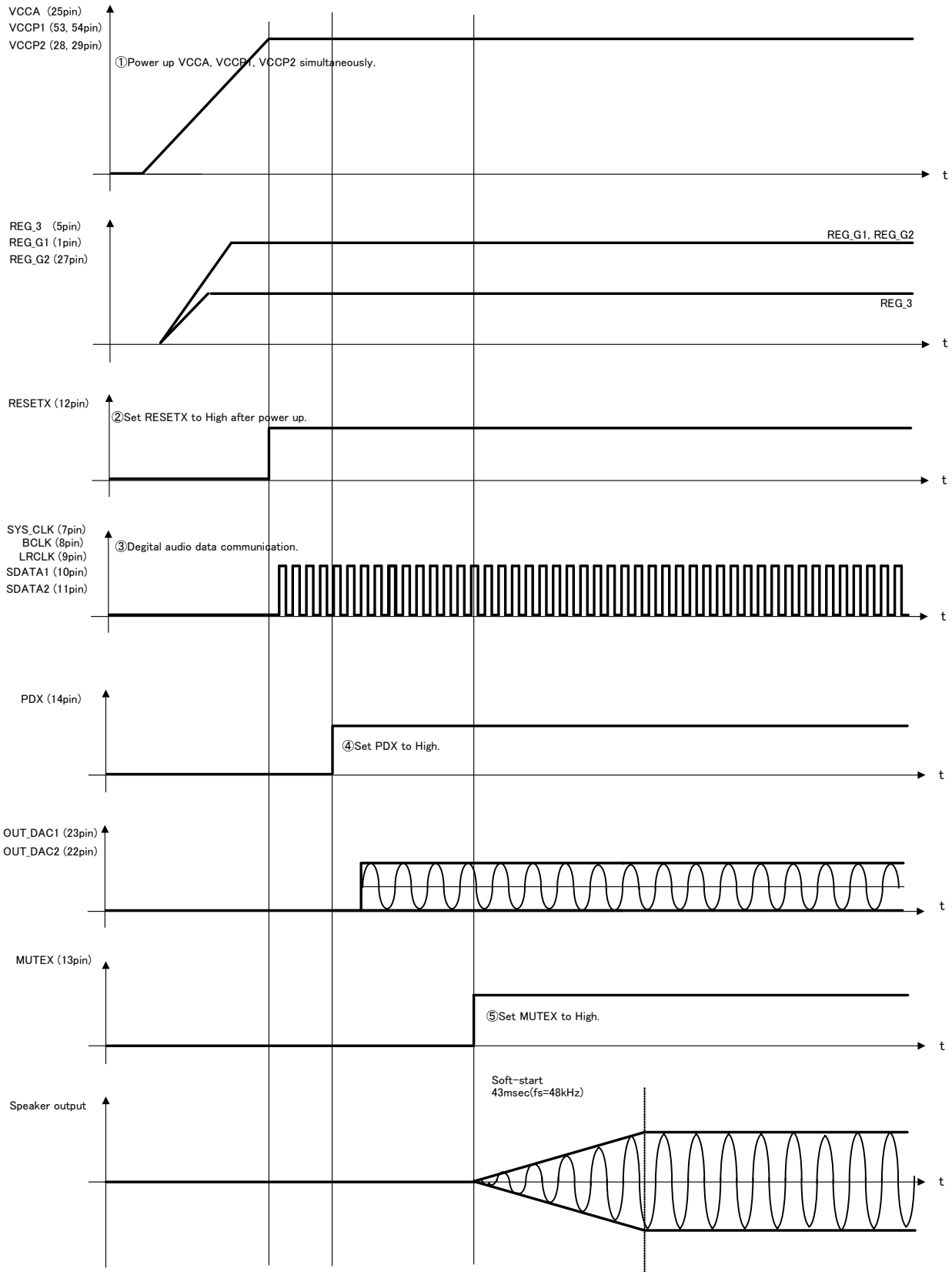

Fig.25 Left-Justified Data Format 64fs, 16 bit Data

The High section of LRCLK becomes Lch, the Low section of LRCLK becomes Rch.
After changing LRCLK, first bit becomes MSB.

●Power supply start-up sequence



● Power supply shut-down sequence

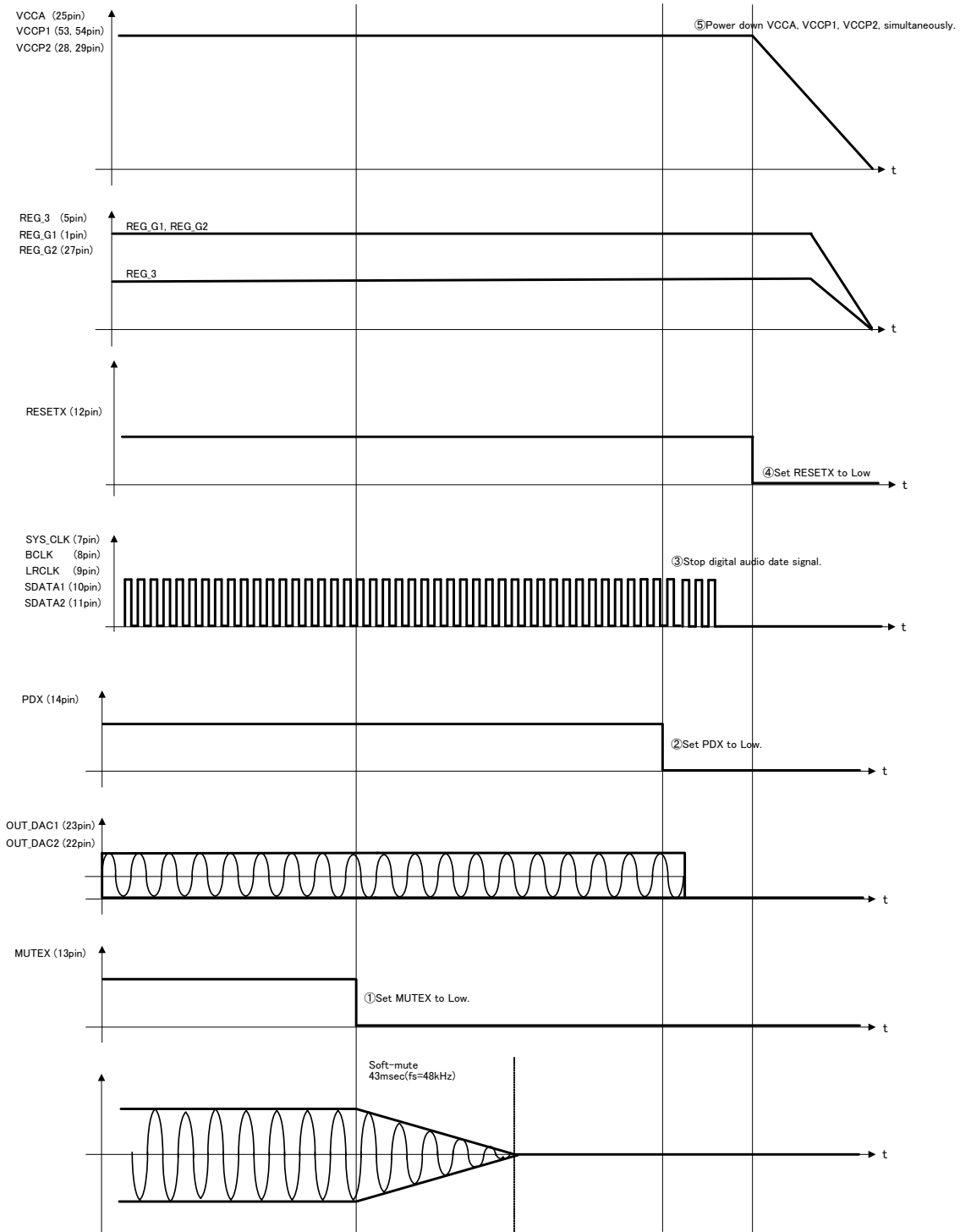

●About the protection function

Protection function	Detecting & Releasing condition		DAC Output	PWM Output	ERROR Output
Output short protection	Detecting condition	Detecting current = 10A (TYP.)	Normal operation	HiZ_Low (Latch)	L (Latch)
DC voltage protection in the speaker	Detecting condition	PWM output Duty=0% or 100% 43msec(fs=48kHz) above fixed		HiZ_Low (Latch)	L (Latch)
High temperature protection	Detecting condition	Chip temperature to be above 150°C (TYP.)	Normal operation	HiZ_Low	H
	Releasing condition	Chip temperature to be below 120°C (TYP.)		Normal operation	
Under voltage protection	Detecting condition	Power supply voltage to be below 8V (TYP.)	Normal operation	HiZ_Low	H
	Releasing condition	Power supply voltage to be above 9V (TYP.)		Normal operation	
Clock stop protection	Detecting condition	No change to SYS_CLK more than 1usec (TYP.)	Irregular output	HiZ_Low	H
	Releasing condition	Normal input to SYS_CLK	Normal operation	Normal operation	

* The ERROR pin is Nch open-drain output.

* Once an IC is latched, the circuit is not released automatically even after an abnormal status is removed.

The following procedures ① or ② is available for recovery.

①After the MUTEX pin is made Low once, the MUTEX pin is returned to High again.

②Turning on the power supply again.

1) High temperature protection

This IC has the high temperature protection circuit that prevents thermal reckless driving under an abnormal state for the temperature of the chip to exceed $T_{jmax}=150^{\circ}\text{C}$.

Detecting condition - It will detect when MUTE pin is set High and the temperature of the chip becomes 150°C (TYP.) or more. The speaker output is muted through a soft-mute when detected.

Releasing condition - It will release when MUTE pin is set High and the temperature of the chip becomes 120°C (TYP.) or less. The speaker output is outputted through a soft-start when released.

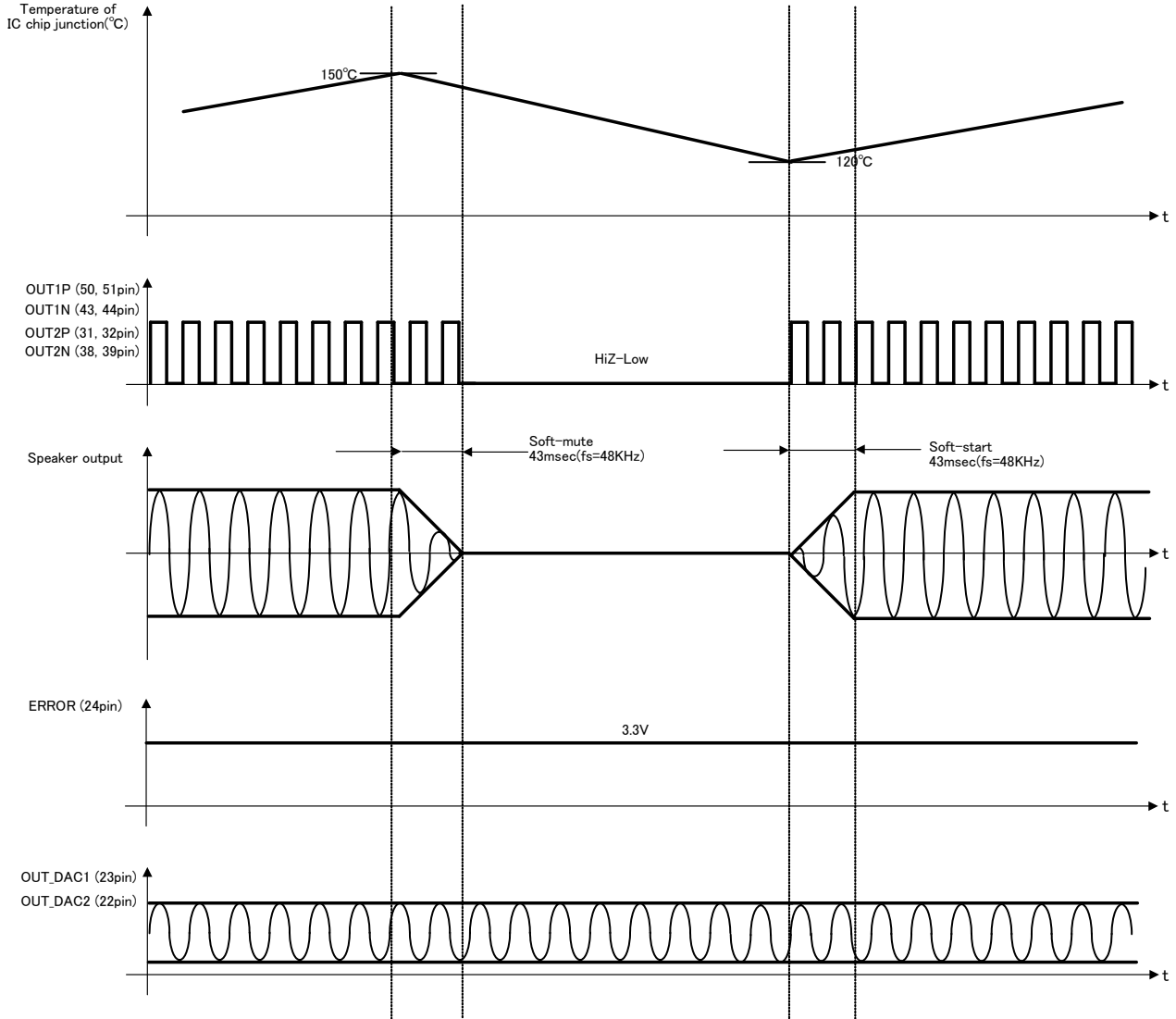

2) Under voltage protection

This IC has the under voltage protection circuit that make speaker output mute once detecting extreme drop of the power supply voltage.

Detecting condition – It will detect when MUTE pin is set High and the power supply voltage becomes lower than 8V. The speaker output is muted through a soft-mute when detected.

Releasing condition – It will release when MUTE pin is set High and the power supply voltage becomes more than 9V. The speaker output is outputted through a soft-start when released.

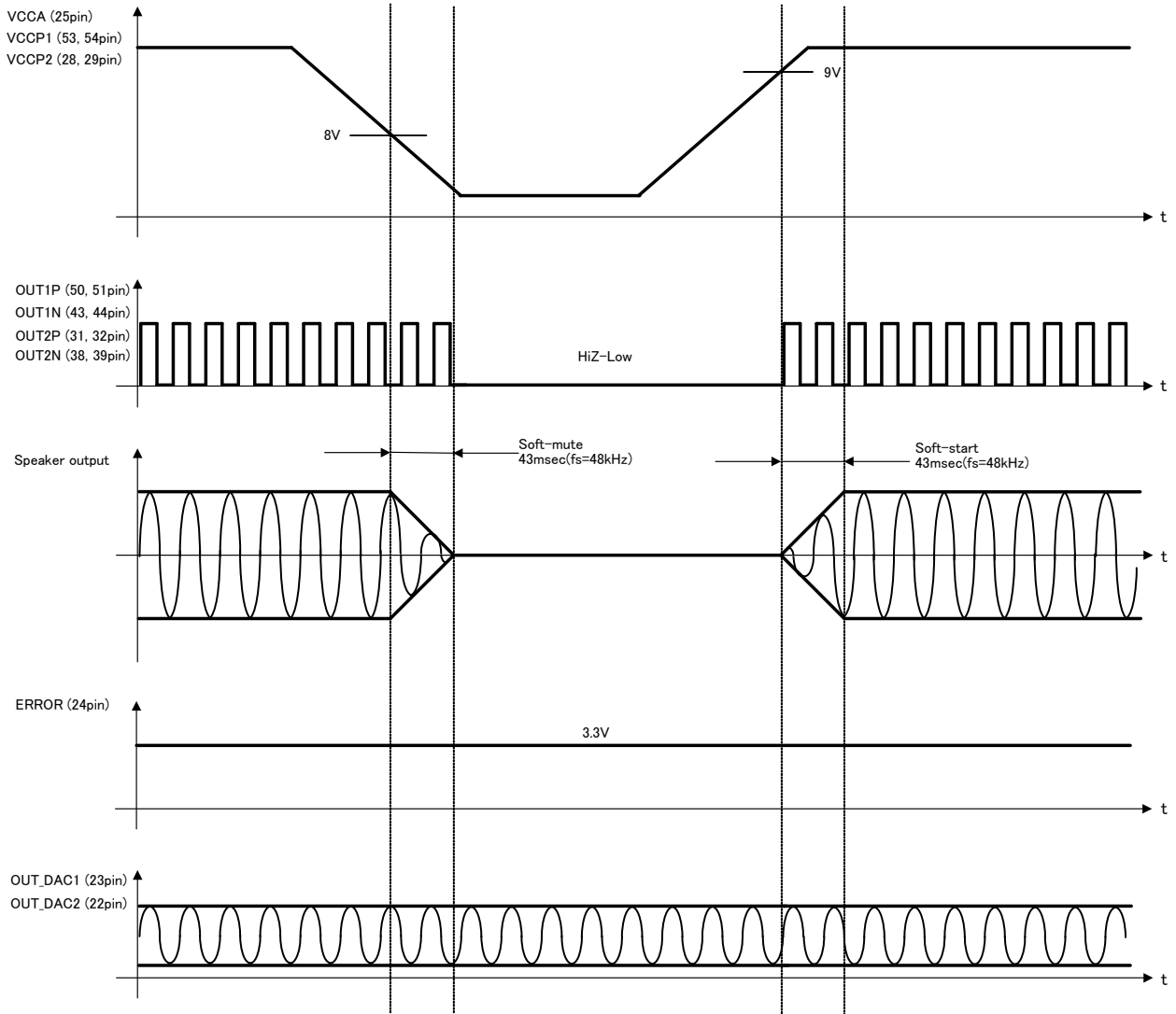

3) Clock stop protection

This IC has the clock stop protection circuit that make the speaker output mute when the SYS_CLK signal of the digital audio input stops.

Detecting condition - It will detect when MUTE pin is set High and the SYS_CLK signal stops for about 1usec or more. The speaker output is muted through a soft-mute when detected.

Releasing condition - It will release when MUTE pin is set High and the SYS_CLK signal returns to the normal clock operation. The speaker output is outputted through a soft-start when released.

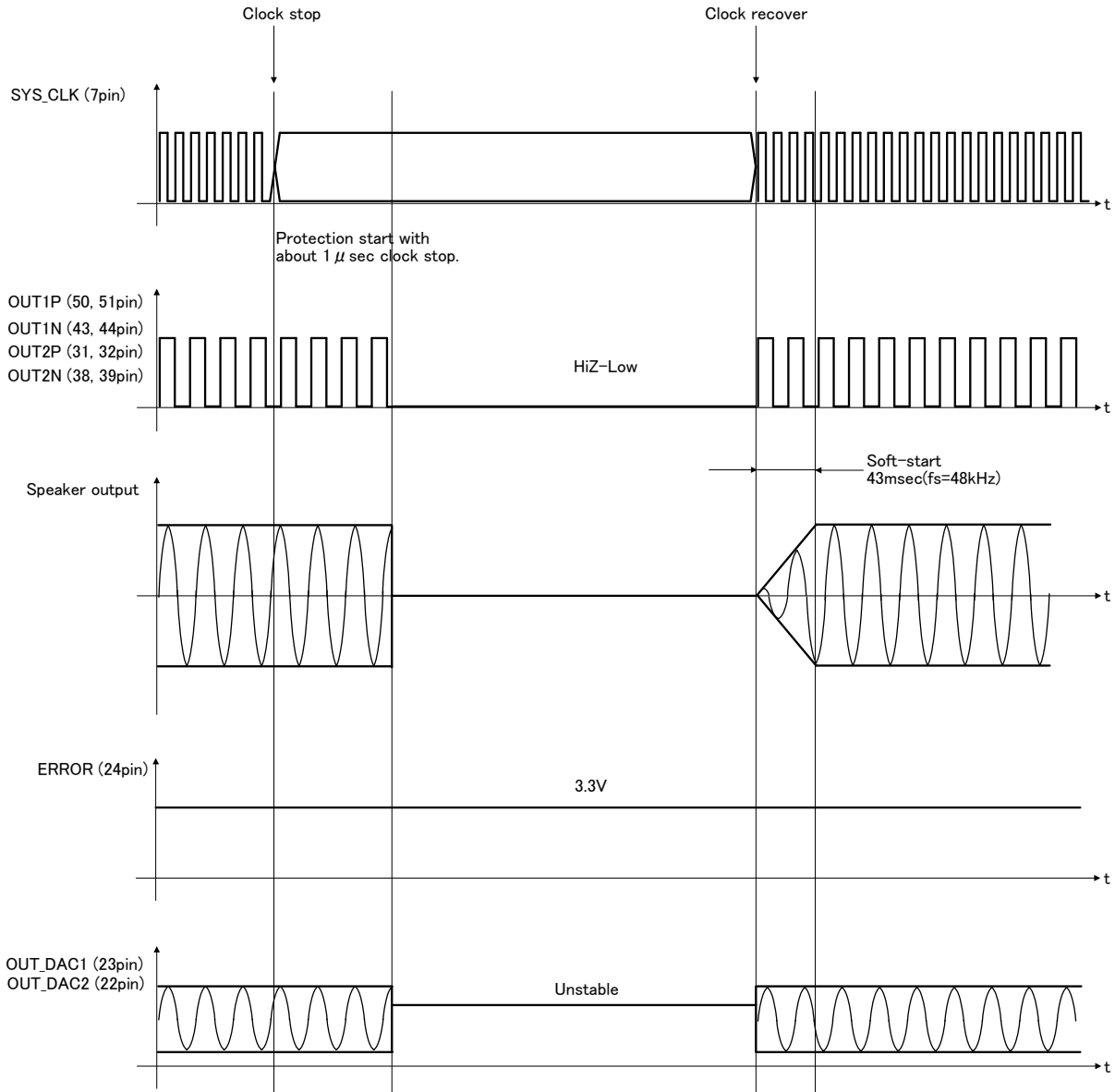

4) Output short protection(Short to the power supply)

This IC has the PWM output short protection circuit that stops the PWM output when the PWM output is short-circuited to the power supply due to abnormality.

Detecting condition - It will detect when MUTE pin is set High and the current that flows in the PWM output pin becomes 10A(TYP.) or more. The PWM output instantaneously enters the state of HiZ-Low if detected, and IC does the latch.

Releasing method - ①After the MUTEX pin is set Low once, the MUTEX pin is set High again.
②Turning on the power supply again.

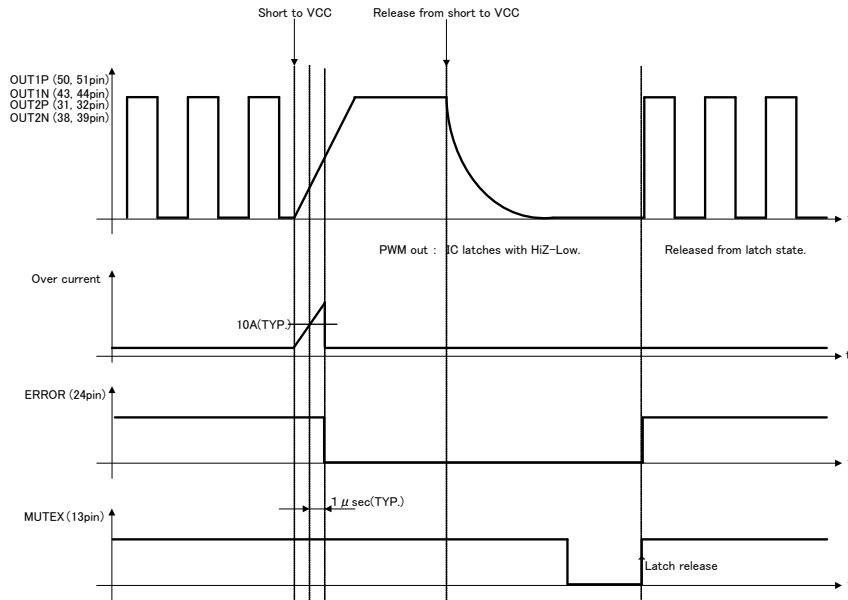

5) Output short protection(Short to GND)

This IC has the PWM output short protection circuit that stops the PWM output when the PWM output is short-circuited to GND due to abnormality.

Detecting condition - It will detect when MUTE pin is set High and the current that flows in the PWM output terminal becomes 10A(TYP.) or more. The PWM output instantaneously enters the state of HiZ-Low if detected, and IC does the latch.

Releasing method – ①After the MUTEX pin is set Low once, the MUTEX pin is set High again.
②Turning on the power supply again.

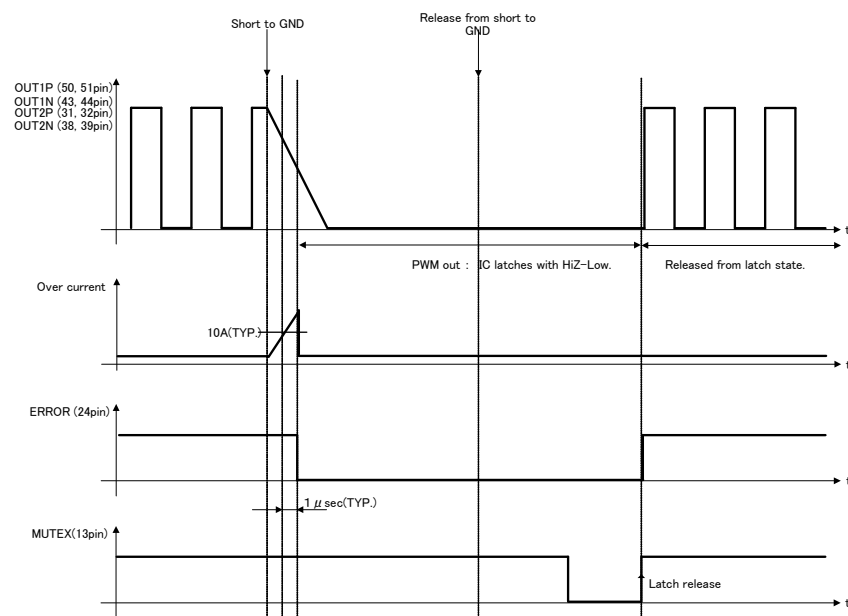

6) DC voltage protection in the speaker

When the DC voltage in the speaker is impressed due to abnormality, this IC has the protection circuit where the speaker is defended from destruction.

Detecting condition - It will detect when MUTE pin is set High or Low and PWM output Duty=0% or 100% , 43msec(fs=48kHz) or above. Once detected, The PWM output instantaneously enters the state of HiZ-Low, and IC does the latch.

Releasing method – ①After the MUTE pin is set Low once, the MUTE pin is set High again.
 ②Turning on the power supply again

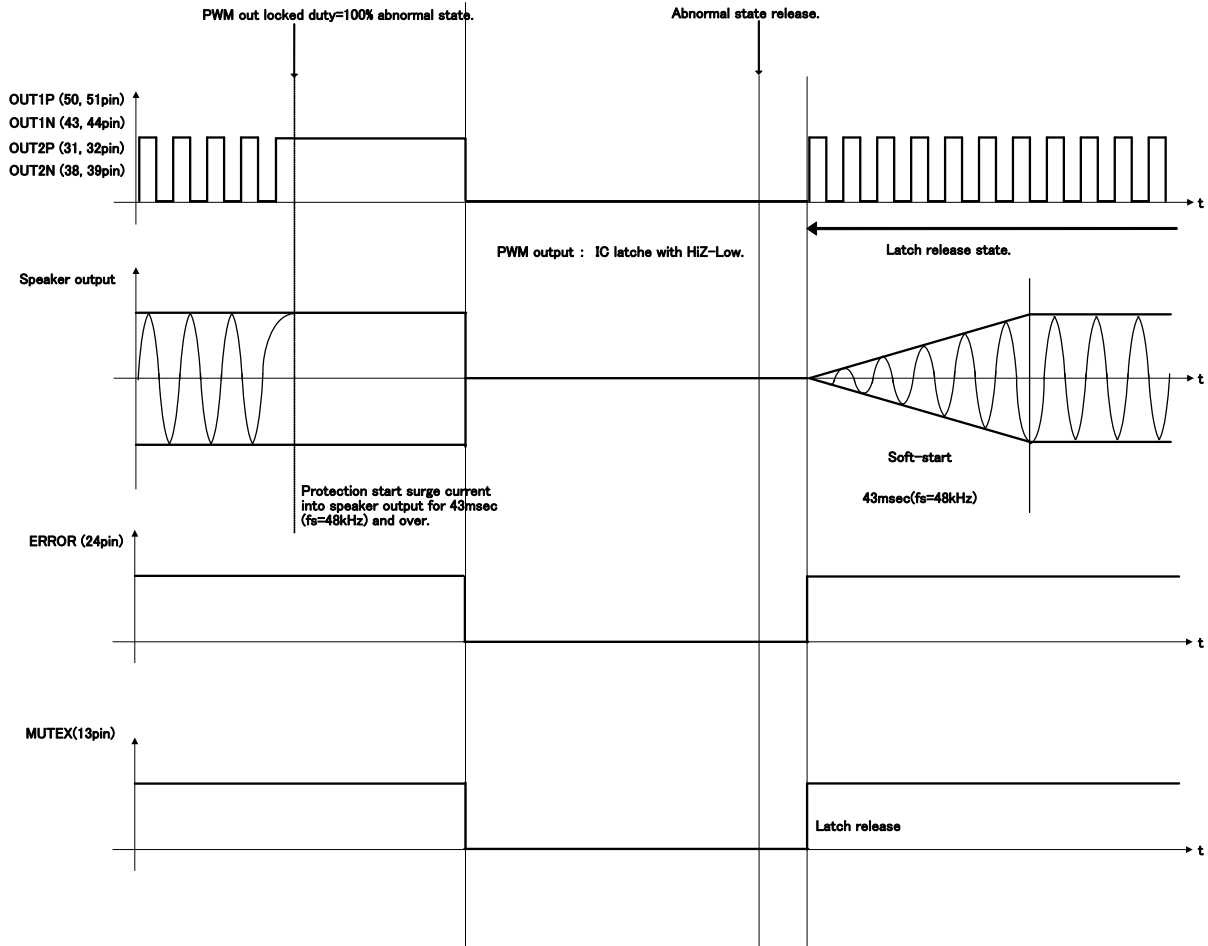

●Output power limiter function

This IC is provided with an output power limiter function to protect speakers from destruction by an excessive output. Limiter values are freely specified by changing external resistors R1/R2 as shown in Fig-26. Fig-27 shows a speaker output waveform that is generated with use of the output limiter function. Because the waveform is soft-clipped, unusual noises on audible signals are significantly reduced under operation of limiter.

Use resistors with a high degree of accuracy for R1 and R2 ($\pm 1\%$ or higher accuracy is recommended). The capacitor C is for the noise removal of output power limitation terminal (3pin). Provide grounding with a $1\mu\text{F}$ capacitor. Specify a resistor of $10\text{k}\Omega$ or higher resistor R1 and R2. If the output power limiter function is not used, R1, R2 and C is unnecessary. However, connect 3pin with GNDA.

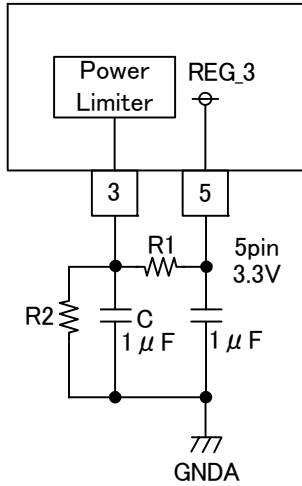

Fig-26

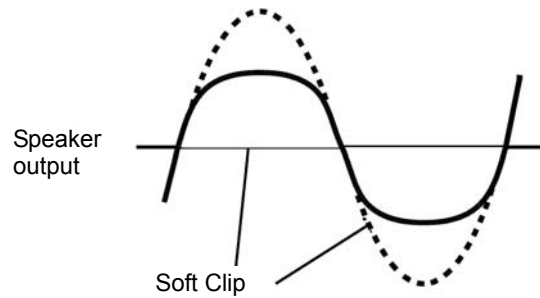

Fig-27

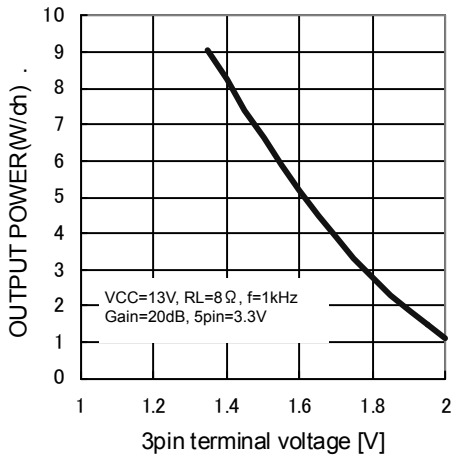
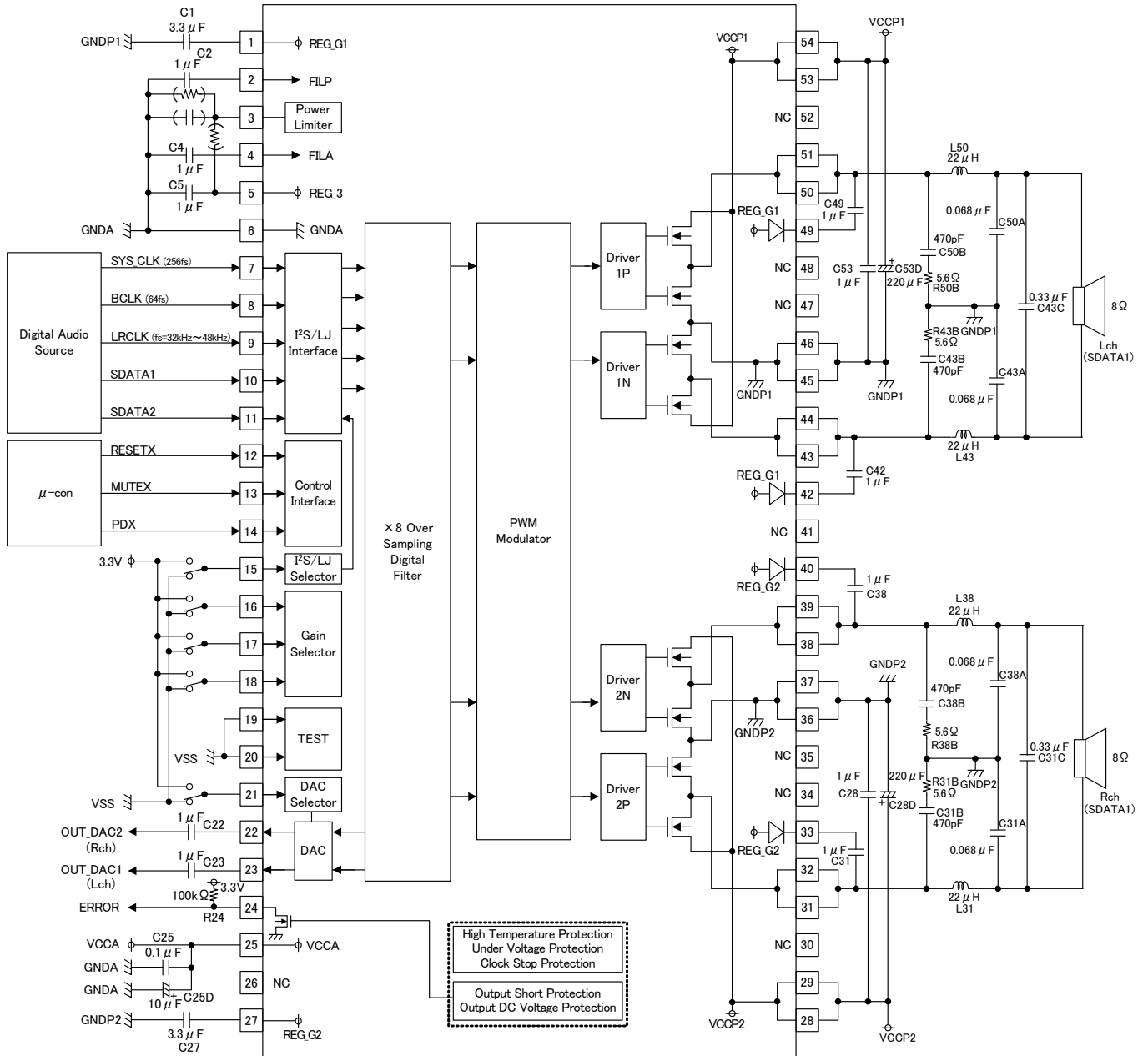

Fig.28

Output power
– 3pin terminal voltage

● Application Circuit Example (R_{L_SP}=8Ω)



●BOM list($R_{L, SP}=8\Omega$)

Parts	Parts No.	Value	Company	Product No.	Rated Voltage	Tolerance	Size
IC	U1	—	ROHM	BD5446EFV	—	—	18.5mm×9.5mm
Inductor	L31, L38, L43, L50	22μH	TOKO	1168ER-0001	-	(±20%)	10.3mm×7.6mm
			SAGAMI	DBE7210H-220M	-	(±20%)	10.5mm×6.4mm
Resistor	R31B, R38B R43B, R50B	5.6Ω	ROHM	MCR18PZHFL5R60	1/4W	F(±1%)	3.2mm×1.6mm
Capacitor	C31, C38, C42, C49	1μF	MURATA	GRM185B31C105KE43	16V	B(±10%)	1.6mm×0.8mm
	C25, C28, C53	0.1μF		GRM188B31H104KA92	50V	B(±10%)	1.6mm×0.8mm
	C31A, C38A C43A, C50A	0.068μF		GRM21BB11H683KA01	50V	B(±10%)	2.0mm×1.25mm
	C31C, C43C	0.33μF		GRM219B31H334KA87	50V	B(±10%)	2.0mm×1.25mm
	C1, C27	3.3μF		GRM188B31A335KE15	10V	B(±10%)	1.6mm×0.8mm
	C2, C4, C5 C22, C23	1μF		GRM185B30J105KE25	6.3V	B(±10%)	1.6mm×0.8mm
	C31B, C38B C43B, C50B	470pF		GRM188B11H471KA	50V	B(±10%)	2.0mm×1.2mm
Electrolytic Capacitor	C28D, C53D	220μF	Panasonic	ECA1VMH221	35V	±20%	φ8mm×11.5mm
	C25D	10μF		EEUFC1H100L	50V	±20%	φ5mm×11mm

●Application Circuit Example(R_{L_SP}=6Ω)

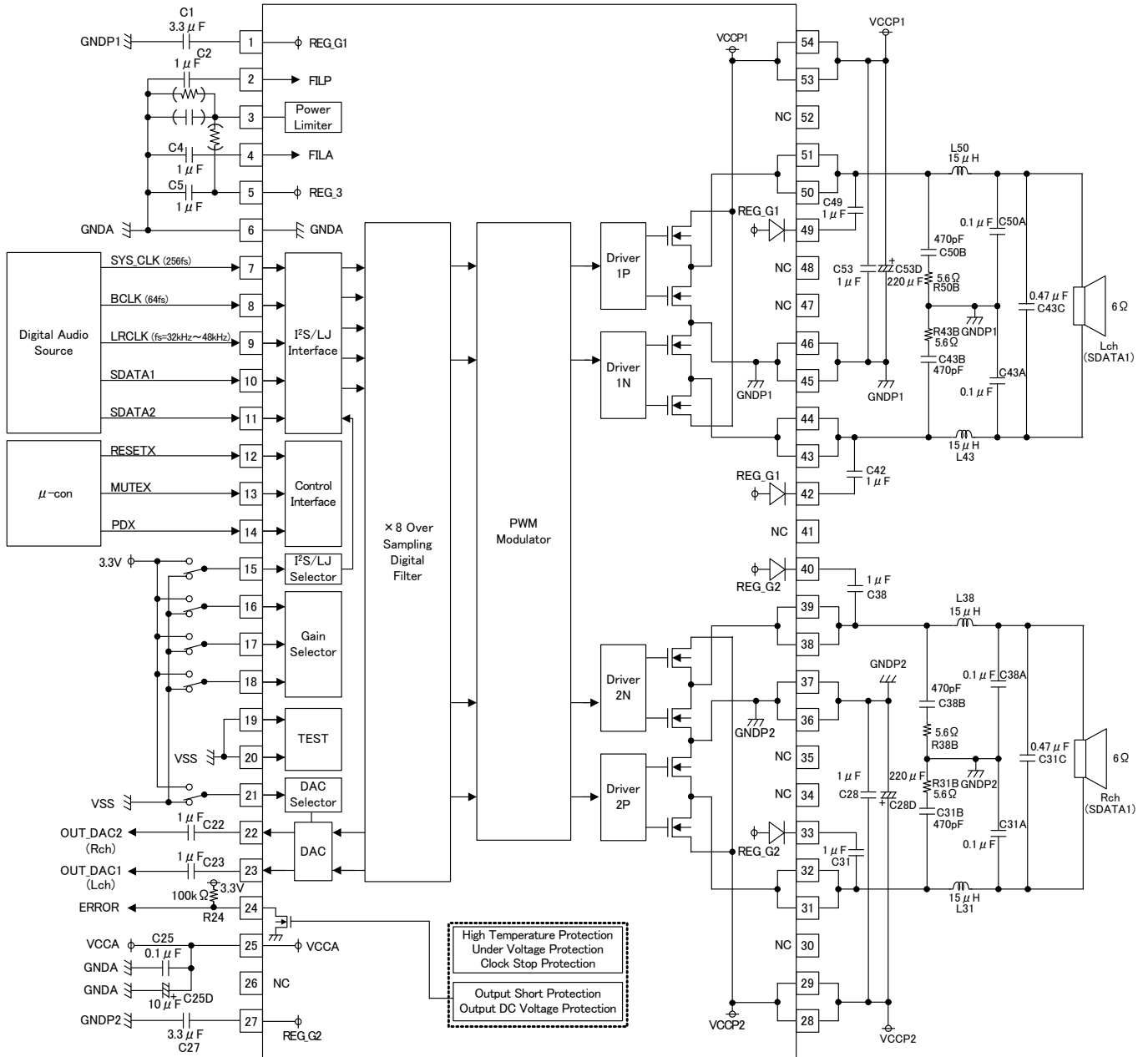

●BOM list($R_{L_SP}=6\Omega$)

Parts	Parts No.	Value	Company	Product No.	Rated Voltage	Tolerance	Size
IC	U1	—	ROHM	BD5446EFV	—	—	18.5mm×9.5mm
Inductor	L31, L38, L43, L50	15 μ H	SAGAMI	DBE7210H-150M	—	($\pm 20\%$)	10.5mm×6.4mm
Resistor	R31B, R38B R43B, R50B	5.6 Ω	ROHM	MCR18PZHFL5R60	1/4W	F($\pm 1\%$)	3.2mm×1.6mm
Capacitor	C31, C38, C42, C49	1 μ F	MURATA	GRM185B31C105KE43	16V	B($\pm 10\%$)	1.6mm×0.8mm
	C25, C28, C53, C31A, C38A, C43A, C48A	0.1 μ F		GRM188B31H104KA92	50V	B($\pm 10\%$)	1.6mm×0.8mm
	C31C, C43C	0.47 μ F		GRM21BB31H474KA87	50V	B($\pm 10\%$)	2.0mm×1.2mm
	C1, C27	3.3 μ F		GRM188B31A335KE15	10V	B($\pm 10\%$)	1.6mm×0.8mm
	C2, C4, C5 C22, C23	1 μ F		GRM185B30J105KE25	6.3V	B($\pm 10\%$)	1.6mm×0.8mm
	C31B, C38B C43B, C50B	470pF		GRM188B11H471KA	50V	B($\pm 10\%$)	2.0mm×1.2mm
Electrolytic Capacitor	C28D, C53D	220 μ F	Panasonic	ECA1VMH221	35V	$\pm 20\%$	$\phi 8$ mm×11.5mm
	C25D	10 μ F		EEUFC1H100L	50V	$\pm 20\%$	$\phi 5$ mm×11mm

●Output LC Filter Circuit

An output filter is required to eliminate radio-frequency components exceeding the audio-frequency region supplied to a load (speaker). Because this IC uses sampling clock frequencies from 200kHz to 400kHz in the output PWM signals, the high-frequency components must be appropriately removed.

This section takes an example of an LC type LPF shown in Fig.29, in which coil L and capacitor C compose a differential filter with an attenuation property of -12dB/oct. A large part of switching currents flow to capacitor C, and only a small part of the currents flow to speaker R_L . This filter reduces unwanted emission this way. In addition, coil L and capacitor C_g compose a filter against in-phase components, reducing unwanted emission further.

Filter constants depend on load impedances. The following are formulas to calculate values of L, C, and C_g when $Q=0.707$ is specified.

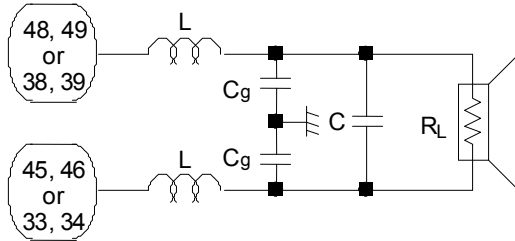

Fig. 29

$$L = \frac{R_L \sqrt{2}}{4 \pi f_c} \text{ (H)}$$

$$C = \frac{1}{2 \pi f_c R_L \sqrt{2}} \text{ (F)}$$

$$C_g = 0.2 C \text{ (F)}$$

R_L : Load impedance (Ω)
 f_c : LPF cut off frequency (Hz)

Following presents output LC filter constants with typical load impedances.

$f_c = 30\text{kHz}$				$f_c = 40\text{kHz}$			
R_L	L	C	C_g	R_L	L	C	C_g
6 Ω	22 μH	0.68 μF	0.15 μF	6 Ω	15 μH	0.47 μF	0.1 μF
8 Ω	33 μH	0.47 μF	0.1 μF	8 Ω	22 μH	0.33 μF	0.068 μF
16 Ω	68 μH	0.22 μF	0.047 μF	16 Ω	47 μH	0.15 μF	0.033 μF

Use coils with a low direct-current resistance and with a sufficient margin of allowable currents. A high direct-current resistance causes power losses. In addition, select a closed magnetic circuit type product in normal cases to prevent unwanted emission.

Use capacitors with a low equivalent series resistance, and good impedance characteristics at high frequency ranges (100kHz or higher). Also, select an item with sufficient withstand voltage because flowing massive amount of high-frequency currents is expected.

●Notes for use

- 1) Absolute maximum ratings
Use of the IC in excess of absolute maximum ratings such as the applied voltage or operating temperature range may result in IC damage. Assumptions should not be made regarding the state of the IC (short mode or open mode) when such damage is suffered. A physical safety measure such as a fuse should be implemented when use of the IC in a special mode where the absolute maximum ratings may be exceeded is anticipated.
- 2) Power supply lines
As return of current regenerated by back EMF of output coil happens, take steps such as putting capacitor between power supply and GND as a electric pathway for the regenerated current. Be sure that there is no problem with each property such as emptied capacity at lower temperature regarding electrolytic capacitor to decide capacity value. If the connected power supply does not have sufficient current absorption capacity, regenerative current will cause the voltage on the power supply line to rise, which combined with the product and its peripheral circuitry may exceed the absolute maximum ratings. It is recommended to implement a physical safety measure such as the insertion of a voltage clamp diode between the power supply and GND pins.
- 3) GND potential(Pin 6, 36, 37, 45, 46).
Any state must become the lowest voltage about GND terminal and VSS terminal.
- 4) Input terminal
The parasitic elements are formed in the IC because of the voltage relation. The parasitic element operating causes the wrong operation and destruction. Therefore, please be careful so as not to operate the parasitic elements by impressing to input terminals lower voltage than GND and VSS. Please do not apply the voltage to the input terminal when the power-supply voltage is not impressed.
- 5) Setting of heat
Use a thermal design that allows for a sufficient margin in light of the power dissipation (Pd) in actual operating conditions. This IC exposes its frame of the backside of package. Note that this part is assumed to use after providing heat dissipation treatment to improve heat dissipation efficiency. Try to occupy as wide as possible with heat dissipation pattern not only on the board surface but also the backside.
Class D speaker amplifier is high efficiency and low heat generation by comparison with conventional Analog power amplifier. However, In case it is operated continuously by maximum output power, Power dissipation (Pdiss) may exceed package dissipation. Please consider about heat design that Power dissipation (Pdiss) does not exceed Package dissipation (Pd) in average power (Poav). (Tjmax : Maximum junction temperature=150°C, Ta : Peripheral temperature[°C], θja : Thermal resistance of package[°C/W], Poav : Average power[W], η : Efficiency)
Package dissipation : Pd(W)=(Tjmax - Ta)/θja
Power dissipation : Pdiss(W)= Poav × (1/η - 1)
- 6) Actions in strong magnetic field
Use caution when using the IC in the presence of a strong magnetic field as doing so may cause the IC to malfunction.
- 7) Thermal shutdown circuit
This product is provided with a built-in thermal shutdown circuit. When the thermal shutdown circuit operates, the output transistors are placed under open status. The thermal shutdown circuit is primarily intended to shut down the IC avoiding thermal runaway under abnormal conditions with a chip temperature exceeding Tjmax = 150°C.
- 8) Shorts between pins and misinstallation
When mounting the IC on a board, pay adequate attention to orientation and placement discrepancies of the IC. If it is misinstalled and the power is turned on, the IC may be damaged. It also may be damaged if it is shorted by a foreign substance coming between pins of the IC or between a pin and a power supply or a pin and a GND.
- 9) Power supply on/off (Pin 25, 28, 29, 53, 54)
In case power supply is started up, RESETX(Pin 12), MUTEX(Pin 13) and PDX (Pin 14) always should be set Low. And in case power supply is shut down, it should be set Low likewise. Then it is possible to eliminate pop noise when power supply is turned on/off. And also, all power supply terminals should start up and shut down together.
- 10) ERROR terminal(Pin 24)
A error flag is outputted when Output short protection and DC voltage protection in the speaker are operated. These flags are the function which the condition of this product is shown in.
- 11) N.C. terminal(Pin 26, 30, 34, 35, 41, 47, 48, 52)
N.C. terminal (Non Connection Pin) does not connect to the inside circuit. Therefore, possible to use open.
- 12) TEST terminal(Pin 19, 20)
TEST terminal connects with ground to prevent the malfunction by external noise.
- 13) Precautions for Spealer-setting
If the impedance characteristics of the speakers at high-frequency range while increase rapidly, the IC might not have stable-operation in the resonance frequency range of the LC-filter. Therefore, consider adding damping-circuit, etc., depending on the impedance of the speaker.

● Allowable Power Dissipation

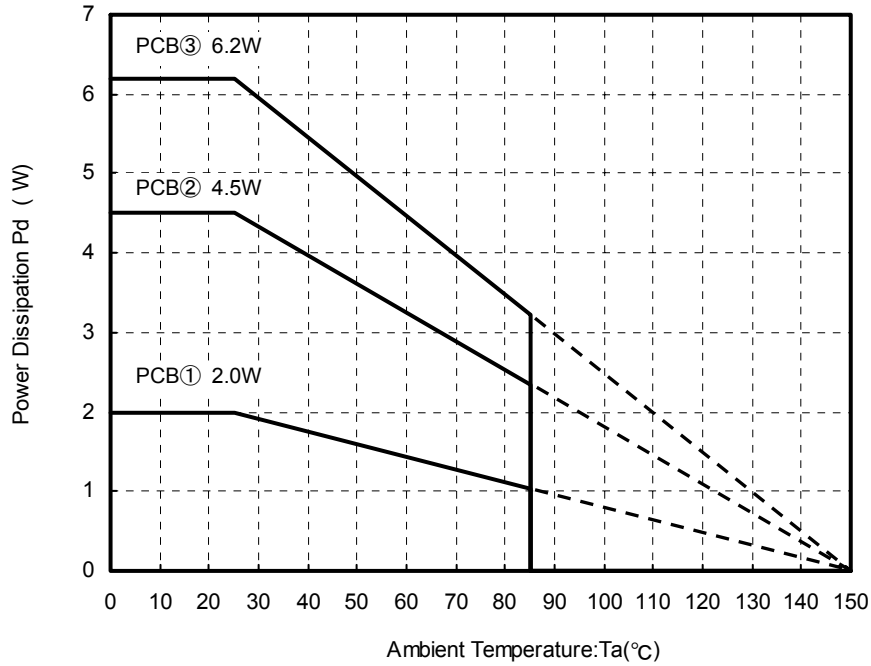

Measuring instrument : TH-156(Shibukawa Kuwano Electrical Instruments Co., Ltd.)

Measuring conditions : Installation on ROHM's board

Board size : 70mm×70mm×1.6mm(with thermal via on board)

Material : FR4

• The board on exposed heat sink on the back of package are connected by soldering.

PCB① : 1-layer board(back copper foil size: 0mm×0mm), $\theta_{ja}=62.5^{\circ}\text{C}/\text{W}$

PCB② : 2-layer board(back copper foil size: 70mm×70mm), $\theta_{ja}=27.8^{\circ}\text{C}/\text{W}$

PCB③ : 4-layer board(back copper foil size: 70mm×70mm), $\theta_{ja}=20.2^{\circ}\text{C}/\text{W}$

●Ordering part number

B	D
---	---

Part No.

5	4	4	6
---	---	---	---

Part No.

E	F	V
---	---	---

Package
EFV : HTSSOP-B54

E	2
---	---

Packaging and forming specification
E2: Embossed tape and reel

HTSSOP-B54

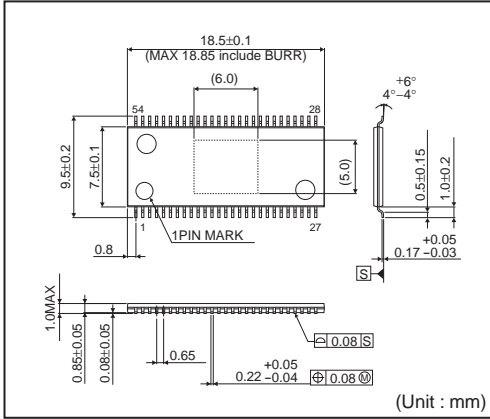

<Tape and Reel information>

Tape	Embossed carrier tape (with dry pack)
Quantity	1500pcs
Direction of feed	E2 (The direction is the 1pin of product is at the upper left when you hold reel on the left hand and you pull out the tape on the right hand)

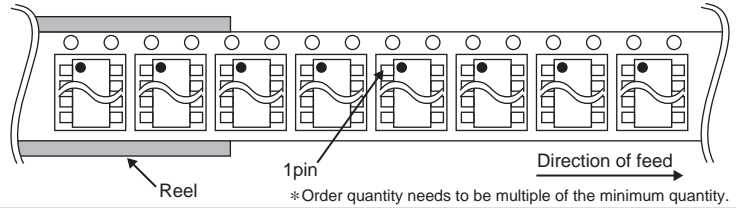

Notes

No copying or reproduction of this document, in part or in whole, is permitted without the consent of ROHM Co.,Ltd.

The content specified herein is subject to change for improvement without notice.

The content specified herein is for the purpose of introducing ROHM's products (hereinafter "Products"). If you wish to use any such Product, please be sure to refer to the specifications, which can be obtained from ROHM upon request.

Examples of application circuits, circuit constants and any other information contained herein illustrate the standard usage and operations of the Products. The peripheral conditions must be taken into account when designing circuits for mass production.

Great care was taken in ensuring the accuracy of the information specified in this document. However, should you incur any damage arising from any inaccuracy or misprint of such information, ROHM shall bear no responsibility for such damage.

The technical information specified herein is intended only to show the typical functions of and examples of application circuits for the Products. ROHM does not grant you, explicitly or implicitly, any license to use or exercise intellectual property or other rights held by ROHM and other parties. ROHM shall bear no responsibility whatsoever for any dispute arising from the use of such technical information.

The Products specified in this document are intended to be used with general-use electronic equipment or devices (such as audio visual equipment, office-automation equipment, communication devices, electronic appliances and amusement devices).

The Products specified in this document are not designed to be radiation tolerant.

While ROHM always makes efforts to enhance the quality and reliability of its Products, a Product may fail or malfunction for a variety of reasons.

Please be sure to implement in your equipment using the Products safety measures to guard against the possibility of physical injury, fire or any other damage caused in the event of the failure of any Product, such as derating, redundancy, fire control and fail-safe designs. ROHM shall bear no responsibility whatsoever for your use of any Product outside of the prescribed scope or not in accordance with the instruction manual.

The Products are not designed or manufactured to be used with any equipment, device or system which requires an extremely high level of reliability the failure or malfunction of which may result in a direct threat to human life or create a risk of human injury (such as a medical instrument, transportation equipment, aerospace machinery, nuclear-reactor controller, fuel-controller or other safety device). ROHM shall bear no responsibility in any way for use of any of the Products for the above special purposes. If a Product is intended to be used for any such special purpose, please contact a ROHM sales representative before purchasing.

If you intend to export or ship overseas any Product or technology specified herein that may be controlled under the Foreign Exchange and the Foreign Trade Law, you will be required to obtain a license or permit under the Law.



Thank you for your accessing to ROHM product informations.
More detail product informations and catalogs are available, please contact us.

ROHM Customer Support System

<http://www.rohm.com/contact/>

Компания «Океан Электроники» предлагает заключение долгосрочных отношений при поставках импортных электронных компонентов на взаимовыгодных условиях!

Наши преимущества:

- Поставка оригинальных импортных электронных компонентов напрямую с производств Америки, Европы и Азии, а так же с крупнейших складов мира;
- Широкая линейка поставок активных и пассивных импортных электронных компонентов (более 30 млн. наименований);
- Поставка сложных, дефицитных, либо снятых с производства позиций;
- Оперативные сроки поставки под заказ (от 5 рабочих дней);
- Экспресс доставка в любую точку России;
- Помощь Конструкторского Отдела и консультации квалифицированных инженеров;
- Техническая поддержка проекта, помощь в подборе аналогов, поставка прототипов;
- Поставка электронных компонентов под контролем ВП;
- Система менеджмента качества сертифицирована по Международному стандарту ISO 9001;
- При необходимости вся продукция военного и аэрокосмического назначения проходит испытания и сертификацию в лаборатории (по согласованию с заказчиком);
- Поставка специализированных компонентов военного и аэрокосмического уровня качества (Xilinx, Altera, Analog Devices, Intersil, Interpoint, Microsemi, Actel, Aeroflex, Peregrine, VPT, Syfer, Eurofarad, Texas Instruments, MS Kennedy, Miteq, Cobham, E2V, MA-COM, Hittite, Mini-Circuits, General Dynamics и др.);

Компания «Океан Электроники» является официальным дистрибьютором и эксклюзивным представителем в России одного из крупнейших производителей разъемов военного и аэрокосмического назначения «JONHON», а так же официальным дистрибьютором и эксклюзивным представителем в России производителя высокотехнологичных и надежных решений для передачи СВЧ сигналов «FORSTAR».



JONHON

«JONHON» (основан в 1970 г.)

Разъемы специального, военного и аэрокосмического назначения:

(Применяются в военной, авиационной, аэрокосмической, морской, железнодорожной, горно- и нефтедобывающей отраслях промышленности)

«FORSTAR» (основан в 1998 г.)

ВЧ соединители, коаксиальные кабели, кабельные сборки и микроволновые компоненты:

(Применяются в телекоммуникациях гражданского и специального назначения, в средствах связи, РЛС, а так же военной, авиационной и аэрокосмической отраслях промышленности).



Телефон: 8 (812) 309-75-97 (многоканальный)

Факс: 8 (812) 320-03-32

Электронная почта: ocean@oceanchips.ru

Web: <http://oceanchips.ru/>

Адрес: 198099, г. Санкт-Петербург, ул. Калинина, д. 2, корп. 4, лит. А