

NXH80T120L2Q0S2G/S2TG, NXH80T120L2Q0P2G

Q0PACK Module

The NXH80T120L2Q0S2/P2G is a power module containing a T-type neutral point clamped (NPC) three level inverter stage. The integrated field stop trench IGBTs and fast recovery diodes provide lower conduction losses and switching losses, enabling designers to achieve high efficiency and superior reliability.

Features

- Low Switching Loss
- Low V_{CESAT}
- Compact 65.9 mm x 32.5 mm x 12 mm Package
- Thermistor
- Options with pre-applied thermal interface material (TIM) and without pre-applied TIM
- Options with solderable pins and press-fit pins

Typical Applications

- Solar Inverter
- Uninterruptable Power Supplies

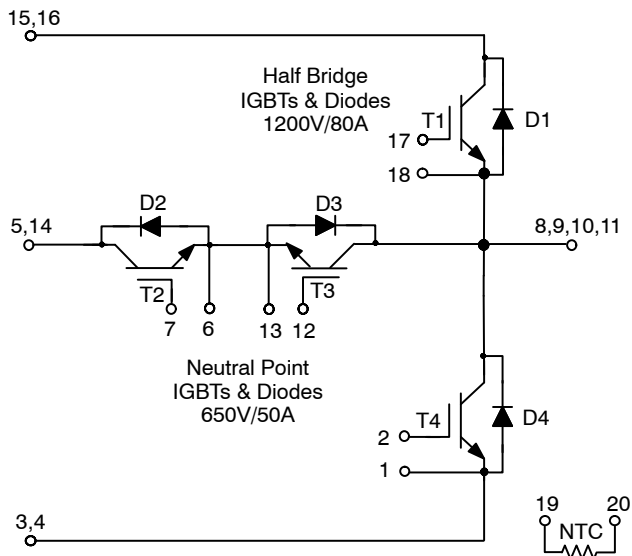
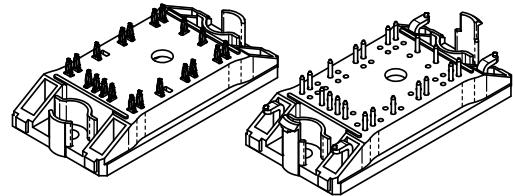

Figure 1. Schematic Diagram



ON Semiconductor®

www.onsemi.com



Q0PACK
CASE 180AA
PRESS-FIT PINS

Q0PACK
CASE 180AB
SOLDERABLE PINS

MARKING DIAGRAMS

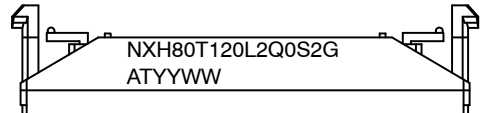
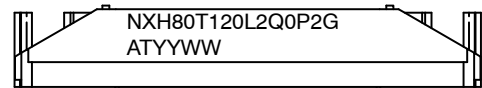

NXH80T120L2Q0S2G = Specific Device Code
G = Pb-free Package
A = Assembly Site Code
T = Test Site Code
YYWW = Year and Work Week Code

PIN ASSIGNMENTS

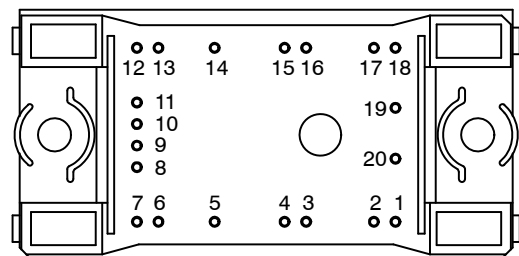

ORDERING INFORMATION

See detailed ordering and shipping information in the dimensions section on page 13 of this data sheet.

NXH80T120L2Q0S2G/S2TG, NXH80T120L2Q0P2G

Table 1. MAXIMUM RATINGS

Rating	Symbol	Value	Unit
HALF BRIDGE IGBT			
Collector–Emitter Voltage	V_{CES}	1200	V
Gate–Emitter Voltage	V_{GE}	± 20	V
Continuous Collector Current @ $T_h = 80^\circ\text{C}$ ($T_J = 175^\circ\text{C}$)	I_C	67	A
Pulsed Collector Current ($T_J = 175^\circ\text{C}$)	I_{Cpulse}	201	A
Maximum Power Dissipation @ $T_h = 80^\circ\text{C}$ ($T_J = 175^\circ\text{C}$)	P_{tot}	158	W
Short Circuit Withstand Time @ $V_{GE} = 15\text{ V}$, $V_{CE} = 600\text{ V}$, $T_J \leq 150^\circ\text{C}$	T_{sc}	5	μs
Minimum Operating Junction Temperature	T_{JMIN}	-40	$^\circ\text{C}$
Maximum Operating Junction Temperature	T_{JMAX}	150	$^\circ\text{C}$

NEUTRAL POINT IGBT			
Collector–Emitter Voltage	V_{CES}	600	V
Gate–Emitter Voltage	V_{GE}	± 20	V
Continuous Collector Current @ $T_h = 80^\circ\text{C}$ ($T_J = 175^\circ\text{C}$)	I_C	49	A
Pulsed Collector Current ($T_J = 175^\circ\text{C}$)	I_{Cpulse}	147	A
Maximum Power Dissipation @ $T_h = 80^\circ\text{C}$ ($T_J = 175^\circ\text{C}$)	P_{tot}	86	W
Short Circuit Withstand Time @ $V_{GE} = 15\text{ V}$, $V_{CE} = 400\text{ V}$, $T_J \leq 150^\circ\text{C}$	T_{sc}	5	μs
Minimum Operating Junction Temperature	T_{JMIN}	-40	$^\circ\text{C}$
Maximum Operating Junction Temperature	T_{JMAX}	150	$^\circ\text{C}$

HALF BRIDGE DIODE			
Peak Repetitive Reverse Voltage	V_{RRM}	1200	V
Continuous Forward Current @ $T_h = 80^\circ\text{C}$ ($T_J = 175^\circ\text{C}$)	I_F	28	A
Repetitive Peak Forward Current ($T_J = 175^\circ\text{C}$, t_p limited by T_{Jmax})	I_{FRM}	84	A
Maximum Power Dissipation @ $T_h = 80^\circ\text{C}$ ($T_J = 175^\circ\text{C}$)	P_{tot}	73	W
Minimum Operating Junction Temperature	T_{JMIN}	-40	$^\circ\text{C}$
Maximum Operating Junction Temperature	T_{JMAX}	150	$^\circ\text{C}$

NEUTRAL POINT DIODE			
Peak Repetitive Reverse Voltage	V_{RRM}	650	V
Continuous Forward Current @ $T_h = 80^\circ\text{C}$ ($T_J = 175^\circ\text{C}$)	I_F	33	A
Repetitive Peak Forward Current ($T_J = 175^\circ\text{C}$, t_p limited by T_{Jmax})	I_{FRM}	99	A
Maximum Power Dissipation @ $T_h = 80^\circ\text{C}$ ($T_J = 175^\circ\text{C}$)	P_{tot}	63	W
Minimum Operating Junction Temperature	T_{JMIN}	-40	$^\circ\text{C}$
Maximum Operating Junction Temperature	T_{JMAX}	150	$^\circ\text{C}$

THERMAL PROPERTIES			
Storage Temperature range	T_{stg}	-40 to 125	$^\circ\text{C}$

INSULATION PROPERTIES			
Isolation test voltage, $t = 1\text{ sec}$, 60 Hz	V_{is}	3000	V_{RMS}
Creepage distance		12.7	mm

Stresses exceeding those listed in the Maximum Ratings table may damage the device. If any of these limits are exceeded, device functionality should not be assumed, damage may occur and reliability may be affected.

1. Refer to ELECTRICAL CHARACTERISTICS, RECOMMENDED OPERATING RANGES and/or APPLICATION INFORMATION for Safe Operating parameters.

Table 2. RECOMMENDED OPERATING RANGES

Rating	Symbol	Min	Max	Unit
Module Operating Junction Temperature	T_J	-40	150	$^\circ\text{C}$

Functional operation above the stresses listed in the Recommended Operating Ranges is not implied. Extended exposure to stresses beyond the Recommended Operating Ranges limits may affect device reliability.

NXH80T120L2Q0S2G/S2TG, NXH80T120L2Q0P2G

Table 3. ELECTRICAL CHARACTERISTICS $T_J = 25^\circ\text{C}$ unless otherwise noted

Parameter	Test Conditions	Symbol	Min	Typ	Max	Unit	
HALF BRIDGE IGBT CHARACTERISTICS							
Collector–Emitter Cutoff Current	$V_{GE} = 0\text{ V}, V_{CE} = 1200\text{ V}$	I_{CES}	–	–	300	μA	
Collector–Emitter Saturation Voltage	$V_{GE} = 15\text{ V}, I_C = 80\text{ A}, T_J = 25^\circ\text{C}$	$V_{CE(sat)}$	–	2.05	2.85	V	
	$V_{GE} = 15\text{ V}, I_C = 80\text{ A}, T_J = 150^\circ\text{C}$		–	2.10	–		
Gate–Emitter Threshold Voltage	$V_{GE} = V_{CE}, I_C = 1.5\text{ mA}$	$V_{GE(TH)}$	–	5.45	6.4	V	
Gate Leakage Current	$V_{GE} = 20\text{ V}, V_{CE} = 0\text{ V}$	I_{GES}	–	–	300	nA	
Turn–on Delay Time	$T_J = 25^\circ\text{C}$ $V_{CE} = 350\text{ V}, I_C = 60\text{ A}$ $V_{GE} = \pm 15\text{ V}, R_G = 4.7\ \Omega$	$t_{d(on)}$	–	61	–	ns	
Rise Time		t_r	–	28	–		
Turn–off Delay Time		$t_{d(off)}$	–	205	–		
Fall Time		t_f	–	41	–		
Turn–on Switching Loss per Pulse		E_{on}	–	550	–		μJ
Turn off Switching Loss per Pulse		E_{off}	–	1100	–		
Turn–on Delay Time	$T_J = 125^\circ\text{C}$ $V_{CE} = 350\text{ V}, I_C = 60\text{ A}$ $V_{GE} = \pm 15\text{ V}, R_G = 4.7\ \Omega$	$t_{d(on)}$	–	58	–	ns	
Rise Time		t_r	–	30	–		
Turn–off Delay Time		$t_{d(off)}$	–	230	–		
Fall Time		t_f	–	63	–		
Turn–on Switching Loss per Pulse		E_{on}	–	720	–		μJ
Turn off Switching Loss per Pulse		E_{off}	–	1700	–		
Input Capacitance	$V_{CE} = 20\text{ V}, V_{GE} = 0\text{ V}, f = 10\text{ kHz}$	C_{ies}	–	19400	–	pF	
Output Capacitance		C_{oes}	–	400	–		
Reverse Transfer Capacitance		C_{res}	–	340	–		
Total Gate Charge	$V_{CE} = 600\text{ V}, I_C = 80\text{ A}, V_{GE} = +15\text{ V}$	Q_g	–	800	–	nC	
Thermal Resistance – chip–to–heatsink	Thermal grease, Thickness = $76\ \mu\text{m} \pm 2\%$, $\lambda = 2.9\text{ W/mK}$	R_{thJH}	–	0.60	–	$^\circ\text{C/W}$	

NEUTRAL POINT DIODE CHARACTERISTICS

Diode Forward Voltage	$I_F = 60\text{ A}, T_J = 25^\circ\text{C}$	V_F	–	1.7	2.2	V
	$I_F = 60\text{ A}, T_J = 150^\circ\text{C}$		–	1.6	–	
Reverse Recovery Time	$T_J = 25^\circ\text{C}$ $V_{CE} = 350\text{ V}, I_C = 60\text{ A}$ $V_{GE} = \pm 15\text{ V}, R_G = 4.7\ \Omega$	t_{rr}	–	39	–	ns
Reverse Recovery Charge		Q_{rr}	–	1.1	–	μC
Peak Reverse Recovery Current		I_{RRM}	–	48	–	A
Peak Rate of Fall of Recovery Current		di/dt	–	3400	–	$\text{A}/\mu\text{s}$
Reverse Recovery Energy		E_{rr}	–	400	–	μJ
Reverse Recovery Time		$T_J = 125^\circ\text{C}$ $V_{CE} = 350\text{ V}, I_C = 60\text{ A}$ $V_{GE} = \pm 15\text{ V}, R_G = 4.7\ \Omega$	t_{rr}	–	78	–
Reverse Recovery Charge	Q_{rr}		–	2.0	–	μC
Peak Reverse Recovery Current	I_{RRM}		–	59	–	A
Peak Rate of Fall of Recovery Current	di/dt		–	1600	–	$\text{A}/\mu\text{s}$
Reverse Recovery Energy	E_{rr}		–	550	–	μJ
Thermal Resistance – chip–to–heatsink	Thermal grease, Thickness = $76\ \mu\text{m} \pm 2\%$, $\lambda = 2.9\text{ W/mK}$		R_{thJH}	–	1.50	–

NEUTRAL POINT IGBT CHARACTERISTICS

Collector–Emitter Cutoff Current	$V_{GE} = 0\text{ V}, V_{CE} = 600\text{ V}$	I_{CES}	–	–	250	μA
Collector–Emitter Saturation Voltage	$V_{GE} = 15\text{ V}, I_C = 50\text{ A}, T_J = 25^\circ\text{C}$	$V_{CE(sat)}$	–	1.40	1.75	V
	$V_{GE} = 15\text{ V}, I_C = 50\text{ A}, T_J = 150^\circ\text{C}$		–	1.50	–	
Gate–Emitter Threshold Voltage	$V_{GE} = V_{CE}, I_C = 1.2\text{ mA}$	$V_{GE(TH)}$	–	5.45	6.4	V
Gate Leakage Current	$V_{GE} = 20\text{ V}, V_{CE} = 0\text{ V}$	I_{GES}	–	–	200	nA

NXH80T120L2Q0S2G/S2TG, NXH80T120L2Q0P2G

Table 3. ELECTRICAL CHARACTERISTICS $T_J = 25^\circ\text{C}$ unless otherwise noted

Parameter	Test Conditions	Symbol	Min	Typ	Max	Unit
NEUTRAL POINT IGBT CHARACTERISTICS						
Turn-on Delay Time	$T_J = 25^\circ\text{C}$ $V_{CE} = 350\text{ V}, I_C = 60\text{ A}$ $V_{GE} = \pm 15\text{ V}, R_G = 4.7\ \Omega$	$t_{d(on)}$	–	30	–	ns
Rise Time		t_r	–	19	–	
Turn-off Delay Time		$t_{d(off)}$	–	110	–	
Fall Time		t_f	–	23	–	
Turn-on Switching Loss per Pulse		E_{on}	–	800	–	μJ
Turn off Switching Loss per Pulse		E_{off}	–	480	–	
Turn-on Delay Time	$T_J = 125^\circ\text{C}$ $V_{CE} = 350\text{ V}, I_C = 60\text{ A}$ $V_{GE} = \pm 15\text{ V}, R_G = 4.7\ \Omega$	$t_{d(on)}$	–	32	–	ns
Rise Time		t_r	–	18	–	
Turn-off Delay Time		$t_{d(off)}$	–	120	–	
Fall Time		t_f	–	35	–	
Turn-on Switching Loss per Pulse		E_{on}	–	1100	–	μJ
Turn off Switching Loss per Pulse		E_{off}	–	880	–	
Input Capacitance	$V_{CE} = 20\text{ V}, V_{GE} = 0\text{ V}, f = 10\text{ kHz}$	C_{ies}	–	9400	–	pF
Output Capacitance		C_{oes}	–	280	–	
Reverse Transfer Capacitance		C_{res}	–	250	–	
Total Gate Charge	$V_{CE} = 480\text{ V}, I_C = 50\text{ A}, V_{GE} = +15\text{ V}$	Q_g	–	395	–	nC
Thermal Resistance – chip-to-heatsink	Thermal grease, Thickness = $76\ \mu\text{m} \pm 2\%$, $\lambda = 2.9\text{ W/mK}$	R_{thJH}	–	1.10	–	$^\circ\text{C/W}$

HALF BRIDGE DIODE CHARACTERISTICS

Diode Forward Voltage	$I_F = 40\text{ A}, T_J = 25^\circ\text{C}$	V_F	–	2.11	3.10	V
	$I_F = 40\text{ A}, T_J = 150^\circ\text{C}$		–	1.50	–	
Reverse recovery time	$T_J = 25^\circ\text{C}$ $V_{CE} = 350\text{ V}, I_C = 60\text{ A}$ $V_{GE} = \pm 15\text{ V}, R_G = 4.7\ \Omega$	t_{rr}	–	45	–	ns
Reverse recovery charge		Q_{rr}	–	2.7	–	μC
Peak reverse recovery current		I_{RRM}	–	110	–	A
Peak rate of fall of recovery current		di/dt	–	7100	–	$\text{A}/\mu\text{s}$
Reverse recovery energy		E_{rr}	–	1000	–	μJ
Reverse recovery time		$T_J = 125^\circ\text{C}$ $V_{CE} = 350\text{ V}, I_C = 60\text{ A}$ $V_{GE} = \pm 15\text{ V}, R_G = 4.7\ \Omega$	t_{rr}	–	185	–
Reverse recovery charge	Q_{rr}		–	6	–	μC
Peak reverse recovery current	I_{RRM}		–	150	–	A
Peak rate of fall of recovery current	di/dt		–	5900	–	$\text{A}/\mu\text{s}$
Reverse recovery energy	E_{rr}		–	1900	–	μJ
Thermal Resistance – chip-to-heatsink	Thermal grease, Thickness = $76\ \mu\text{m} \pm 2\%$, $\lambda = 2.9\text{ W/mK}$		R_{thJH}	–	1.30	–

THERMISTOR CHARACTERISTICS

Nominal resistance	$T = 25^\circ\text{C}$	R_{25}	–	22	–	k Ω
Nominal resistance	$T = 100^\circ\text{C}$	R_{100}	–	1486	–	Ω
Deviation of R25		$\Delta R/R$	–5	–	5	%
Power dissipation		P_D	–	200	–	mW
Power dissipation constant			–	2	–	mW/K
B-value	B(25/50), tolerance $\pm 3\%$		–	3950	–	K
B-value	B(25/100), tolerance $\pm 3\%$		–	3998	–	K

Product parametric performance is indicated in the Electrical Characteristics for the listed test conditions, unless otherwise noted. Product performance may not be indicated by the Electrical Characteristics if operated under different conditions.

NXH80T120L2Q0S2G/S2TG, NXH80T120L2Q0P2G

TYPICAL CHARACTERISTICS – Half Bridge IGBT and Neutral Point Diode

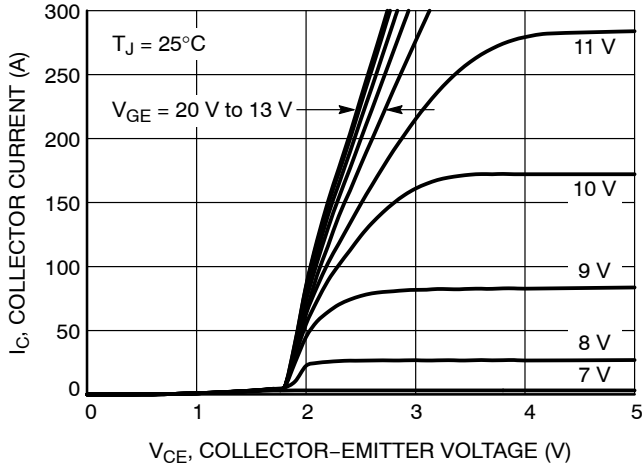

Figure 2. Typical Output Characteristics

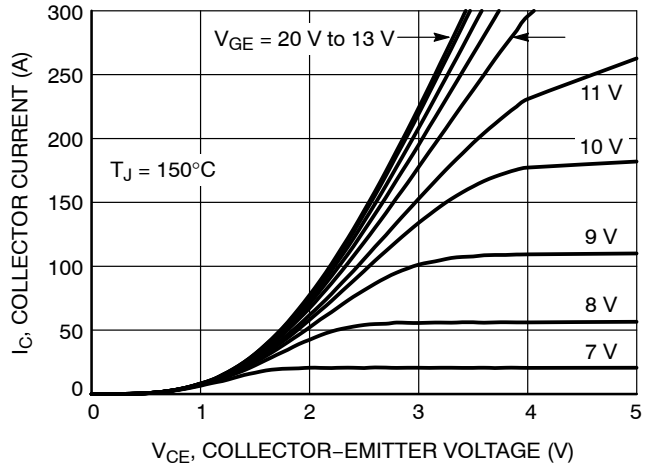

Figure 3. Typical Output Characteristics

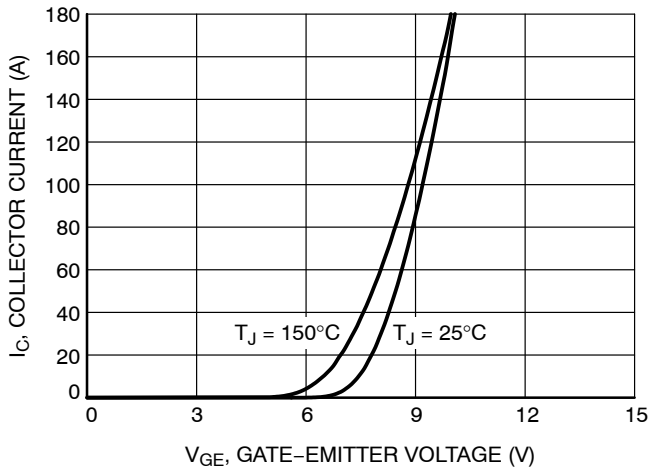

Figure 4. Typical Transfer Characteristics

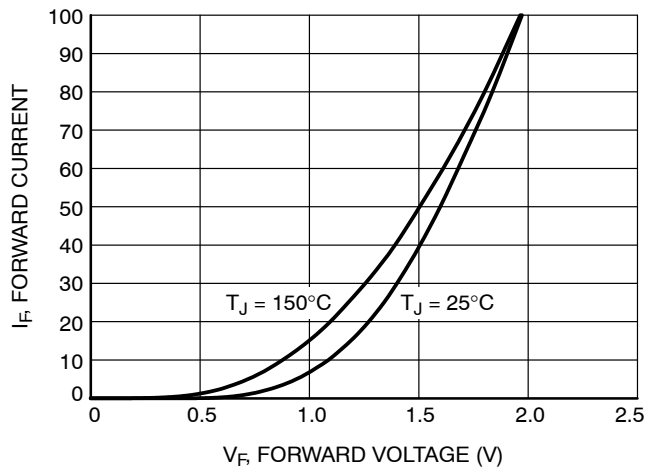

Figure 5. Diode Forward Characteristics

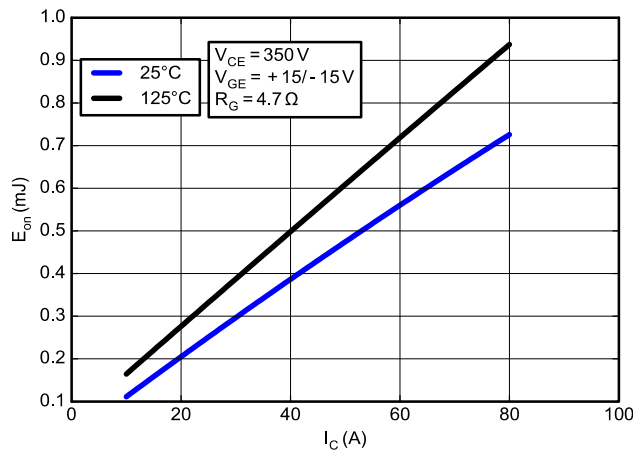

Figure 6. Typical Turn On Loss vs. IC

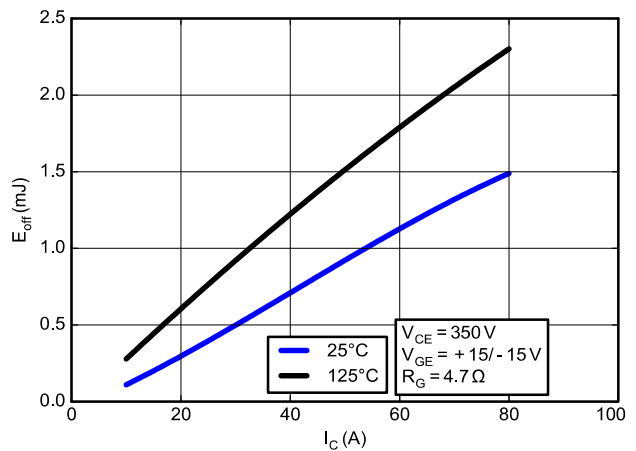

Figure 7. Typical Turn Off Loss vs. IC

NXH80T120L2Q0S2G/S2TG, NXH80T120L2Q0P2G

TYPICAL CHARACTERISTICS – Half Bridge IGBT and Neutral Point Diode

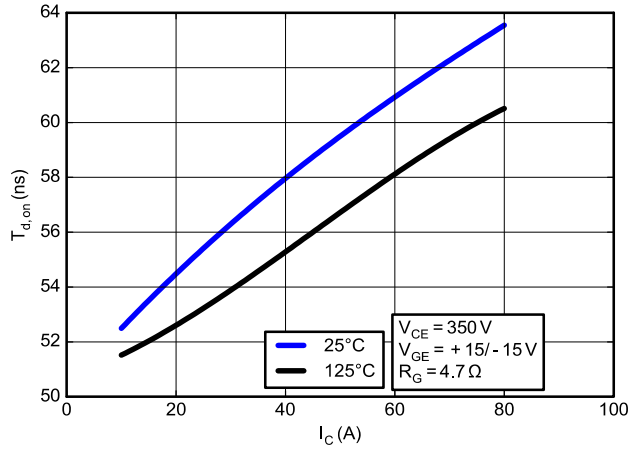

Figure 8. Typical On Switching Times vs. IC

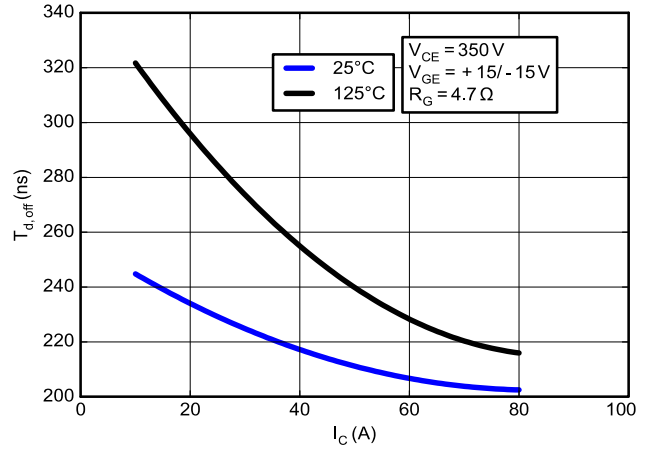

Figure 9. Typical Off Switching Times vs. IC

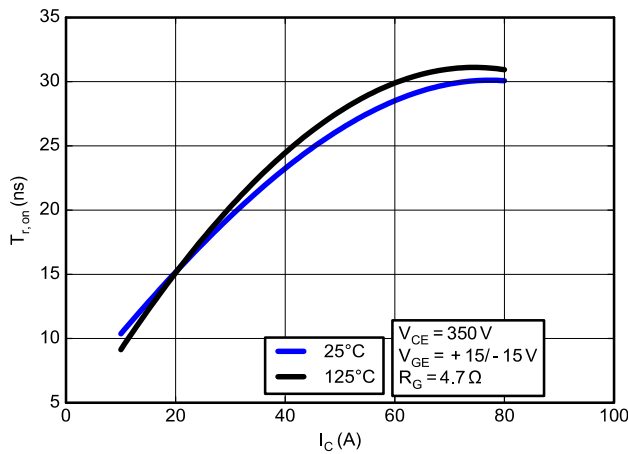

Figure 10. Typical On Rise Times vs. IC

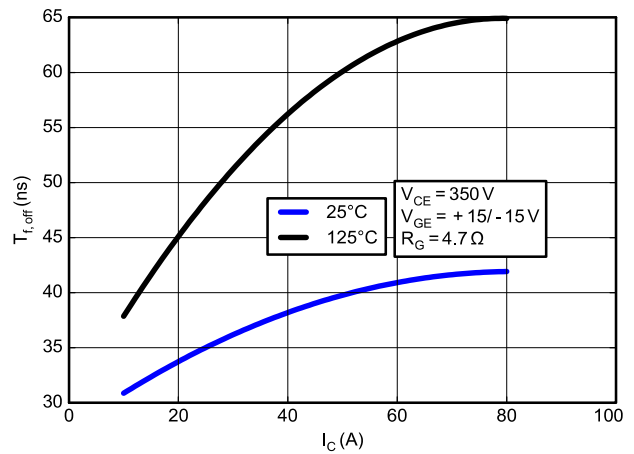

Figure 11. Typical Off Fall Times vs. IC

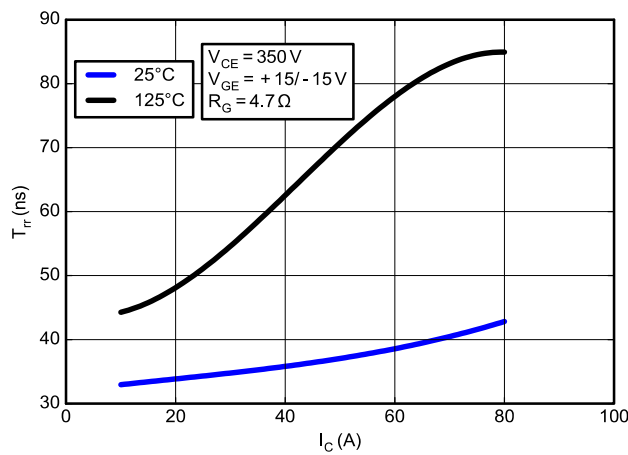

Figure 12. Typical Reverse Recovery Time vs. IC

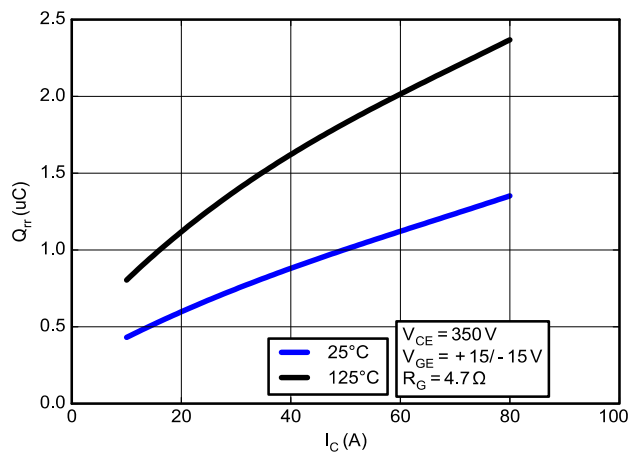

Figure 13. Typical Reverse Recovery Charge vs. IC

NXH80T120L2Q0S2G/S2TG, NXH80T120L2Q0P2G

TYPICAL CHARACTERISTICS – Half Bridge IGBT and Neutral Point Diode

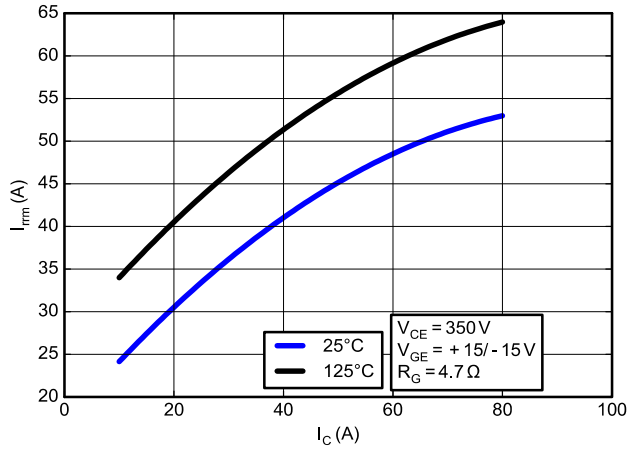

Figure 14. Typical Reverse Recovery Peak Current vs. I_C

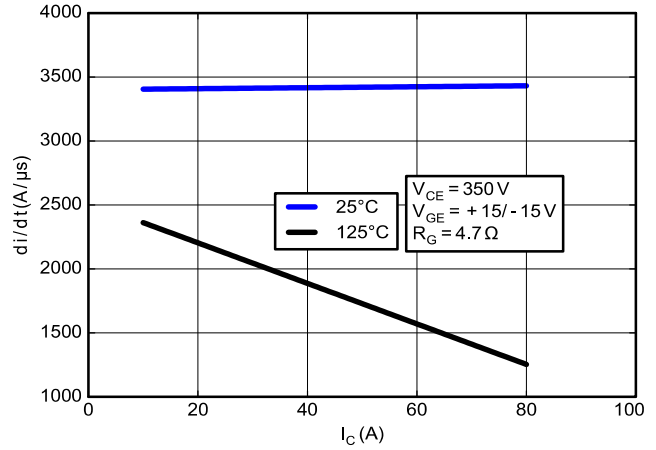

Figure 15. Typical Diode Current Slope vs. I_C

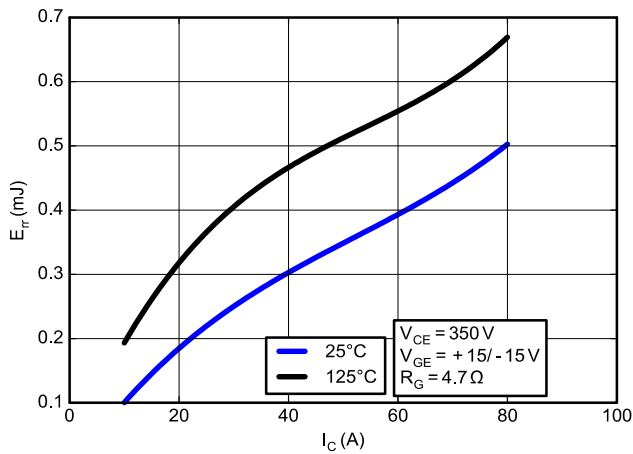

Figure 16. Typical Reverse Recovery Energy vs. I_C

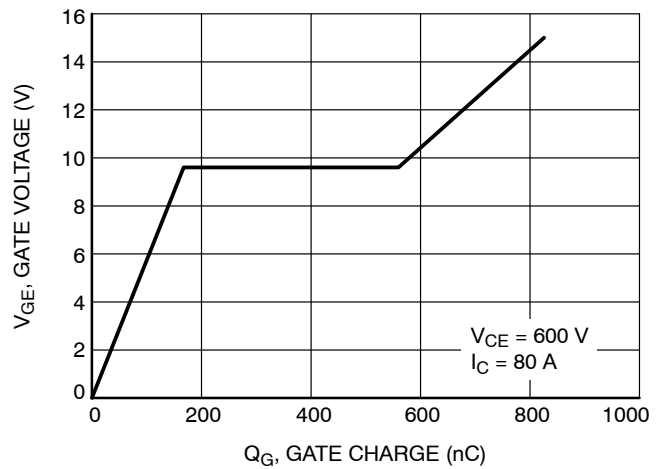

Figure 17. Gate Voltage vs. Gate Charge

NXH80T120L2Q0S2G/S2TG, NXH80T120L2Q0P2G

TYPICAL CHARACTERISTICS – Half Bridge IGBT and Neutral Point Diode

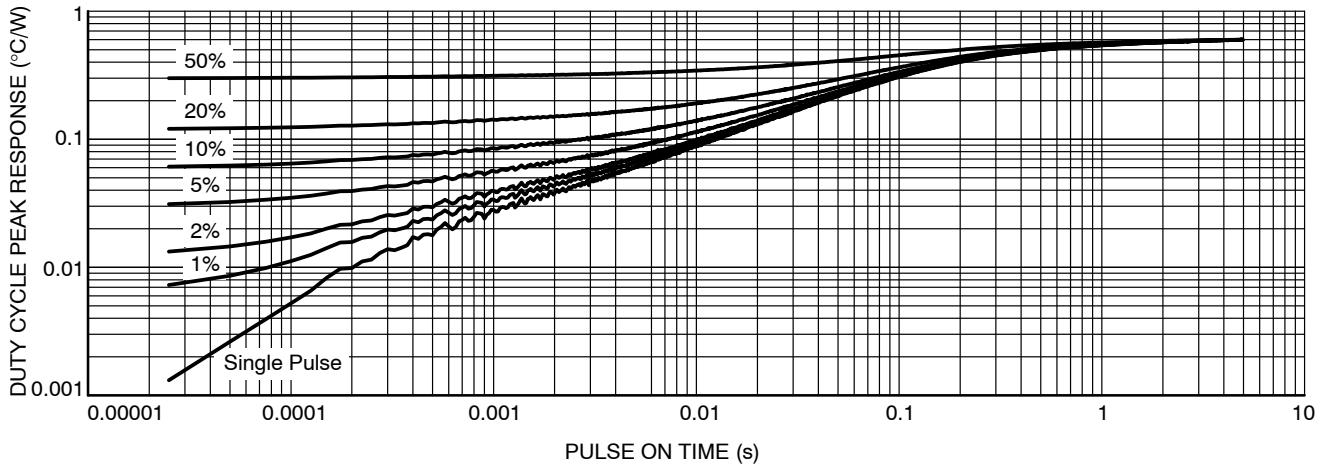

Figure 18. IGBT Transient Thermal Impedance

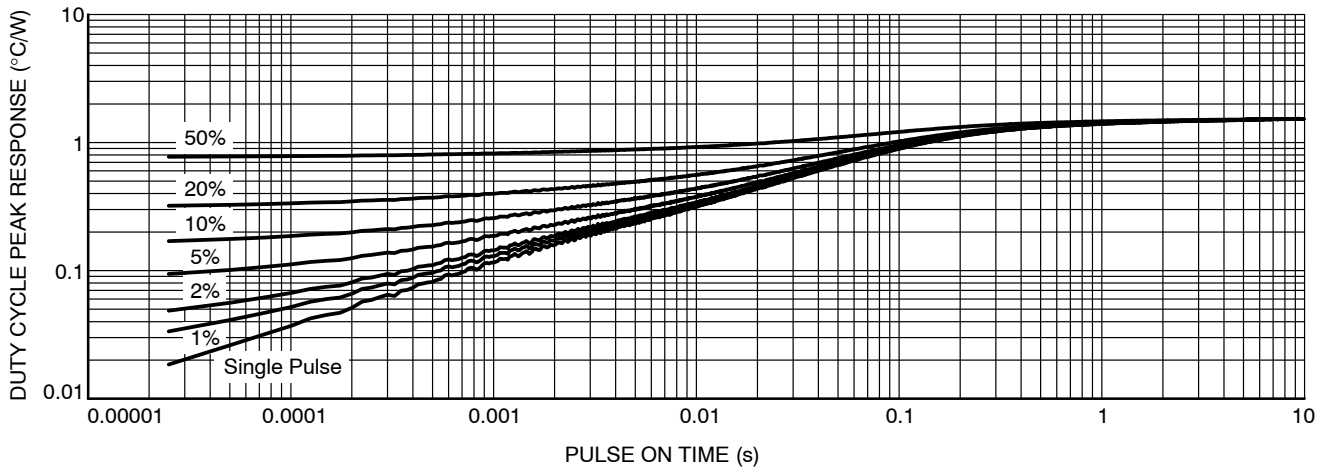

Figure 19. Diode Transient Thermal Impedance

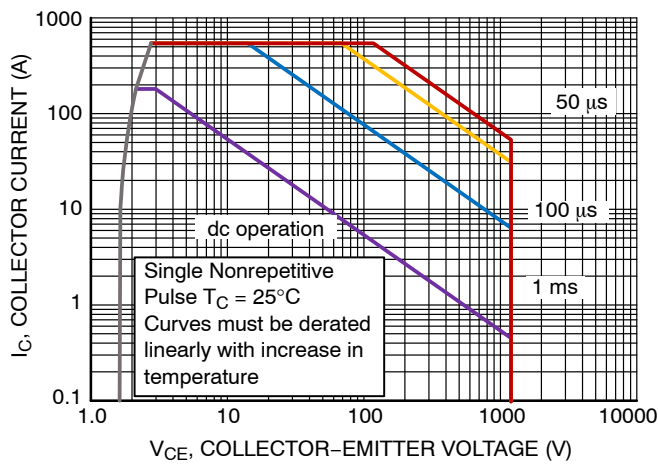

Figure 20. T1 & T4 FBSOA

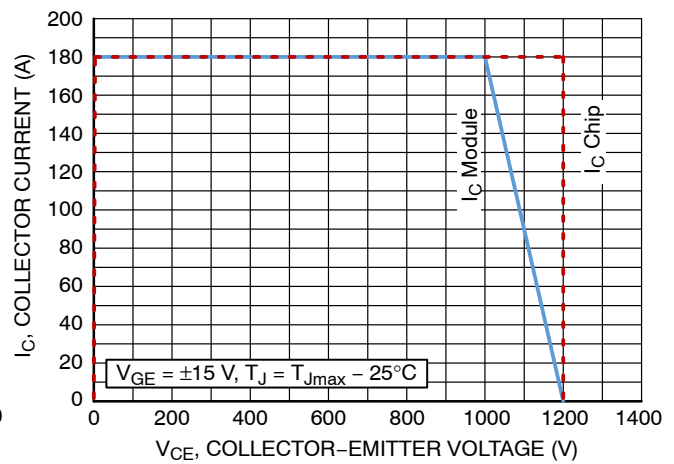

Figure 21. T1 & T4 RBSOA

NXH80T120L2Q0S2G/S2TG, NXH80T120L2Q0P2G

TYPICAL CHARACTERISTICS – Neutral Point IGBT and Half Bridge Diode

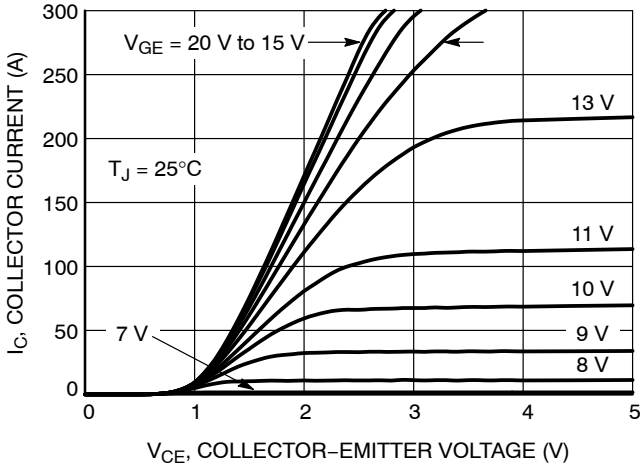

Figure 22. Typical Output Characteristics

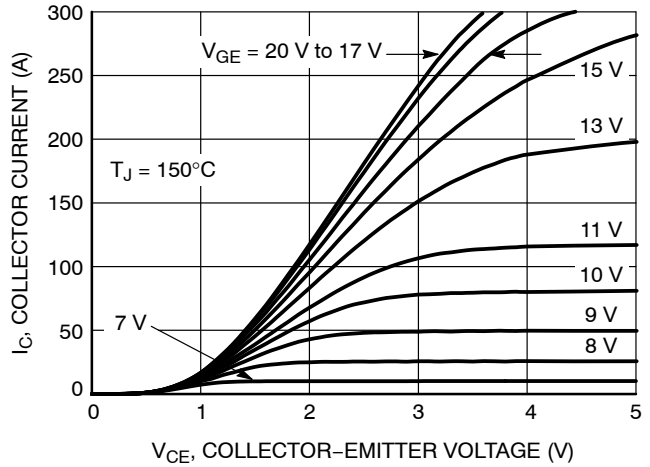

Figure 23. Typical Output Characteristics

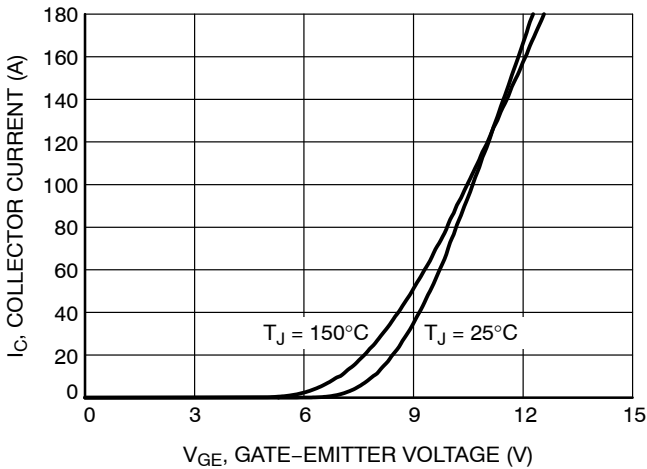

Figure 24. Typical Transfer Characteristics

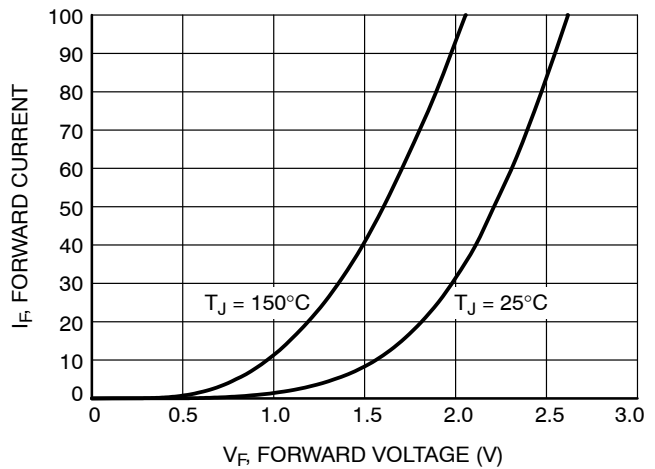

Figure 25. Diode Forward Characteristics

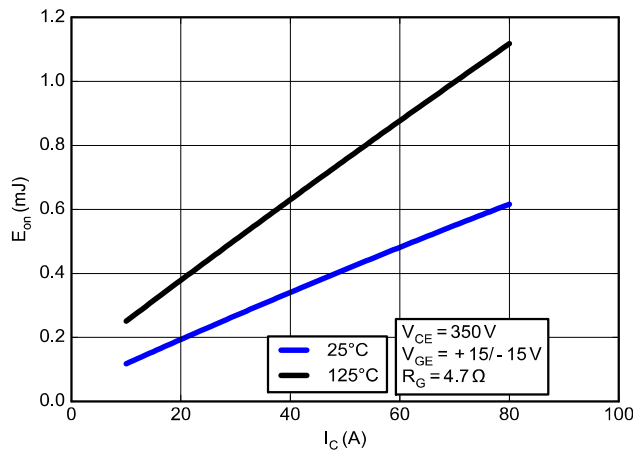

Figure 26. Typical Turn On Loss vs. IC

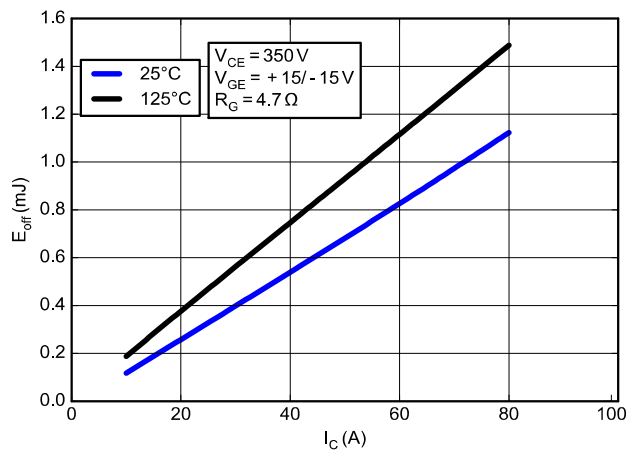

Figure 27. Typical Turn Off Loss vs. IC

NXH80T120L2Q0S2G/S2TG, NXH80T120L2Q0P2G

TYPICAL CHARACTERISTICS – Neutral Point IGBT and Half Bridge Diode

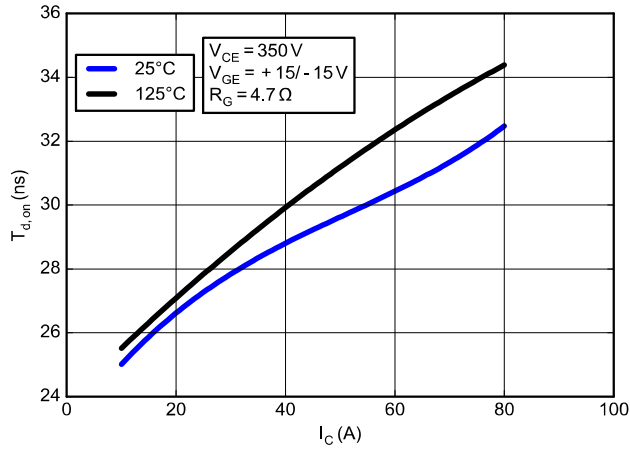

Figure 28. Typical On Switching Times vs. IC

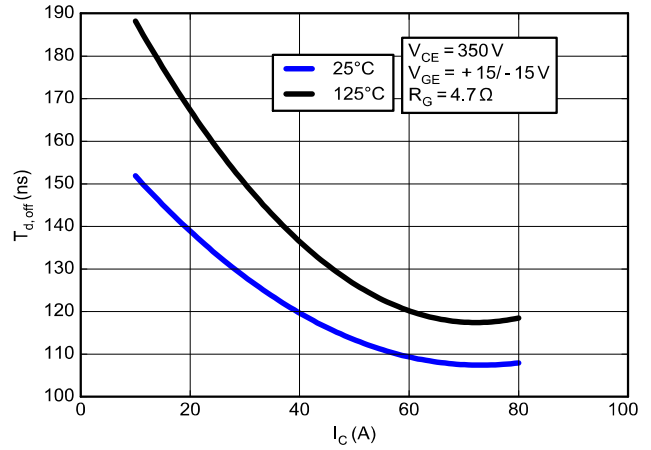

Figure 29. Typical Off Switching Times vs. IC

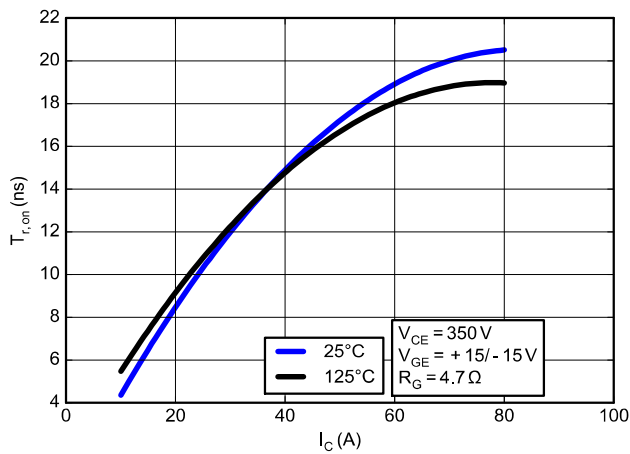

Figure 30. Typical On Rise Times vs. IC

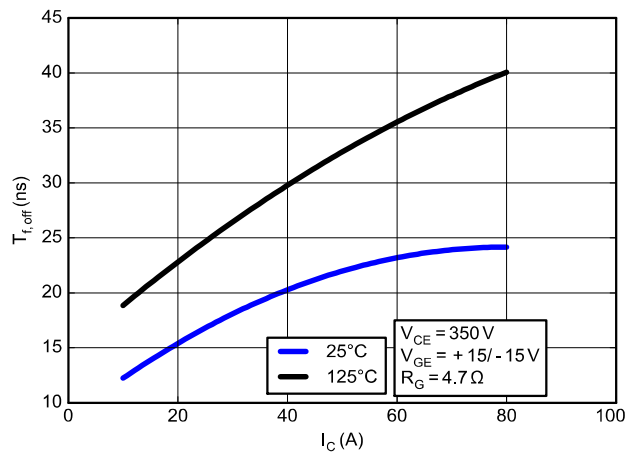

Figure 31. Typical Off Fall Times vs. IC

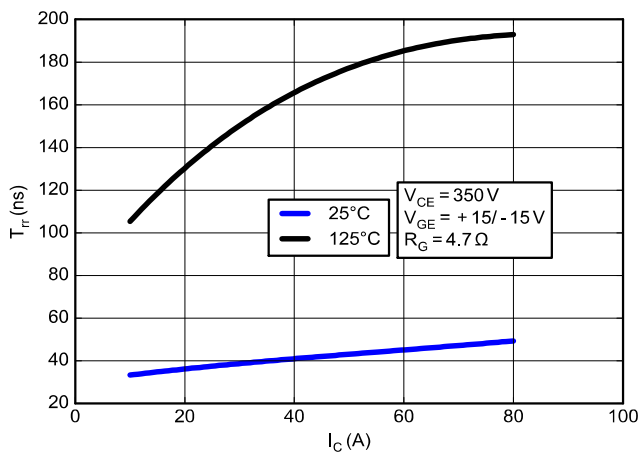

Figure 32. Typical Reverse Recovery Time vs. IC

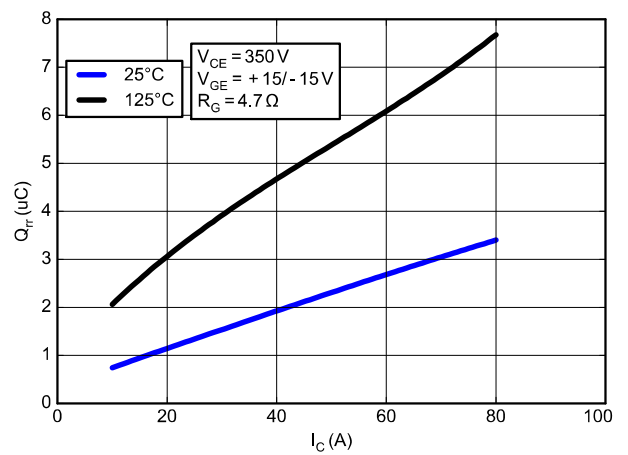

Figure 33. Typical Reverse Recovery Charge vs. IC

TYPICAL CHARACTERISTICS – Neutral Point IGBT and Half Bridge Diode

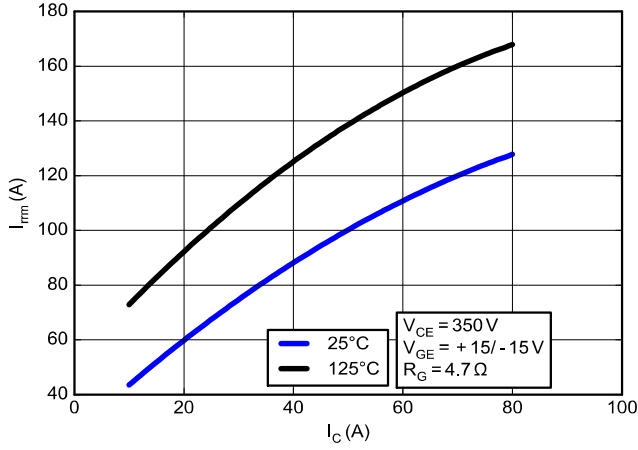

Figure 34. Typical Reverse Recovery Peak Current vs. I_C

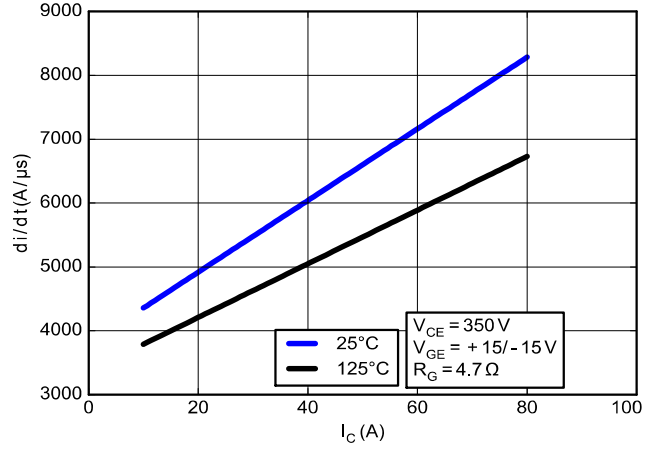

Figure 35. Typical Diode Current Slope vs. I_C

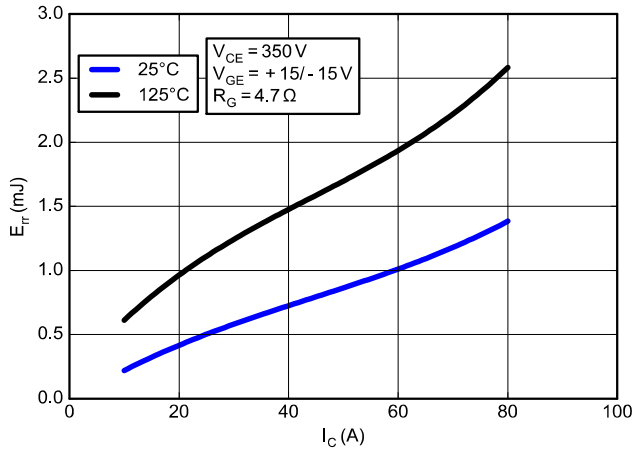

Figure 36. Typical Reverse Recovery Energy vs. I_C

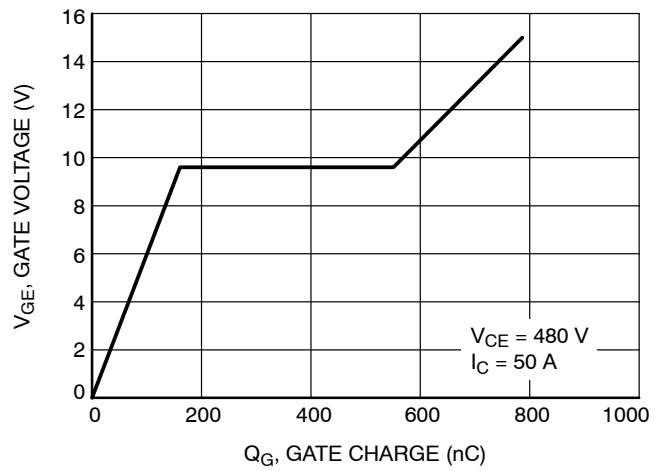

Figure 37. Gate Voltage vs. Gate Charge

NXH80T120L2Q0S2G/S2TG, NXH80T120L2Q0P2G

TYPICAL CHARACTERISTICS – Neutral Point IGBT and Half Bridge Diode

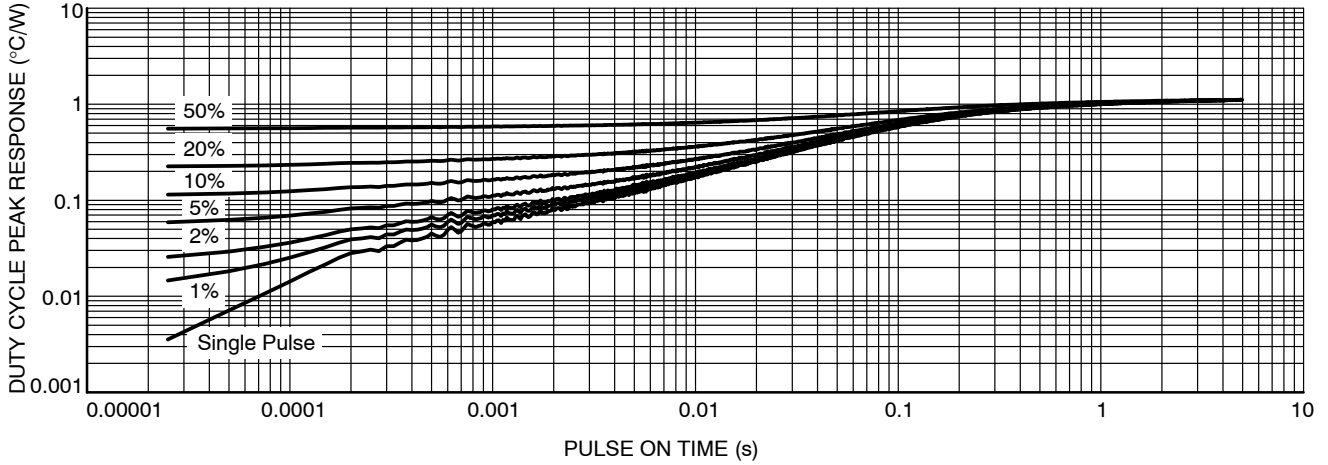

Figure 38. IGBT Transient Thermal Impedance

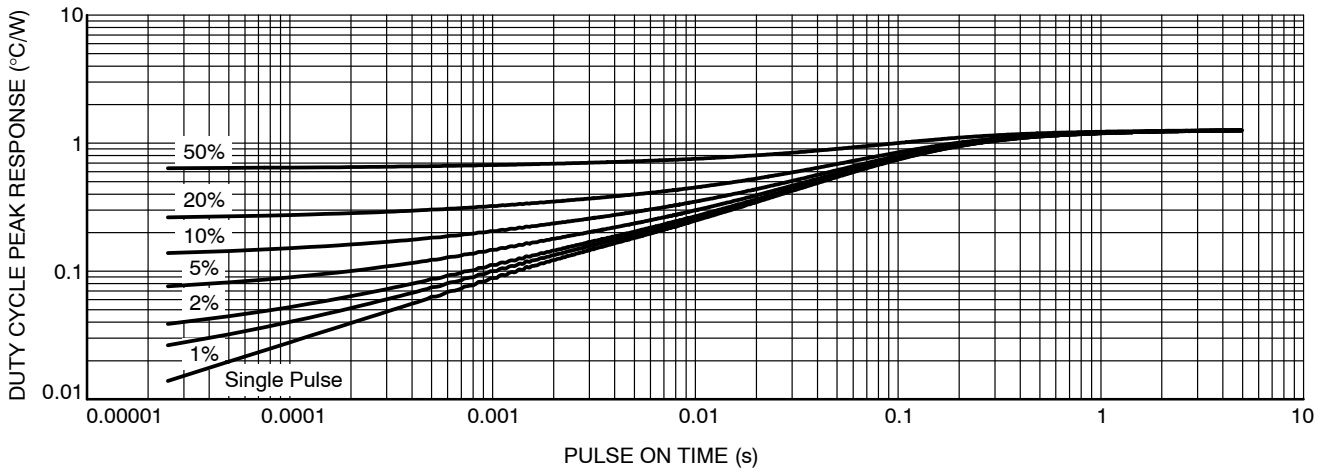

Figure 39. Diode Transient Thermal Impedance

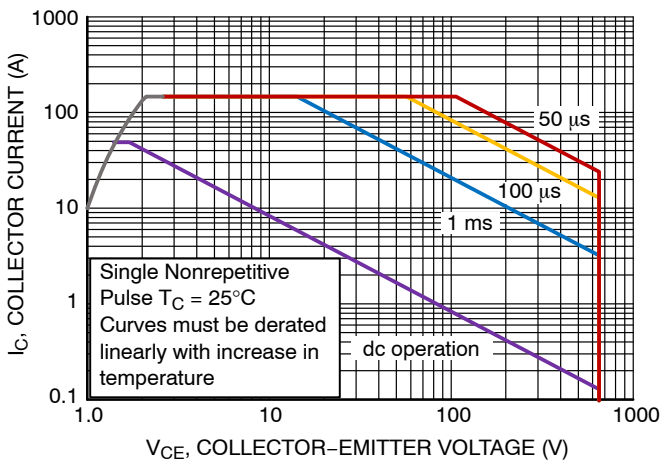

Figure 40. T2 & T3 FBSOA

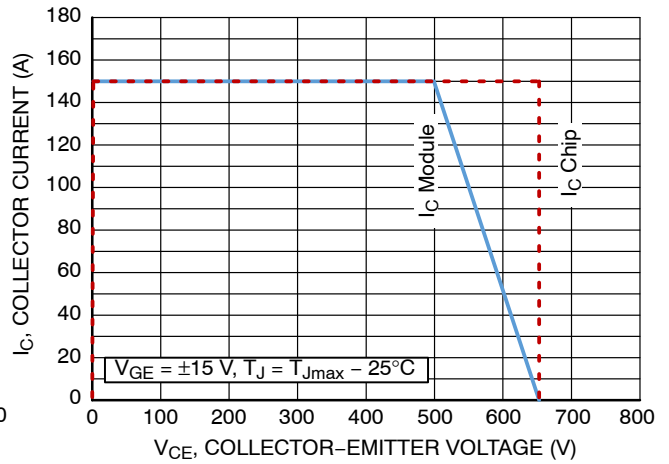

Figure 41. T2 & T3 RBSOA

NXH80T120L2Q0S2G/S2TG, NXH80T120L2Q0P2G

TYPICAL CHARACTERISTICS – Thermistor

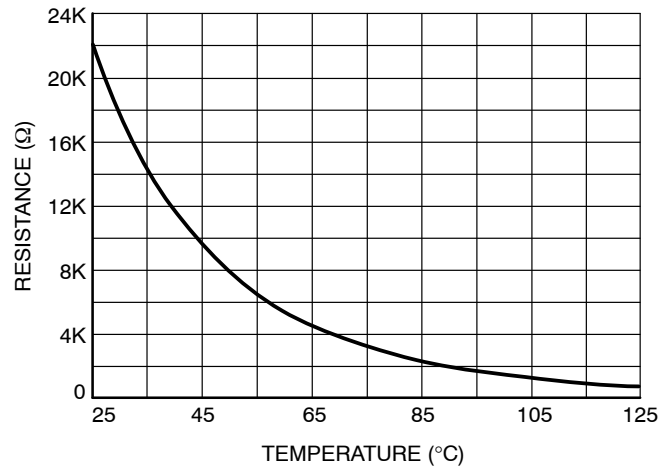

Figure 42. Thermistor Characteristics

ORDERING INFORMATION

Orderable Part Number	Marking	Package	Shipping
NXH80T120L2Q0P2G	NXH80T120L2Q0P2G	Q0PACK – Case 180AA (Pb-Free and Halide-Free)	24 Units / Blister Tray
NXH80T120L2Q0S2G	NXH80T120L2Q0S2G	Q0PACK – Case 180AB (Pb-Free and Halide-Free)	24 Units / Blister Tray
NXH80T120L2Q0S2TG	NXH80T120L2Q0S2TG	Q0PACK – Case 180AB with pre-applied thermal interface material (TIM) (Pb-Free and Halide-Free)	24 Units / Blister Tray

NXH80T120L2Q0S2G/S2TG, NXH80T120L2Q0P2G

PACKAGE DIMENSIONS

PIM20, 55x32.5 / Q0PACK
CASE 180AA
ISSUE D

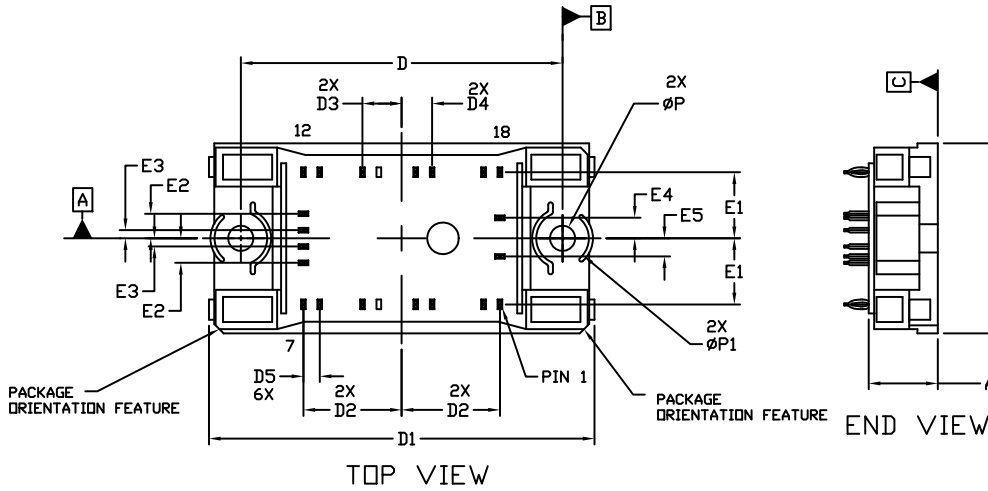

DIM	MILLIMETERS		
	MIN.	NOM.	MAX.
A	11.33	11.83	12.33
A3	15.50	16.00	16.50
A4	12.88 BSC		
b	1.61	1.66	1.71
b1	0.75	0.80	0.85
D	54.80	55.00	55.20
D1	65.70	67.90	70.10
D2	16.80 BSC		
D3	6.70 BSC		
D4	5.20 BSC		
D5	2.80 BSC		
E	32.30	32.50	32.70
E1	11.30 BSC		
E2	4.20 BSC		
E3	1.40 BSC		
E4	3.50 BSC		
E5	3.10 BSC		
P	4.10	4.30	4.50
P1	8.50	9.00	9.50

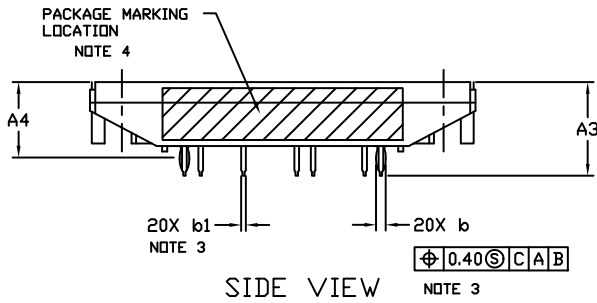

NOTES:

1. DIMENSIONING AND TOLERANCING PER ASME Y14.5M, 2009.
2. CONTROLLING DIMENSION: MILLIMETERS
3. DIMENSIONS b AND b1 APPLY TO THE PLATED TERMINALS AND ARE MEASURED AT DIMENSION A4.
4. PACKAGE MARKING IS LOCATED AS SHOWN ON THE SIDE OPPOSITE THE PACKAGE ORIENTATION FEATURES.

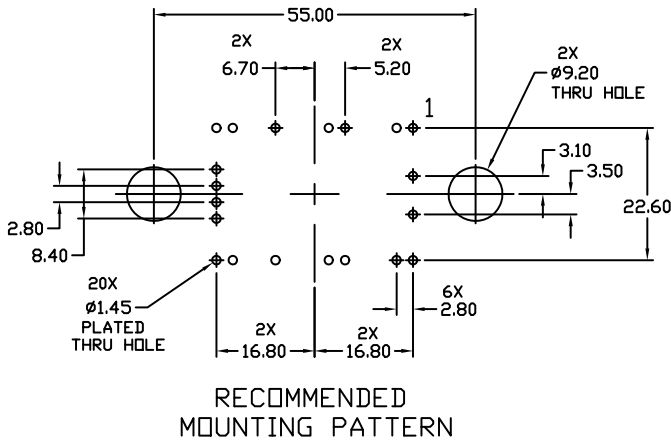

NXH80T120L2Q0S2G/S2TG, NXH80T120L2Q0P2G

PACKAGE DIMENSIONS

PIM20, 55x32.5 / Q0PACK
CASE 180AB
ISSUE D

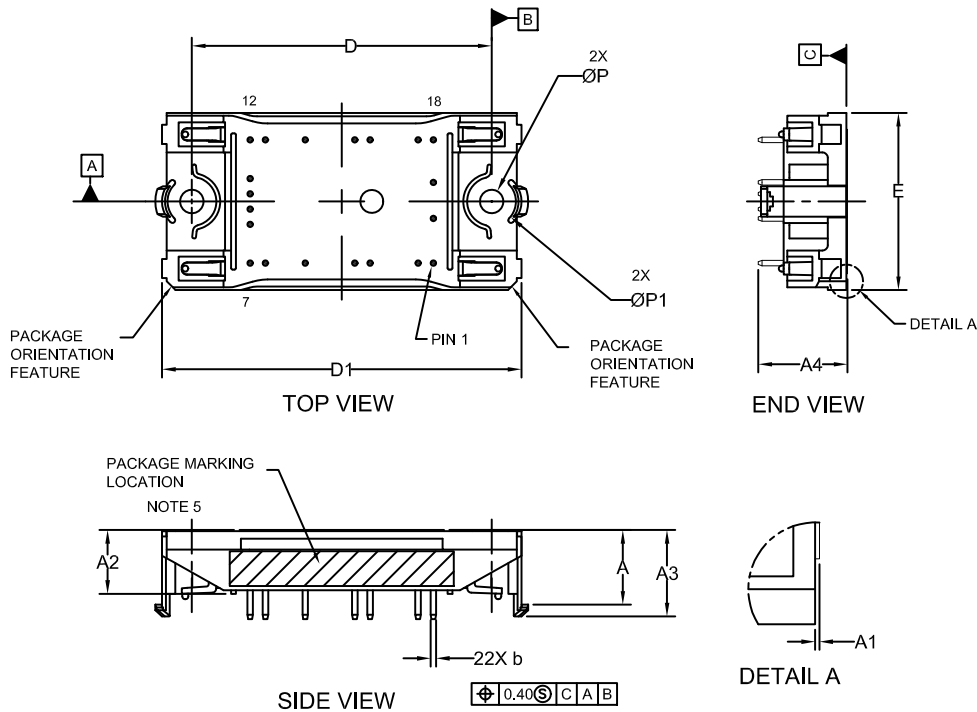

DIM	MILLIMETERS	
	MIN.	NOM.
A	13.50	13.90
A1	0.10	0.30
A2	11.50	11.90
A3	15.65	16.05
A4	16.35 REF	
b	0.95	1.05
D	54.80	55.20
D1	65.60	66.20
E	32.20	32.80
P	4.20	4.40
P1	8.90	9.10

NOTE 4

PIN	PIN POSITION		PIN	PIN POSITION	
	X	Y		X	Y
1	16.80	-11.30	11	-16.80	4.20
2	14.00	-11.30	12	-16.80	11.30
3	5.20	-11.30	13	-14.00	11.30
4	2.40	-11.30	14	-6.70	11.30
5	-6.70	-11.30	15	2.40	11.30
6	-14.00	-11.30	16	5.20	11.30
7	-16.80	-11.30	17	14.00	11.30
8	-16.80	-4.20	18	16.80	11.30
9	-16.80	-1.40	19	16.80	3.50
10	-16.80	1.40	20	16.80	-3.10

NOTES:

- DIMENSIONING AND TOLERANCING PER ASME Y14.5M, 2009.
- CONTROLLING DIMENSION: MILLIMETERS
- DIMENSION b APPLIES TO THE PLATED TERMINALS AND IS MEASURED BETWEEN 1.00 AND 3.00 FROM THE TERMINAL TIP.
- POSITION OF THE CENTER OF THE TERMINALS IS DETERMINED FROM DATUM B THE CENTER OF DIMENSION D, X DIRECTION, AND FROM DATUM A, Y DIRECTION. POSITIONAL TOLERANCE, AS NOTED IN DRAWING, APPLIES TO EACH TERMINAL IN BOTH DIRECTIONS.
- PACKAGE MARKING IS LOCATED AS SHOWN ON THE SIDE OPPOSITE THE PACKAGE ORIENTATION FEATURES.

NXH80T120L2Q0S2G/S2TG, NXH80T120L2Q0P2G

PACKAGE DIMENSIONS

PIM20, 55x32.5 / Q0PACK
CASE 180AB
ISSUE D

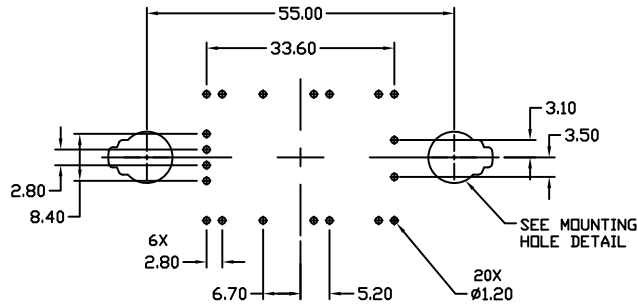

**RECOMMENDED
MOUNTING PATTERN**

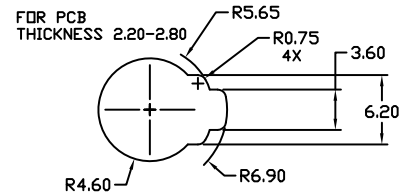
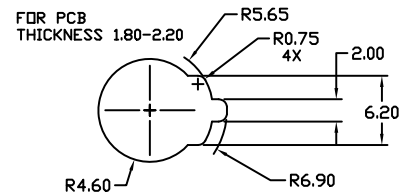
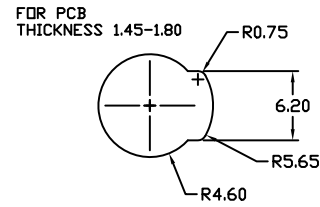

MOUNTING HOLE DETAIL

ON Semiconductor and  are trademarks of Semiconductor Components Industries, LLC dba ON Semiconductor or its subsidiaries in the United States and/or other countries. ON Semiconductor owns the rights to a number of patents, trademarks, copyrights, trade secrets, and other intellectual property. A listing of ON Semiconductor's product/patent coverage may be accessed at www.onsemi.com/site/pdf/Patent-Marking.pdf. ON Semiconductor reserves the right to make changes without further notice to any products herein. ON Semiconductor makes no warranty, representation or guarantee regarding the suitability of its products for any particular purpose, nor does ON Semiconductor assume any liability arising out of the application or use of any product or circuit, and specifically disclaims any and all liability, including without limitation special, consequential or incidental damages. Buyer is responsible for its products and applications using ON Semiconductor products, including compliance with all laws, regulations and safety requirements or standards, regardless of any support or applications information provided by ON Semiconductor. "Typical" parameters which may be provided in ON Semiconductor data sheets and/or specifications can and do vary in different applications and actual performance may vary over time. All operating parameters, including "Typicals" must be validated for each customer application by customer's technical experts. ON Semiconductor does not convey any license under its patent rights nor the rights of others. ON Semiconductor products are not designed, intended, or authorized for use as a critical component in life support systems or any FDA Class 3 medical devices or medical devices with a same or similar classification in a foreign jurisdiction or any devices intended for implantation in the human body. Should Buyer purchase or use ON Semiconductor products for any such unintended or unauthorized application, Buyer shall indemnify and hold ON Semiconductor and its officers, employees, subsidiaries, affiliates, and distributors harmless against all claims, costs, damages, and expenses, and reasonable attorney fees arising out of, directly or indirectly, any claim of personal injury or death associated with such unintended or unauthorized use, even if such claim alleges that ON Semiconductor was negligent regarding the design or manufacture of the part. ON Semiconductor is an Equal Opportunity/Affirmative Action Employer. This literature is subject to all applicable copyright laws and is not for resale in any manner.

PUBLICATION ORDERING INFORMATION

LITERATURE FULFILLMENT:
Literature Distribution Center for ON Semiconductor
19521 E. 32nd Pkwy, Aurora, Colorado 80011 USA
Phone: 303-675-2175 or 800-344-3860 Toll Free USA/Canada
Fax: 303-675-2176 or 800-344-3867 Toll Free USA/Canada
Email: orderlit@onsemi.com

N. American Technical Support: 800-282-9855 Toll Free
USA/Canada
Europe, Middle East and Africa Technical Support:
Phone: 421 33 790 2910

ON Semiconductor Website: www.onsemi.com
Order Literature: <http://www.onsemi.com/orderlit>

For additional information, please contact your local Sales Representative

Компания «Океан Электроники» предлагает заключение долгосрочных отношений при поставках импортных электронных компонентов на взаимовыгодных условиях!

Наши преимущества:

- Поставка оригинальных импортных электронных компонентов напрямую с производств Америки, Европы и Азии, а так же с крупнейших складов мира;
- Широкая линейка поставок активных и пассивных импортных электронных компонентов (более 30 млн. наименований);
- Поставка сложных, дефицитных, либо снятых с производства позиций;
- Оперативные сроки поставки под заказ (от 5 рабочих дней);
- Экспресс доставка в любую точку России;
- Помощь Конструкторского Отдела и консультации квалифицированных инженеров;
- Техническая поддержка проекта, помощь в подборе аналогов, поставка прототипов;
- Поставка электронных компонентов под контролем ВП;
- Система менеджмента качества сертифицирована по Международному стандарту ISO 9001;
- При необходимости вся продукция военного и аэрокосмического назначения проходит испытания и сертификацию в лаборатории (по согласованию с заказчиком);
- Поставка специализированных компонентов военного и аэрокосмического уровня качества (Xilinx, Altera, Analog Devices, Intersil, Interpoint, Microsemi, Actel, Aeroflex, Peregrine, VPT, Syfer, Eurofarad, Texas Instruments, MS Kennedy, Miteq, Cobham, E2V, MA-COM, Hittite, Mini-Circuits, General Dynamics и др.);

Компания «Океан Электроники» является официальным дистрибьютором и эксклюзивным представителем в России одного из крупнейших производителей разъемов военного и аэрокосмического назначения «JONHON», а так же официальным дистрибьютором и эксклюзивным представителем в России производителя высокотехнологичных и надежных решений для передачи СВЧ сигналов «FORSTAR».



JONHON

«JONHON» (основан в 1970 г.)

Разъемы специального, военного и аэрокосмического назначения:

(Применяются в военной, авиационной, аэрокосмической, морской, железнодорожной, горно- и нефтедобывающей отраслях промышленности)

«FORSTAR» (основан в 1998 г.)

ВЧ соединители, коаксиальные кабели, кабельные сборки и микроволновые компоненты:

(Применяются в телекоммуникациях гражданского и специального назначения, в средствах связи, РЛС, а так же военной, авиационной и аэрокосмической отраслях промышленности).



Телефон: 8 (812) 309-75-97 (многоканальный)

Факс: 8 (812) 320-03-32

Электронная почта: ocean@oceanchips.ru

Web: <http://oceanchips.ru/>

Адрес: 198099, г. Санкт-Петербург, ул. Калинина, д. 2, корп. 4, лит. А